



FCC/IC RF Test Report

APPLICANT : Sony Mobile Communications Inc.
EQUIPMENT : Smart phone
BRAND NAME : SONY
TYPE NAME : PM-0385-BV
FCC ID : PY7PM-0385
STANDARD : FCC Part 15 Subpart C §15.247
IC RSS-210 issue 8
CLASSIFICATION : (DTS) Digital Transmission System

The product was received on May 02, 2014 and testing was completed on May 31, 2014. We, SPORTON INTERNATIONAL INC., would like to declare that the tested sample has been evaluated in accordance with the test procedures and the testing has shown the tested sample to be in compliance with the applicable technical standards.

The test results in this report apply exclusively to the tested model / sample. Without written approval of SPORTON INTERNATIONAL INC., the test report shall not be reproduced except in full.

Reviewed by: Joseph Lin / Supervisor

Approved by: Jones Tsai / Manager



SPORTON INTERNATIONAL INC.

No. 52, Hwa Ya 1st Rd., Hwa Ya Technology Park, Kwei-Shan Hsiang, Tao Yuan Hsien, Taiwan, R.O.C.



TABLE OF CONTENTS

REVISION HISTORY.....3

SUMMARY OF TEST RESULT4

1 GENERAL DESCRIPTION5

1.1 Applicant.....5

1.2 Manufacturer.....5

1.3 Feature of Equipment Under Test5

1.4 Product Specification of Equipment Under Test.....6

1.5 Modification of EUT7

1.6 Testing Location7

1.7 Applicable Standards.....7

2 TEST CONFIGURATION OF EQUIPMENT UNDER TEST.....8

2.1 Carrier Frequency Channel8

2.2 Pre-Scanned RF Power.....9

2.3 Test Mode.....10

2.4 Connection Diagram of Test System.....11

2.5 Support Unit used in test configuration and system.....12

2.6 EUT Operation Test Setup12

2.7 Measurement Results Explanation Example.....12

3 TEST RESULT.....13

3.1 6dB and 99% Bandwidth Measurement13

3.2 Output Power Measurement.....15

3.3 Power Spectral Density Measurement17

3.4 Conducted Band Edges and Spurious Emission Measurement19

3.5 Radiated Band Edges and Spurious Emission Measurement29

3.6 AC Conducted Emission Measurement.....79

3.7 Antenna Requirements.....84

4 LIST OF MEASURING EQUIPMENT85

5 UNCERTAINTY OF EVALUATION.....87



REVISION HISTORY

REPORT NO.	VERSION	DESCRIPTION	ISSUED DATE
FR450249C	Rev. 01	Initial issue of report	Jul. 14, 2014
FR450249C	Rev. 02	Update EUT Information List for SW version change as 18.4.C.1.10	Aug. 01, 2014



SUMMARY OF TEST RESULT

Report Section	FCC Rule	IC Rule	Description	Limit	Result	Remark
3.1	15.247(a)(2)	RSS-210 A8.2(a)	6dB Bandwidth	$\geq 0.5\text{MHz}$	Pass	-
3.1	-	RSS-Gen 4.6.1	99% Bandwidth	-	Pass	-
3.2	15.247(b)	RSS-210 A8.4	Power Output Measurement	$\leq 30\text{dBm}$	Pass	-
3.3	15.247(e)	RSS-210 A8.2(b)	Power Spectral Density	$\leq 8\text{dBm}/3\text{kHz}$	Pass	-
3.4	15.247(d)	RSS-210 A8.5	Conducted Band Edges	$\leq 20\text{dBc}$	Pass	-
			Conducted Spurious Emission		Pass	-
3.5	15.247(d)	RSS-210 A8.5	Radiated Band Edges and Radiated Spurious Emission	15.209(a) & 15.247(d)	Pass	Under limit 3.72 dB at 2390.000 MHz
3.6	15.207	RSS-Gen 7.2.4	AC Conducted Emission	15.207(a)	Pass	Under limit 14.40 dB at 2.702 MHz
3.7	15.203 & 15.247(b)	RSS-210 A8.4	Antenna Requirement	N/A	Pass	-



1 General Description

1.1 Applicant

Sony Mobile Communications Inc.
Nya Vattentorget, 22188 Lund, Sweden

1.2 Manufacturer

Arima Communication Corp.
6F,No.866,Jhongjheng Rd., Jhonghe Dist., New Taipei City 23586, Taiwan

1.3 Feature of Equipment Under Test

The Equipment Under Test (hereafter called: EUT) is smart phone supporting, GSM / WCDMA / LTE, Wi-Fi 2.4GHz 802.11b/g/n, Bluetooth with FM Receiver, ANT+, GPS, and NFC features, and below is details of information.

Product Feature	
Equipment	Smart phone
Brand Name	SONY
Type Name	PM-0385-BV
FCC ID	PY7PM-0385
GSM Operating Band(s)	GSM 850/900/1800/1900MHz
GPRS / EGPRS Multi Slot Class	GPRS Class 33, EGPRS Class 33
WCDMA Operating Band(s)	FDD Band I / II / IV / V
WCDMA Rel. Version	Rel. 9
LTE Operating Band(s)	FDD Band IV / VII / XVII
LTE Rel. Version	Rel. 8
Wi-Fi Specification	802.11b/g/n (HT20)
Bluetooth Version	v3.0 + EDR / v4.0 - LE
NFC Specification	ISO14443A / ISO14443B / Felica / ISO15693
ANT+	ANT+
Power Supply	Battery / AC Adapter / Car Charger

Remark: The above EUT's information was declared by manufacturer. Please refer to the specifications or user's manual for more detailed description.



1.4 Product Specification of Equipment Under Test

Product Specification subjective to this standard	
Tx/Rx Channel Frequency Range	2412 MHz ~ 2462 MHz
Maximum (Peak) Output Power to Antenna	802.11b : 20.27 dBm (0.1064 W) 802.11g : 21.99 dBm (0.1581 W) 802.11n HT20 : 20.41 dBm (0.1099 W)
99% Occupied Bandwidth	802.11b : 14.20MHz 802.11g : 18.80MHz 802.11n HT20 : 19.10MHz
Antenna Type / Gain	IFA Antenna type with gain -0.91 dBi
Type of Modulation	802.11b : DSSS (DBPSK / DQPSK / CCK) 802.11g/n : OFDM (BPSK / QPSK / 16QAM / 64QAM)

EUT Information List				
IMEI	HW Version	SW Version	S/N	Performed Test Item
IMEI : 004402452636586	A	18.4.C.1.10	ZL4416D28274	RF conducted measurement
IMEI : 004402452638509			WUJ01AYKJ8	Radiated Spurious Emission
IMEI : 004402452636123			ZL4416D28653	Conducted Emission

Accessory List	
AC Adapter	Model No. : EP800
	Type No. : CAA-0002016-US B
	S/N : 3113W45408465 (for Radiated Spurious Emission) 3113W45408551 (for Conducted Emission)
Battery	Model No. : LIS1551ERPC
Earphone	Model No. : MH410c
	Type No. : AG-1100
	S/N : 13511E5B0076390 (for Radiated Spurious Emission) 13511E5B00763EC (for Conducted Emission)
USB Cable	Model No. : EC450
	Type No. : AI-0700
	S/N : 134912DC0004380 (for Radiated Spurious Emission) 134912D80008076 (for Conducted Emission)

Note:

1. Above EUT list and accessory list used are electrically identical per declared by manufacturer.
2. Above the accessories list are used to exercise the EUT during test.
3. For other wireless features of this EUT, test report will be issued separately.



1.5 Modification of EUT

No modifications are made to the EUT during all test items.

1.6 Testing Location

Sporton Lab is accredited to ISO 17025 by Taiwan Accreditation Foundation (TAF code : 1190) and the FCC designation No. TW1022 under the FCC 2.948(e) by Mutual Recognition Agreement (MRA) in FCC Test.

Test Site	SPORTON INTERNATIONAL INC.			
Test Site Location	No. 52, Hwa Ya 1 st Rd., Hwa Ya Technology Park, Kwei-Shan Hsiang, Tao Yuan Hsien, Taiwan, R.O.C. TEL: +886-3-3273456 / FAX: +886-3-3284978			
Test Site No.	Sporton Site No.			IC Registration No.
	TH02-HY	CO05-HY	03CH07-HY	4086B-1

1.7 Applicable Standards

According to the specifications of the manufacturer, the EUT must comply with the requirements of the following standards:

- FCC Part 15 Subpart C §15.247
- FCC KDB Publication No. 558074 D01 DTS Meas. Guidance v03r01
- ANSI C63.4-2003
- IC RSS-210 Issue 8
- IC RSS-Gen Issue 3
- NOTICE 2012-DRS0126

Remark:

1. All test items were verified and recorded according to the standards and without any deviation during the test.
2. This EUT has also been tested and complied with the requirements of FCC Part 15, Subpart B, recorded in a separate test report.
3. Per the section 2.2.3 of Notice of 2012-DRS0126, " Receivers Excluded from Industry Canada Requirements", only radiocommunication receivers operating in stand-alone mode within the band 30-960 MHz and scanner receivers are subject to Industry Canada requirements.



2 Test Configuration of Equipment Under Test

The EUT has been associated with peripherals and configuration operated in a manner tended to maximize its emission characteristics in a typical application. Frequency range investigated: conducted emission (150 kHz to 30 MHz) and radiated emission (9 kHz to the 10th harmonic of the highest fundamental frequency or to 40 GHz, whichever is lower). For radiated measurement, pre-scanned in three orthogonal panels, X, Y, Z. The worst cases (Y plane) were recorded in this report.

The final configuration from all the combinations and the worst-case data rates were investigated by measuring the maximum power across all the data rates and modulation modes under section 2.2.

Based on the worst configuration found above, the RF power setting is set individually to meet FCC compliance limit for the final conducted and radiated tests shown in section 2.3.

2.1 Carrier Frequency Channel

Frequency Band	Channel	Freq. (MHz)	Channel	Freq. (MHz)
2400-2483.5 MHz	1	2412	7	2442
	2	2417	8	2447
	3	2422	9	2452
	4	2427	10	2457
	5	2432	11	2462
	6	2437	-	-



2.2 Pre-Scanned RF Power

Preliminary tests were performed in different data rate and data rate associated with the highest power were chosen for full test shown in the following tables.

2.4GHz 802.11b mode				
Data Rate (MHz)	1M bps	2M bps	5.5M bps	11M bps
Peak Power (dBm)	20.27	20.20	20.22	20.24

2.4GHz 802.11g mode								
Data Rate (MHz)	6M bps	9M bps	12M bps	18M bps	24M bps	36M bps	48M bps	54M bps
Peak Power (dBm)	21.99	21.96	21.97	21.95	21.91	21.92	21.96	21.91

2.4GHz 802.11n HT20 mode								
Data Rate (MHz)	MCS0	MCS1	MCS2	MCS3	MCS4	MCS5	MCS6	MCS7
Peak Power (dBm)	20.41	20.39	20.36	20.38	20.36	20.40	20.32	20.35



2.3 Test Mode

Final results of test modes, data rates and test channels are shown as following table.

Test Cases				
	Test Items	Mode	Data Rate	Test Channel
Conducted TCs	6dB and 99% BW Power Spectral Density	802.11b	1 Mbps	1/6/11
		802.11g	6 Mbps	1/6/11
		802.11n HT20	MCS0	1/6/11
	Output Power	802.11b	1 Mbps	1/6/11
		802.11g	6 Mbps	1/6/11
		802.11n HT20	MCS0	1/6/11
	Conducted Band Edge	802.11b	1 Mbps	1/11
		802.11g	6 Mbps	1/11
		802.11n HT20	MCS0	1/11
	Conducted Spurious Emission	802.11b	1 Mbps	1/6/11
		802.11g	6 Mbps	1/6/11
		802.11n HT20	MCS0	1/6/11
Radiated TCs	Radiated Band Edge	802.11b	1 Mbps	1/11
		802.11g	6 Mbps	1/11
		802.11n HT20	MCS0	1/11
	Radiated Spurious Emission	802.11b	1 Mbps	1/6/11
		802.11g	6 Mbps	1/6/11
		802.11n HT20	MCS0	1/6/11
AC Conducted Emission	Mode 1 : GSM1900 Idle + Bluetooth Link + WLAN Link + Earphone + Battery + USB Cable (Charging from Adapter) + MP3			

2.4 Connection Diagram of Test System

<WLAN Tx Mode>

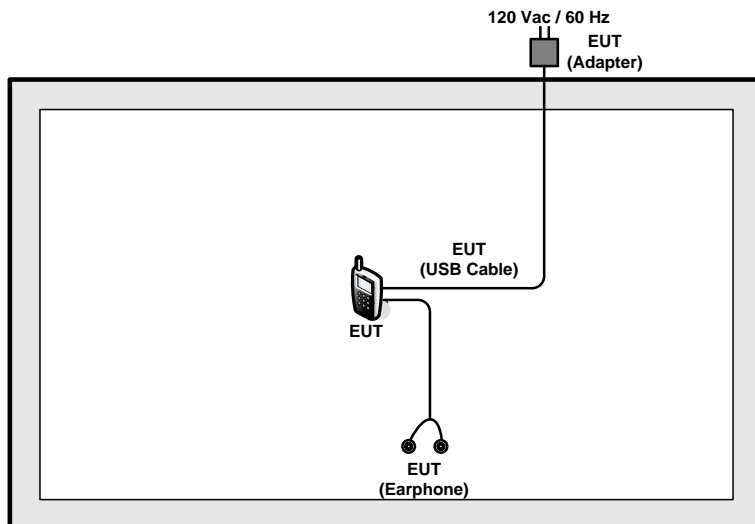

<AC Conducted Emission Mode>

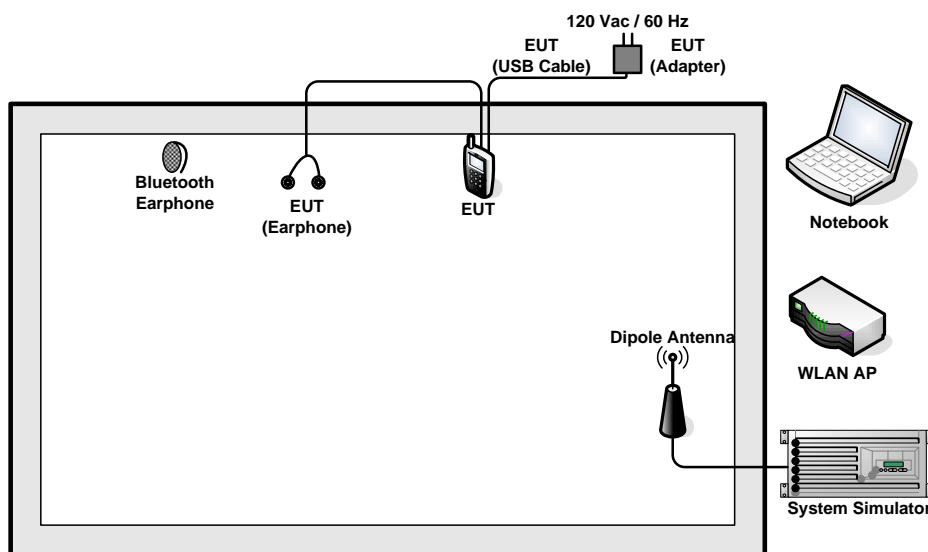



2.5 Support Unit used in test configuration and system

Item	Equipment	Trade Name	Model Name	FCC ID	Data Cable	Power Cord
1.	System Simulator	R&S	CMU 200	N/A	N/A	Unshielded, 1.8 m
2.	WLAN AP	D-Link	DIR-628	KA2DIR628A2	N/A	Unshielded, 1.8 m
3.	Bluetooth Earphone	Sony	SBH20	PY7-RD0010	Unshielded, 0.75m	N/A
4.	Notebook	DELL	Latitude E6320	FCC DoC/ Contains FCC ID: QDS-BRCM1054	N/A	AC I/P: Unshielded, 1.2 m DC O/P: Shielded, 1.8 m
5.	SD Card	SanDisk	MicroSD HC	FCC DoC	N/A	N/A

2.6 EUT Operation Test Setup

For WLAN function, programmed RF utility, "QRCT" installed in the notebook make the EUT provide functions like channel selection and power level for continuous transmitting and receiving signals.

2.7 Measurement Results Explanation Example

For all conducted test items:

The offset level is set in the spectrum analyzer to compensate the RF cable loss and attenuator factor between EUT conducted output port and spectrum analyzer. With the offset compensation, the spectrum analyzer reading level is exactly the EUT RF output level.

Example :

The spectrum analyzer offset is derived from RF cable loss and attenuator factor.

$$\text{Offset} = \text{RF cable loss} + \text{attenuator factor}.$$

Following shows an offset computation example with cable loss 4.2 dB and 10dB attenuator.

$$\begin{aligned} \text{Offset(dB)} &= \text{RF cable loss(dB)} + \text{attenuator factor(dB)}. \\ &= 4.2 + 10 = 14.2 \text{ (dB)} \end{aligned}$$

3 Test Result

3.1 6dB and 99% Bandwidth Measurement

3.1.1 Limit of 6dB and 99% Bandwidth

The minimum 6 dB bandwidth shall be at least 500 kHz.

3.1.2 Measuring Instruments

The measuring equipment is listed in the section 4 of this test report.

3.1.3 Test Procedures

1. The testing follows FCC KDB Publication No. 558074 DTS D01 Meas. Guidance v03r01.
2. The RF output of EUT was connected to the spectrum analyzer by RF cable and attenuator. The path loss was compensated to the results for each measurement.
3. Set to the maximum power setting and enable the EUT transmit continuously.
4. Make the measurement with the spectrum analyzer's resolution bandwidth (RBW) = 100 kHz. Set the Video bandwidth (VBW) = 300 kHz. In order to make an accurate measurement. The 6 dB bandwidth must be greater than 500 kHz.
5. For 99% Bandwidth Measurement, the spectrum analyzer's resolution bandwidth (RBW) = 1MHz and set the Video bandwidth (VBW) = 3MHz.
6. Measure and record the results in the test report.

3.1.4 Test Setup

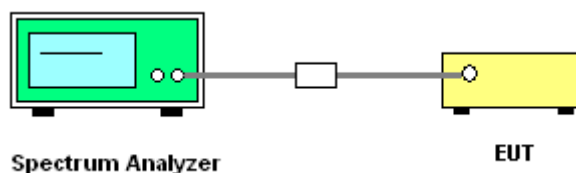



3.1.5 Test Result of 6dB and 99% Occupied Bandwidth

Test Band :	2.4GHz	Temperature :	21~26°C
Test Engineer :	Osolemio Chang	Relative Humidity :	45~54%

Mod.	Data Rate	N _{TX}	Channel	Freq. (MHz)	99% Bandwidth (MHz)	6dB Bandwidth (MHz)	6dB Bandwidth Min. Limit (MHz)	Pass/Fail
11b	1Mbps	1	1	2412	14.20	9.04	0.50	Pass
11b	1Mbps	1	6	2437	14.15	9.00	0.50	Pass
11b	1Mbps	1	11	2462	13.85	8.56	0.50	Pass
11g	6Mbps	1	1	2412	18.80	16.36	0.50	Pass
11g	6Mbps	1	6	2437	18.80	16.36	0.50	Pass
11g	6Mbps	1	11	2462	18.20	15.98	0.50	Pass
HT20	MCS0	1	1	2412	19.10	17.60	0.50	Pass
HT20	MCS0	1	6	2437	19.10	17.56	0.50	Pass
HT20	MCS0	1	11	2462	19.00	17.18	0.50	Pass

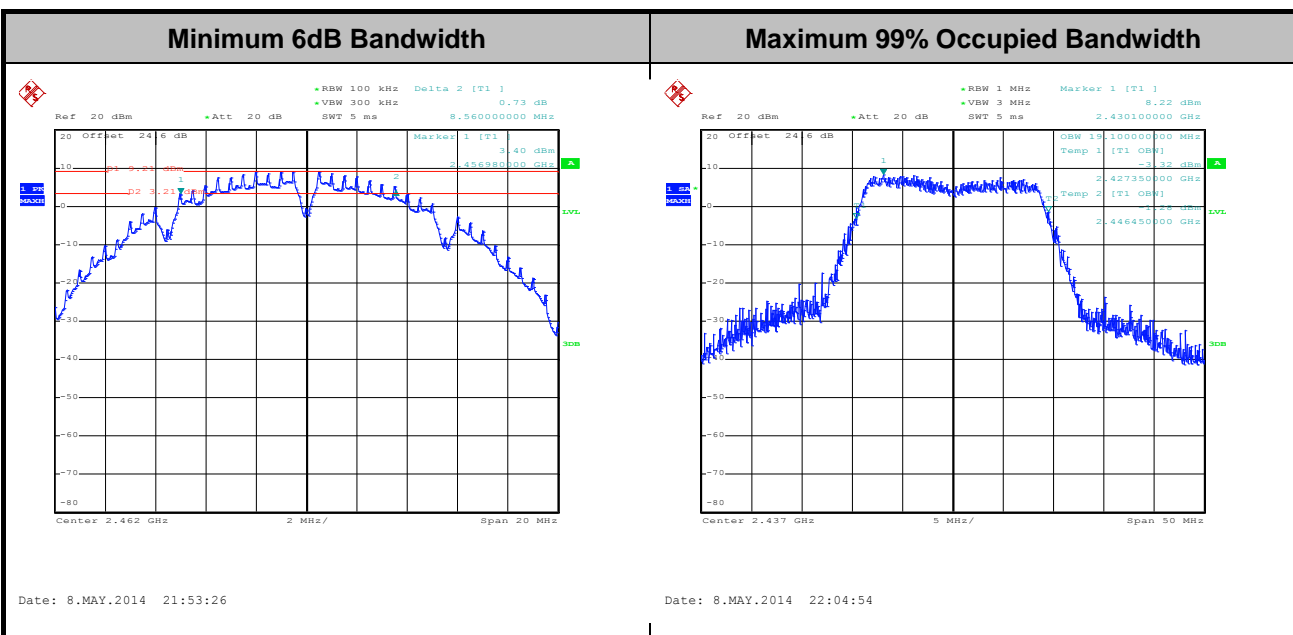

Note: The occupied channel bandwidth is maintained within the band of operation for all of the modulations.

3.2 Output Power Measurement

3.2.1 Limit of Output Power

For systems using digital modulation in the 2400-2483.5MHz and 5725-5850MHz, the limit for peak output power is 30dBm. If transmitting Antenna of directional gain greater than 6dBi are used the peak output power from the intentional radiator shall be reduced below the above stated value by the amount in dB that the directional gain of the Antenna exceeds 6 dBi. In case of point-to-point operation, the limit has to be reduced by 1dB for every 3dB that the directional gain of the Antenna exceeds 6dBi.

3.2.2 Measuring Instruments

The measuring equipment is listed in the section 4 of this test report.

3.2.3 Test Procedures

1. The testing follows the Measurement Procedure of FCC KDB No. 558074 DTS D01 Meas. Guidance v03r01.
2. The RF output of EUT was connected to the power meter by RF cable and attenuator. The path loss was compensated to the results for each measurement.
3. Set to the maximum power setting and enable the EUT transmit continuously.
4. Measure the conducted output power and record the results in the test report.

3.2.4 Test Setup

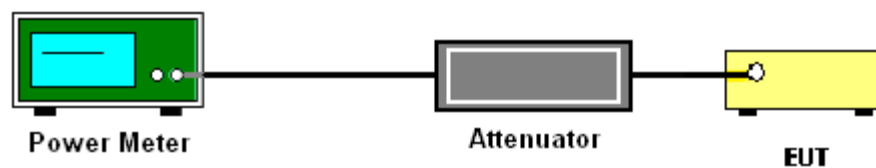



3.2.5 Test Result of Peak Output Power

Test Mode :	2.4GHz	Temperature :	21~26°C
Test Engineer :	Osolemio Chang	Relative Humidity :	45~54%

Mod.	Data Rate	N _{TX}	Channel	Freq. (MHz)	RF Output Power (dBm)	Power Limit (dBm)	DG (dBi)	Pass/Fail
11b	1Mbps	1	1	2412	19.66	30.00	-0.91	Pass
11b	1Mbps	1	6	2437	20.27	30.00	-0.91	Pass
11b	1Mbps	1	11	2462	20.16	30.00	-0.91	Pass
11g	6Mbps	1	1	2412	21.40	30.00	-0.91	Pass
11g	6Mbps	1	6	2437	21.89	30.00	-0.91	Pass
11g	6Mbps	1	11	2462	21.99	30.00	-0.91	Pass
HT20	MCS0	1	1	2412	19.68	30.00	-0.91	Pass
HT20	MCS0	1	6	2437	20.23	30.00	-0.91	Pass
HT20	MCS0	1	11	2462	20.41	30.00	-0.91	Pass

Note: Measured power (dBm) has offset with cable loss.

3.2.6 Test Result of Average output Power (Reporting Only)

Test Mode :	2.4GHz	Temperature :	21~26°C
Test Engineer :	Osolemio Chang	Relative Humidity :	45~54%

Mod.	Data Rate	N _{TX}	Channel	Freq. (MHz)	Duty Factor (dB)	Average Output Power (dBm)	Power Limit (dBm)	DG (dBi)	Pass/Fail
11b	1Mbps	1	1	2412	0.10	17.41	30	-0.91	Pass
11b	1Mbps	1	6	2437	0.10	17.91	30	-0.91	Pass
11b	1Mbps	1	11	2462	0.10	17.75	30	-0.91	Pass
11g	6Mbps	1	1	2412	0.59	14.84	30	-0.91	Pass
11g	6Mbps	1	6	2437	0.59	14.64	30	-0.91	Pass
11g	6Mbps	1	11	2462	0.59	14.87	30	-0.91	Pass
HT20	MCS0	1	1	2412	0.63	11.24	30	-0.91	Pass
HT20	MCS0	1	6	2437	0.63	11.31	30	-0.91	Pass
HT20	MCS0	1	11	2462	0.63	11.37	30	-0.91	Pass

Note: Measured power (dBm) has offset with cable loss and duty factor.

3.3 Power Spectral Density Measurement

3.3.1 Limit of Power Spectral Density

The peak power spectral density shall not be greater than 8dBm in any 3kHz band at any time interval of continuous transmission.

3.3.2 Measuring Instruments

The measuring equipment is listed in the section 4 of this test report.

3.3.3 Test Procedures

1. The testing follows Measurement Procedure 10.2 Method PKPSD of FCC KDB Publication No. 558074 D01 DTS Meas. Guidance v03r01
2. The RF output of EUT was connected to the spectrum analyzer by RF cable and attenuator. The path loss was compensated to the results for each measurement.
3. Set to the maximum power setting and enable the EUT transmit continuously.
4. Make the measurement with the spectrum analyzer's resolution bandwidth (RBW) = 3 kHz. Video bandwidth VBW = 10 kHz In order to make an accurate measurement, set the span to 1.5 times DTS Channel Bandwidth. (6dB BW)
5. Detector = peak, Sweep time = auto couple, Trace mode = max hold, Allow trace to fully stabilize. Use the peak marker function to determine the maximum power level.
6. Measure and record the results in the test report.

3.3.4 Test Setup

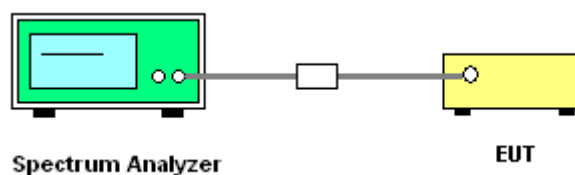



3.3.5 Test Result of Power Spectral Density

Test Mode :	2.4GHz	Temperature :	21~26°C
Test Engineer :	Osolemio Chang	Relative Humidity :	45~54%

Mod.	Data Rate	N _{TX}	Channel	Freq. (MHz)	Peak Power Density (dBm/3kHz)	Max. Limits (dBm/3kHz)	DG (dBi)	Pass/Fail
11b	1Mbps	1	1	2412	-5.15	8	-0.91	Pass
11b	1Mbps	1	6	2437	-5.13	8	-0.91	Pass
11b	1Mbps	1	11	2462	-5.57	8	-0.91	Pass
11g	6Mbps	1	1	2412	-10.48	8	-0.91	Pass
11g	6Mbps	1	6	2437	-10.77	8	-0.91	Pass
11g	6Mbps	1	11	2462	-10.62	8	-0.91	Pass
HT20	MCS0	1	1	2412	-14.66	8	-0.91	Pass
HT20	MCS0	1	6	2437	-14.19	8	-0.91	Pass
HT20	MCS0	1	11	2462	-13.80	8	-0.91	Pass

Note: Measured power density (dBm) has offset with cable loss.

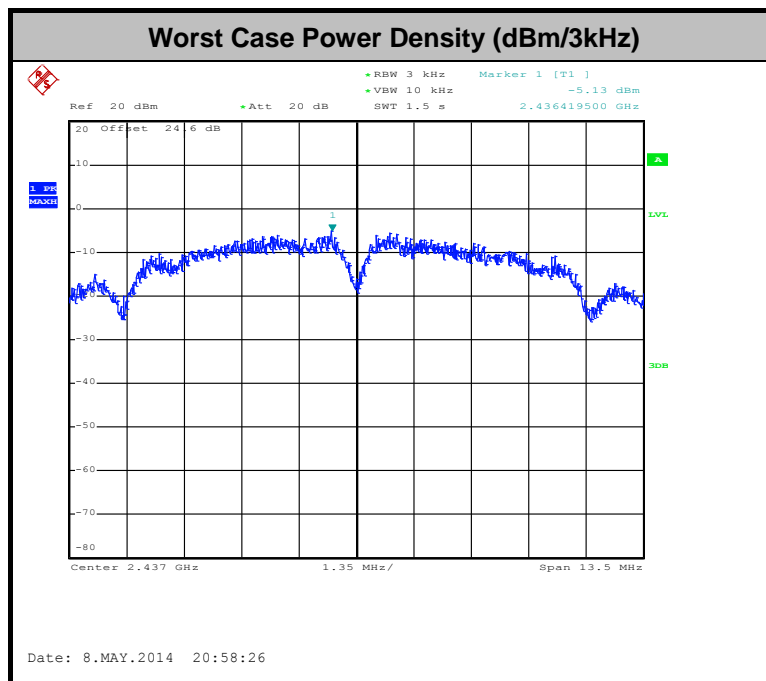

3.4 Conducted Band Edges and Spurious Emission Measurement

3.4.1 Limit of Conducted Band Edges and Spurious Emission Measurement

In any 100 kHz bandwidth outside of the authorized frequency band, the emissions which fall in the non-restricted bands shall be attenuated at least 20 dB / 30dB relative to the maximum PSD level in 100 kHz by RF conducted measurement and radiated emissions which fall in the restricted bands, as defined in Section 15.205(a), must also comply with the radiated emission limits specified in Section 15.209(a).

3.4.2 Measuring Instruments

The measuring equipment is listed in the section 4 of this test report.

3.4.3 Test Procedures

1. The testing follows FCC KDB Publication No. 558074 D01 DTS Meas. Guidance v03r01.
2. The RF output of EUT was connected to the spectrum analyzer by RF cable and attenuator. The path loss was compensated to the results for each measurement.
3. Set to the maximum power setting and enable the EUT transmit continuously.
4. Set RBW = 100 kHz, VBW=300 kHz, Peak Detector. Unwanted Emissions measured in any 100 kHz bandwidth outside of the authorized frequency band shall be attenuated by at least 20 dB relative to the maximum in-band peak PSD level in 100 kHz when maximum peak conducted output power procedure is used. If the transmitter complies with the conducted power limits based on the use of RMS averaging over a time interval, the attenuation required under this paragraph shall be 30 dB instead of 20 dB per 15.247(d).
5. Measure and record the results in the test report.
6. The RF fundamental frequency should be excluded against the limit line in the operating frequency band.

3.4.4 Test Setup

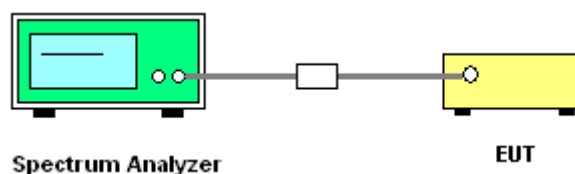



3.4.5 Test Result of Conducted Band Edges and Spurious Emission

Test Mode :	802.11b	Temperature :	21~26°C
Test Band :	2.4GHz Low	Relative Humidity :	45~54%
Test Channel :	01	Test Engineer :	Osolemio Chang

WLAN 802.11b Channel 01

100kHz PSD reference Level

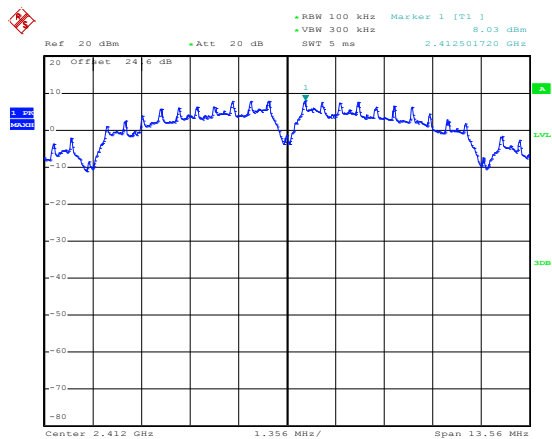

Date: 8.MAY.2014 21:13:27

Low Channel Plot

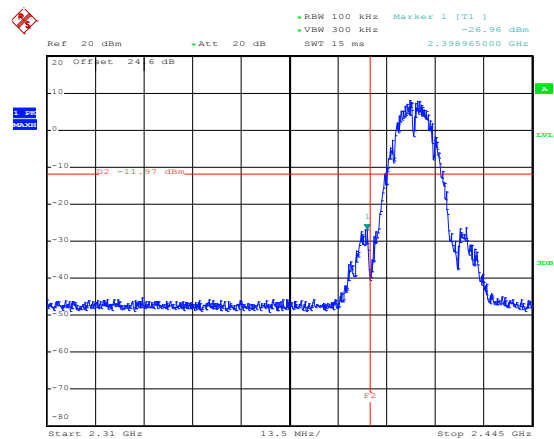

Date: 8.MAY.2014 21:13:41

Spurious Emission 30MHz~3GHz

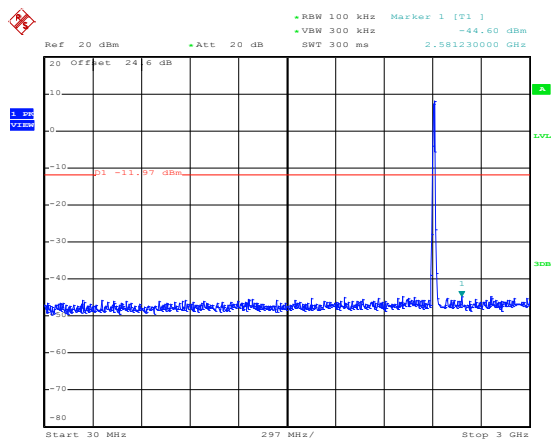

Date: 8.MAY.2014 21:14:00

Spurious Emission 2GHz~25GHz

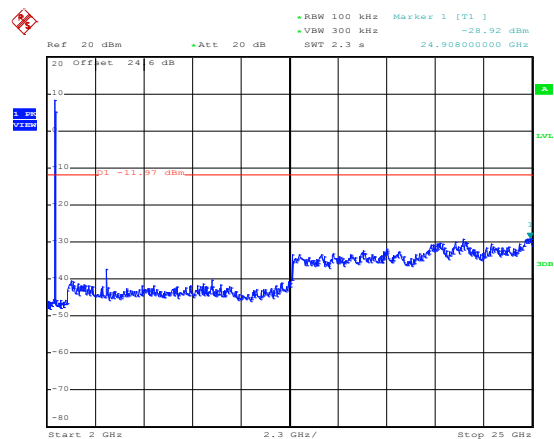

Date: 8.MAY.2014 21:14:19



Test Mode :	802.11b	Temperature :	21~26°C
Test Band :	2.4GHz Mid.	Relative Humidity :	45~54%
Test Channel :	06	Test Engineer :	Osolemio Chang

WLAN 802.11b Channel 06

100kHz PSD reference Level

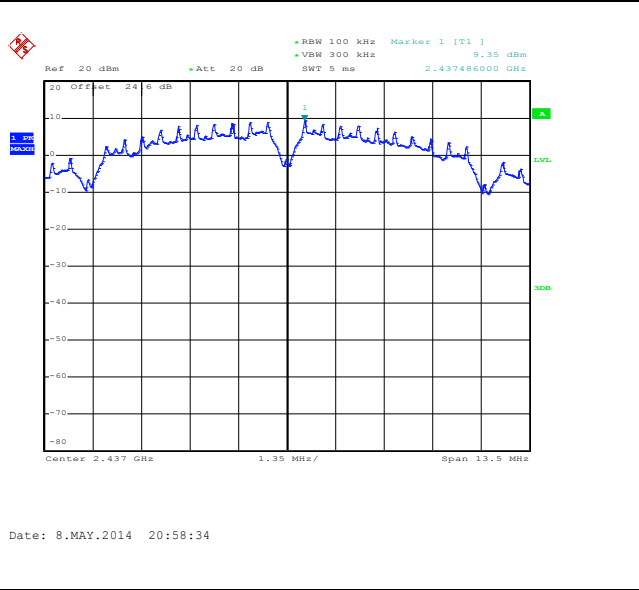

Spurious Emission 30MHz~3GHz

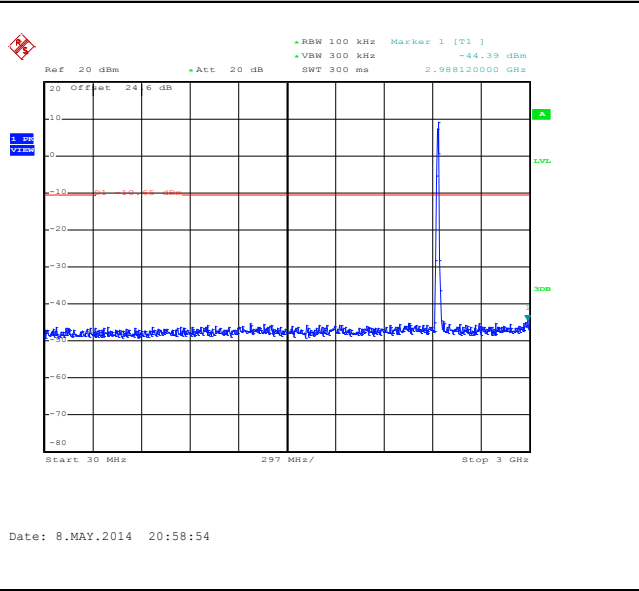

Spurious Emission 2GHz~25GHz

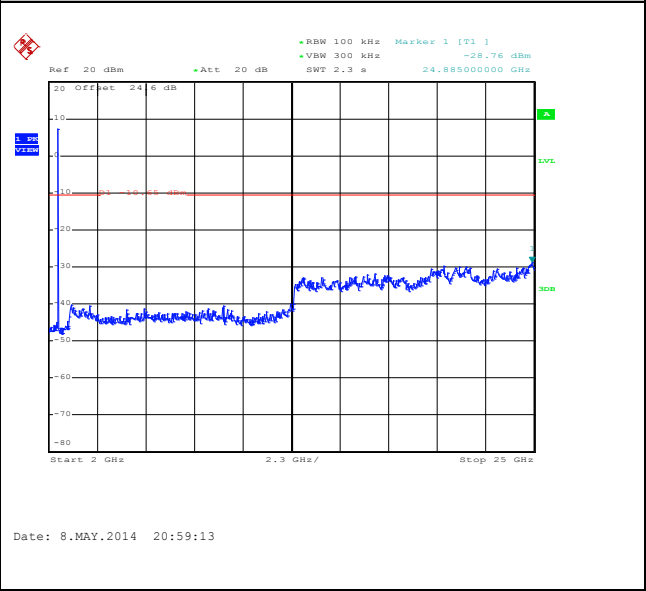



Test Mode :	802.11b	Temperature :	21~26°C
Test Band :	2.4GHz High	Relative Humidity :	45~54%
Test Channel :	11	Test Engineer :	Osolemio Chang

WLAN 802.11b Channel 11

100kHz PSD reference Level

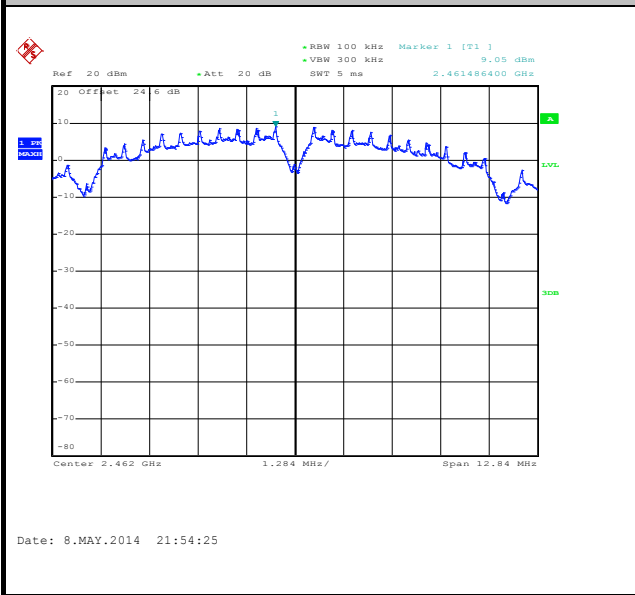

High Channel Plot

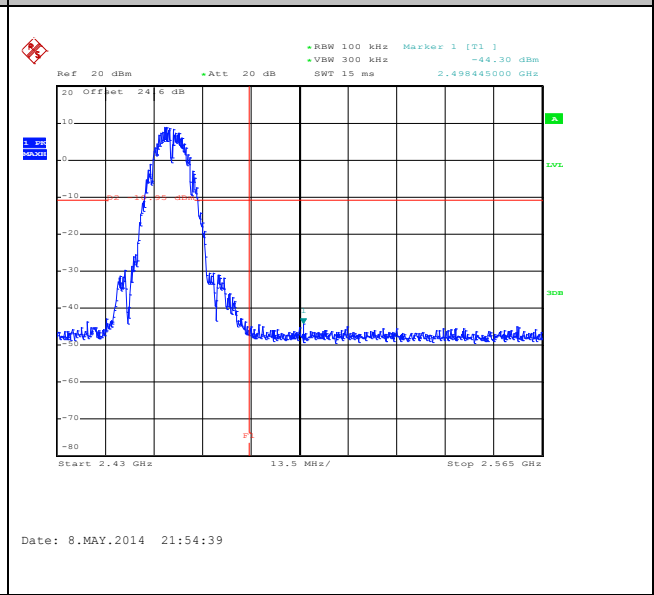

Spurious Emission 30MHz~3GHz

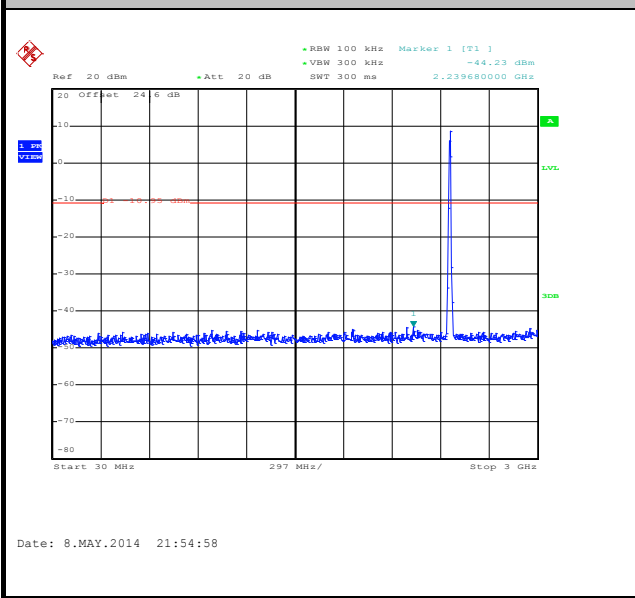

Spurious Emission 2GHz~25GHz

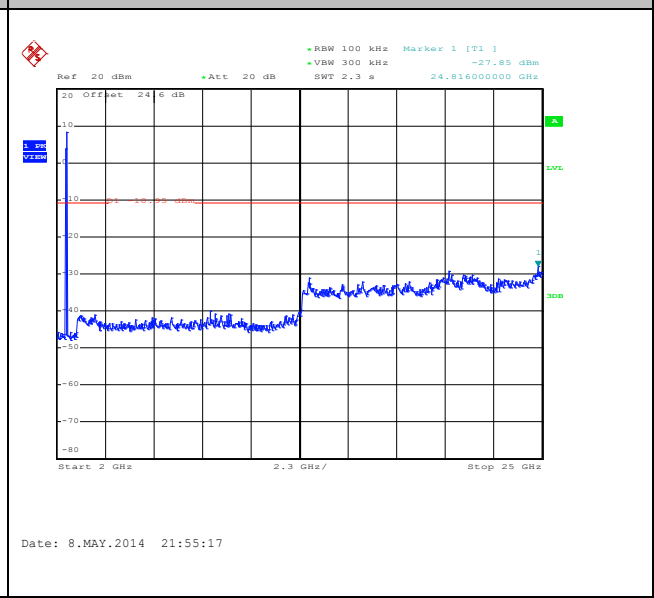



Test Mode :	802.11g	Temperature :	21~26°C
Test Band :	2.4GHz Low	Relative Humidity :	45~54%
Test Channel :	01	Test Engineer :	Osolemio Chang

WLAN 802.11g Channel 01

100kHz PSD reference Level

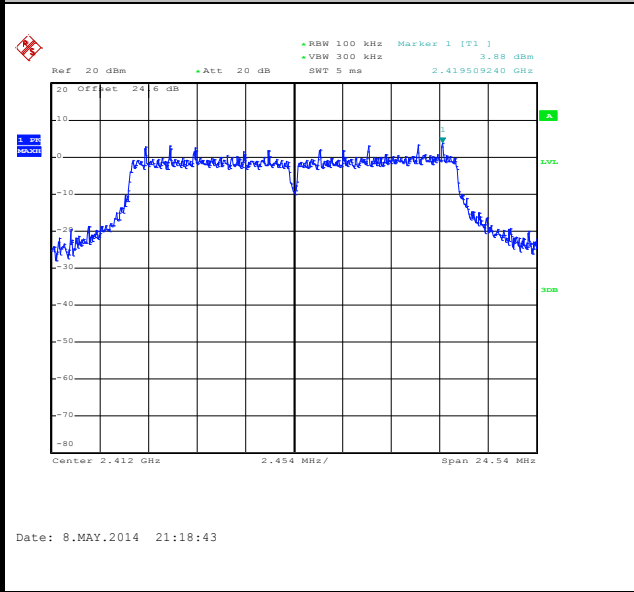

Low Channel Plot

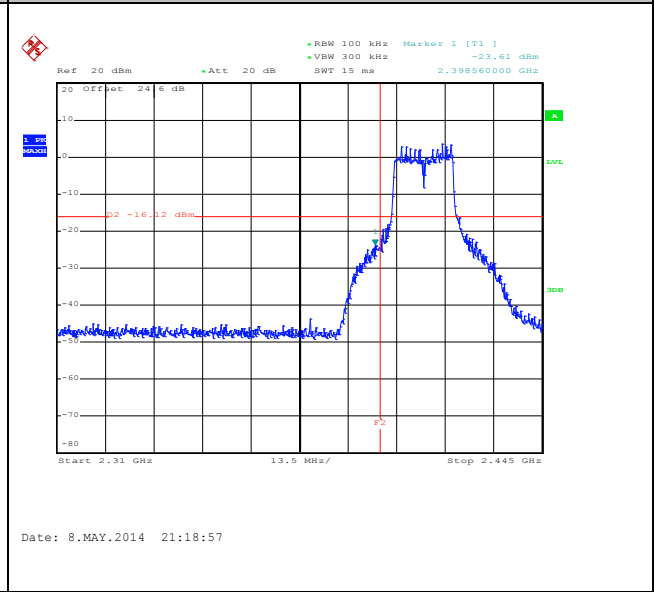

Spurious Emission 30MHz~3GHz

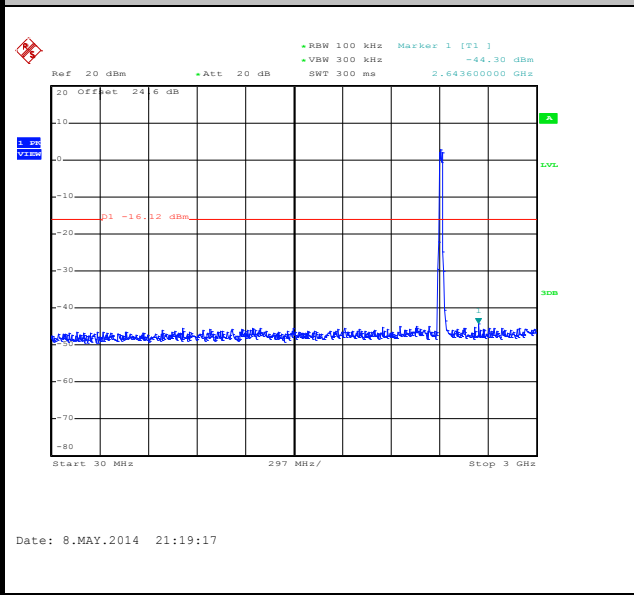

Spurious Emission 2GHz~25GHz

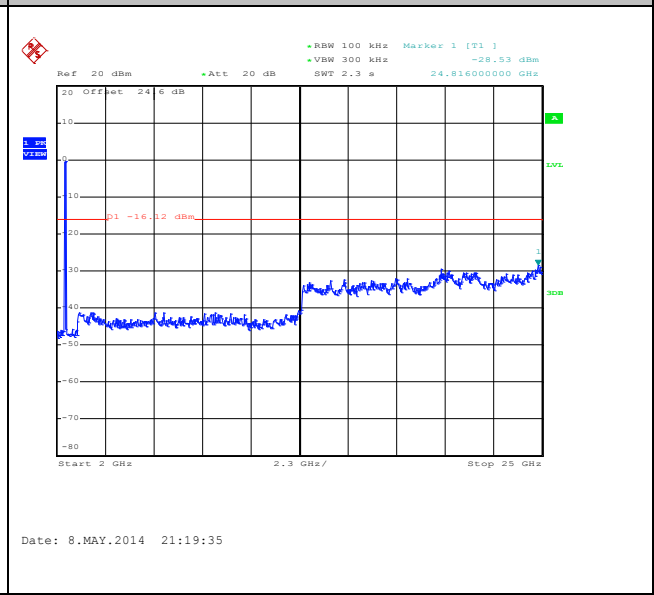



Test Mode :	802.11g	Temperature :	21~26°C
Test Band :	2.4GHz Mid.	Relative Humidity :	45~54%
Test Channel :	06	Test Engineer :	Osolemio Chang

WLAN 802.11g Channel 06

100kHz PSD reference Level

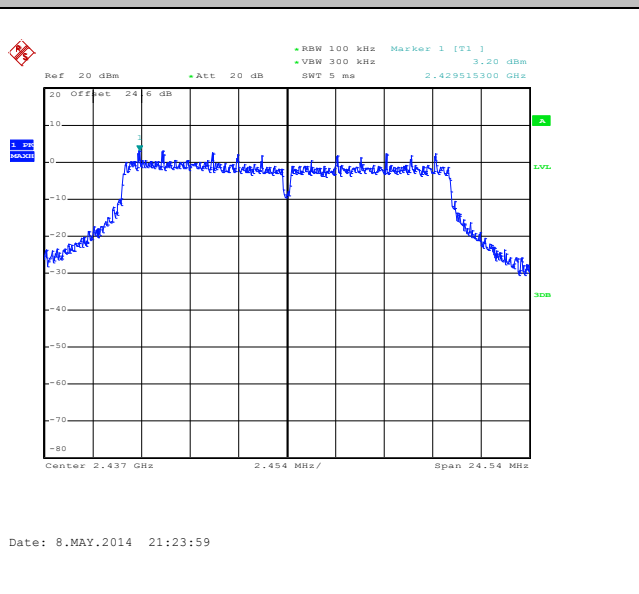

Spurious Emission 30MHz~3GHz

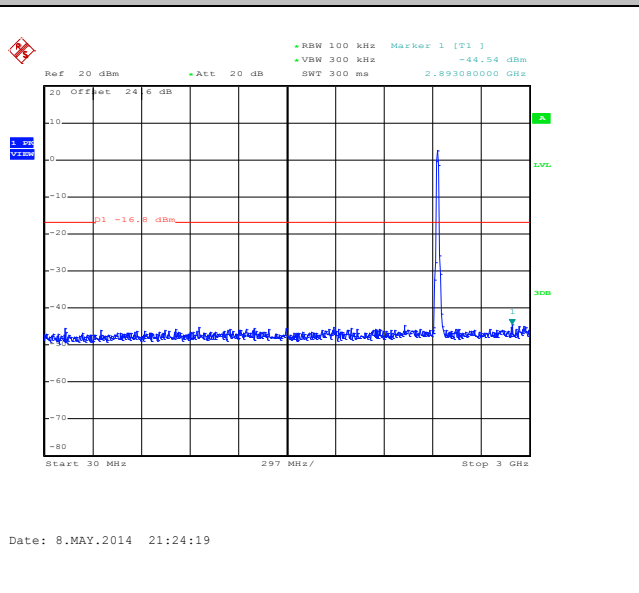

Spurious Emission 2GHz~25GHz

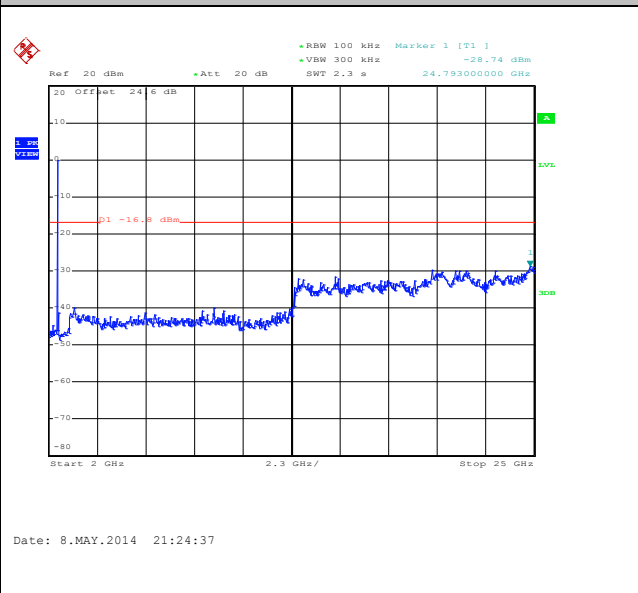



Test Mode :	802.11g	Temperature :	21~26°C
Test Band :	2.4GHz High	Relative Humidity :	45~54%
Test Channel :	11	Test Engineer :	Osolemio Chang

WLAN 802.11g Channel 11

100kHz PSD reference Level

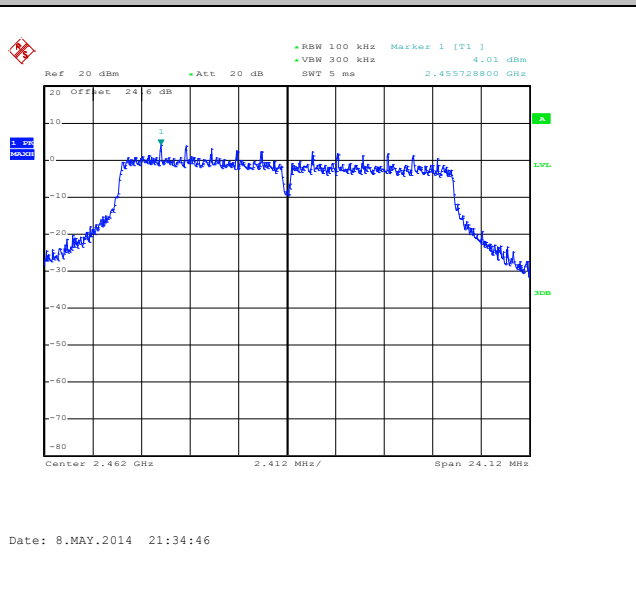

High Channel Plot

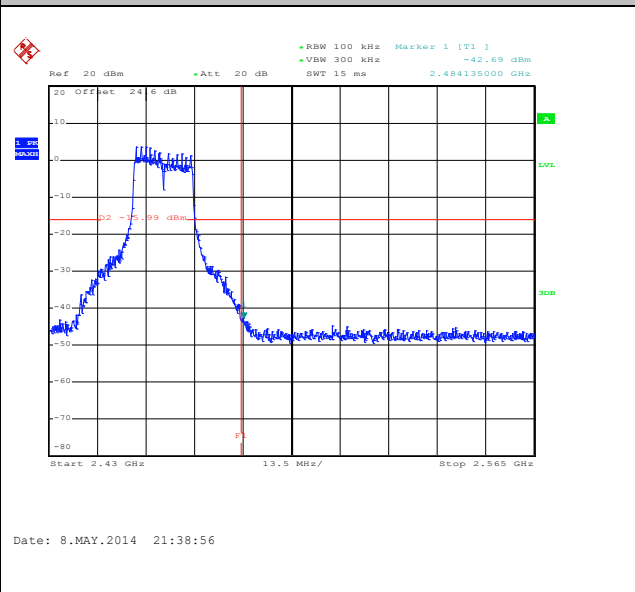

Spurious Emission 30MHz~3GHz

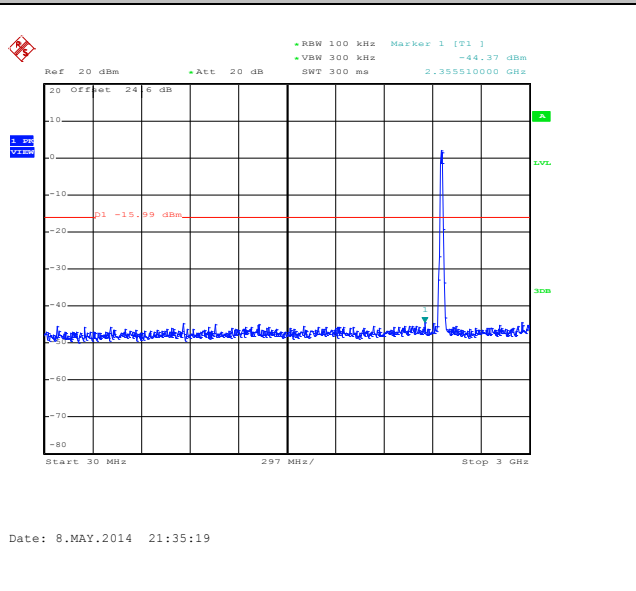

Spurious Emission 2GHz~25GHz

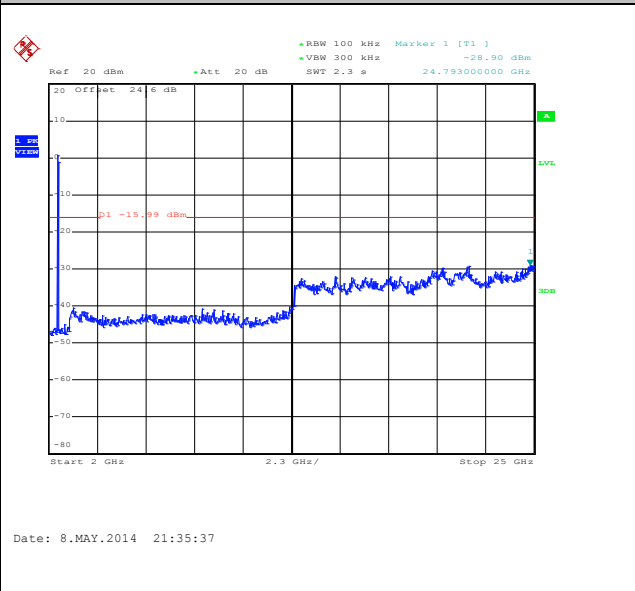



Test Mode :	802.11n HT20	Temperature :	21~26°C
Test Band :	2.4GHz Low	Relative Humidity :	45~54%
Test Channel :	01	Test Engineer :	Osolemio Chang

WLAN 802.11n HT20 Channel 01

100kHz PSD reference Level

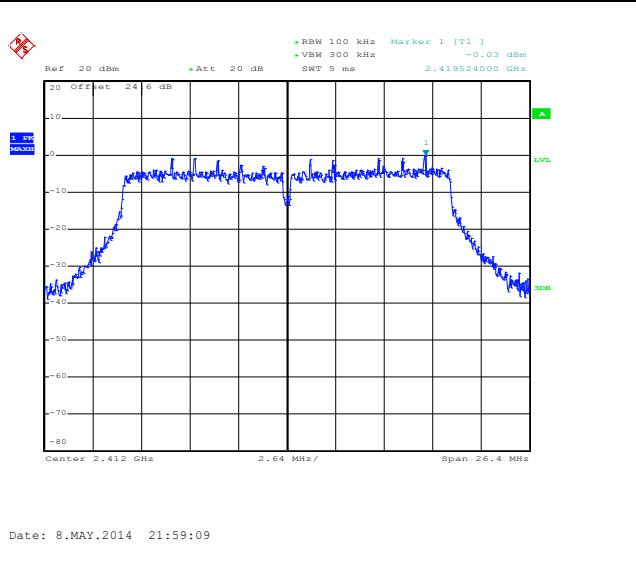

Low Channel Plot

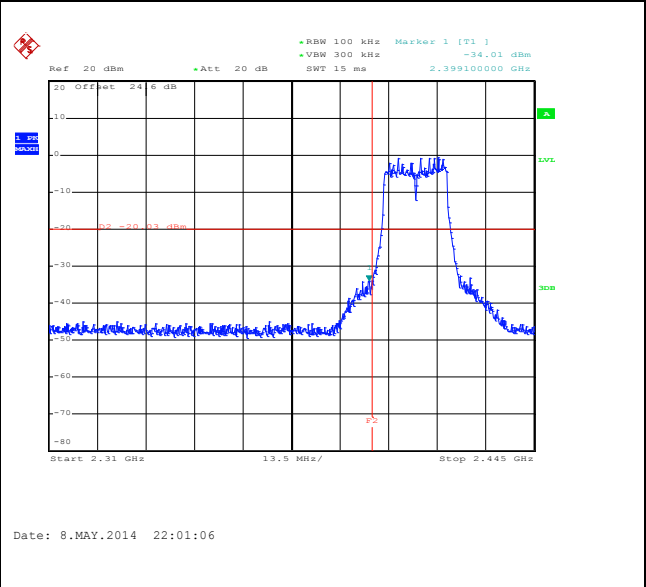

Spurious Emission 30MHz~3GHz

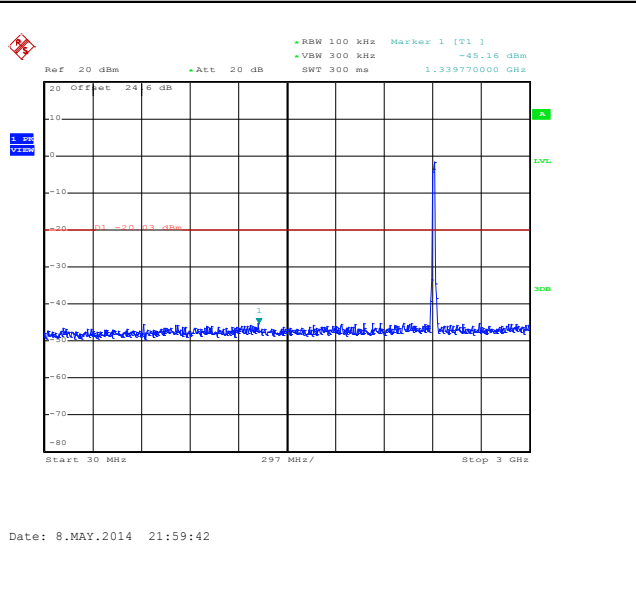

Spurious Emission 2GHz~25GHz

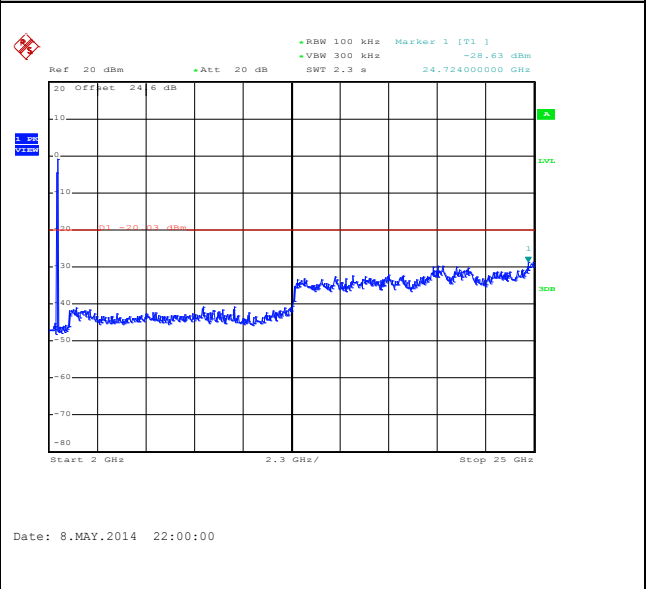



Test Mode :	802.11n HT20	Temperature :	21~26°C
Test Band :	2.4GHz Mid.	Relative Humidity :	45~54%
Test Channel :	06	Test Engineer :	Osolemio Chang

WLAN 802.11n HT20 Channel 06

100kHz PSD reference Level

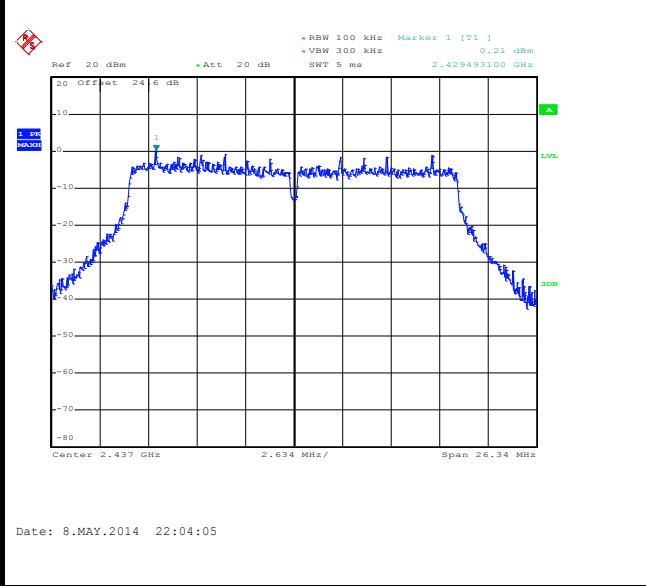

Spurious Emission 30MHz~3GHz

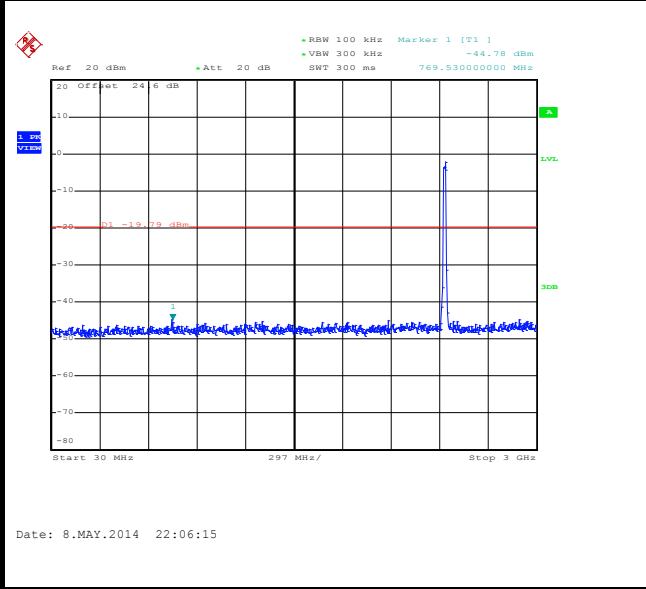

Spurious Emission 2GHz~25GHz

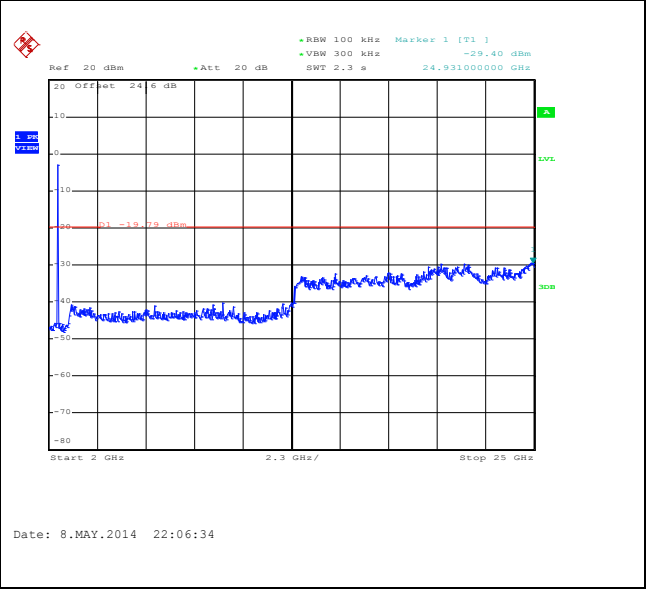



Test Mode :	802.11n HT20	Temperature :	21~26°C
Test Band :	2.4GHz High	Relative Humidity :	45~54%
Test Channel :	11	Test Engineer :	Osolemio Chang

WLAN 802.11n HT20 Channel 11

100kHz PSD reference Level

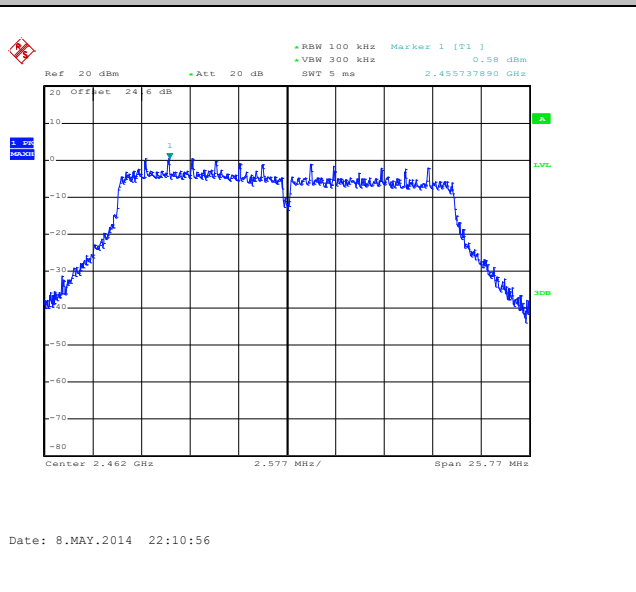

High Channel Plot

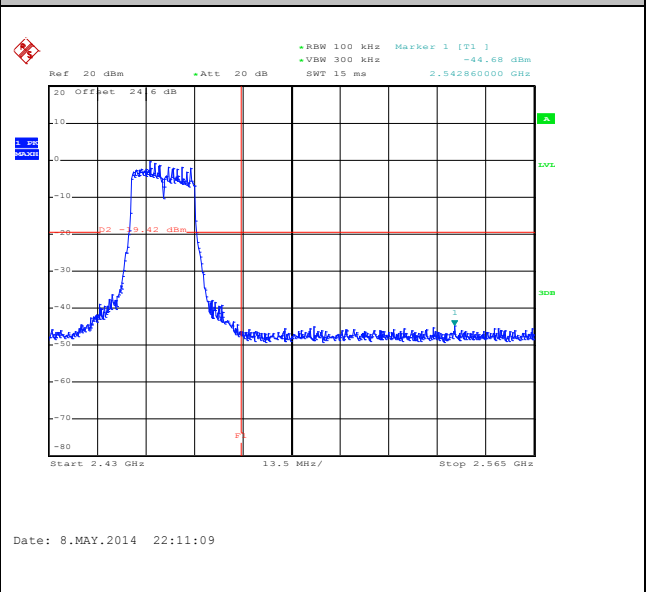

Spurious Emission 30MHz~3GHz

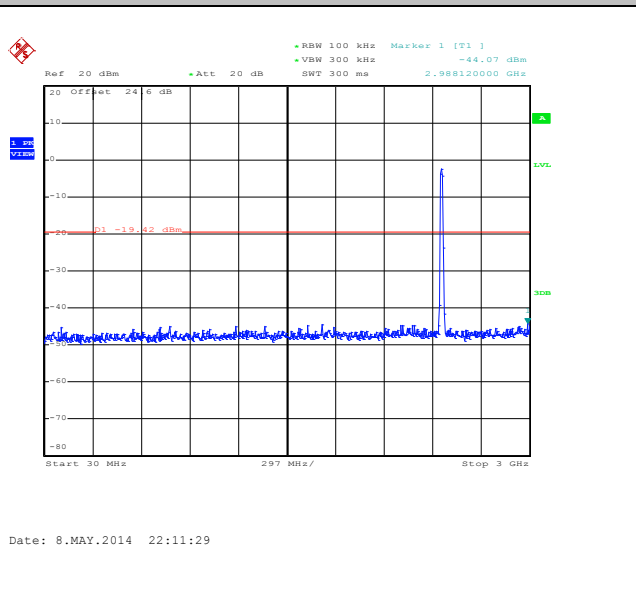

Spurious Emission 2GHz~25GHz

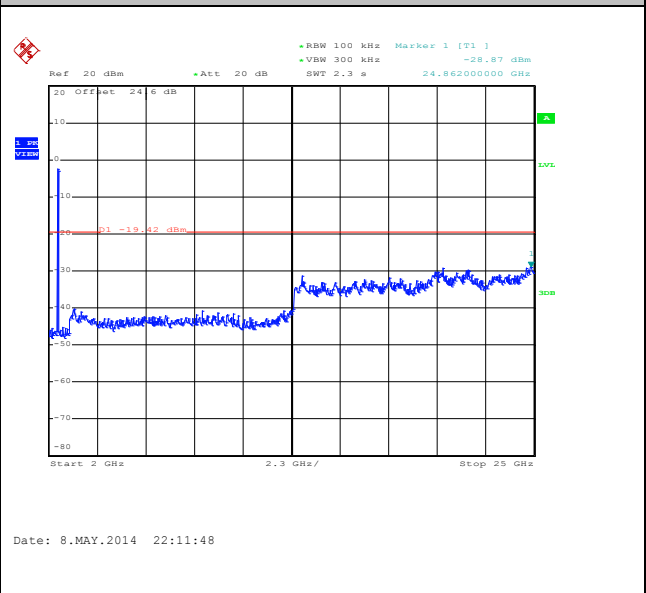



3.5 Radiated Band Edges and Spurious Emission Measurement

3.5.1 Limit of Radiated band edge and Spurious Emission Measurement

In any 100 kHz bandwidth outside the intentional radiator frequency band, all harmonics/spurious must be at least 20 dB below the highest emission level within the authorized band. If the output power of this device was measured by spectrum analyzer, the attenuation under this paragraph shall be 30 dB instead of 20 dB. In addition, radiated emissions which fall in the restricted bands must also comply with the FCC section 15.209 limits as below.

Frequency (MHz)	Field Strength (microvolts/meter)	Measurement Distance (meters)
0.009 – 0.490	2400/F(kHz)	300
0.490 – 1.705	24000/F(kHz)	30
1.705 – 30.0	30	30
30 – 88	100	3
88 – 216	150	3
216 - 960	200	3
Above 960	500	3

3.5.2 Measuring Instruments

The measuring equipment is listed in the section 4 of this test report.



3.5.3 Test Procedures

1. The testing follows FCC KDB Publication No. 558074 D01 DTS Meas. Guidance v03r01.
2. The EUT was arranged to its worst case and then tune the antenna tower (from 1 m to 4 m) and turntable (from 0 degree to 360 degrees) to find the maximum reading. A pre-amp and a high pass filter are used for the test in order to get better signal level.
3. The EUT was placed on a turntable with 0.8 meter above ground.
4. The EUT was set 3 meters from the interference receiving antenna, which was mounted on the top of a variable height antenna tower.
5. Corrected Reading: Antenna Factor + Cable Loss + Read Level - Preamp Factor = Level
6. For measurement below 1GHz, If the emission level of the EUT measured by the peak detector is 3 dB lower than the applicable limit, the peak emission level will be reported. Otherwise, the emission measurement will be repeated using the quasi-peak detector and reported.
7. Use the following spectrum analyzer settings:
 - (1) Span shall wide enough to fully capture the emission being measured;
 - (2) Set RBW=100 kHz for $f < 1$ GHz; $VBW \geq RBW$; Sweep = auto; Detector function = peak; Trace = max hold;
 - (3) Set RBW = 1 MHz, VBW= 3MHz for $f \geq 1$ GHz for peak measurement.

For average measurement:

 - $VBW = 10$ Hz, when duty cycle is no less than 98 percent.
 - $VBW \geq 1/T$, when duty cycle is less than 98 percent where T is the minimum transmission duration over which the transmitter is on and is transmitting at its maximum power control level for the tested mode of operation.

Band	Duty Cycle(%)	T(μ s)	1/T(kHz)	VBW Setting
802.11b	97.63	8240.00	0.12	300Hz
802.11g	87.26	1370.00	0.73	1kHz
2.4GHz 802.11n HT20	86.49	1280.00	0.78	1kHz

3.5.4 Test Setup

For radiated emissions below 30MHz

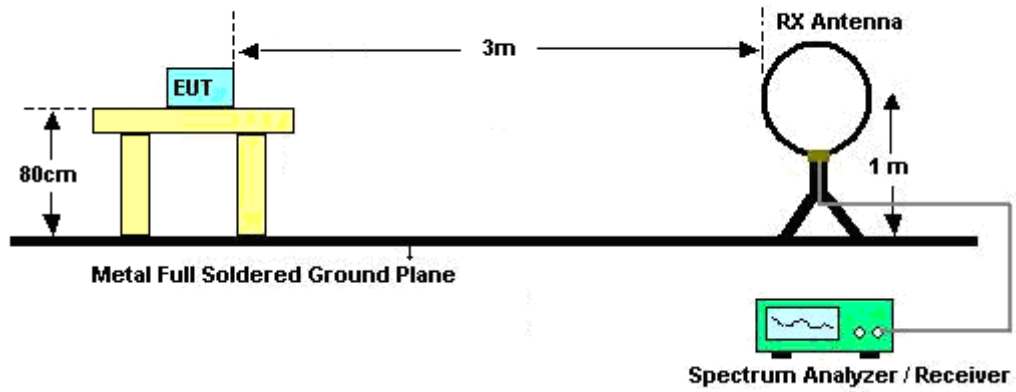

For radiated emissions from 30MHz to 1GHz

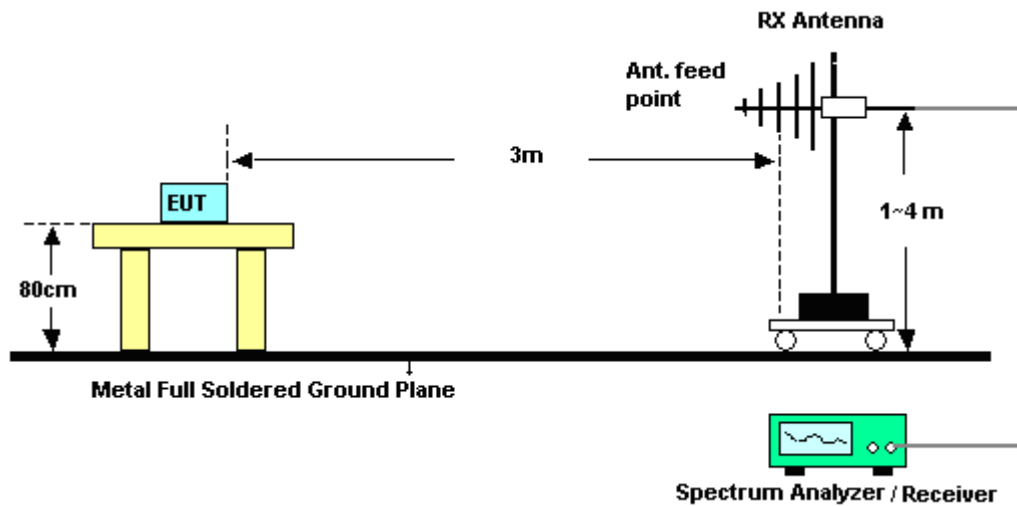

For radiated emissions above 1GHz

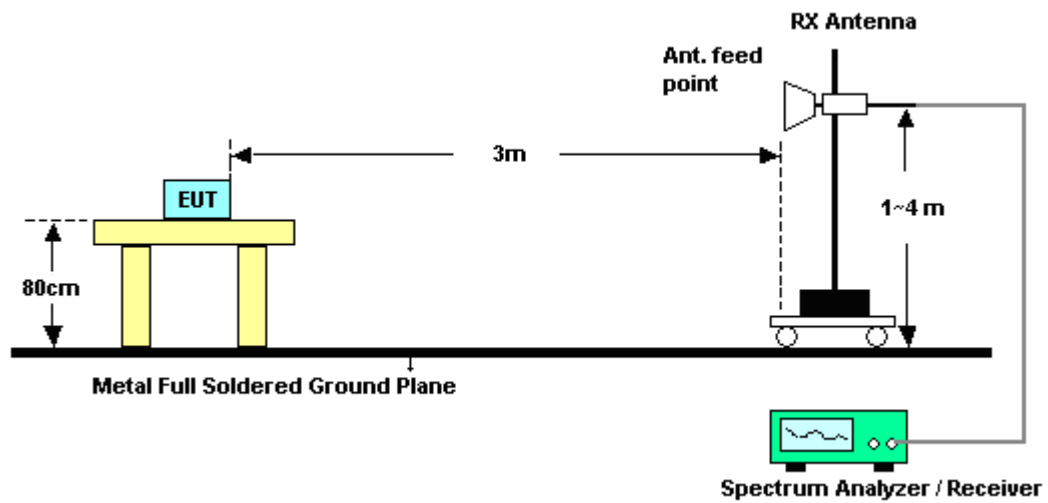

3.5.5 Test Results of Radiated Spurious Emissions (9kHz ~ 30MHz)

The low frequency, which started from 9 kHz to 30MHz, was pre-scanned and the result which was 20dB lower than the limit line per 15.31(o) was not reported.



3.5.6 Test Result of Radiated Spurious at Band Edges

Test Mode :	802.11b	Temperature :	24~25°C
Test Band :	Low	Relative Humidity :	45~46%
Test Channel :	01	Test Engineer :	Eric Shih

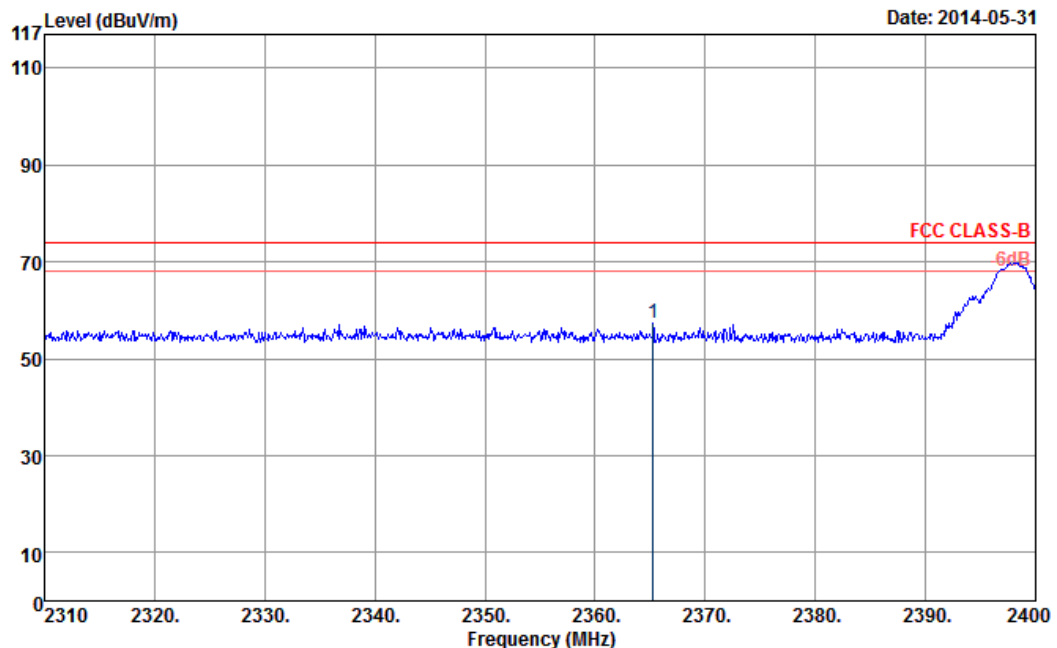

Site : 03CH07-HY
 Condition : FCC CLASS-B 3m HF-ANT_120823 HORIZONTAL
 : RBW:1000.000KHz VBW:3000.000KHz SWT:Auto

ANTENNA POLARITY : HORIZONTAL

Frequency (MHz)	Level (dBμV/m)	Over Limit (dB)	Limit Line (dBμV/m)	Read Level (dBμV)	Antenna Factor (dB)	Cable Loss (dB)	Preamp Factor (dB)	Ant Pos (cm)	Table Pos (deg)	Remark
2365.26	57.52	-16.48	74	52.65	32.26	6.88	34.27	101	339	Peak

Note: Worst case measurement on 2365.26 MHz is compliance with 74/54 dBuV/m (peak/average) limit and band edge measurement in the restricted band 2310-2390MHz. And, 2390-2400 MHz is non-restricted band which limit line is 20dB below the fundamental frequency emission level which is tested by conducted spurious emission. Both the test results are compliance with the FCC limit line.



Test Mode :	802.11b	Temperature :	24~25°C
Test Band :	Low	Relative Humidity :	45~46%
Test Channel :	01	Test Engineer :	Eric Shih

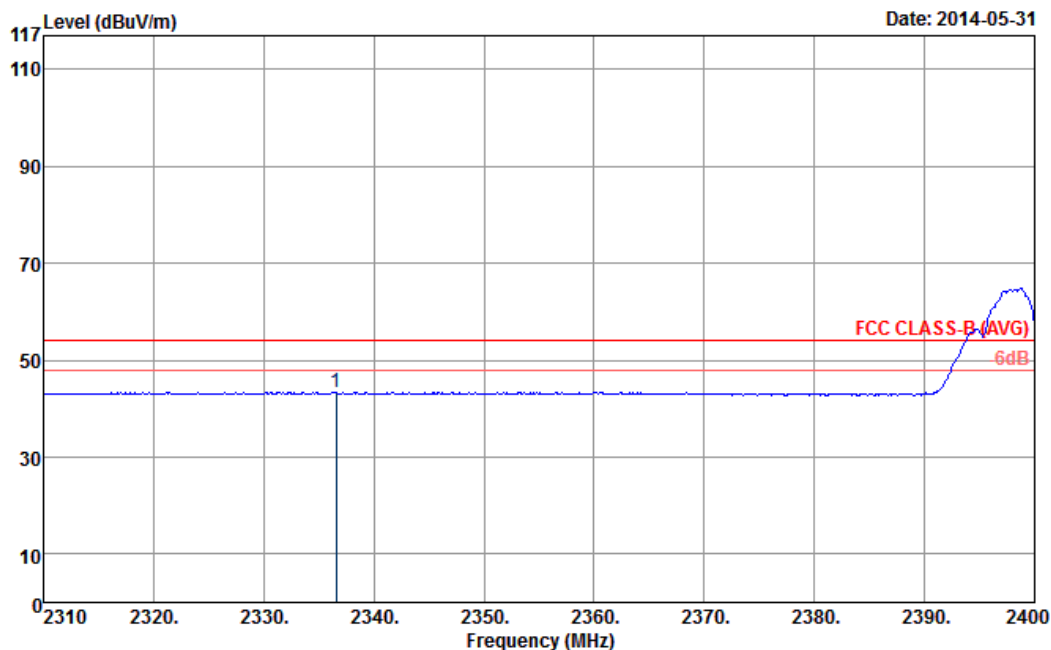

Site : 03CH07-HY
 Condition : FCC CLASS-B (AVG) 3m HF-ANT_120823 HORIZONTAL
 : RBW:1000.000KHz VBW:0.300KHz SWT:Auto

ANTENNA POLARITY : HORIZONTAL

Frequency (MHz)	Level (dBμV/m)	Over Limit (dB)	Limit Line (dBμV/m)	Read Level (dBμV)	Antenna Factor (dB)	Cable Loss (dB)	Preamp Factor (dB)	Ant Pos (cm)	Table Pos (deg)	Remark
2336.55	43.35	-10.65	54	38.49	32.24	6.84	34.22	101	339	Average

Note: Worst case measurement on 2336.55 MHz is compliance with 74/54 dBuV/m (peak/average) limit and band edge measurement in the restricted band 2310-2390MHz. And, 2390-2400 MHz is non-restricted band which limit line is 20dB below the fundamental frequency emission level which is tested by conducted spurious emission. Both the test results are compliance with the FCC limit line.



Test Mode :	802.11b	Temperature :	24~25°C
Test Band :	Low	Relative Humidity :	45~46%
Test Channel :	01	Test Engineer :	Eric Shih

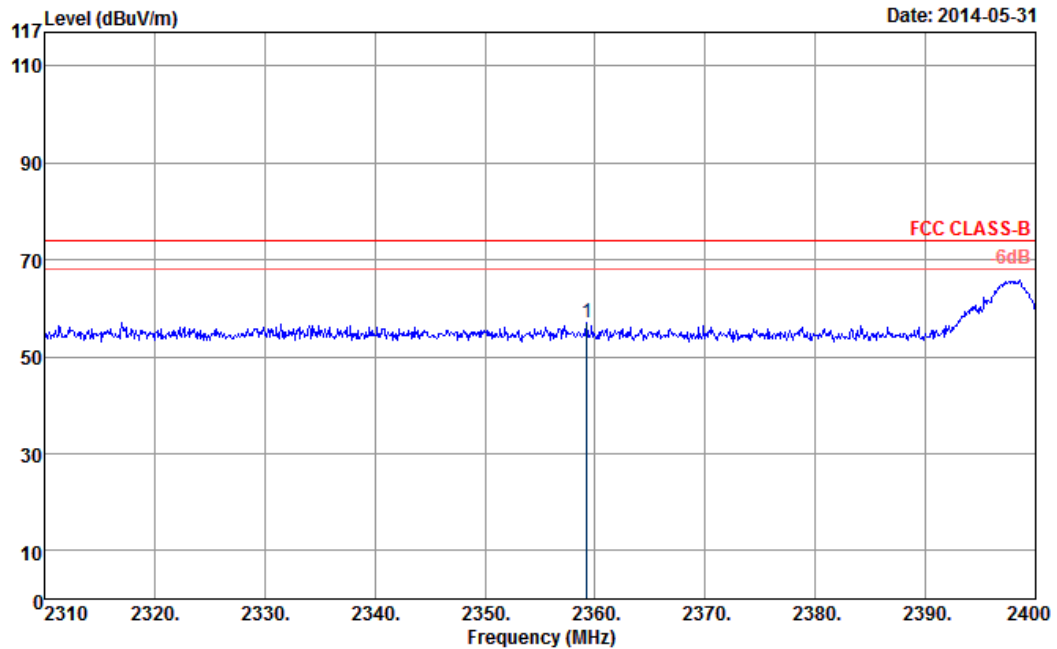

Site : 03CH07-HY
 Condition : FCC CLASS-B 3m HF-ANT_120823 VERTICAL
 : RBW:1000.000KHz VBW:3000.000KHz SWT:Auto

ANTENNA POLARITY : VERTICAL

Frequency (MHz)	Level (dBμV/m)	Over Limit (dB)	Limit Line (dBμV/m)	Read Level (dBμV)	Antenna Factor (dB)	Cable Loss (dB)	Preamp Factor (dB)	Ant Pos (cm)	Table Pos (deg)	Remark
2359.23	57.03	-16.97	74	52.14	32.26	6.88	34.25	138	70	Peak

Note: Worst case measurement on 2359.23 MHz is compliance with 74/54 dBuV/m (peak/average) limit and band edge measurement in the restricted band 2310-2390MHz. And, 2390-2400 MHz is non-restricted band which limit line is 20dB below the fundamental frequency emission level which is tested by conducted spurious emission. Both the test results are compliance with the FCC limit line.



Test Mode :	802.11b	Temperature :	24~25°C
Test Band :	Low	Relative Humidity :	45~46%
Test Channel :	01	Test Engineer :	Eric Shih

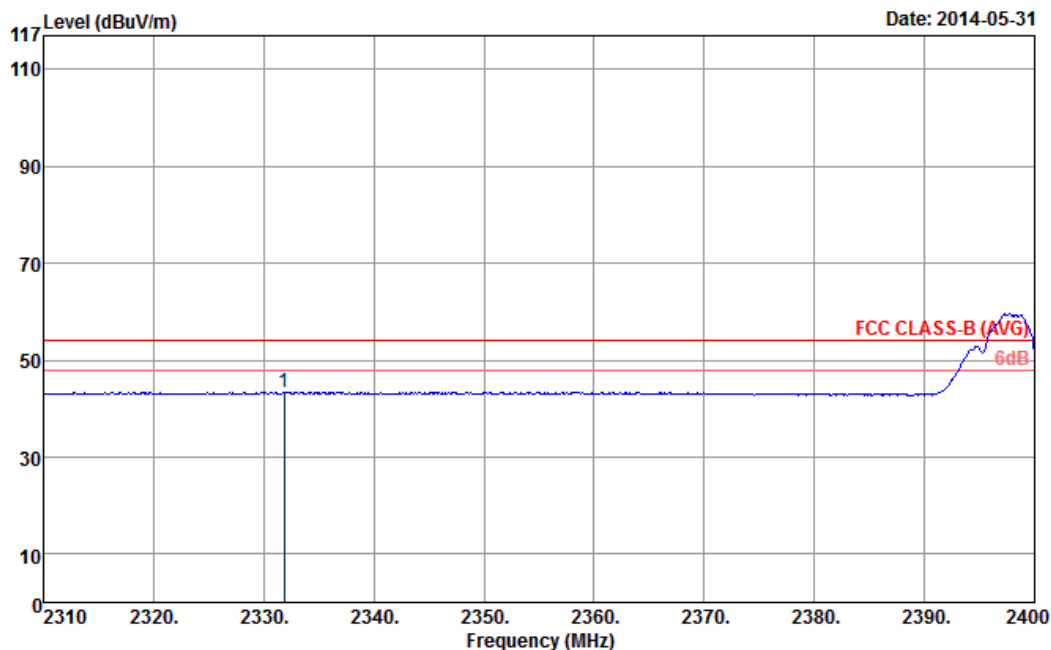

Site : 03CH07-HY
 Condition : FCC CLASS-B (AVG) 3m HF-ANT_120823 VERTICAL
 : RBW:1000.000KHz VBW:0.300KHz SWT:Auto

ANTENNA POLARITY : VERTICAL

Frequency (MHz)	Level (dBμV/m)	Over Limit (dB)	Limit Line (dBμV/m)	Read Level (dBμV)	Antenna Factor (dB)	Cable Loss (dB)	Preamp Factor (dB)	Ant Pos (cm)	Table Pos (deg)	Remark
2331.87	43.4	-10.6	54	38.59	32.23	6.8	34.22	138	70	Average

Note: Worst case measurement on 2331.87 MHz is compliance with 74/54 dBUV/m (peak/average) limit and band edge measurement in the restricted band 2310-2390MHz. And, 2390-2400 MHz is non-restricted band which limit line is 20dB below the fundamental frequency emission level which is tested by conducted spurious emission. Both the test results are compliance with the FCC limit line.



Test Mode :	802.11b	Temperature :	24~25°C
Test Band :	High	Relative Humidity :	45~46%
Test Channel :	11	Test Engineer :	Eric Shih

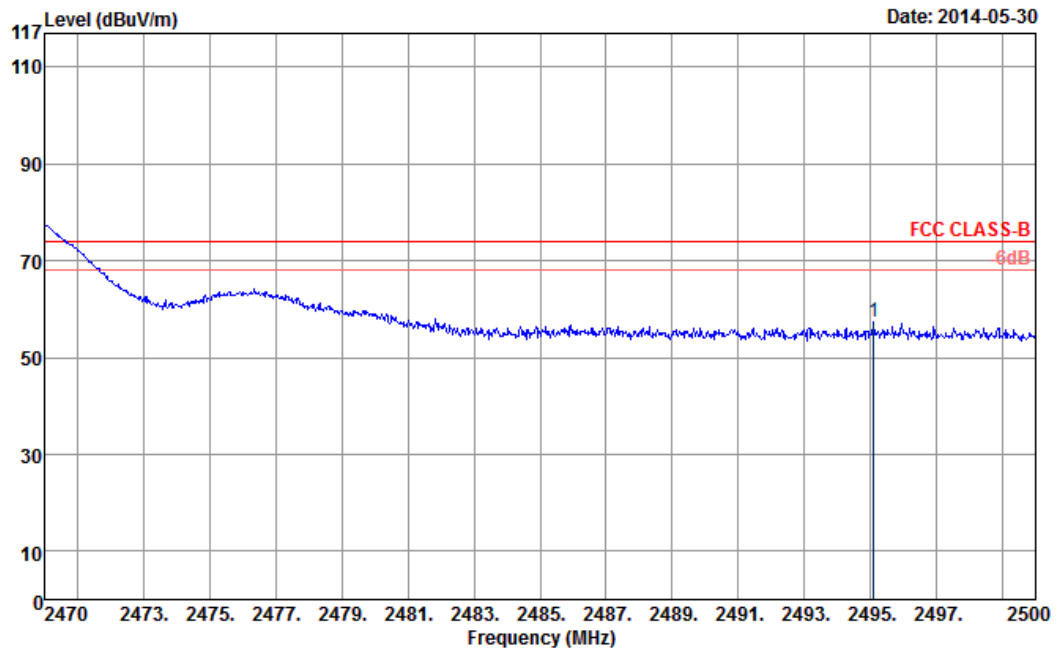

Site : 03CH07-HY
 Condition : FCC CLASS-B 3m HF-ANT_120823 HORIZONTAL
 : RBW:1000.000KHz VBW:3000.000KHz SWT:Auto

ANTENNA POLARITY : HORIZONTAL

Frequency (MHz)	Level (dBμV/m)	Over Limit (dB)	Limit Line (dBμV/m)	Read Level (dBμV)	Antenna Factor (dB)	Cable Loss (dB)	Preamp Factor (dB)	Ant Pos (cm)	Table Pos (deg)	Remark
2495.11	57.23	-16.77	74	52.25	32.4	7.06	34.48	100	349	Peak

Note: Worst case measurement on 2495.11 MHz is compliance with 74/54 dBuV/m (peak/average) limit and band edge measurement in the restricted band 2483.5-2500MHz. And, 2470-2483.5MHz is within the operating band and not within the restricted band. The test result is compliance with the FCC limit line.



Test Mode :	802.11b	Temperature :	24~25°C
Test Band :	High	Relative Humidity :	45~46%
Test Channel :	11	Test Engineer :	Eric Shih

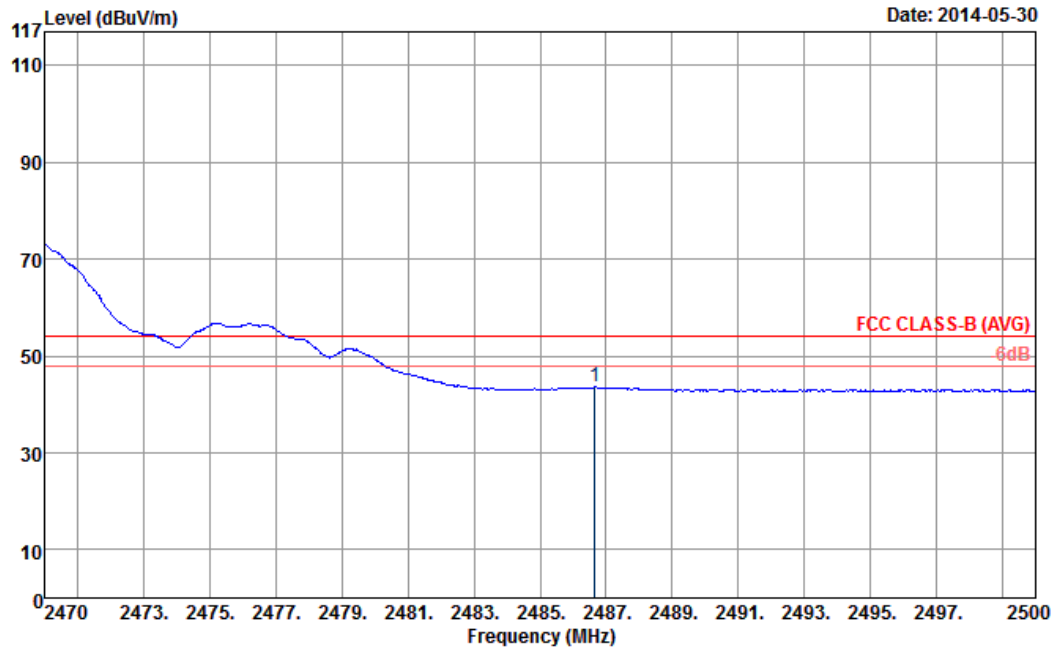

Site : 03CH07-HY
 Condition : FCC CLASS-B (AVG) 3m HF-ANT_120823 HORIZONTAL
 : RBW:1000.000KHz VBW:0.300KHz SWT:Auto

ANTENNA POLARITY : HORIZONTAL

Frequency (MHz)	Level (dBμV/m)	Over Limit (dB)	Limit Line (dBμV/m)	Read Level (dBμV)	Antenna Factor (dB)	Cable Loss (dB)	Preamp Factor (dB)	Ant Pos (cm)	Table Pos (deg)	Remark
2486.65	43.56	-10.44	54	38.55	32.38	7.06	34.43	100	349	Average

Note: Worst case measurement on 2486.65 MHz is compliance with 74/54 dBuV/m (peak/average) limit and band edge measurement in the restricted band 2483.5-2500MHz. And, 2470-2483.5MHz is within the operating band and not within the restricted band. The test result is compliance with the FCC limit line.



Test Mode :	802.11b	Temperature :	24~25°C
Test Band :	High	Relative Humidity :	45~46%
Test Channel :	11	Test Engineer :	Eric Shih

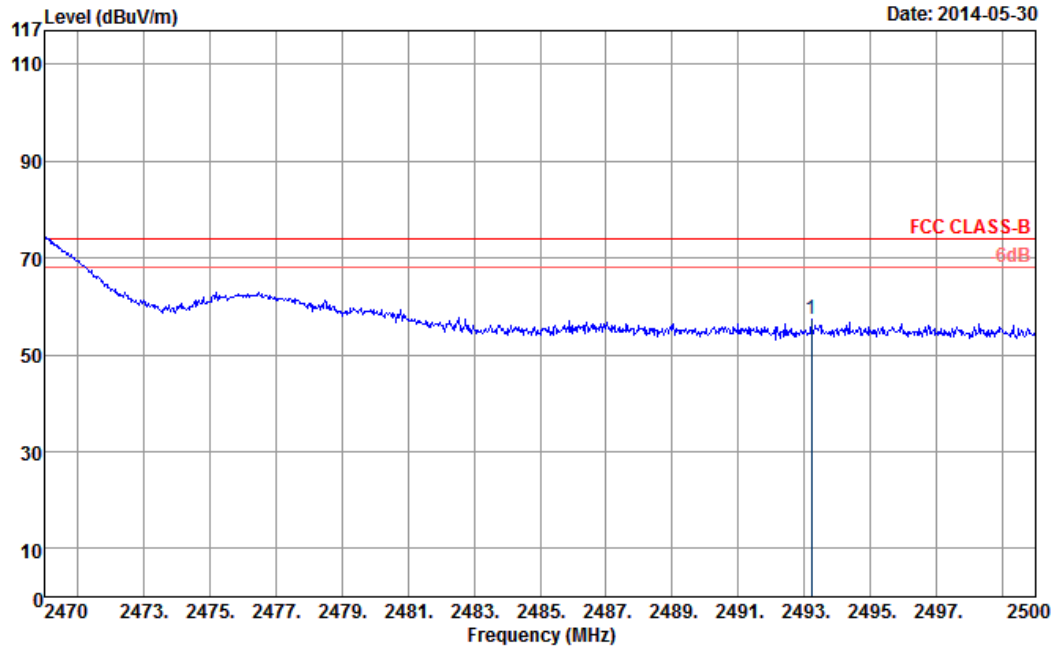

Site : 03CH07-HY
 Condition : FCC CLASS-B 3m HF-ANT_120823 VERTICAL
 : RBW:1000.000KHz VBW:3000.000KHz SWT:Auto

ANTENNA POLARITY : VERTICAL

Frequency (MHz)	Level (dBμV/m)	Over Limit (dB)	Limit Line (dBμV/m)	Read Level (dBμV)	Antenna Factor (dB)	Cable Loss (dB)	Preamp Factor (dB)	Ant Pos (cm)	Table Pos (deg)	Remark
2493.22	57.48	-16.52	74	52.5	32.4	7.06	34.48	131	108	Peak

Note: Worst case measurement on 2493.22 MHz is compliance with 74/54 dBuV/m (peak/average) limit and band edge measurement in the restricted band 2483.5-2500MHz. And, 2470-2483.5MHz is within the operating band and not within the restricted band. The test result is compliance with the FCC limit line.



Test Mode :	802.11b	Temperature :	24~25°C
Test Band :	High	Relative Humidity :	45~46%
Test Channel :	11	Test Engineer :	Eric Shih

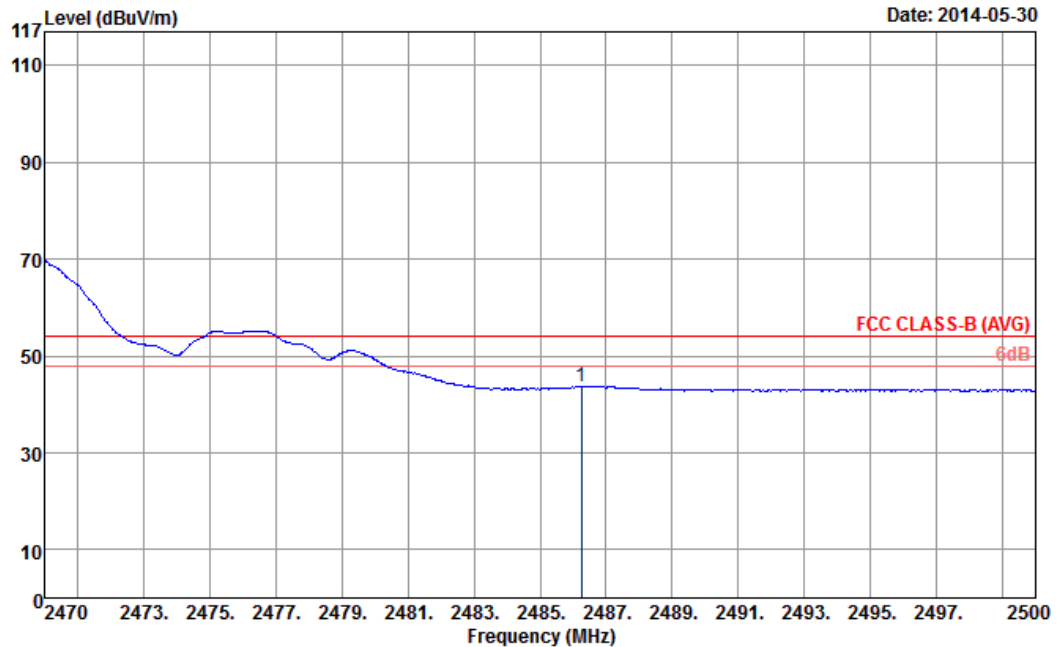

Site : 03CH07-HY
 Condition : FCC CLASS-B (AVG) 3m HF-ANT_120823 VERTICAL
 : RBW:1000.000KHz VBW:0.300KHz SWT:Auto

ANTENNA POLARITY : VERTICAL

Frequency (MHz)	Level (dBμV/m)	Over Limit (dB)	Limit Line (dBμV/m)	Read Level (dBμV)	Antenna Factor (dB)	Cable Loss (dB)	Preamp Factor (dB)	Ant Pos (cm)	Table Pos (deg)	Remark
2486.26	43.76	-10.24	54	38.75	32.38	7.06	34.43	131	108	Average

Note: Worst case measurement on 2486.26 MHz is compliance with 74/54 dBuV/m (peak/average) limit and band edge measurement in the restricted band 2483.5-2500MHz. And, 2470-2483.5MHz is within the operating band and not within the restricted band. The test result is compliance with the FCC limit line.



Test Mode :	802.11g	Temperature :	24~25°C
Test Band :	Low	Relative Humidity :	45~46%
Test Channel :	01	Test Engineer :	Eric Shih

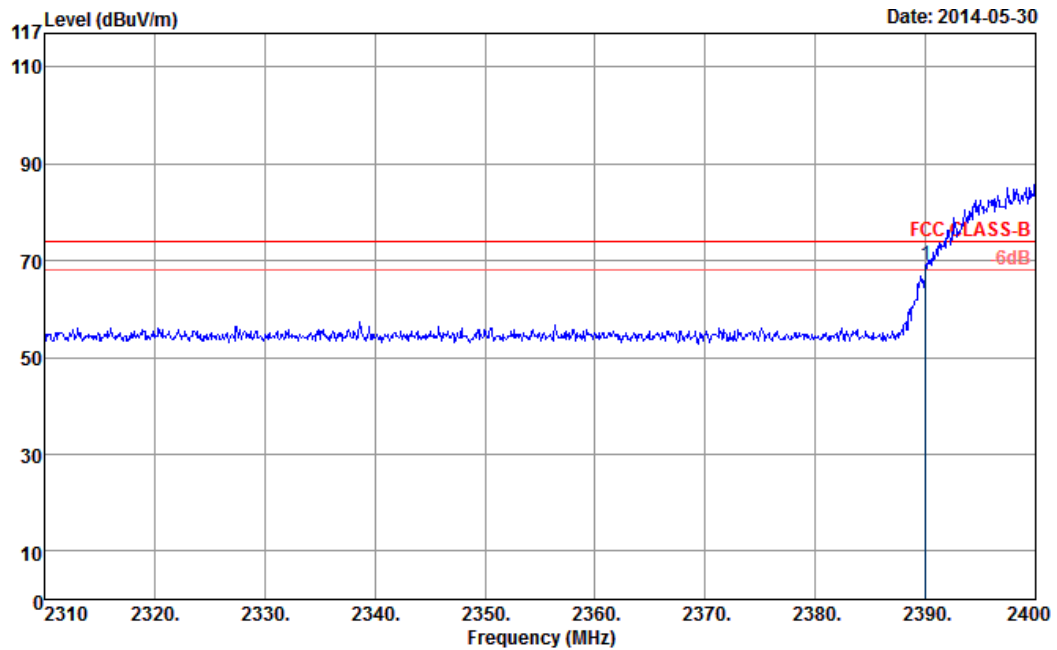

Site : 03CH07-HY
 Condition : FCC CLASS-B 3m HF-ANT_120823 HORIZONTAL
 : RBW:1000.000KHz VBW:3000.000KHz SWT:Auto

ANTENNA POLARITY : HORIZONTAL

Frequency (MHz)	Level (dBμV/m)	Over Limit (dB)	Limit Line (dBμV/m)	Read Level (dBμV)	Antenna Factor (dB)	Cable Loss (dB)	Preamp Factor (dB)	Ant Pos (cm)	Table Pos (deg)	Remark
2390	68.95	-5.05	74	64.04	32.3	6.91	34.3	100	60	Peak

Note: Worst case measurement on 2390 MHz is compliance with 74/54 dBuV/m (peak/average) limit and band edge measurement in the restricted band 2310-2390MHz. And, 2390-2400 MHz is non-restricted band which limit line is 20dB below the fundamental frequency emission level which is tested by conducted spurious emission. Both the test results are compliance with the FCC limit line.



Test Mode :	802.11g	Temperature :	24~25°C
Test Band :	Low	Relative Humidity :	45~46%
Test Channel :	01	Test Engineer :	Eric Shih

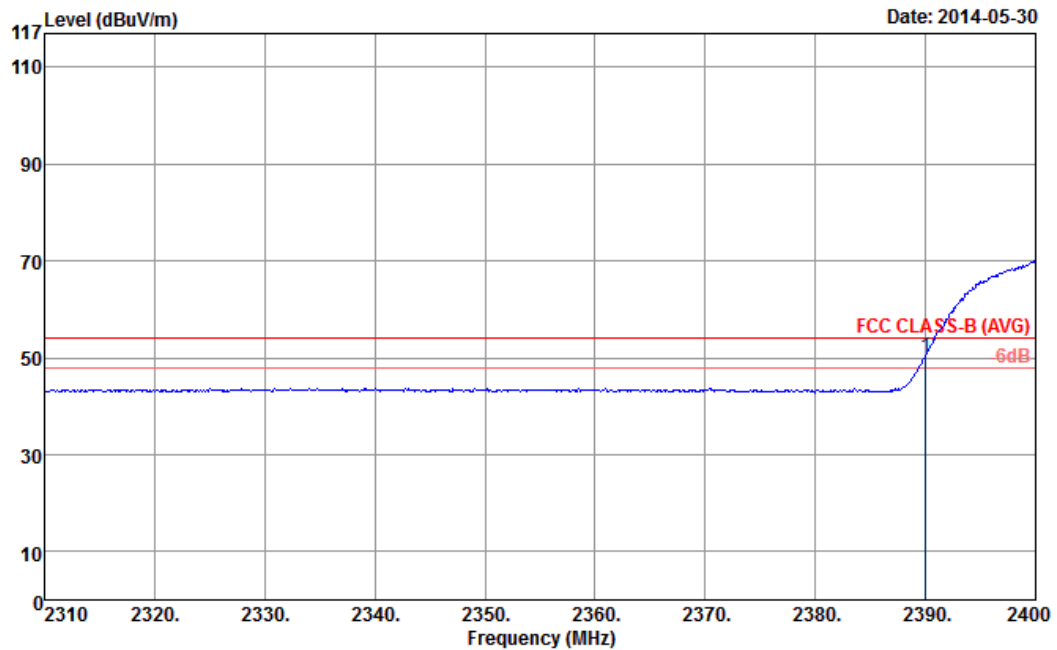

Site : 03CH07-HY
 Condition : FCC CLASS-B (AVG) 3m HF-ANT_120823 HORIZONTAL
 : RBW:1000.000KHz VBW:1.000KHz SWT:Auto

ANTENNA POLARITY : HORIZONTAL

Frequency (MHz)	Level (dBμV/m)	Over Limit (dB)	Limit Line (dBμV/m)	Read Level (dBμV)	Antenna Factor (dB)	Cable Loss (dB)	Preamp Factor (dB)	Ant Pos (cm)	Table Pos (deg)	Remark
2390	50.28	-3.72	54	45.37	32.3	6.91	34.3	100	60	Average

Note: Worst case measurement on 2390 MHz is compliance with 74/54 dBUV/m (peak/average) limit and band edge measurement in the restricted band 2310-2390MHz. And, 2390-2400 MHz is non-restricted band which limit line is 20dB below the fundamental frequency emission level which is tested by conducted spurious emission. Both the test results are compliance with the FCC limit line.



Test Mode :	802.11g	Temperature :	24~25°C
Test Band :	Low	Relative Humidity :	45~46%
Test Channel :	01	Test Engineer :	Eric Shih

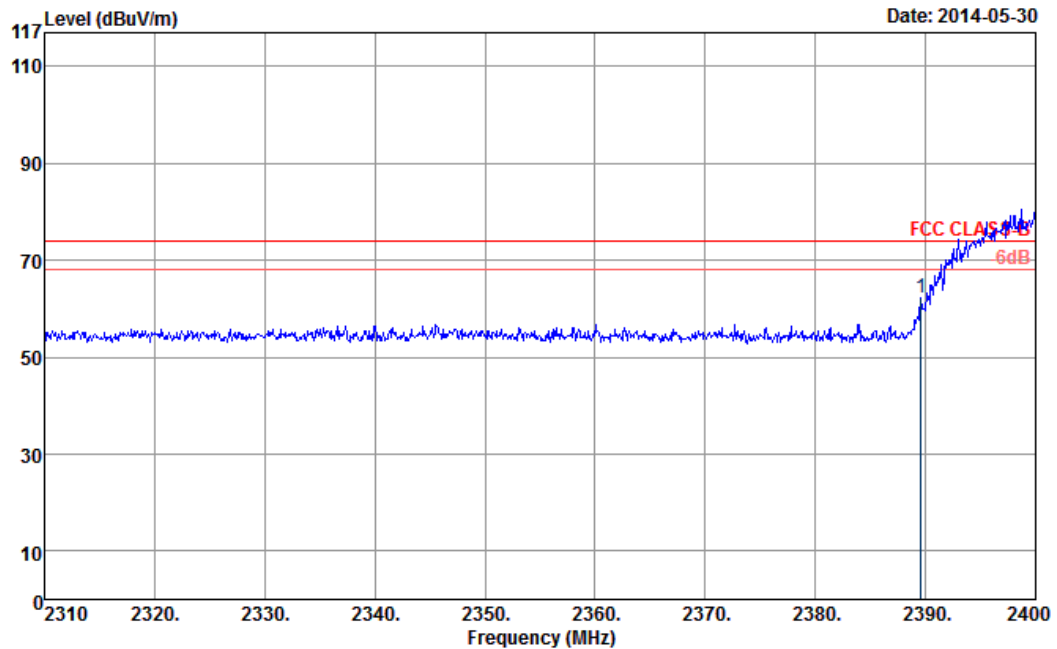

Site : 03CH07-HY
 Condition : FCC CLASS-B 3m HF-ANT_120823 VERTICAL
 : RBW:1000.000KHz VBW:3000.000KHz SWT:Auto

ANTENNA POLARITY : VERTICAL

Frequency (MHz)	Level (dBμV/m)	Over Limit (dB)	Limit Line (dBμV/m)	Read Level (dBμV)	Antenna Factor (dB)	Cable Loss (dB)	Preamp Factor (dB)	Ant Pos (cm)	Table Pos (deg)	Remark
2389.56	62.19	-11.81	74	57.25	32.3	6.91	34.27	102	336	Peak

Note: Worst case measurement on 2389.56 MHz is compliance with 74/54 dBuV/m (peak/average) limit and band edge measurement in the restricted band 2310-2390MHz. And, 2390-2400 MHz is non-restricted band which limit line is 20dB below the fundamental frequency emission level which is tested by conducted spurious emission. Both the test results are compliance with the FCC limit line.



Test Mode :	802.11g	Temperature :	24~25°C
Test Band :	Low	Relative Humidity :	45~46%
Test Channel :	01	Test Engineer :	Eric Shih

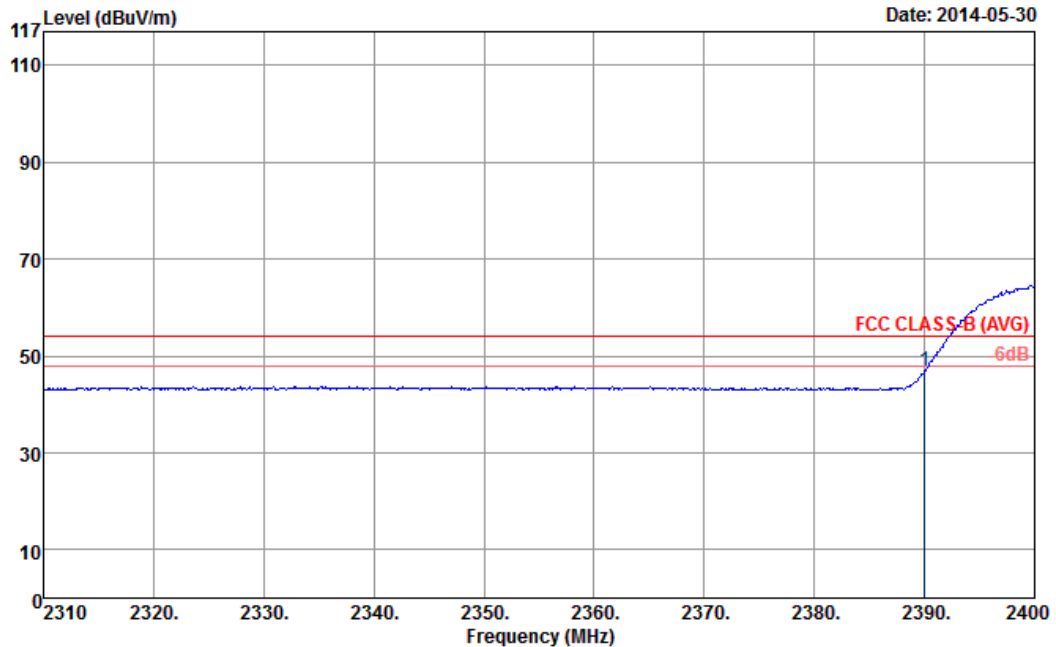

Site : 03CH07-HY
 Condition : FCC CLASS-B (AVG) 3m HF-ANT_120823 VERTICAL
 : RBW:1000.000KHz VBW:1.000KHz SWT:Auto

ANTENNA POLARITY : VERTICAL

Frequency (MHz)	Level (dBμV/m)	Over Limit (dB)	Limit Line (dBμV/m)	Read Level (dBμV)	Antenna Factor (dB)	Cable Loss (dB)	Preamp Factor (dB)	Ant Pos (cm)	Table Pos (deg)	Remark
2390	46.8	-7.2	54	41.89	32.3	6.91	34.3	102	336	Average

Note: Worst case measurement on 2390 MHz is compliance with 74/54 dBuV/m (peak/average) limit and band edge measurement in the restricted band 2310-2390MHz. And, 2390-2400 MHz is non-restricted band which limit line is 20dB below the fundamental frequency emission level which is tested by conducted spurious emission. Both the test results are compliance with the FCC limit line.



Test Mode :	802.11g	Temperature :	24~25°C
Test Band :	High	Relative Humidity :	45~46%
Test Channel :	11	Test Engineer :	Eric Shih

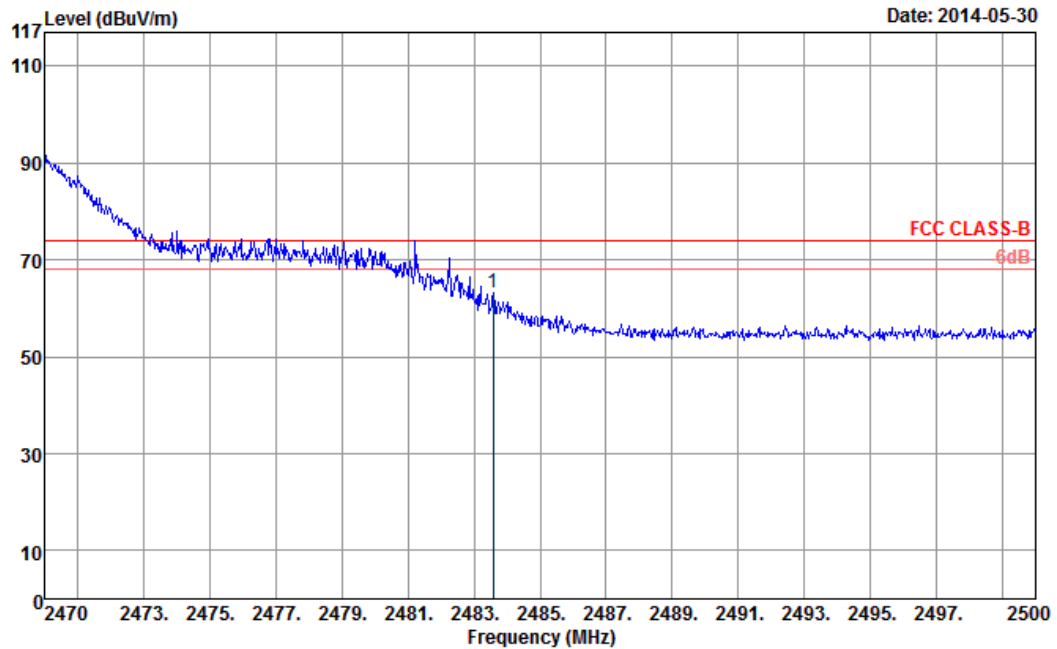

Site : 03CH07-HY
 Condition : FCC CLASS-B 3m HF-ANT_120823 HORIZONTAL
 : RBW:1000.000KHz VBW:3000.000KHz SWT:Auto

ANTENNA POLARITY : HORIZONTAL

Frequency (MHz)	Level (dBμV/m)	Over Limit (dB)	Limit Line (dBμV/m)	Read Level (dBμV)	Antenna Factor (dB)	Cable Loss (dB)	Preamp Factor (dB)	Ant Pos (cm)	Table Pos (deg)	Remark
2483.59	63.3	-10.7	74	58.29	32.38	7.06	34.43	100	72	Peak

Note: Worst case measurement on 2483.59 MHz is compliance with 74/54 dBuV/m (peak/average) limit and band edge measurement in the restricted band 2483.5-2500MHz. And, 2470-2483.5MHz is within the operating band and not within the restricted band. The test result is compliance with the FCC limit line.



Test Mode :	802.11g	Temperature :	24~25°C
Test Band :	High	Relative Humidity :	45~46%
Test Channel :	11	Test Engineer :	Eric Shih

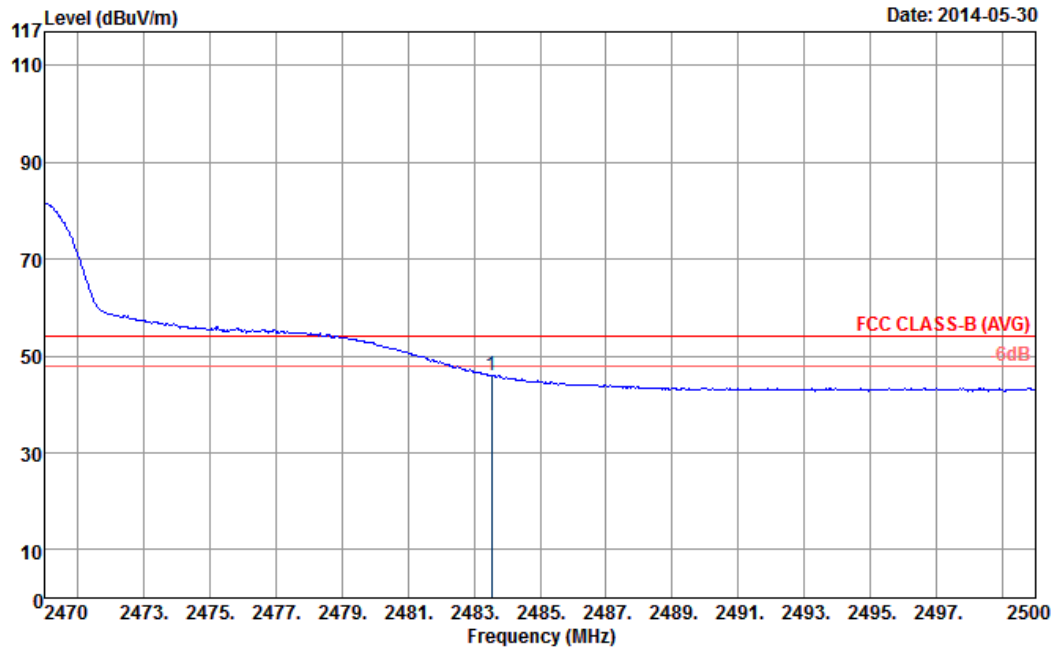

Site : 03CH07-HY
 Condition : FCC CLASS-B (AVG) 3m HF-ANT_120823 HORIZONTAL
 : RBW:1000.000KHz VBW:1.000KHz SWT:Auto

ANTENNA POLARITY : HORIZONTAL

Frequency (MHz)	Level (dBμV/m)	Over Limit (dB)	Limit Line (dBμV/m)	Read Level (dBμV)	Antenna Factor (dB)	Cable Loss (dB)	Preamp Factor (dB)	Ant Pos (cm)	Table Pos (deg)	Remark
2483.53	45.95	-8.05	54	40.94	32.38	7.06	34.43	100	72	Average

Note: Worst case measurement on 2483.53 MHz is compliance with 74/54 dBuV/m (peak/average) limit and band edge measurement in the restricted band 2483.5-2500MHz. And, 2470-2483.5MHz is within the operating band and not within the restricted band. The test result is compliance with the FCC limit line.



Test Mode :	802.11g	Temperature :	24~25°C
Test Band :	High	Relative Humidity :	45~46%
Test Channel :	11	Test Engineer :	Eric Shih

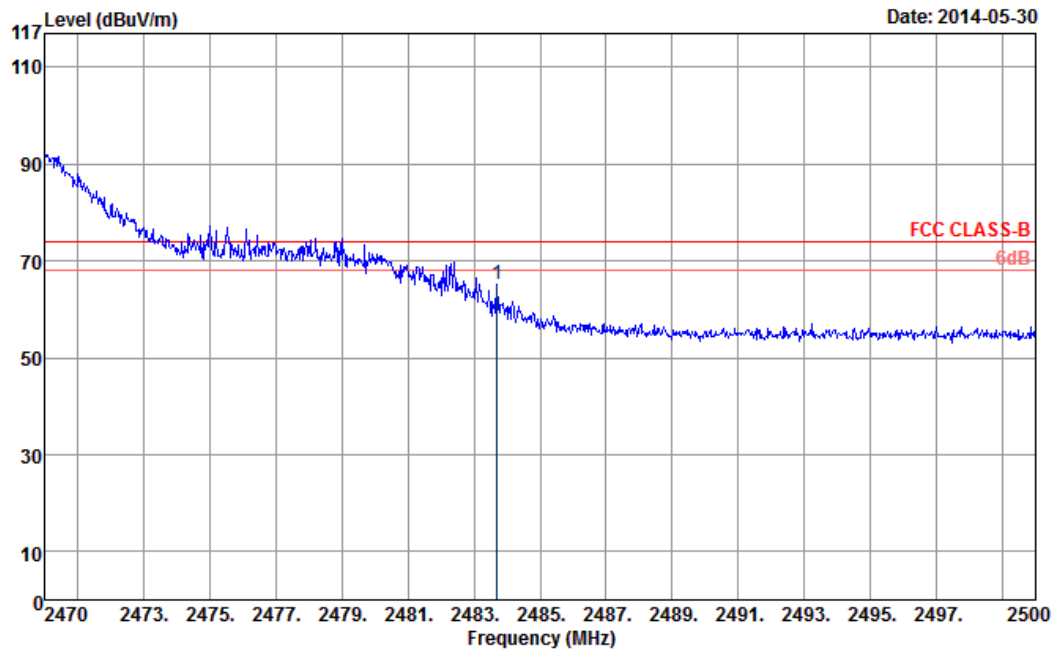

Site : 03CH07-HY
 Condition : FCC CLASS-B 3m HF-ANT_120823 VERTICAL
 : RBW:1000.000KHz VBW:3000.000KHz SWT:Auto

ANTENNA POLARITY : VERTICAL

Frequency (MHz)	Level (dBμV/m)	Over Limit (dB)	Limit Line (dBμV/m)	Read Level (dBμV)	Antenna Factor (dB)	Cable Loss (dB)	Preamp Factor (dB)	Ant Pos (cm)	Table Pos (deg)	Remark
2483.71	65.22	-8.78	74	60.21	32.38	7.06	34.43	131	83	Peak

Note: Worst case measurement on 2483.71 MHz is compliance with 74/54 dBuV/m (peak/average) limit and band edge measurement in the restricted band 2483.5-2500MHz. And, 2470-2483.5MHz is within the operating band and not within the restricted band. The test result is compliance with the FCC limit line.



Test Mode :	802.11g	Temperature :	24~25°C
Test Band :	High	Relative Humidity :	45~46%
Test Channel :	11	Test Engineer :	Eric Shih

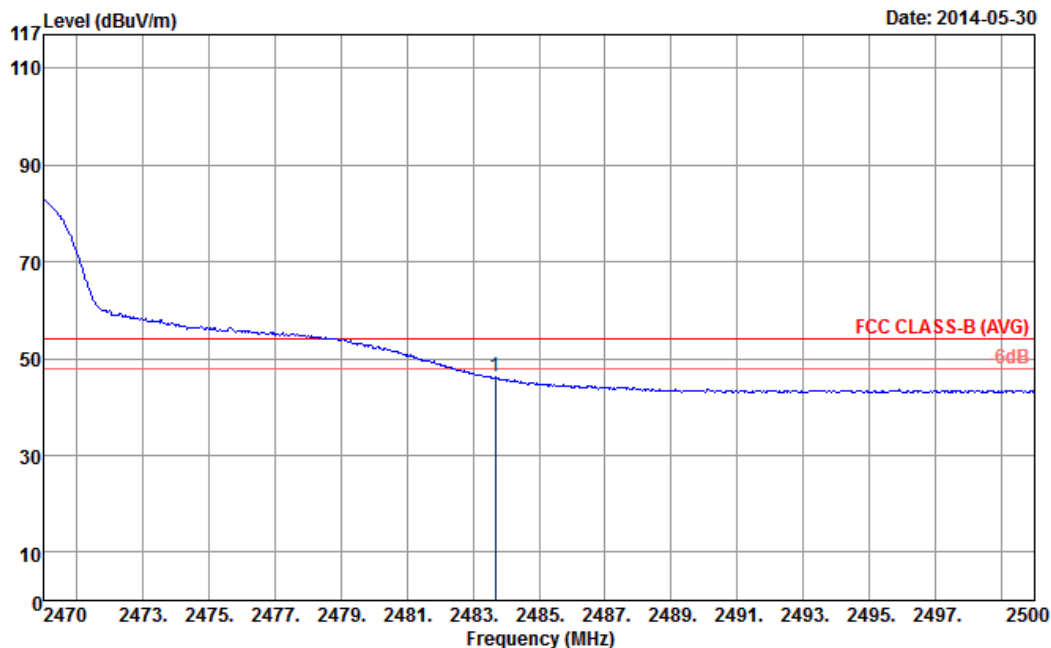

Site : 03CH07-HY
 Condition : FCC CLASS-B (AVG) 3m HF-ANT_120823 VERTICAL
 : RBW:1000.000KHz VBW:1.000KHz SWT:Auto

ANTENNA POLARITY : VERTICAL

Frequency (MHz)	Level (dBμV/m)	Over Limit (dB)	Limit Line (dBμV/m)	Read Level (dBμV)	Antenna Factor (dB)	Cable Loss (dB)	Preamp Factor (dB)	Ant Pos (cm)	Table Pos (deg)	Remark
2483.68	46.16	-7.84	54	41.15	32.38	7.06	34.43	131	83	Average

Note: Worst case measurement on 2483.68 MHz is compliance with 74/54 dBuV/m (peak/average) limit and band edge measurement in the restricted band 2483.5-2500MHz. And, 2470-2483.5MHz is within the operating band and not within the restricted band. The test result is compliance with the FCC limit line.



Test Mode :	802.11n HT20	Temperature :	24~25°C
Test Band :	Low	Relative Humidity :	45~46%
Test Channel :	01	Test Engineer :	Eric Shih

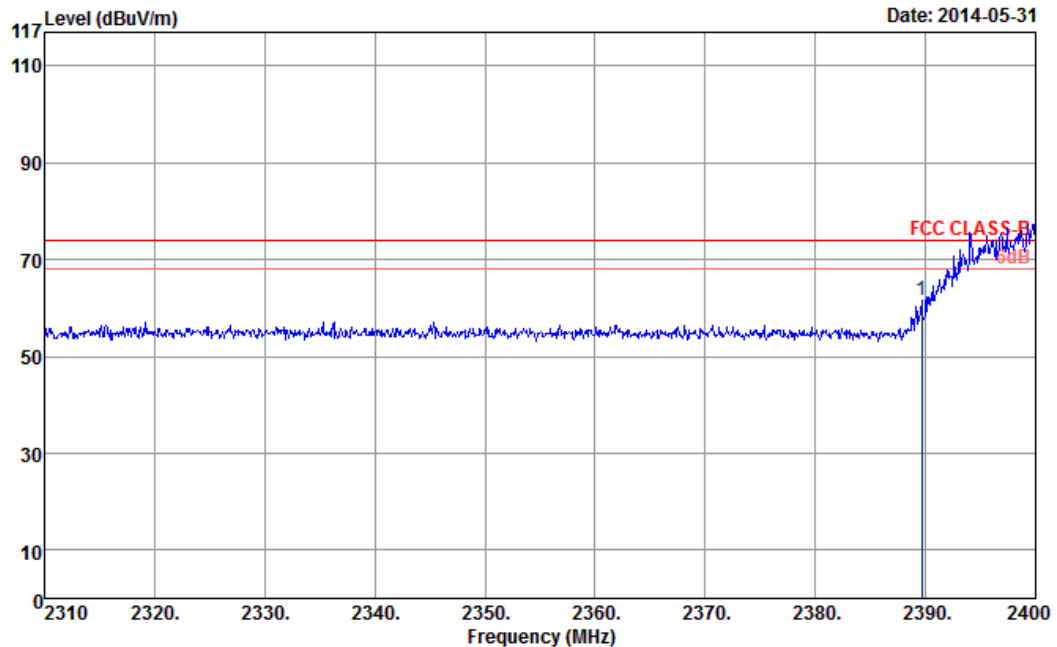

Site : 03CH07-HY
 Condition : FCC CLASS-B 3m HF-ANT_120823 HORIZONTAL
 : RBW:1000.000KHz VBW:3000.000KHz SWT:Auto

ANTENNA POLARITY : HORIZONTAL

Frequency (MHz)	Level (dBμV/m)	Over Limit (dB)	Limit Line (dBμV/m)	Read Level (dBμV)	Antenna Factor (dB)	Cable Loss (dB)	Preamp Factor (dB)	Ant Pos (cm)	Table Pos (deg)	Remark
2389.65	61.44	-12.56	74	56.5	32.3	6.91	34.27	100	280	Peak

Note: Worst case measurement on 2389.65 MHz is compliance with 74/54 dBuV/m (peak/average) limit and band edge measurement in the restricted band 2310-2390MHz. And, 2390-2400 MHz is non-restricted band which limit line is 20dB below the fundamental frequency emission level which is tested by conducted spurious emission. Both the test results are compliance with the FCC limit line.



Test Mode :	802.11n HT20	Temperature :	24~25°C
Test Band :	Low	Relative Humidity :	45~46%
Test Channel :	01	Test Engineer :	Eric Shih

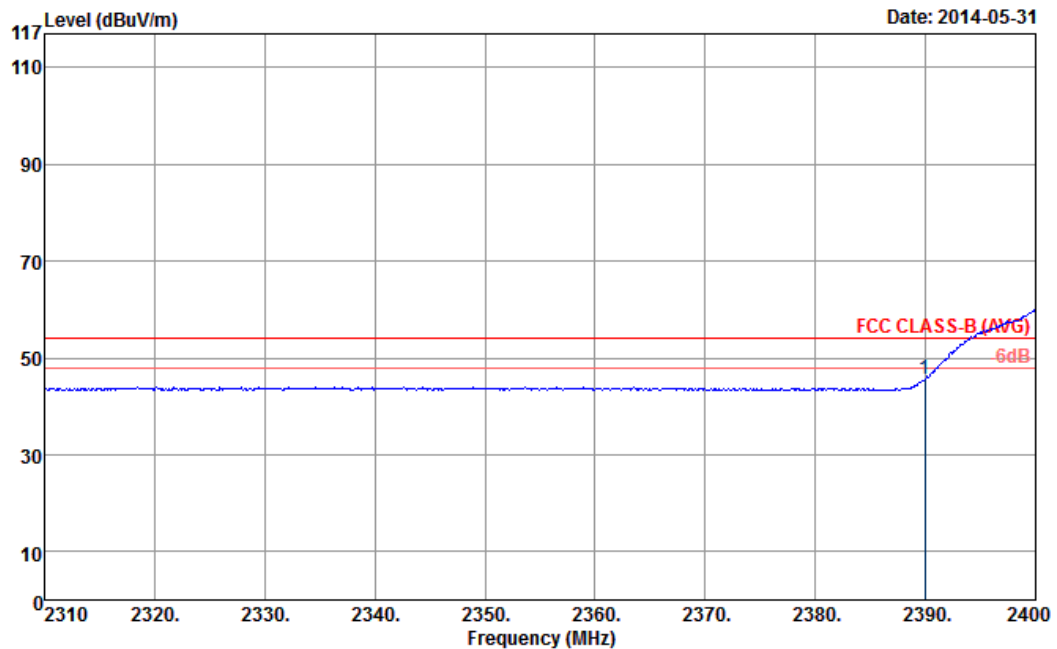

Site : 03CH07-HY
 Condition : FCC CLASS-B (AVG) 3m HF-ANT_120823 HORIZONTAL
 : RBW:1000.000KHz VBW:1.000KHz SWT:Auto

ANTENNA POLARITY : HORIZONTAL

Frequency (MHz)	Level (dBμV/m)	Over Limit (dB)	Limit Line (dBμV/m)	Read Level (dBμV)	Antenna Factor (dB)	Cable Loss (dB)	Preamp Factor (dB)	Ant Pos (cm)	Table Pos (deg)	Remark
2389.92	45.72	-8.28	54	40.81	32.3	6.91	34.3	100	280	Average

Note: Worst case measurement on 2389.92 MHz is compliance with 74/54 dBuV/m (peak/average) limit and band edge measurement in the restricted band 2310-2390MHz. And, 2390-2400 MHz is non-restricted band which limit line is 20dB below the fundamental frequency emission level which is tested by conducted spurious emission. Both the test results are compliance with the FCC limit line.



Test Mode :	802.11n HT20	Temperature :	24~25°C
Test Band :	Low	Relative Humidity :	45~46%
Test Channel :	01	Test Engineer :	Eric Shih

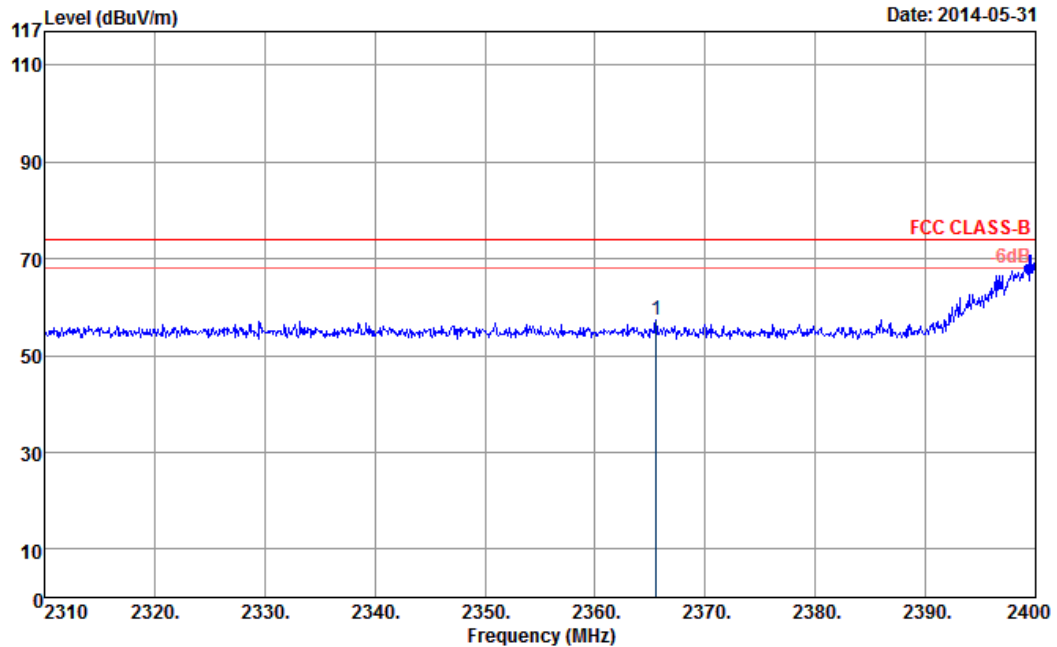

Site : 03CH07-HY
 Condition : FCC CLASS-B 3m HF-ANT_120823 VERTICAL
 : RBW:1000.000KHz VBW:3000.000KHz SWT:Auto

ANTENNA POLARITY : VERTICAL

Frequency (MHz)	Level (dBμV/m)	Over Limit (dB)	Limit Line (dBμV/m)	Read Level (dBμV)	Antenna Factor (dB)	Cable Loss (dB)	Preamp Factor (dB)	Ant Pos (cm)	Table Pos (deg)	Remark
2365.53	57.46	-16.54	74	52.59	32.26	6.88	34.27	188	242	Peak

Note: Worst case measurement on 2365.53 MHz is compliance with 74/54 dBuV/m (peak/average) limit and band edge measurement in the restricted band 2310-2390MHz. And, 2390-2400 MHz is non-restricted band which limit line is 20dB below the fundamental frequency emission level which is tested by conducted spurious emission. Both the test results are compliance with the FCC limit line.



Test Mode :	802.11n HT20	Temperature :	24~25°C
Test Band :	Low	Relative Humidity :	45~46%
Test Channel :	01	Test Engineer :	Eric Shih

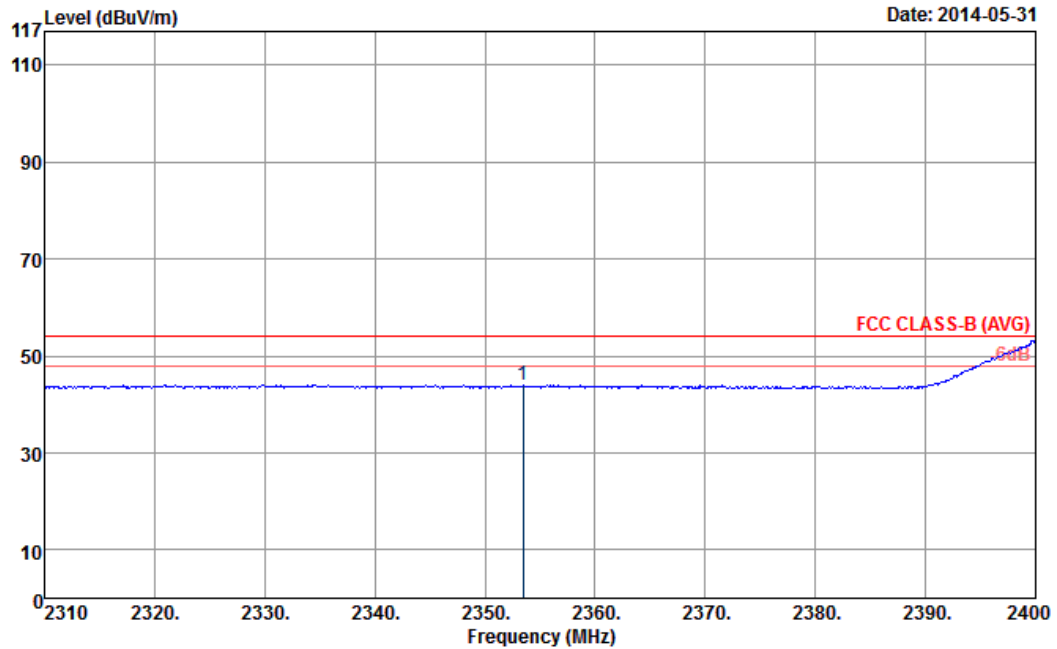

Site : 03CH07-HY
 Condition : FCC CLASS-B (AVG) 3m HF-ANT_120823 VERTICAL
 : RBW:1000.000KHz VBW:1.000KHz SWT:Auto

ANTENNA POLARITY : VERTICAL

Frequency (MHz)	Level (dBμV/m)	Over Limit (dB)	Limit Line (dBμV/m)	Read Level (dBμV)	Antenna Factor (dB)	Cable Loss (dB)	Preamp Factor (dB)	Ant Pos (cm)	Table Pos (deg)	Remark
2353.47	44.08	-9.92	54	39.23	32.26	6.84	34.25	188	242	Average

Note: Worst case measurement on 2353.47 MHz is compliance with 74/54 dBuV/m (peak/average) limit and band edge measurement in the restricted band 2310-2390MHz. And, 2390-2400 MHz is non-restricted band which limit line is 20dB below the fundamental frequency emission level which is tested by conducted spurious emission. Both the test results are compliance with the FCC limit line.



Test Mode :	802.11n HT20	Temperature :	24~25°C
Test Band :	High	Relative Humidity :	45~46%
Test Channel :	11	Test Engineer :	Eric Shih

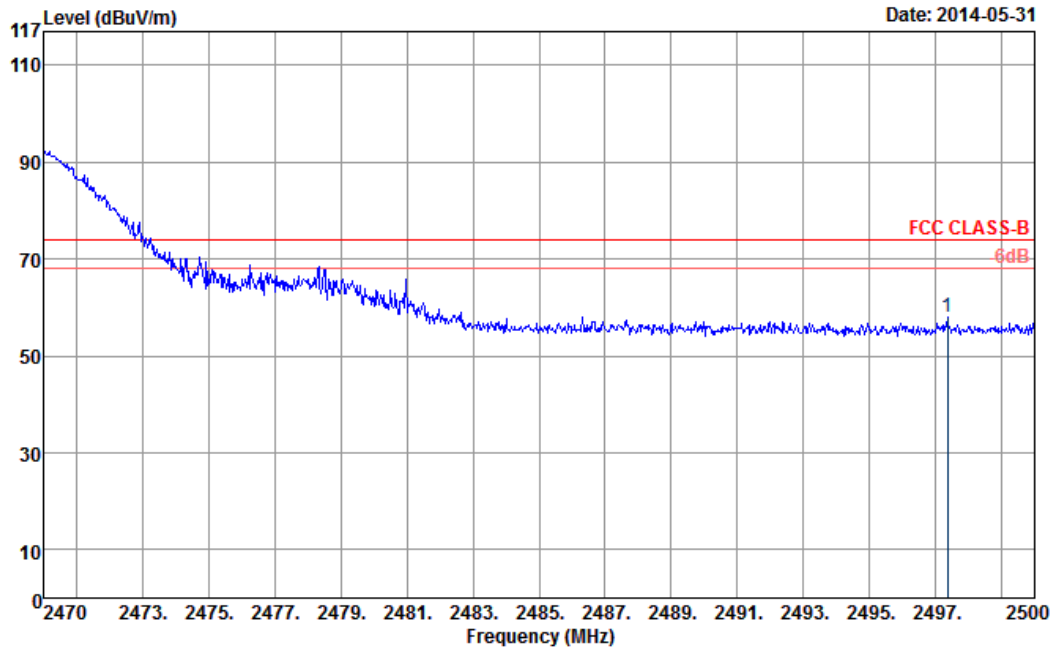

Site : 03CH07-HY
 Condition : FCC CLASS-B 3m HF-ANT_120823 HORIZONTAL
 : RBW:1000.000KHz VBW:3000.000KHz SWT:Auto

ANTENNA POLARITY : HORIZONTAL

Frequency (MHz)	Level (dBμV/m)	Over Limit (dB)	Limit Line (dBμV/m)	Read Level (dBμV)	Antenna Factor (dB)	Cable Loss (dB)	Preamp Factor (dB)	Ant Pos (cm)	Table Pos (deg)	Remark
2497.36	57.98	-16.02	74	53	32.4	7.06	34.48	126	57	Peak

Note: Worst case measurement on 2497.36 MHz is compliance with 74/54 dBuV/m (peak/average) limit and band edge measurement in the restricted band 2483.5-2500MHz. And, 2470-2483.5MHz is within the operating band and not within the restricted band. The test result is compliance with the FCC limit line.



Test Mode :	802.11n HT20	Temperature :	24~25°C
Test Band :	High	Relative Humidity :	45~46%
Test Channel :	11	Test Engineer :	Eric Shih

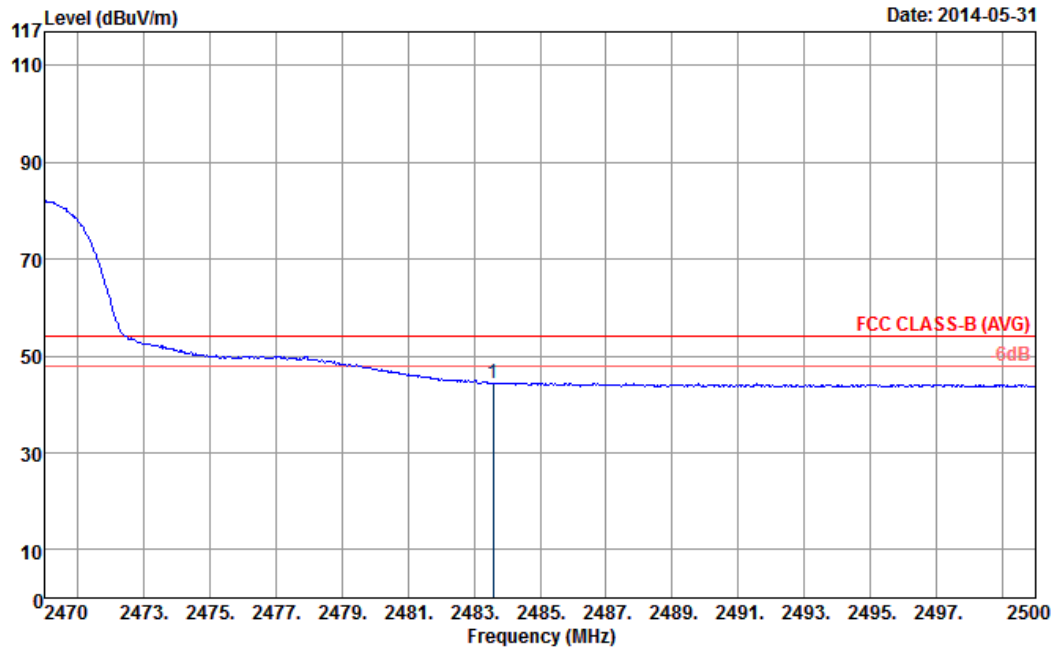

Site : 03CH07-HY
 Condition : FCC CLASS-B (AVG) 3m HF-ANT_120823 HORIZONTAL
 : RBW:1000.000KHz VBW:1.000KHz SWT:Auto

ANTENNA POLARITY : HORIZONTAL

Frequency (MHz)	Level (dBμV/m)	Over Limit (dB)	Limit Line (dBμV/m)	Read Level (dBμV)	Antenna Factor (dB)	Cable Loss (dB)	Preamp Factor (dB)	Ant Pos (cm)	Table Pos (deg)	Remark
2483.59	44.43	-9.57	54	39.42	32.38	7.06	34.43	126	57	Average

Note: Worst case measurement on 2483.59 MHz is compliance with 74/54 dBuV/m (peak/average) limit and band edge measurement in the restricted band 2483.5-2500MHz. And, 2470-2483.5MHz is within the operating band and not within the restricted band. The test result is compliance with the FCC limit line.



Test Mode :	802.11n HT20	Temperature :	24~25°C
Test Band :	High	Relative Humidity :	45~46%
Test Channel :	11	Test Engineer :	Eric Shih

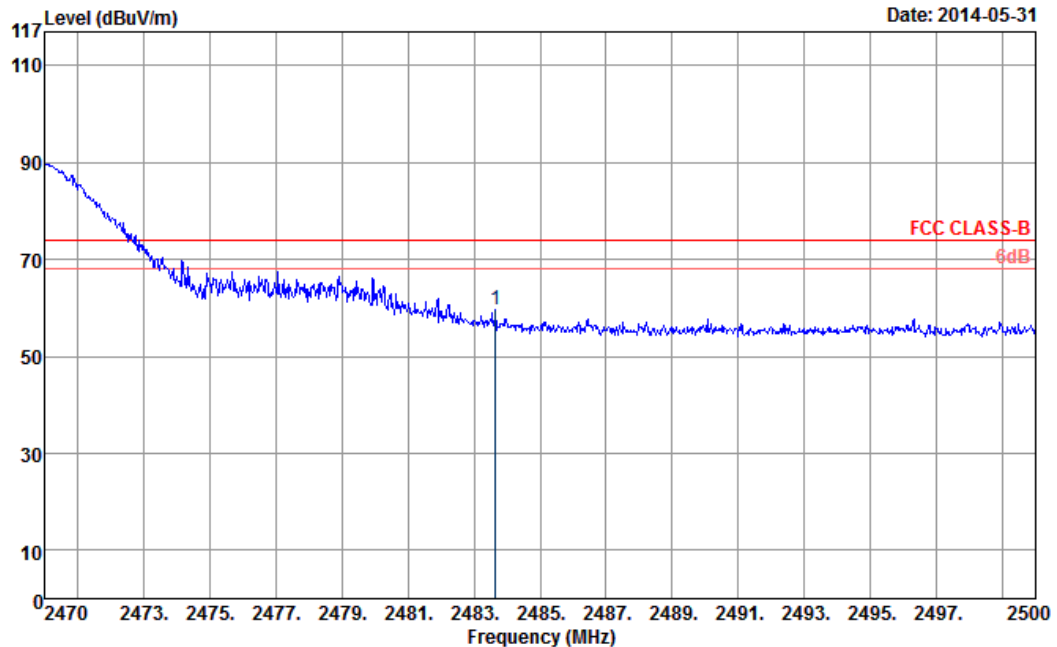

Site : 03CH07-HY
 Condition : FCC CLASS-B 3m HF-ANT_120823 VERTICAL
 : RBW:1000.000KHz VBW:3000.000KHz SWT:Auto

ANTENNA POLARITY : VERTICAL

Frequency (MHz)	Level (dBμV/m)	Over Limit (dB)	Limit Line (dBμV/m)	Read Level (dBμV)	Antenna Factor (dB)	Cable Loss (dB)	Preamp Factor (dB)	Ant Pos (cm)	Table Pos (deg)	Remark
2483.65	59.67	-14.33	74	54.66	32.38	7.06	34.43	131	60	Peak

Note: Worst case measurement on 2483.65 MHz is compliance with 74/54 dBuV/m (peak/average) limit and band edge measurement in the restricted band 2483.5-2500MHz. And, 2470-2483.5MHz is within the operating band and not within the restricted band. The test result is compliance with the FCC limit line.



Test Mode :	802.11n HT20	Temperature :	24~25°C
Test Band :	High	Relative Humidity :	45~46%
Test Channel :	11	Test Engineer :	Eric Shih

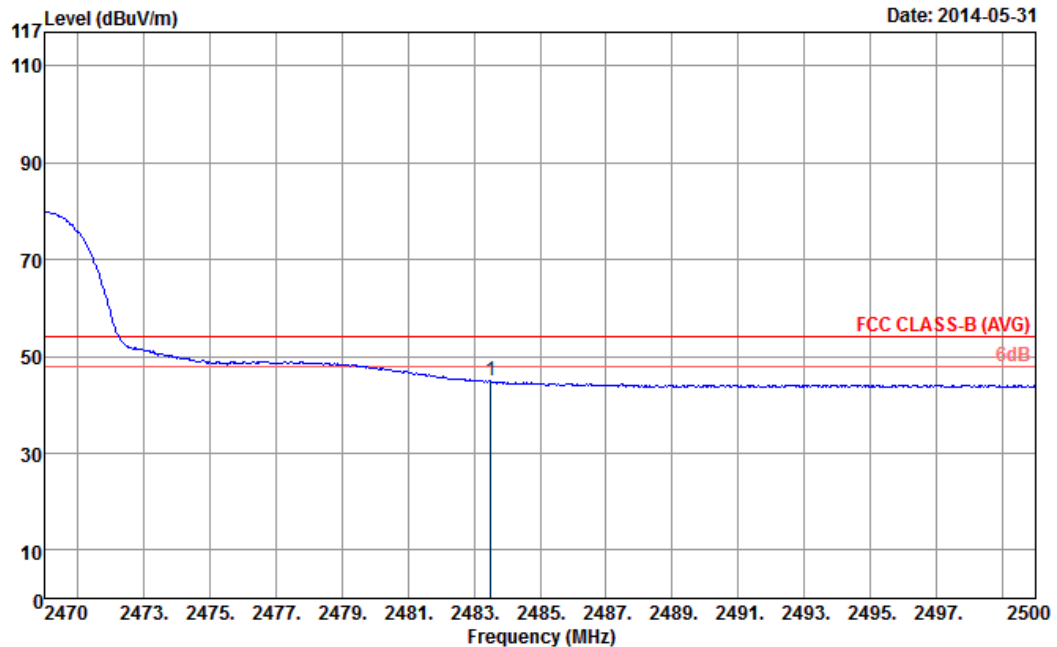

Site : 03CH07-HY
 Condition : FCC CLASS-B (AVG) 3m HF-ANT_120823 VERTICAL
 : RBW:1000.000KHz VBW:1.000KHz SWT:Auto

ANTENNA POLARITY : VERTICAL

Frequency (MHz)	Level (dBμV/m)	Over Limit (dB)	Limit Line (dBμV/m)	Read Level (dBμV)	Antenna Factor (dB)	Cable Loss (dB)	Preamp Factor (dB)	Ant Pos (cm)	Table Pos (deg)	Remark
2483.5	44.87	-9.13	54	39.86	32.38	7.06	34.43	131	60	Average

Note: Worst case measurement on 2483.5 MHz is compliance with 74/54 dBuV/m (peak/average) limit and band edge measurement in the restricted band 2483.5-2500MHz. And, 2470-2483.5MHz is within the operating band and not within the restricted band. The test result is compliance with the FCC limit line.



3.5.7 Result of Radiated Spurious Emission (30MHz ~ 10th Harmonic)

Test Mode :	802.11b	Temperature :	24~25°C
Test Channel :	01	Relative Humidity :	45~46%
Test Engineer :	Eric Shih		

Remark :

- 2412 MHz is fundamental signal which can be ignored.
- 7236 MHz and 9648 MHz are not within a restricted band, and its limit line is 20dB below the highest emission level. For example, 103.26 dBμV/m - 20dB = 83.26 dBμV/m.
- Average measurement was not performed if peak level went lower than the average limit.
- The harmonic (5th, 6th, 7th, ...etc.) and other spurious are not reported, because those levels are lower than average limit line and background noise.

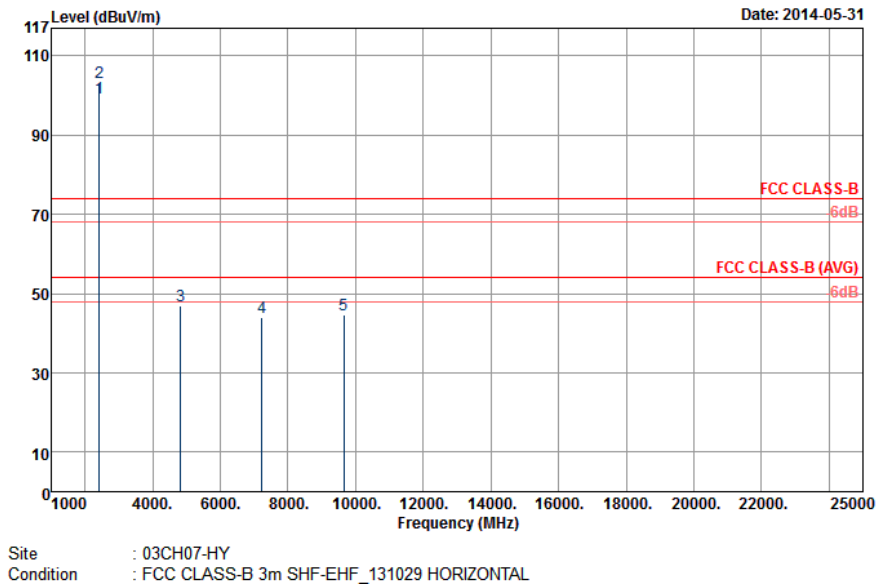

ANTENNA POLARITY : HORIZONTAL

Frequency (MHz)	Level (dBμV/m)	Over Limit (dB)	Limit Line (dBμV/m)	Read Level (dBμV)	Antenna Factor (dB)	Cable Loss (dB)	Preamp Factor (dB)	Ant Pos (cm)	Table Pos (deg)	Remark
2412	99.4	-	-	94.44	32.31	6.95	34.3	101	339	Average
2412	103.26	-	-	98.3	32.31	6.95	34.3	101	339	Peak
4824	46.8	-27.2	74	62.7	34.26	8.77	58.93	100	0	Peak
7236	44.04	-39.22	83.26	55.27	35.6	10.83	57.66	100	0	Peak
9648	44.62	-38.64	83.26	52.97	36.66	13.69	58.7	100	0	Peak

Other harmonics are lower than background noise



Test Mode :	802.11b	Temperature :	24~25°C
Test Channel :	01	Relative Humidity :	45~46%
Test Engineer :	Eric Shih		

Remark :

- 2412 MHz is fundamental signal which can be ignored.
- 7236 MHz and 9648 MHz are not within a restricted band, and its limit line is 20dB below the highest emission level. For example, 101.01 dBμV/m - 20dB = 81.01 dBμV/m.
- Average measurement was not performed if peak level went lower than the average limit.
- The harmonic (5th, 6th, 7th, ...etc.) and other spurious are not reported, because those levels are lower than average limit line and background noise

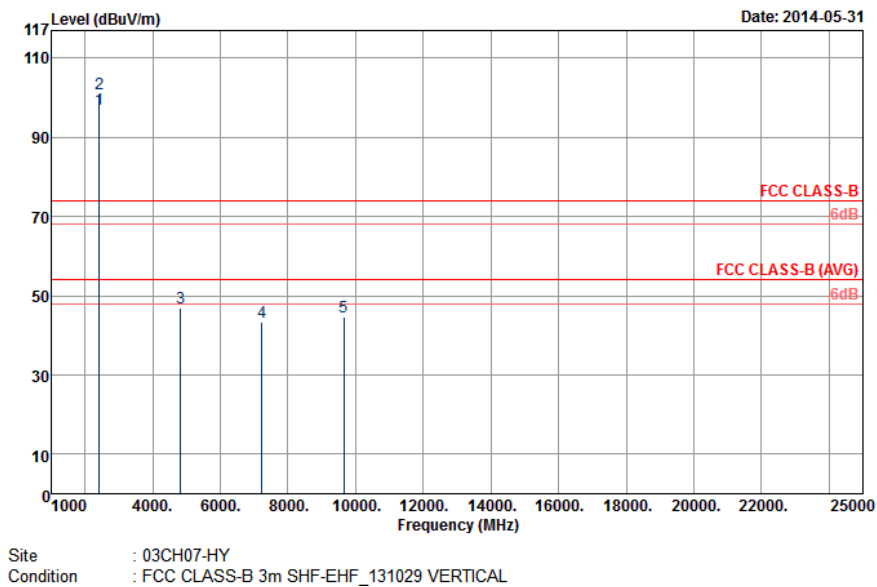

ANTENNA POLARITY : VERTICAL

Frequency (MHz)	Level (dBμV/m)	Over Limit (dB)	Limit Line (dBμV/m)	Read Level (dBμV)	Antenna Factor (dB)	Cable Loss (dB)	Preamp Factor (dB)	Ant Pos (cm)	Table Pos (deg)	Remark
2412	97.14	-	-	92.18	32.31	6.95	34.3	138	70	Average
2412	101.01	-	-	96.05	32.31	6.95	34.3	138	70	Peak
4824	46.94	-27.06	74	62.84	34.26	8.77	58.93	100	0	Peak
7236	43.37	-37.64	81.01	54.6	35.6	10.83	57.66	100	0	Peak
9648	44.7	-36.31	81.01	53.05	36.66	13.69	58.7	100	0	Peak

Other harmonics are lower than background noise



Test Mode :	802.11b	Temperature :	24~25°C
Test Channel :	06	Relative Humidity :	45~46%
Test Engineer :	Eric Shih		

Remark :

- 2438 MHz is fundamental signal which can be ignored.
- 9747 MHz is not within a restricted band, and its limit line is 20dB below the highest emission level. For example, 103.76 dBμV/m - 20dB = 83.76 dBμV/m.
- Average measurement was not performed if peak level went lower than the average limit.
- The harmonic (5th, 6th, 7th, ...etc.) and other spurious are not reported, because those levels are lower than average limit line and background noise

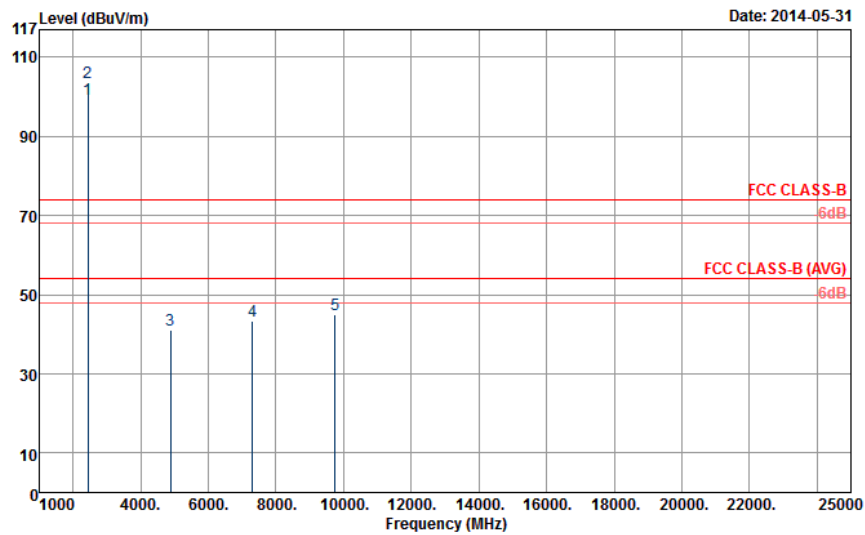

Site : 03CH07-HY
 Condition : FCC CLASS-B 3m SHF-EHF_131029 HORIZONTAL

ANTENNA POLARITY : HORIZONTAL

Frequency (MHz)	Level (dBμV/m)	Over Limit (dB)	Limit Line (dBμV/m)	Read Level (dBμV)	Antenna Factor (dB)	Cable Loss (dB)	Preamp Factor (dB)	Ant Pos (cm)	Table Pos (deg)	Remark
2438	99.56	-	-	94.57	32.35	6.99	34.35	100	95	Average
2438	103.76	-	-	98.77	32.35	6.99	34.35	100	95	Peak
4875	41.1	-32.9	74	56.81	34.3	8.82	58.83	100	0	Peak
7311	43.44	-30.56	74	54.66	35.6	10.91	57.73	100	0	Peak
9747	44.93	-38.83	83.76	53.21	36.76	13.69	58.73	100	0	Peak

Other harmonics are lower than background noise



Test Mode :	802.11b	Temperature :	24~25°C
Test Channel :	06	Relative Humidity :	45~46%
Test Engineer :	Eric Shih		

Remark :

- 2438 MHz is fundamental signal which can be ignored.
- 9747 MHz is not within a restricted band, and its limit line is 20dB below the highest emission level. For example, 100.4 dBμV/m - 20dB = 80.4 dBμV/m.
- Average measurement was not performed if peak level went lower than the average limit.
- The harmonic (5th, 6th, 7th, ...etc.) and other spurious are not reported, because those levels are lower than average limit line and background noise

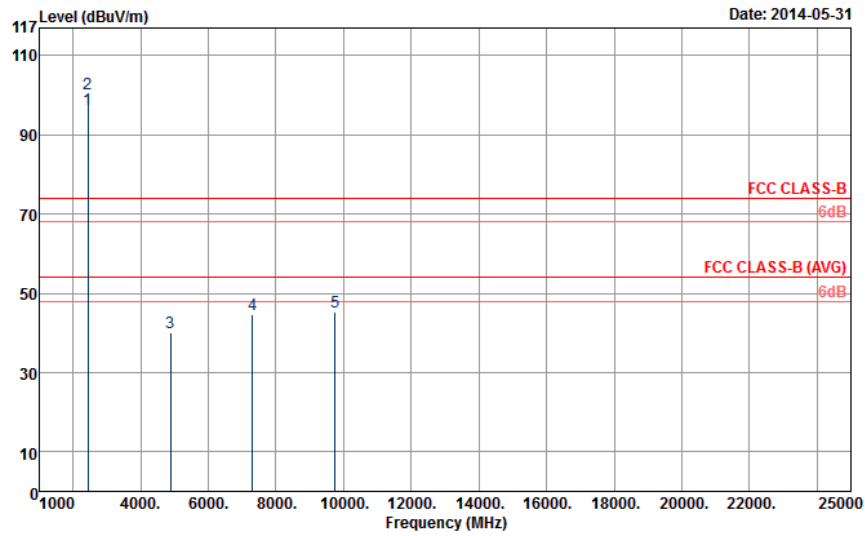

Site : 03CH07-HY
 Condition : FCC CLASS-B 3m SHF-EHF_131029 VERTICAL

ANTENNA POLARITY : VERTICAL

Frequency (MHz)	Level (dBμV/m)	Over Limit (dB)	Limit Line (dBμV/m)	Read Level (dBμV)	Antenna Factor (dB)	Cable Loss (dB)	Preamp Factor (dB)	Ant Pos (cm)	Table Pos (deg)	Remark
2438	96.52	-	-	91.53	32.35	6.99	34.35	124	10	Average
2438	100.4	-	-	95.41	32.35	6.99	34.35	124	10	Peak
4875	40.07	-33.93	74	55.78	34.3	8.82	58.83	100	0	Peak
7311	44.72	-29.28	74	55.94	35.6	10.91	57.73	100	0	Peak
9747	45.43	-34.97	80.4	53.71	36.76	13.69	58.73	100	0	Peak

Other harmonics are lower than background noise



Test Mode :	802.11b	Temperature :	24~25°C
Test Channel :	11	Relative Humidity :	45~46%
Test Engineer :	Eric Shih		
Remark :	<ol style="list-style-type: none"> 2462 MHz is fundamental signal which can be ignored. 9849 MHz is not within a restricted band, and its limit line is 20dB below the highest emission level. For example, 102.46 dBμV/m - 20dB = 82.46 dBμV/m. Average measurement was not performed if peak level went lower than the average limit. The harmonic (5th, 6th, 7th, ...etc.) and other spurious are not reported, because those levels are lower than average limit line and background noise 		

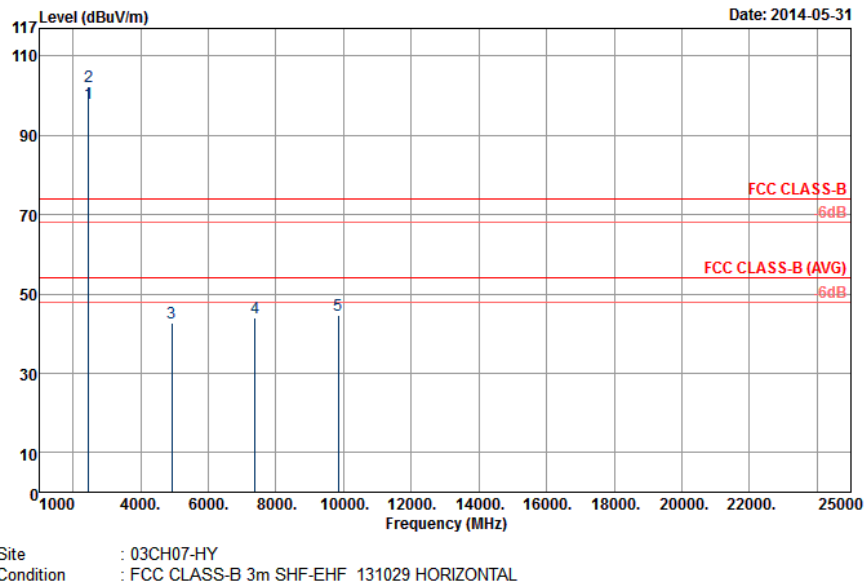

ANTENNA POLARITY : HORIZONTAL

Frequency (MHz)	Level (dBμV/m)	Over Limit (dB)	Limit Line (dBμV/m)	Read Level (dBμV)	Antenna Factor (dB)	Cable Loss (dB)	Preamp Factor (dB)	Ant Pos (cm)	Table Pos (deg)	Remark
2462	98.15	-	-	93.15	32.37	7.02	34.39	100	349	Average
2462	102.46	-	-	97.46	32.37	7.02	34.39	100	349	Peak
4926	42.63	-31.37	74	58.12	34.34	8.9	58.73	100	0	Peak
7386	43.88	-30.12	74	55.09	35.6	10.99	57.8	100	0	Peak
9849	44.62	-37.84	82.46	52.83	36.86	13.69	58.76	100	0	Peak

Other harmonics are lower than background noise



Test Mode :	802.11b	Temperature :	24~25°C
Test Channel :	11	Relative Humidity :	45~46%
Test Engineer :	Eric Shih		

Remark :

- 2460 MHz is fundamental signal which can be ignored.
- 9849 MHz is not within a restricted band, and its limit line is 20dB below the highest emission level. For example, 99.97 dBμV/m - 20dB = 79.97 dBμV/m.
- Average measurement was not performed if peak level went lower than the average limit.
- The harmonic (5th, 6th, 7th, ...etc.) and other spurious are not reported, because those levels are lower than average limit line and background noise

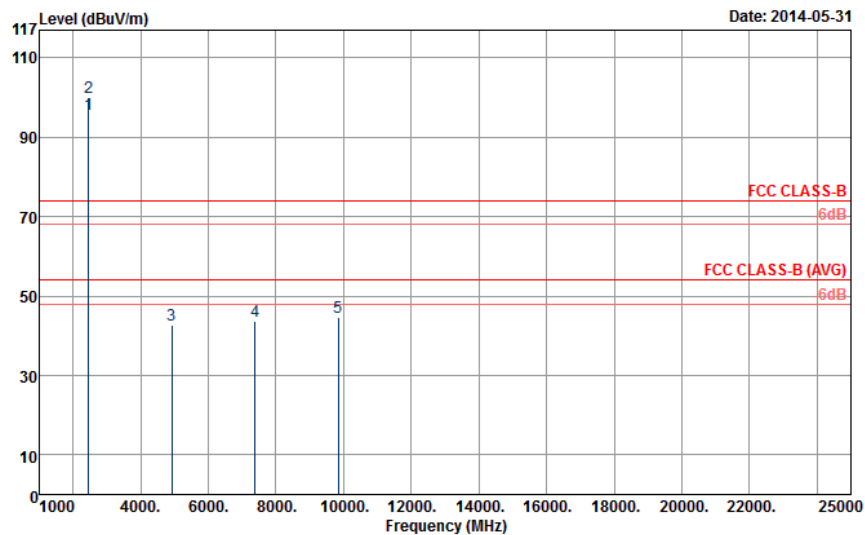

Site : 03CH07-HY
 Condition : FCC CLASS-B 3m SHF-EHF_131029 VERTICAL

ANTENNA POLARITY : VERTICAL

Frequency (MHz)	Level (dBμV/m)	Over Limit (dB)	Limit Line (dBμV/m)	Read Level (dBμV)	Antenna Factor (dB)	Cable Loss (dB)	Preamp Factor (dB)	Ant Pos (cm)	Table Pos (deg)	Remark
2460	95.88	-	-	90.88	32.37	7.02	34.39	131	108	Average
2460	99.97	-	-	94.97	32.37	7.02	34.39	131	108	Peak
4926	42.67	-31.33	74	58.16	34.34	8.9	58.73	100	0	Peak
7386	43.59	-30.41	74	54.8	35.6	10.99	57.8	100	0	Peak
9849	44.6	-35.37	79.97	52.81	36.86	13.69	58.76	100	0	Peak

Other harmonics are lower than background noise



Test Mode :	802.11g	Temperature :	24~25°C
Test Channel :	01	Relative Humidity :	45~46%
Test Engineer :	Eric Shih		

Remark :

- 2410 MHz is fundamental signal which can be ignored.
- 7236 MHz and 9648 MHz are not within a restricted band, and its limit line is 20dB below the highest emission level. For example, 104.84 dBμV/m - 20dB = 84.84 dBμV/m.
- Average measurement was not performed if peak level went lower than the average limit.
- The harmonic (5th, 6th, 7th, ...etc.) and other spurious are not reported, because those levels are lower than average limit line and background noise

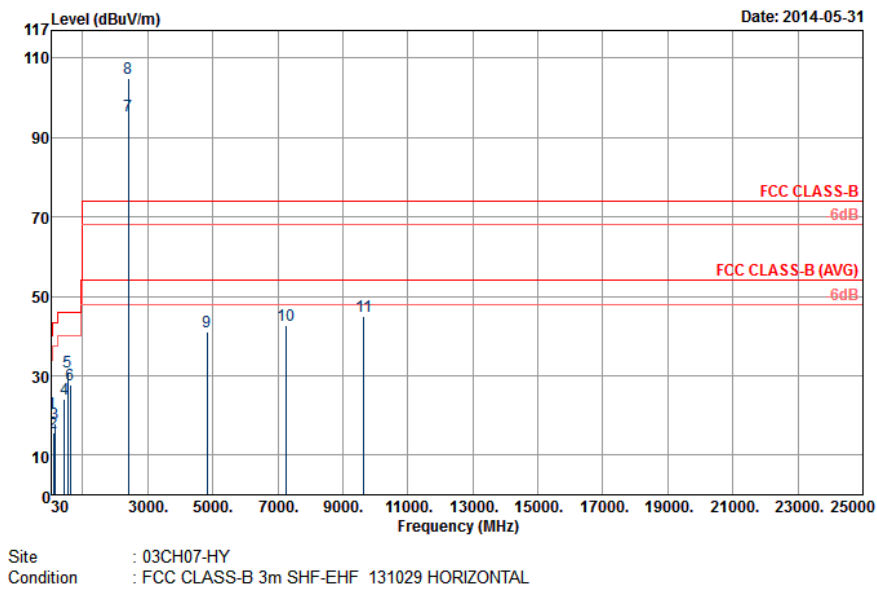

ANTENNA POLARITY : HORIZONTAL

Frequency (MHz)	Level (dBμV/m)	Over Limit (dB)	Limit Line (dBμV/m)	Read Level (dBμV)	Antenna Factor (dB)	Cable Loss (dB)	Preamp Factor (dB)	Ant Pos (cm)	Table Pos (deg)	Remark
33.24	20.39	-19.61	40	33.97	17.24	0.56	31.38	-	-	Peak
105.06	15.64	-27.86	43.5	35.27	10.5	1.02	31.15	-	-	Peak
138.81	17.98	-25.52	43.5	36.38	11.5	1.2	31.1	-	-	Peak
431.6	24.18	-21.82	46	35.75	16.92	2.25	30.74	-	-	Peak
528.2	30.81	-15.19	46	40.73	18.28	2.51	30.71	126	304	Peak
620.6	27.66	-18.34	46	35.25	20.22	2.75	30.56	-	-	Peak

Other harmonics are lower than background noise



ANTENNA POLARITY : HORIZONTAL										
Frequency (MHz)	Level (dB μ V/m)	Over Limit (dB)	Limit Line (dB μ V/m)	Read Level (dB μ V)	Antenna Factor (dB)	Cable Loss (dB)	Preamp Factor (dB)	Ant Pos (cm)	Table Pos (deg)	Remark
2410	95.39	-	-	90.43	32.31	6.95	34.3	100	60	Average
2410	104.84	-	-	99.88	32.31	6.95	34.3	100	60	Peak
4824	41.06	-32.94	74	56.96	34.26	8.77	58.93	100	0	Peak
7236	42.81	-42.03	84.84	54.04	35.6	10.83	57.66	100	0	Peak
9648	44.94	-39.9	84.84	53.29	36.66	13.69	58.7	100	0	Peak

Other harmonics are lower than background noise



Test Mode :	802.11g	Temperature :	24~25°C
Test Channel :	01	Relative Humidity :	45~46%
Test Engineer :	Eric Shih		

Remark :

- 2410 MHz is fundamental signal which can be ignored.
- 7236 MHz and 9648 MHz are not within a restricted band, and its limit line is 20dB below the highest emission level. For example, 98.98 dBμV/m - 20dB = 78.98 dBμV/m.
- Average measurement was not performed if peak level went lower than the average limit.
- The harmonic (5th, 6th, 7th, ...etc.) and other spurious are not reported, because those levels are lower than average limit line and background noise

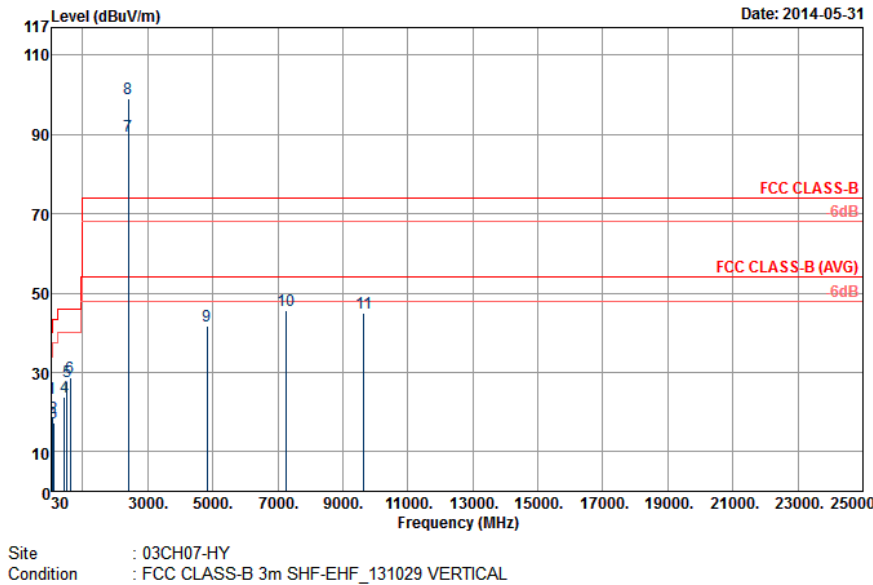

ANTENNA POLARITY : VERTICAL

Frequency (MHz)	Level (dBμV/m)	Over Limit (dB)	Limit Line (dBμV/m)	Read Level (dBμV)	Antenna Factor (dB)	Cable Loss (dB)	Preamp Factor (dB)	Ant Pos (cm)	Table Pos (deg)	Remark
42.69	23.44	-16.56	40	42.1	11.9	0.64	31.2	101	245	Peak
74.82	18.7	-21.3	40	42.25	6.8	0.85	31.2	-	-	Peak
99.39	17.16	-26.34	43.5	36.87	10.4	0.99	31.1	-	-	Peak
428.8	23.89	-22.11	46	35.53	16.88	2.24	30.76	-	-	Peak
521.2	27.79	-18.21	46	37.87	18.12	2.49	30.69	-	-	Peak
620.6	28.75	-17.25	46	36.34	20.22	2.75	30.56	-	-	Peak

Other harmonics are lower than background noise



ANTENNA POLARITY : VERTICAL										
Frequency (MHz)	Level (dBμV/m)	Over Limit (dB)	Limit Line (dBμV/m)	Read Level (dBμV)	Antenna Factor (dB)	Cable Loss (dB)	Preamp Factor (dB)	Ant Pos (cm)	Table Pos (deg)	Remark
2410	89.56	-	-	84.6	32.31	6.95	34.3	102	336	Average
2410	98.98	-	-	94.02	32.31	6.95	34.3	102	336	Peak
4824	41.61	-32.39	74	57.51	34.26	8.77	58.93	100	0	Peak
7236	45.57	-33.41	78.98	56.8	35.6	10.83	57.66	100	0	Peak
9648	45.09	-33.89	78.98	53.44	36.66	13.69	58.7	100	0	Peak

Other harmonics are lower than background noise



Test Mode :	802.11g	Temperature :	24~25°C
Test Channel :	06	Relative Humidity :	45~46%
Test Engineer :	Eric Shih		

Remark :

- 2435 MHz is fundamental signal which can be ignored.
- 9747 MHz is not within a restricted band, and its limit line is 20dB below the highest emission level. For example, 102.83 dBμV/m - 20dB = 82.83 dBμV/m.
- Average measurement was not performed if peak level went lower than the average limit.
- The harmonic (5th, 6th, 7th, ...etc.) and other spurious are not reported, because those levels are lower than average limit line and background noise

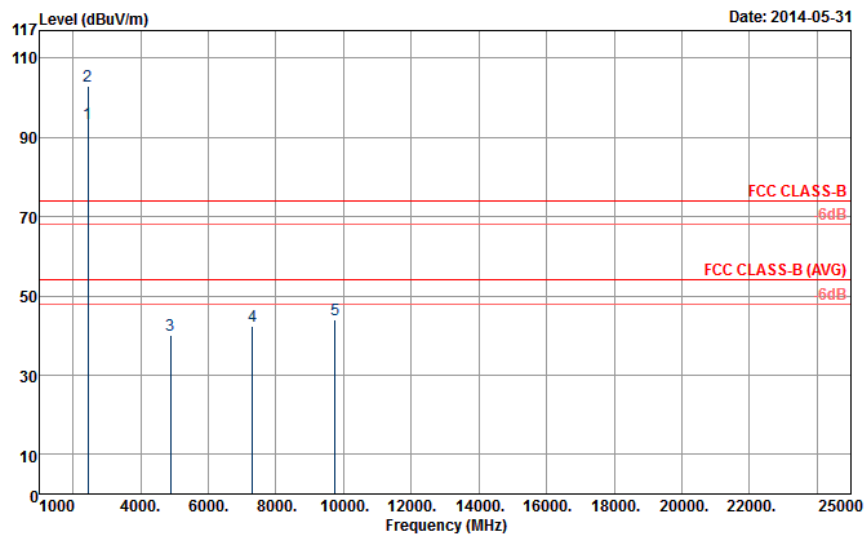

Site : 03CH07-HY
 Condition : FCC CLASS-B 3m SHF-EHF 131029 HORIZONTAL

ANTENNA POLARITY : HORIZONTAL

Frequency (MHz)	Level (dBμV/m)	Over Limit (dB)	Limit Line (dBμV/m)	Read Level (dBμV)	Antenna Factor (dB)	Cable Loss (dB)	Preamp Factor (dB)	Ant Pos (cm)	Table Pos (deg)	Remark
2435	93.56	-	-	88.59	32.33	6.99	34.35	127	288	Average
2435	102.83	-	-	97.86	32.33	6.99	34.35	127	288	Peak
4875	40.08	-33.92	74	55.79	34.3	8.82	58.83	100	0	Peak
7311	42.46	-31.54	74	53.68	35.6	10.91	57.73	100	0	Peak
9747	43.95	-38.88	82.83	52.23	36.76	13.69	58.73	100	0	Peak

Other harmonics are lower than background noise



Test Mode :	802.11g	Temperature :	24~25°C
Test Channel :	06	Relative Humidity :	45~46%
Test Engineer :	Eric Shih		
Remark :	<ol style="list-style-type: none"> 2435 MHz is fundamental signal which can be ignored. 9747 MHz is not within a restricted band, and its limit line is 20dB below the highest emission level. For example, 99.5 dBμV/m - 20dB = 79.5 dBμV/m. Average measurement was not performed if peak level went lower than the average limit. The harmonic (5th, 6th, 7th, ...etc.) and other spurious are not reported, because those levels are lower than average limit line and background noise 		

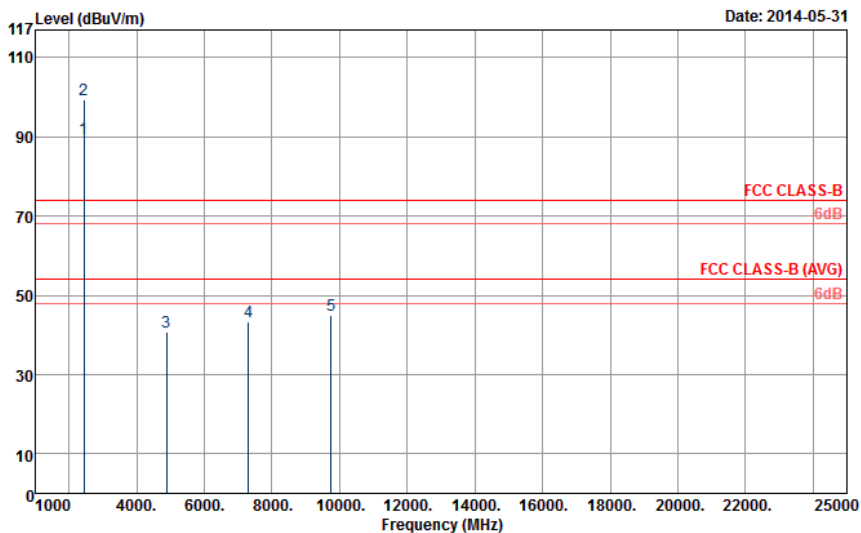

Site : 03CH07-HY
 Condition : FCC CLASS-B 3m SHF-EHF_131029 VERTICAL

ANTENNA POLARITY : VERTICAL

Frequency (MHz)	Level (dBμV/m)	Over Limit (dB)	Limit Line (dBμV/m)	Read Level (dBμV)	Antenna Factor (dB)	Cable Loss (dB)	Preamp Factor (dB)	Ant Pos (cm)	Table Pos (deg)	Remark
2435	89.71	-	-	84.74	32.33	6.99	34.35	130	76	Average
2435	99.5	-	-	94.53	32.33	6.99	34.35	130	76	Peak
4875	40.58	-33.42	74	56.29	34.3	8.82	58.83	100	0	Peak
7311	43.23	-30.77	74	54.45	35.6	10.91	57.73	100	0	Peak
9747	44.84	-34.66	79.5	53.12	36.76	13.69	58.73	100	0	Peak

Other harmonics are lower than background noise



Test Mode :	802.11g	Temperature :	24~25°C
Test Channel :	11	Relative Humidity :	45~46%
Test Engineer :	Eric Shih		
Remark :	<ol style="list-style-type: none"> 2460 MHz is fundamental signal which can be ignored. 9849 MHz is not within a restricted band, and its limit line is 20dB below the highest emission level. For example, 103.3 dBμV/m - 20dB = 83.3 dBμV/m. Average measurement was not performed if peak level went lower than the average limit. The harmonic (5th, 6th, 7th, ...etc.) and other spurious are not reported, because those levels are lower than average limit line and background noise 		

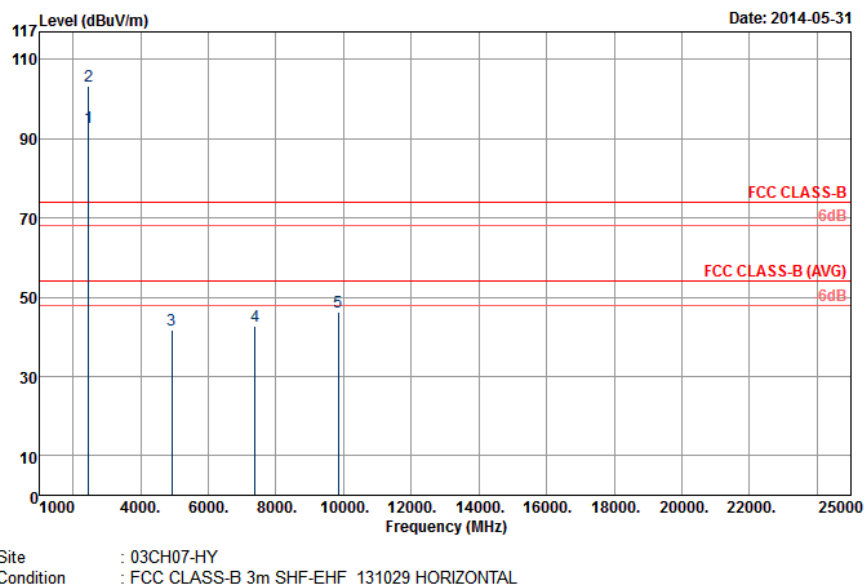

ANTENNA POLARITY : HORIZONTAL

Frequency (MHz)	Level (dBμV/m)	Over Limit (dB)	Limit Line (dBμV/m)	Read Level (dBμV)	Antenna Factor (dB)	Cable Loss (dB)	Preamp Factor (dB)	Ant Pos (cm)	Table Pos (deg)	Remark
2460	92.75	-	-	87.75	32.37	7.02	34.39	100	72	Average
2460	103.3	-	-	98.3	32.37	7.02	34.39	100	72	Peak
4923	41.64	-32.36	74	57.16	34.34	8.87	58.73	100	0	Peak
7386	42.7	-31.3	74	53.91	35.6	10.99	57.8	100	0	Peak
9849	46.23	-37.07	83.3	54.44	36.86	13.69	58.76	100	0	Peak



Test Mode :	802.11g	Temperature :	24~25°C
Test Channel :	11	Relative Humidity :	45~46%
Test Engineer :	Eric Shih		

Remark :

- 2458 MHz is fundamental signal which can be ignored.
- 9849 MHz is not within a restricted band, and its limit line is 20dB below the highest emission level. For example, 100.83 dBμV/m - 20dB = 80.83 dBμV/m.
- Average measurement was not performed if peak level went lower than the average limit.
- The harmonic (5th, 6th, 7th, ...etc.) and other spurious are not reported, because those levels are lower than average limit line and background noise

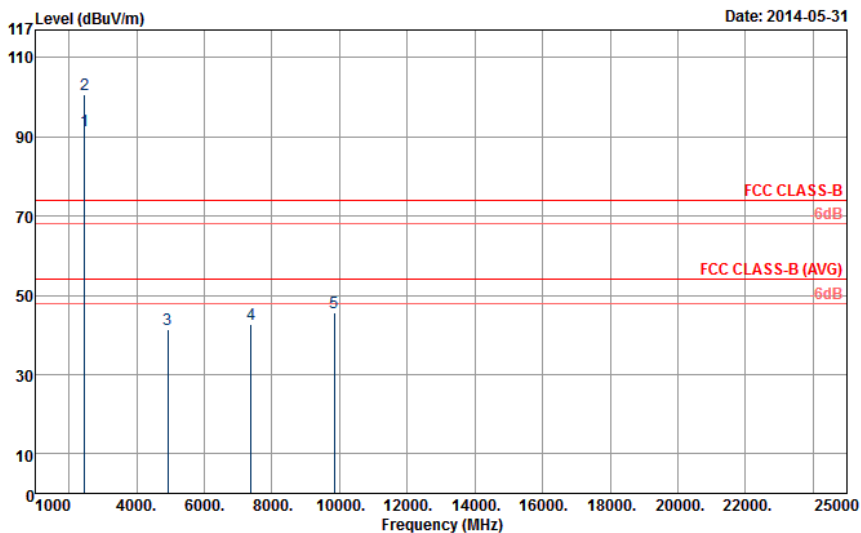

Site : 03CH07-HY
 Condition : FCC CLASS-B 3m SHF-EHF_131029 VERTICAL

ANTENNA POLARITY : VERTICAL

Frequency (MHz)	Level (dBμV/m)	Over Limit (dB)	Limit Line (dBμV/m)	Read Level (dBμV)	Antenna Factor (dB)	Cable Loss (dB)	Preamp Factor (dB)	Ant Pos (cm)	Table Pos (deg)	Remark
2458	91.67	-	-	86.67	32.37	7.02	34.39	131	83	Average
2458	100.83	-	-	95.83	32.37	7.02	34.39	131	83	Peak
4923	41.52	-32.48	74	57.04	34.34	8.87	58.73	100	0	Peak
7386	42.59	-31.41	74	53.8	35.6	10.99	57.8	100	0	Peak
9849	45.73	-35.1	80.83	53.94	36.86	13.69	58.76	100	0	Peak



Test Mode :	2.4GHz 802.11n HT20	Temperature :	24~25°C
Test Channel :	01	Relative Humidity :	45~46%
Test Engineer :	Eric Shih		

Remark :

- 2410 MHz is fundamental signal which can be ignored.
- 7236 MHz and 9648 MHz are not within a restricted band, and its limit line is 20dB below the highest emission level. For example, 100.92 dBμV/m - 20dB = 80.92 dBμV/m.
- Average measurement was not performed if peak level went lower than the average limit.
- The harmonic (5th, 6th, 7th, ...etc.) and other spurious are not reported, because those levels are lower than average limit line and background noise

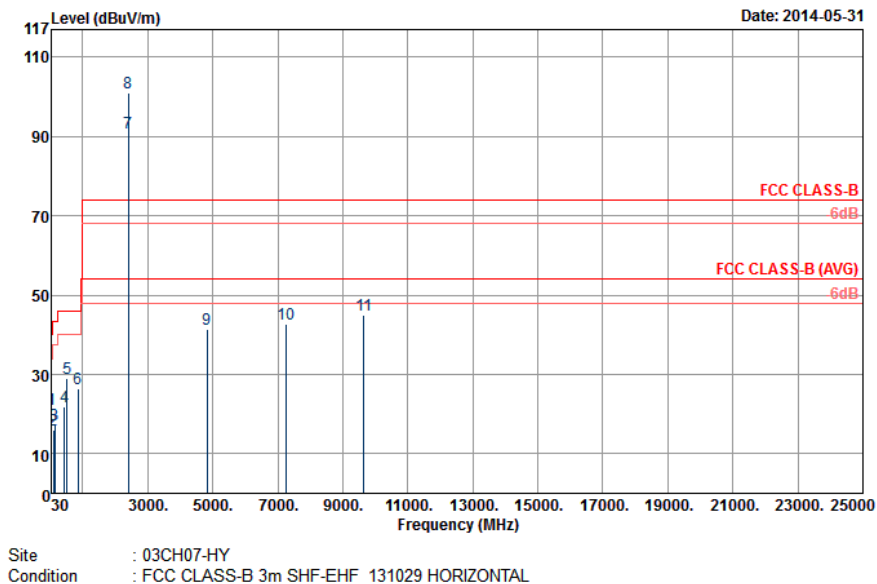

ANTENNA POLARITY : HORIZONTAL

Frequency (MHz)	Level (dBμV/m)	Over Limit (dB)	Limit Line (dBμV/m)	Read Level (dBμV)	Antenna Factor (dB)	Cable Loss (dB)	Preamp Factor (dB)	Ant Pos (cm)	Table Pos (deg)	Remark
30.54	21.11	-18.89	40	33.75	18.28	0.54	31.46	-	-	Peak
105.87	16.02	-27.48	43.5	35.59	10.56	1.03	31.16	-	-	Peak
132.06	17.12	-26.38	43.5	35.26	11.8	1.16	31.1	-	-	Peak
435.1	21.71	-24.29	46	33.22	16.95	2.26	30.72	-	-	Peak
524.7	29.01	-16.99	46	39.01	18.2	2.5	30.7	115	29	Peak
853	26.5	-19.5	46	30.35	23.27	3.27	30.39	-	-	Peak

Other harmonics are lower than background noise



ANTENNA POLARITY : HORIZONTAL										
Frequency (MHz)	Level (dBμV/m)	Over Limit (dB)	Limit Line (dBμV/m)	Read Level (dBμV)	Antenna Factor (dB)	Cable Loss (dB)	Preamp Factor (dB)	Ant Pos (cm)	Table Pos (deg)	Remark
2410	90.78	-	-	85.82	32.31	6.95	34.3	100	280	Average
2410	100.92	-	-	95.96	32.31	6.95	34.3	100	280	Peak
4824	41.3	-32.7	74	57.2	34.26	8.77	58.93	100	0	Peak
7236	42.63	-38.29	80.92	53.86	35.6	10.83	57.66	100	0	Peak
9648	44.93	-35.99	80.92	53.28	36.66	13.69	58.7	100	0	Peak

Other harmonics are lower than background noise



Test Mode :	2.4GHz 802.11n HT20	Temperature :	24~25°C
Test Channel :	01	Relative Humidity :	45~46%
Test Engineer :	Eric Shih		

Remark :

- 2410 MHz is fundamental signal which can be ignored.
- 7236 MHz and 9648 MHz are not within a restricted band, and its limit line is 20dB below the highest emission level. For example, 96.1 dBμV/m - 20dB = 76.1 dBμV/m.
- Average measurement was not performed if peak level went lower than the average limit.
- The harmonic (5th, 6th, 7th, ...etc.) and other spurious are not reported, because those levels are lower than average limit line and background noise

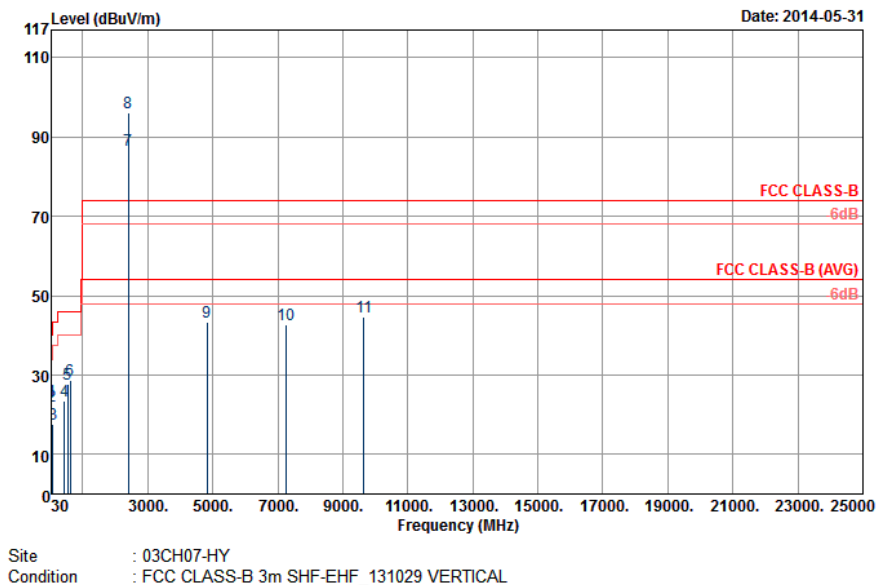

ANTENNA POLARITY : VERTICAL

Frequency (MHz)	Level (dBμV/m)	Over Limit (dB)	Limit Line (dBμV/m)	Read Level (dBμV)	Antenna Factor (dB)	Cable Loss (dB)	Preamp Factor (dB)	Ant Pos (cm)	Table Pos (deg)	Remark
31.62	23.57	-16.43	40	36.68	17.76	0.55	31.42	101	212	Peak
41.34	22.23	-17.77	40	40.2	12.6	0.63	31.2	-	-	Peak
75.63	17.75	-22.25	40	41.26	6.83	0.86	31.2	-	-	Peak
431.6	23.61	-22.39	46	35.18	16.92	2.25	30.74	-	-	Peak
528.2	27.73	-18.27	46	37.65	18.28	2.51	30.71	-	-	Peak
620.6	28.61	-17.39	46	36.2	20.22	2.75	30.56	-	-	Peak

Other harmonics are lower than background noise



ANTENNA POLARITY : VERTICAL										
Frequency (MHz)	Level (dBμV/m)	Over Limit (dB)	Limit Line (dBμV/m)	Read Level (dBμV)	Antenna Factor (dB)	Cable Loss (dB)	Preamp Factor (dB)	Ant Pos (cm)	Table Pos (deg)	Remark
2410	86.73	-	-	81.77	32.31	6.95	34.3	188	242	Average
2410	96.1	-	-	91.14	32.31	6.95	34.3	188	242	Peak
4824	43.33	-30.67	74	59.23	34.26	8.77	58.93	100	0	Peak
7236	42.72	-33.38	76.1	53.95	35.6	10.83	57.66	100	0	Peak
9648	44.63	-31.47	76.1	52.98	36.66	13.69	58.7	100	0	Peak

Other harmonics are lower than background noise



Test Mode :	2.4GHz 802.11n HT20	Temperature :	24~25°C
Test Channel :	06	Relative Humidity :	45~46%
Test Engineer :	Eric Shih		
Remark :	<ol style="list-style-type: none"> 2435 MHz is fundamental signal which can be ignored. 9747 MHz is not within a restricted band, and its limit line is 20dB below the highest emission level. For example, 101.86 dBμV/m - 20dB = 81.86 dBμV/m. Average measurement was not performed if peak level went lower than the average limit. The harmonic (5th, 6th, 7th, ...etc.) and other spurious are not reported, because those levels are lower than average limit line and background noise 		

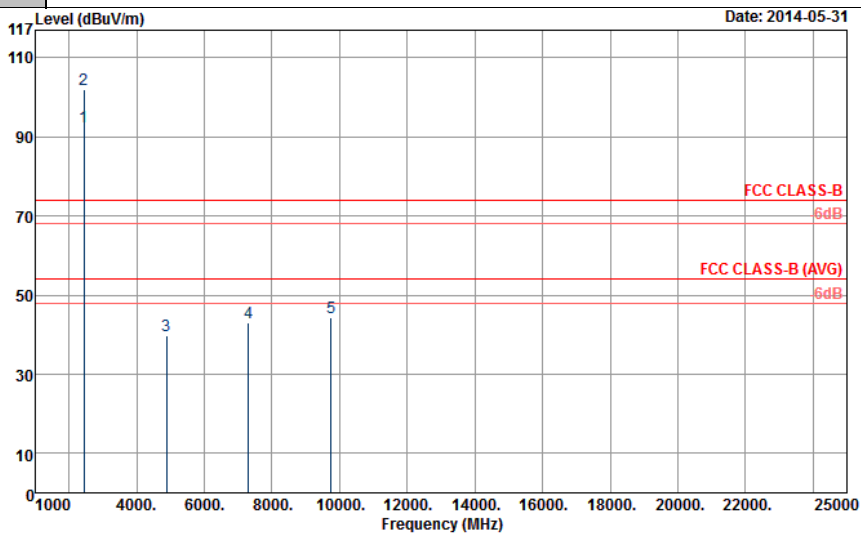

Site : 03CH07-HY
 Condition : FCC CLASS-B 3m SHF-EHF_131029 HORIZONTAL

ANTENNA POLARITY : HORIZONTAL

Frequency (MHz)	Level (dBμV/m)	Over Limit (dB)	Limit Line (dBμV/m)	Read Level (dBμV)	Antenna Factor (dB)	Cable Loss (dB)	Preamp Factor (dB)	Ant Pos (cm)	Table Pos (deg)	Remark
2435	92.5	-	-	87.53	32.33	6.99	34.35	115	334	Average
2435	101.86	-	-	96.89	32.33	6.99	34.35	115	334	Peak
4875	39.63	-34.37	74	55.34	34.3	8.82	58.83	100	0	Peak
7311	43.06	-30.94	74	54.28	35.6	10.91	57.73	100	0	Peak
9747	44.17	-37.69	81.86	52.45	36.76	13.69	58.73	100	0	Peak

Other harmonics are lower than background noise



Test Mode :	2.4GHz 802.11n HT20	Temperature :	24~25°C
Test Channel :	06	Relative Humidity :	45~46%
Test Engineer :	Eric Shih		

Remark :

- 2435 MHz is fundamental signal which can be ignored.
- 9747 MHz is not within a restricted band, and its limit line is 20dB below the highest emission level. For example, 97.19 dBμV/m - 20dB = 77.19 dBμV/m.
- Average measurement was not performed if peak level went lower than the average limit.
- The harmonic (5th, 6th, 7th, ...etc.) and other spurious are not reported, because those levels are lower than average limit line and background noise

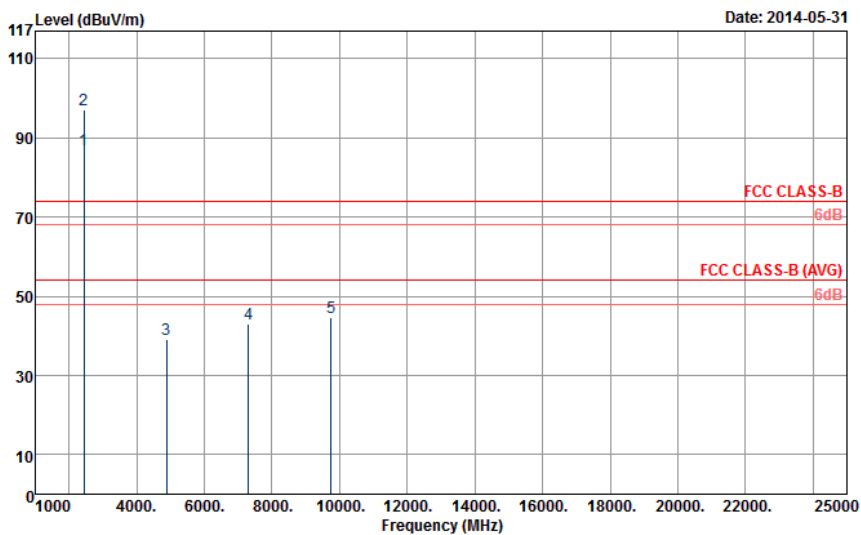

Site : 03CH07-HY
 Condition : FCC CLASS-B 3m SHF-EHF_131029 VERTICAL

ANTENNA POLARITY : VERTICAL

Frequency (MHz)	Level (dBμV/m)	Over Limit (dB)	Limit Line (dBμV/m)	Read Level (dBμV)	Antenna Factor (dB)	Cable Loss (dB)	Preamp Factor (dB)	Ant Pos (cm)	Table Pos (deg)	Remark
2435	87.17	-	-	82.2	32.33	6.99	34.35	144	33	Average
2435	97.19	-	-	92.22	32.33	6.99	34.35	144	33	Peak
4875	39.08	-34.92	74	54.79	34.3	8.82	58.83	100	0	Peak
7311	43.16	-30.84	74	54.38	35.6	10.91	57.73	100	0	Peak
9747	44.75	-32.44	77.19	53.03	36.76	13.69	58.73	100	0	Peak

Other harmonics are lower than background noise



Test Mode :	2.4GHz 802.11n HT20	Temperature :	24~25°C
Test Channel :	11	Relative Humidity :	45~46%
Test Engineer :	Eric Shih		
Remark :	<ol style="list-style-type: none"> 2462 MHz is fundamental signal which can be ignored. 9849 MHz is not within a restricted band, and its limit line is 20dB below the highest emission level. For example, 98.22 dBμV/m - 20dB = 78.22 dBμV/m. Average measurement was not performed if peak level went lower than the average limit. The harmonic (5th, 6th, 7th, ...etc.) and other spurious are not reported, because those levels are lower than average limit line and background noise 		

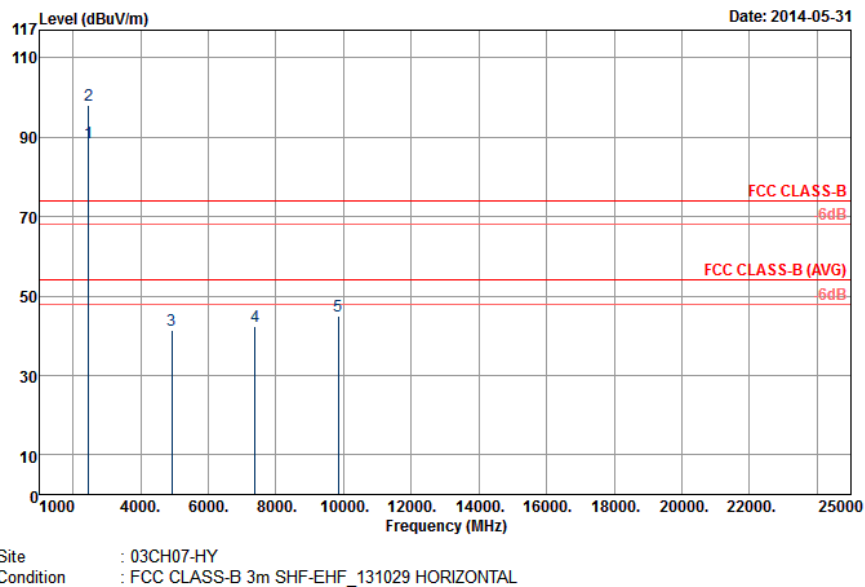

ANTENNA POLARITY : HORIZONTAL

Frequency (MHz)	Level (dBμV/m)	Over Limit (dB)	Limit Line (dBμV/m)	Read Level (dBμV)	Antenna Factor (dB)	Cable Loss (dB)	Preamp Factor (dB)	Ant Pos (cm)	Table Pos (deg)	Remark
2462	88.79	-	-	83.79	32.37	7.02	34.39	126	57	Average
2462	98.22	-	-	93.22	32.37	7.02	34.39	126	57	Peak
4923	41.36	-32.64	74	56.88	34.34	8.87	58.73	100	0	Peak
7386	42.47	-31.53	74	53.68	35.6	10.99	57.8	100	0	Peak
9849	45.06	-33.16	78.22	53.27	36.86	13.69	58.76	100	0	Peak



Test Mode :	2.4GHz 802.11n HT20	Temperature :	24~25°C
Test Channel :	11	Relative Humidity :	45~46%
Test Engineer :	Eric Shih		

Remark :

- 2458 MHz is fundamental signal which can be ignored.
- 9849 MHz is not within a restricted band, and its limit line is 20dB below the highest emission level. For example, 96.79 dBμV/m - 20dB = 76.79 dBμV/m.
- Average measurement was not performed if peak level went lower than the average limit.
- The harmonic (5th, 6th, 7th, ...etc.) and other spurious are not reported, because those levels are lower than average limit line and background noise

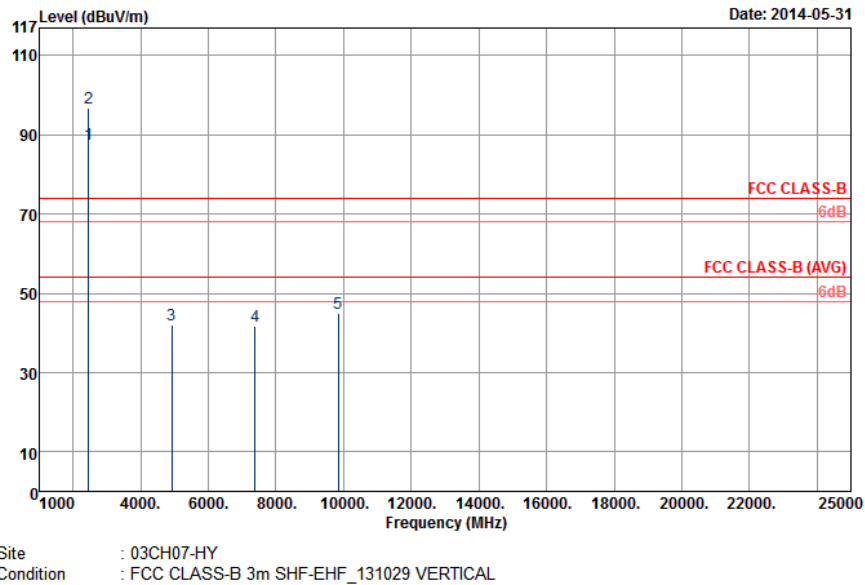

ANTENNA POLARITY : VERTICAL

Frequency (MHz)	Level (dBμV/m)	Over Limit (dB)	Limit Line (dBμV/m)	Read Level (dBμV)	Antenna Factor (dB)	Cable Loss (dB)	Preamp Factor (dB)	Ant Pos (cm)	Table Pos (deg)	Remark
2458	87.51	-	-	82.51	32.37	7.02	34.39	131	60	Average
2458	96.79	-	-	91.79	32.37	7.02	34.39	131	60	Peak
4923	42.1	-31.9	74	57.62	34.34	8.87	58.73	100	0	Peak
7386	41.84	-32.16	74	53.05	35.6	10.99	57.8	100	0	Peak
9849	45.1	-31.69	76.79	53.31	36.86	13.69	58.76	100	0	Peak



3.6 AC Conducted Emission Measurement

3.6.1 Limit of AC Conducted Emission

For equipment that is designed to be connected to the public utility (AC) power line, the radio frequency voltage that is conducted back onto the AC power line on any frequency or frequencies within the band 150 kHz to 30 MHz shall not exceed the limits in the following table.

Frequency of Emission (MHz)	Conducted Limit (dBµV)	
	Quasi-Peak	Average
0.15-0.5	66 to 56*	56 to 46*
0.5-5	56	46
5-30	60	50

*Decreases with the logarithm of the frequency.

3.6.2 Measuring Instruments

The measuring equipment is listed in the section 4 of this test report.

3.6.3 Test Procedures

1. The EUT was placed 0.4 meter from the conducting wall of the shielding room, and it was kept at least 80 centimeters from any other grounded conducting surface.
2. Connect EUT to the power mains through a line impedance stabilization network (LISN).
3. All the support units are connecting to the other LISN.
4. The LISN provides 50 ohm coupling impedance for the measuring instrument.
5. The FCC states that a 50 ohm, 50 microhenry LISN should be used.
6. Both sides of AC line were checked for maximum conducted interference.
7. The frequency range from 150 kHz to 30 MHz was searched.
8. Set the test-receiver system to Peak Detect Function and specified bandwidth with Maximum Hold Mode.

3.6.4 Test Setup

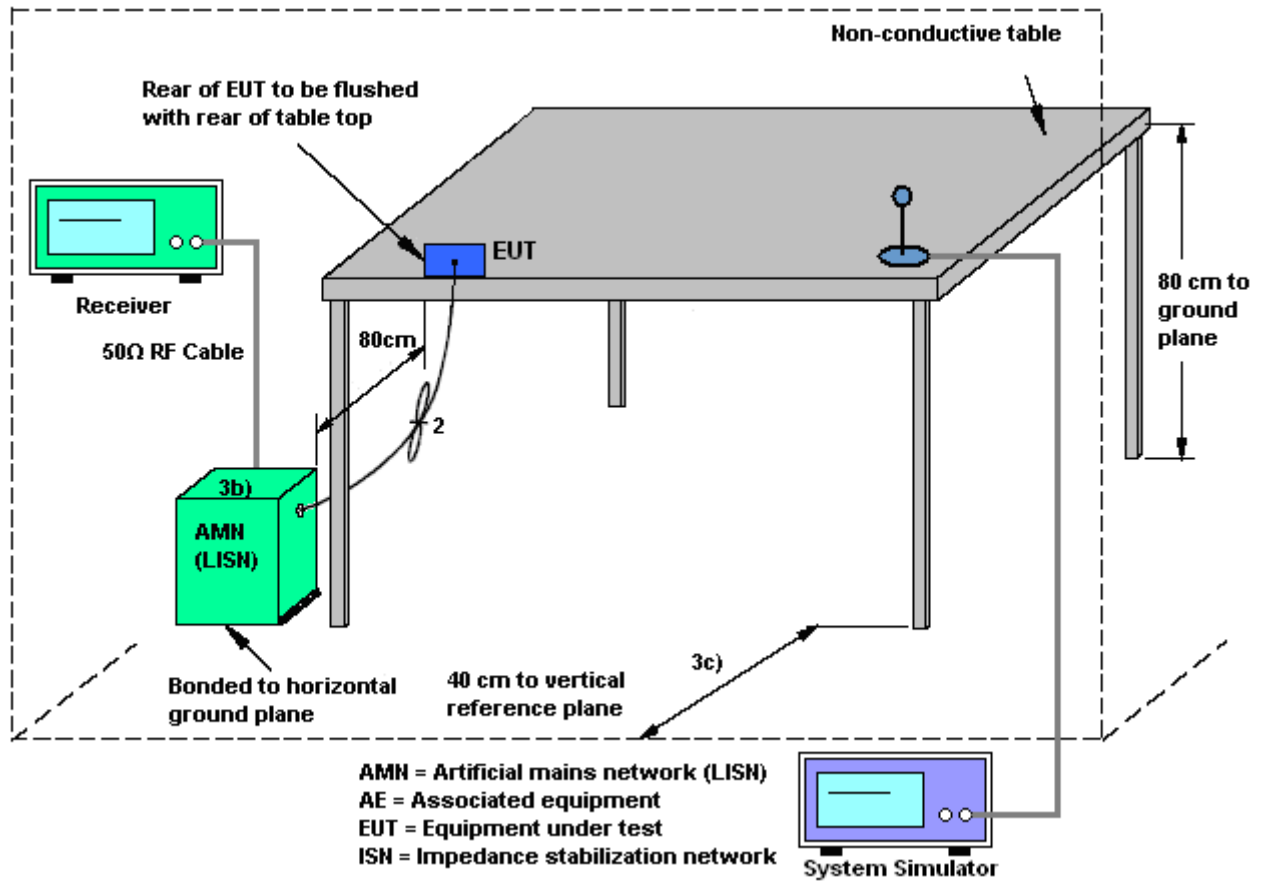

3.6.5 Test Result of AC Conducted Emission

Test Mode :	Mode 1	Temperature :	20~22°C
Test Engineer :	Kai-Chun Chu	Relative Humidity :	46~48%
Test Voltage :	120Vac / 60Hz	Phase :	Line
Function Type :	GSM1900 Idle + Bluetooth Link + WLAN Link + Earphone + Battery + USB Cable (Charging from Adapter) + MP3		

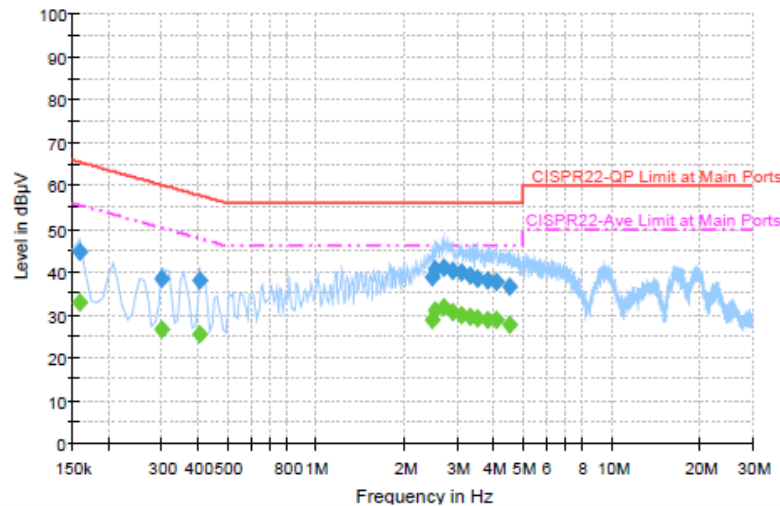

Final Result : Quasi-Peak

Frequency (MHz)	Quasi-Peak (dBµV)	Filter	Line	Corr. (dB)	Margin (dB)	Limit (dBµV)
0.158000	44.8	Off	L1	19.3	20.8	65.6
0.302000	38.3	Off	L1	19.4	21.9	60.2
0.406000	37.9	Off	L1	19.3	19.8	57.7
2.478000	38.7	Off	L1	19.5	17.3	56.0
2.542000	40.7	Off	L1	19.6	15.3	56.0
2.702000	40.9	Off	L1	19.5	15.1	56.0
2.902000	40.1	Off	L1	19.6	15.9	56.0
3.102000	39.8	Off	L1	19.6	16.2	56.0
3.310000	39.1	Off	L1	19.6	16.9	56.0
3.518000	38.5	Off	L1	19.6	17.5	56.0
3.814000	38.1	Off	L1	19.6	17.9	56.0
4.062000	37.6	Off	L1	19.6	18.4	56.0
4.502000	36.7	Off	L1	19.6	19.3	56.0



Test Mode :	Mode 1	Temperature :	20~22°C
Test Engineer :	Kai-Chun Chu	Relative Humidity :	46~48%
Test Voltage :	120Vac / 60Hz	Phase :	Line
Function Type :	GSM1900 Idle + Bluetooth Link + WLAN Link + Earphone + Battery + USB Cable (Charging from Adapter) + MP3		

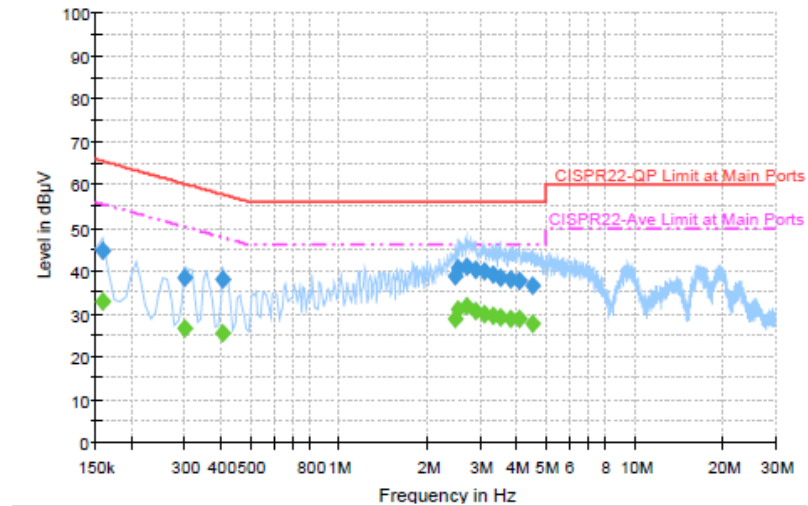

Final Result : Average

Frequency (MHz)	Average (dBµV)	Filter	Line	Corr. (dB)	Margin (dB)	Limit (dBµV)
0.158000	32.8	Off	L1	19.3	22.8	55.6
0.302000	26.6	Off	L1	19.4	23.6	50.2
0.406000	25.5	Off	L1	19.3	22.2	47.7
2.478000	29.0	Off	L1	19.5	17.0	46.0
2.542000	30.9	Off	L1	19.6	15.1	46.0
2.702000	31.6	Off	L1	19.5	14.4	46.0
2.902000	30.7	Off	L1	19.6	15.3	46.0
3.102000	29.9	Off	L1	19.6	16.1	46.0
3.310000	29.4	Off	L1	19.6	16.6	46.0
3.518000	29.3	Off	L1	19.6	16.7	46.0
3.814000	28.9	Off	L1	19.6	17.1	46.0
4.062000	28.7	Off	L1	19.6	17.3	46.0
4.502000	27.5	Off	L1	19.6	18.5	46.0



Test Mode :	Mode 1	Temperature :	20~22°C
Test Engineer :	Kai-Chun Chu	Relative Humidity :	46~48%
Test Voltage :	120Vac / 60Hz	Phase :	Neutral
Function Type :	GSM1900 Idle + Bluetooth Link + WLAN Link + Earphone + Battery + USB Cable (Charging from Adapter) + MP3		

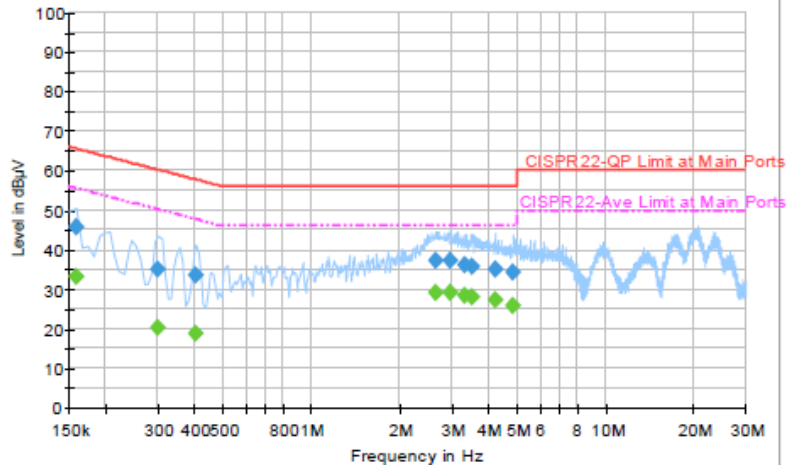

Final Result : Quasi-Peak

Frequency (MHz)	Quasi-Peak (dBµV)	Filter	Line	Corr. (dB)	Margin (dB)	Limit (dBµV)
0.158000	45.7	Off	N	19.3	19.9	65.6
0.302000	34.9	Off	N	19.4	25.3	60.2
0.406000	33.6	Off	N	19.4	24.1	57.7
2.646000	37.3	Off	N	19.5	18.7	56.0
2.958000	37.2	Off	N	19.6	18.8	56.0
3.326000	36.2	Off	N	19.6	19.8	56.0
3.534000	35.9	Off	N	19.6	20.1	56.0
4.214000	35.1	Off	N	19.6	20.9	56.0
4.870000	34.4	Off	N	19.6	21.6	56.0

Final Result : Average

Frequency (MHz)	Average (dBµV)	Filter	Line	Corr. (dB)	Margin (dB)	Limit (dBµV)
0.158000	33.3	Off	N	19.3	22.3	55.6
0.302000	20.4	Off	N	19.4	29.8	50.2
0.406000	18.9	Off	N	19.4	28.8	47.7
2.646000	29.3	Off	N	19.5	16.7	46.0
2.958000	29.0	Off	N	19.6	17.0	46.0
3.326000	28.3	Off	N	19.6	17.7	46.0
3.534000	28.1	Off	N	19.6	17.9	46.0
4.214000	27.4	Off	N	19.6	18.6	46.0
4.870000	26.0	Off	N	19.6	20.0	46.0



3.7 Antenna Requirements

3.7.1 Standard Applicable

If directional gain of transmitting antennas is greater than 6dBi, the power shall be reduced by the same level in dB comparing to gain minus 6dBi. For the fixed point-to-point operation, the power shall be reduced by one dB for every 3 dB that the directional gain of the antenna exceeds 6 dBi. The use of a permanently attached antenna or of an antenna that uses a unique coupling to the intentional radiator shall be considered sufficient to comply with the FCC rule.

3.7.2 Antenna Anti-Replacement Construction

An embedded-in antenna design is used.

3.7.3 Antenna Gain

The antenna peak gain of EUT is less than 6 dBi. Therefore, it is not necessary to reduce maximum peak output power limit.



4 List of Measuring Equipment

Instrument	Manufacturer	Model No.	Serial No.	Characteristics	Calibration Date	Test Date	Due Date	Remark
Spectrum Analyzer	Rohde & Schwarz	FSP40	100055	9kHz~40GHz	Jun. 07, 2013	May 06, 2014~ May 08, 2014	Jun. 06, 2014	Conducted (TH02-HY)
Power Meter	Anritsu	ML2495A	1036004	300MHz~40GHz	Aug. 17, 2013	May 06, 2014~ May 08, 2014	Aug. 16, 2014	Conducted (TH02-HY)
Power Sensor	Anritsu	MA2411B	1027253	300MHz~40GHz	Aug. 17, 2013	May 06, 2014~ May 08, 2014	Aug. 16, 2014	Conducted (TH02-HY)
Hygrometer	Testo	608-H1	34897199	N/A	May 06, 2014	May 06, 2014~ May 08, 2014	May 05, 2015	Conducted (TH02-HY)
RF cable	WOKEN	S05	S05-130708-03 8	N/A	Jan. 22, 2014	May 06, 2014~ May 08, 2014	Jan. 21, 2015	Conducted (TH02-HY)
EMI Test Receiver	Rohde & Schwarz	ESCI 7	100724	9 kHz~7 GHz	Sep. 06, 2013	May 31, 2014	Sep. 05, 2014	Radiation (03CH07-HY)
Spectrum Analyzer	Rohde & Schwarz	FSV30	101749	10Hz ~ 30GHz	Feb. 10, 2014	May 31, 2014	Feb. 09, 2015	Radiation (03CH07-HY)
Bilog Antenna	Schaffner	CBL6111C	2726	30 MHz ~ 1 GHz	Oct. 10, 2013	May 31, 2014	Oct. 09, 2014	Radiation (03CH07-HY)
Double Ridge Horn Antenna	ESCO	3117	75962	1 GHz~18 GHz	Aug. 22, 2013	May 31, 2014	Aug. 21, 2014	Radiation (03CH07-HY)
Loop Antenna	Rohde & Schwarz	HFH2-Z2	860004/0001	9 kHz~30 MHz	Jul. 03, 2012	May 31, 2014	Jul. 03, 2014	Radiation (03CH07-HY)
SHF-EHF Horn Antenna	SCHWARZBECK	BBHA 9170	BBHA9170251	15GHz- 40GHz	Oct. 03, 2013	May 31, 2014	Oct. 02, 2014	Radiation (03CH07-HY)
Preamplifier	COM-POWER	PA-103A	161241	10 MHz ~ 1000MHz	Mar. 17, 2014	May 31, 2014	Mar. 16, 2015	Radiation (03CH07-HY)
Preamplifier	Agilent	8449B	3008A02362	1 GHz~26.5 GHz	Nov. 29, 2013	May 31, 2014	Nov. 28, 2014	Radiation (03CH07-HY)
Preamplifier	MITEQ	AMF-7D-00 101800-30- 10P	1590074	DC~18 G	Jul. 09, 2013	May 31, 2014	Jul. 08, 2014	Radiation (03CH07-HY)
Turn Table	ChainTek	ChainTek 3000	N/A	0 ~ 360 degree	N/A	May 31, 2014	N/A	Radiation (03CH07-HY)
Antenna Mast	ChainTek	ChainTek 3000	N/A	N/A	N/A	May 31, 2014	N/A	Radiation (03CH07-HY)
LF RF Cable	Warison+HUBER SUHNER	WCBA-WC 04NM.NM2	N/A	30MHz~1GHz	Nov. 28, 2013	May 31, 2014	Nov. 27, 2014	Radiation (03CH07-HY)
HF RF Cable	HUBER SUHNER	SUCOFLEX 104	38411/6	1GHz~26.5GHz	Nov. 28, 2013	May 31, 2014	Nov. 27, 2014	Radiation (03CH07-HY)
High Pass Filter	Microwave Circuits	H3G018G1	SN477220	3G HPF	Nov. 28, 2013	May 31, 2014	Nov. 27, 2014	Radiation (03CH07-HY)
Low Pass Filter	Wainwright Instruments GmbH	WLKS1200- 8SS	SN3	1.5G LPF	Nov. 28, 2013	May 31, 2014	Nov. 27, 2014	Radiation (03CH07-HY)
Hygrometer	Testo	608-H1	34897197	N/A	May 06, 2014	May 31, 2014	May 05, 2015	Radiation (03CH07-HY)
Test Software	Audix	E3 V6.0	N/A	N/A	N/A	May 31, 2014	N/A	Radiation (03CH07-HY)



Instrument	Manufacturer	Model No.	Serial No.	Characteristics	Calibration Date	Test Date	Due Date	Remark
EMI Test Receiver	Rohde & Schwarz	ESCS 30	100356	9kHz ~ 2.75GHz	Nov. 15, 2013	May 20, 2014	Nov. 14, 2014	Conduction (CO05-HY)
LISN	Rohde & Schwarz	ENV216	100081	9kHz ~ 30MHz	Dec. 12, 2013	May 20, 2014	Dec. 11, 2014	Conduction (CO05-HY)
LISN (for auxiliary equipment)	Rohde & Schwarz	ENV216	100080	9kHz ~ 30MHz	Dec. 04, 2013	May 20, 2014	Dec. 03, 2014	Conduction (CO05-HY)
AC Power Source	APC	APC-1000W	N/A	N/A	N/A	May 20, 2014	N/A	Conduction (CO05-HY)
Test Software	N/A	EMC32	8.40.0	N/A	N/A	May 20, 2014	N/A	Conduction (CO05-HY)
Hygrometer	Testo	608-H1	34913912	N/A	Apr. 23, 2014	May 20, 2014	Apr. 22, 2015	Conduction (CO05-HY)
LF Cable	Shuner	RG-402	N/A	N/A	Oct. 17, 2013	May 20, 2014	Oct. 16, 2014	Conduction (CO05-HY)

Note: Test equipment calibration is traceable to the procedure of ISO17025.



5 Uncertainty of Evaluation

Uncertainty of Conducted Emission Measurement (150kHz ~ 30MHz)

Measuring Uncertainty for a Level of Confidence of 95% ($U = 2Uc(y)$)	2.26
---	------

Uncertainty of Radiated Emission Measurement (30 MHz ~ 1000 MHz)

Measuring Uncertainty for a Level of Confidence of 95% ($U = 2Uc(y)$)	4.50
---	------