

TEST REPORT

Test report no.: 1-5831/13-05-18-A



Testing laboratory

CETECOM ICT Services GmbH
Untertuerkheimer Strasse 6 – 10
66117 Saarbruecken / Germany
Phone: + 49 681 5 98 - 0
Fax: + 49 681 5 98 - 9075
Internet: <http://www.cetecom.com>
e-mail: ict@cetecom.com

Accredited Testing Laboratory:

The testing laboratory (area of testing) is accredited according to DIN EN ISO/IEC 17025 (2005) by the Deutsche Akkreditierungsstelle GmbH (DAkkS). The accreditation is valid for the scope of testing procedures as stated in the accreditation certificate with the registration number: D-PL-12076-01-01
Area of Testing: Radio/Satellite Communications

Applicant

Sony Mobile Communications AB
Nya Vattentornet
22188 Lund / SWEDEN
Phone: +46 46 19 30 00
Fax: +46 1 08 00 24 41
Contact: Fredrik Björk
e-mail: Fredrik.Bjork@sonymobile.com
Phone: +46 10 80 14 67 5
Mobile: +46 70 32 40 14 0

Manufacturer

Sony Mobile Communications AB
Nya Vattentornet
22188 Lund / SWEDEN

Test standard/s

47 CFR Part 15 Title 47 of the Code of Federal Regulations; Chapter I
Part 15 - Radio frequency devices

For further applied test standards please refer to section 3 of this test report.

Test Item

Kind of test item: Mobile Phone GPRS/EGPRS 850/900/1800/1900; UMTS HSPA FDDI/V/VI/XIX; LTE FDD1/19/21; WLAN a/b/g/n; BT 3.1; RFID; FM Rx; A-GPS
Model name: PM-0320-BV
FCC ID: PY7PM-0320
IC: -/-
Frequency: ISM band 2400 MHz to 2483.5 MHz
(lowest channel 00 – 2402 MHz; highest channel 39 – 2480 MHz)
Technology tested: Bluetooth® LE
Antenna: Integrated PCB antenna
Power Supply: 3.7V DC by Li - Ion battery
Temperature Range: -20°C to +55°C

This test report is electronically signed and valid without handwriting signature. For verification of the electronic signatures, the public keys can be requested at the testing laboratory.

Test report authorised:

Stefan Bös
Senior Testing Manager

Test performed:

p.o.

Marco Bertolino
Testing Manager

1 Table of contents	
1	Table of contents2
2	General information3
2.1	Notes and disclaimer3
2.2	Application details.....3
3	Test standard/s3
4	Measurement guidance.....3
5	Test environment.....4
6	Test item4
6.1	Additional information4
7	Test laboratories sub-contracted4
8	Summary of measurement results5
9	RF measurements6
9.1	Description of test setup6
9.1.1	Radiated measurements.....6
9.1.2	Conducted measurements.....7
9.2	Additional comments7
10	Measurement results8
10.1	Antenna gain8
10.2	Power spectral density.....9
10.3	Carrier frequency separation.....12
10.4	Number of hopping channels14
10.5	Time of occupancy (dwell time)16
10.6	DTS bandwidth – 6 dB bandwidth17
10.7	Spectrum bandwidth of a FHSS system – 20 dB bandwidth.....18
10.8	Maximum output power.....21
10.9	Band edge compliance conducted24
10.10	Band edge compliance radiated.....27
10.11	TX spurious emissions conducted29
10.12	TX spurious emissions radiated32
10.13	RX spurious emissions radiated43
10.14	Spurious emissions radiated < 30 MHz47
10.15	Spurious emissions conducted < 30 MHz.....49
11	Test equipment and ancillaries used for tests.....52
12	Observations53
Annex A	Document history54
Annex B	Further information.....54
Annex C	Accreditation Certificate55

2 General information

2.1 Notes and disclaimer

The test results of this test report relate exclusively to the test item specified in this test report. CETECOM ICT Services GmbH does not assume responsibility for any conclusions and generalizations drawn from the test results with regard to other specimens or samples of the type of the equipment represented by the test item.

The test report may only be reproduced or published in full. Reproduction or publication of extracts from the report requires the prior written approval of CETECOM ICT Services GmbH.

The testing service provided by CETECOM ICT Services GmbH has been rendered under the current "General Terms and Conditions for CETECOM ICT Services GmbH".

CETECOM ICT Services GmbH will not be liable for any loss or damage resulting from false, inaccurate, inappropriate or incomplete product information provided by the customer.

Under no circumstances does the CETECOM ICT Services GmbH test report include any endorsement or warranty regarding the functionality, quality or performance of any other product or service provided.

Under no circumstances does the CETECOM ICT Services GmbH test report include or imply any product or service warranties from CETECOM ICT Services GmbH, including, without limitation, any implied warranties of merchantability, fitness for purpose, or non-infringement, all of which are expressly disclaimed by CETECOM ICT Services GmbH.

All rights and remedies regarding vendor's products and services for which CETECOM ICT Services GmbH has prepared this test report shall be provided by the party offering such products or services and not by CETECOM ICT Services GmbH.

In no case this test report can be considered as a Letter of Approval.

2.2 Application details

Date of receipt of order:	2013-01-15
Date of receipt of test item:	2013-02-12
Start of test:	2013-02-12
End of test:	2013-02-30
Person(s) present during the test:	-/-

3 Test standard/s

Test standard	Date	Test standard description
47 CFR Part 15	2010-10	Title 47 of the Code of Federal Regulations; Chapter I Part 15 - Radio frequency devices

4 Measurement guidance

DTS : KDB 558074	2013-04	Guidance for Performing Compliance Measurements on Digital Transmission Systems (DTS) Operating Under §15.247
------------------	---------	---

5 Test environment

Temperature:	T_{nom}	+22 °C during room temperature tests
	T_{max}	+55 °C during high temperature tests
	T_{min}	-20 °C during low temperature tests
Relative humidity content:		42 %
Barometric pressure:		not relevant for this kind of testing
Power supply:	V_{nom}	3.7 V DC by Li - Ion battery
	V_{max}	4.1 V
	V_{min}	3.3 V

6 Test item

Kind of test item	:	Mobile Phone GPRS/EGPRS 850/900/1800/1900; UMTS HSPA FDDI/V/VI/XIX; LTE FDD1/19/21; WLAN a/b/g/n; BT 3.1; RFID; FM Rx; A-GPS
Type identification	:	PM-0320-BV
S/N serial number	:	Radiated units: CB5A1NUBNB; CB5A1NUBN5 Conducted units: CB5A1NUBPM; CB5A1NUBP4
HW hardware status	:	AP1
SW software status	:	atp_dogo_dcm_0_0_36_0_d
Frequency band [MHz]	:	ISM band 2400 MHz to 2483.5 MHz (lowest channel 00 – 2402 MHz; highest channel 39 – 2480 MHz)
Type of radio transmission	:	FHSS, DSSS
Use of frequency spectrum	:	
Type of modulation	:	GFSK
Number of channels	:	40
Antenna	:	Integrated PCB antenna
Power supply	:	3.7V DC by Li - Ion battery
Temperature range	:	-20°C to +55°C

6.1 Additional information

Test setup - and EUT - photos are included in the following test reports:

External EUT photos:	1-5831/13-05-01_AnnexA
Internal EUT photos:	1-5831/13-05-01_AnnexB
Test setup:	1-5831/13-05-01_AnnexD

7 Test laboratories sub-contracted

None

8 Summary of measurement results



No deviations from the technical specifications were ascertained



There were deviations from the technical specifications ascertained

TC Identifier	Description	Verdict	Date	Remark
RF-Testing	CFR Part 15 RSS 210, Issue 8, Annex 8	Passed	2013-04-30	-/-

Test specification clause	Test case	Temperature conditions	Power source voltages	Mode	Pass	Fail	NA	NP	Remark
§15.247(b)(4) RSS 210 / A8.4(2)	Antenna gain	Nominal	Nominal	GFSK	<input checked="" type="checkbox"/>	<input type="checkbox"/>	<input type="checkbox"/>	<input type="checkbox"/>	complies
§15.247(e) RSS 210 / A8.2(b)	Power spectral density	Nominal	Nominal	GFSK	<input checked="" type="checkbox"/>	<input type="checkbox"/>	<input type="checkbox"/>	<input type="checkbox"/>	complies
§15.247(a)(1) RSS 210 / A8.1(b)	Carrier frequency separation	Nominal	Nominal	GFSK	<input checked="" type="checkbox"/>	<input type="checkbox"/>	<input type="checkbox"/>	<input type="checkbox"/>	complies
§15.247(a)(1) RSS 210 / A8.1(d)	Number of hopping channels	Nominal	Nominal	GFSK	<input checked="" type="checkbox"/>	<input type="checkbox"/>	<input type="checkbox"/>	<input type="checkbox"/>	complies
§15.247(a)(1) (iii) RSS 210 / A8.3(1)	Time of occupancy (dwell time)	Nominal	Nominal	GFSK	<input checked="" type="checkbox"/>	<input type="checkbox"/>	<input type="checkbox"/>	<input type="checkbox"/>	complies
§15.247(a)(2) RSS 210 / A8.2(a)	DTS bandwidth 6 dB bandwidth	Nominal	Nominal	GFSK	<input checked="" type="checkbox"/>	<input type="checkbox"/>	<input type="checkbox"/>	<input type="checkbox"/>	complies
§15.247(a)(1) RSS 210	Spectrum bandwidth of a FHSS system 20 dB bandwidth	Nominal	Nominal	GFSK	<input checked="" type="checkbox"/>	<input type="checkbox"/>	<input type="checkbox"/>	<input type="checkbox"/>	complies
§15.247(b)(1) RSS-210 / A8.4(2)	Maximum output power	Nominal	Nominal	GFSK	<input checked="" type="checkbox"/>	<input type="checkbox"/>	<input type="checkbox"/>	<input type="checkbox"/>	complies
§15.247(d) RSS-210 / A8.5	Band edge compliance conducted	Nominal	Nominal	GFSK	<input checked="" type="checkbox"/>	<input type="checkbox"/>	<input type="checkbox"/>	<input type="checkbox"/>	complies
§15.205 RSS-210 / A8.5	Band edge compliance radiated	Nominal	Nominal	GFSK	<input checked="" type="checkbox"/>	<input type="checkbox"/>	<input type="checkbox"/>	<input type="checkbox"/>	complies
§15.247(d) RSS-210 / A8.5	TX spurious emissions conducted	Nominal	Nominal	GFSK	<input checked="" type="checkbox"/>	<input type="checkbox"/>	<input type="checkbox"/>	<input type="checkbox"/>	complies
§15.247(d) RSS-210 / A8.5	TX spurious emissions radiated	Nominal	Nominal	GFSK	<input checked="" type="checkbox"/>	<input type="checkbox"/>	<input type="checkbox"/>	<input type="checkbox"/>	complies
§15.109 RSS-Gen.	RX spurious emissions radiated	Nominal	Nominal	-/-	<input checked="" type="checkbox"/>	<input type="checkbox"/>	<input type="checkbox"/>	<input type="checkbox"/>	complies
§15.209(a) RSS-Gen	TX spurious emissions radiated < 30 MHz	Nominal	Nominal	GFSK	<input checked="" type="checkbox"/>	<input type="checkbox"/>	<input type="checkbox"/>	<input type="checkbox"/>	complies
§15.207(a)	Conducted emissions < 30 MHz	Nominal	Nominal	GFSK	<input checked="" type="checkbox"/>	<input type="checkbox"/>	<input type="checkbox"/>	<input type="checkbox"/>	complies

Note: NA = Not Applicable; NP = Not Performed

9 RF measurements

9.1 Description of test setup

9.1.1 Radiated measurements

The radiated measurements are performed in vertical and horizontal plane in the frequency range from 9 kHz to 25 GHz in semi-anechoic chambers. The EUT is positioned on a non-conductive support with a height of 0.80 m above a conductive ground plane that covers the whole chamber. The receiving antennas are confirmed with specifications ANSI C63.2-1996 clause 15 and ANSI C63.4-2009 clause 4.1.5. These antennas can be moved over the height range between 1.0 m and 4.0 m in order to search for maximum field strength emitted from EUT. The measurement distances between EUT and receiving antennas are indicated in the test setups for the various frequency ranges. For each measurement, the EUT is rotated in all three axes until the maximum field strength is received. The wanted and unwanted emissions are received by spectrum analysers where the detector modes and resolution bandwidths over various frequency ranges are set according to requirement ANSI C63-4-2009 clause 4.2.

Antennas are confirmed with ANSI C63.2-1996 item 15.

Semi anechoic chamber

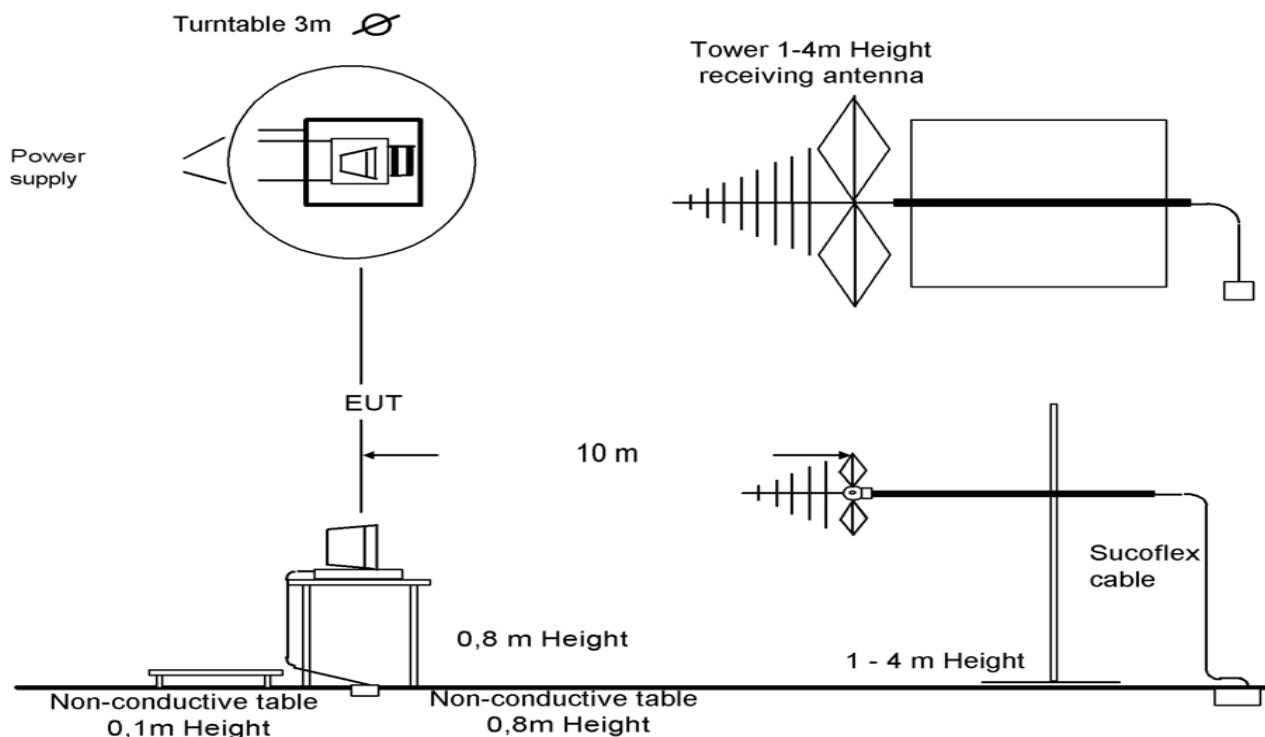

Picture 1: Diagram radiated measurements

9 kHz - 30 MHz:	active loop antenna
30 MHz – 1 GHz:	tri-log antenna
> 1 GHz:	horn antenna

All measurements are done in accordance with the Filing and Measurement Guidelines for Frequency Hopping Spread Spectrum Systems DA 00-705 and Appendix A "BLUETOOTH® APPROVALS"

The EUT is powered by an external power supply with nominal voltage. The signalling is performed from outside the chamber with a signalling unit (CMU200 or other) by air link using signalling antenna.

9.1.2 Conducted measurements

The EUT's RF signal is coupled out by the antenna connector which is supplied by the manufacturer. The signal is first 10dB attenuated before it is power divided (~6dB loss per branch). One of the signal paths is connected to the communication base Station (CMU200 or other), the other one is connected to the spectrum analyzer. The specific losses for both signal paths are first checked within a calibration. The measurement readings on the signalling unit/spectrum analyzer are corrected by the specific test set-up loss. The attenuator, power divider, signalling unit and the spectrum analyzer are impedance matched on 50 Ohm.

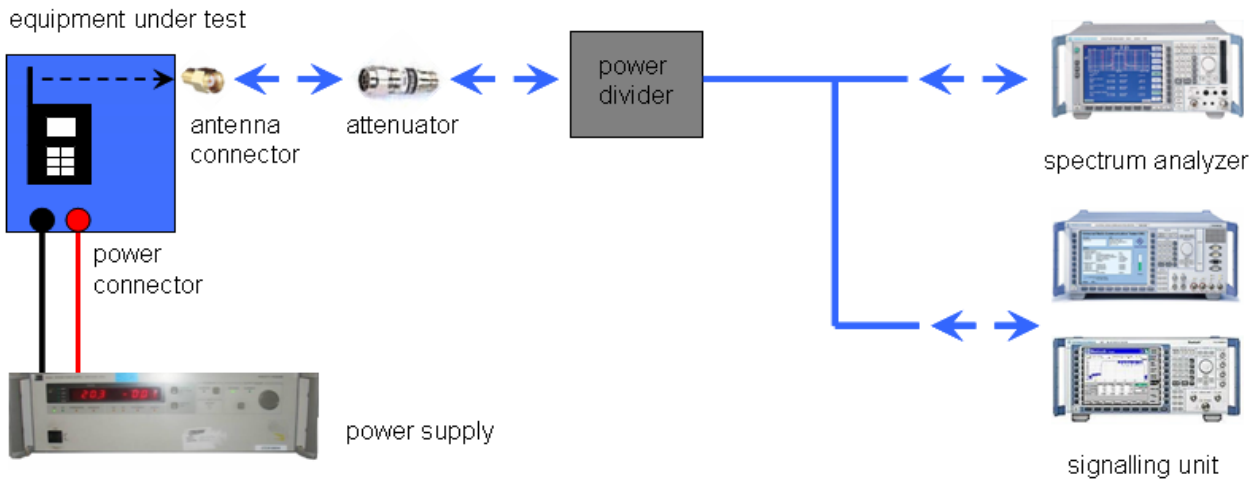

Picture 2: Diagram conducted measurements

9.2 Additional comments

The Bluetooth® word mark and logos are owned by the Bluetooth SIG Inc. and any use of such marks by Cetecom ICT Services GmbH is under license.

- | | |
|-----------------------------|--|
| Reference documents: | RF Fixture- Antenna Port Information |
| Special test descriptions: | None |
| Configuration descriptions: | TX tests: were performed with LE packets (37 byte payload) and static PRBS pattern.
RX/Standby tests: BT enabled, TX Idle |
| Test mode: | <input type="checkbox"/> Bluetooth LE Test mode enabled (EUT is controlled over CBT)
<input checked="" type="checkbox"/> Special software is used. EUT is transmitting pseudo random data by itself |

10 Measurement results

10.1 Antenna gain

Measurement:

The antenna gain of the complete system is calculated by the difference of radiated power in EIRP and the conducted power of the module. For normal Bluetooth® devices, the GFSK modulation is used.

Measurement parameters:

Measurement parameter	
Detector:	Peak
Sweep time:	Auto
Resolution bandwidth:	3 MHz
Video bandwidth:	3 MHz
Span:	5 MHz
Trace-Mode:	Max hold

Limits:

FCC	IC
Antenna Gain	
6 dBi	

Results:

T _{nom}	V _{nom}	lowest channel 2402 MHz	middle channel 2440 MHz	highest channel 2480 MHz
Conducted power [dBm] Measured with GFSK modulation		-1.02	-1.32	-1.41
Radiated power [dBm] Measured with GFSK modulation		1.04	0.05	-0.01
Gain [dBi] Calculated		2.06	1.37	1.40

Result: Passed

10.2 Power spectral density

Description:

Measurement of the power spectral density of a digital modulated system.

Measurement:

Measurement parameter	
According DTS guideline 2013-04 clause 10.2	
Detector:	Peak
Sweep time:	Auto
Resolution bandwidth:	3 kHz
Video bandwidth:	10 kHz
Span:	1.5x DTS BW
Trace-Mode:	Max Hold

Limits:

FCC	IC
Power Spectral Density	
For digitally modulated systems the transmitter power spectral density conducted from the transmitter to the antenna shall not be greater than 8 dBm in any 3 kHz band during any time interval of continuous transmission or over 1.0 second if the transmission exceeds 1.0-second duration.	

Results:

Modulation Frequency	Power spectral density		
	2402 MHz	2440 MHz	2480 MHz
[dBm / 3kHz]	-16.25	-16.32	-16.54
Measurement uncertainty	± 1.5 dB		

Plots:

Plot 1: lowest channel

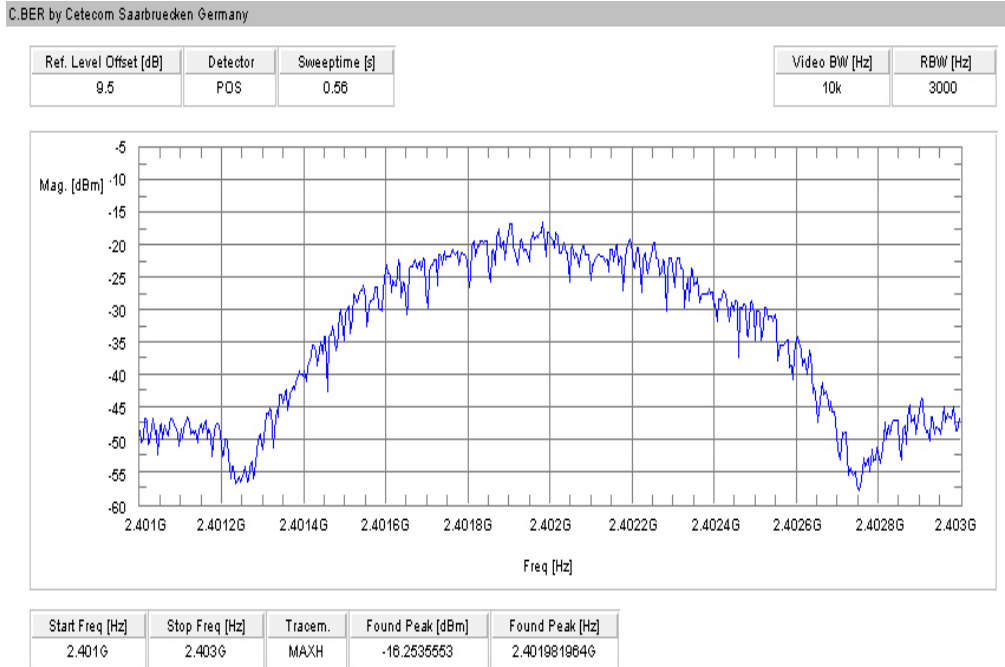

Plot 2: mid channel

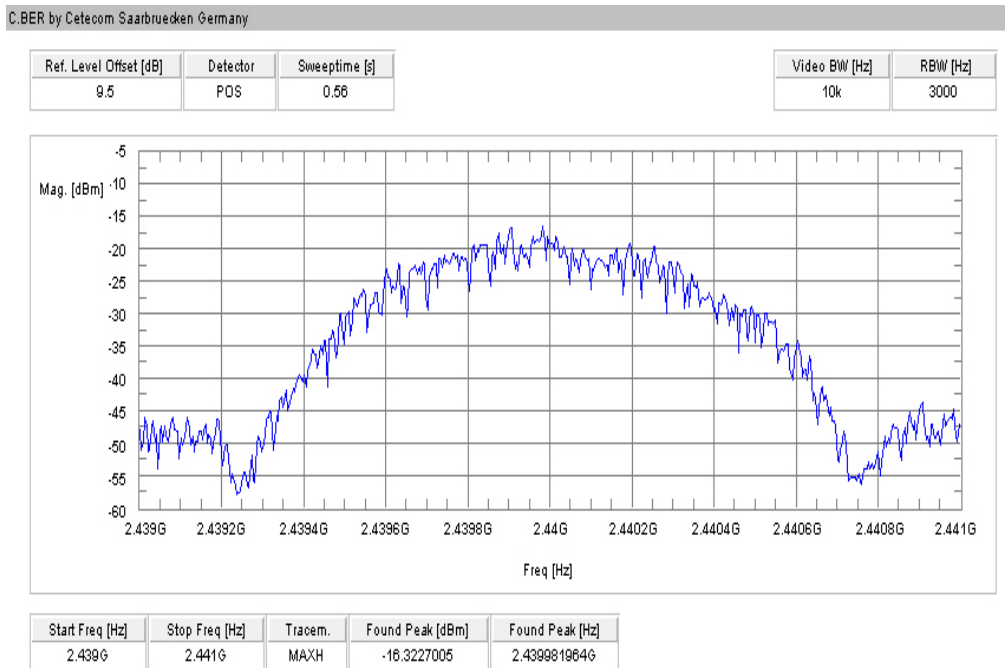

Plot 3: highest channel

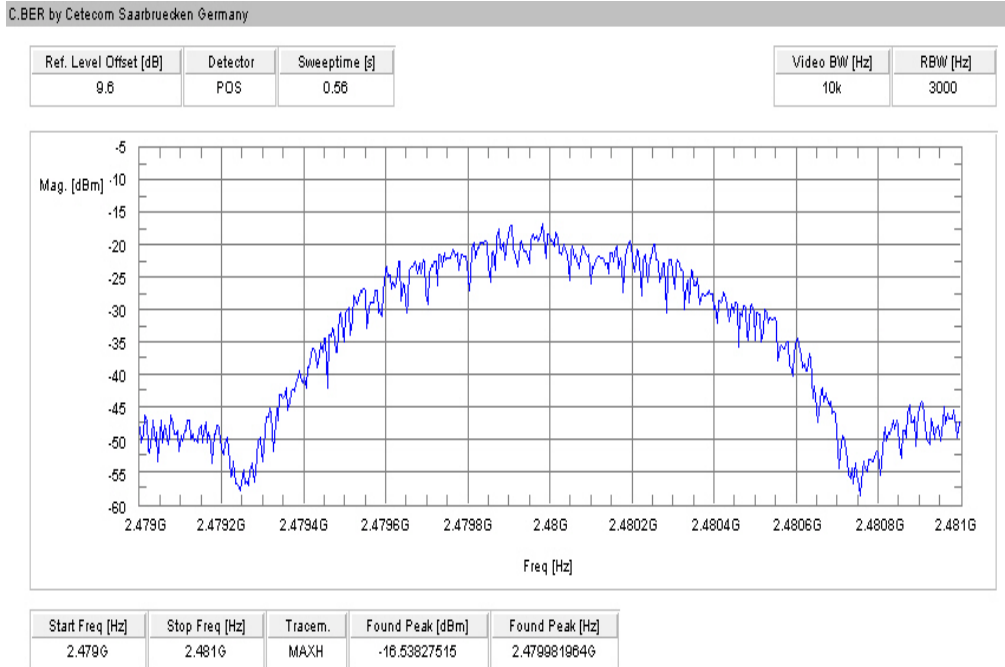

10.3 Carrier frequency separation

Description:

Measurement of the carrier frequency separation of a hopping system. We use GFSK modulation to show compliance. EUT in hopping mode.

Measurement:

Measurement parameter	
Detector:	Peak
Sweep time:	Auto
Resolution bandwidth:	100 kHz
Video bandwidth:	100 kHz
Span:	4 MHz
Trace-Mode:	Max Hold

Limits:

FCC	IC
Carrier Frequency Separation	
Minimum 25 kHz or two-thirds of the 20 dB bandwidth of the hopping system whichever is greater.	

Result:

Carrier frequency separation	~ 2 MHz
------------------------------	---------

Result: Passed

Plot:

Plot 1: Carrier Frequency Separation

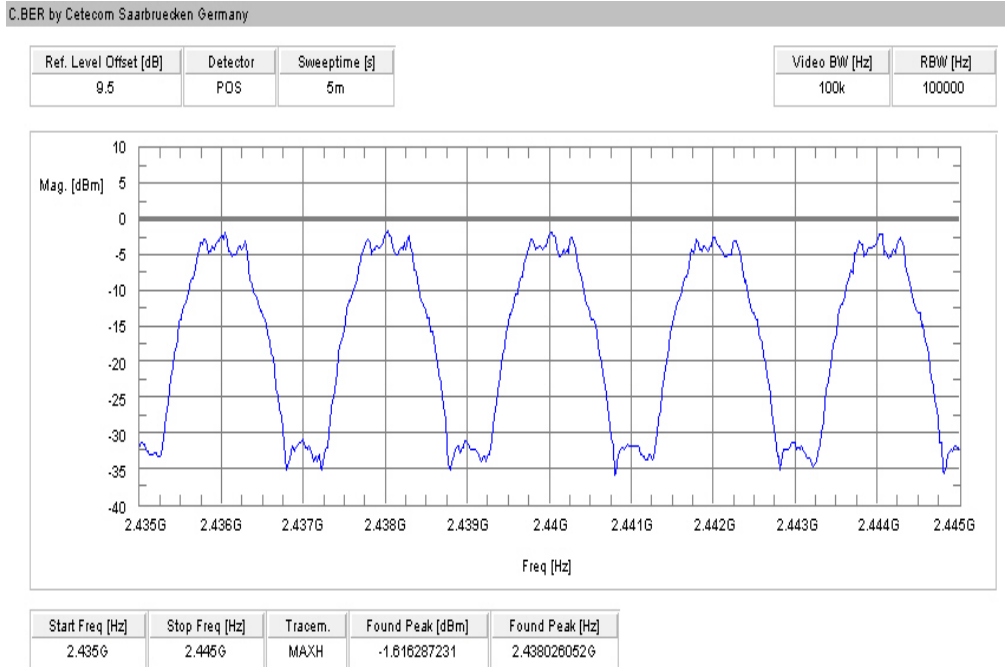

10.4 Number of hopping channels

Description:

Measurement of the total number of used hopping channels. The number of hopping channels is constant for all modulation-modes. We use GFSK modulation to show compliance. EUT in hopping mode.

Measurement:

Measurement parameter	
Detector:	Peak
Sweep time:	Auto
Resolution bandwidth:	500 kHz
Video bandwidth:	500 kHz
Span:	Plot 1: 2400 – 2445 MHz Plot 2: 2445 – 2485 MHz
Trace-Mode:	Max Hold

Limits:

FCC	IC
Number of hopping channels	
At least 15 non overlapping hopping channels	

Result:

Number of hopping channels	40
----------------------------	----

Result: Passed

Plots:

Plot 1: Number of hopping channels

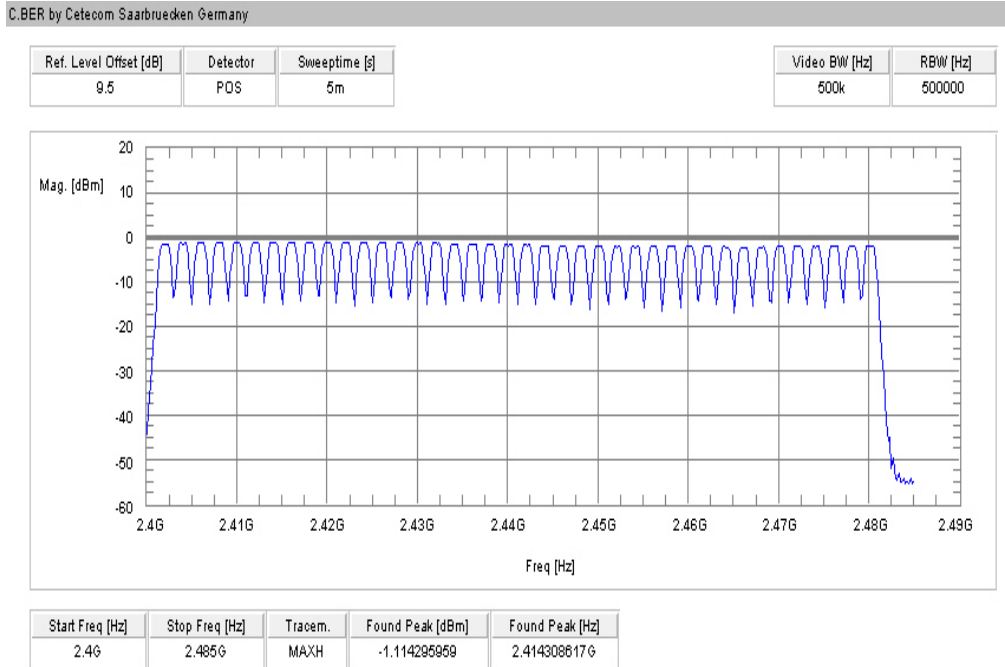

10.5 Time of occupancy (dwell time)

Measurement:

Measuring/calculation of the pulse width in data transmit mode on one hopping channel for a Bluetooth® LE device.

Measurement parameters:

Detector: Peak
 Video bandwidth: 1 MHz
 Resolution bandwidth: 1 MHz
 Span: Zero Span
 Trace: Video triggered

For Bluetooth® LE devices:

Time slot length: 625us
 Number of channels: 40
 Number of time slots per second: 1600/s
 Max. number of transmissions per channel in 1 s: $1600/s / 40 = 40$
 Max. number of transmissions per channel in 16 s: $40 \times 16 = 640$
 Period: Number of channels \times 0.4s = 16s

Under normal test conditions only	400 ms within in a period
-----------------------------------	---------------------------

Results:

Dwell time = standard test packet pulse width*) \times number of transmission per channel in 15.6 seconds

Packet type	standard test packet pulse width [ms]	number of hops in 16 sec	calculated dwell time[ms]
Data Transmit mode	0.376	640	241

*) For Bluetooth® LE devices no measurements are mandatory due to the fixed requirements of the Bluetooth® Core Specification. The standard test packet is defined as:

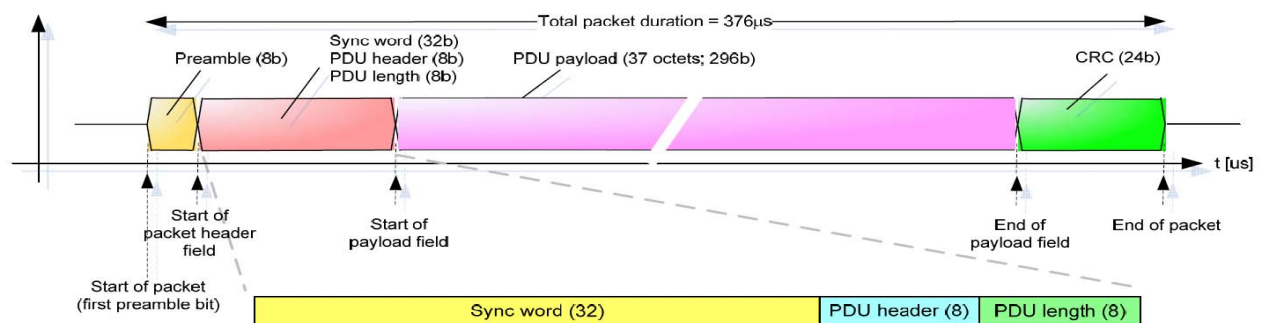

Result: Passed

10.6 DTS bandwidth – 6 dB bandwidth

Description:

Measurement of the 6 dB bandwidth of the modulated signal.

Measurement:

Measurement parameter	
According DTS guideline 2013-04 clause 8.2	
Detector:	Peak
Sweep time:	Auto
Resolution bandwidth:	100 kHz
Video bandwidth:	300 kHz
Span:	3 MHz
Trace-Mode:	Max Hold

Limits:

FCC	IC
Spectrum bandwidth – 6 dB bandwidth	
> 500 kHz	

Results:

Modulation	6 dB BANDWIDTH [kHz]		
	2402 MHz	2440 MHz	2480 MHz
Frequency			
GFSK	753	751	760
Measurement uncertainty	± 20 kHz		

Result: Passed

10.7 Spectrum bandwidth of a FHSS system – 20 dB bandwidth

Description:

Measurement of the 20 dB bandwidth of the modulated signal. The measurement is performed according to the “Measurement Guidelines” (DA 00-705, March 30, 2000). EUT in single channel mode.

Measurement:

Measurement parameter	
Detector:	Peak
Sweep time:	2 s
Resolution bandwidth:	30 kHz
Video bandwidth:	100 kHz
Span:	4 MHz
Trace-Mode:	Max Hold

Limits:

FCC	IC
Spectrum bandwidth of a FHSS system – 20 dB bandwidth	
Bandwidth < 3/2 * Channel spacing	

Results:

Modulation Frequency	20 dB BANDWIDTH [kHz]		
	2402 MHz	2440 MHz	2480 MHz
GFSK	1130	1130	1130
Measurement uncertainty	± 30 kHz		

Result: Passed

Plots:

Plot 1: lowest channel

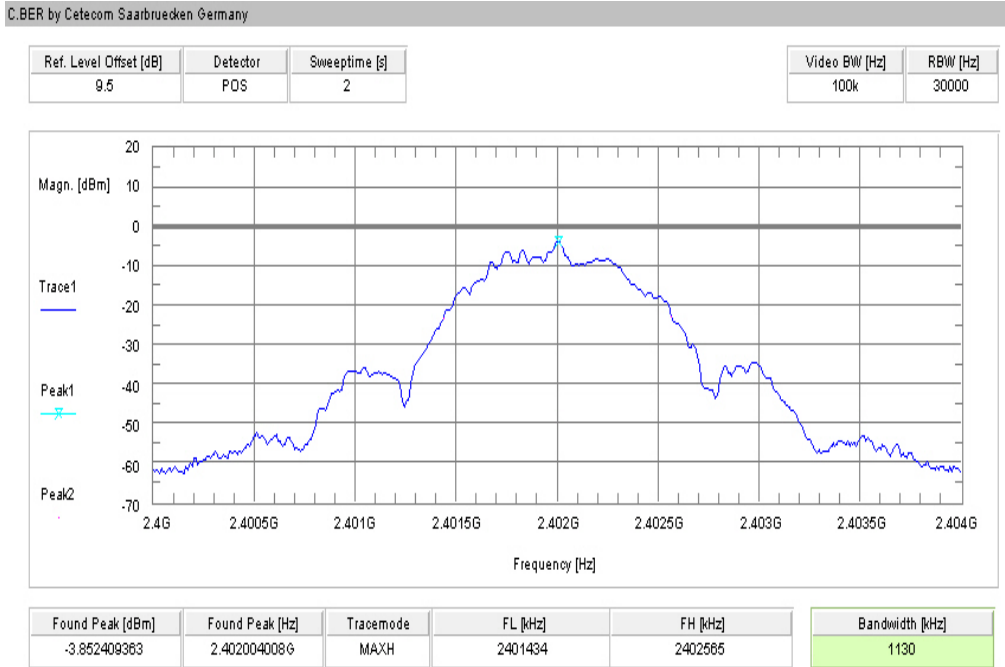

Plot 2: mid channel

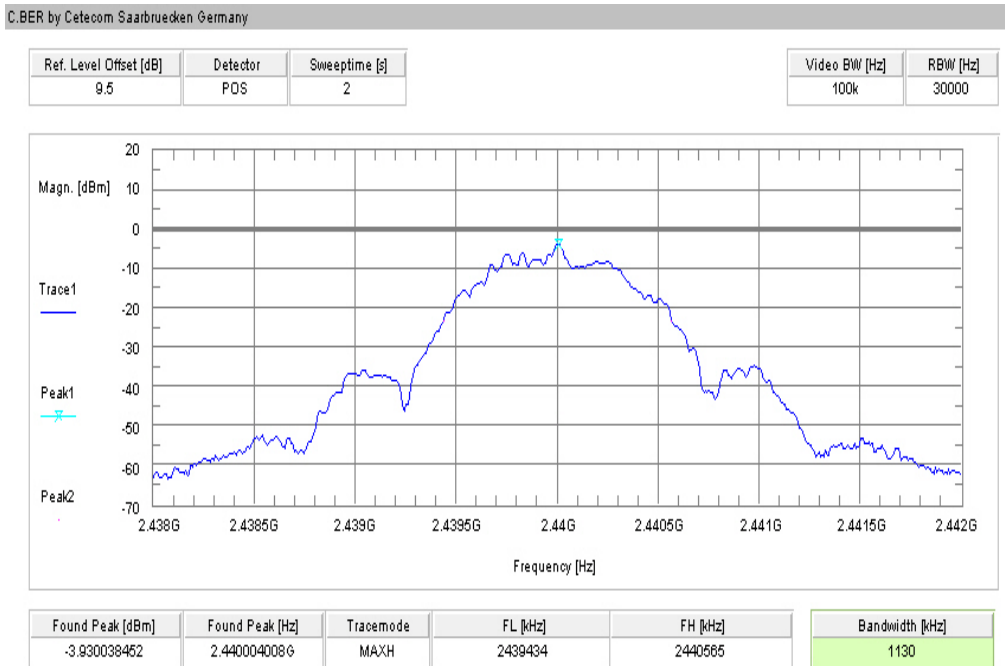

Plot 3: highest channel

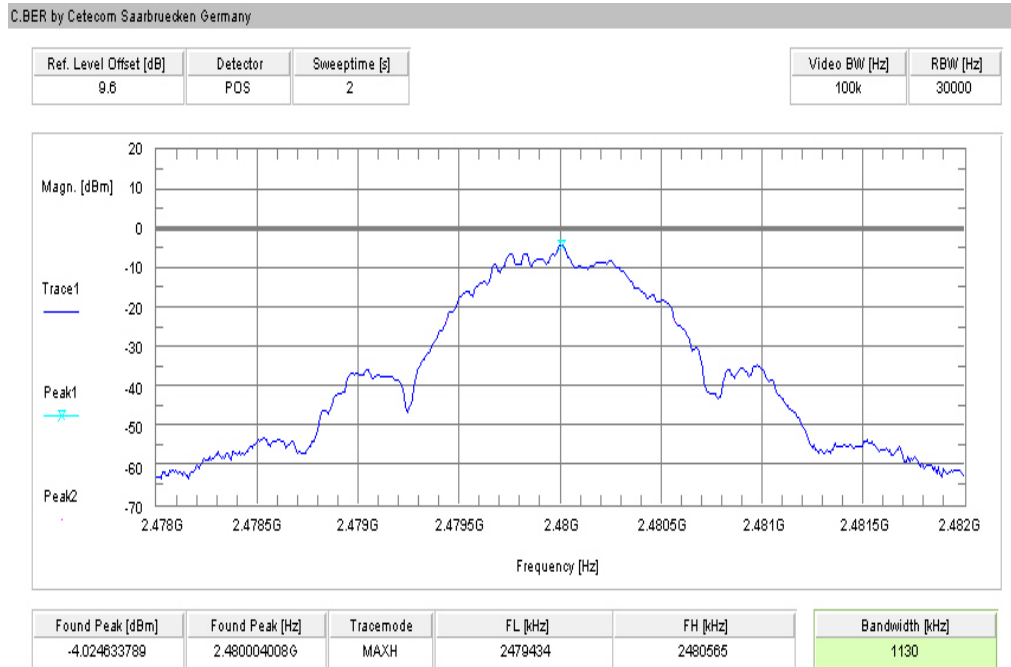

10.8 Maximum output power

Description:

Measurement of the maximum output power conducted and radiated. EUT in single channel mode.

Measurement:

Measurement parameter	
According DTS guideline 2013-04 clause 9.1.1	
Detector:	Peak
Sweep time:	Auto
Resolution bandwidth:	3 MHz
Video bandwidth:	10 MHz
Span:	6 MHz
Trace-Mode:	Max Hold

Limits:

FCC	IC
Maximum output power	
[Conducted: 0.125 W – antenna gain max. 6 dBi] Systems using more than 75 hopping channels: Conducted: 1.0 W – antenna gain max. 6 dBi	

Results:

Modulation	Maximum output power conducted [dBm]		
	2402 MHz	2440 MHz	2480 MHz
Frequency			
GFSK	-1.02	-1.32	-1.41
Measurement uncertainty	± 1.5 dB		

Modulation	Maximum output power radiated - EIRP [dBm]		
	2402 MHz	2440 MHz	2480 MHz
Frequency			
GFSK	1.04	0.05	-0.01
Measurement uncertainty	± 3 dB		

*) - Values calculated with antenna gain

Result: Passed

Plots:

Plot 1: lowest channel

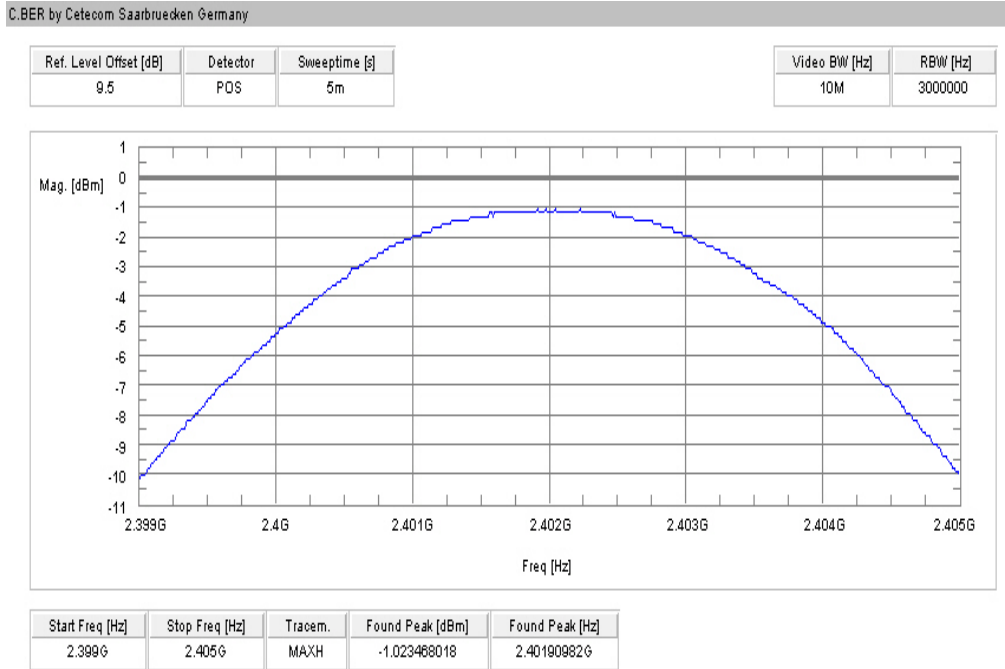

Plot 2: mid channel

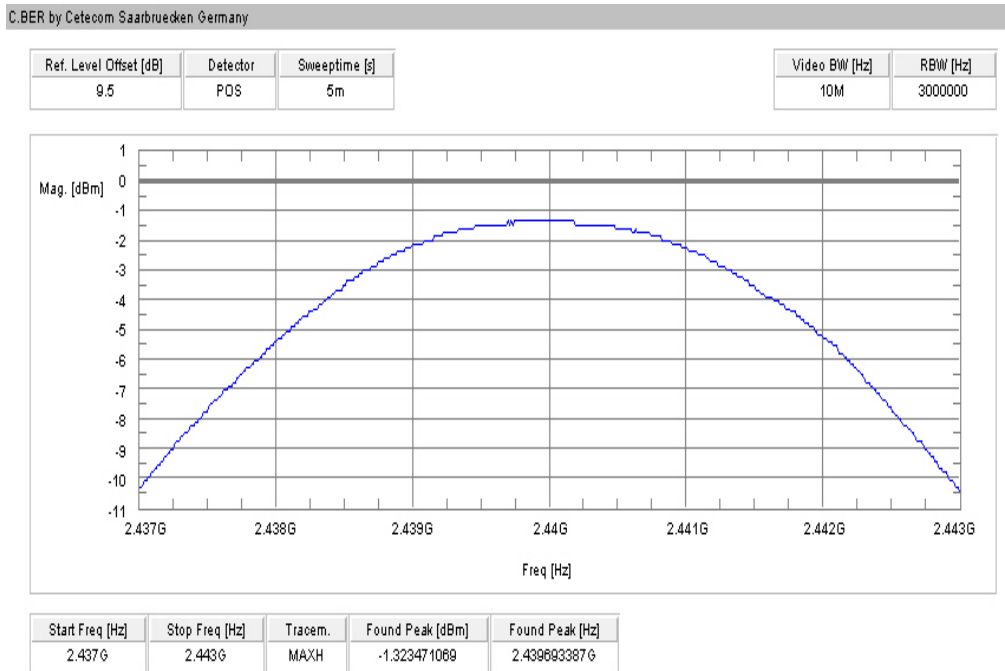

Plot 3: highest channel

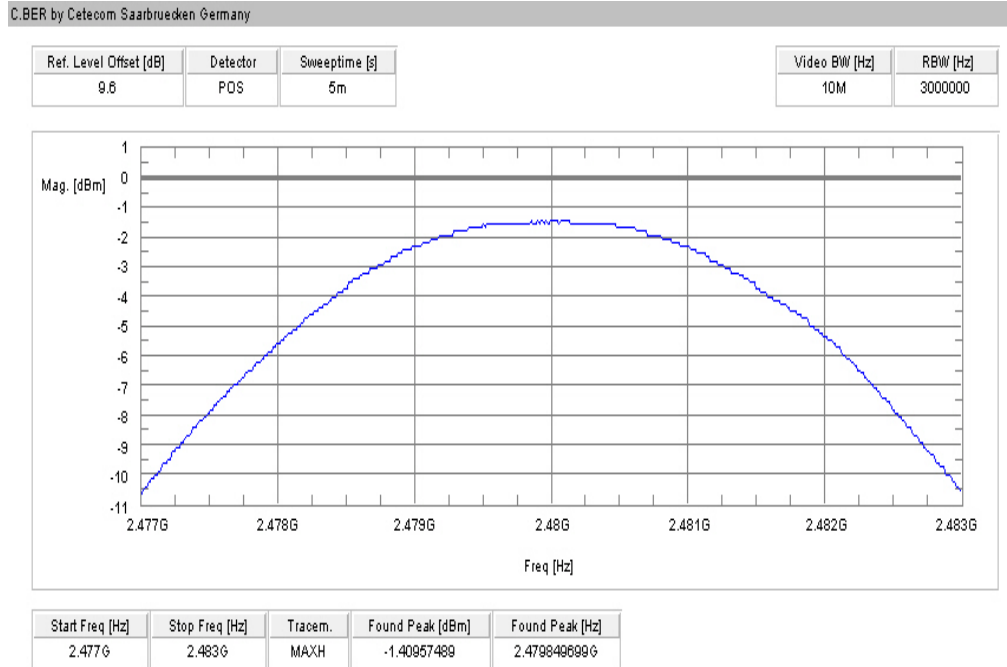

10.9 Band edge compliance conducted

Description:

Measurement of the conducted band edge compliance. EUT is measured at the lower and upper band edge in single channel and hopping mode. The measurement is repeated for all modulations.

Measurement:

Measurement parameter	
Detector:	Peak
Sweep time:	Auto
Resolution bandwidth:	100 kHz
Video bandwidth:	100 kHz
Span:	Lower Band Edge: 2395 – 2405 MHz Upper Band Edge: 2478 – 2489 MHz
Trace-Mode:	Max Hold

Limits:

FCC	IC
Band edge compliance conducted	
<p>In any 100 kHz bandwidth outside the frequency band in which the spread spectrum or digitally modulated intentional radiator is operating, the radio frequency power that is produced by the intentional radiator shall be at least 20 dB below that in the 100 kHz bandwidth within the band that contains the highest level of the desired power, based on either an RF conducted or a radiated measurement. Attenuation below the general limits specified in Section 15.209(a) is not required.</p>	

Result:

Scenario Modulation	Band edge compliance conducted [dB]
	GFSK
Lower band edge – hopping off	> 20 dB
Lower band edge – hopping on	> 20 dB
Upper band edge – hopping off	> 20 dB
Upper band edge – hopping on	> 20 dB
Measurement uncertainty	± 1.5 dB

Result: Passed

Plots:

Plot 1: Lower band edge – hopping on

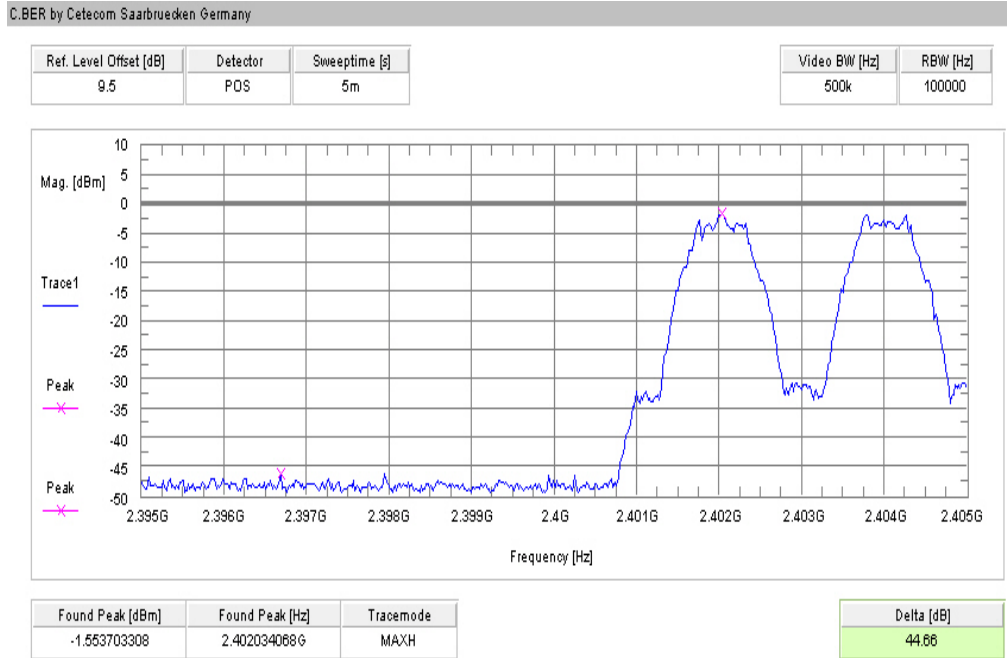

Plot 2: Upper band edge – hopping on

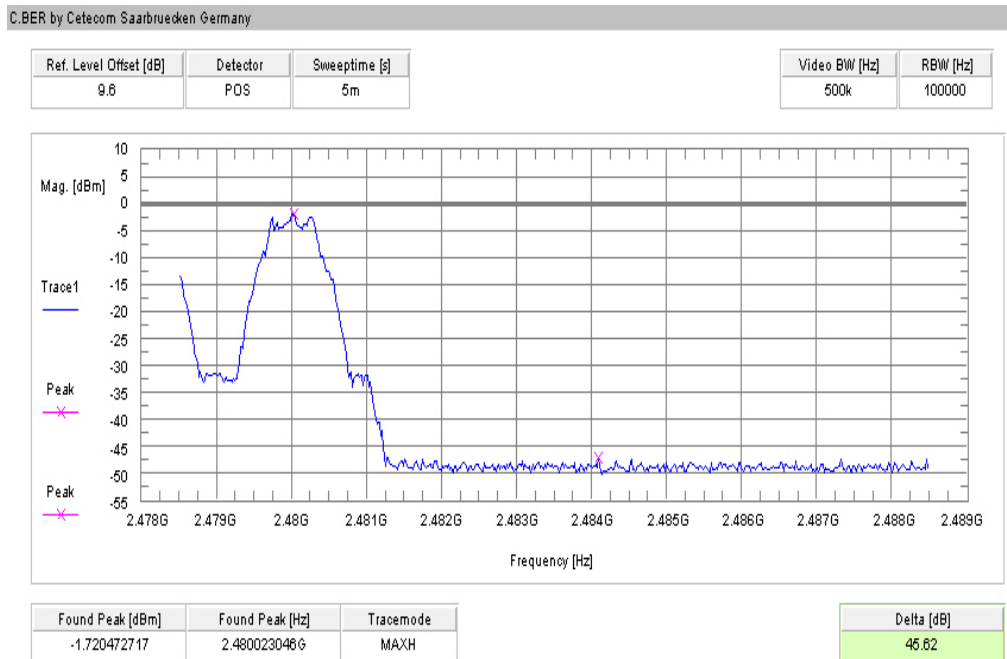

Plot 3: Lower band edge – hopping off

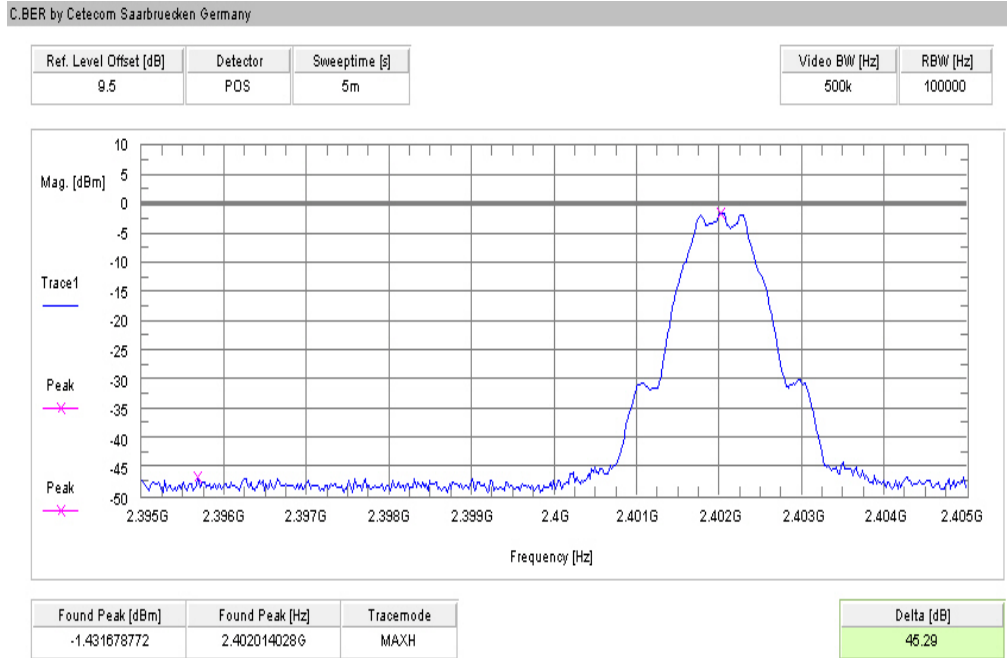

Plot 4: Upper band edge – hopping off

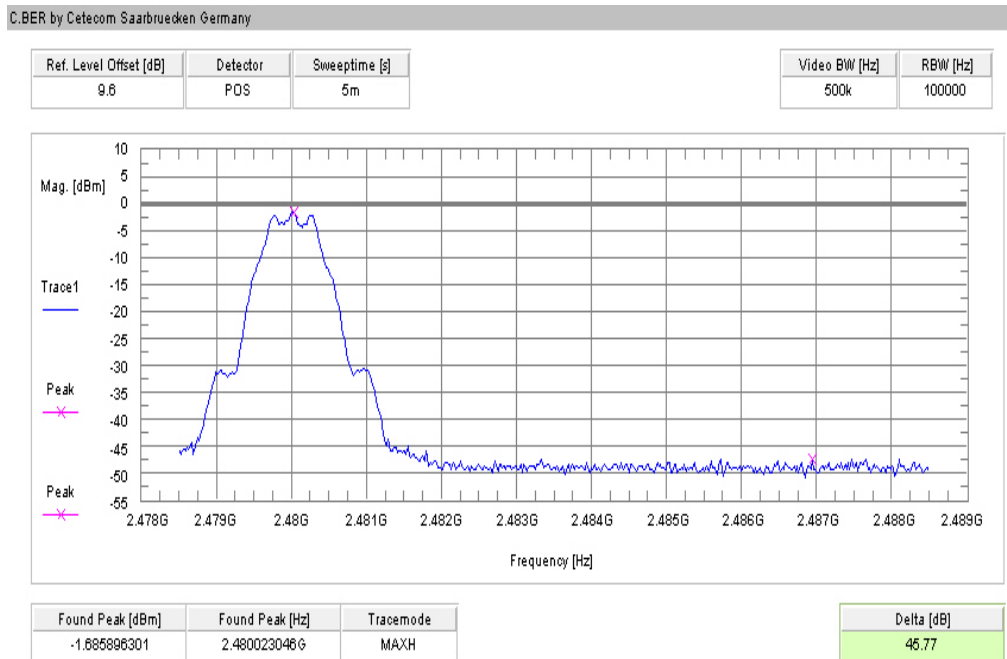

10.10 Band edge compliance radiated

Description:

Measurement of the radiated band edge compliance. The EUT is turned in the position that results in the maximum level at the band edge. Then a sweep over the corresponding restricted band is performed. The EUT is set to single channel mode and the transmit channel is channel 00 for the lower restricted band and channel 39 for the upper restricted band. The measurement is repeated for all modulations. Measurement distance is 3m.

Measurement:

Measurement parameter	
Detector:	Peak
Sweep time:	Auto
Resolution bandwidth:	1 MHz
Video bandwidth:	10 Hz
Span:	Lower Band: 2300 – 2400 MHz Upper Band: 2480 – 2500 MHz
Trace-Mode:	Max Hold

Limits:

FCC	IC
Band edge compliance radiated	
<p>In any 100 kHz bandwidth outside the frequency band in which the spread spectrum or digitally modulated intentional radiator is operating, the radio frequency power that is produced by the intentional radiator shall be at least 20 dB below that in the 100 kHz bandwidth within the band that contains the highest level of the desired power, based on either an RF conducted or a radiated measurement. Attenuation below the general limits specified in Section 15.209(a) is not required. In addition, radiated emissions which fall in the restricted bands, as defined in Section 15.205(a), must also comply with the radiated emission limits specified in Section 15.209(a) (see Section 5.205(c)).</p>	
54 dB μ V/m AVG	

Result:

Scenario	Band edge compliance radiated [dB μ V/m]
Modulation	GFSK
Lower restricted band	< 54 (see plot 1)
Upper restricted band	< 54 (see plot 2)
Measurement uncertainty	\pm 3 dB

Result: Passed

Plots:

Plot 1: Lower restricted band

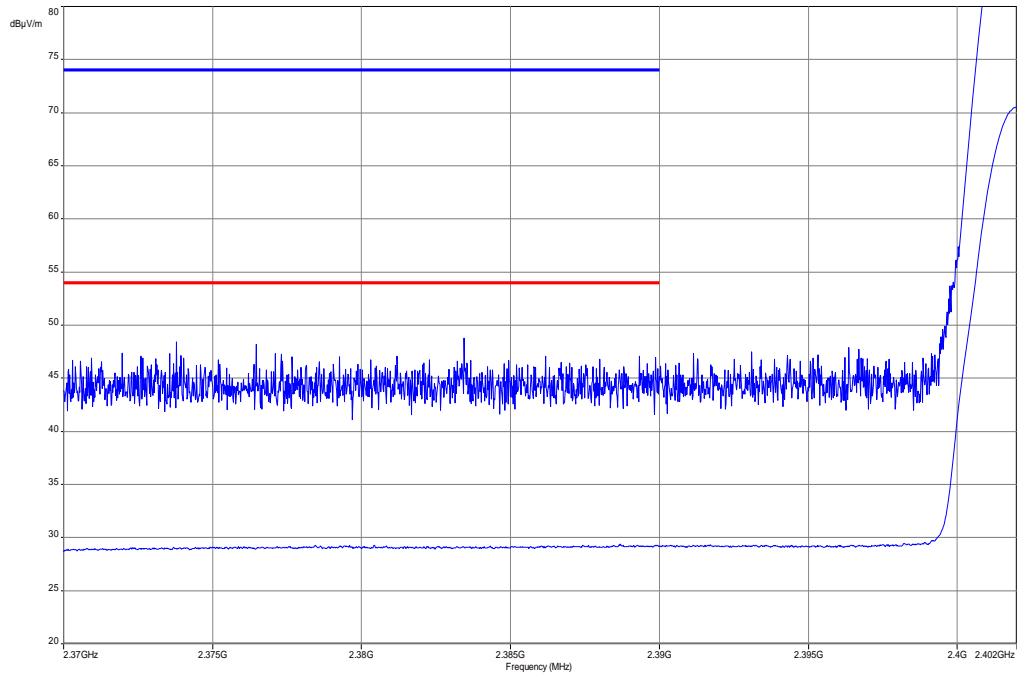

Plot 2: Upper restricted band

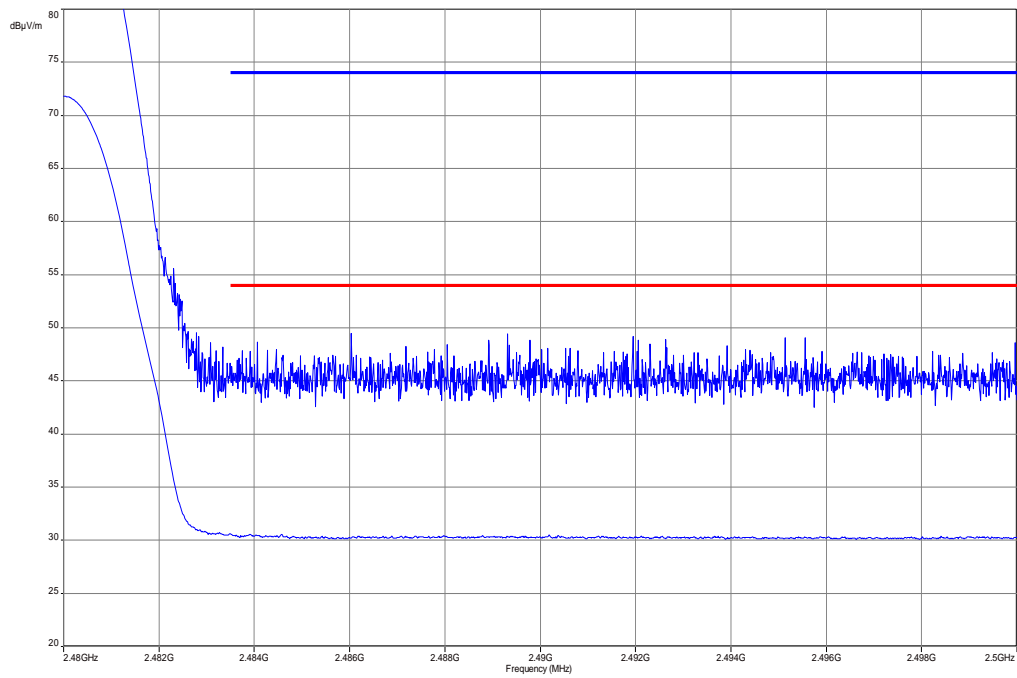

10.11 TX spurious emissions conducted

Description:

Measurement of the conducted spurious emissions in transmit mode. The EUT is set to single channel mode and the transmit channel is channel 00, channel 19 and channel 39. The measurement is repeated for all modulations.

Measurement:

Measurement parameter	
Detector:	Peak
Sweep time:	Auto
Resolution bandwidth:	100 kHz
Video bandwidth:	300 kHz or 500 kHz
Span:	9 kHz to 25 GHz
Trace-Mode:	Max Hold

Limits:

FCC	IC
TX spurious emissions conducted	
<p>In any 100 kHz bandwidth outside the frequency band in which the spread spectrum or digitally modulated intentional radiator is operating, the radio frequency power that is produced by the intentional radiator shall be at least 20 dB below that in the 100 kHz bandwidth within the band that contains the highest level of the desired power, based on either an RF conducted or a radiated measurement. Attenuation below the general limits specified in Section 15.209(a) is not required</p>	

Results:

TX spurious emissions conducted					
f [MHz]		amplitude of emission [dBm]	limit max. allowed emission power	actual attenuation below frequency of operation [dB]	results
2402		-1.28	30 dBm		Operating frequency
<i>No critical peaks found! All detected emissions are more than 6 dB below the limit!</i>			-20 dBc		complies
2440		-1.34	30 dBm		Operating frequency
<i>No critical peaks found! All detected emissions are more than 6 dB below the limit!</i>			-20 dBc		complies
2480		-1.51	30 dBm		Operating frequency
<i>No critical peaks found! All detected emissions are more than 6 dB below the limit!</i>			-20 dBc		complies
Measurement uncertainty		± 3 dB			

Result: Passed

Plots:

Plot 1: lowest channel

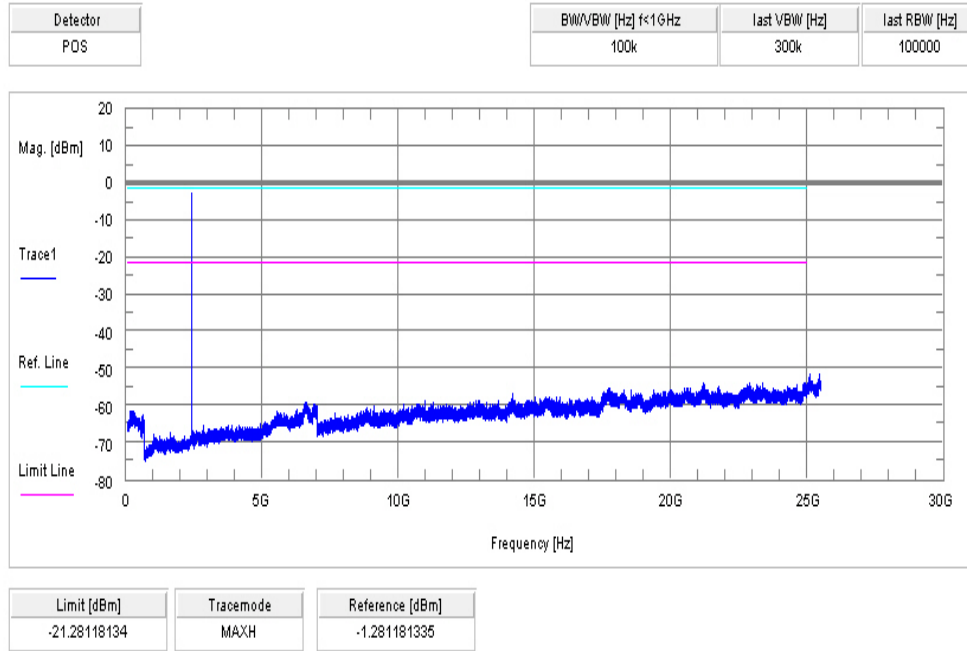

Plot 2: mid channel

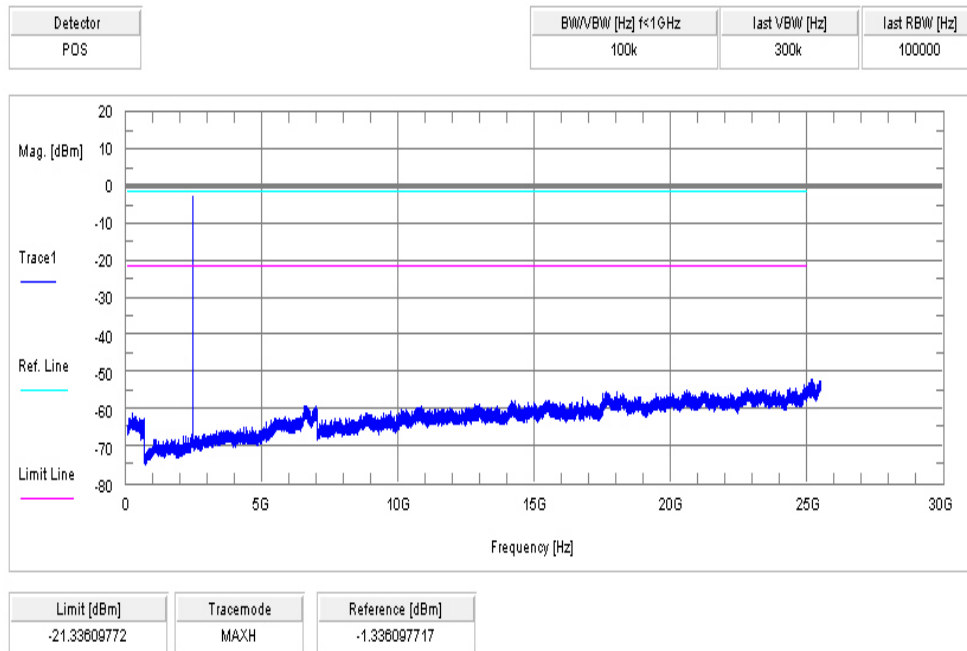

Plot 3: highest channel

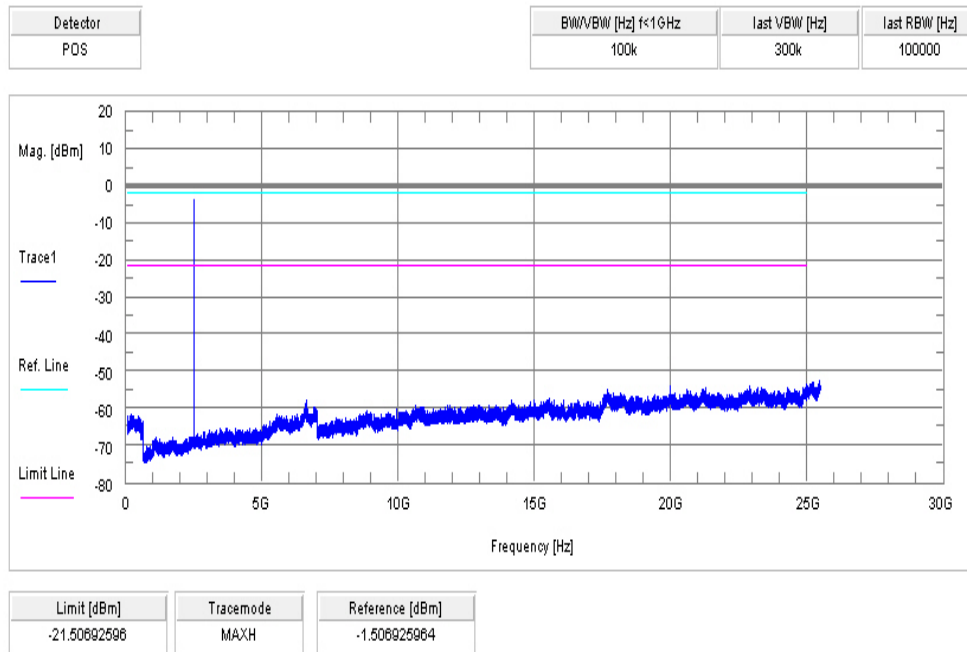

10.12 TX spurious emissions radiated

Description:

Measurement of the radiated spurious emissions in transmit mode. The EUT is set to single channel mode and the transmit channel is channel 00, channel 19 and channel 39. The measurement is performed in the mode with the highest output power.

Measurement:

Measurement parameter	
Detector:	Peak / Quasi Peak
Sweep time:	Auto
Resolution bandwidth:	F < 1 GHz: 100 kHz F > 1 GHz: 1 MHz
Video bandwidth:	Sweep: 100 kHz Remeasurement: 10 Hz
Span:	30 MHz to 25 GHz
Trace-Mode:	Max Hold
Measured Modulation:	GFSK

The modulation with the highest output power was used to perform the transmitter spurious emissions. If spurious were detected a re-measurement was performed on the detected frequency with each modulation.

Limits:

FCC		IC
TX spurious emissions radiated		
<p>In any 100 kHz bandwidth outside the frequency band in which the spread spectrum or digitally modulated intentional radiator is operating, the radio frequency power that is produced by the intentional radiator shall be at least 20 dB below that in the 100 kHz bandwidth within the band that contains the highest level of the desired power, based on either an RF conducted or a radiated measurement. Attenuation below the general limits specified in Section 15.209(a) is not required. In addition, radiated emissions which fall in the restricted bands, as defined in §15.205(a), must also comply with the radiated emission limits specified in §15.209(a) (see §15.205(c)).</p>		
§15.209		
Frequency (MHz)	Field strength (dBµV/m)	Measurement distance
30 - 88	30.0	10
88 - 216	33.5	10
216 - 960	36.0	10
Above 960	54.0	3

Results:

TX spurious emissions radiated [dBµV/m]								
2402 MHz			2440 MHz			2480 MHz		
F [MHz]	Detector	Level [dBµV/m]	F [MHz]	Detector	Level [dBµV/m]	F [MHz]	Detector	Level [dBµV/m]
For emissions below 1 GHz, please take a look at the table below the 1 GHz plot.			For emissions below 1 GHz, please take a look at the table below the 1 GHz plot.			For emissions below 1 GHz, please take a look at the table below the 1 GHz plot.		
No emissions detected above 1 GHz.			No emissions detected above 1 GHz.			No emissions detected above 1 GHz.		
Measurement uncertainty			± 3 dB					

Result: Passed

Plots:

Plot 1: 30 MHz to 1 GHz, lowest channel, vertical & horizontal polarization

Common Information

EUT: PM-0320--BV
 Test Description: FCC part 15 class B @ 10 m
 Operating Conditions: BT LE CH0
 Operator Name: Wolsdorfer
 Comment: AC: 115 V / 60 Hz

Scan Setup: STAN_Fin [EMI radiated]

Hardware Setup: Electric Field (NOS)
 Receiver: [ESCI 3]
 Level Unit: dBµV/m

Subrange	Step Size	Detectors	IF BW	Meas. Time	Preamp
30 MHz - 2 GHz	60 kHz	QPK	120 kHz	1 s	20 dB

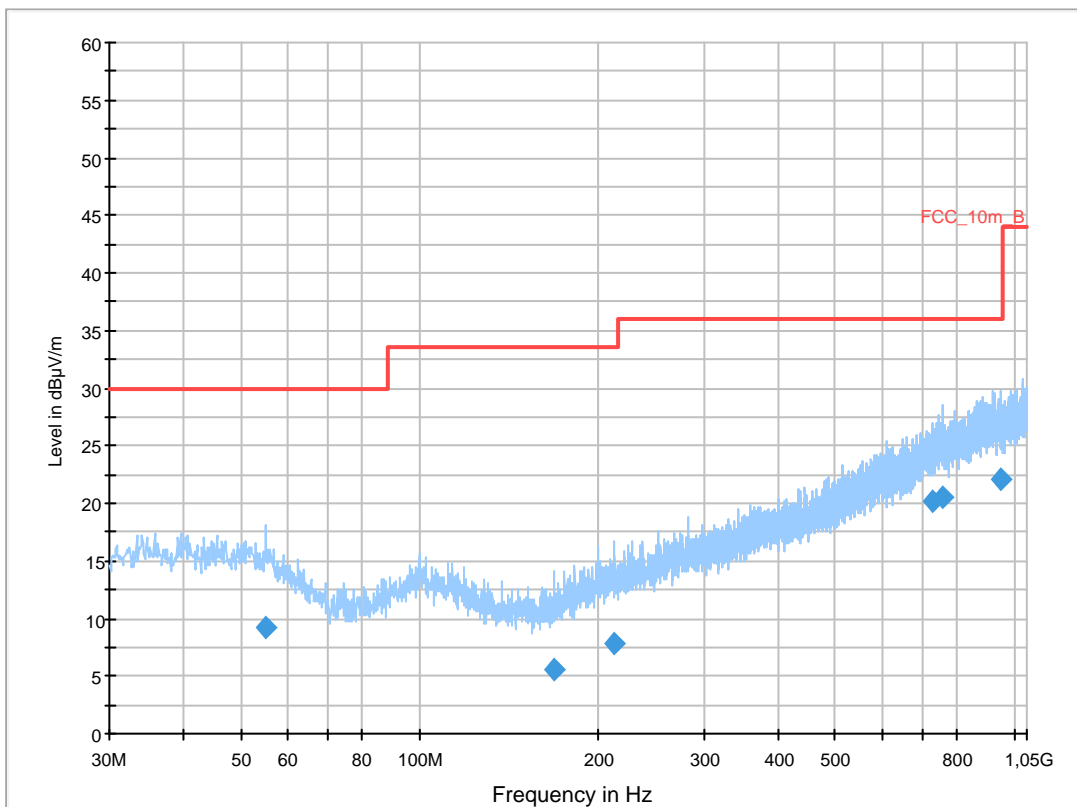

Final Result 1

Frequency (MHz)	QuasiPeak (dBµV/m)	Meas. Time (ms)	Bandwidth (kHz)	Height (cm)	Polarization	Azimuth (deg)	Corr. (dB)	Margin (dB)	Limit (dBµV/m)	Comment
55.146750	9.1	1000.0	120.000	112.0	V	270.0	12.8	20.9	30.0	
167.866950	5.5	1000.0	120.000	170.0	H	280.0	9.7	28.0	33.5	
212.972850	7.8	1000.0	120.000	170.0	H	90.0	12.2	25.7	33.5	
731.423100	20.2	1000.0	120.000	120.0	H	100.0	23.2	15.8	36.0	
756.275100	20.5	1000.0	120.000	106.0	H	170.0	23.7	15.5	36.0	
948.266850	22.1	1000.0	120.000	170.0	H	100.0	25.3	13.9	36.0	

Plot 2: 1 GHz to 12.75 GHz, lowest channel, vertical & horizontal polarization

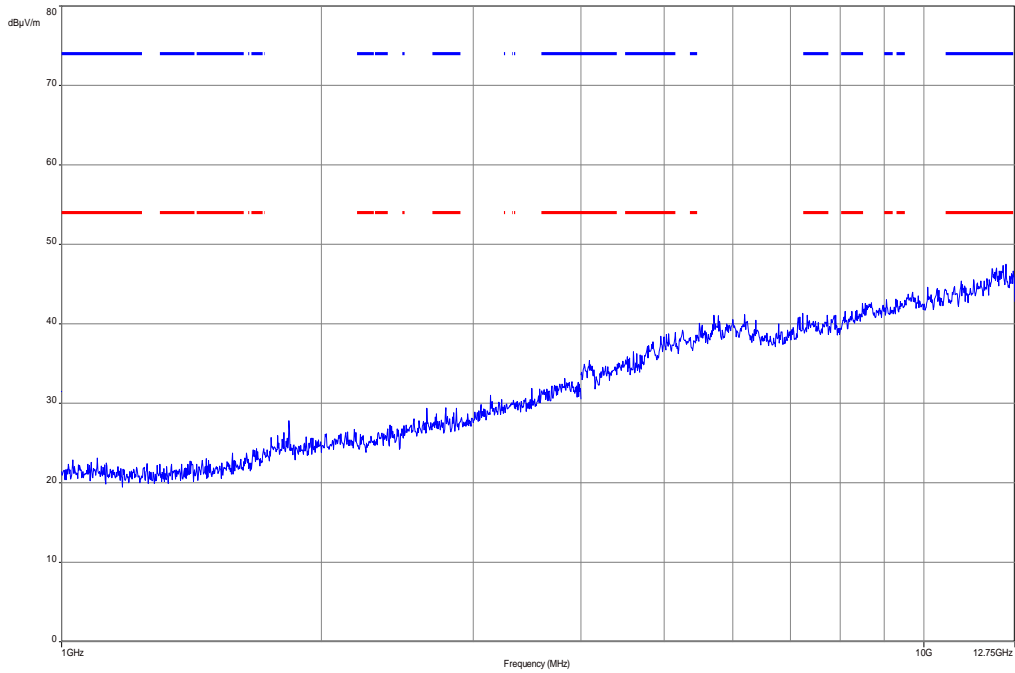

Carrier suppressed with a 2.4 GHz-band rejection filter.

Plot 3: 12.75 GHz to 18 GHz, lowest channel, vertical & horizontal polarization

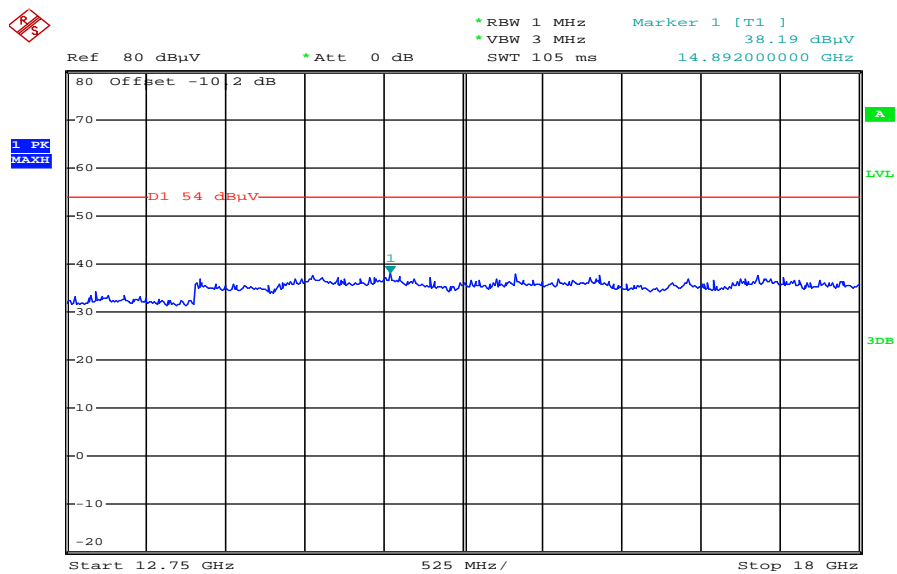

Date: 18.FEB.2013 11:34:01

Plot 4: 18 GHz to 26 GHz, lowest channel, vertical & horizontal polarization

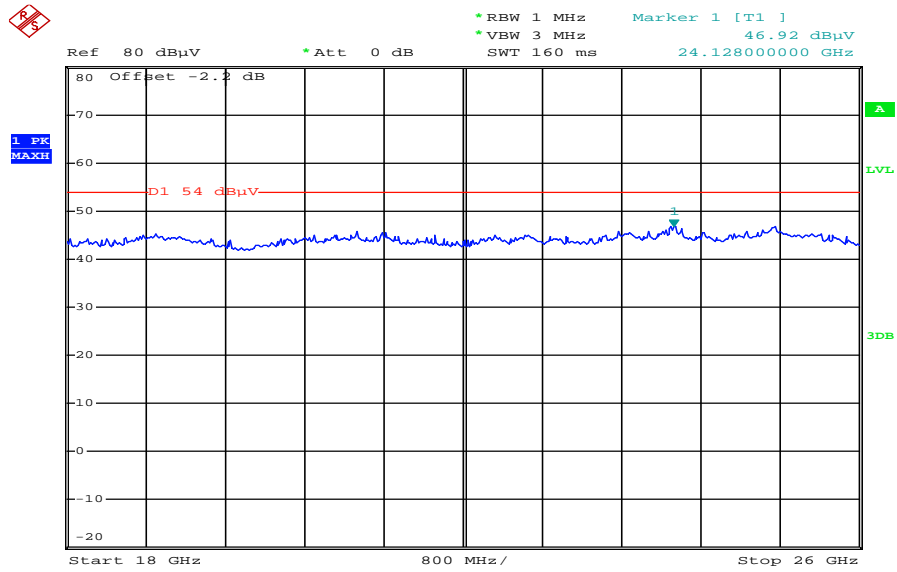

Date: 18.FEB.2013 11:13:12

Plot 5: 30 MHz to 1 GHz, mid channel, vertical & horizontal polarization

Common Information

EUT: PM-0320--BV
 Test Description: FCC part 15 class B @ 10 m
 Operating Conditions: BT LE CH39
 Operator Name: Medrow
 Comment: AC: 115 V / 60 Hz

Scan Setup: STAN_Fin [EMI radiated]

Hardware Setup: Electric Field (NOS)
 Receiver: [ESCI 3]
 Level Unit: dBµV/m

Subrange	Step Size	Detectors	IF BW	Meas. Time	Preamp
30 MHz - 2 GHz	60 kHz	QPK	120 kHz	1 s	20 dB

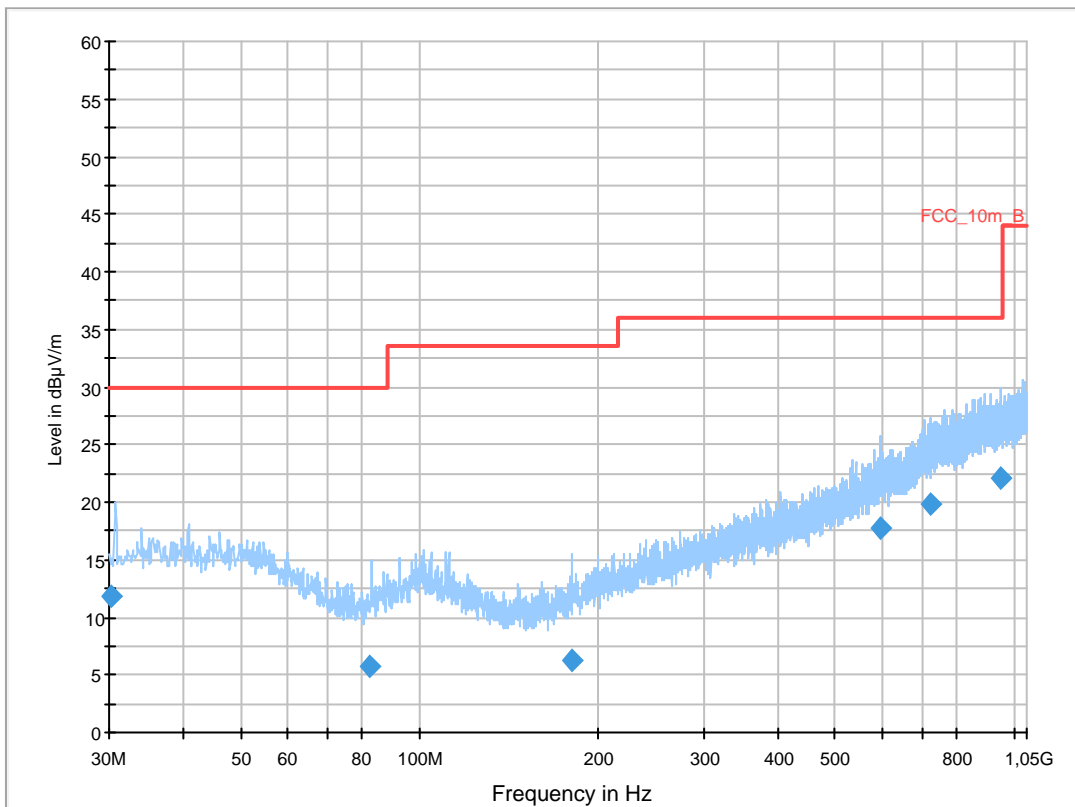

Final Result 1

Frequency (MHz)	QuasiPeak (dBµV/m)	Meas. Time (ms)	Bandwidth (kHz)	Height (cm)	Polarization	Azimuth (deg)	Corr. (dB)	Margin (dB)	Limit (dBµV/m)	Comment
30.238050	11.8	1000.0	120.000	98.0	V	-10.0	12.5	18.2	30.0	
82.616550	5.7	1000.0	120.000	161.0	V	80.0	9.5	24.3	30.0	
180.472350	6.2	1000.0	120.000	170.0	V	273.0	10.5	27.3	33.5	
595.766850	17.7	1000.0	120.000	98.0	V	182.0	20.7	18.3	36.0	
724.944150	19.9	1000.0	120.000	104.0	H	170.0	23.1	16.1	36.0	
947.043450	22.1	1000.0	120.000	112.0	H	2.0	25.3	13.9	36.0	

Plot 6: 1 GHz to 12.75 GHz, mid channel, vertical & horizontal polarization

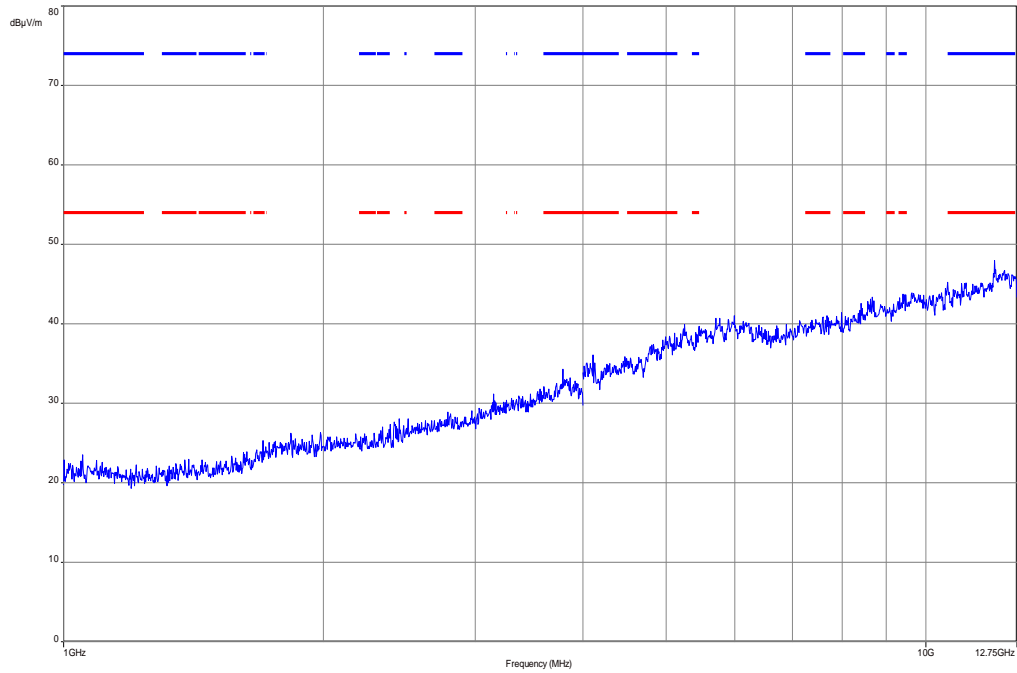

Carrier suppressed with a 2.4 GHz-band rejection filter.

Plot 7: 12.75 GHz to 18 GHz, mid channel, vertical & horizontal polarization

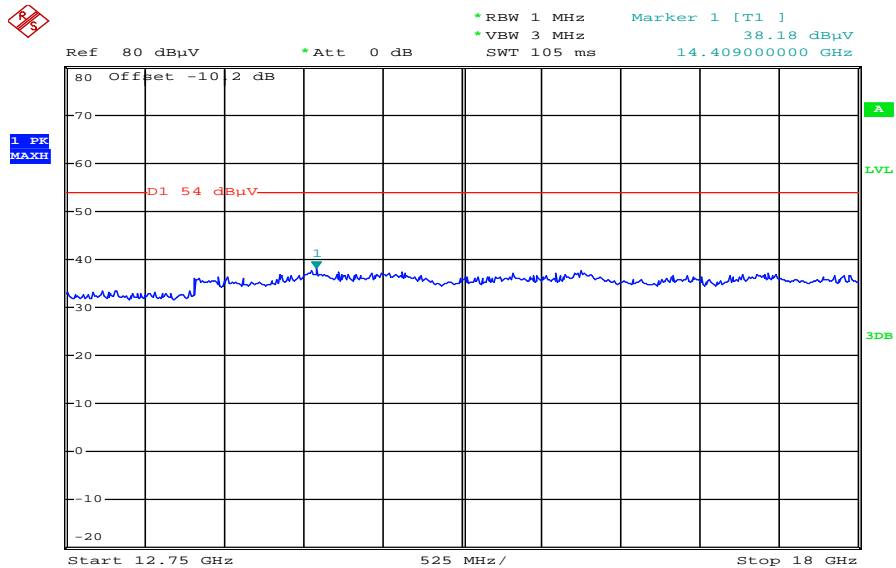

Date: 18.FEB.2013 11:33:02

Plot 8: 18 GHz to 26 GHz, mid channel, vertical & horizontal polarization

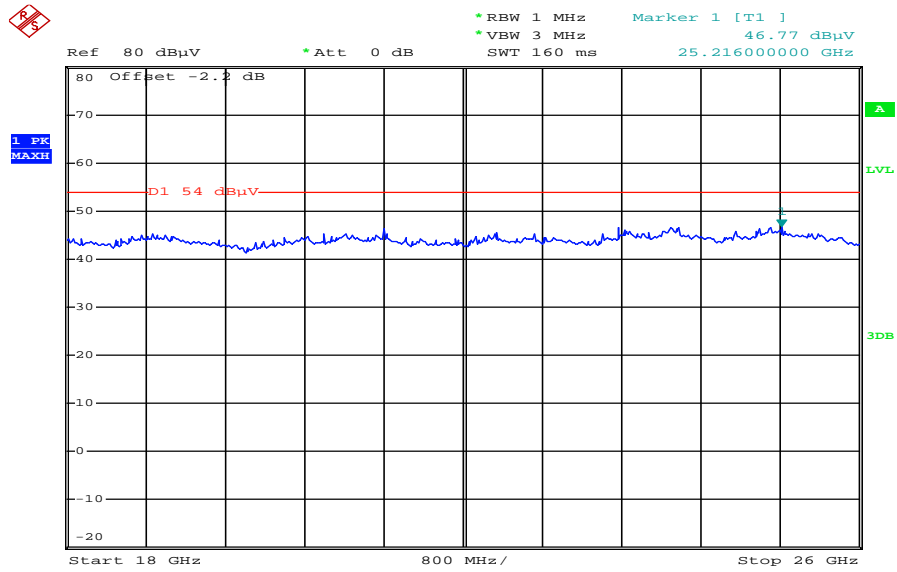

Date: 18.FEB.2013 11:14:14

Plot 9: 30 MHz to 1 GHz, highest channel, vertical & horizontal polarization

Common Information

EUT: PM-0320--BV
 Test Description: FCC part 15 class B @ 10 m
 Operating Conditions: BT LE CH78
 Operator Name: Medrow
 Comment: AC: 115 V / 60 Hz

Scan Setup: STAN_Fin [EMI radiated]

Hardware Setup: Electric Field (NOS)
 Receiver: [ESCI 3]
 Level Unit: dBµV/m

Subrange	Step Size	Detectors	IF BW	Meas. Time	Preamp
30 MHz - 2 GHz	60 kHz	QPK	120 kHz	1 s	20 dB

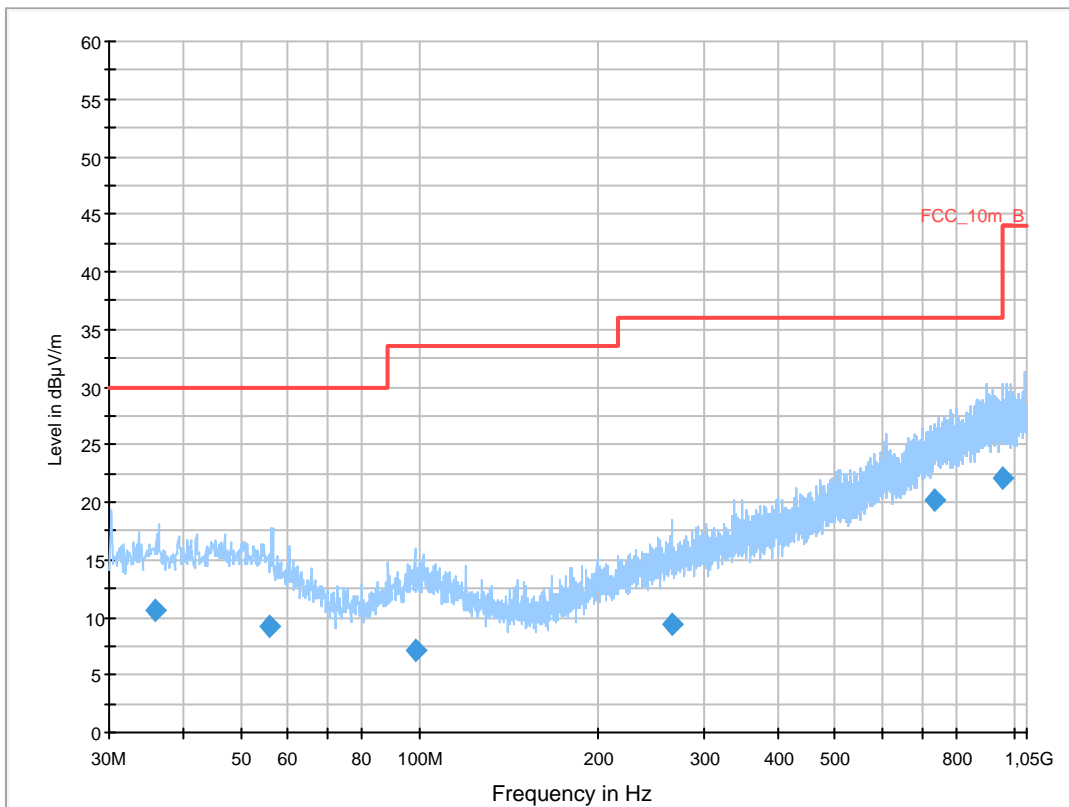

Final Result 1

Frequency (MHz)	QuasiPeak (dBµV/m)	Meas. Time (ms)	Bandwidth (kHz)	Height (cm)	Polarization	Azimuth (deg)	Corr. (dB)	Margin (dB)	Limit (dBµV/m)	Comment
35.855100	10.6	1000.0	120.000	111.0	V	-5.0	13.1	19.4	30.0	
55.817550	9.1	1000.0	120.000	170.0	H	171.0	12.7	20.9	30.0	
98.246700	7.1	1000.0	120.000	170.0	H	190.0	11.7	26.4	33.5	
265.060800	9.5	1000.0	120.000	170.0	V	3.0	13.7	26.5	36.0	
733.892400	20.2	1000.0	120.000	170.0	V	179.0	23.3	15.8	36.0	
958.910400	22.1	1000.0	120.000	170.0	V	190.0	25.4	13.9	36.0	

Plot 10: 1 GHz to 12.75 GHz, highest channel, vertical & horizontal polarization

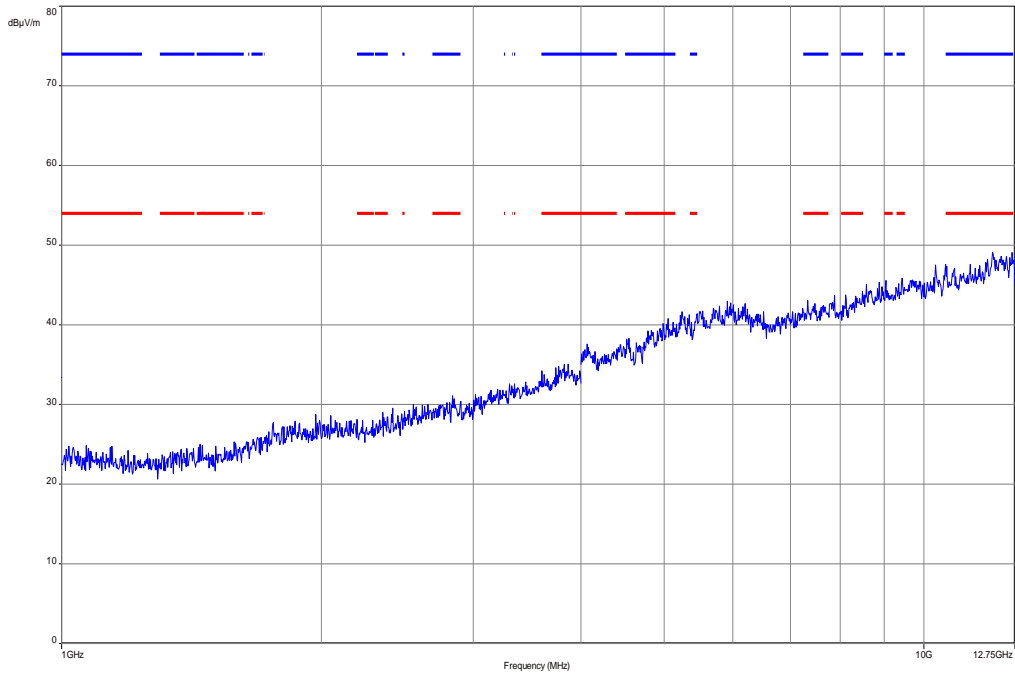

Carrier suppressed with a 2.4 GHz-band rejection filter.

Plot 11: 12.75 GHz to 18 GHz, highest channel, vertical & horizontal polarization

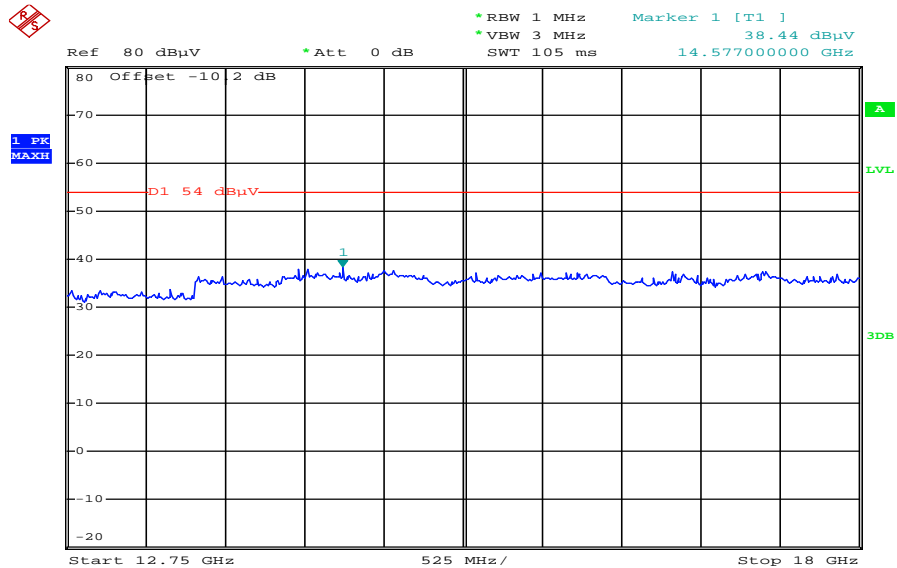

Date: 18.FEB.2013 11:31:40

Plot 12: 18 GHz to 26 GHz, highest channel, vertical & horizontal polarization

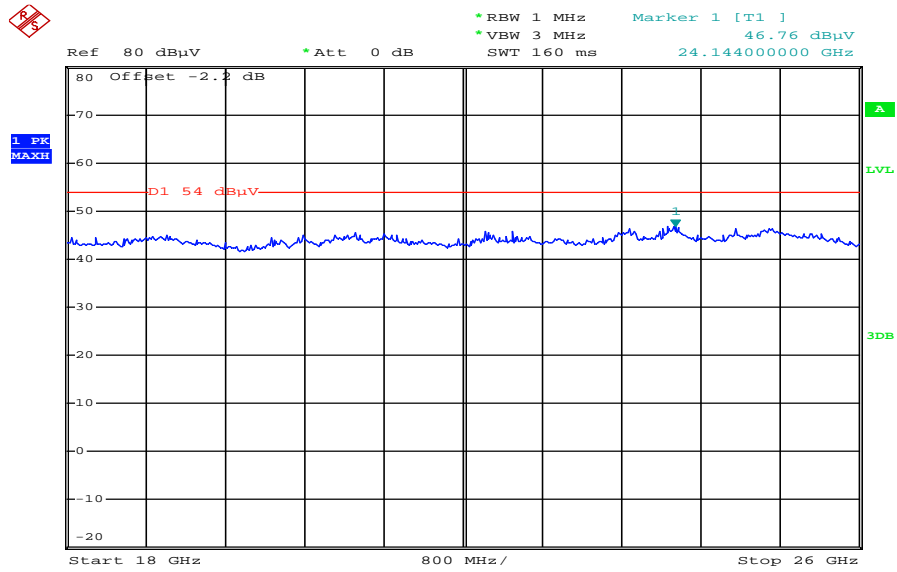

Date: 18.FEB.2013 11:15:13

10.13 RX spurious emissions radiated

Description:

Measurement of the radiated spurious emissions in idle/receive mode. The EUT is detached so all oscillators are active.

Measurement:

Measurement parameter	
Detector:	Peak / Quasi peak
Sweep time:	Auto
Resolution bandwidth:	F < 1 GHz: 100 kHz F > 1 GHz: 1 MHz
Video bandwidth:	Sweep: 100 kHz Remeasurement: 10 Hz
Span:	30 MHz to 25 GHz
Trace-Mode:	Max Hold

Limits:

FCC		IC
RX Spurious Emissions Radiated		
Frequency (MHz)	Field strength (dBµV/m)	Measurement distance
30 - 88	30.0	10
88 – 216	33.5	10
216 – 960	36.0	10
Above 960	54.0	3

Results:

RX spurious emissions radiated [dBµV/m]		
F [MHz]	Detector	Level [dBµV/m]
For emissions below 1 GHz, please take a look at the table below the 1 GHz plot.		
No emissions detected above 1 GHz.		
Measurement uncertainty	±3 dB	

Result: Passed

Plots:

Plot 1: 30 MHz to 1 GHz, RX / idle – mode, vertical & horizontal polarization

Common Information

EUT: PM-0320--BV
 Test Description: FCC part 15 class B @ 10 m
 Operating Conditions: BT LE Rx
 Operator Name: Medrow
 Comment: AC: 115 V / 60 Hz

Scan Setup: STAN_Fin [EMI radiated]

Hardware Setup: Electric Field (NOS)
 Receiver: [ESCI 3]
 Level Unit: dBµV/m

Subrange	Step Size	Detectors	IF BW	Meas. Time	Preamp
30 MHz - 2 GHz	60 kHz	QPK	120 kHz	1 s	20 dB

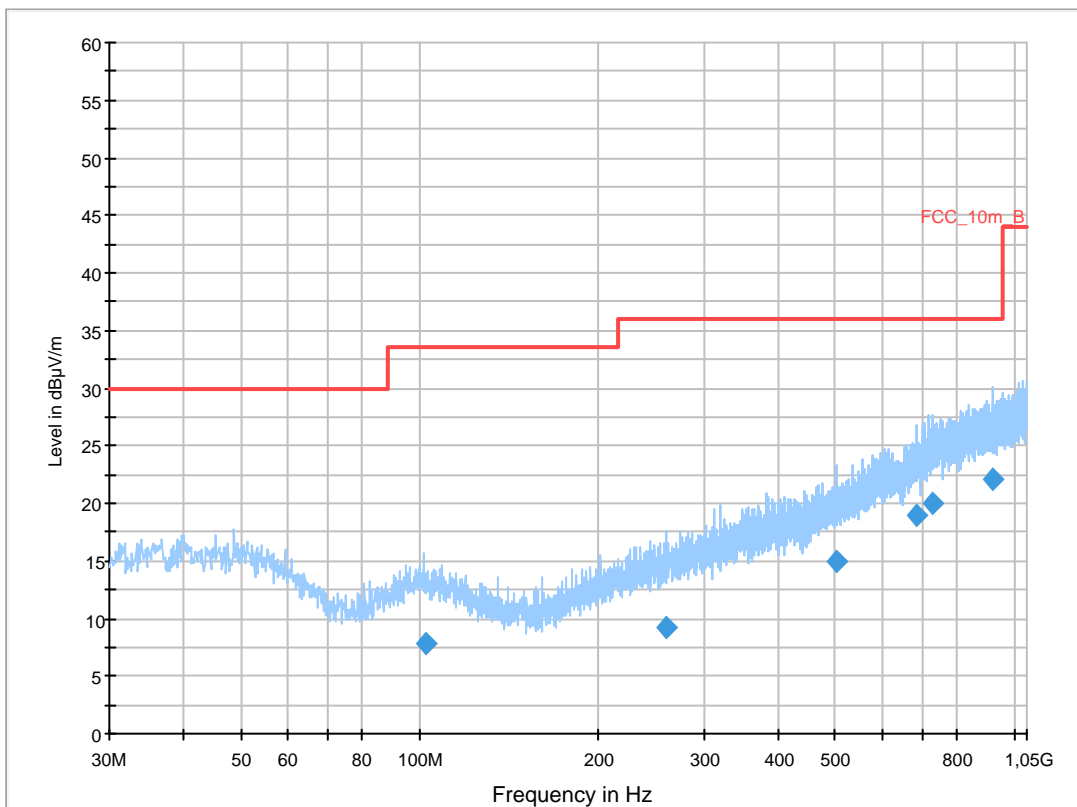

Final Result 1

Frequency (MHz)	QuasiPeak (dBµV/m)	Meas. Time (ms)	Bandwidth (kHz)	Height (cm)	Polarization	Azimuth (deg)	Corr. (dB)	Margin (dB)	Limit (dBµV/m)	Comment
102.241650	7.8	1000.0	120.000	170.0	V	100.0	11.7	25.7	33.5	
259.110900	9.3	1000.0	120.000	170.0	H	90.0	13.5	26.7	36.0	
501.360600	15.0	1000.0	120.000	170.0	H	180.0	18.7	21.0	36.0	
686.577750	19.0	1000.0	120.000	170.0	H	190.0	22.1	17.0	36.0	
729.520950	20.0	1000.0	120.000	170.0	V	80.0	23.2	16.0	36.0	
917.265600	22.0	1000.0	120.000	120.0	H	261.0	25.3	14.0	36.0	

Plot 2: 1 GHz to 12.75 GHz, RX / idle – mode, vertical & horizontal polarization

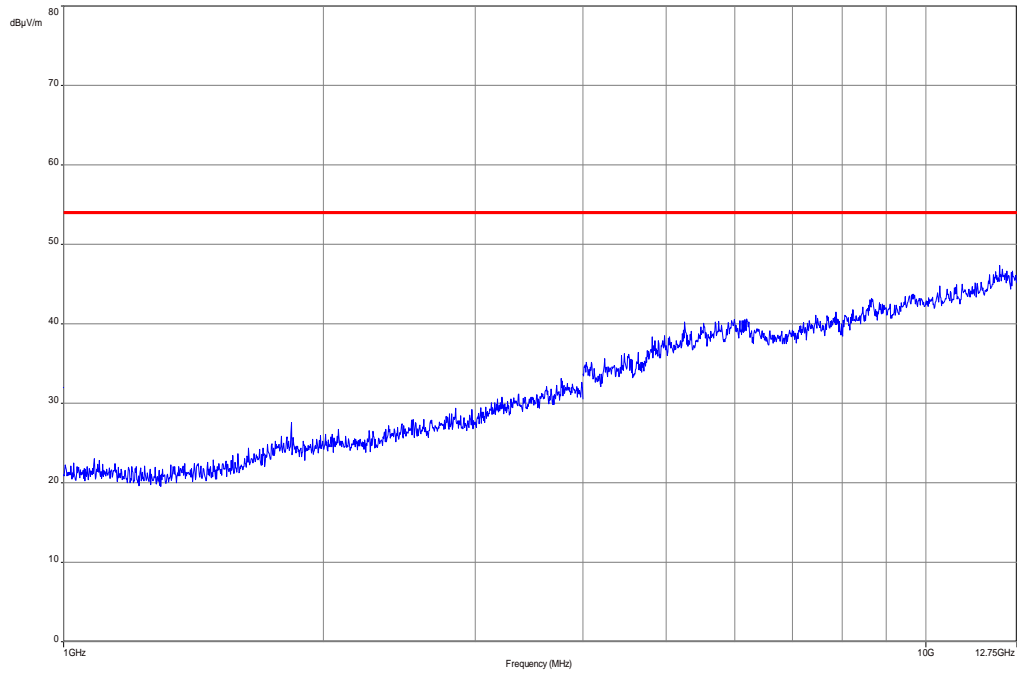

Plot 3: 12.75 GHz to 18 GHz, RX / idle – mode, vertical & horizontal polarization

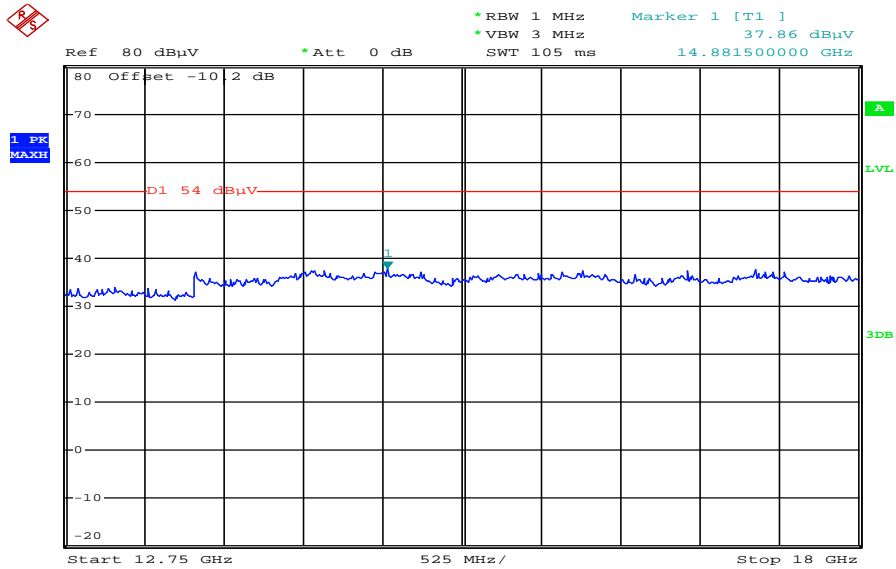

Date: 18.FEB.2013 11:30:34

Plot 4: 18 GHz to 26 GHz, RX / idle – mode, vertical & horizontal polarization

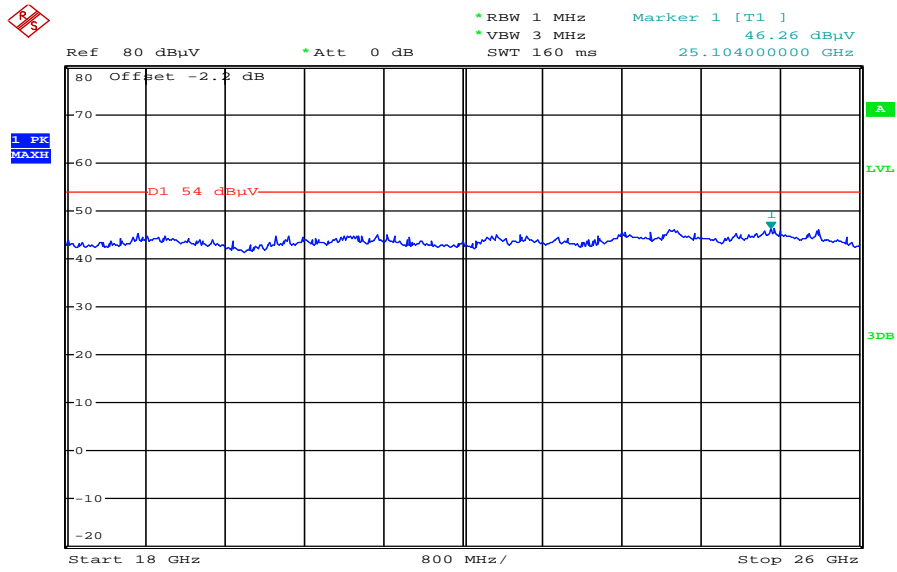

Date: 18.FEB.2013 11:15:39

10.14 Spurious emissions radiated < 30 MHz

Description:

Measurement of the radiated spurious emissions in transmit mode below 30 MHz. The EUT is set to single channel mode and the transmit channel is channel 19. This measurement is representative for all channels and modes. If critical peaks are found channel 00 and channel 39 will be measured too. The measurement is performed in the mode with the highest output power. The limits are recalculated to a measurement distance of 3 m with 40 dB/decade according CFR Part 2.

Measurement:

Measurement parameter	
Detector:	Peak / Quasi peak
Sweep time:	Auto
Resolution bandwidth:	F < 150 kHz: 1 kHz F > 150 kHz: 100 kHz
Video bandwidth:	F < 150 kHz: 200 Hz F > 150 kHz: 9 kHz
Span:	9 kHz to 30 MHz
Trace-Mode:	Max Hold

Limits:

FCC		IC
TX spurious emissions radiated < 30 MHz		
Frequency (MHz)	Field strength (dBµV/m)	Measurement distance
0.009 – 0.490	2400/F(kHz)	300
0.490 – 1.705	24000/F(kHz)	30
1.705 – 30.0	30	30

Results:

TX spurious emissions radiated < 30 MHz [dBµV/m]		
F [MHz]	Detector	Level [dBµV/m]
No critical peaks found!		
Measurement uncertainty	± 3 dB	

Result: Passed

Plot:

Plot 1: 9 kHz to 30 MHz, TX mode

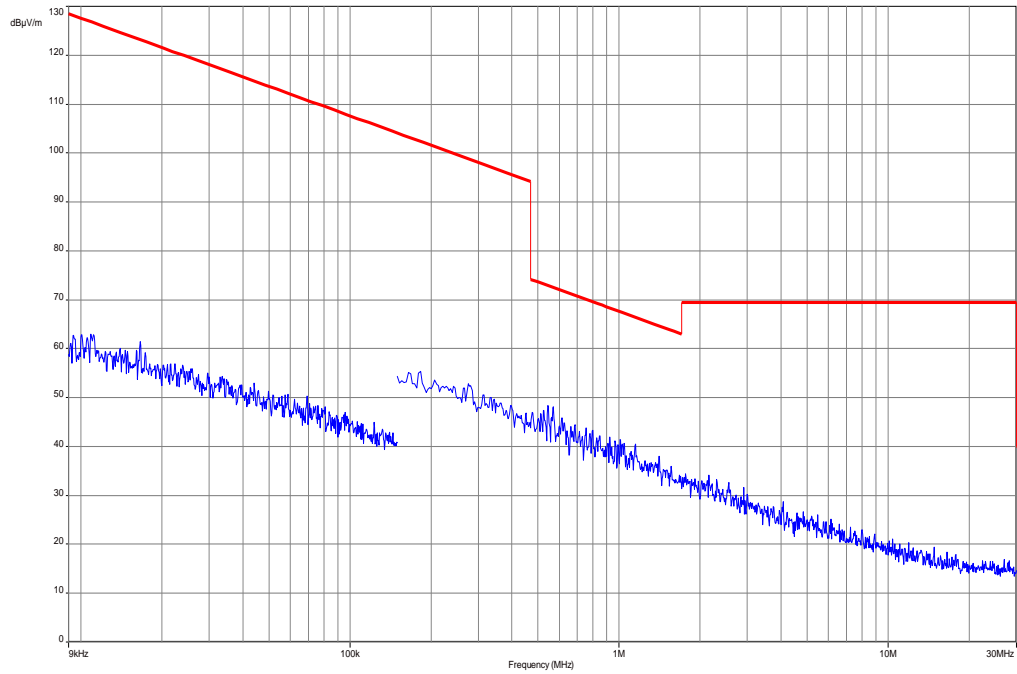

Plot 2: 9 kHz to 30 MHz, RX mode

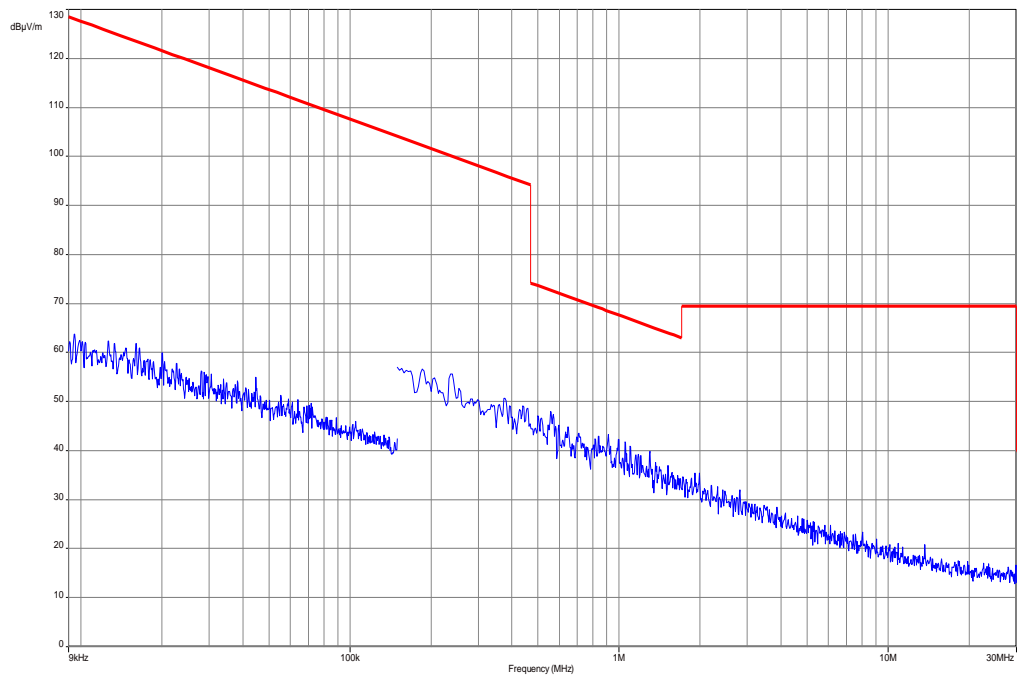

10.15 Spurious emissions conducted < 30 MHz

Description:

Measurement of the conducted spurious emissions in transmit mode below 30 MHz. The EUT is set to single channel mode and the transmit channel is channel 19. This measurement is representative for all channels and modes. If critical peaks are found channel 00 and channel 39 will be measured too. The measurement is performed in the mode with the highest output power. Both power lines, phase and neutral line, are measured. Found peaks are remeasured with average and quasi peak detection to show compliance to the limits.

Measurement:

Measurement parameter	
Detector:	Peak / Quasi peak / average
Sweep time:	Auto
Resolution bandwidth:	F < 150 kHz: 1 kHz F > 150 kHz: 100 kHz
Video bandwidth:	F < 150 kHz: 200 Hz F > 150 kHz: 9 kHz
Span:	9 kHz to 30 MHz
Trace-Mode:	Max Hold

Limits:

FCC	IC	
TX spurious emissions conducted < 30 MHz		
Frequency (MHz)	Quasi-peak (dBµV/m)	Average (dBµV/m)
0.15 – 0.5	66 to 56*	56 to 46*
0.5 – 5	56	46
5 – 30.0	60	50

*Decreases with the logarithm of the frequency

Results:

TX spurious emissions conducted < 30 MHz [dBµV/m]		
F [MHz]	Detector	Level [dBµV/m]
No peaks found!		
Measurement uncertainty	± 3 dB	

Result: Passed

Plots:

Plot 1: 150 kHz to 30 MHz, TX mode, phase line

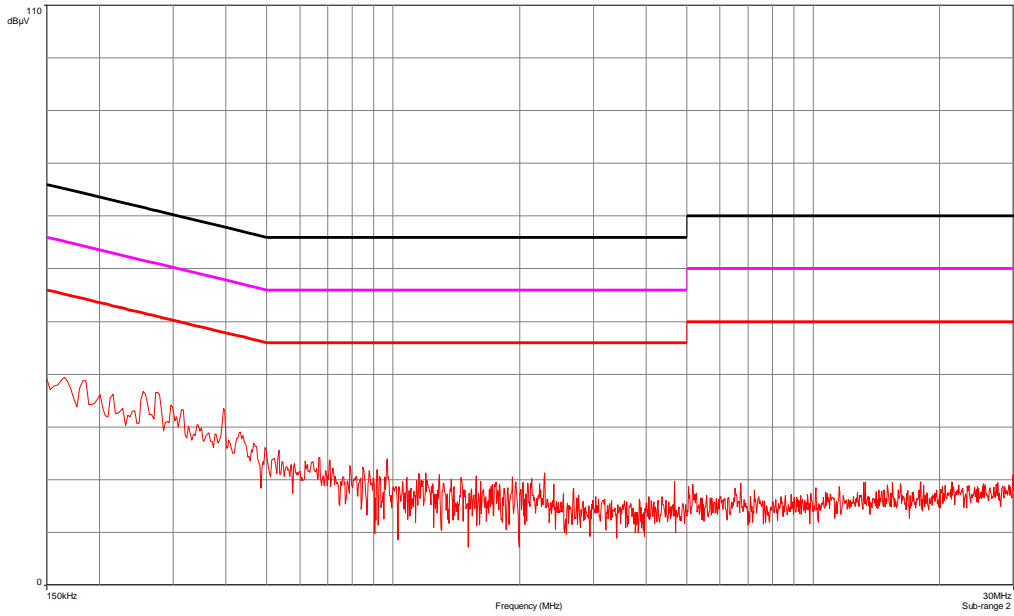

Plot 2: 150 kHz to 30 MHz, TX mode, neutral line

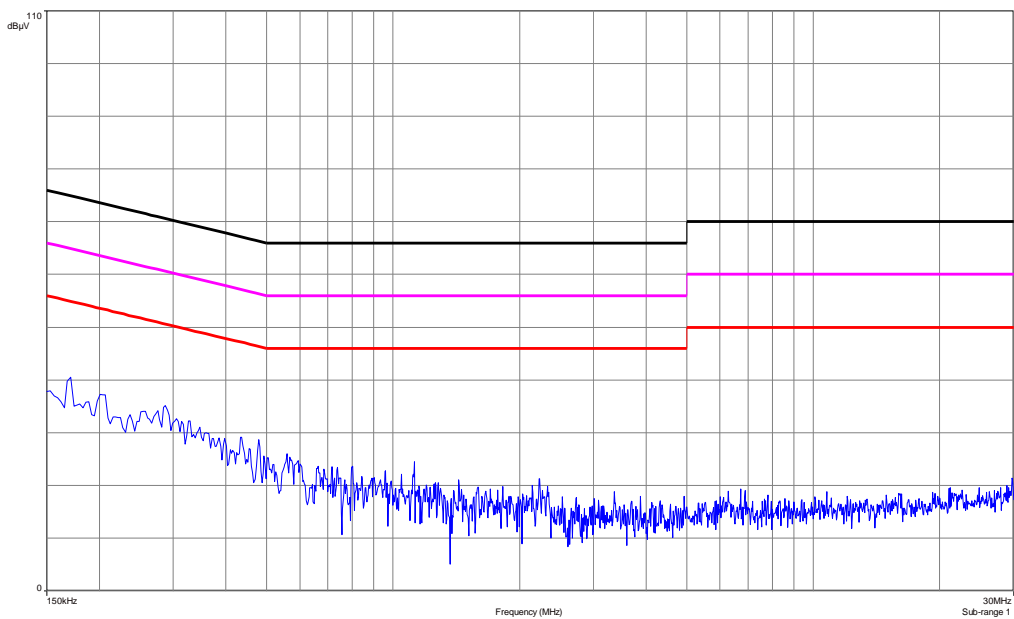

Plot 3: 150 kHz to 30 MHz, RX mode, phase line

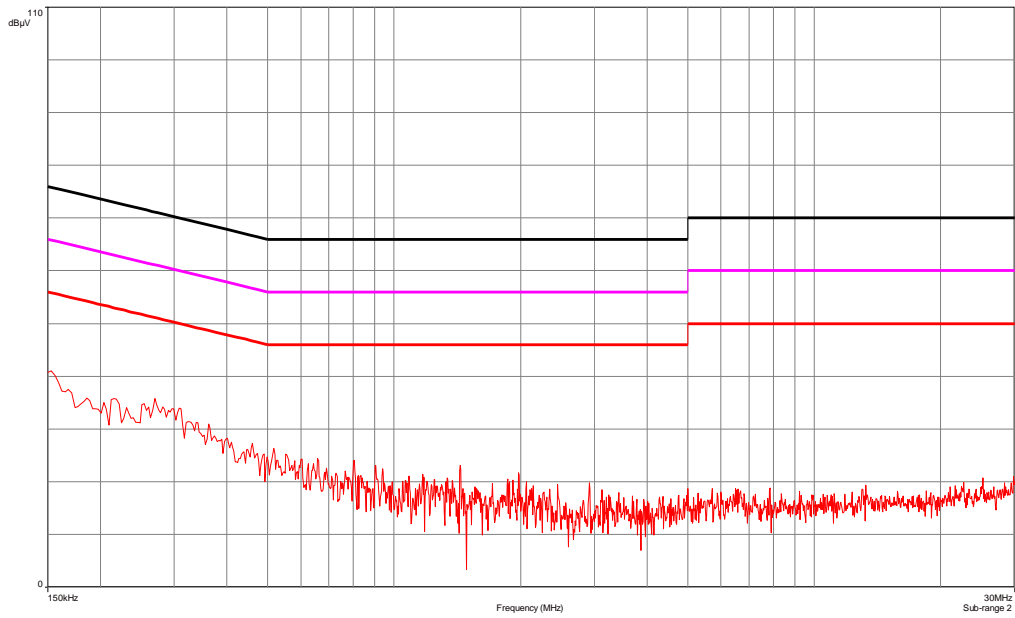

Plot 4: 150 kHz to 30 MHz, RX mode, neutral line

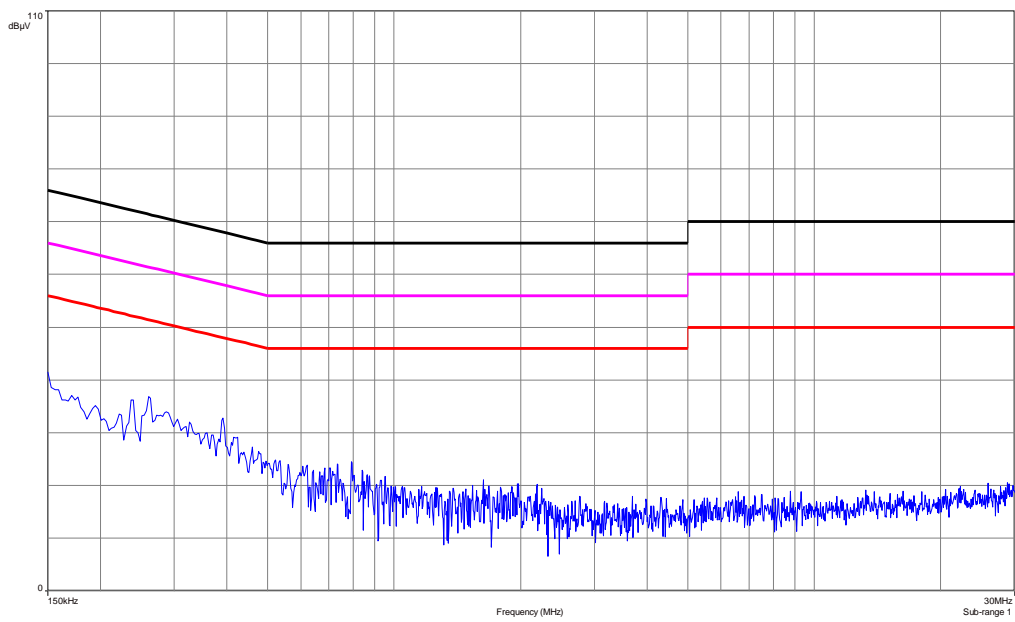

11 Test equipment and ancillaries used for tests

Typically, the calibrations of the test apparatus are commissioned to and performed by an accredited calibration laboratory. The calibration intervals are determined in accordance with the DIN EN ISO/IEC 17025. In addition to the external calibrations, the laboratory executes comparison measurements with other calibrated test systems or effective verifications. Weekly chamber inspections and range calibrations are performed. Where possible, rf-generating and signalling equipment as well as measuring receivers and analyzers are connected to an external high-precision 10 MHz reference (GPS-based or rubidium frequency standard).

In order to simplify the identification of the equipment used at some special tests, some items of test equipment and ancillaries can be provided with an identifier or number in the equipment list below (Labor/Item).

No.	Lab / Item	Equipment	Type	Manufact.	Serial No.	INV. No Cetecom	Kind of Calibration	Last Calibration	Next Calibration
1	45	Switch-Unit	3488A	HP Meßtechnik	2719A14505	300000368	g		
2	50	DC power supply, 60Vdc, 50A, 1200 W	6032A	HP Meßtechnik	2920A04466	300000580	ne		
3	n. a.	software	SPS_PHE 1.4f	Spitzberger & Spieß	B5981; 5D1081;B597 9	300000210	ne		
4	n. a.	EMI Test Receiver	ESCI 1166.5950. 03	R&S	100083	300003312	k	09.01.2013	09.01.2014
5	n. a.	Analyzer- Reference- System (Harmonics and Flicker)	ARS 16/1	SPS	A3509 07/0 0205	300003314	k	14.07.2011	14.07.2013
6	n. a.	Amplifier	JS42- 00502650- 28-5A	MITEQ	1084532	300003379	ev		
7	n. a.	Antenna Tower	Model 2175	ETS- LINDGREN	64762	300003745	izw		
8	n. a.	Positioning Controller	Model 2090	ETS- LINDGREN	64672	300003746	izw		
9	n. a.	Turntable Interface-Box	Model 105637	ETS- LINDGREN	44583	300003747	izw		
10	n. a.	TRILOG Broadband Test-Antenna 30 MHz - 3 GHz	VULB9163	Schwarzbe ck	295	300003787	k	12.04.2012	12.04.2014
11	n. a.	Spectrum- Analyzer	FSU26	R&S	200809	300003874	k	16.01.2013	16.01.2015
12	n. a.	DC power supply, 60Vdc, 50A, 1200 W	6032A	HP Meßtechnik	2818A03450	300001040	Ve	12.01.2012	12.01.2015
13	n. a.	Double-Ridged Waveguide Horn Antenna 1-18.0GHz	3115	EMCO	8812-3088	300001032	vIKI!	11.05.2011	11.05.2013
14	n. a.	Active Loop Antenna	6502	EMCO	2210	300001015	ne		
15	n. a.	Anechoic chamber	FAC 3/5m	MWB / TDK	87400/02	300000996	ev		
16	n. a.	Switch / Control Unit	3488A	HP Meßtechnik	*	300000199	ne		
17	n. a.	Switch / Control Unit	3488A	HP Meßtechnik	2719A15013	300001156	ne		
18	9	Isolating Transformer	MPL IEC625 Bus Regeltrennt ravo	Erfi	91350	300001155	ne		
19	n. a.	Three-Way Power Splitter, 50 Ohm	11850C	HP Meßtechnik		300000997	ne		
20	n. a.	Amplifier	js42- 00502650- 28-5a	Parzich GMBH	928979	300003143	ne		
21	n. a.	Band Reject filter	WRCG240 0/2483- 2375/2505- 50/10SS	Wainwright	11	300003351	ev		
22	n. a.	TRILOG Broadband	VULB9163	Schwarzbe ck	371	300003854	vIKI!	14.10.2011	14.10.2014

		Test-Antenna 30 MHz - 3 GHz							
23	n. a.	MXE EMI Receiver 20 Hz bis 26,5 GHz	N9038A	Agilent Technologi es	MY51210197	300004405	k		
24	11b	Microwave System Amplifier, 0.5- 26.5 GHz	83017A	HP Meßtechnik	00419	300002268	ev		
25	A025	Std. Gain Horn Antenna 12.4 to 18.0 GHz	639	Narda		300000786	ne		
26	A028	Std. Gain Horn Antenna 18.0 to 26.5 GHz	638	Narda		300002440	ne		
27	n. a.	Spectrum Analyzer 9kHz to 30GHz - 140..+30dBm	FSP30	R&S	100886	300003575	k	22.08.2012	22.08.2014
28	n. a.	Switch / Control Unit	3488A	HP Meßtechnik		300001691	ne		
29	n. a.	Power Supply DC	NGPE 40/40	R&S	388	400000078	vlk!	21.08.2012	21.08.2014
30	n. a.	Signal Analyzer 20Hz-26,5GHz- 150 to + 30 DBM	FSIQ26	R&S	835540/018	300002681- 0005	k	01.02.2012	01.02.2014
31	n. a.	Frequency Standard (Rubidium Frequency Standard)	MFS (Rubidium)	R&S (Datum)	002	300002681- 0009	Ve	21.08.2012	21.08.2014
32	n. a.	Directional Coupler	101020010	Krytar	70215	300002840	ev		
33	n. a.	DC-Blocker	8143	Inmet Corp.	none	300002842	ne		
34	n. a.	Powersplitter	6005-3	Inmet Corp.		300002841	ev		

Agenda: Kind of Calibration

k	calibration / calibrated	EK	limited calibration
ne	not required (k, ev, izw, zw not required)	zw	cyclical maintenance (external cyclical maintenance)
ev	periodic self verification	izw	internal cyclical maintenance
Ve	long-term stability recognized	g	blocked for accredited testing
vlk!	Attention: extended calibration interval	*)	next calibration ordered / currently in progress
NK!	Attention: not calibrated		

12 Observations

No observations exceeding those reported with the single test cases have been made.

Annex A Document history

Version	Applied changes	Date of release
1.0	Initial release	2013-02-20
-A	Update to new DTS guideline from April 2013	2013-04-30

Annex B Further information**Glossary**

AVG	-	Average
DUT	-	Device under test
EMC	-	Electromagnetic Compatibility
EN	-	European Standard
EUT	-	Equipment under test
ETSI	-	European Telecommunications Standard Institute
FCC	-	Federal Communication Commission
FCC ID	-	Company Identifier at FCC
HW	-	Hardware
IC	-	Industry Canada
Inv. No.	-	Inventory number
N/A	-	Not applicable
PP	-	Positive peak
QP	-	Quasi peak
S/N	-	Serial number
SW	-	Software

Annex C Accreditation Certificate

Front side of certificate



Deutsche Akkreditierungsstelle GmbH

Befehlens gemäß § 8 Absatz 1 AkkStelleG i.V.m. § 1 Absatz 1 AkkStelleGBV
 Unterzeichnerin der Multilateralen Abkommen
 von EA, ILAC und IAF zur gegenseitigen Anerkennung

Akkreditierung



Die Deutsche Akkreditierungsstelle GmbH bestätigt hiermit, dass das Prüflaboratorium

CETECOM ICT Services GmbH
 Untertürkheimer Straße 6-10, 66117 Saarbrücken

die Kompetenz nach DIN EN ISO/IEC 17025:2005 besitzt, Prüfungen in folgenden Bereichen durchzuführen:

- Drahtgebundene Kommunikation einschließlich xDSL
- VoIP und DECT
- Akustik
- Funk einschließlich WLAN
- Short Range Devices (SRD)
- RFID
- WiMax und Richtfunk
- Mobilfunk (GSM / GPRS, Over the Air (OTA) Performance)
- Elektromagnetische Verträglichkeit (EMV) einschließlich Automotive
- Produktsicherheit
- SAR und Hearing Aid Compatibility (HAC)
- Umweltsimulation
- Smart Card Terminals
- Bluetooth
- Wi-Fi Services

Die Akkreditierungsurkunde gilt nur in Verbindung mit dem Bescheid vom 18.01.2013 mit der Akkreditierungsnummer D-PL-12076-01 und ist gültig 17.01.2018. Sie besteht aus diesem Deckblatt, der Rückseite des Deckblatts und der folgenden Anlage mit insgesamt 80 Seiten.

Registrierungsnummer der Urkunde: D-PL-12076-01-01

Frankfurt am Main, 18.01.2013
 Seite 1/1 von 1 der Rückseite

Im Auftrag
 Dr. Ingrid (FH) Hoff-Egner
 Abteilungsleiter

Back side of certificate

Deutsche Akkreditierungsstelle GmbH

Standort Berlin
 Spittelmarkt 10
 10117 Berlin

Standort Frankfurt am Main
 Gartenstraße 6
 60594 Frankfurt am Main

Standort Braunschweig
 Rundesallee 100
 38116 Braunschweig

Die auszugsweise Veröffentlichung der Akkreditierungsurkunde bedarf der vorherigen schriftlichen Zustimmung der Deutsche Akkreditierungsstelle GmbH (DAkkS). Ausgenommen davon ist die separate Weiterverarbeitung des Deckblatts durch die umseitig genannte Konformitätsbewertungsstelle in unveränderter Form.

Es darf nicht der Anschein erweckt werden, dass sich die Akkreditierung auch auf Bereiche erstreckt, die über den durch die DAkkS bestätigten Akkreditierungsbereich hinausgehen.

Die Akkreditierung erfolgte gemäß des Gesetzes über die Akkreditierungsstelle (AkkStelleG) vom 31. Juli 2009 (BGBl. I S. 2625) sowie der Verordnung (EG) Nr. 765/2008 des Europäischen Parlaments und des Rates vom 9. Juli 2008 über die Vorschriften für die Akkreditierung und Marktüberwachung im Zusammenhang mit der Vermarktung von Produkten (Abi. L 218 vom 9. Juli 2008, S. 30). Die DAkkS ist Unterzeichnerin der Multilateralen Abkommen zur gegenseitigen Anerkennung der European co-operation for Accreditation (EA), des International Accreditation Forum (IAF) und der International Laboratory Accreditation Cooperation (ILAC). Die Unterzeichner dieser Abkommen erkennen ihre Akkreditierungen gegenseitig an.

Der aktuelle Stand der Mitgliedschaft kann folgenden Webseiten entnommen werden:
 EA: www.european-accreditation.org
 ILAC: www.ilac.org
 IAF: www.iaf.nu

Note:

The current certificate including annex is published on our website (see link below) or may be received from CETECOM ICT Services on request.

<http://www.cetecom.com/eu/de/cetecom-group/europa/deutschland-saarbruecken/akkreditierungen.html>