

TEST REPORT

Test report no.: 1-5831/13-05-04



Testing laboratory

CETECOM ICT Services GmbH
Untertuerkheimer Strasse 6 – 10
66117 Saarbruecken / Germany
Phone: + 49 681 5 98 - 0
Fax: + 49 681 5 98 - 9075
Internet: <http://www.cetecom.com>
e-mail: ict@cetecom.com

Accredited Testing Laboratory:

The testing laboratory (area of testing) is accredited according to DIN EN ISO/IEC 17025 (2005) by the Deutsche Akkreditierungsstelle GmbH (DAkkS). The accreditation is valid for the scope of testing procedures as stated in the accreditation certificate with the registration number: D-PL-12076-01-01
Area of Testing: Radio/Satellite Communications

Applicant

Sony Mobile Communications AB
Nya Vattentornet
22188 Lund / SWEDEN
Phone: +46 46 19 30 00
Fax: +46 46 19 32 95
Contact: Håkan Sjöberg
e-mail: hakan.sjoberg@sonymobile.com
Phone: +46 46 19 35 59

Manufacturer

CETECOM GmbH
Im Teelbruch 116
45219 Essen / GERMANY

Test standard/s

47 CFR Part 15 Title 47 of the Code of Federal Regulations; Chapter I
Part 15 - Radio frequency devices

For further applied test standards please refer to section 3 of this test report.

Test Item

Kind of test item: Mobile Phone GPRS/EGPRS 850/900/1800/1900; UMTS HSPA FDDI/V/VI/XIX; LTE FDD1/19/21; WLAN a/b/g/n; BT 3.1; RFID; FM Rx; A-GPS
Model name: PM-0320-BV
FCC ID: PY7PM-0320
IC: -/-
Frequency: ISM band 2400 MHz to 2483.5 MHz
(lowest channel 00 – 2402 MHz; highest channel 78 – 2480 MHz)
Technology tested: Bluetooth®, +EDR
Antenna: Integrated PCB antenna
Power Supply: 3.7V DC by Li - Ion battery
Temperature Range: -20°C to +55°C

This test report is electronically signed and valid without handwriting signature. For verification of the electronic signatures, the public keys can be requested at the testing laboratory.

Test report authorised:



Stefan Bös
Senior Testing Manager

Test performed:

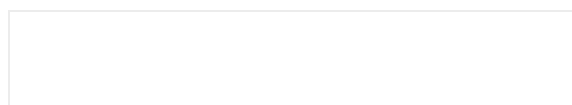

Marco Bertolino
Testing Manager

| | |
|----------------------------|---|
| 1 Table of contents | |
| 1 | Table of contents2 |
| 2 | General information3 |
| 2.1 | Notes and disclaimer3 |
| 2.2 | Application details.....3 |
| 3 | Test standard/s3 |
| 4 | Test environment.....4 |
| 5 | Test item4 |
| 5.1 | Additional information4 |
| 6 | Test laboratories sub-contracted4 |
| 7 | Summary of measurement results5 |
| 8 | RF measurements6 |
| 8.1 | Description of test setup6 |
| 8.1.1 | Radiated measurements.....6 |
| 8.1.2 | Conducted measurements.....7 |
| 8.2 | Additional comments7 |
| 9 | Measurement results.....8 |
| 9.1 | Antenna gain.....8 |
| 9.2 | Power spectral density9 |
| 9.3 | Carrier frequency separation10 |
| 9.4 | Number of hopping channels.....12 |
| 9.5 | Time of occupancy (dwell time)14 |
| 9.6 | Spectrum bandwidth of a FHSS system – 20 dB bandwidth15 |
| 9.7 | Maximum output power21 |
| 9.8 | Band edge compliance conducted28 |
| 9.9 | Band edge compliance radiated35 |
| 9.10 | TX spurious emissions conducted39 |
| 9.11 | TX spurious emissions radiated47 |
| 9.12 | RX spurious emissions radiated58 |
| 9.13 | Spurious emissions radiated < 30 MHz62 |
| 9.14 | Spurious emissions conducted < 30 MHz.....64 |
| 10 | Test equipment and ancillaries used for tests.....67 |
| 11 | Observations68 |
| Annex A | Document history69 |
| Annex B | Further information.....69 |
| Annex C | Accreditation Certificate70 |

2 General information

2.1 Notes and disclaimer

The test results of this test report relate exclusively to the test item specified in this test report. CETECOM ICT Services GmbH does not assume responsibility for any conclusions and generalizations drawn from the test results with regard to other specimens or samples of the type of the equipment represented by the test item.

The test report may only be reproduced or published in full. Reproduction or publication of extracts from the report requires the prior written approval of CETECOM ICT Services GmbH.

The testing service provided by CETECOM ICT Services GmbH has been rendered under the current "General Terms and Conditions for CETECOM ICT Services GmbH".

CETECOM ICT Services GmbH will not be liable for any loss or damage resulting from false, inaccurate, inappropriate or incomplete product information provided by the customer.

Under no circumstances does the CETECOM ICT Services GmbH test report include any endorsement or warranty regarding the functionality, quality or performance of any other product or service provided.

Under no circumstances does the CETECOM ICT Services GmbH test report include or imply any product or service warranties from CETECOM ICT Services GmbH, including, without limitation, any implied warranties of merchantability, fitness for purpose, or non-infringement, all of which are expressly disclaimed by CETECOM ICT Services GmbH.

All rights and remedies regarding vendor's products and services for which CETECOM ICT Services GmbH has prepared this test report shall be provided by the party offering such products or services and not by CETECOM ICT Services GmbH.

In no case this test report can be considered as a Letter of Approval.

2.2 Application details

| | |
|------------------------------------|------------|
| Date of receipt of order: | 2013-01-15 |
| Date of receipt of test item: | 2013-02-12 |
| Start of test: | 2013-02-13 |
| End of test: | 2013-02-15 |
| Person(s) present during the test: | -/- |

3 Test standard/s

| Test standard | Date | Test standard description |
|----------------|---------|--|
| 47 CFR Part 15 | 2010-10 | Title 47 of the Code of Federal Regulations; Chapter I Part 15 - Radio frequency devices |

4 Test environment

| | | |
|----------------------------|-----------|---------------------------------------|
| Temperature: | T_{nom} | +22 °C during room temperature tests |
| | T_{max} | +55 °C during high temperature tests |
| | T_{min} | -20 °C during low temperature tests |
| Relative humidity content: | | 42 % |
| Barometric pressure: | | not relevant for this kind of testing |
| Power supply: | V_{nom} | 3.7 V DC by Li - Ion battery |
| | V_{max} | 4.1 V |
| | V_{min} | 3.3 V |

5 Test item

| | | |
|----------------------------|---|--|
| Kind of test item | : | Mobile Phone GPRS/EGPRS 850/900/1800/1900; UMTS HSPA FDDI/V/VI/XIX; LTE FDD1/19/21; WLAN a/b/g/n; BT 3.1; RFID; FM Rx; A-GPS |
| Type identification | : | PM-0320-BV |
| S/N serial number | : | Radiated units: CB5A1NUBNB; CB5A1NUBN5 Conducted units: CB5A1NUBPM; CB5A1NUBP4 |
| HW hardware status | : | AP1 |
| SW software status | : | atp_dogo_dcm_0_0_36_0_d |
| Frequency band [MHz] | : | ISM band 2400 MHz to 2483.5 MHz (lowest channel 00 – 2402 MHz; highest channel 78 – 2480 MHz) |
| Type of radio transmission | : | FHSS |
| Use of frequency spectrum | : | |
| Type of modulation | : | GFSK, Pi/4 DQPSK and 8 DPSK |
| Number of channels | : | 79 |
| Antenna | : | Integrated PCB antenna |
| Power supply | : | 3.7 V DC by Li - Ion battery |
| Temperature range | : | -20°C to +55 °C |

5.1 Additional information

Test setup - and EUT - photos are included in the following test reports:

External EUT photos: 1-5831/13-05-01_AnnexA
 Internal EUT photos: 1-5831/13-05-01_AnnexB
 Test setup: 1-5831/13-05-01_AnnexD

6 Test laboratories sub-contracted

None

7 Summary of measurement results

- No deviations from the technical specifications were ascertained
- There were deviations from the technical specifications ascertained

| TC Identifier | Description | Verdict | Date | Remark |
|---------------|--|---------|------------|--------|
| RF-Testing | CFR Part 15 RSS 210, Issue 8, Annex 8 | Passed | 2013-02-20 | -/- |

| Test specification clause | Test case | Temperature conditions | Power source voltages | Mode | Pass | Fail | NA | NP | Remark |
|---|---|------------------------|-----------------------|------------------------------|---|--|--|--|--------------------------|
| §15.247(b)(4) RSS 210 / A8.4(2) | Antenna gain | Nominal | Nominal | GFSK | <input checked="" type="checkbox"/> | <input type="checkbox"/> | <input type="checkbox"/> | <input type="checkbox"/> | complies |
| §15.247(e) RSS 210 / A8.2(b) | Power spectral density | Nominal | Nominal | GFSK Pi/4 DQPSK 8 DPSK | <input type="checkbox"/> | <input type="checkbox"/> | <input checked="" type="checkbox"/> | <input type="checkbox"/> | Not applicable for FHSS! |
| §15.247(a)(1) RSS 210 / A8.1(b) | Carrier frequency separation | Nominal | Nominal | GFSK | <input checked="" type="checkbox"/> | <input type="checkbox"/> | <input type="checkbox"/> | <input type="checkbox"/> | complies |
| §15.247(a)(1) RSS 210 / A8.1(d) | Number of hopping channels | Nominal | Nominal | GFSK | <input checked="" type="checkbox"/> | <input type="checkbox"/> | <input type="checkbox"/> | <input type="checkbox"/> | complies |
| §15.247(a)(1) (iii) RSS 210 / A8.3(1) | Time of occupancy (dwell time) | Nominal | Nominal | GFSK Pi/4 DQPSK 8 DPSK | <input checked="" type="checkbox"/> | <input type="checkbox"/> | <input type="checkbox"/> | <input type="checkbox"/> | complies |
| §15.247(a)(1) RSS 210 / A8.2(a) | Spectrum bandwidth of a FHSS system 20dB bandwidth | Nominal | Nominal | GFSK Pi/4 DQPSK 8 DPSK | <input checked="" type="checkbox"/> <input checked="" type="checkbox"/> <input checked="" type="checkbox"/> | <input type="checkbox"/> <input type="checkbox"/> <input type="checkbox"/> | <input type="checkbox"/> <input type="checkbox"/> <input type="checkbox"/> | <input type="checkbox"/> <input type="checkbox"/> <input type="checkbox"/> | complies |
| §15.247(b)(1) RSS-210 / A8.4(2) | Maximum output power | Nominal | Nominal | GFSK Pi/4 DQPSK 8 DPSK | <input checked="" type="checkbox"/> <input checked="" type="checkbox"/> <input checked="" type="checkbox"/> | <input type="checkbox"/> <input type="checkbox"/> <input type="checkbox"/> | <input type="checkbox"/> <input type="checkbox"/> <input type="checkbox"/> | <input type="checkbox"/> <input type="checkbox"/> <input type="checkbox"/> | complies |
| §15.247(d) RSS-210 / A8.5 | Band edge compliance conducted | Nominal | Nominal | GFSK Pi/4 DQPSK 8 DPSK | <input checked="" type="checkbox"/> <input checked="" type="checkbox"/> <input checked="" type="checkbox"/> | <input type="checkbox"/> <input type="checkbox"/> <input type="checkbox"/> | <input type="checkbox"/> <input type="checkbox"/> <input type="checkbox"/> | <input type="checkbox"/> <input type="checkbox"/> <input type="checkbox"/> | complies |
| §15.205 RSS-210 / A8.5 | Band edge compliance radiated | Nominal | Nominal | GFSK Pi/4 DQPSK 8 DPSK | <input checked="" type="checkbox"/> <input checked="" type="checkbox"/> <input checked="" type="checkbox"/> | <input type="checkbox"/> <input type="checkbox"/> <input type="checkbox"/> | <input type="checkbox"/> <input type="checkbox"/> <input type="checkbox"/> | <input type="checkbox"/> <input type="checkbox"/> <input type="checkbox"/> | complies |
| §15.247(d) RSS-210 / A8.5 | TX spurious emissions conducted | Nominal | Nominal | GFSK Pi/4 DQPSK 8 DPSK | <input checked="" type="checkbox"/> <input checked="" type="checkbox"/> <input checked="" type="checkbox"/> | <input type="checkbox"/> <input type="checkbox"/> <input type="checkbox"/> | <input type="checkbox"/> <input type="checkbox"/> <input type="checkbox"/> | <input type="checkbox"/> <input type="checkbox"/> <input type="checkbox"/> | complies |
| §15.247(d) RSS-210 / A8.5 | TX spurious emissions radiated | Nominal | Nominal | 8 DPSK | <input checked="" type="checkbox"/> | <input type="checkbox"/> | <input type="checkbox"/> | <input type="checkbox"/> | complies |
| §15.109 RSS-Gen | RX spurious emissions radiated | Nominal | Nominal | -/- | <input checked="" type="checkbox"/> | <input type="checkbox"/> | <input type="checkbox"/> | <input type="checkbox"/> | complies |
| §15.209(a) RSS-Gen | TX spurious emissions radiated < 30 MHz | Nominal | Nominal | 8 DPSK | <input checked="" type="checkbox"/> | <input type="checkbox"/> | <input type="checkbox"/> | <input type="checkbox"/> | complies |
| §15.107(a) | Conducted emissions < 30 MHz | Nominal | Nominal | 8 DPSK | <input checked="" type="checkbox"/> | <input type="checkbox"/> | <input type="checkbox"/> | <input type="checkbox"/> | complies |

Note: NA = Not Applicable; NP = Not Performed

8 RF measurements

8.1 Description of test setup

8.1.1 Radiated measurements

The radiated measurements are performed in vertical and horizontal plane in the frequency range from 9 kHz to 25 GHz in semi-anechoic chambers. The EUT is positioned on a non-conductive support with a height of 0.80 m above a conductive ground plane that covers the whole chamber. The receiving antennas are confirmed with specifications ANSI C63.2-1996 clause 15 and ANSI C63.4-2009 clause 4.1.5. These antennas can be moved over the height range between 1.0 m and 4.0 m in order to search for maximum field strength emitted from EUT. The measurement distances between EUT and receiving antennas are indicated in the test setups for the various frequency ranges. For each measurement, the EUT is rotated in all three axes until the maximum field strength is received. The wanted and unwanted emissions are received by spectrum analysers where the detector modes and resolution bandwidths over various frequency ranges are set according to requirement ANSI C63-4-2009 clause 4.2.

Antennas are confirmed with ANSI C63.2-1996 item 15.

Semi anechoic chamber

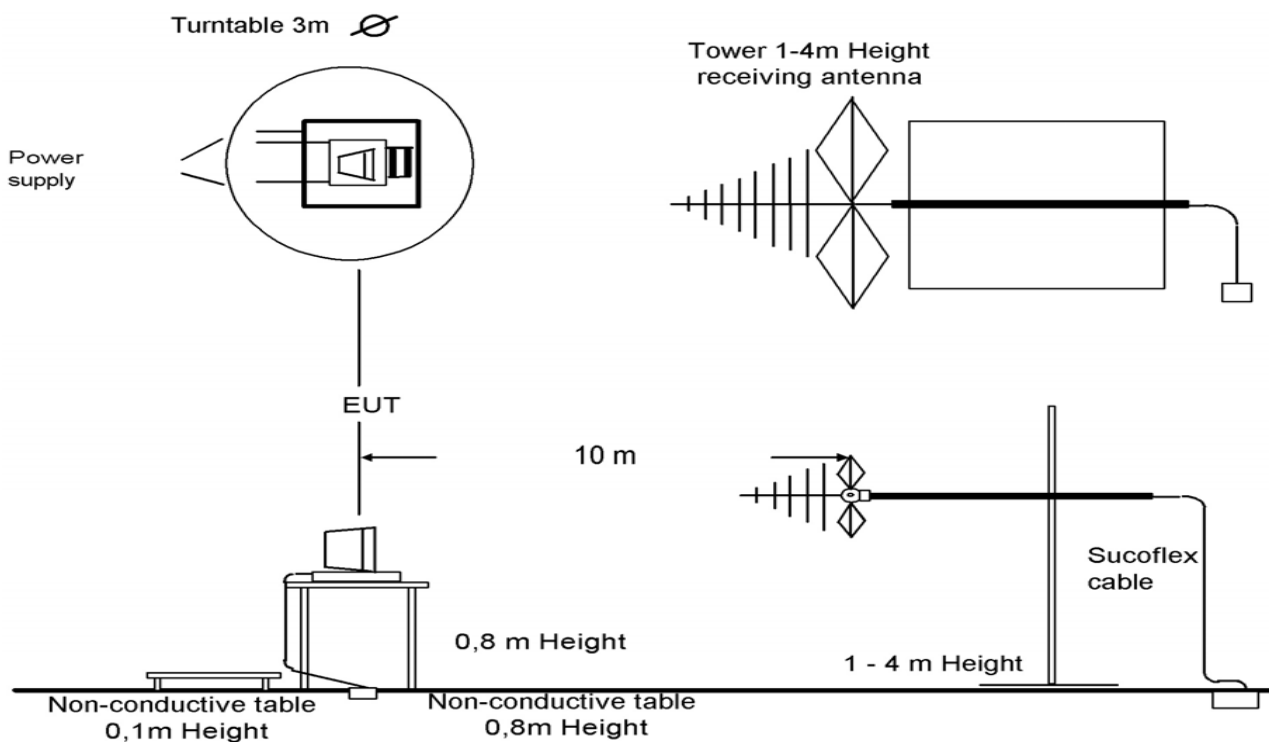

Picture 1: Diagram radiated measurements

| | |
|-----------------|---------------------|
| 9 kHz - 30 MHz: | active loop antenna |
| 30 MHz – 1 GHz: | tri-log antenna |
| > 1 GHz: | horn antenna |

All measurements are done in accordance with the Filing and Measurement Guidelines for Frequency Hopping Spread Spectrum Systems DA 00-705 and Appendix A “BLUETOOTH® APPROVALS”
 The EUT is powered by an external power supply with nominal voltage. The signalling is performed from outside the chamber with a signalling unit (CMU200 or other) by air link using signalling antenna.

8.1.2 Conducted measurements

The EUT's RF signal is coupled out by the antenna connector which is supplied by the manufacturer. The signal is first 10dB attenuated before it is power divided (~6dB loss per branch). One of the signal paths is connected to the communication base Station (CMU200 or other), the other one is connected to the spectrum analyzer. The specific losses for both signal paths are first checked within a calibration. The measurement readings on the signalling unit/spectrum analyzer are corrected by the specific test set-up loss. The attenuator, power divider, signalling unit and the spectrum analyzer are impedance matched on 50 Ohm.

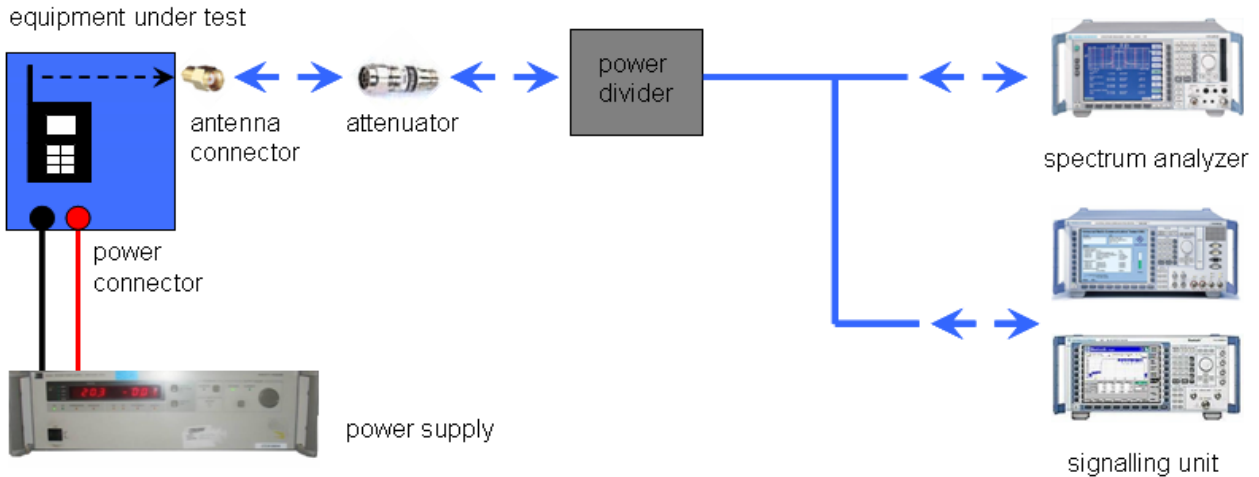

Picture 2: Diagram conducted measurements

8.2 Additional comments

The Bluetooth® word mark and logos are owned by the Bluetooth SIG Inc. and any use of such marks by Cetecom ICT Services GmbH is under license.

| | |
|-----------------------------|---|
| Reference documents: | RF Fixture- Antenna Port Information |
| Special test descriptions: | None |
| Configuration descriptions: | TX tests: were performed with x-DH5 packets and static PRBS pattern payload. RX/Standby tests: BT test mode enabled, scan enabled, TX Idle |
| Test mode: | <input checked="" type="checkbox"/> Bluetooth Test mode loop back enabled (EUT is controlled over CBT/CMU) <input type="checkbox"/> Special software is used. EUT is transmitting pseudo random data by itself |

9 Measurement results

9.1 Antenna gain

Measurement:

The antenna gain of the complete system is calculated by the difference of radiated power in EIRP and the conducted power of the module. For normal Bluetooth® devices, the GFSK modulation is used.

Measurement parameters:

| Measurement parameter | |
|-----------------------|----------|
| Detector: | Peak |
| Sweep time: | Auto |
| Video bandwidth: | 3 MHz |
| Resolution bandwidth: | 3 MHz |
| Span: | 5 MHz |
| Trace-Mode: | Max hold |

Limits:

| FCC | IC |
|--------------|----|
| Antenna Gain | |
| 6 dBi | |

Results:

| T _{nom} | V _{nom} | lowest channel 2402 MHz | middle channel 2441 MHz | highest channel 2480 MHz |
|--|------------------|----------------------------|----------------------------|-----------------------------|
| Conducted power [dBm] Measured with GFSK modulation | | 6.90 | 6.45 | 6.57 |
| Radiated power [dBm] Measured with GFSK modulation | | 8.96 | 7.82 | 7.97 |
| Gain [dBi] Calculated | | 2.06 | 1.37 | 1.40 |

Result: Passed

9.2 Power spectral density

Description:

Measurement of the power spectral density of a digital modulated system. This requirement is only valid for digitally modulated systems without hopping functionality.

Measurement:

| Measurement parameter | |
|-----------------------|----------|
| Detector: | Peak |
| Sweep time: | 500 s |
| Video bandwidth: | 3 kHz |
| Resolution bandwidth: | 3 kHz |
| Span: | 150 kHz |
| Trace-Mode: | Max Hold |

Limits:

| FCC | IC |
|--|----|
| Power Spectral Density | |
| For digitally modulated systems the transmitter power spectral density conducted from the transmitter to the antenna shall not be greater than 8 dBm in any 3 kHz band during any time interval of continuous transmission or over 1.0 second if the transmission exceeds 1.0-second duration. | |

Results:

| Modulation | Power spectral density [dBm/3kHz] | | |
|-------------------------|--|----------|----------|
| | 2412 MHz | 2437 MHz | 2462 MHz |
| Frequency | | | |
| GFSK | Not required for hopping systems! | | |
| Pi/4 DQPSK | | | |
| 8DPSK | | | |
| Measurement uncertainty | ± 1.5 dB | | |

9.3 Carrier frequency separation

Description:

Measurement of the carrier frequency separation of a hopping system. The carrier frequency separation is constant for all modulation-modes. We use GFSK-modulation to show compliance. EUT in hopping mode.

Measurement:

| Measurement parameter | |
|-----------------------|----------|
| Detector: | Peak |
| Sweep time: | Auto |
| Video bandwidth: | 100 kHz |
| Resolution bandwidth: | 100 kHz |
| Span: | 4 MHz |
| Trace-Mode: | Max Hold |

Limits:

| FCC | IC |
|---|----|
| Carrier Frequency Separation | |
| Minimum 25 kHz or two-thirds of the 20 dB bandwidth of the hopping system whichever is greater. | |

Result:

| | |
|------------------------------|---------|
| Carrier frequency separation | ~ 1 MHz |
|------------------------------|---------|

Result: Passed

Plot:

Plot 1: Carrier frequency separation (GFSK modulation)

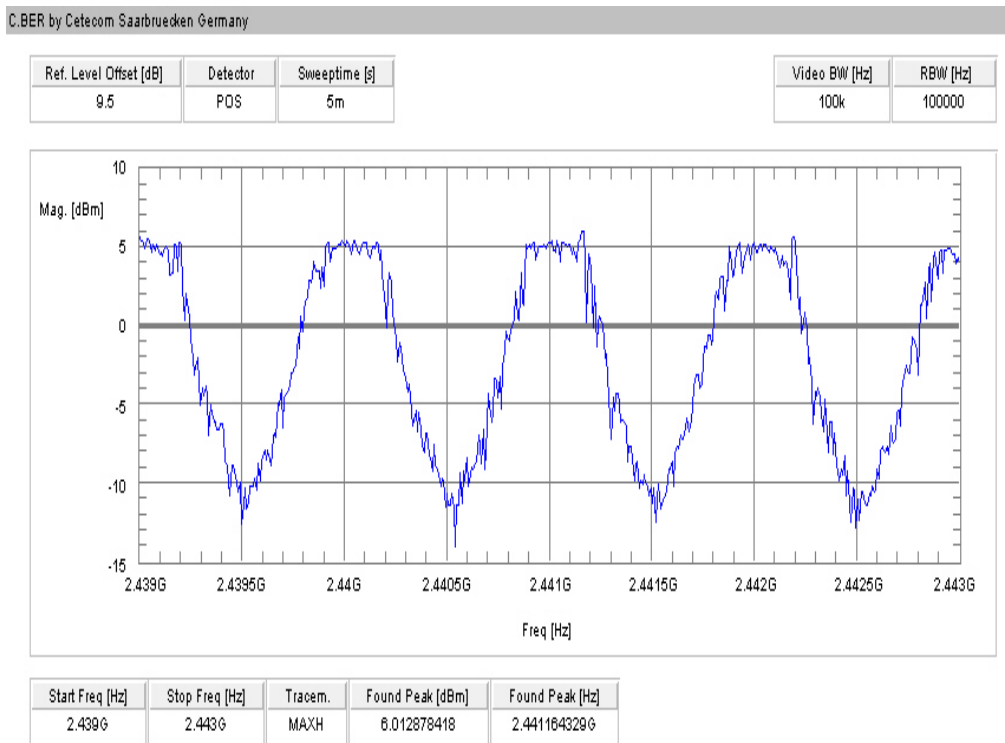

9.4 Number of hopping channels

Description:

Measurement of the total number of used hopping channels. The number of hopping channels is constant for all modulation-modes. We use GFSK-modulation to show compliance. EUT in hopping mode.

Measurement:

| Measurement parameter | |
|-----------------------|--|
| Detector: | Peak |
| Sweep time: | Auto |
| Video bandwidth: | 500 kHz |
| Resolution bandwidth: | 500 kHz |
| Span: | Plot 1: 2400 – 2445 MHz Plot 2: 2445 – 2485 MHz |
| Trace-Mode: | Max Hold |

Limits:

| FCC | IC |
|--|----|
| Number of hopping channels | |
| At least 15 non overlapping hopping channels | |

Result:

| | |
|----------------------------|----|
| Number of hopping channels | 79 |
|----------------------------|----|

Result: Passed

Plots:

Plot 1: Number of hopping channels (GFSK modulation)

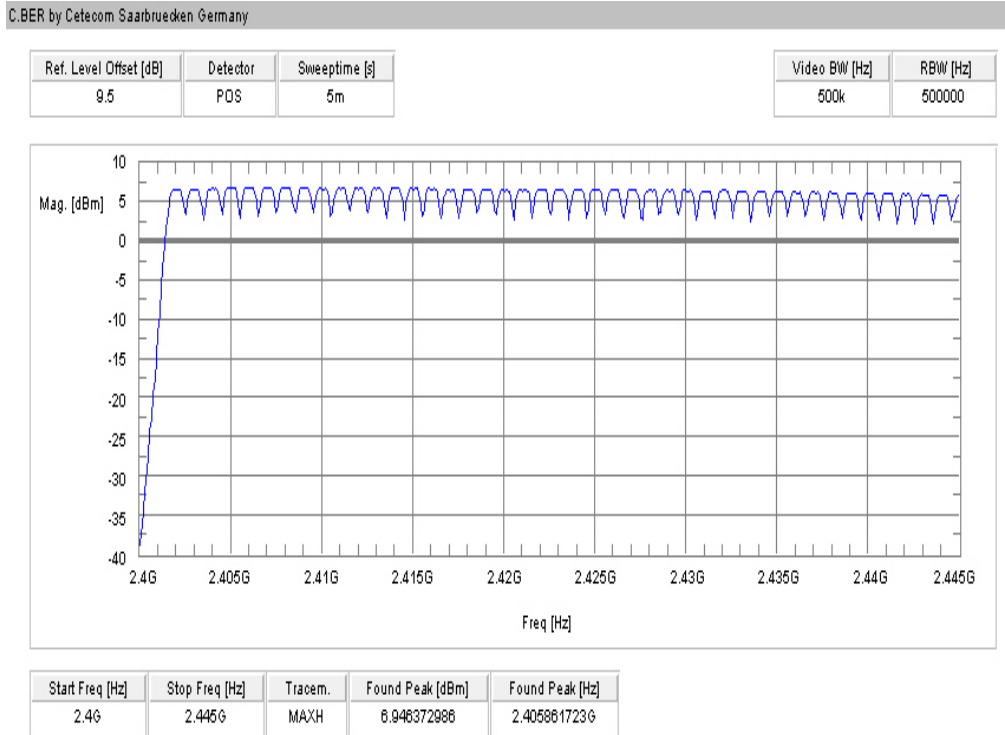

Plot 2: Number of hopping channels (GFSK modulation)

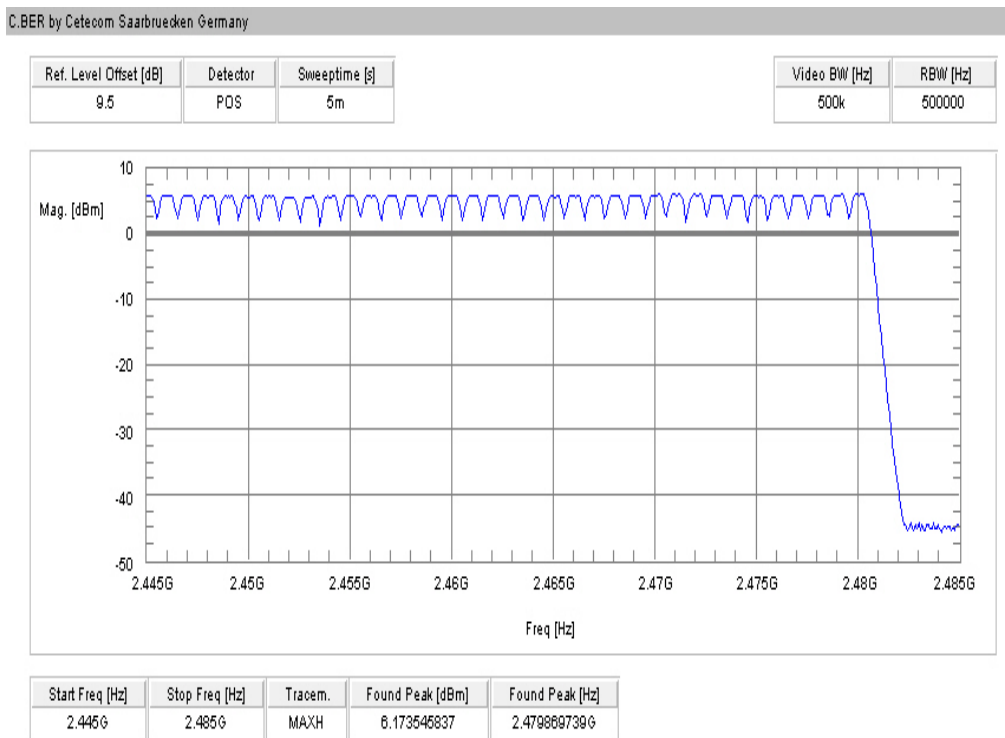

9.5 Time of occupancy (dwell time)

Measurement:

For Bluetooth® devices no measurements mandatory depending on the fixed requirements according to the Bluetooth® Core Specifications!

For Bluetooth® devices:

The channel staying time of 0.4 s within a 31.6 second period in data mode is constant for Bluetooth® devices and independent from the packet type (packet length). The calculation for a 31.6 second period is as follows:

Channel staying time = time slot length * hop rate / number of hopping channels * 31.6 s

Example for a DH1 packet (with a maximum length of one time slot)

Channel staying time = $625 \mu\text{s} * 1600 * 1/\text{s} / 79 * 31.6 \text{ s} = 0.4 \text{ s}$ (in a 31.6 s period)

For multi-slot packets the hopping is reduced according to the length of the packet.

Example for a DH3 packet (with a maximum length of three time slots)

Channel staying time = $3 * 625 \mu\text{s} * 1600/3 * 1/\text{s} / 79 * 31.6 \text{ s} = 0.4 \text{ s}$ (in a 31.6 s period)

Example for a DH5 packet (with a maximum length of five time slots)

Channel staying time = $5 * 625 \mu\text{s} * 1600/5 * 1/\text{s} / 79 * 31.6 \text{ s} = 0.4 \text{ s}$ (in a 31.6 s period)

This is according to the Bluetooth® Core Specification V2.0 & V2.1 & V3.0 & V4.0 (+ critical errata) for all Bluetooth® devices.

The following table shows the relations:

| Packet Size | Pulse Width [ms] * | Max. number of transmissions per channel in 31.6 sec |
|-------------|--------------------|--|
| DH1 | 0.366 | 640 |
| DH3 | 1.622 | 214 |
| DH5 | 2.870 | 128 |

* according Bluetooth® specification

Results:

| Packet Size | Pulse Width [ms]* | Max. number of transmissions in 31.6 sec | Dwell time [Pulse width * Number of transmissions] |
|-------------|-------------------|--|--|
| DH1 | 0.366 | 640 | 234.2 ms |
| DH3 | 1.622 | 214 | 347.1 ms |
| DH5 | 2.870 | 128 | 367.4 ms |

Limits:

| FCC | IC |
|---|----|
| Time of occupancy (dwell time) | |
| The frequency hopping operation shall have an average time of occupancy on any frequency not exceeding 0.4 seconds within a duration in seconds equal to the number of hopping frequencies multiplied by 0.4. | |

Result: Passed

9.6 Spectrum bandwidth of a FHSS system – 20 dB bandwidth

Description:

Measurement of the 20dB bandwidth of the modulated signal. The measurement is performed according to the "Measurement Guidelines" (DA 00-705, March 30, 2000). EUT in single channel mode.

Measurement:

| Measurement parameter | |
|-----------------------|----------|
| Detector: | Peak |
| Sweep time: | 2 s |
| Video bandwidth: | 30 kHz |
| Resolution bandwidth: | 30 kHz |
| Span: | 3 MHz |
| Trace-Mode: | Max Hold |

Limits:

| FCC | IC |
|--|----|
| Spectrum bandwidth of a FHSS system – 20 dB bandwidth | |
| GFSK < 1500 kHz Pi/4 DQPSK < 1500 kHz 8DPSK < 1500 kHz | |

Results:

| Modulation | 20 dB BANDWIDTH [kHz] | | |
|-------------------------|-----------------------|----------|----------|
| | 2402 MHz | 2441 MHz | 2480 MHz |
| Frequency | | | |
| GFSK | 938 | 956 | 992 |
| Pi/4 DQPSK | 1299 | 1299 | 1299 |
| 8DPSK | 1299 | 1299 | 1281 |
| Measurement uncertainty | ± 30 kHz | | |

Result: Passed

Plots:

Plot 1: lowest channel – 2402 MHz, GFSK modulation

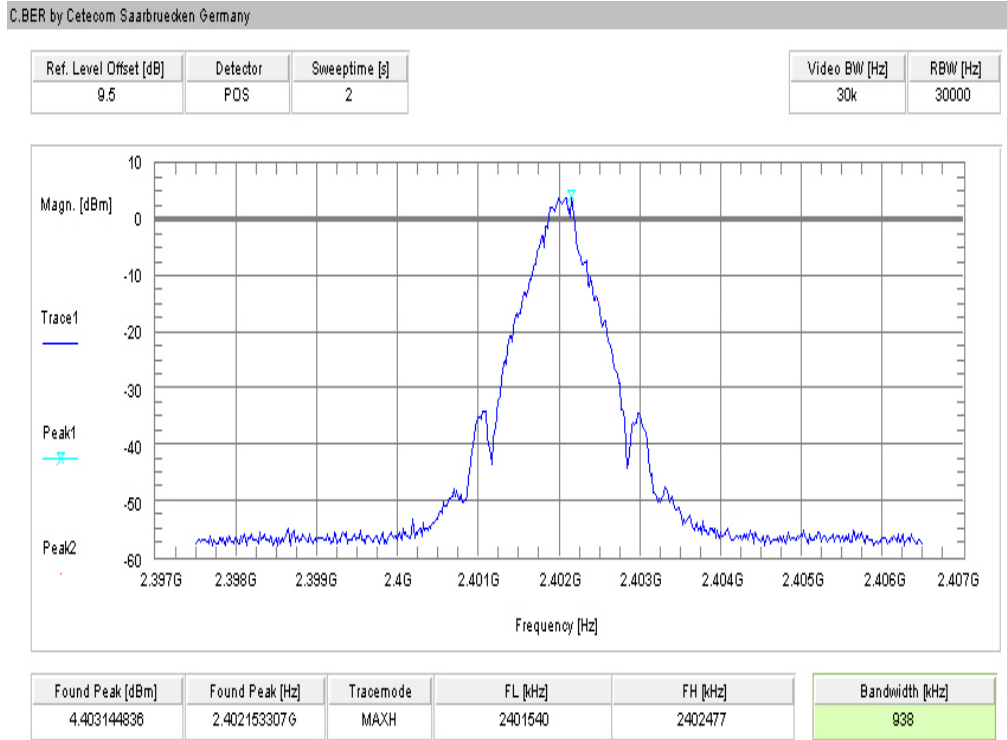

Plot 2: middle channel – 2441 MHz, GFSK modulation

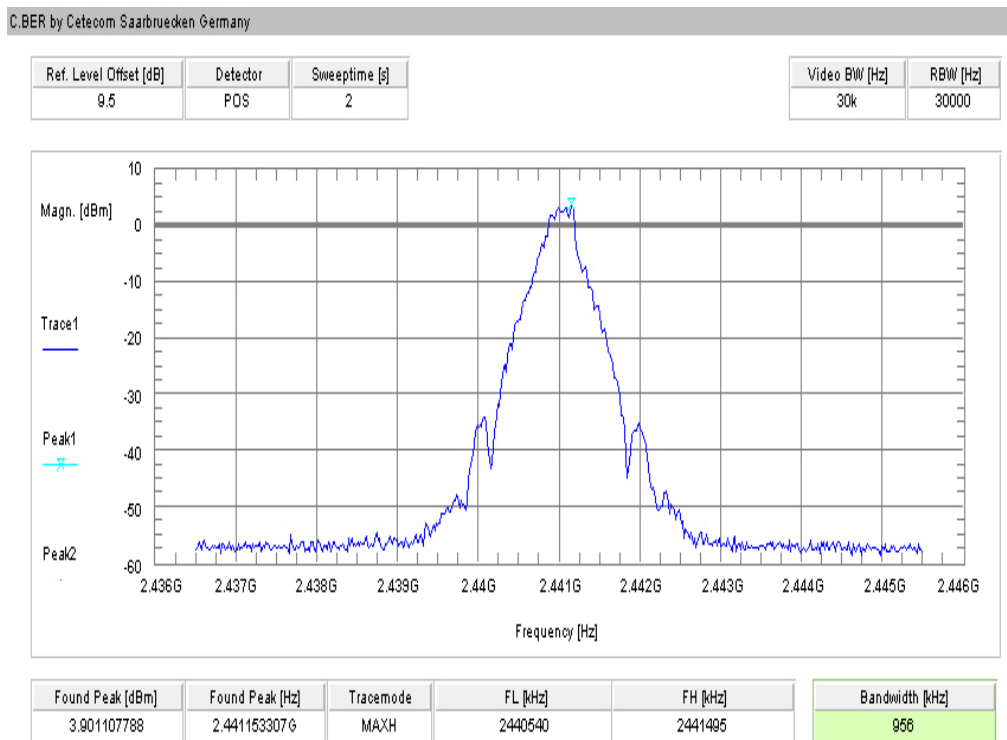

Plot 3: highest channel – 2480 MHz, GFSK modulation

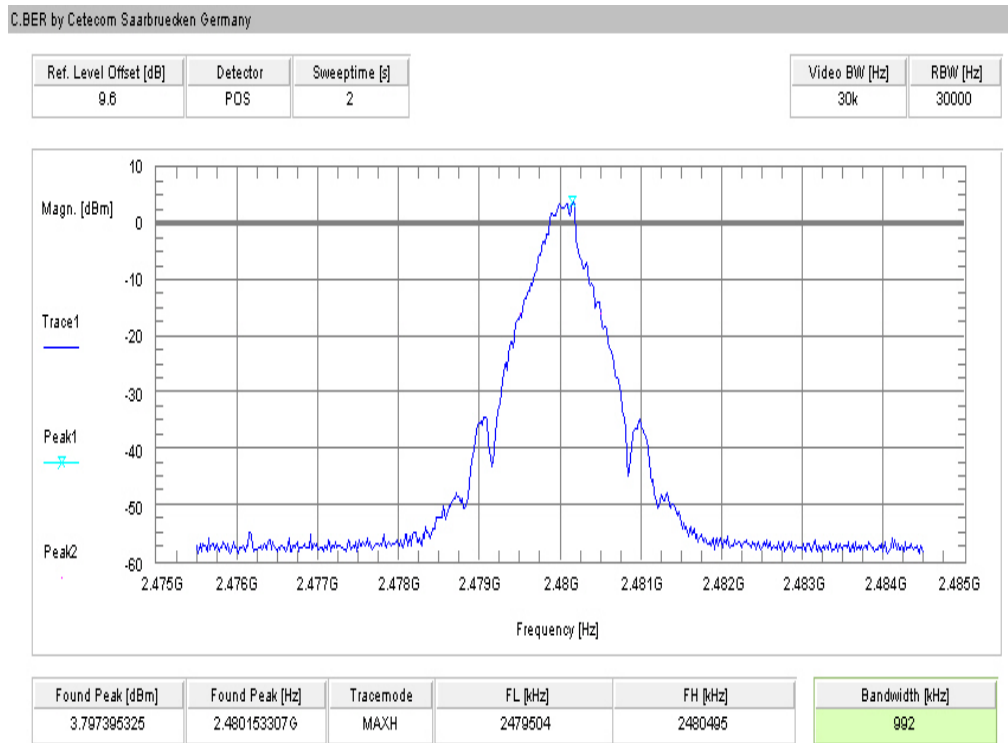

Plot 4: lowest channel – 2402 MHz, Pi / DQPSK modulation

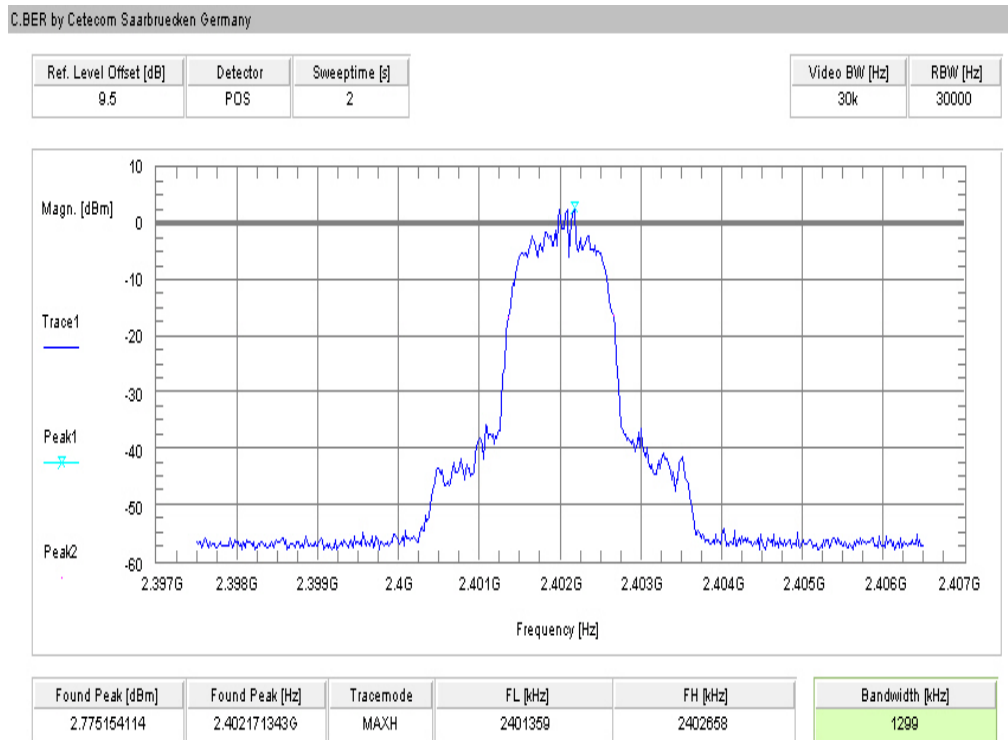

Plot 5: middle channel – 2441 MHz, Pi / DQPSK modulation

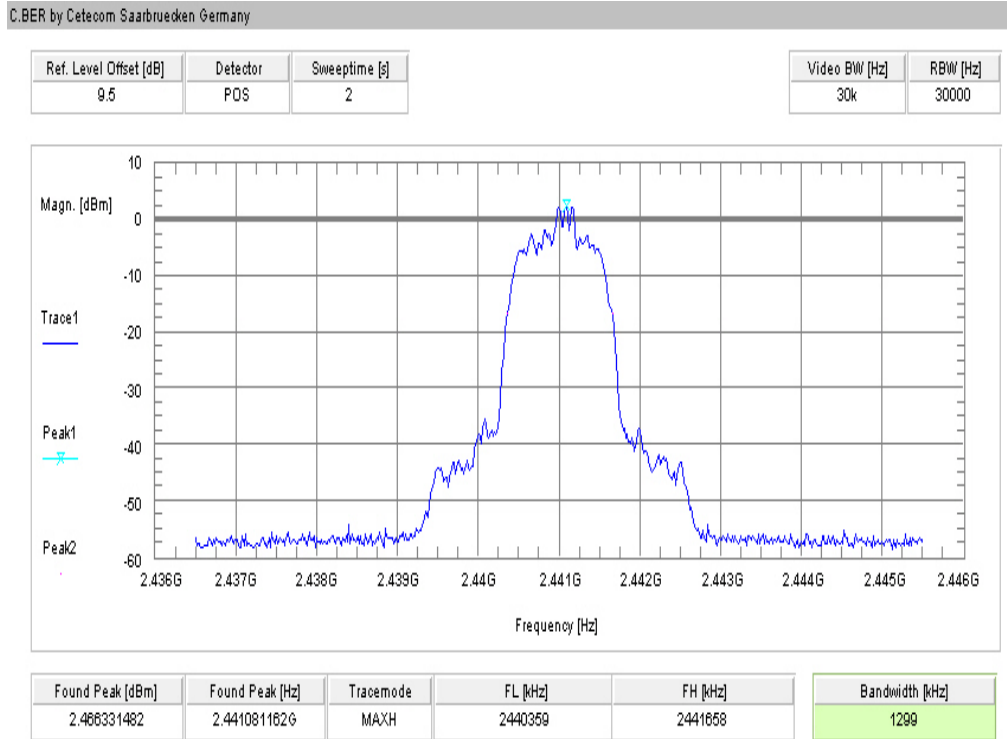

Plot 6: highest channel – 2480 MHz, Pi / DQPSK modulation

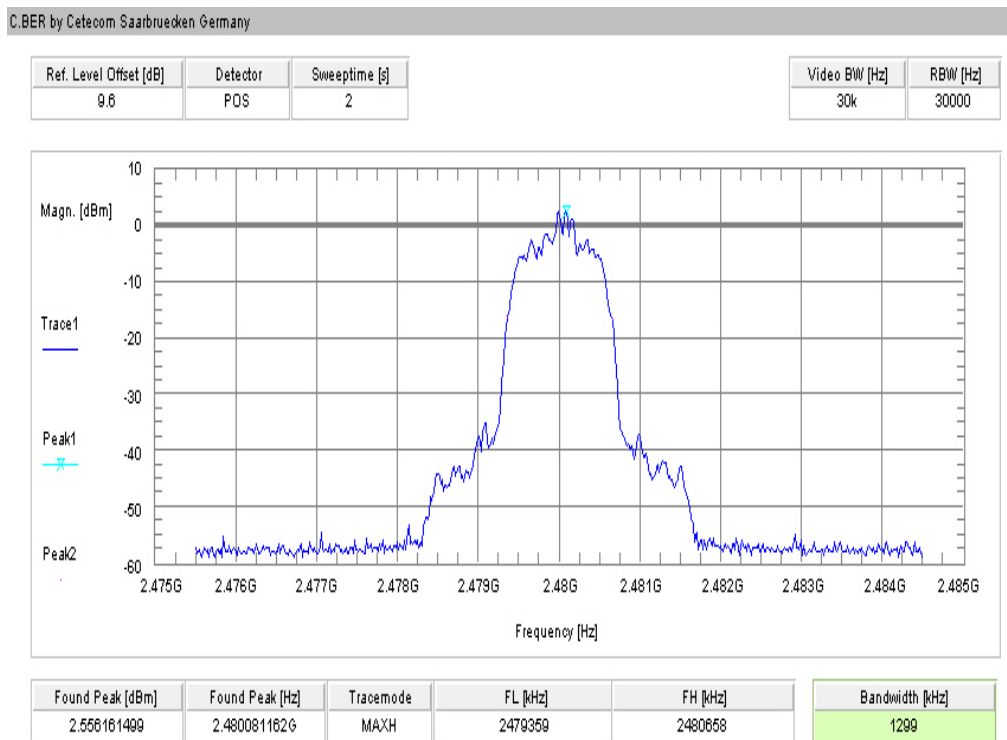

Plot 7: lowest channel – 2402 MHz, 8 DPSK modulation

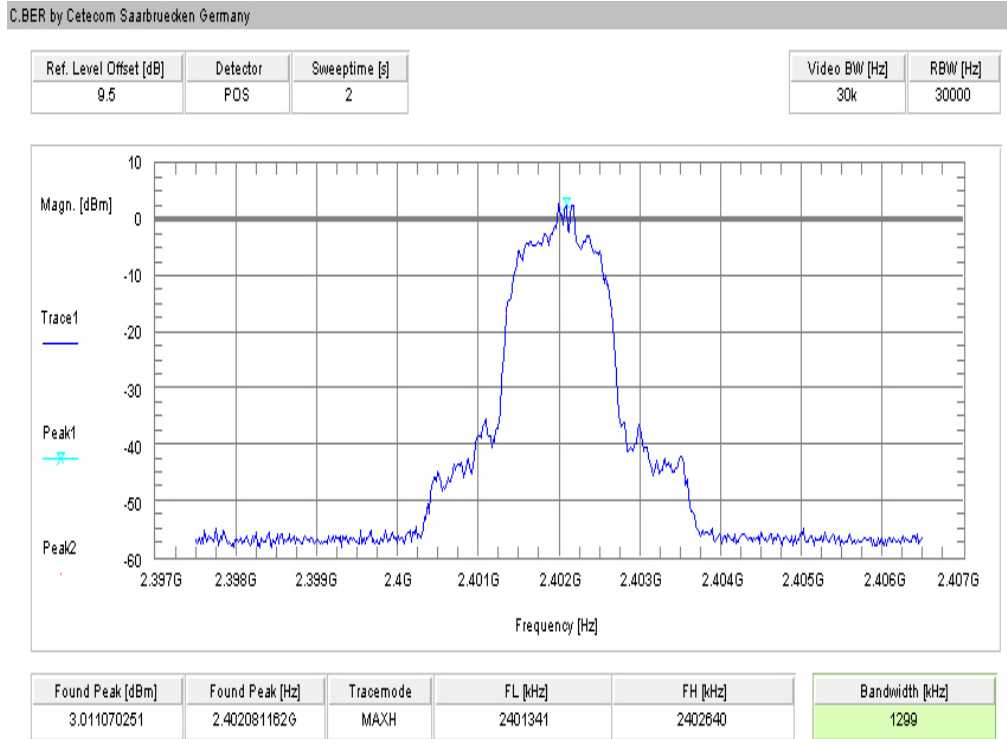

Plot 8: middle channel – 2441 MHz, 8 DPSK modulation

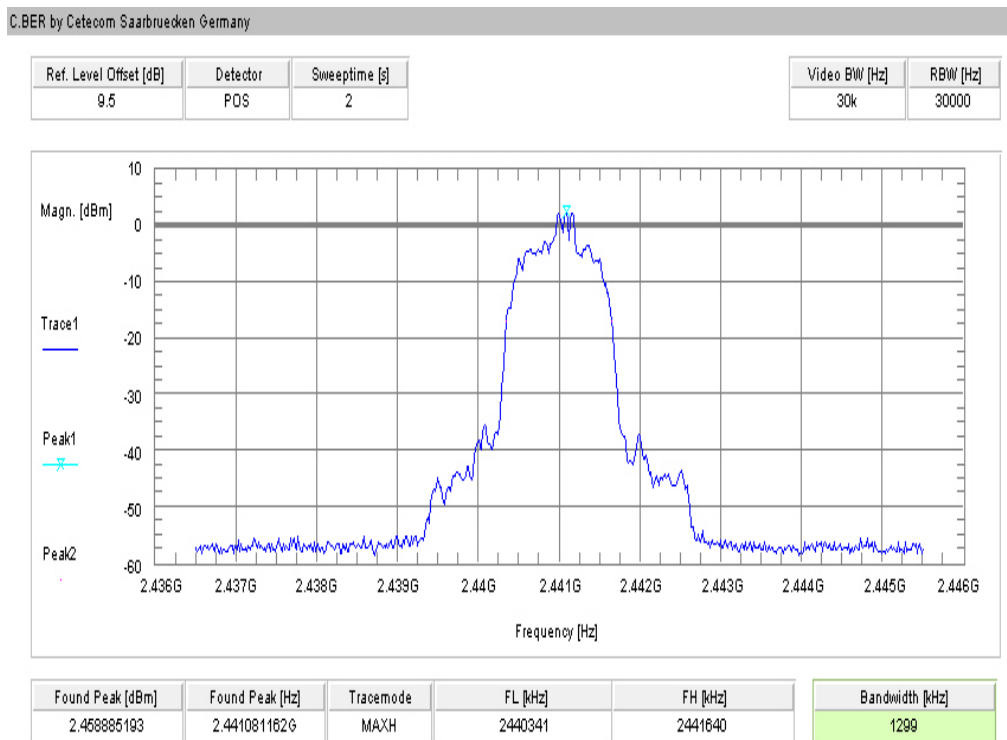

Plot 9: highest channel – 2480 MHz, 8 DPSK modulation

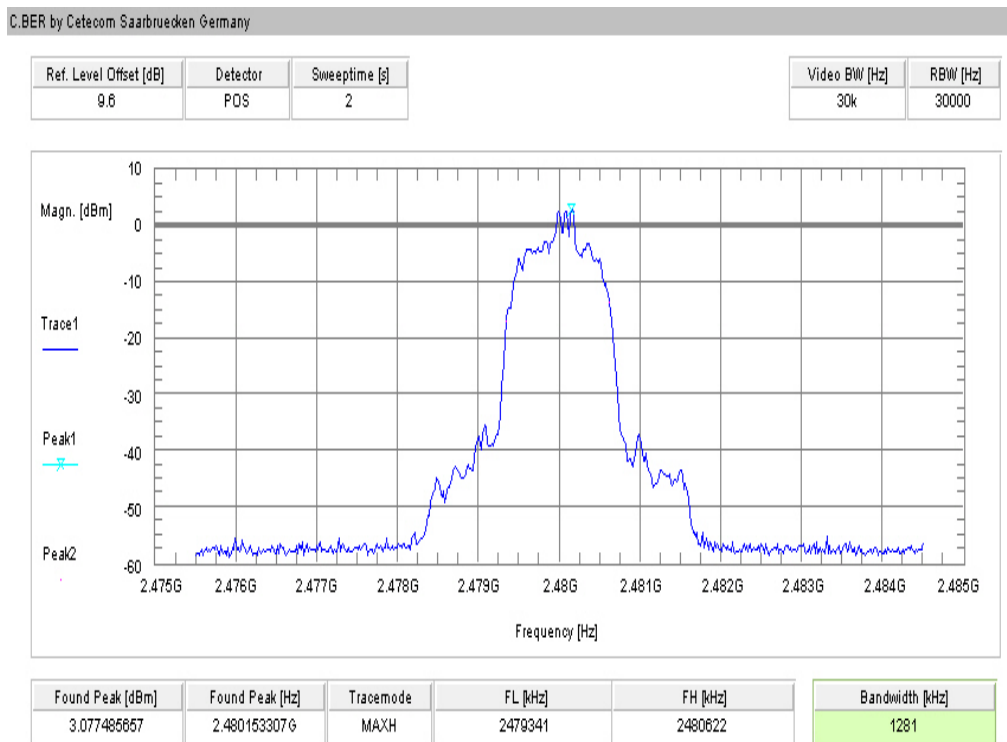

9.7 Maximum output power

Description:

Measurement of the maximum output power conducted and radiated. EUT in single channel mode.

Measurement:

| Measurement parameter | |
|-----------------------|----------|
| Detector: | Peak |
| Sweep time: | Auto |
| Video bandwidth: | 3 MHz |
| Resolution bandwidth: | 3 MHz |
| Span: | 5 MHz |
| Trace-Mode: | Max Hold |

Limits:

| FCC | IC |
|--|----|
| Maximum output power | |
| [Conducted: 0.125 W – antenna gain max. 6 dBi] Systems using more than 75 hopping channels: Conducted: 1.0 W – antenna gain max. 6 dBi | |

Results:

| Modulation Frequency | Maximum output power conducted [dBm] | | |
|-------------------------|--------------------------------------|----------|----------|
| | 2402 MHz | 2441 MHz | 2480 MHz |
| GFSK | 6.90 | 6.45 | 6.57 |
| Pi/4 DQPSK | 7.78 | 7.34 | 7.44 |
| 8DPSK | 8.12 | 7.62 | 7.79 |
| Measurement uncertainty | ± 1 dB | | |

Result: Passed**Results:**

| Modulation Frequency | Maximum output power radiated - EIRP [dBm] | | |
|-------------------------|--|----------|----------|
| | 2402 MHz | 2441 MHz | 2480 MHz |
| GFSK | 8.96 | 7.82 | 7.97 |
| Pi/4 DQPSK *) | 9.84 | 8.71 | 8.84 |
| 8DPSK *) | 10.18 | 8.99 | 9.19 |
| Measurement uncertainty | ± 3 dB | | |

*) - Values calculated with antenna gain

Result: Passed

Plots:

Plot 1: lowest channel – 2402 MHz, GFSK modulation

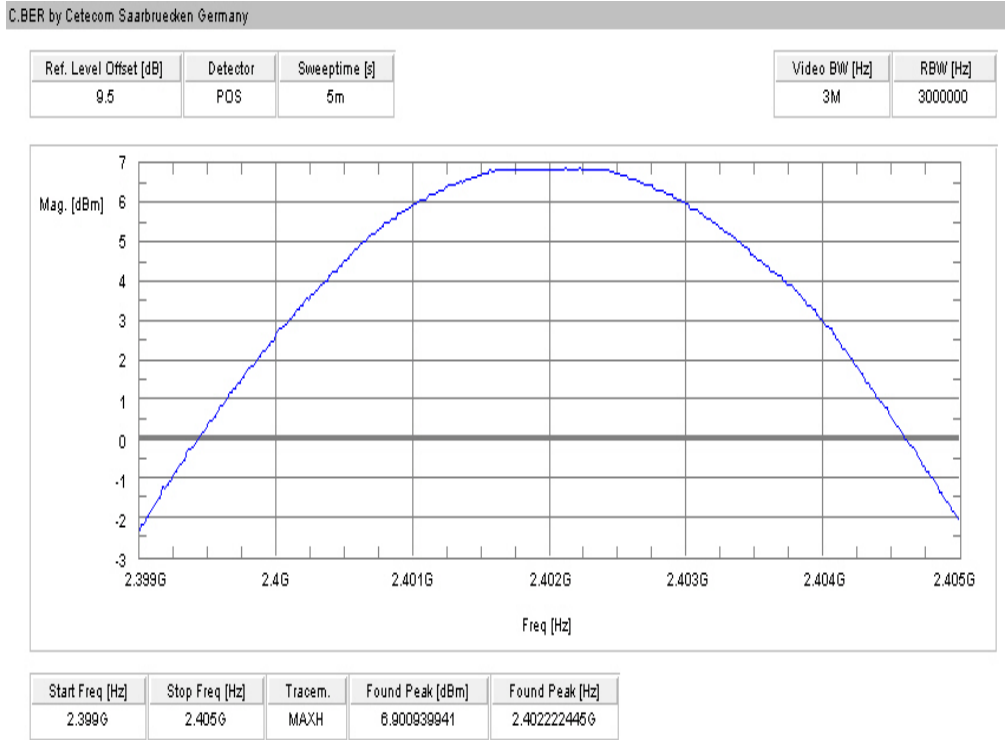

Plot 2: middle channel – 2441 MHz, GFSK modulation

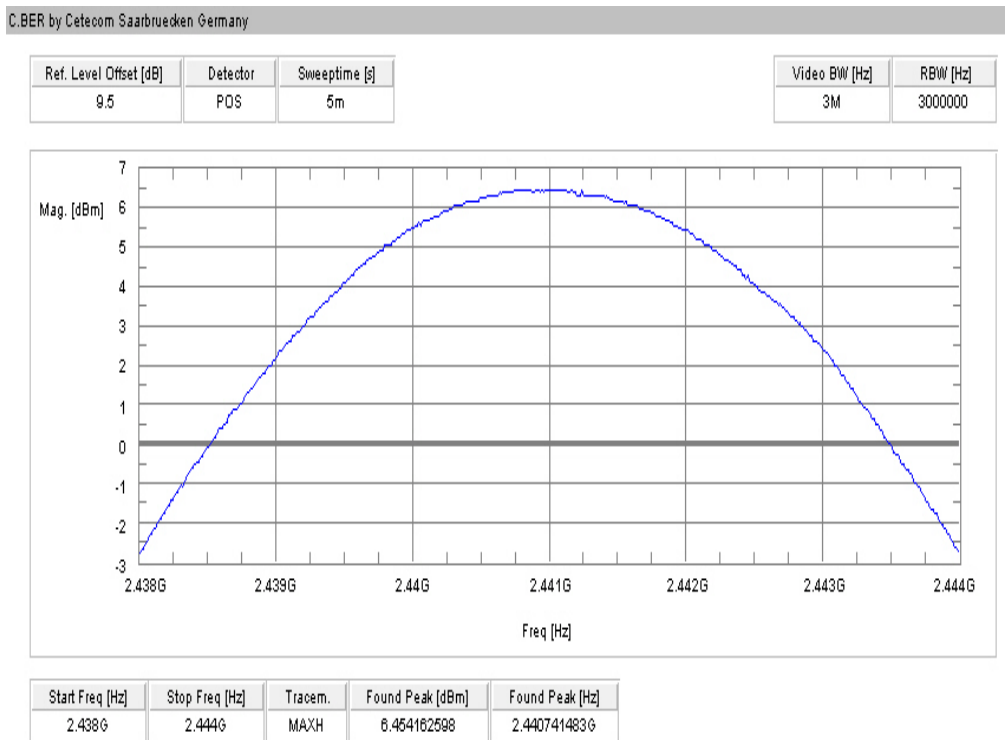

Plot 3: highest channel – 2480 MHz, GFSK modulation

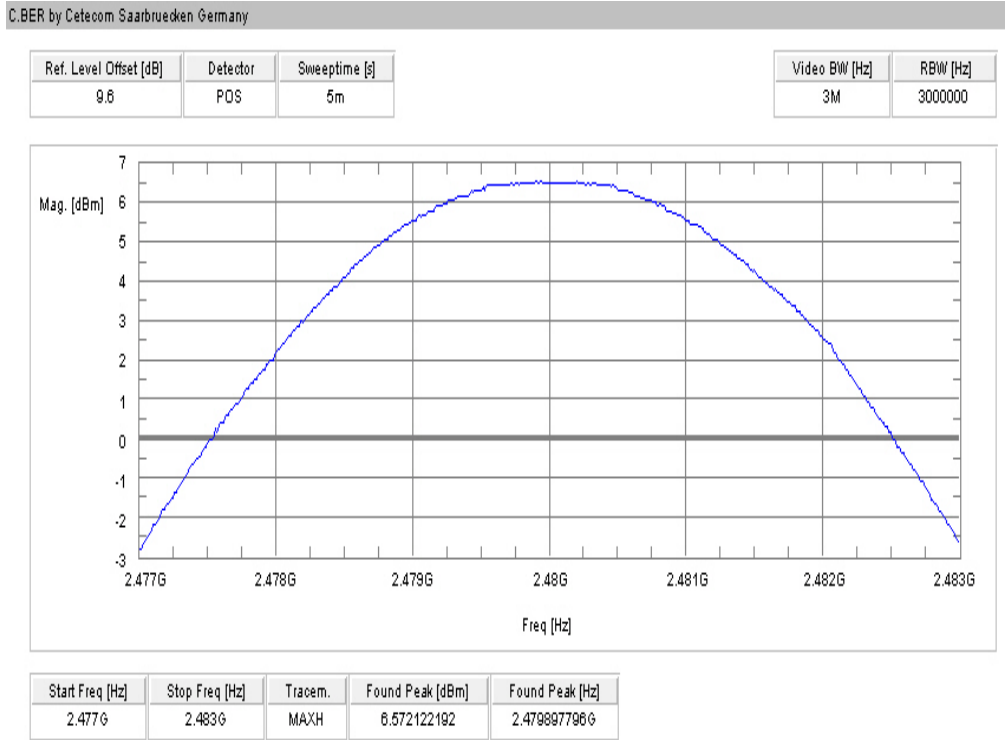

Plot 4: lowest channel – 2402 MHz, Pi/4 DQPSK modulation

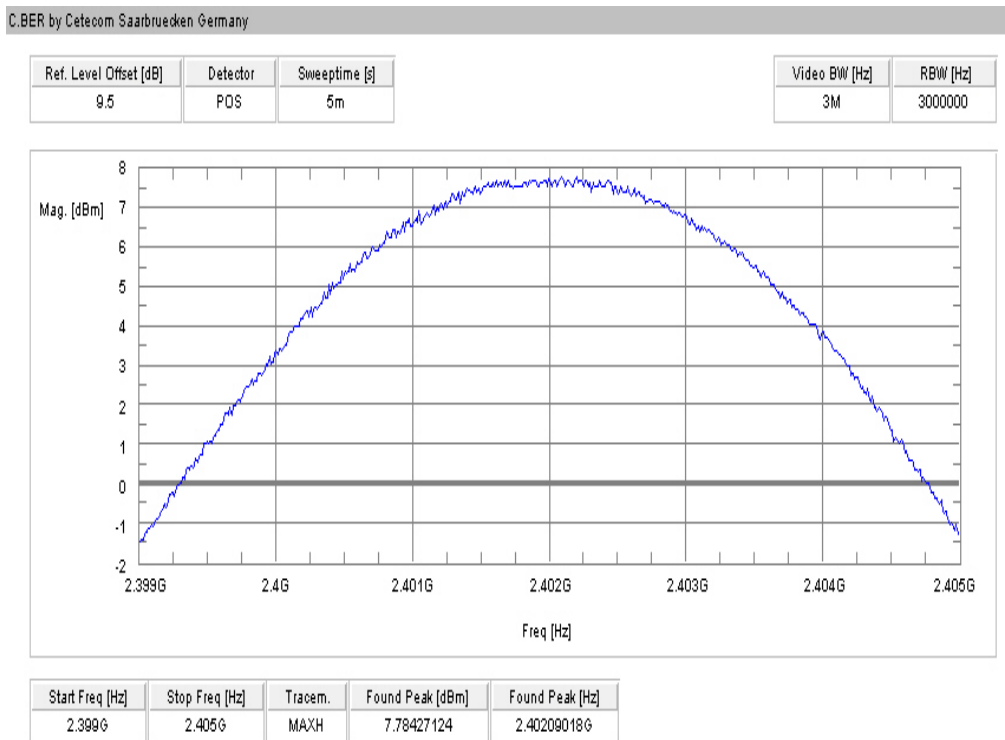

Plot 5: middle channel – 2441 MHz, Pi/4 DQPSK modulation

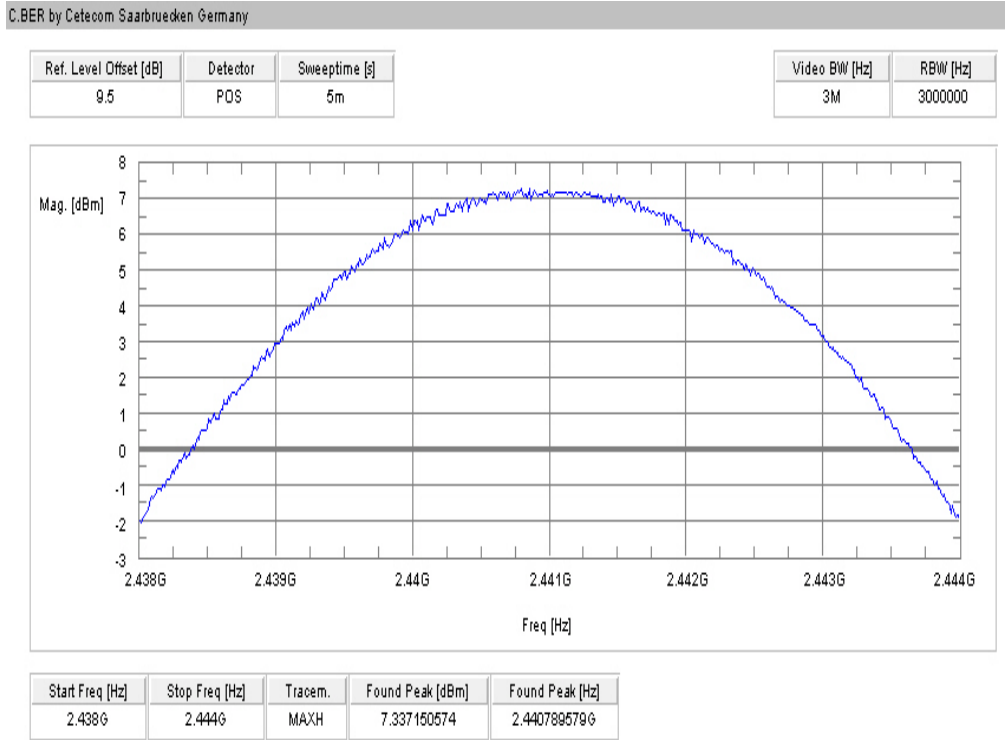

Plot 6: highest channel – 2480 MHz, Pi/4 DQPSK modulation

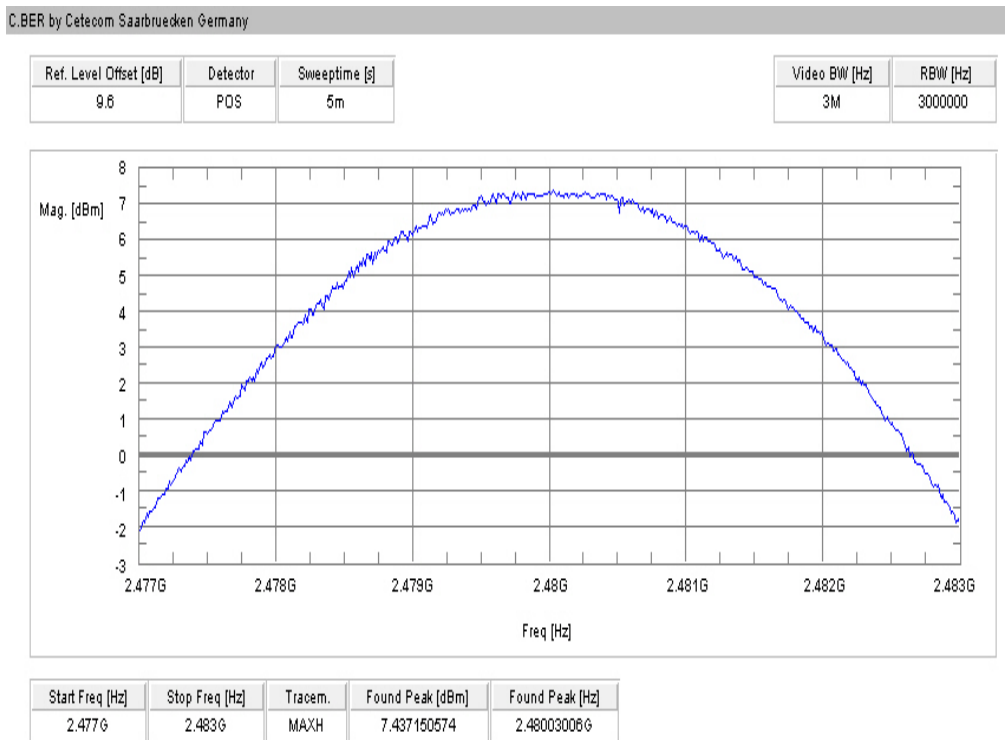

Plot 7: lowest channel – 2402 MHz, 8 DPSK modulation

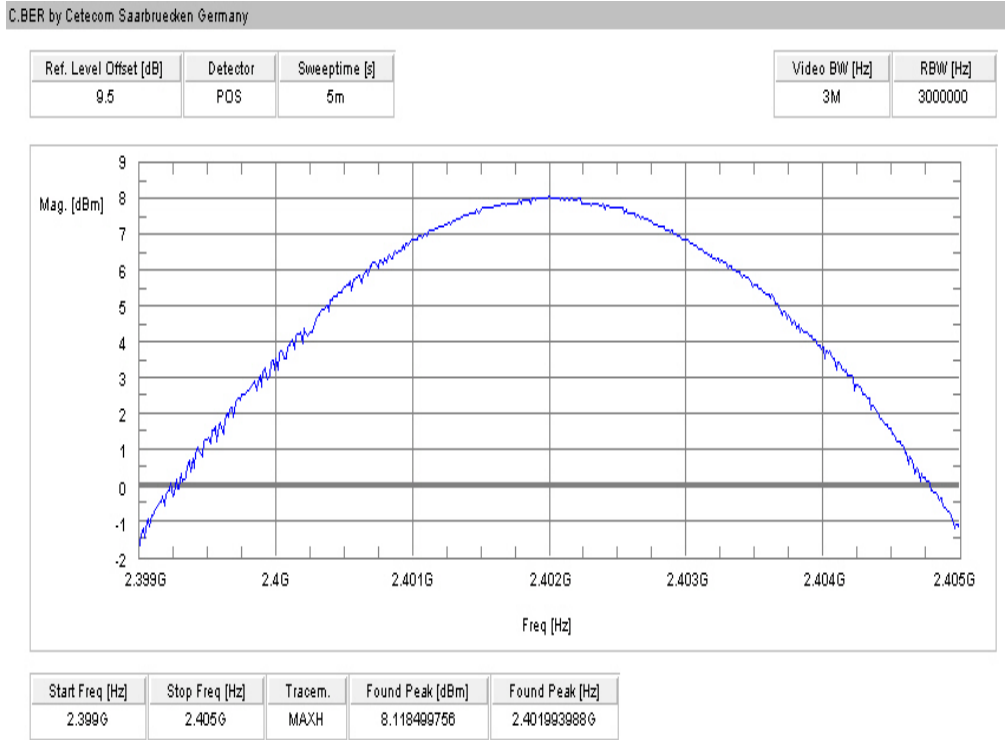

Plot 8: middle channel – 2441 MHz, 8 DPSK modulation

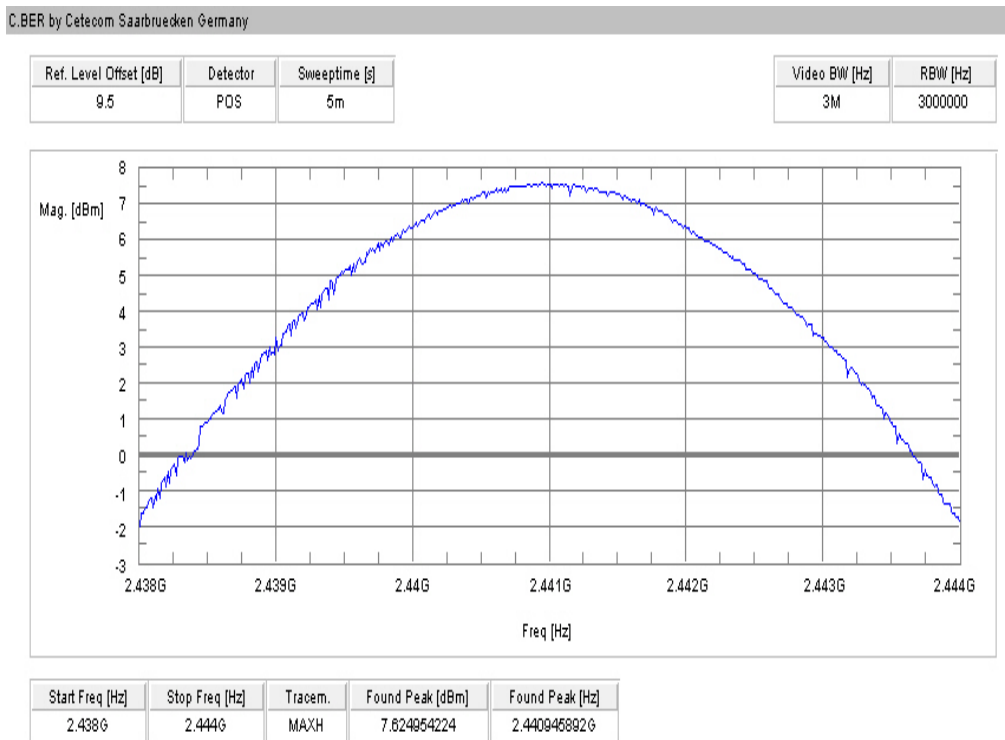

Plot 9: highest channel – 2480 MHz, 8 DPSK modulation

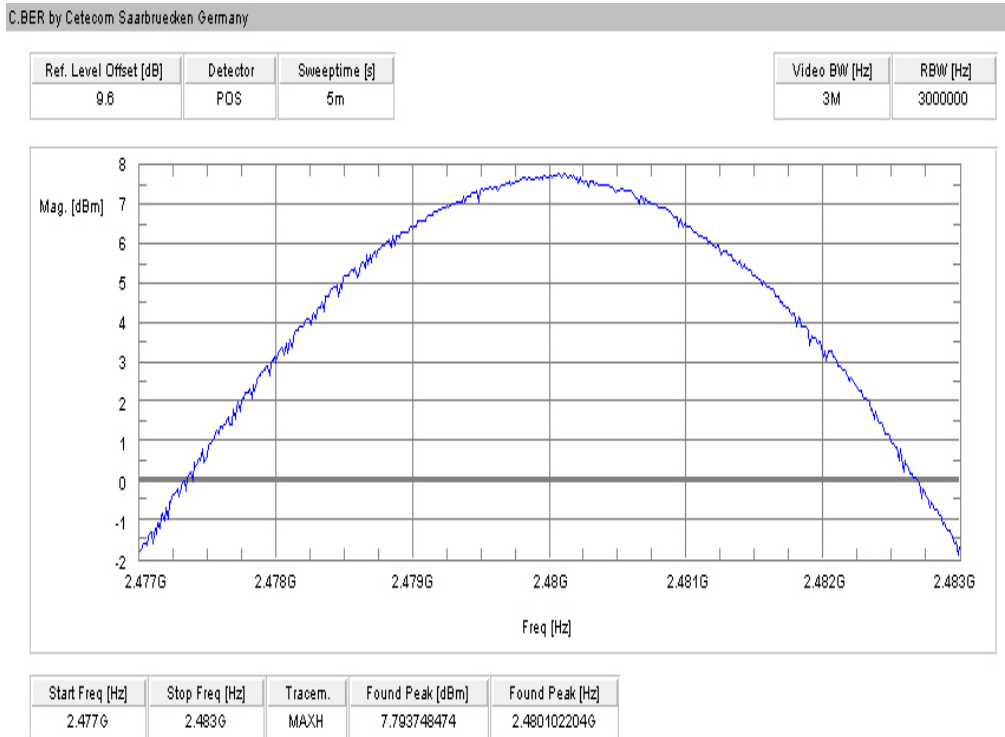

9.8 Band edge compliance conducted

Description:

Measurement of the conducted band edge compliance. EUT is measured at the lower and upper band edge in single channel and hopping mode. The measurement is repeated for all modulations.

Measurement:

| Measurement parameter | |
|-----------------------|--|
| Detector: | Peak |
| Sweep time: | Auto |
| Video bandwidth: | 100 kHz |
| Resolution bandwidth: | 100 kHz |
| Span: | Lower Band Edge: 2395 – 2405 MHz Upper Band Edge: 2478 – 2489 MHz |
| Trace-Mode: | Max Hold |

Limits:

| FCC | IC |
|--|----|
| Band edge compliance conducted | |
| <p>In any 100 kHz bandwidth outside the frequency band in which the spread spectrum or digitally modulated intentional radiator is operating, the radio frequency power that is produced by the intentional radiator shall be at least 20 dB below that in the 100 kHz bandwidth within the band that contains the highest level of the desired power, based on either an RF conducted or a radiated measurement. Attenuation below the general limits specified in Section 15.209(a) is not required.</p> | |

Results:

| Scenario Modulation | Band edge compliance conducted [dB] | | |
|-------------------------------|-------------------------------------|------------|---------|
| | GFSK | Pi/4 DQPSK | 8DPSK |
| Lower band edge – hopping off | > 20 dB | > 20 dB | > 20 dB |
| Lower band edge – hopping on | > 20 dB | > 20 dB | > 20 dB |
| Upper band edge – hopping off | > 20 dB | > 20 dB | > 20 dB |
| Upper band edge – hopping on | > 20 dB | > 20 dB | > 20 dB |
| Measurement uncertainty | ± 1.5 dB | | |

Result: Passed

Plots:

Plot 1: Lower band edge – hopping on, GFSK modulation

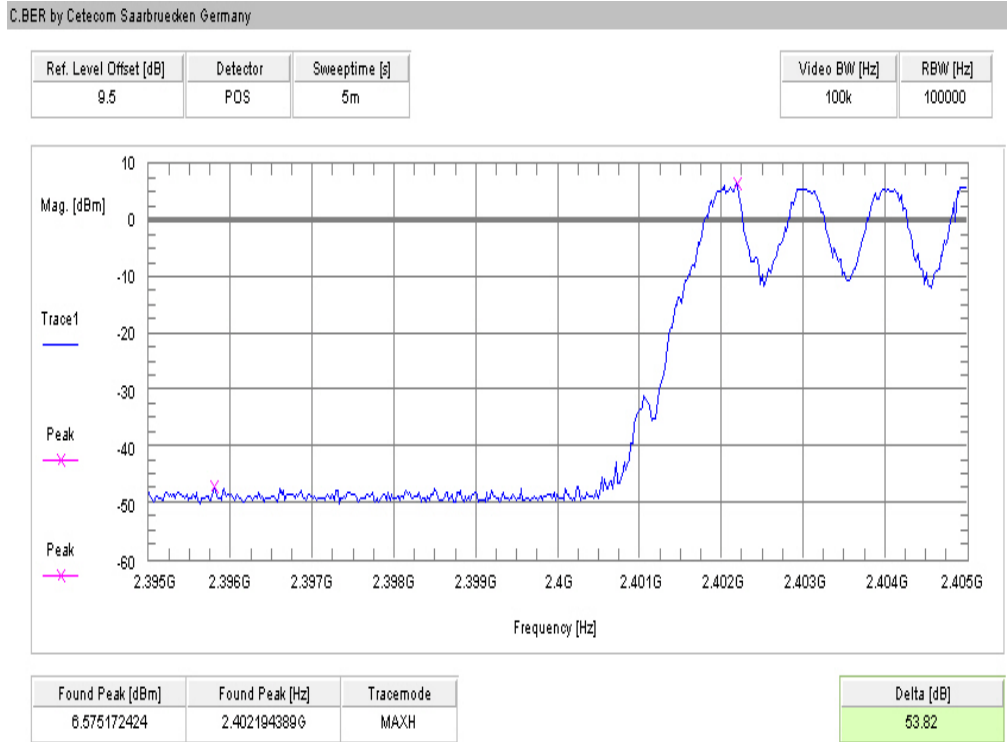

Plot 2: Upper band edge – hopping on, GFSK modulation

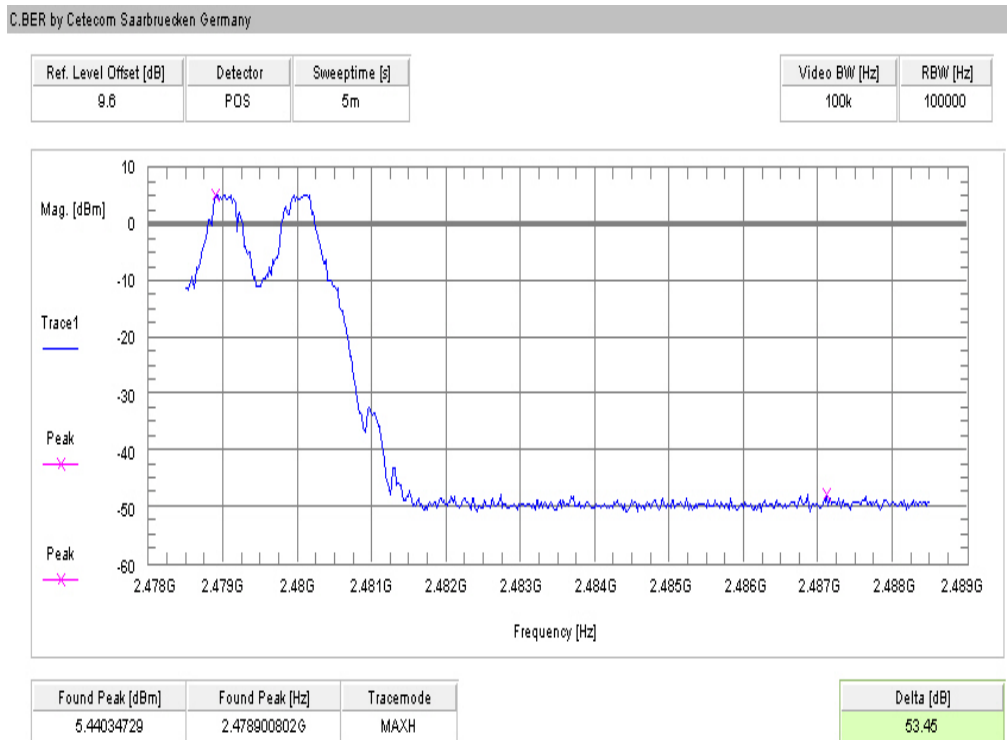

Plot 3: Lower band edge – hopping off, GFSK modulation

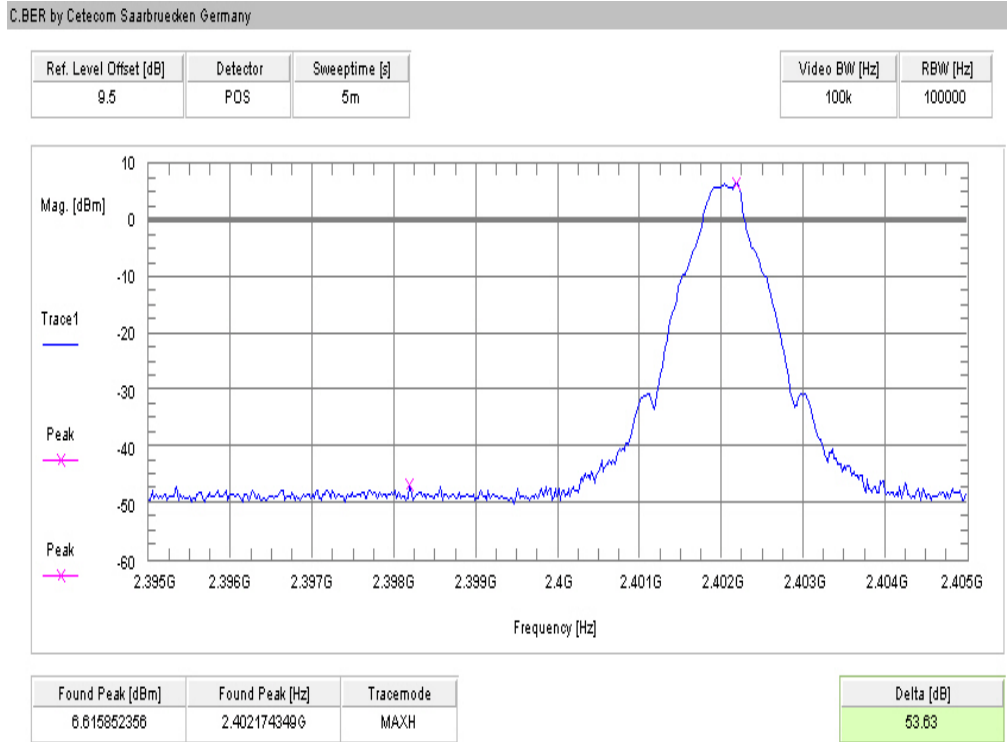

Plot 4: Upper band edge – hopping off, GFSK modulation

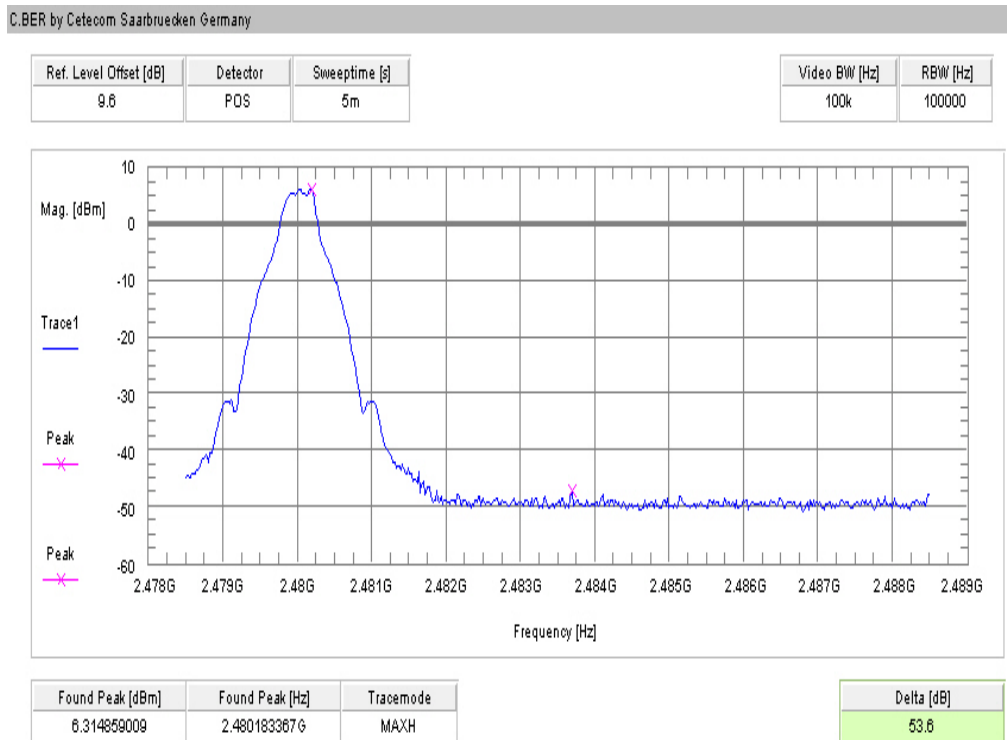

Plot 5: Lower band edge – hopping on, Pi/4 DQPSK modulation

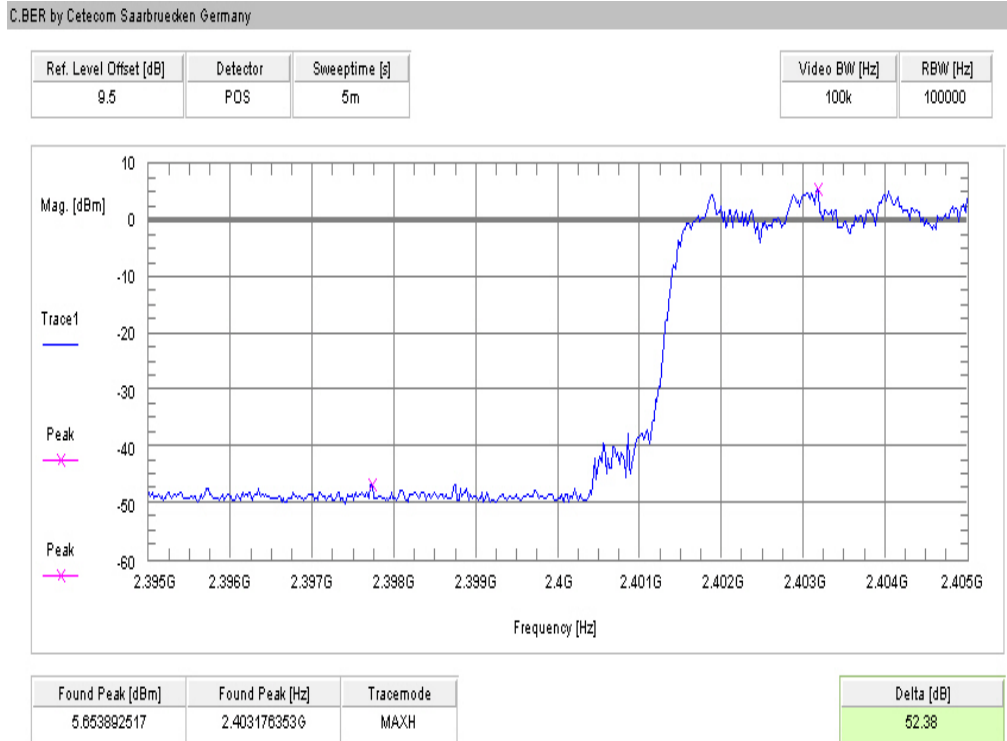

Plot 6: Upper band edge – hopping on, Pi/4 DQPSK modulation

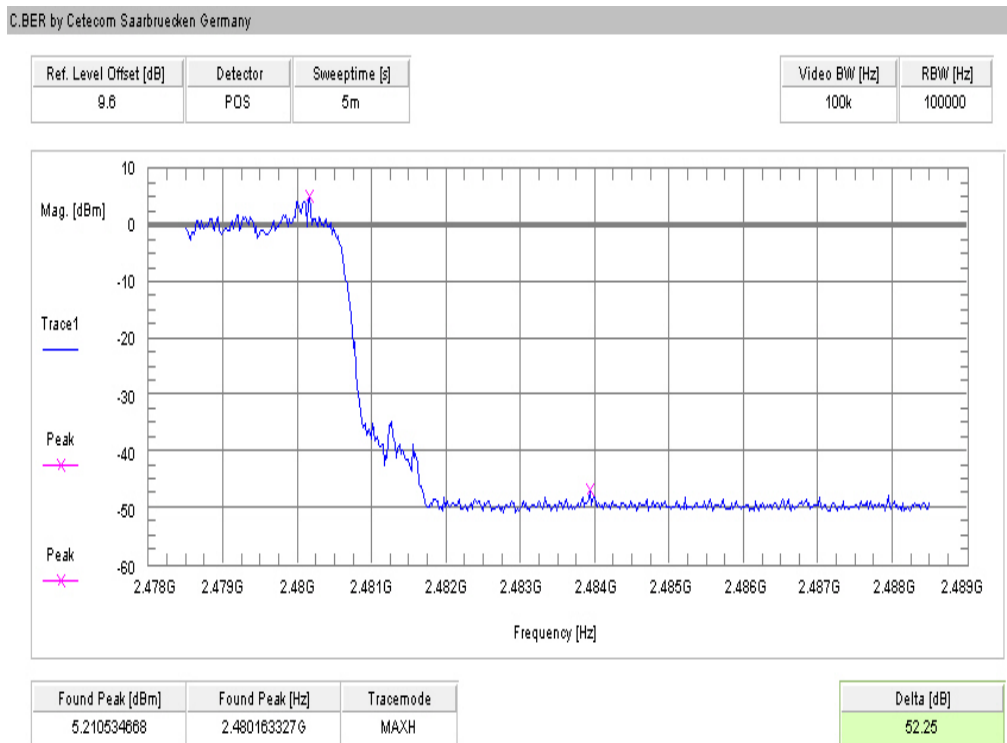

Plot 7: Lower band edge – hopping off, Pi/4 DQPSK modulation

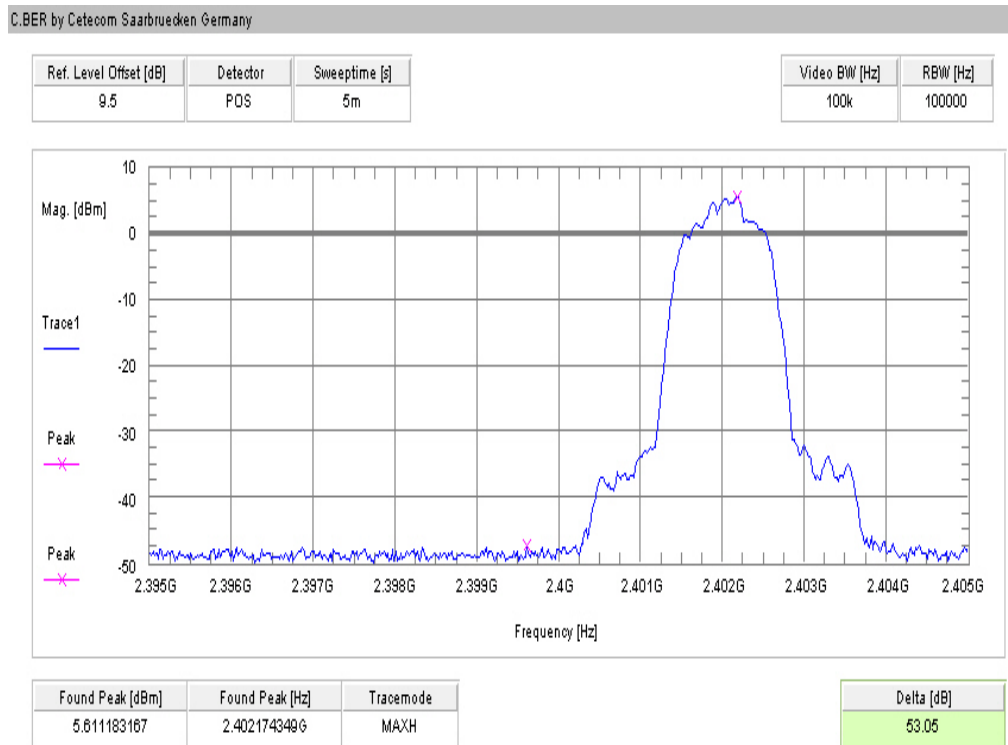

Plot 8: Upper band edge – hopping off, Pi/4 DQPSK modulation

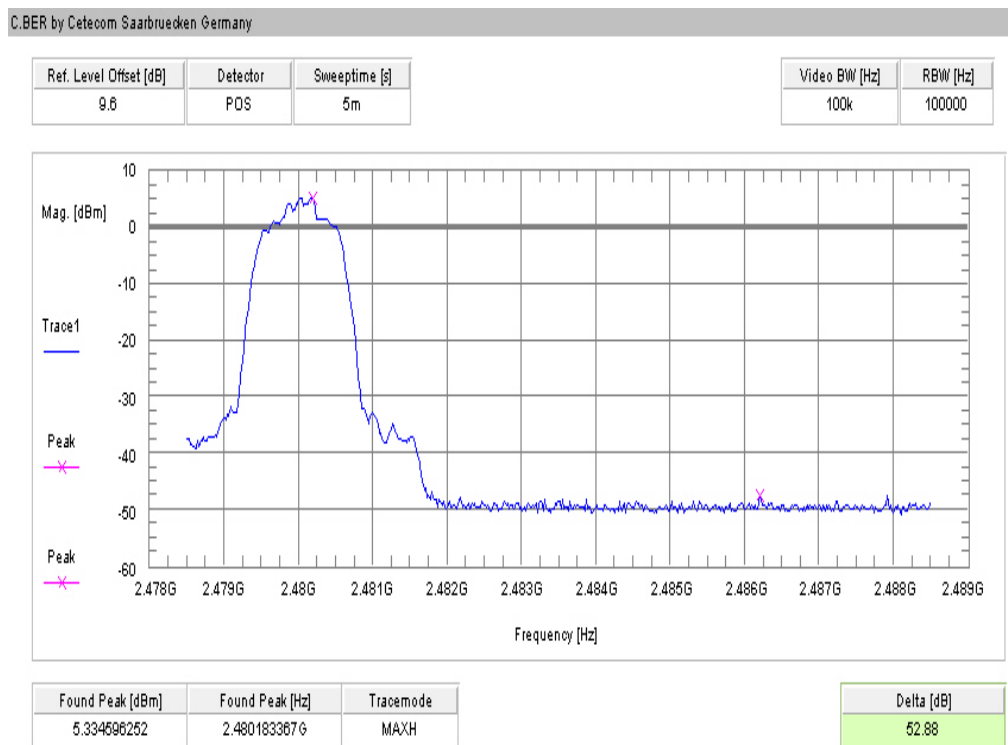

Plot 9: Lower band edge – hopping on, 8DPSK modulation

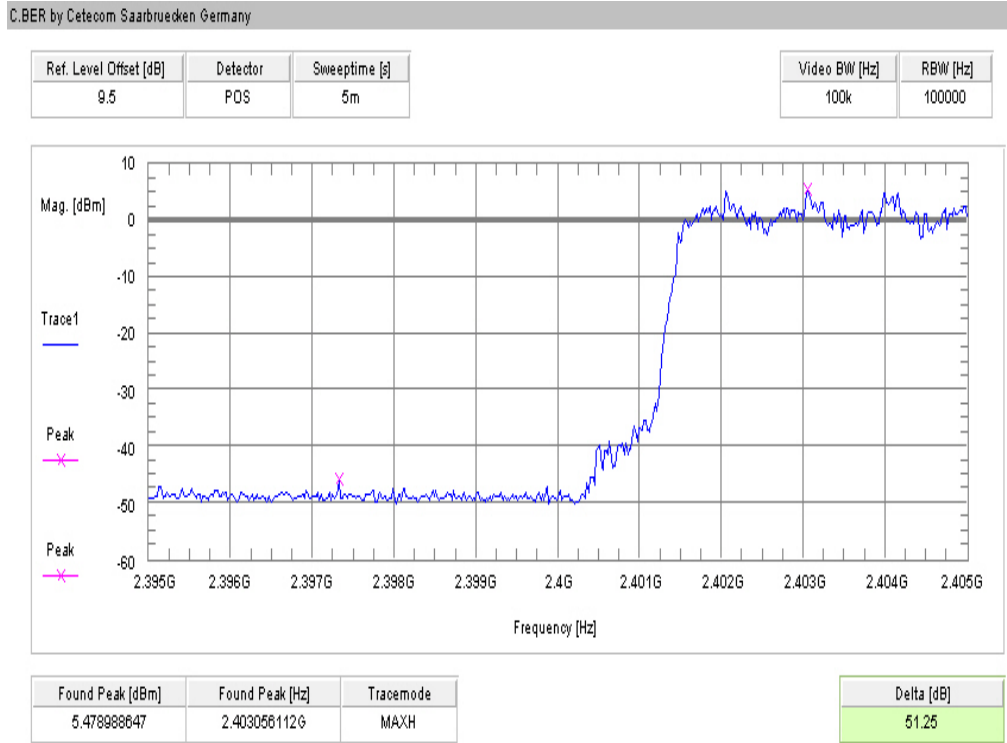

Plot 10: Upper band edge – hopping on, 8DPSK modulation

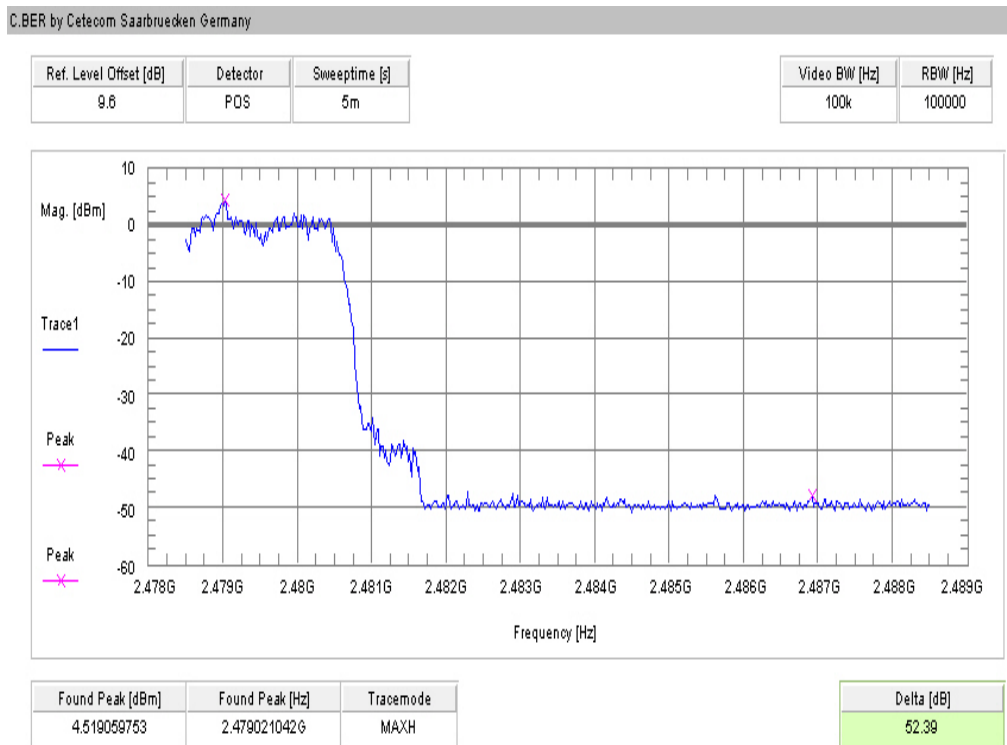

Plot 11: Lower band edge – hopping off, 8DPSK modulation

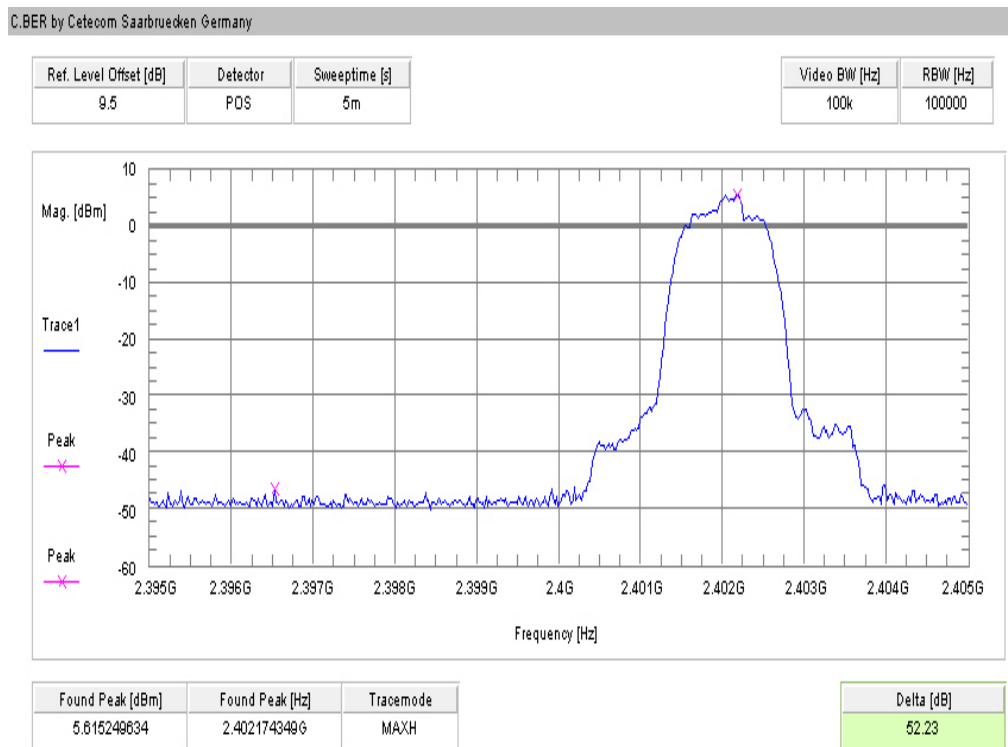

Plot 12: Upper band edge – hopping off, 8DPSK modulation

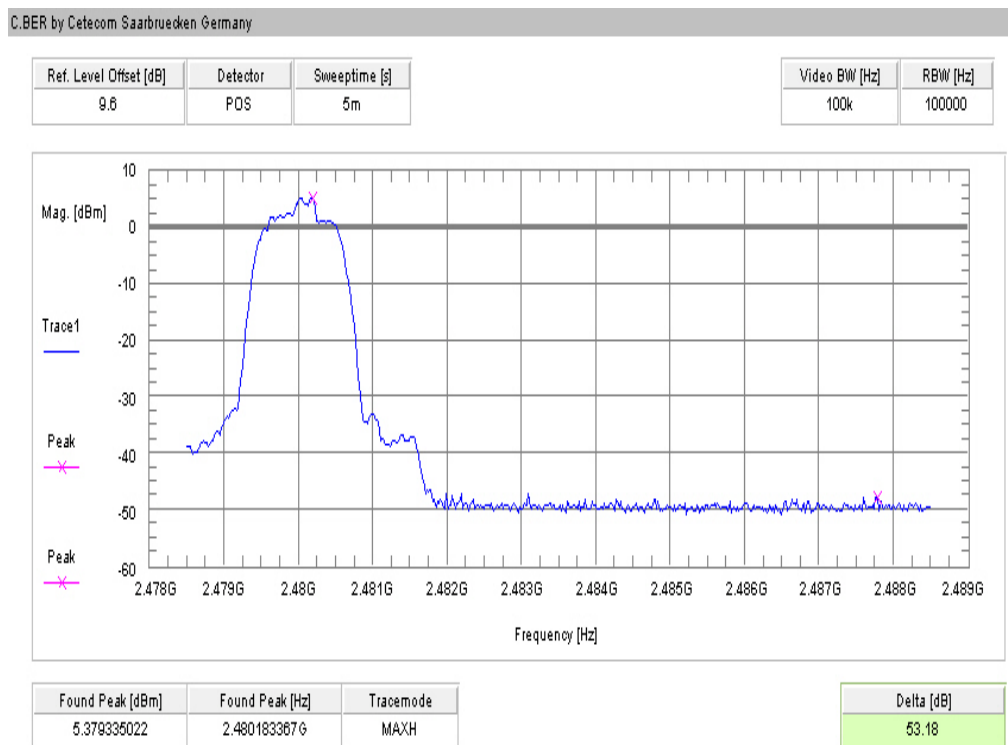

9.9 Band edge compliance radiated

Description:

Measurement of the radiated band edge compliance. The EUT is turned in the position that results in the maximum level at the band edge. Then a sweep over the corresponding restricted band is performed. The EUT is set to single channel mode and the transmit channel is channel 00 for the lower restricted band and channel 78 for the upper restricted band. The measurement is repeated for all modulations. Measurement distance is 3m.

Measurement:

| Measurement parameter | |
|-----------------------|--|
| Detector: | Peak |
| Sweep time: | Auto |
| Video bandwidth: | 1 MHz Peak / 10 Hz AVG |
| Resolution bandwidth: | 1 MHz |
| Span: | Lower Band: 2370 – 2400 MHz Upper Band: 2480 – 2500 MHz |
| Trace-Mode: | Max Hold |

Limits:

| FCC | IC |
|---|----|
| Band edge compliance radiated | |
| <p>In any 100 kHz bandwidth outside the frequency band in which the spread spectrum or digitally modulated intentional radiator is operating, the radio frequency power that is produced by the intentional radiator shall be at least 20 dB below that in the 100 kHz bandwidth within the band that contains the highest level of the desired power, based on either an RF conducted or a radiated measurement. Attenuation below the general limits specified in Section 15.209(a) is not required. In addition, radiated emissions which fall in the restricted bands, as defined in Section 15.205(a), must also comply with the radiated emission limits specified in Section 15.209(a) (see Section 5.205(c)).</p> | |
| 54 dBµV/m @ 3 m (AVG) 74 dBµV/m @ 3 m (Peak) | |

Results:

| Scenario | Band edge compliance radiated [dBµV/m] | | |
|-------------------------|--|--------------------|--------------------|
| | GFSK | Pi/4 DQPSK | 8DPSK |
| Modulation | | | |
| Lower restricted band | < 54 AVG / < 74 PP | < 54 AVG / < 74 PP | < 54 AVG / < 74 PP |
| Upper restricted band | < 54 AVG / < 74 PP | < 54 AVG / < 74 PP | < 54 AVG / < 74 PP |
| Measurement uncertainty | ± 3 dB | | |

Result: Passed

Plots:

Plot 1: Lower band edge, GFSK modulation, vertical & horizontal polarization

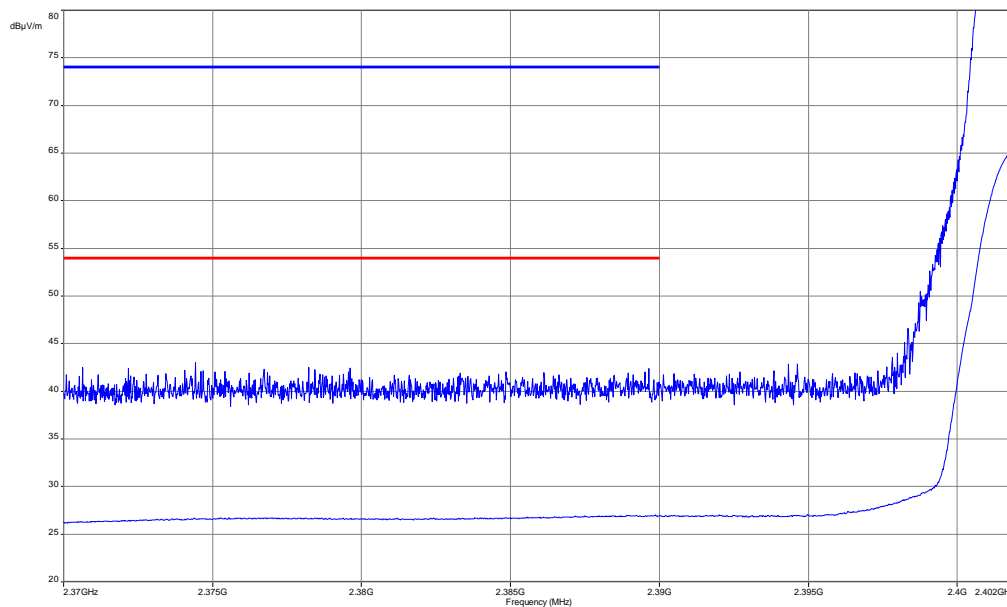

Plot 2: Upper band edge, GFSK modulation, vertical & horizontal polarization

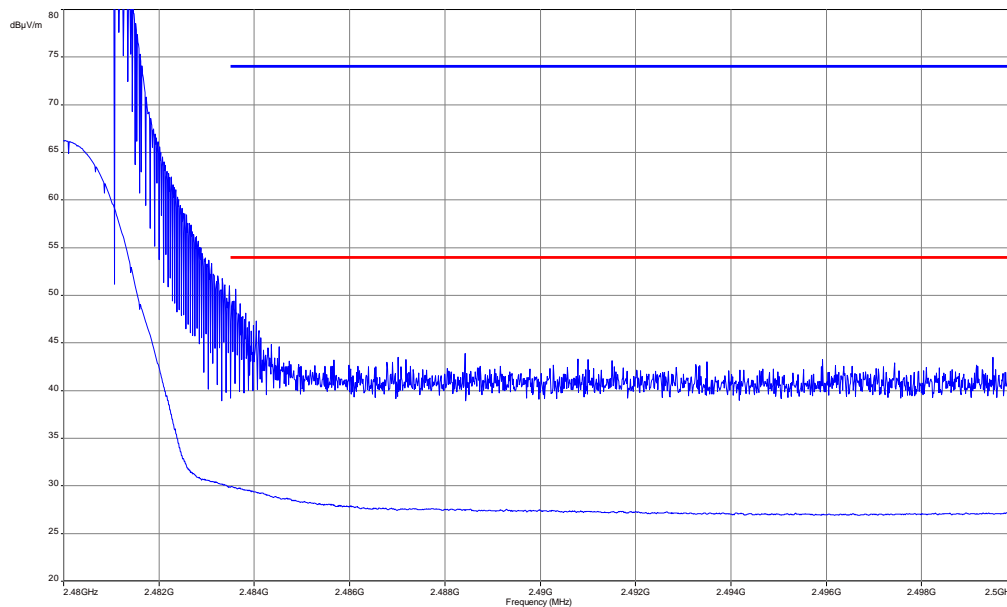

Plot 3: Lower band edge, Pi/4 DQPSK modulation, vertical & horizontal polarization

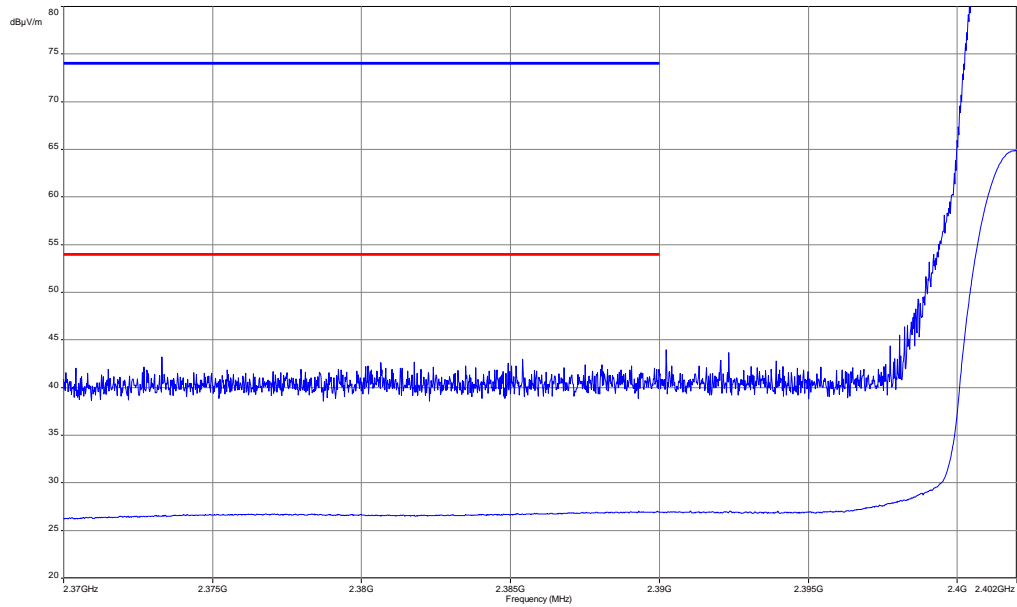

Plot 4: Upper band edge, Pi/4 DQPSK modulation, vertical & horizontal polarization

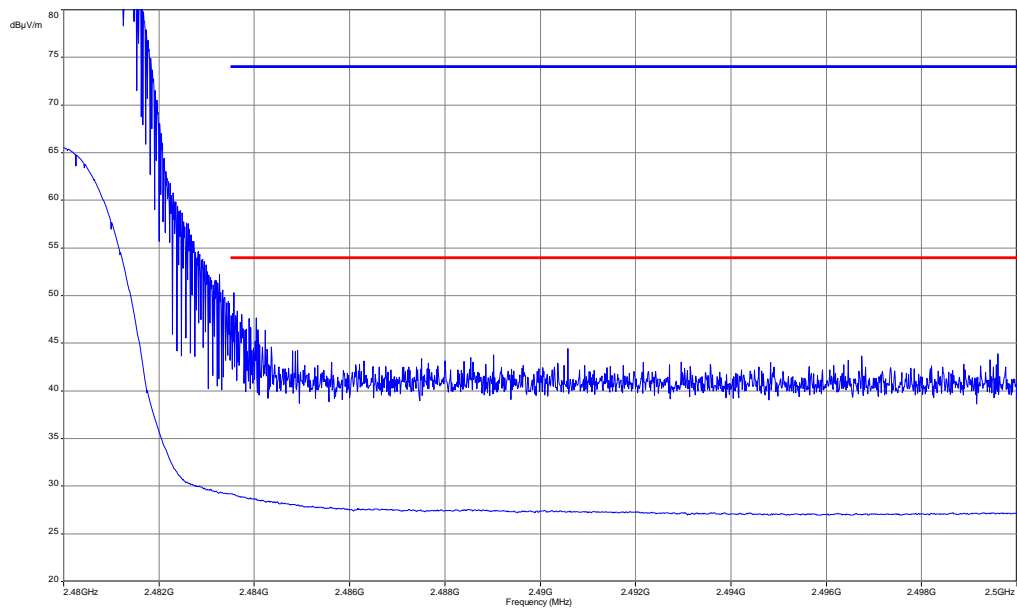

Plot 5: Lower band edge, 8 DPSK modulation, vertical & horizontal polarization

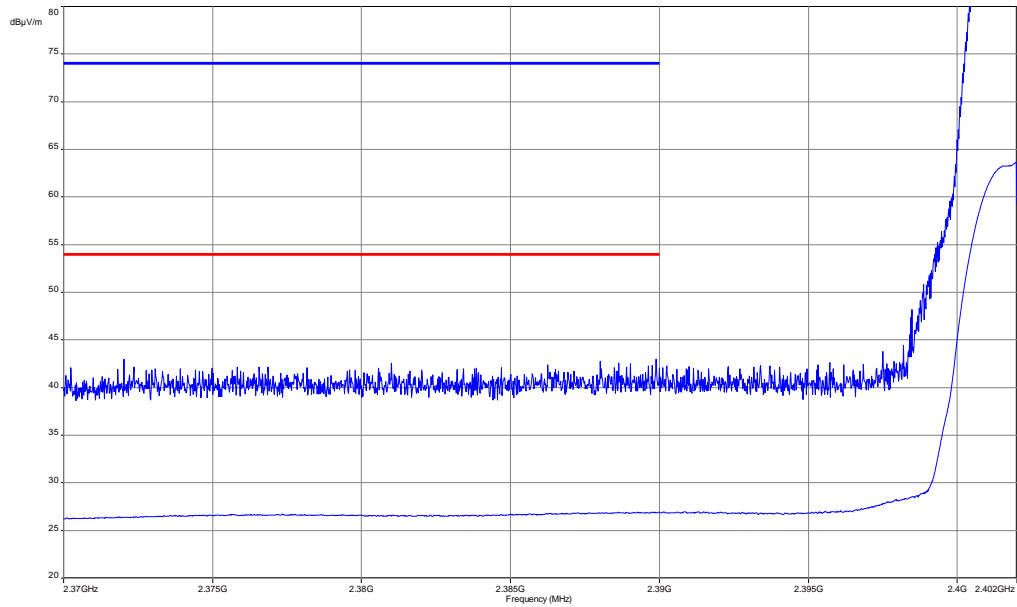

Plot 6: Upper band edge, 8 DPSK modulation, vertical & horizontal polarization

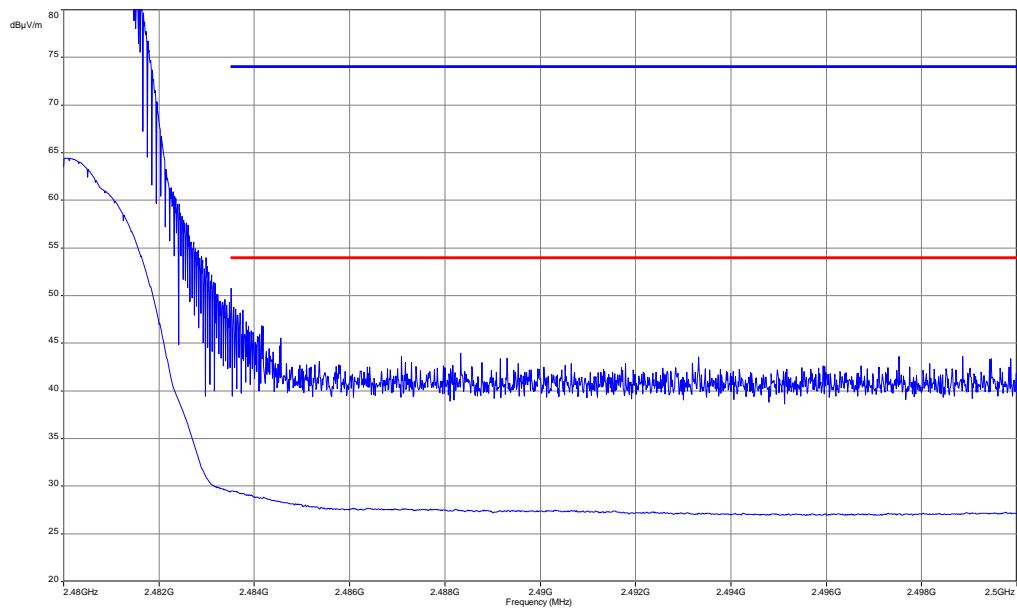

9.10 TX spurious emissions conducted

Description:

Measurement of the conducted spurious emissions in transmit mode. The EUT is set to single channel mode and the transmit channel is channel 00, channel 39 and channel 78. The measurement is repeated for all modulations.

Measurement:

| Measurement parameter | |
|-----------------------|--|
| Detector: | Peak |
| Sweep time: | Auto |
| Video bandwidth: | F < 1 GHz: 500 kHz F > 1 GHz: 500 kHz |
| Resolution bandwidth: | F < 1 GHz: 100 kHz F > 1 GHz: 100 kHz |
| Span: | 9 kHz to 25 GHz |
| Trace-Mode: | Max Hold |

Limits:

| FCC | IC |
|--|----|
| TX spurious emissions conducted | |
| In any 100 kHz bandwidth outside the frequency band in which the spread spectrum or digitally modulated intentional radiator is operating, the radio frequency power that is produced by the intentional radiator shall be at least 20 dB below that in the 100 kHz bandwidth within the band that contains the highest level of the desired power, based on either an RF conducted or a radiated measurement. Attenuation below the general limits specified in Section 15.209(a) is not required | |

Results:

| TX spurious emissions conducted | | | | | |
|---------------------------------|--|-----------------------------|-----------------------------------|--|---------------------|
| GFSK - mode | | | | | |
| f [MHz] | | amplitude of emission [dBm] | limit max. allowed emission power | actual attenuation below frequency of operation [dB] | results |
| 2402 | | 6.67 | 30 dBm | | Operating frequency |
| <i>No peaks detected.</i> | | | -20 dBc | | complies |
| | | | | | |
| 2441 | | 6.26 | 30 dBm | | Operating frequency |
| <i>No peaks detected.</i> | | | -20 dBc | | complies |
| | | | | | |
| 2480 | | 6.33 | 30 dBm | | Operating frequency |
| <i>No peaks detected.</i> | | | -20 dBc | | complies |
| | | | | | |
| Measurement uncertainty | | ± 3 dB | | | |

Result: Passed

Results:

| TX spurious emissions conducted | | | | | |
|---------------------------------|--|-----------------------------|-----------------------------------|--|---------------------|
| Pi/4-DQPSK - mode | | | | | |
| f [MHz] | | amplitude of emission [dBm] | limit max. allowed emission power | actual attenuation below frequency of operation [dB] | results |
| 2402 | | 7.02 | 30 dBm | | Operating frequency |
| <i>No peaks detected.</i> | | | -20 dBc | | complies |
| | | | | | |
| 2441 | | 6.62 | 30 dBm | | Operating frequency |
| <i>No peaks detected.</i> | | | -20 dBc | | complies |
| | | | | | |
| 2480 | | 6.70 | 30 dBm | | Operating frequency |
| <i>No peaks detected.</i> | | | -20 dBc | | complies |
| | | | | | |
| Measurement uncertainty | | ± 3dB | | | |

Result: Passed

Results:

| TX spurious emissions conducted | | | | | |
|---------------------------------|--|-----------------------------|-----------------------------------|--|---------------------|
| 8DPSK - mode | | | | | |
| f [MHz] | | amplitude of emission [dBm] | limit max. allowed emission power | actual attenuation below frequency of operation [dB] | results |
| 2402 | | 7.17 | 30 dBm | | Operating frequency |
| <i>No peaks detected.</i> | | | -20 dBc | | complies |
| | | | | | |
| 2441 | | 6.76 | 30 dBm | | Operating frequency |
| <i>No peaks detected.</i> | | | -20 dBc | | complies |
| | | | | | |
| 2480 | | 6.82 | 30 dBm | | Operating frequency |
| <i>No peaks detected.</i> | | | -20 dBc | | complies |
| | | | | | |
| Measurement uncertainty | | ± 3dB | | | |

Result: Passed

Plots:

Plot 1: lowest channel – 2402 MHz, GFSK modulation

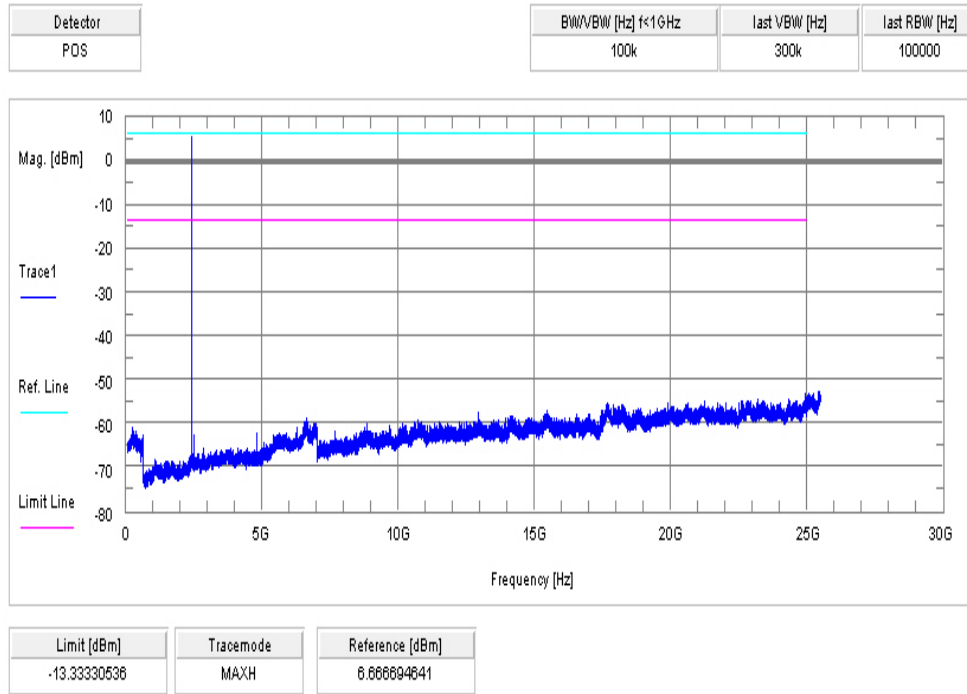

Plot 2: middle channel – 2441 MHz, GFSK modulation

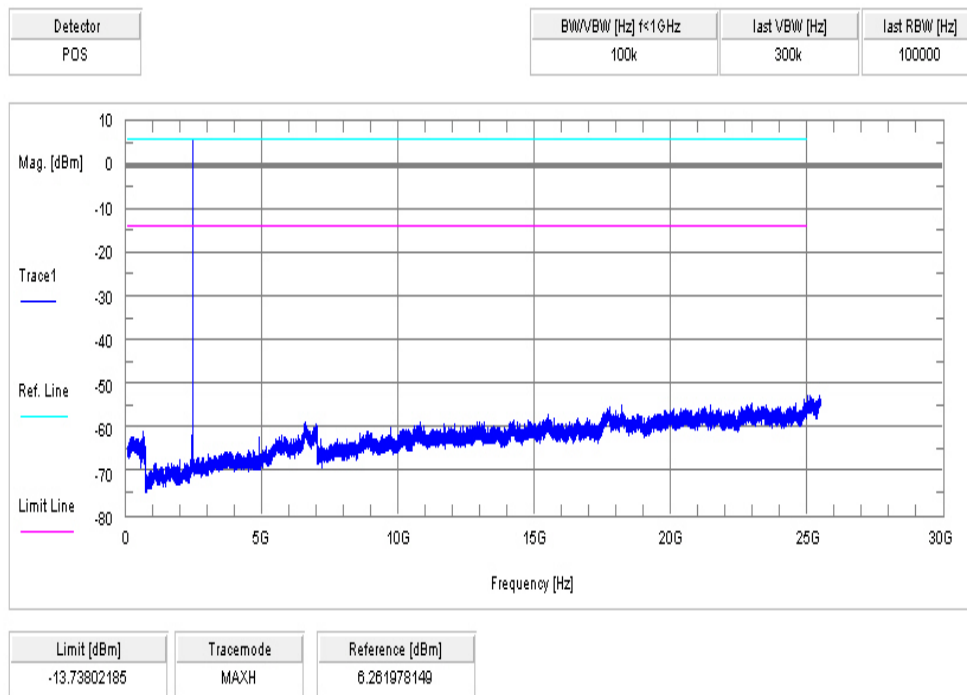

Plot 3: highest channel – 2480 MHz, GFSK modulation

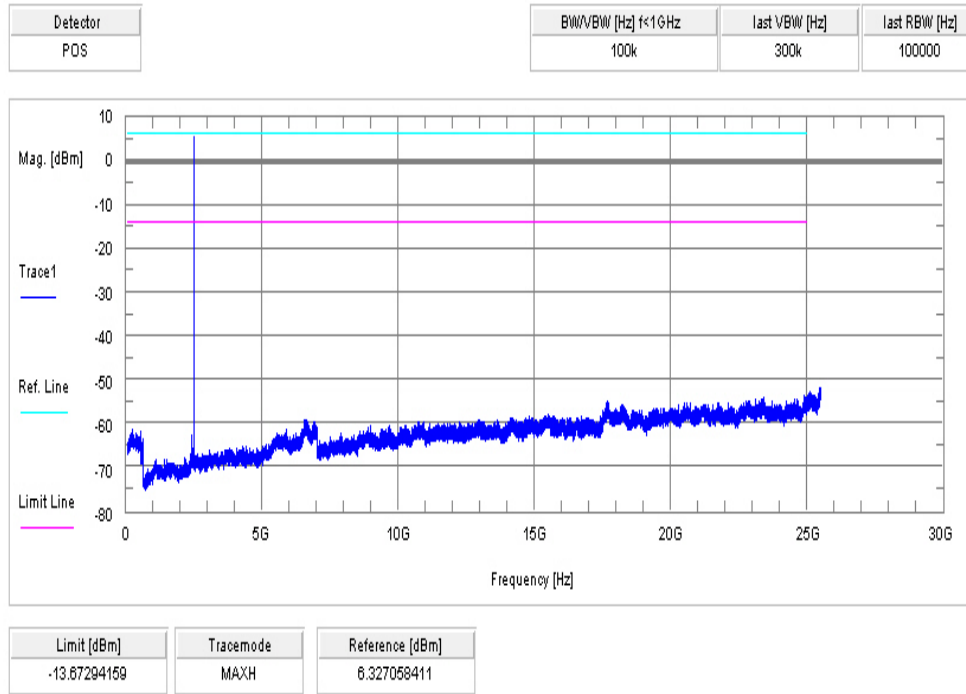

Plot 4: lowest channel – 2402 MHz, Pi / DQPSK modulation

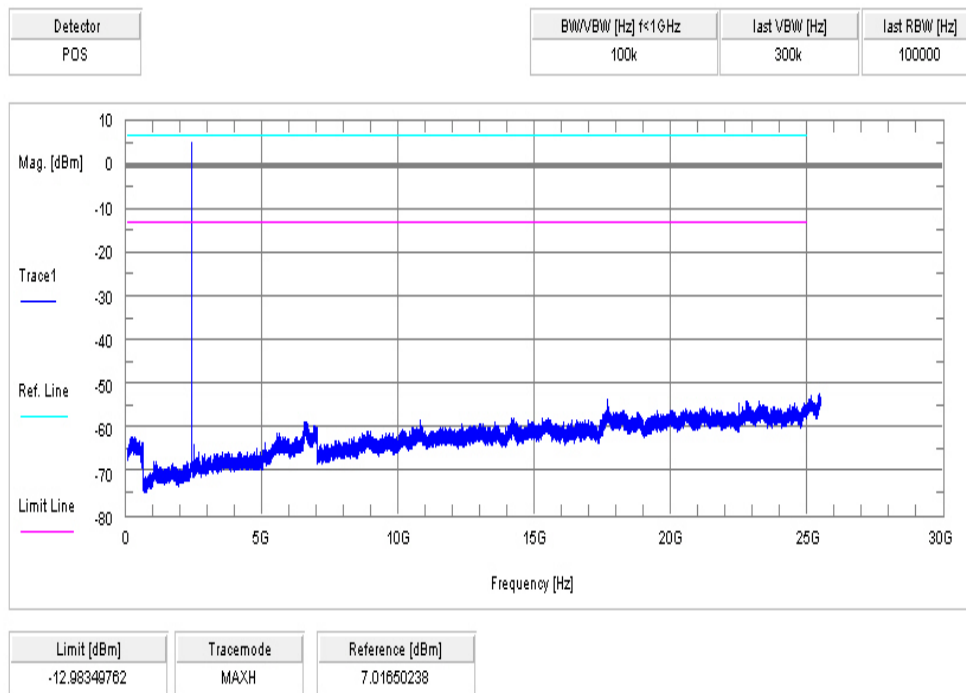

Plot 5: middle channel – 2441 MHz, Pi / DQPSK modulation

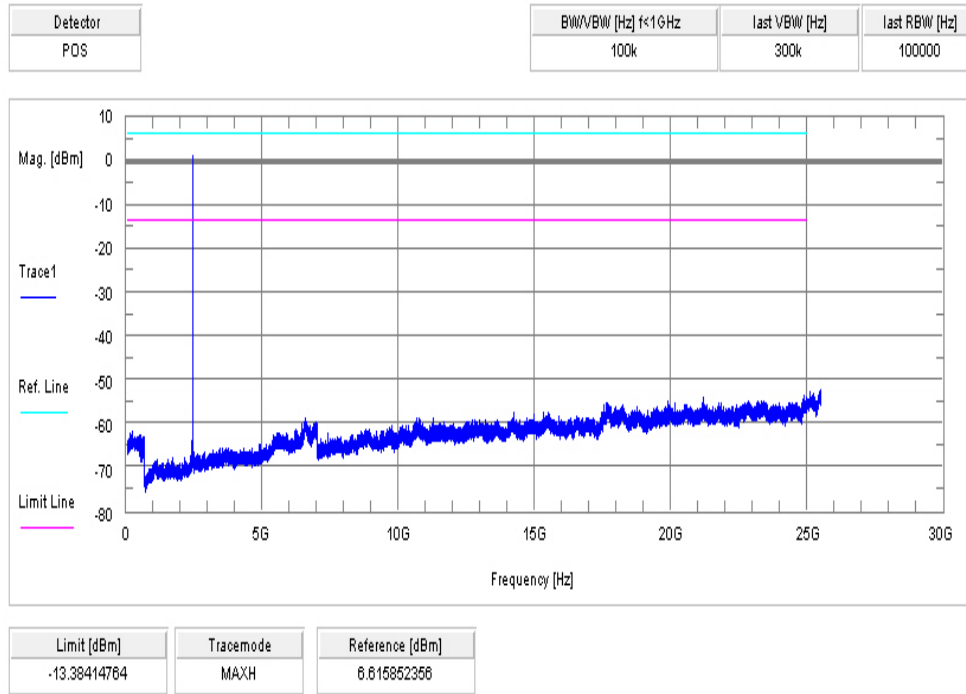

Plot 6: highest channel – 2480 MHz, Pi / DQPSK modulation

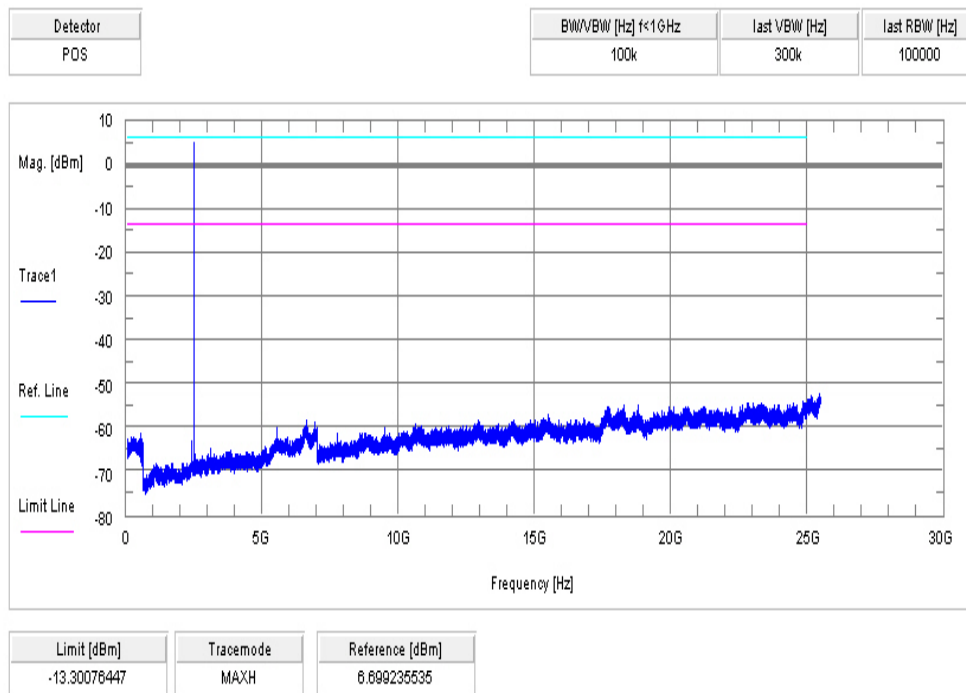

Plot 7: lowest channel – 2402 MHz, 8 DPSK modulation

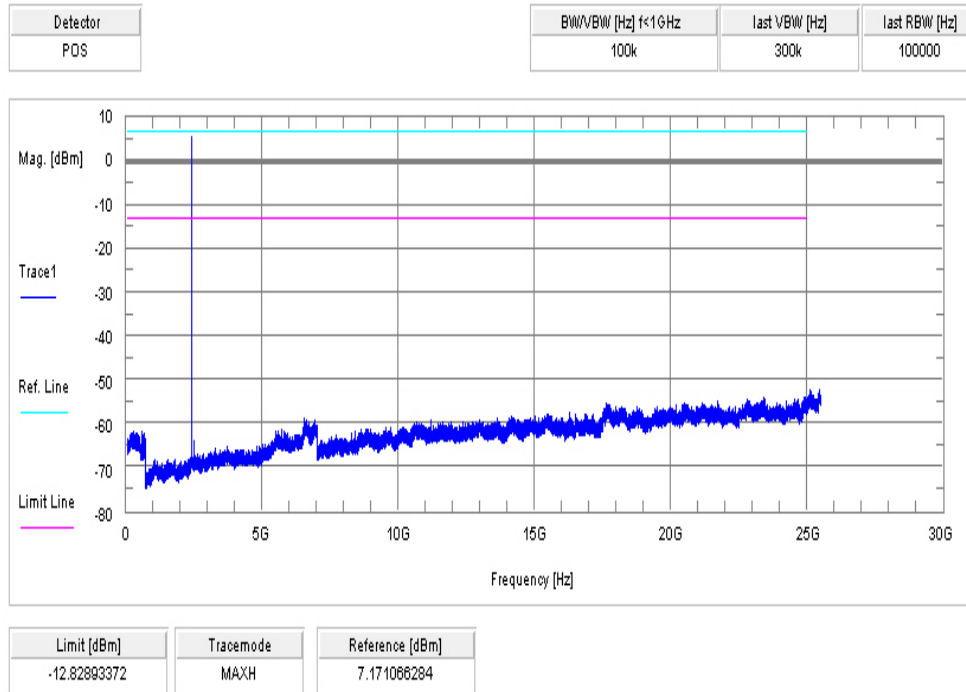

Plot 8: middle channel – 2441 MHz, 8 DPSK modulation

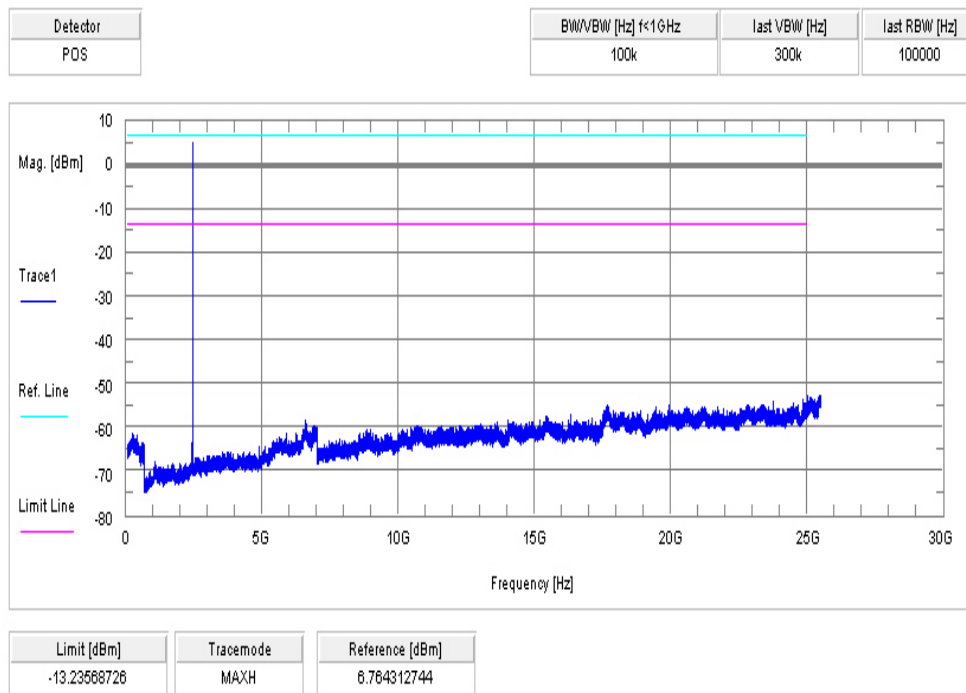

Plot 9: highest channel – 2480 MHz, 8 DPSK modulation

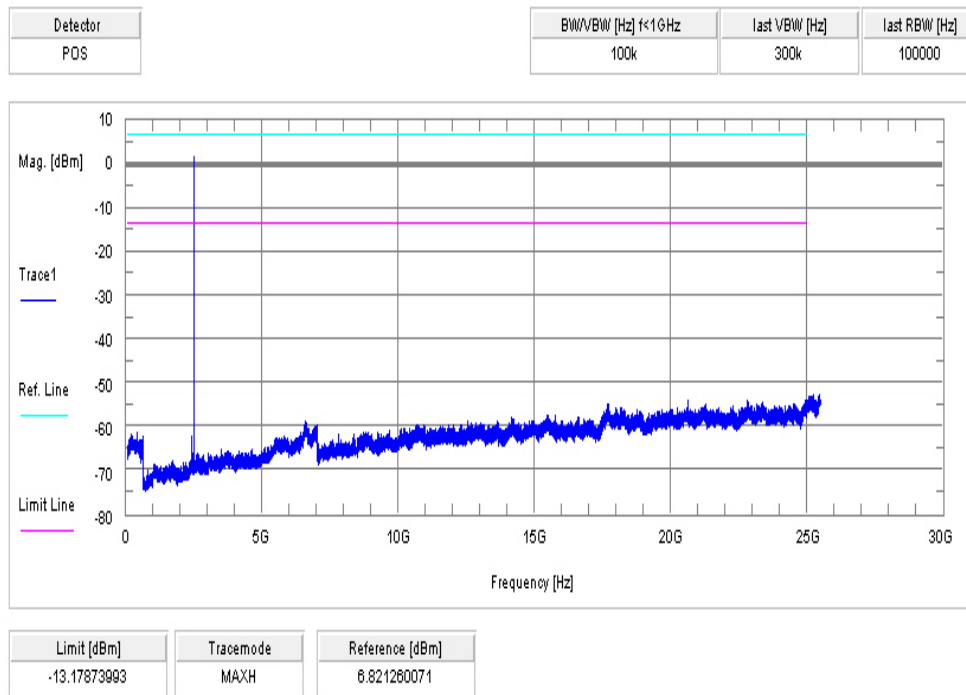

9.11 TX spurious emissions radiated

Description:

Measurement of the radiated spurious emissions in transmit mode. The EUT is set to single channel mode and the transmit channel is channel 00, channel 39 and channel 78. The measurement is performed in the mode with the highest output power.

Measurement:

| Measurement parameter | |
|-----------------------|---|
| Detector: | Peak / Quasi Peak |
| Sweep time: | Auto |
| Video bandwidth: | Sweep: 100 kHz Remeasurement: 10 Hz |
| Resolution bandwidth: | F < 1 GHz: 100 kHz F > 1 GHz: 1 MHz |
| Span: | 30 MHz to 25 GHz |
| Trace-Mode: | Max Hold |
| Measured Modulation: | <input type="checkbox"/> GFSK <input type="checkbox"/> Pi/4 DQPSK <input checked="" type="checkbox"/> 8DPSK |

The modulation with the highest output power was used to perform the transmitter spurious emissions. If spurious were detected a re-measurement was performed on the detected frequency with each modulation.

Limits:

| FCC | | IC | |
|--|-------------------------|----------------------|--|
| TX spurious emissions radiated | | | |
| In any 100 kHz bandwidth outside the frequency band in which the spread spectrum or digitally modulated intentional radiator is operating, the radio frequency power that is produced by the intentional radiator shall be at least 20 dB below that in the 100 kHz bandwidth within the band that contains the highest level of the desired power, based on either an RF conducted or a radiated measurement. Attenuation below the general limits specified in Section 15.209(a) is not required. In addition, radiated emissions which fall in the restricted bands, as defined in §15.205(a), must also comply with the radiated emission limits specified in §15.209(a) (see §15.205(c)). | | | |
| §15.209 | | | |
| Frequency (MHz) | Field strength (dBµV/m) | Measurement distance | |
| 30 - 88 | 30.0 | 10 | |
| 88 – 216 | 33.5 | 10 | |
| 216 – 960 | 36.0 | 10 | |
| Above 960 | 54.0 | 3 | |

Results:

| TX spurious emissions radiated [dBµV/m] | | | | | | | | |
|--|----------|----------------|--|----------|----------------|--|----------|----------------|
| 2402 MHz | | | 2441 MHz | | | 2480 MHz | | |
| F [MHz] | Detector | Level [dBµV/m] | F [MHz] | Detector | Level [dBµV/m] | F [MHz] | Detector | Level [dBµV/m] |
| For emissions below 1 GHz, please take a look at the table below the 1 GHz plot. | | | For emissions below 1 GHz, please take a look at the table below the 1 GHz plot. | | | For emissions below 1 GHz, please take a look at the table below the 1 GHz plot. | | |
| No emissions detected above 1 GHz. | | | No emissions detected above 1 GHz. | | | No emissions detected above 1 GHz. | | |
| Measurement uncertainty | | | ± 3 dB | | | | | |

Result: Passed

Plots:

Plot 1: 30 MHz to 1 GHz, TX mode, channel 00, vertical & horizontal polarization

Common Information

EUT: PM-0320--BV
 Test Description: FCC part 15 class B @ 10 m
 Operating Conditions: BT 3DH5 CH0
 Operator Name: Medrow
 Comment: AC: 115 V / 60 Hz

Scan Setup: STAN_Fin [EMI radiated]

Hardware Setup: Electric Field (NOS)
 Receiver: [ESCI 3]
 Level Unit: dBµV/m

| Subrange | Step Size | Detectors | IF BW | Meas. Time | Preamp |
|----------------|-----------|-----------|---------|------------|--------|
| 30 MHz - 2 GHz | 60 kHz | QPK | 120 kHz | 1 s | 20 dB |

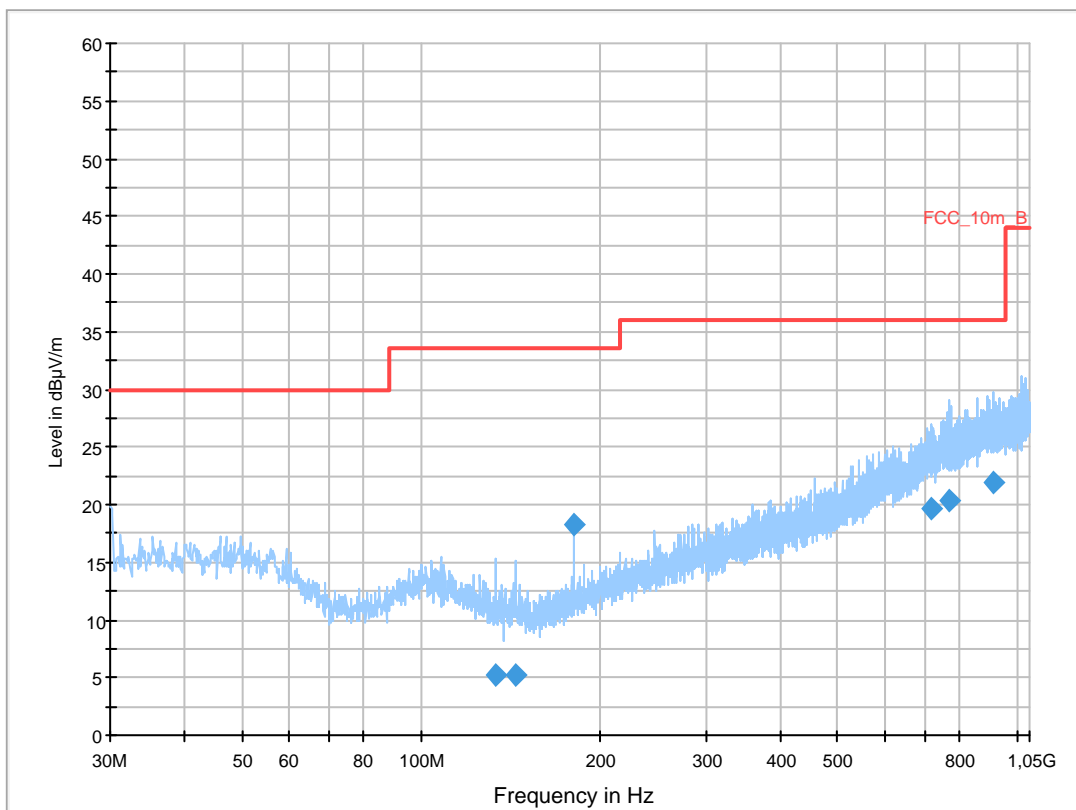

Final Result 1

| Frequency (MHz) | QuasiPeak (dBµV/m) | Meas. Time (ms) | Bandwidth (kHz) | Height (cm) | Polarization | Azimuth (deg) | Corr. (dB) | Margin (dB) | Limit (dBµV/m) | Comment |
|-----------------|--------------------|-----------------|-----------------|-------------|--------------|---------------|------------|-------------|----------------|---------|
| 133.561200 | 5.2 | 1000.0 | 120.000 | 170.0 | V | 261.0 | 9.1 | 28.3 | 33.5 | |
| 143.772150 | 5.3 | 1000.0 | 120.000 | 170.0 | V | 100.0 | 8.8 | 28.2 | 33.5 | |
| 179.999850 | 18.2 | 1000.0 | 120.000 | 98.0 | V | 93.0 | 10.4 | 15.3 | 33.5 | |
| 716.064300 | 19.7 | 1000.0 | 120.000 | 170.0 | V | 100.0 | 22.9 | 16.3 | 36.0 | |
| 771.912750 | 20.4 | 1000.0 | 120.000 | 98.0 | H | 85.0 | 23.7 | 15.6 | 36.0 | |
| 913.072650 | 21.9 | 1000.0 | 120.000 | 98.0 | H | 190.0 | 25.2 | 14.1 | 36.0 | |

Plot 2: 1 GHz to 12.75 GHz, TX mode, channel 00, vertical & horizontal polarization

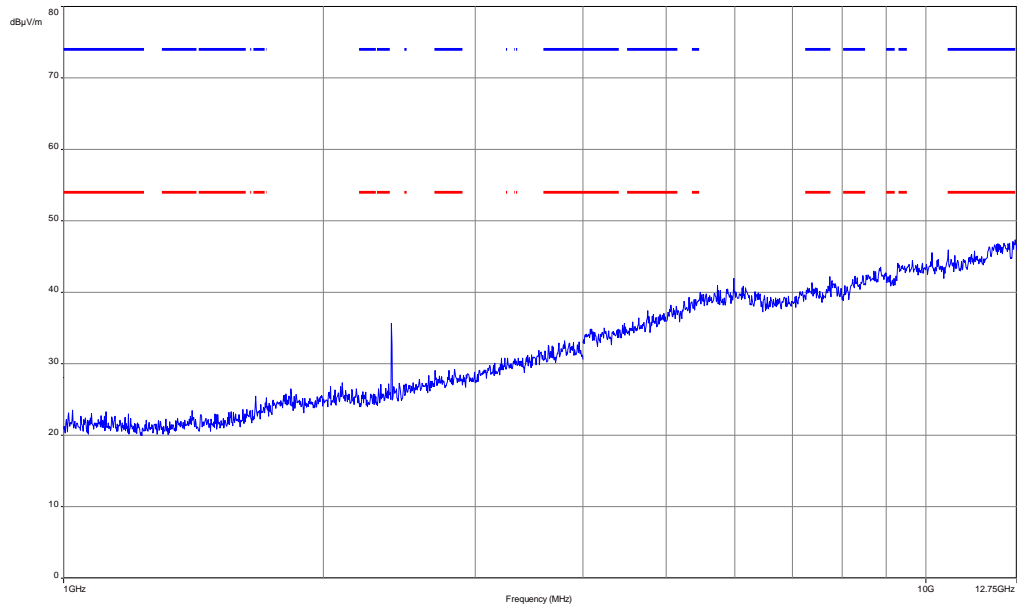

The carrier signal is notched with a 2.4 GHz band rejection filter.

Plot 3: 12.75 GHz to 18 GHz, TX mode, channel 00, vertical & horizontal polarization

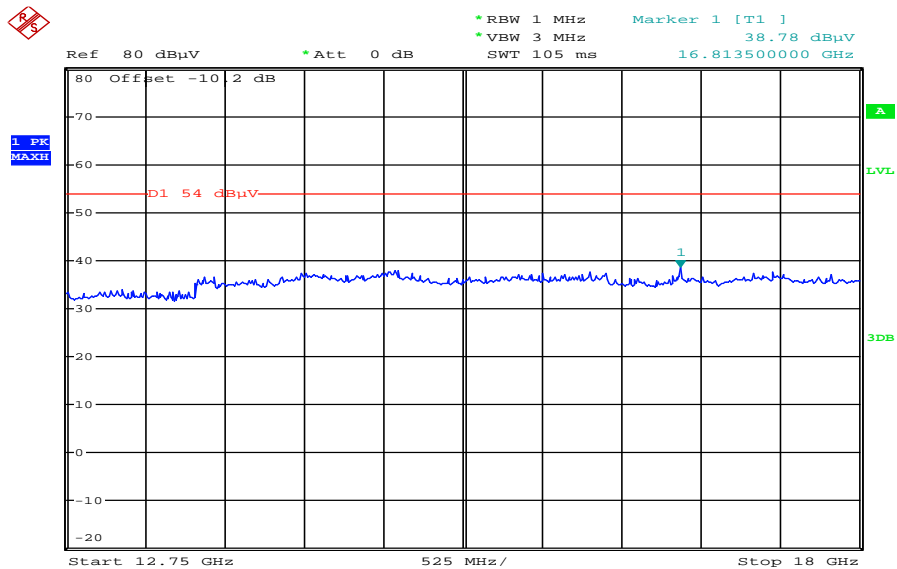

Date: 18.FEB.2013 08:02:30

Plot 4: 18 GHz to 26 GHz, TX mode, channel 00, vertical & horizontal polarization

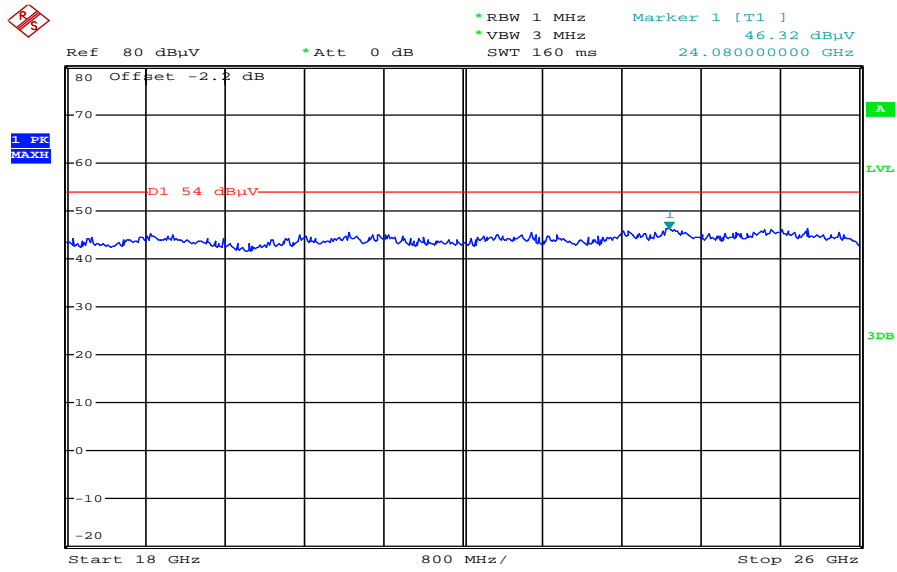

Date: 18.FEB.2013 08:10:17

Plot 5: 30 MHz to 1 GHz, TX mode, channel 39, vertical & horizontal polarization

Common Information

EUT: PM-0320--BV
 Test Description: FCC part 15 class B @ 10 m
 Operating Conditions: BT 3DH5 CH39
 Operator Name: Medrow
 Comment: AC: 115 V / 60 Hz

Scan Setup: STAN_Fin [EMI radiated]

Hardware Setup: Electric Field (NOS)
 Receiver: [ESCI 3]
 Level Unit: dBµV/m

| Subrange | Step Size | Detectors | IF BW | Meas. Time | Preamp |
|----------------|-----------|-----------|---------|------------|--------|
| 30 MHz - 2 GHz | 60 kHz | QPK | 120 kHz | 1 s | 20 dB |

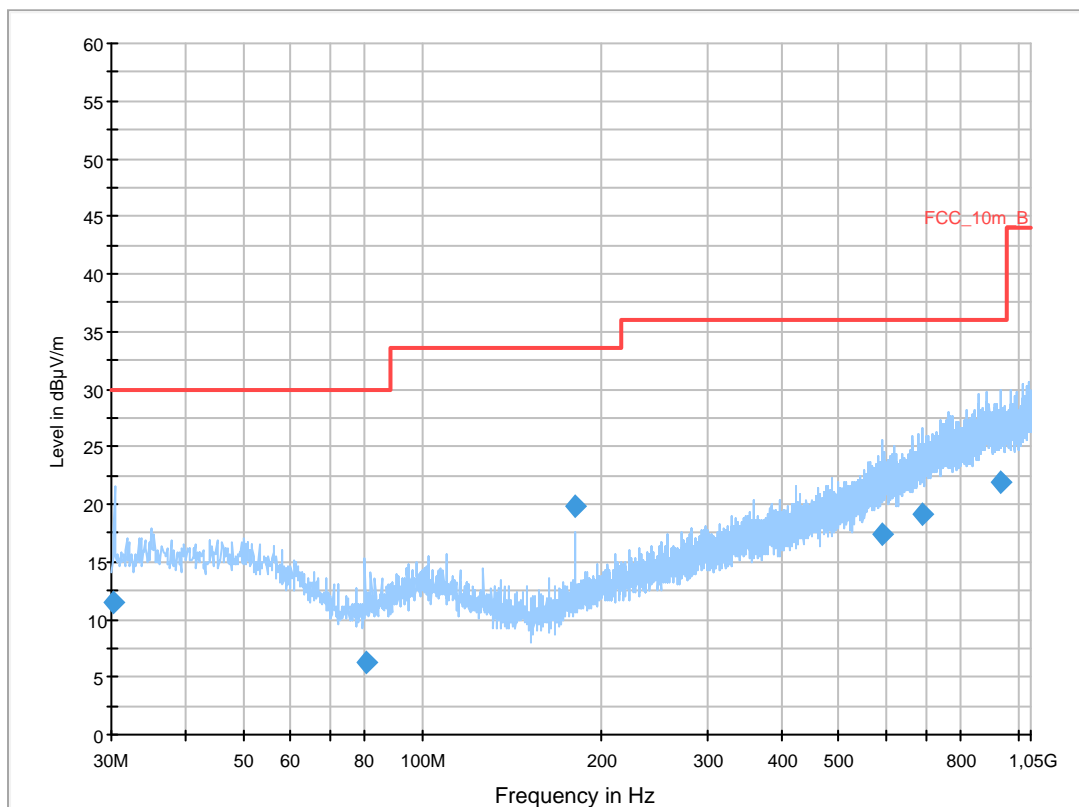

Final Result 1

| Frequency (MHz) | QuasiPeak (dBµV/m) | Meas. Time (ms) | Bandwidth (kHz) | Height (cm) | Polarization | Azimuth (deg) | Corr. (dB) | Margin (dB) | Limit (dBµV/m) | Comment |
|-----------------|--------------------|-----------------|-----------------|-------------|--------------|---------------|------------|-------------|----------------|---------|
| 30.297452 | 11.5 | 1000.0 | 120.000 | 98.0 | V | 190.0 | 12.5 | 18.5 | 30.0 | |
| 80.526750 | 6.3 | 1000.0 | 120.000 | 170.0 | V | 190.0 | 9.2 | 23.7 | 30.0 | |
| 180.016950 | 19.8 | 1000.0 | 120.000 | 134.0 | V | 260.0 | 10.4 | 13.7 | 33.5 | |
| 591.310350 | 17.4 | 1000.0 | 120.000 | 170.0 | V | 190.0 | 20.6 | 18.6 | 36.0 | |
| 693.105600 | 19.1 | 1000.0 | 120.000 | 112.0 | V | 10.0 | 22.3 | 16.9 | 36.0 | |
| 934.631700 | 21.9 | 1000.0 | 120.000 | 147.0 | H | 180.0 | 25.3 | 14.1 | 36.0 | |

Plot 6: 1 GHz to 12.75 GHz, TX mode, channel 39, vertical & horizontal polarization

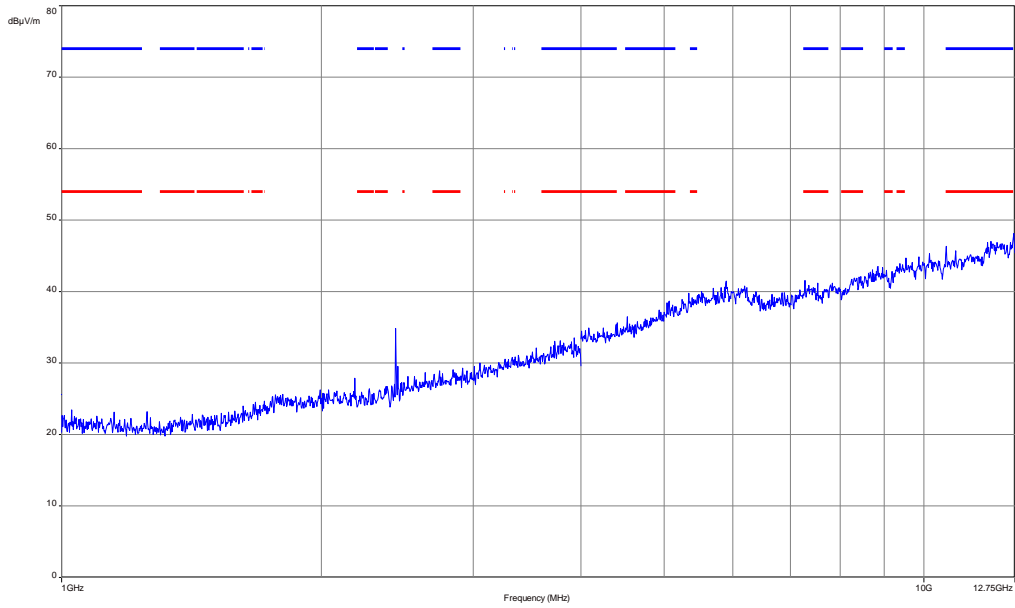

The carrier signal is notched with a 2.4 GHz band rejection filter.

Plot 7: 12.75 GHz to 18 GHz, TX mode, channel 39, vertical & horizontal polarization

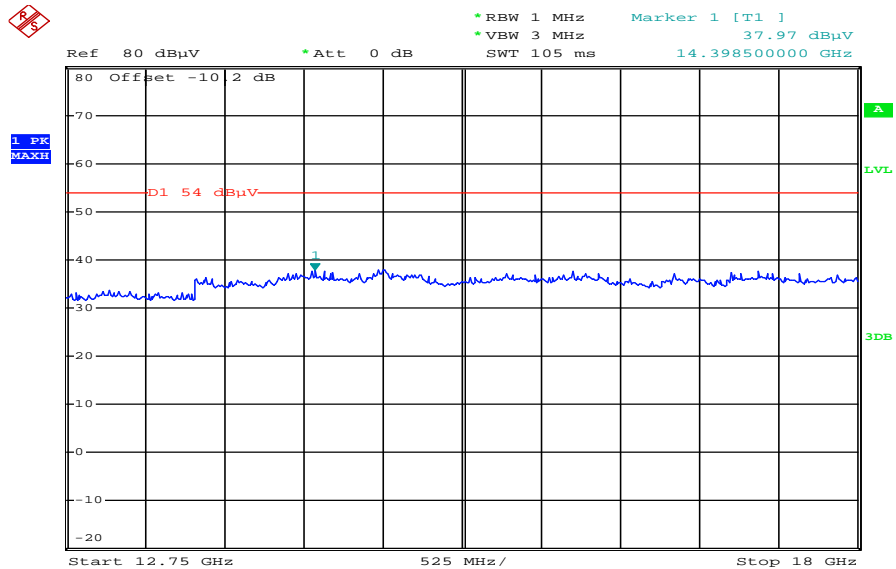

Date: 18.FEB.2013 08:05:18

Plot 8: 18 GHz to 26 GHz, TX mode, channel 39, vertical & horizontal polarization

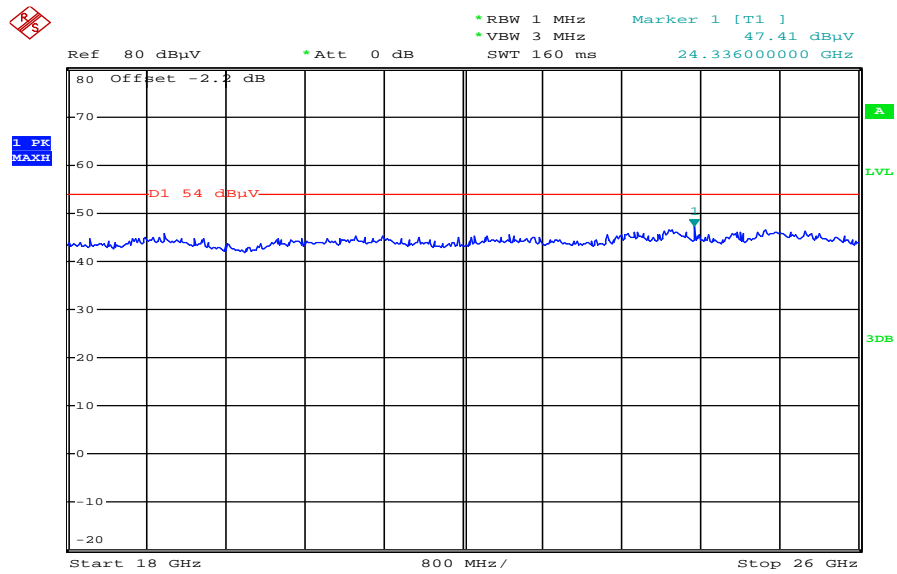

Date: 18.FEB.2013 08:09:42

Plot 9: 30 MHz to 1 GHz, TX mode, channel 78, vertical & horizontal polarization

Common Information

EUT: PM-0320--BV
 Test Description: FCC part 15 class B @ 10 m
 Operating Conditions: BT CH78
 Operator Name: Medrow
 Comment: AC: 115 V / 60 Hz

Scan Setup: STAN_Fin [EMI radiated]

Hardware Setup: Electric Field (NOS)
 Receiver: [ESCI 3]
 Level Unit: dBµV/m

| Subrange | Step Size | Detectors | IF BW | Meas. Time | Preamp |
|----------------|-----------|-----------|---------|------------|--------|
| 30 MHz - 2 GHz | 60 kHz | QPK | 120 kHz | 1 s | 20 dB |

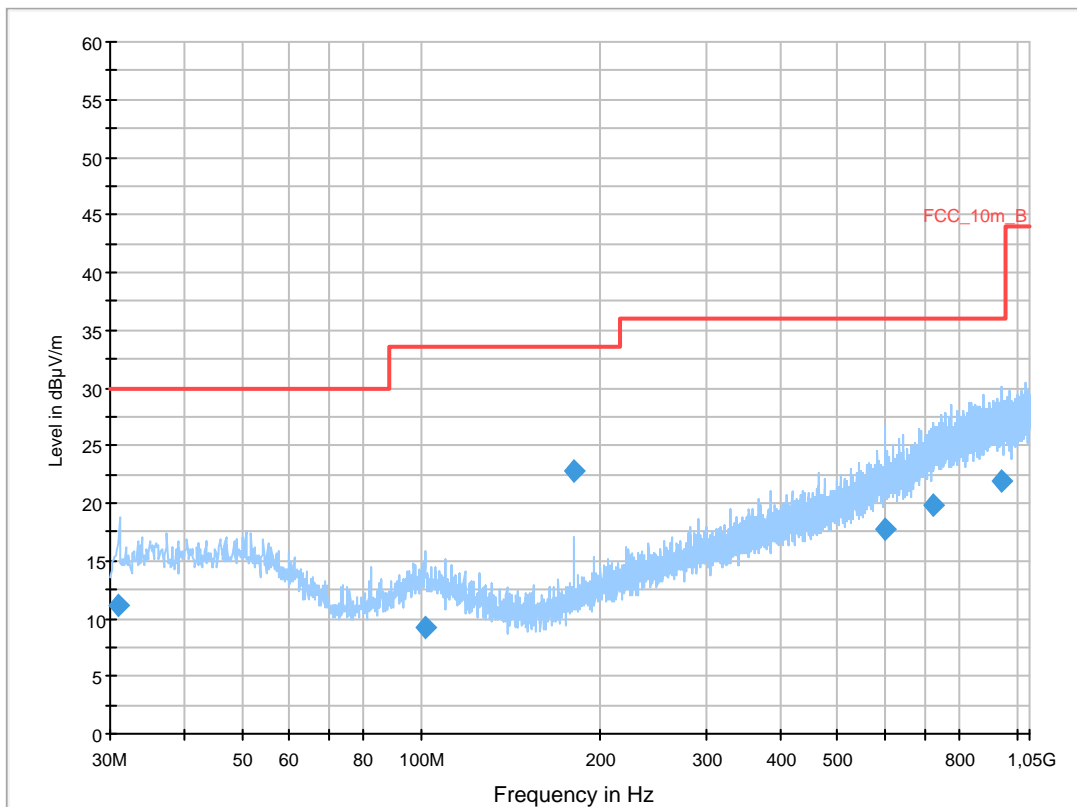

Final Result 1

| Frequency (MHz) | QuasiPeak (dBµV/m) | Meas. Time (ms) | Bandwidth (kHz) | Height (cm) | Polarization | Azimuth (deg) | Corr. (dB) | Margin (dB) | Limit (dBµV/m) | Comment |
|-----------------|--------------------|-----------------|-----------------|-------------|--------------|---------------|------------|-------------|----------------|---------|
| 30.934950 | 11.1 | 1000.0 | 120.000 | 98.0 | V | 270.0 | 12.6 | 18.9 | 30.0 | |
| 101.707800 | 9.3 | 1000.0 | 120.000 | 171.0 | V | 170.0 | 11.7 | 24.2 | 33.5 | |
| 180.028050 | 22.7 | 1000.0 | 120.000 | 98.0 | V | 260.0 | 10.4 | 10.8 | 33.5 | |
| 599.437350 | 17.7 | 1000.0 | 120.000 | 171.0 | H | 280.0 | 20.8 | 18.3 | 36.0 | |
| 724.235250 | 19.9 | 1000.0 | 120.000 | 121.0 | H | 11.0 | 23.1 | 16.1 | 36.0 | |
| 939.730350 | 22.0 | 1000.0 | 120.000 | 171.0 | H | 11.0 | 25.3 | 14.0 | 36.0 | |

Plot 10: 1 GHz to 12.75 GHz, TX mode, channel 78, vertical & horizontal polarization

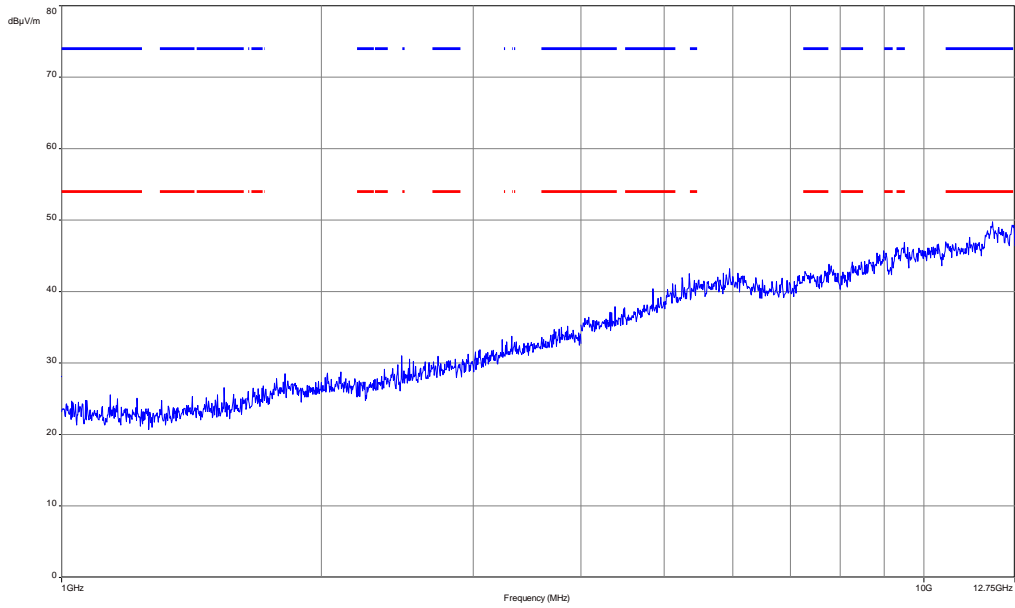

The carrier signal is notched with a 2.4 GHz band rejection filter.

Plot 11: 12.75 GHz to 18 GHz, TX mode, channel 78, vertical & horizontal polarization

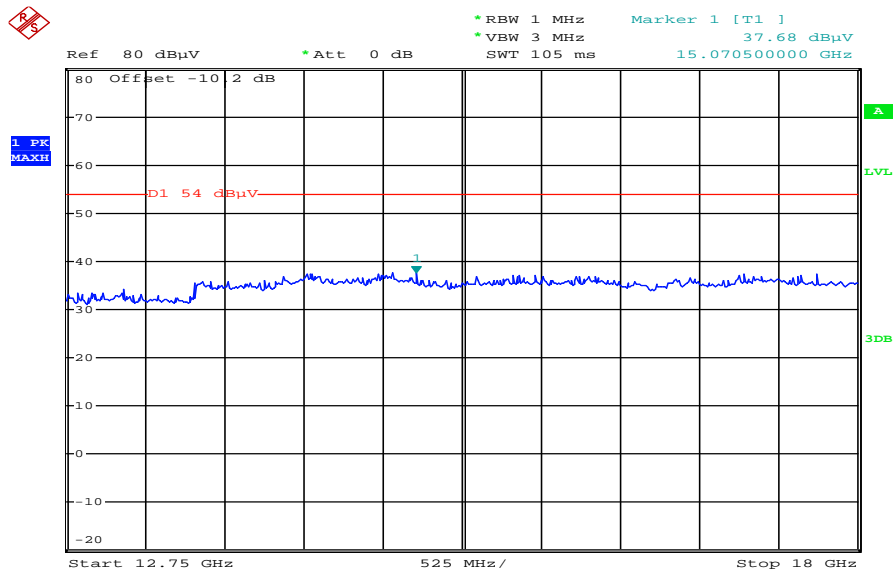

Date: 18.FEB.2013 08:06:07

Plot 12: 18 GHz to 26 GHz, TX mode, channel 78, vertical & horizontal polarization

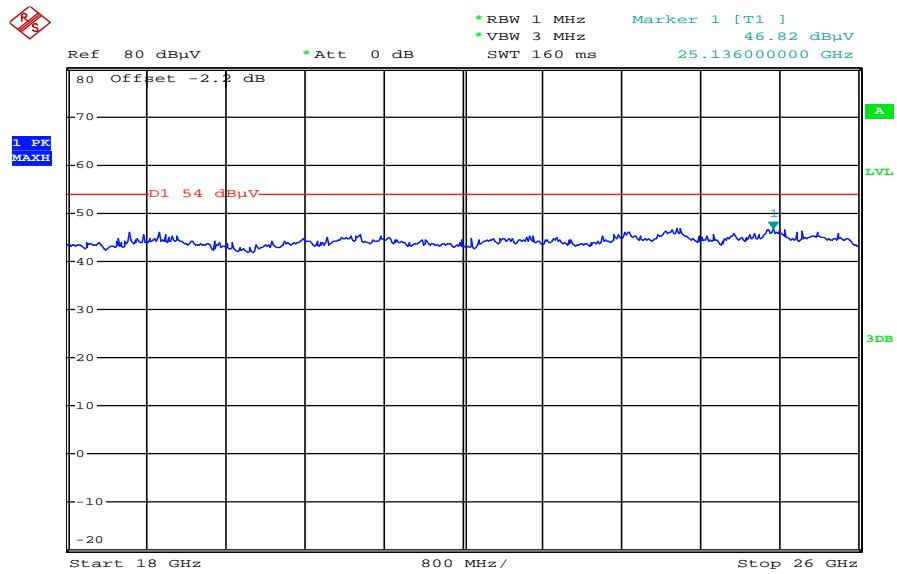

Date: 18.FEB.2013 08:08:56

9.12 RX spurious emissions radiated

Description:

Measurement of the radiated spurious emissions in idle/receive mode. The EUT is detached so all oscillators are active.

Measurement:

| Measurement parameter | |
|-----------------------|--|
| Detector: | Peak / Quasi peak |
| Sweep time: | Auto |
| Video bandwidth: | Sweep: 100 kHz Remeasurement: 10 Hz |
| Resolution bandwidth: | F < 1 GHz: 100 kHz F > 1 GHz: 1 MHz |
| Span: | 30 MHz to 25 GHz |
| Trace-Mode: | Max Hold |

Limits:

| FCC | | IC |
|--------------------------------|-------------------------------|----------------------|
| RX Spurious Emissions Radiated | | |
| Frequency (MHz) | Field strength (dB μ V/m) | Measurement distance |
| 30 - 88 | 30.0 | 10 |
| 88 - 216 | 33.5 | 10 |
| 216 - 960 | 36.0 | 10 |
| Above 960 | 54.0 | 3 |

Results:

| RX spurious emissions radiated [dB μ V/m] | | |
|--|----------|----------------------|
| F [MHz] | Detector | Level [dB μ V/m] |
| For emissions below 1 GHz, please take a look at the table below the 1 GHz plot. | | |
| No emissions detected above 1 GHz. | | |
| Measurement uncertainty | ±3 dB | |

Result: Passed

Plots:

Plot 1: 30 MHz to 1 GHz, RX mode, vertical & horizontal polarization

Common Information

EUT: PM-0320--BV
 Test Description: EN 55022 class B @ 10 m
 Operating Conditions: BT 3DH5 idle
 Operator Name: Medrow
 Comment: AC: 115 V / 60 Hz

Scan Setup: STAN_Fin [EMI radiated]

Hardware Setup: Electric Field (NOS)
 Receiver: [ESCI 3]
 Level Unit: dBµV/m

| Subrange | Step Size | Detectors | IF BW | Meas. Time | Preamp |
|----------------|-----------|-----------|---------|------------|--------|
| 30 MHz - 2 GHz | 60 kHz | QPK | 120 kHz | 1 s | 20 dB |

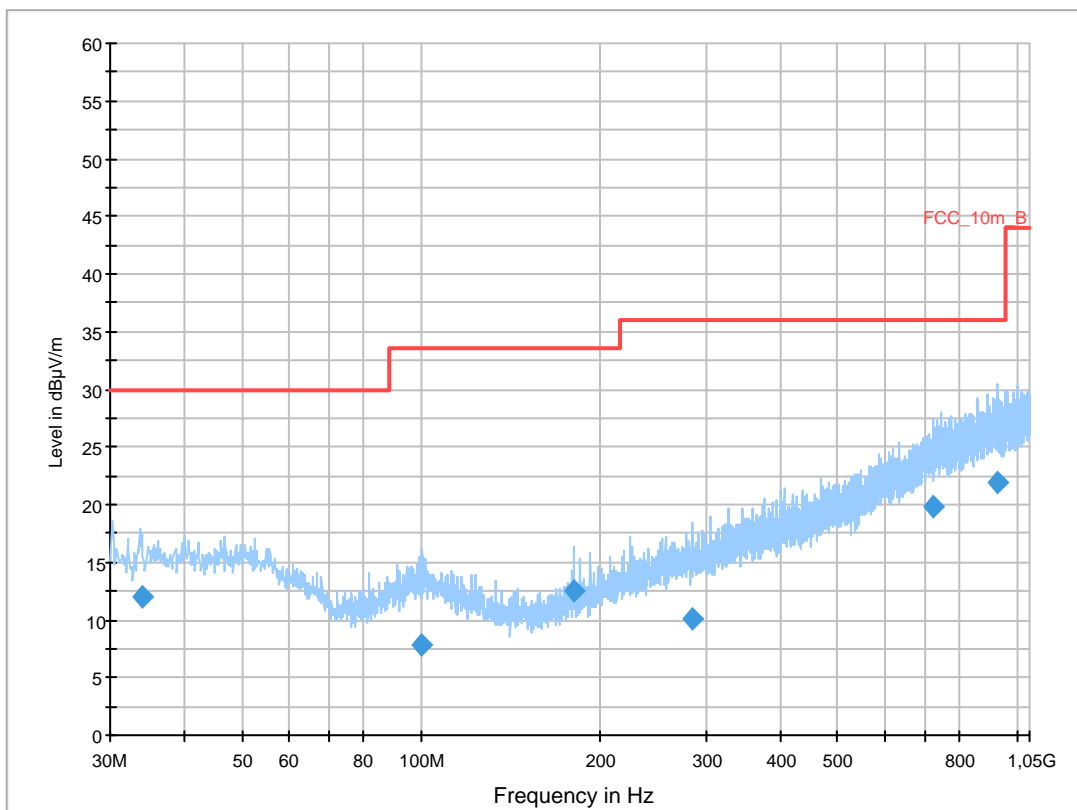

Final Result 1

| Frequency (MHz) | QuasiPeak (dBµV/m) | Meas. Time (ms) | Bandwidth (kHz) | Height (cm) | Polarization | Azimuth (deg) | Corr. (dB) | Margin (dB) | Limit (dBµV/m) | Comment |
|-----------------|--------------------|-----------------|-----------------|-------------|--------------|---------------|------------|-------------|----------------|---------|
| 34.026300 | 12.0 | 1000.0 | 120.000 | 104.0 | V | 3.0 | 12.9 | 18.0 | 30.0 | |
| 100.023300 | 7.8 | 1000.0 | 120.000 | 170.0 | V | 280.0 | 11.9 | 25.7 | 33.5 | |
| 180.075000 | 12.5 | 1000.0 | 120.000 | 98.0 | V | 280.0 | 10.4 | 21.0 | 33.5 | |
| 285.433950 | 10.1 | 1000.0 | 120.000 | 116.0 | V | 170.0 | 14.2 | 25.9 | 36.0 | |
| 723.088650 | 19.8 | 1000.0 | 120.000 | 170.0 | H | 265.0 | 23.0 | 16.2 | 36.0 | |
| 930.414450 | 22.0 | 1000.0 | 120.000 | 170.0 | H | 265.0 | 25.3 | 14.0 | 36.0 | |

Plot 2: 1 GHz to 12.75 GHz, RX mode, vertical & horizontal polarization

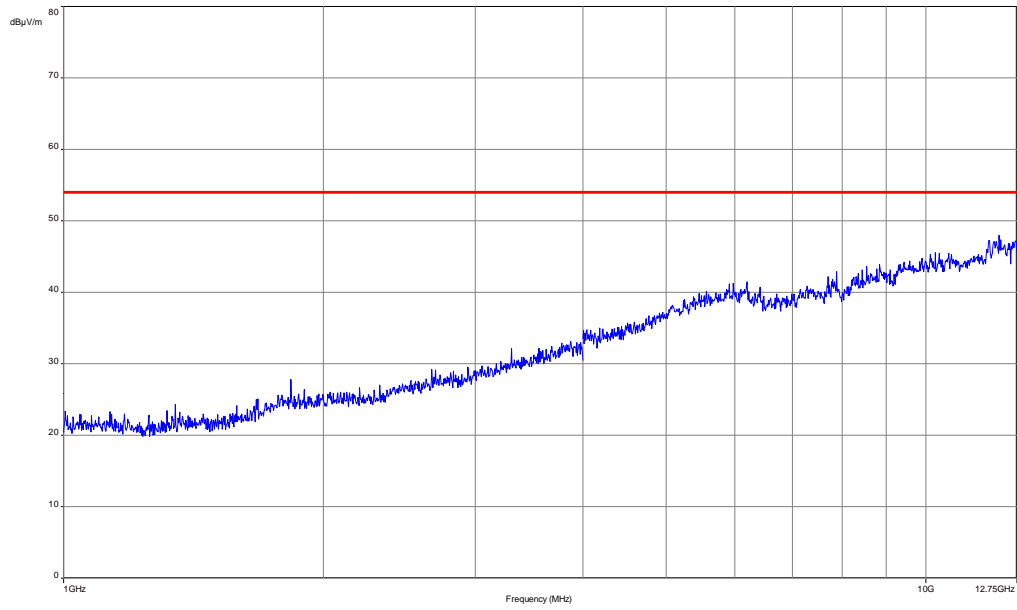

Plot 3: 12.75 GHz to 18 GHz, RX mode, vertical & horizontal polarization

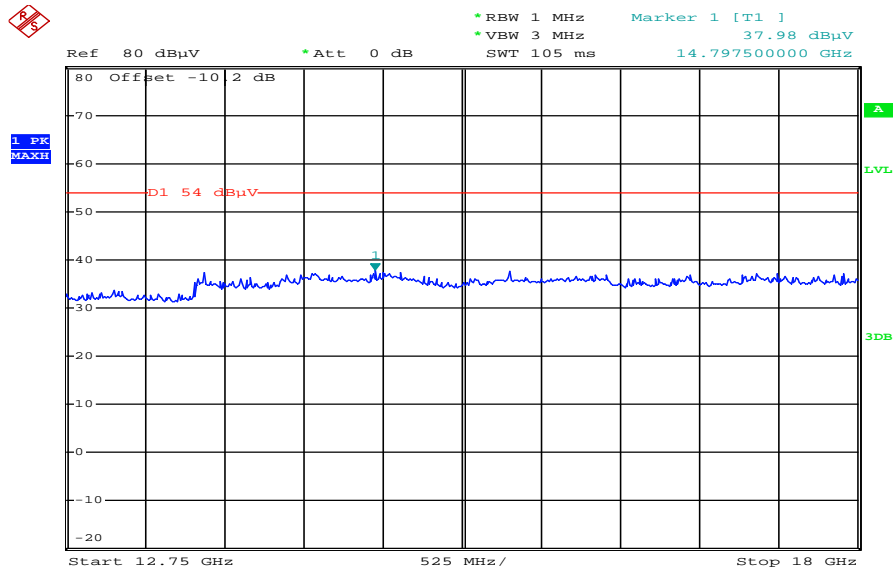

Date: 18.FEB.2013 08:06:40

Plot 4: 18 GHz to 26 GHz, RX mode, vertical & horizontal polarization

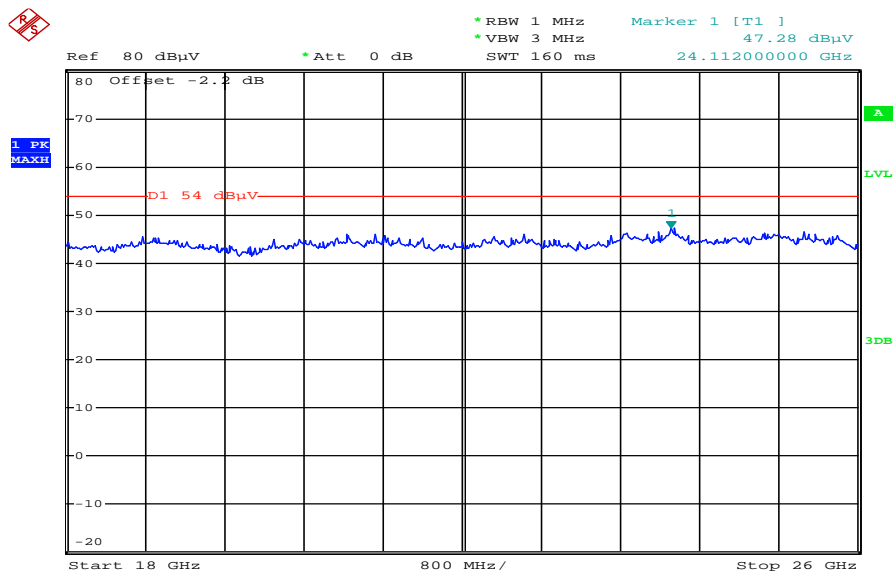

Date: 18.FEB.2013 08:08:12

9.13 Spurious emissions radiated < 30 MHz

Description:

Measurement of the radiated spurious emissions in transmit mode below 30 MHz. The EUT is set to single channel mode and the transmit channel is channel 39. This measurement is representative for all channels and modes. If critical peaks are found channel 00 and channel 78 will be measured too. The measurement is performed in the mode with the highest output power. The limits are recalculated to a measurement distance of 3 m with 40 dB/decade according CFR Part 2.

Measurement:

| Measurement parameter | |
|-----------------------|--|
| Detector: | Peak / Quasi peak |
| Sweep time: | Auto |
| Video bandwidth: | F < 150 kHz: 200 Hz F > 150 kHz: 9 kHz |
| Resolution bandwidth: | F < 150 kHz: 1 kHz F > 150 kHz: 100 kHz |
| Span: | 9 kHz to 30 MHz |
| Trace-Mode: | Max Hold |

Limits:

| FCC | | IC |
|---|-------------------------|----------------------|
| TX spurious emissions radiated < 30 MHz | | |
| Frequency (MHz) | Field strength (dBµV/m) | Measurement distance |
| 0.009 – 0.490 | 2400/F(kHz) | 300 |
| 0.490 – 1.705 | 24000/F(kHz) | 30 |
| 1.705 – 30.0 | 30 | 30 |

Results:

| TX spurious emissions radiated < 30 MHz [dBµV/m] | | |
|--|----------|----------------|
| F [MHz] | Detector | Level [dBµV/m] |
| No critical peaks detected | | |
| Measurement uncertainty | ± 3 dB | |

Result: Passed

Plots:

Plot 1: 9 kHz to 30 MHz, TX mode

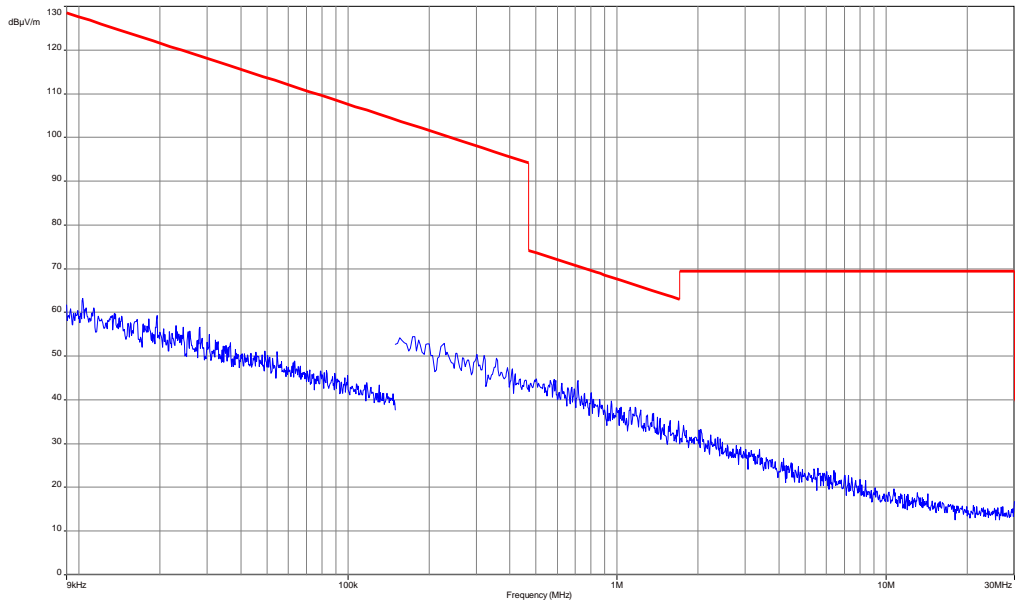

Plot 2: 9 kHz to 30 MHz, RX mode

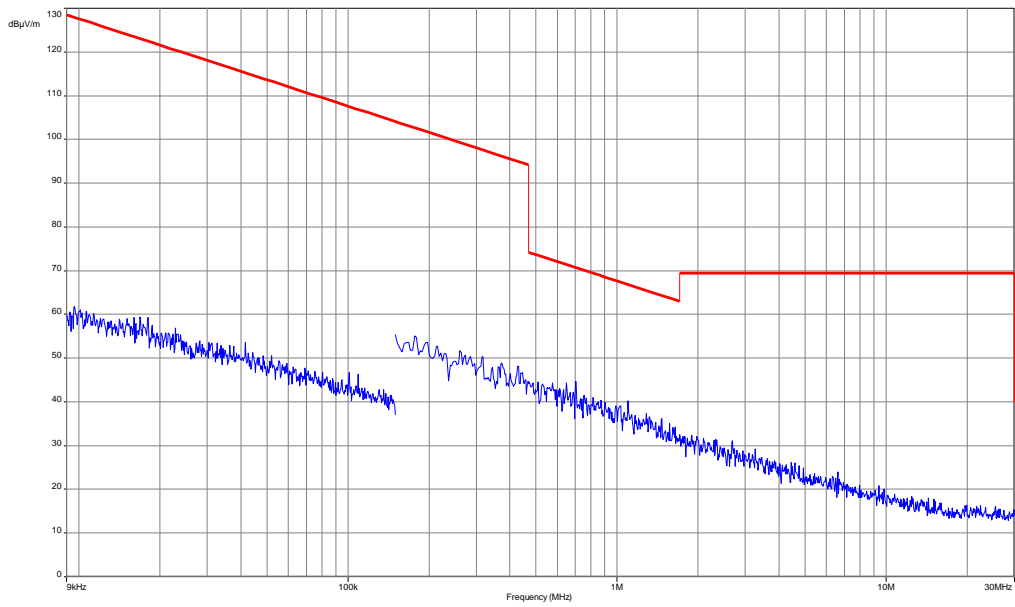

9.14 Spurious emissions conducted < 30 MHz

Description:

Measurement of the conducted spurious emissions in transmit mode below 30 MHz. The EUT is set to single channel mode and the transmit channel is channel 39. This measurement is representative for all channels and modes. If critical peaks are found channel 00 and channel 78 will be measured too. The measurement is performed in the mode with the highest output power. Both power lines, phase and neutral line, are measured. Found peaks are remeasured with average and quasi peak detection to show compliance to the limits.

Measurement:

| Measurement parameter | |
|-----------------------|--|
| Detector: | Peak - Quasi peak / average |
| Sweep time: | Auto |
| Video bandwidth: | F < 150 kHz: 200 Hz F > 150 kHz: 9 kHz |
| Resolution bandwidth: | F < 150 kHz: 1 kHz F > 150 kHz: 100 kHz |
| Span: | 9 kHz to 30 MHz |
| Trace-Mode: | Max Hold |

Limits:

| FCC | | IC |
|--|---------------------|------------------|
| TX spurious emissions conducted < 30 MHz | | |
| Frequency (MHz) | Quasi-peak (dBµV/m) | Average (dBµV/m) |
| 0.15 – 0.5 | 66 to 56* | 56 to 46* |
| 0.5 – 5 | 56 | 46 |
| 5 – 30.0 | 60 | 50 |

*Decreases with the logarithm of the frequency

Results:

| TX spurious emissions conducted < 30 MHz [dBµV/m] | | |
|---|----------|----------------|
| F [MHz] | Detector | Level [dBµV/m] |
| No critical peaks detected | | |
| Measurement uncertainty | ± 3 dB | |

Result: Passed

Plots:

Plot 1: 150 kHz to 30 MHz, TX mode, phase line

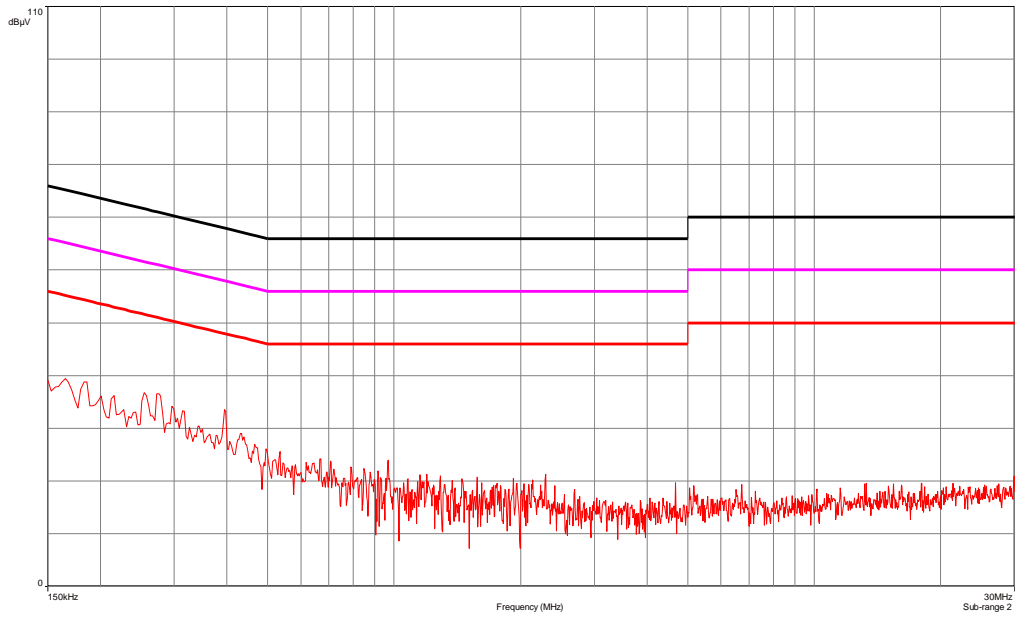

Plot 2: 150 kHz to 30 MHz, TX mode, neutral line

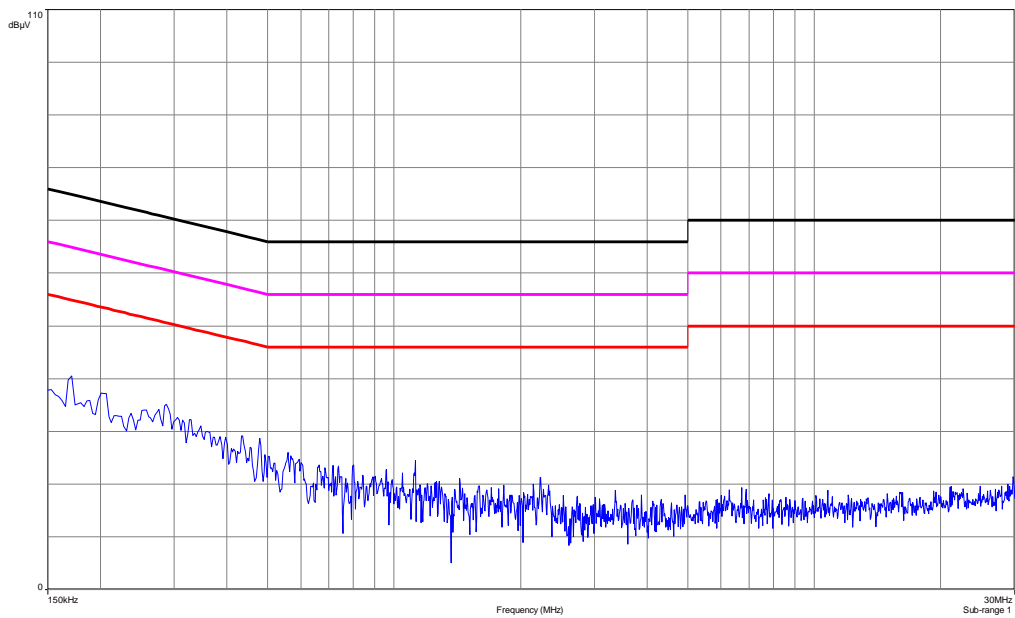

Plot 3: 150 kHz to 30 MHz, RX mode, phase line

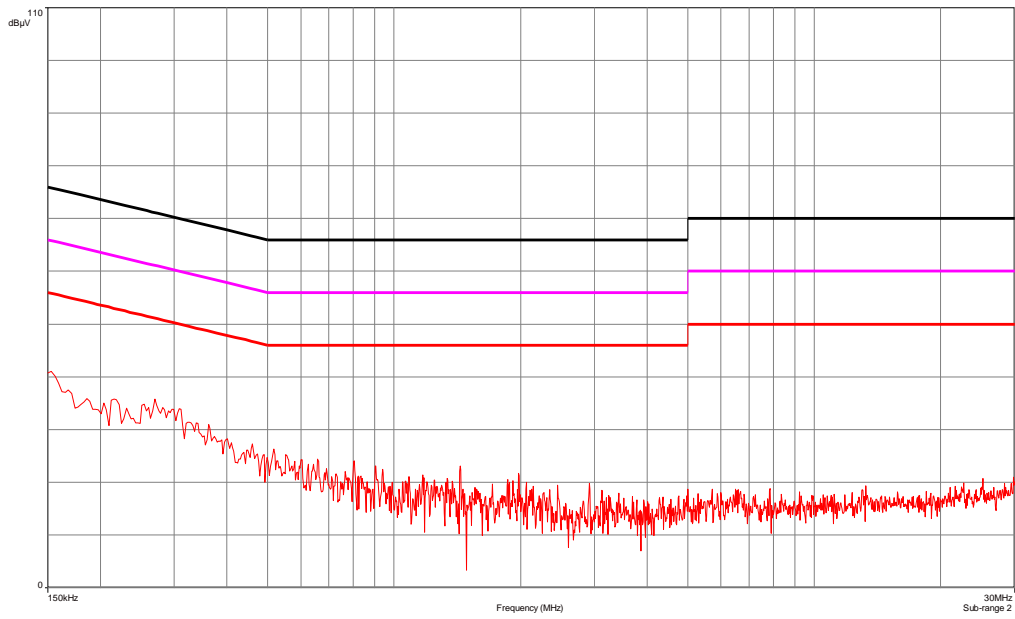

Plot 4: 150 kHz to 30 MHz, RX mode, neutral line

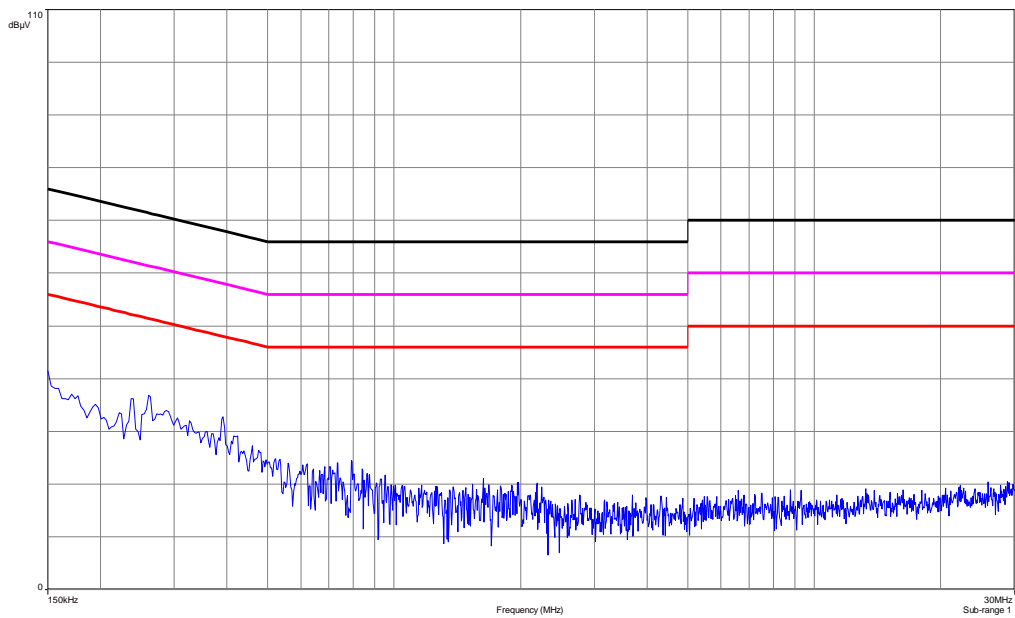

10 Test equipment and ancillaries used for tests

Typically, the calibrations of the test apparatus are commissioned to and performed by an accredited calibration laboratory. The calibration intervals are determined in accordance with the DIN EN ISO/IEC 17025. In addition to the external calibrations, the laboratory executes comparison measurements with other calibrated test systems or effective verifications. Weekly chamber inspections and range calibrations are performed. Where possible, rf-generating and signalling equipment as well as measuring receivers and analyzers are connected to an external high-precision 10 MHz reference (GPS-based or rubidium frequency standard).

In order to simplify the identification of the equipment used at some special tests, some items of test equipment and ancillaries can be provided with an identifier or number in the equipment list below (Labor/Item).

| No. | Lab / Item | Equipment | Type | Manufact. | Serial No. | INV. No Cetecom | Kind of Calibration | Last Calibration | Next Calibration |
|-----|------------|---|---|------------------------|----------------------------|--------------------|------------------------|---------------------|---------------------|
| 1 | 45 | Switch-Unit | 3488A | HP Meßtechnik | 2719A14505 | 300000368 | g | | |
| 2 | 50 | DC power supply, 60Vdc, 50A, 1200 W | 6032A | HP Meßtechnik | 2920A04466 | 300000580 | ne | | |
| 3 | n. a. | software | SPS_PHE 1.4f | Spitzberger & Spieß | B5981; 5D1081;B597 9 | 300000210 | ne | | |
| 4 | n. a. | EMI Test Receiver | ESCI 1166.5950. 03 | R&S | 100083 | 300003312 | k | 09.01.2013 | 09.01.2014 |
| 5 | n. a. | Analyzer- Reference- System (Harmonics and Flicker) | ARS 16/1 | SPS | A3509 07/0 0205 | 300003314 | k | 14.07.2011 | 14.07.2013 |
| 6 | n. a. | Amplifier | JS42- 00502650- 28-5A | MITEQ | 1084532 | 300003379 | ev | | |
| 7 | n. a. | Antenna Tower | Model 2175 | ETS- LINDGREN | 64762 | 300003745 | izw | | |
| 8 | n. a. | Positioning Controller | Model 2090 | ETS- LINDGREN | 64672 | 300003746 | izw | | |
| 9 | n. a. | Turntable Interface-Box | Model 105637 | ETS- LINDGREN | 44583 | 300003747 | izw | | |
| 10 | n. a. | TRILOG Broadband Test-Antenna 30 MHz - 3 GHz | VULB9163 | Schwarzbe ck | 295 | 300003787 | k | 12.04.2012 | 12.04.2014 |
| 11 | n. a. | Spectrum- Analyzer | FSU26 | R&S | 200809 | 300003874 | k | 16.01.2013 | 16.01.2015 |
| 12 | n. a. | DC power supply, 60Vdc, 50A, 1200 W | 6032A | HP Meßtechnik | 2818A03450 | 300001040 | Ve | 12.01.2012 | 12.01.2015 |
| 13 | n. a. | Double-Ridged Waveguide Horn Antenna 1-18.0GHz | 3115 | EMCO | 8812-3088 | 300001032 | vIKI! | 11.05.2011 | 11.05.2013 |
| 14 | n. a. | Active Loop Antenna | 6502 | EMCO | 2210 | 300001015 | ne | | |
| 15 | n. a. | Anechoic chamber | FAC 3/5m | MWB / TDK | 87400/02 | 300000996 | ev | | |
| 16 | n. a. | Switch / Control Unit | 3488A | HP Meßtechnik | * | 300000199 | ne | | |
| 17 | n. a. | Switch / Control Unit | 3488A | HP Meßtechnik | 2719A15013 | 300001156 | ne | | |
| 18 | 9 | Isolating Transformer | MPL IEC625 Bus Regeltrennt ravo | Erfi | 91350 | 300001155 | ne | | |
| 19 | n. a. | Three-Way Power Splitter, 50 Ohm | 11850C | HP Meßtechnik | | 300000997 | ne | | |
| 20 | n. a. | Amplifier | js42- 00502650- 28-5a | Parzich GMBH | 928979 | 300003143 | ne | | |
| 21 | n. a. | Band Reject filter | WRCG240 0/2483- 2375/2505- 50/10SS | Wainwright | 11 | 300003351 | ev | | |
| 22 | n. a. | TRILOG Broadband Test-Antenna 30 MHz - 3 GHz | VULB9163 | Schwarzbe ck | 371 | 300003854 | vIKI! | 14.10.2011 | 14.10.2014 |

| | | | | | | | | | |
|----|-------|--|-------------------|----------------------|------------|----------------|-------|------------|------------|
| 23 | n. a. | MXE EMI Receiver 20 Hz bis 26,5 GHz | N9038A | Agilent Technologies | MY51210197 | 300004405 | k | | |
| 24 | n. a. | Switch / Control Unit | 3488A | HP Meßtechnik | | 300001691 | ne | | |
| 25 | n. a. | Power Supply DC | NGPE 40/40 | R&S | 388 | 400000078 | vIKI! | 21.08.2012 | 21.08.2014 |
| 26 | n. a. | Switch / Control Unit | SSCU | R&S | 338864/003 | 300002681-0006 | ne | | |
| 27 | n. a. | Frequency Standard (Rubidium Frequency Standard) | MFS (Rubidium) | R&S (Datum) | 002 | 300002681-0009 | Ve | 21.08.2012 | 21.08.2014 |
| 28 | n. a. | Directional Coupler | 101020010 | Krytar | 70215 | 300002840 | ev | | |
| 29 | n. a. | DC-Blocker | 8143 | Inmet Corp. | none | 300002842 | ne | | |
| 30 | n. a. | Powersplitter | 6005-3 | Inmet Corp. | | 300002841 | ev | | |
| 31 | n. a. | CBT (Bluetooth Tester + EDR Signalling) | CBT 1153.9000 K35 | R&S | 100185 | 300003416 | vIKI! | 21.08.2012 | 21.08.2014 |
| 32 | n. a. | Spectrum Analyzer 9kHz to 30GHz - 140..+30dBm | FSP30 | R&S | 100886 | 300003575 | k | 22.08.2012 | 22.08.2014 |
| 33 | 11b | Microwave System Amplifier, 0.5-26.5 GHz | 83017A | HP Meßtechnik | 00419 | 300002268 | ev | | |
| 34 | A025 | Std. Gain Horn Antenna 12.4 to 18.0 GHz | 639 | Narda | | 300000786 | ne | | |
| 35 | A027 | Std. Gain Horn Antenna 18.0 to 26.5 GHz | 638 | Narda | | 300000486 | ne | | |
| 36 | n. a. | Signal Analyzer 40 GHz | FSV40 | R&S | 101042 | 300004xxx | k | 22.10.2012 | 22.10.2013 |

Agenda: Kind of Calibration

- | | | | |
|-------|--|-----|--|
| k | calibration / calibrated | EK | limited calibration |
| ne | not required (k, ev, izw, zw not required) | zw | cyclical maintenance (external cyclical maintenance) |
| ev | periodic self verification | izw | internal cyclical maintenance |
| Ve | long-term stability recognized | g | blocked for accredited testing |
| vIKI! | Attention: extended calibration interval | | |
| NK! | Attention: not calibrated | *) | next calibration ordered / currently in progress |

11 Observations

No observations exceeding those reported with the single test cases have been made.

Annex A Document history

| Version | Applied changes | Date of release |
|---------|-----------------|-----------------|
| 1.0 | Initial release | 2013-02-20 |

Annex B Further information**Glossary**

| | | |
|----------|---|--|
| AVG | - | Average |
| DUT | - | Device under test |
| EMC | - | Electromagnetic Compatibility |
| EN | - | European Standard |
| EUT | - | Equipment under test |
| ETSI | - | European Telecommunications Standard Institute |
| FCC | - | Federal Communication Commission |
| FCC ID | - | Company Identifier at FCC |
| HW | - | Hardware |
| IC | - | Industry Canada |
| Inv. No. | - | Inventory number |
| N/A | - | Not applicable |
| PP | - | Positive peak |
| QP | - | Quasi peak |
| S/N | - | Serial number |
| SW | - | Software |

Annex C Accreditation Certificate



Deutsche Akkreditierungsstelle GmbH

Befehlene gemäß § 8 Absatz 1 AkkStelleG i.V.m. § 1 Absatz 1 AkkStelleGBV
 Unterzeichnerin der Multilateralen Abkommen
 von EA, ILAC und IAF zur gegenseitigen Anerkennung

Akkreditierung



Die Deutsche Akkreditierungsstelle GmbH bestätigt hiermit, dass das Prüflaboratorium

CETECOM ICT Services GmbH
 Untertürkheimer Straße 6-10, 66117 Saarbrücken

die Kompetenz nach DIN EN ISO/IEC 17025:2005 besitzt, Prüfungen in folgenden Bereichen durchzuführen:

- Drahtgebundene Kommunikation einschließlich xDSL
- VoIP und DECT
- Akustik
- Funk einschließlich WLAN
- Short Range Devices (SRD)
- RFID
- WiMax und Richtfunk
- Mobilfunk (GSM / DCS, Over the Air (OTA) Performance)
- Elektromagnetische Verträglichkeit (EMV) einschließlich Automotive
- Produktsicherheit
- SAR und Hearing Aid Compatibility (HAC)
- Umweltsimulation
- Smart Card Terminals
- Bluetooth
- Wi-Fi Services

Die Akkreditierungsurkunde gilt nur in Verbindung mit dem Bescheid vom 18.01.2013 mit der Akkreditierungsnummer D-PL-12076-01 und ist gültig 17.01.2018. Sie besteht aus diesem Deckblatt, der Rückseite des Deckblatts und der folgenden Anlage mit insgesamt 80 Seiten.

Registrierungsnummer der Urkunde: D-PL-12076-01-01

Frankfurt am Main, 18.01.2013
 Bitte Hinweisen auf der Rückseite

Im Auftrag
 Dr. Ingrid (FH) Pfeiffer
 Abteilungsleiterin

Deutsche Akkreditierungsstelle GmbH

Standort Berlin
 Spittelmarkt 10
 10117 Berlin

Standort Frankfurt am Main
 Gartenstraße 6
 60594 Frankfurt am Main

Standort Braunschweig
 Rundesallee 100
 38116 Braunschweig

Die auszugsweise Veröffentlichung der Akkreditierungsurkunde bedarf der vorherigen schriftlichen Zustimmung der Deutsche Akkreditierungsstelle GmbH (DAKKS). Ausgenommen davon ist die separate Weiterverarbeitung des Deckblattes durch die umseitig genannte Konformitätsbewertungsstelle in unveränderter Form.

Es darf nicht der Anschein erweckt werden, dass sich die Akkreditierung auch auf Bereiche erstreckt, die über den durch die DAKKS bestätigten Akkreditierungsbereich hinausgehen.

Die Akkreditierung erfolgte gemäß des Gesetzes über die Akkreditierungsstelle (AkkStelleG) vom 31. Juli 2009 (BGBl. I S. 2625) sowie der Verordnung (EG) Nr. 765/2008 des Europäischen Parlaments und des Rates vom 9. Juli 2008 über die Vorschriften für die Akkreditierung und Marktüberwachung im Zusammenhang mit der Vermarktung von Produkten (Abi. L 218 vom 9. Juli 2008, S. 30). Die DAKKS ist Unterzeichnerin der Multilateralen Abkommen zur gegenseitigen Anerkennung der European co-operation for Accreditation (EA), des International Accreditation Forum (IAF) und der International Laboratory Accreditation Cooperation (ILAC). Die Unterzeichner dieser Abkommen erkennen ihre Akkreditierungen gegenseitig an.

Der aktuelle Stand der Mitgliedschaft kann folgenden Webseiten entnommen werden:
 EA: www.european-accreditation.org
 ILAC: www.ilac.org
 IAF: www.iaf.nu

Note:

The current certificate including annex is published on our website (see link below) or may be received from CETECOM ICT Services on request.

<http://www.cetecom.com/eu/de/cetecom-group/europa/deutschland-saarbruecken/akkreditierungen.html>