

TEST REPORT

Test Report No.: 1-4254/12-70-03



Testing Laboratory

CETECOM ICT Services GmbH
 Untertürkheimer Straße 6 – 10
 66117 Saarbrücken/Germany
 Phone: + 49 681 5 98 - 0
 Fax: + 49 681 5 98 - 9075
 Internet: <http://www.cetecom.com>
 e-mail: ict@cetecom.com

Accredited Test Laboratory:
 The testing laboratory (area of testing) is accredited according to DIN EN ISO/IEC 17025 (2005) by the Deutsche Akkreditierungsstelle GmbH (DAKKS)
 The accreditation is valid for the scope of testing procedures as stated in the accreditation certificate with the registration number: D-PL-12076-01-01

Applicant

Sony Mobile Communications AB
 Nya Vattentornet
 22188 Lund/SWEDEN

Phone: +46 46 19 30 00

Contact: Håkan Sjöberg
 e-mail: hakan.sjoberg@sonymobile.com
 Phone: +46 46 19 35 59
 Fax: +46 46 19 32 95

Manufacturer

Sony Mobile Communications AB
 Nya Vattentornet
 22188 Lund/SWEDEN

Test Standard/s

ANSI C63.19-2007	Methods of Measurement of Compatibility between Wireless Communications Devices and Hearing Aids
FCC 47 CFR §20.19	Hearing Aid Compatible Mobile Headsets

Test Item

Kind of test item:	Mobile Phone
Device type:	portable device
Model name:	PM-0280-BV
S/N serial number:	CB5A1MAPY5
FCC-ID:	PY7PM-0280
IC:	4170B-PM0280
IMEI-Number:	00440214-630005-2
Hardware status:	AP1.2
Software status:	10.1.A.0.287
Frequency:	see technical details
Antenna:	integrated antenna
Battery option:	Integrated battery
Accessories:	---
Test sample status:	identical prototype
HAC-Rating:	M3

Test Report authorised:



2012-12-11 Thomas Vogler
 Senior Testing Manager

Test performed:



2012-12-11 Oleksandr Hnatovskiy
 Testing Manager

1 Table of contents

1	Table of contents.....	2
2	General information	4
2.1	Notes and disclaimer	4
2.2	Application details	4
2.3	Statement of compliance.....	4
2.4	Technical details.....	5
3	Test standard/s:.....	6
3.1	Categories of hearing aid compatibility for wireless devices	6
4	Summary of Measurement Results	7
5	Test Environment.....	7
6	Test Set-up.....	8
6.1	Measurement system.....	8
6.1.1	System Description.....	8
6.1.2	Test environment.....	9
6.1.3	Probe description.....	9
6.1.4	HAC test arch description.....	10
6.1.5	Device holder description	10
6.1.6	Scanning procedure	11
6.1.7	Data Storage and Evaluation.....	12
6.1.8	Measurement uncertainty evaluation for HAC measurements.....	14
6.1.9	Measurement uncertainty evaluation for system validation	15
6.1.10	System check	16
6.1.11	System check procedure.....	16
6.1.12	Determination of probe modulation factor	18
6.2	Conducted power measurements.....	20
6.2.1	Conducted power measurements GSM 850 MHz.....	20
6.2.2	Conducted power measurements GSM 1900 MHz.....	20
6.2.3	Conducted power measurements WCDMA FDD V (850 MHz).....	20
6.2.4	Conducted power measurements WCDMA FDD IV (1700 MHz).....	20
6.2.5	Conducted power measurements WCDMA FDD II (1900 MHz).....	20
6.3	Test results	21
6.3.1	Test Results at speaker position	21
6.3.2	General description of test procedures	22
7	Test equipment and ancillaries used for tests.....	23
8	Observations	23
Annex A:	System performance check.....	24
Annex B:	DASY4 measurement results.....	30
Annex B.1:	GSM 835MHz	30
Annex B.2:	GSM 1880MHz.....	42
Annex B.3:	WCDMA FDD V 835MHz	54
Annex B.4:	WCDMA FDD IV 1730MHz	66
Annex B.5:	WCDMA FDD II 1880MHz	78
Annex C:	Photo documentation.....	90

Annex D: Calibration parameters.....91

Annex E: Document History.....91

Annex F: Further Information91

2 General information

2.1 Notes and disclaimer

The test results of this test report relate exclusively to the test item specified in this test report. CETECOM ICT Services GmbH does not assume responsibility for any conclusions and generalisations drawn from the test results with regard to other specimens or samples of the type of the equipment represented by the test item. The test report may only be reproduced or published in full. Reproduction or publication of extracts from the report requires the prior written approval of CETECOM ICT Services GmbH.

This test report is electronically signed and valid without handwriting signature. For verification of the electronic signatures, the public keys can be requested at the testing laboratory.

The testing service provided by CETECOM ICT Services GmbH has been rendered under the current "General Terms and Conditions for CETECOM ICT Services GmbH".

CETECOM ICT Services GmbH will not be liable for any loss or damage resulting from false, inaccurate, inappropriate or incomplete product information provided by the customer.

Under no circumstances does the CETECOM ICT Services GmbH test report include any endorsement or warranty regarding the functionality, quality or performance of any other product or service provided.

Under no circumstances does the CETECOM ICT Services GmbH test report include or imply any product or service warranties from CETECOM ICT Services GmbH, including, without limitation, any implied warranties of merchantability, fitness for purpose, or non-infringement, all of which are expressly disclaimed by CETECOM ICT Services GmbH.

All rights and remedies regarding vendor's products and services for which CETECOM ICT Services GmbH has prepared this test report shall be provided by the party offering such products or services and not by CETECOM ICT Services GmbH.

In no case this test report can be considered as a Letter of Approval.

2.2 Application details

Date of receipt of order:	2012-11-28
Date of receipt of test item:	2012-11-28
Start of test:	2012-12-08
End of test:	2012-12-10
Person(s) present during the test:	

2.3 Statement of compliance

ThePM-0280-BV Mobile Phone has been tested in accordance with ANSI C63.19-2007: American National Standard for Methods of Measurement of Compatibility between Wireless Communication Devices and Hearing Aids.

C63.19 HAC Rated Category: M3

2.4 Technical details

Band tested for this test report	Technology	Frequency band	Lowest transmit frequency/MHz	Highest transmit frequency/MHz	Lowest receive Frequency/MHz	Highest receive Frequency/MHz	Kind of modulation	Power Class	Tested power control level	GPRS/EGPRS mobile station class	GPRS/EGPRS multislots class	(E)GPRS voice mode or DTM	Test channel low	Test channel middle	Test channel high	Maximum output power/dBm)*
<input type="checkbox"/>	GSM	GSM	880.2	914.8	925.2	959.8	GMSK 8-PSK	4 E2	5	B	12	no	975	37	124	33.4
<input type="checkbox"/>	GSM	DCS	1710.2	1784.8	1805.2	1879.8	GMSK 8-PSK	1 E2	0	B	12	no	512	698	885	30.3
<input checked="" type="checkbox"/>	GSM	cellular	824.2	848.8	869.2	893.8	GMSK 8-PSK	4 E2	5	B	12	no	128	190	251	33.2
<input checked="" type="checkbox"/>	GSM	PCS	1850.2	1909.8	1930.2	1989.8	GMSK 8-PSK	1 E2	0	B	12	no	512	661	810	30.1
<input type="checkbox"/>	UMTS	FDD I	1922.4	1977.6	2112.4	2167.6	QPSK	3	max	--	--	--	9612	9750	9888	24.0
<input checked="" type="checkbox"/>	UMTS	FDD II	1852.4	1907.6	1982.4	1987.6	QPSK	3	max	--	--	--	9262	9400	9538	22.6
<input checked="" type="checkbox"/>	UMTS	FDD IV	1712.4	1752.6	1807.4	1877.6	QPSK	3	max	--	--	--	1312	1412	1513	23.1
<input checked="" type="checkbox"/>	UMTS	FDD V	826.4	846.6	871.4	891.6	QPSK	3	max	--	--	--	4132	4182	4233	24.2
<input type="checkbox"/>	UMTS	FDD VIII	882.4	912.6	927.4	957.6	QPSK	3	max	--	--	--	2712	2787	2863	23.9
<input type="checkbox"/>	WLAN	ISM	2412	2472	2412	2472	CCK OFDM	--	max	--	--	--	1	7	13	--
<input type="checkbox"/>	WLAN US	ISM	2412	2462	2412	2462	CCK OFDM	--	max	--	--	--	1	6	11	--
<input type="checkbox"/>	WLAN	ISM	5180	5240	5180	5240	OFDM	--	max	--	--	--	--	--	--	--
<input type="checkbox"/>	WLAN	ISM	5260	5320	5260	5320	OFDM	--	max	--	--	--	--	--	--	--
<input type="checkbox"/>	WLAN	ISM	5500	5700	5500	5700	OFDM	--	max	--	--	--	--	--	--	--
<input type="checkbox"/>	WLAN	ISM	5745	5825	5745	5825	OFDM	--	max	--	--	--	--	--	--	--
<input type="checkbox"/>	BT	ISM	2402	2480	2402	2480	GFSK	3	max	--	--	--	0	39	78	<10

)*: slotted peak power for GSM, averaged max. RMS power for UMTS, LTE, WLAN and BT.

3 Test standard/s:

Test Standard	Version	Test Standard Description
ANSI C63.19	2007	Methods of Measurement of Compatibility between Wireless Communications Devices and Hearing Aids
FCC 47 CFR §20.19		Hearing Aid Compatible Mobile Headsets

3.1 Categories of hearing aid compatibility for wireless devices

Telephone RF Parameters					
Category	AWF (dB)	Limits for E-Field Emissions		Limits for H-Field Emissions	
		V/m	dBV/m	A/m	dB A/m
< 960 MHz					
M1	0	631 - 1122	56 – 61	1.91 - 3.39	5.6 – 10.6
	-5	473.2 - 841.4	53.5 – 58.5	1.43 - 2.54	3.1 – 8.1
M2	0	354.8 - 631	51 – 56	1.07 - 1.91	0.6 – 5.6
	-5	266.1 - 473.2	48.5 – 53.5	0.8 - 1.43	-1.9 – 3.1
M3	0	199.5 - 354.8	46 – 51	0.6 - 1.07	-4.4 – 0.6
	-5	149.6 - 266.1	43.5 – 48.5	0.45 - 0.8	-6.9 – -1.9
M4	0	<199.5	<46	<0.6	< -4.4
	-5	<149.6	<43.5	<0.45	< -6.9
> 960 MHz					
M1	0	199.5 – 354.8	46 – 51	0.6 – 1.07	-4.4 – 0.6
	-5	149.6 – 266.1	43.5 – 48.5	0.45 – 0.8	-6.9 – -1.9
M2	0	112.2 – 199.5	41 – 46	0.34 – 0.6	-9.4 – -4.4
	-5	84.1 – 149.6	38.5 – 43.5	0.25 – 0.45	-11.9 – -6.9
M3	0	63.1 – 112.2	36 – 41	0.19 – 0.34	-14.4 – -9.4
	-5	47.3 – 84.1	33.5 – 38.5	0.15 – 0.25	-16.9 – -11.9
M4	0	<63.1	<36	<0.19	< -14.4
	-5	<47.3	<33.5	<0.14	< -16.9

AWF : Articulation Weighting Factor

Standard	Technology	AWF
TIA/EIA/IS-2000	CDMA	0
TIA/EIA-136	TDMA (50 Hz)	0
J-STD-007	GSM (217 Hz)	-5
T1/T1P1/3GPP	UMTS (WCDMA)	0
iDEN	TDMA (22 Hz and 11 Hz)	0

4 Summary of Measurement Results

<input checked="" type="checkbox"/>	No deviations from the technical specifications ascertained
	HAC-Category : M3
<input type="checkbox"/>	Deviations from the technical specifications ascertained

5 Test Environment

Ambient temperature: 20 – 24 °C

Relative humidity content: 40 – 50 %

Air pressure: not relevant for this kind of testing

Power supply: 230 V / 50 Hz

6 Test Set-up

6.1 Measurement system

6.1.1 System Description

For performing HAC measurements the Schmid & Partner DASY5 dosimetric assessment system is used which is described below. Instead of dosimetric probes E-field and H-field probes for measurement in air are in use together with a HAC test arch:

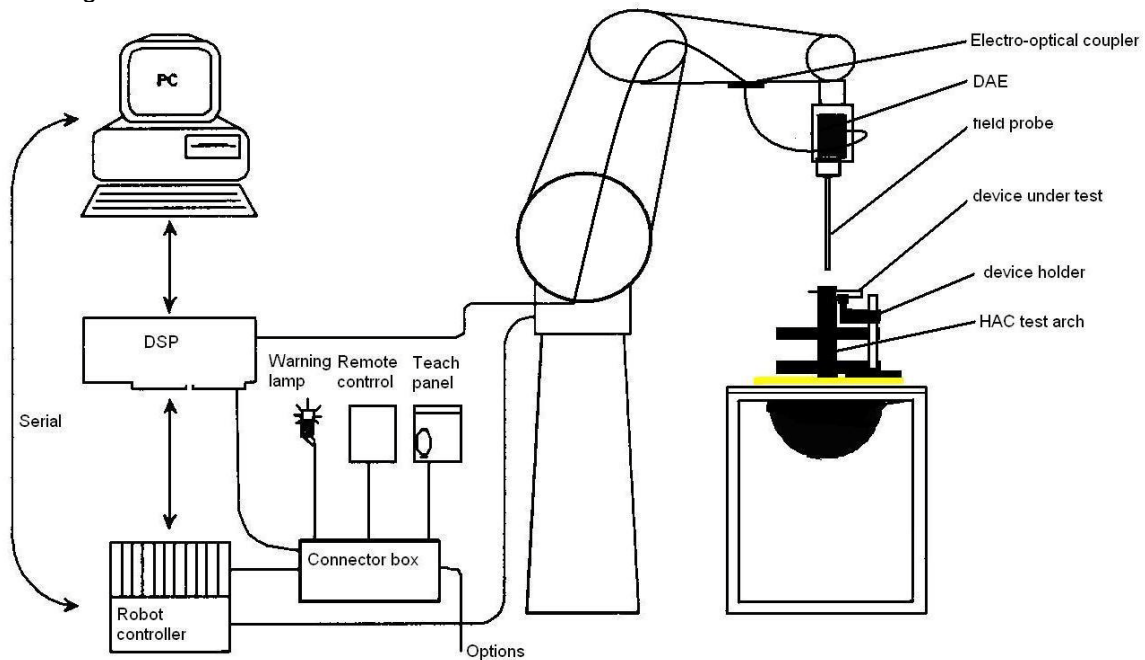

The DASY5 system for performing compliance tests consists of the following items:

- A standard high precision 6-axis robot (Stäubli RX family) with controller and software. An arm extension for accommodating the data acquisition electronics (DAE).
- A dosimetric probe, i.e. an isotropic E-field probe optimized and calibrated for usage in tissue simulating liquid. The probe is equipped with an optical surface detector system.
- A data acquisition electronic (DAE) which performs the signal amplification, signal multiplexing, AD-conversion, offset measurements, mechanical surface detection, collision detection, etc. The unit is battery powered with standard or rechargeable batteries. The signal is optically transmitted to the EOC.
- A unit to operate the optical surface detector which is connected to the EOC.
- The Electro-Optical Coupler (EOC) performs the conversion from the optical into a digital electric signal of the DAE. The EOC is connected to the DASY5 measurement server.
- The DASY5 measurement server, which performs all real-time data evaluation for field measurements and surface detection, controls robot movements and handles safety operation. A computer operating Windows 7
- DASY5 software and SEMCAD data evaluation software.
- Remote control with teach panel and additional circuitry for robot safety such as warning lamps, etc.
- The generic twin phantom enabling the testing of left-hand and right-hand usage.
- The device holder for handheld mobile phones.
- Tissue simulating liquid mixed according to the given recipes.
- System validation dipoles allowing to validate the proper functioning of the system.

6.1.2 Test environment

The DASY5 measurement system is placed at the head end of a room with dimensions: 5 x 2.5 x 3 m³, the SAM phantom is placed in a distance of 75 cm from the side walls and 1.1m from the rear wall. Above the test system a 1.5 x 1.5 m² array of pyramid absorbers is installed to reduce reflections from the ceiling.

Additional absorbers are placed around the HAC test set-up to prevent reflections from the robot arm.

Picture 1 of the photo documentation shows a complete view of the the test environment.

The system allows the measurement of E-field values larger than 2 V/m and H-field values larger than 10mA/m.

6.1.3 Probe description

Isotropic E-Field Probe ET3DV6 for Dosimetric Measurements

E-Field Probe ER3DV6 (Technical data according to manufacturer information)	
Construction	One dipole parallel and two dipoles normal to probe axis Built-in shielding against static charges
Calibration	In air from 100 MHz to 3 GHz (absolute accuracy $\pm 6.0\%$; k=2)
Frequency	100 MHz to >6 GHz; Linearity: ± 0.2 dB (100MHz to 3 GHz)
Directivity	± 0.2 dB in air (rotation around probe axis) ± 0.4 dB in air (rotation normal to probe axis)
Dynamic range	2 V/m to > 1000 V/m (M3/M4 device readings fall well below diode compression point)
Dimensions	Overall length: 330 mm; Tip length: 16 mm Body diameter: 12 mm; Tip diameter: 8 mm Distance from probe tip to dipole centers: 2.5mm

H-Field Probe H3DV6 (Technical data according to manufacturer information)	
Construction	Three concentric loop sensors with 3.8 mm loop diameters. Resistively loaded detector diodes for linear response Built-in shielding against static charges
Calibration	In air from 100 MHz to 3 GHz (absolute accuracy $\pm 6.0\%$; k=2)
Frequency	200 MHz to 3 GHz; Linearity: ± 0.2 dB (100MHz to 3 GHz)
Directivity	± 0.25 dB (spherical isotropy error)
Dynamic range	10 mA/m to 2 A/m at 1 GHz (M3/M4 device readings fall well below diode compression point)
Dimensions	Overall length: 330 mm; Tip length: 40 mm Body diameter: 12 mm; Tip diameter: 6 mm Distance from probe tip to loop centers: 3 mm
E-Field Interference	< 10% at 3 GHz (for plane wave)

6.1.4 HAC test arch description

The HAC test arch is especially designed for performing measurements according to the requirements of ANSI C63.19. It allows centering the wireless device inside a 5 x 5 cm control area marked with 4 points for position adjustment. Plastic bridges allow an exact adjustment of the measurement distance to 1 cm from the DUT, which also includes the distance of the dipole center to the probe tip.

For centering the mobile phone speaker inside the control area and for adjusting the validation dipole position the test arch contains a nylon thread for alignment (see picture).

The HAC test arch is placed on the cover of the DASY5 SAM phantom.

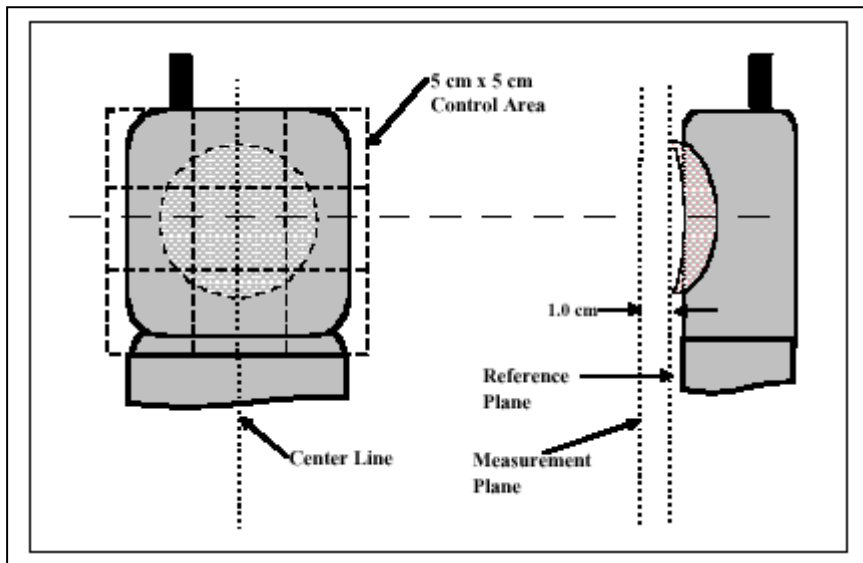

6.1.5 Device holder description

The DASY5 device holder (see picture above) has three scales for device inclination, height and side adjustment. The device holder position is adjusted to the standard measurement position e.g. center of the DUT speaker to the center of the 5 x 5 cm² control area with the device touching the plastic bridge of the HAC test arch. This device holder is used for standard mobile phones or PDA's only. If necessary an additional support of polystyrene material is used.

6.1.6 Scanning procedure

The DASY5 installation includes predefined files with recommended procedures for measurements and validation. They are read-only document files and destined as fully defined but unmeasured masks. All tests are performed with the same configuration of test steps in accordance with the requirements described in C63.19-2007 Chapter 4.4.1.2.2.

1. The HAC test setup is placed at the pre-defined position on top of the SAR phantom cover.
2. A phantom adjustment and verification is performed, which allows checking the borders and center position of the 5 x 5 cm² control area. The probe tip touches down on the 4 points at the corners of the control area
3. The wireless device (WD) is oriented in its intended test position (see photo documentation) with the reference plane in the horizontal plane and secured by the device holder. The acoustical output is placed in the center of the control area (predefined by the HAC test arch)
4. The DUT is set to transmit at maximum output power at the desired test channel(s).
5. „Reference“ and „drift“ measurements are located at the beginning and the end of the test batch process. They measure the field drift at one single point above the DUT over the complete procedure. The indicated drift is mainly the variation of the DUT's output power and should vary max. +/- 5 % (+/- 0.2 dB).
6. The „area scan“ measures the electrical or magnetic field strength above the WD on a parallel plane to the surroundings of the control area at the upper end of the HAC test arch. It is used to locate the approximate location of the peak field strength with 2D spline interpolation. The robot performs a stepped movement along one grid axis while the local electrical or magnetic field strength is measured by the probe. The probe is moving at a distance of 1 cm to a defined plane above the WD during acquisition of measurement values. Standard grid spacing is 5 mm in x- and y- dimension. If a finer resolution is needed, the grid spacing can be reduced. Results of this scan are shown in annex 2.
7. At the maximum interpolated position a 360° rotation of the probe around the azimuth is performed. The maximum and delta reading from this rotation is used in re-evaluating the HAC category.
8. The automatic data evaluation performed by the software in respect of the requirements of the test standard subdivides the tested area of 5 x 5 cm into 9 squares. Within each square the maximum electrical or magnetic field strength is detected. For classification of M categories the 3 squares with highest field values are excluded. Among the remaining 6, one of which is the center square, 4 squares with highest values both in E-field and in H-field scan are evaluated. The results are automatically exported by the SEMCAD evaluation software together with the measurement plots.

The SEMCAD software also respects the articulation weighing factor (AWF), and converts the measured values to peak V/m or peak A/m using appropriate factors derived from the probe modulation factor, which is determined by system validation measurements.

6.1.7 Data Storage and Evaluation

Data Storage

The DASY5 software stores the acquired data from the data acquisition electronics as raw data (in microvolt readings from the probe sensors), together with all necessary software parameters for the data evaluation (probe calibration data, liquid parameters and device frequency and modulation data) in measurement files with the extension ".DA52". The software evaluates the desired unit and format for output each time the data is visualized or exported. This allows verification of the complete software setup even after the measurement and allows correction of incorrect parameter settings. For example, if a measurement has been performed with a wrong crest factor parameter in the device setup, the parameter can be corrected afterwards and the data can be re-evaluated.

The measured data can be visualized or exported in different units or formats, depending on the selected probe type ([V/m], [A/m], [°C], [mW/g], [mW/cm²], [dBrel], etc.). Some of these units are not available in certain situations or show meaningless results, e.g., a SAR output in a lossless media will always be zero. Raw data can also be exported to perform the evaluation with other software packages.

Data Evaluation by SEMCAD

The SEMCAD software automatically executes the following procedures to calculate the field units from the microvolt readings at the probe connector. The parameters used in the evaluation are stored in the configuration modules of the software:

Probe parameters:	- Sensitivity	Norm _i , a _{i0} , a _{i1} , a _{i2}
	- Conversion factor	ConvF _i
	- Diode compression point	Dcpi
Device parameters:	- Frequency	f
	- Crest factor	cf
Media parameters:	- Conductivity	σ
	- Density	ρ

These parameters must be set correctly in the software. They can be found in the component documents or they can be imported into the software from the configuration files issued for the DASY5 components. In the direct measuring mode of the multimeter option, the parameters of the actual system setup are used. In the scan visualization and export modes, the parameters stored in the corresponding document files are used.

The first step of the evaluation is a linearization of the filtered input signal to account for the compression characteristics of the detector diode. The compensation depends on the input signal, the diode type and the DC-transmission factor from the diode to the evaluation electronics.

If the exciting field is pulsed, the crest factor of the signal must be known to correctly compensate for peak power. The formula for each channel can be given as:

$$V_i = U_i + U_i^2 \cdot cf/dcp_i$$

with V_i = compensated signal of channel i (i = x, y, z)
 U_i = input signal of channel i (i = x, y, z)
 cf = crest factor of exciting field (DASY parameter)
 dcp_i = diode compression point (DASY parameter)

From the compensated input signals the primary field data for each channel can be evaluated:

E-field probes:
$$E_i = (V_i / Norm_i \cdot ConvF)^{1/2}$$

H-field probes:
$$H_i = (V_i)^{1/2} \cdot (a_{i0} + a_{i1}f + a_{i2}f^2)/f$$

with V_i = compensated signal of channel i (i = x, y, z)
 $Norm_i$ = sensor sensitivity of channel i (i = x, y, z)
 [mV/(V/m)²] for E-field Probes
 $ConvF$ = sensitivity enhancement in solution
 a_{ij} = sensor sensitivity factors for H-field probes
 f = carrier frequency [GHz]
 E_i = electric field strength of channel i in V/m
 H_i = magnetic field strength of channel i in A/m

The RSS value of the field components gives the total field strength (Hermitian magnitude):

$$E_{tot} = (E_x^2 + E_y^2 + E_z^2)^{1/2}$$

with P_{pwe} = equivalent power density of a plane wave in mW/cm²
 E_{tot} = total electric field strength in V/m
 H_{tot} = total magnetic field strength in A/m

6.1.8 Measurement uncertainty evaluation for HAC measurements

This measurement uncertainty budget is suggested by ANSI-C63.19 and determined by Schmid & Partner Engineering AG. It is valid for the frequency range 800 MHz – 3 GHz and represents a worst case analysis. The breakdown of the individual uncertainties is as follows:

Error Sources	Uncertainty Value	Probability Distribution	Divisor	c _i E	c _i H	Standard Uncertainty E	Standard Uncertainty H
Measurement System							
Probe calibration	± 5.1%	Normal	1	1	1	± 5.1%	± 5.1%
Axial isotropy)*	± 4.7%	Rectangular	√3	1	1	± 2.7%	± 2.7%
Sensor displacement	±16.5%	Rectangular	√3	1	0.145	± 9.5%	± 1.4%
Boundary effects	± 2.4%	Rectangular	√3	1	1	± 1.4%	± 1.4%
Probe linearity	± 4.7%	Rectangular	√3	1	1	± 2.7%	± 2.7%
Scaling to peak envelope power	± 2.0%	Rectangular	√3	1	1	± 1.2%	± 1.2%
System detection limits	± 1.0%	Rectangular	√3	1	1	± 0.6%	± 0.6%
Readout electronics	± 0.3%	Normal	1	1	1	± 0.3%	± 0.3%
Response time	± 0.8%	Rectangular	√3	1	1	± 0.5%	± 0.5%
Integration time	± 2.6%	Rectangular	√3	1	1	± 1.5%	± 1.5%
RF ambient conditions)*	± 3.0%	Rectangular	√3	1	1	± 1.7%	± 1.7%
RF reflections)*	± 7.5%	Rectangular	√3	1	1	± 4.3%	± 4.3%
Probe positioner	± 1.2%	Rectangular	√3	1	0.67	± 0.7%	± 0.5%
Probe positioning	± 4.7%	Rectangular	√3	1	0.67	± 2.7%	± 1.8%
Extrapolation and Interpolation	± 1.0%	Rectangular	√3	1	1	± 0.6%	± 0.6%
Test sample related							
Device positioning vertical	± 4.7%	Rectangular	√3	1	0.67	± 2.7%	± 1.8%
Device positioning lateral	± 1.0%	Rectangular	√3	1	1	± 0.6%	± 0.6%
Device holder and Phantom	± 2.4%	Rectangular	√3	1	1	± 1.4%	± 1.4%
Power drift	± 5.0%	Rectangular	√3	1	1	± 2.9%	± 2.9%
Combined Uncertainty						± 13.6%	± 9.4%
Expanded Std. Uncertainty on Power						± 27.2%	± 18.8%
Expanded Std. Uncertainty on Field						± 13.6%	± 9.4%

)* : site specific

Table 1: Measurement uncertainties

6.1.9 Measurement uncertainty evaluation for system validation

This measurement uncertainty budget is suggested by ANSI-C63.19 and determined by Schmid & Partner Engineering AG. It is valid for the frequency range 800 MHz – 3 GHz and represents a worst case analysis. The breakdown of the individual uncertainties is as follows:

Error Sources	Uncertainty Value	Probability Distribution	Divisor	c _i E	c _i H	Standard Uncertainty E	Standard Uncertainty H
Measurement System							
Probe calibration	± 5.1%	Normal	1	1	1	± 5.1%	± 5.1%
Axial isotropy)*	± 4.7%	Rectangular	√3	1	1	± 2.7%	± 2.7%
Sensor displacement	±16.5%	Rectangular	√3	1	0.145	± 9.5%	± 1.4%
Boundary effects	± 2.4%	Rectangular	√3	1	1	± 1.4%	± 1.4%
Probe linearity	± 4.7%	Rectangular	√3	1	1	± 2.7%	± 2.7%
Scaling to peak envelope power	± 0.0%	Rectangular	√3	1	1	± 0.0%	± 0.0%
System detection limits	± 1.0%	Rectangular	√3	1	1	± 0.6%	± 0.6%
Readout electronics	± 0.3%	Normal	1	1	1	± 0.3%	± 0.3%
Response time	± 0.0%	Rectangular	√3	1	1	± 0.0%	± 0.0%
Integration time	± 0.0%	Rectangular	√3	1	1	± 0.0%	± 0.0%
RF ambient conditions)*	± 3.0%	Rectangular	√3	1	1	± 1.7%	± 1.7%
RF reflections)*	± 3.8%	Rectangular	√3	1	1	± 2.2%	± 2.2%
Probe positioner	± 1.2%	Rectangular	√3	1	0.67	± 0.7%	± 0.5%
Probe positioning	± 4.7%	Rectangular	√3	1	0.67	± 2.7%	± 1.8%
Extrapolation and Interpolation	± 1.0%	Rectangular	√3	1	1	± 0.6%	± 0.6%
Probe calibration	± 5.1%	Normal	1	1	1	± 5.1%	± 5.1%
Dipole related							
Distance dipole – scanning plane	± 5.2%	Rectangular	√3	1	0.3	± 3.0%	± 0.9%
Input power	± 4.7%	Normal	1	1	1	± 4.7%	± 4.7%
Combined Uncertainty						± 13.4%	± 8.9%
Expanded Std. Uncertainty on Power						± 26.9%	± 17.8%
Expanded Std. Uncertainty on Field						± 13.4%	± 8.9%

)* : site specific

Table 2: Measurement uncertainties

6.1.10 System check

The system check is performed for verifying the accuracy of the complete measurement system and performance of the software. The following table shows system check results for all frequency bands and both for E- and H-fields. (graphic plot(s) see annex A).

6.1.11 System check procedure

According to the requirements of ANSI C63.19 chapter 4.3.2.1.1 the system check is performed by using a validation dipole which is positioned parallel to the nylon fibre of the HAC test arch. The dipole is connected to the signal source consisting of signal generator and amplifier via a directional coupler, N-connector cable and adaption to SMA. It is fed with a power of 100 mW (20 dBm). To adjust this power a power meter is used. The power sensor is connected to the cable before the system check to measure the power at this point and do adjustments at the signal generator. At the outputs of the directional coupler both return loss as well as forward power are controlled during the system check to make sure that emitted power at the dipole is kept constant. This can also be checked by the power drift measurement after the test (result on plot). During the system check the measurement system scans a grid along the length of the dipole and the maximum value is recorded.

This system check is performed periodically both with E and H field probes on the center frequencies of the frequency bands used by the wireless device.

System check results have to be equal or near the values determined during dipole calibration (target HAC in table below) with the same test system set-up.

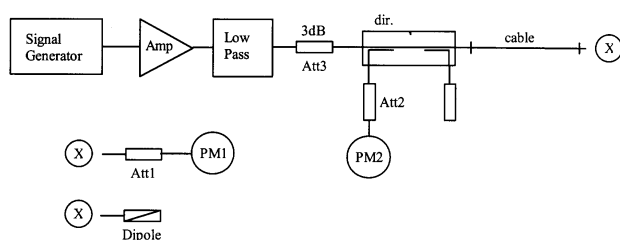

Freq.(MHz)	Signal type	Peak output power (dBm)	Target field strength (+/- 10%)	Measured field strength
835	CW	20	165.8 V/m	166.0 V/m
1730	CW	20	152.6 V/m	151.5 V/m
1880	CW	20	139.8 V/m	137.2 V/m
835	CW	20	0.458 A/m	0.448 A/m
1730	CW	20	0.487 A/m	0.513 A/m
1880	CW	20	0.459 A/m	0.475 A/m

Table 3: Results system check

According to ANSI C63.19 Chapter 4.3.2.1.2 it is recommended to compare measurement results of 3 different test cases: CW, 80% AM and signal of the wireless device.

The probe is moved to the position with the highest field strength found during system check with CW. The wireless device (WD) or an emulated signal source (e.g. CMU 200) is set to apply full rated power into the reference dipole.

Average and peak output power of the WD or emulated signal source are measured using a peak power meter.

Average power emitted by the dipole is measured with the DASY5 system.

The same procedure is repeated with a CW and an AM signal with 80% modulation index which have the same peak power as determined with the signal modulation format of the wireless device.

From the measured results the peak-to-average-ratio (PAR) is determined.

Estimation of expected values:

CW

Peak-to-Average-Ratio: 0.0 dB

80% AM

Peak-to-Average Ratio (dB) = $10 \cdot \log(m+1)^2$ with modulation index $m = 0.8$

$PAR_{\log} = 5.1$ dB

$PAR_{\text{lin}} = 1.8$

c) GSM

$PAR_{\log} = 9$ dB

$PAR_{\text{lin}} = 8$ (for one of eight timeslots in use)

The linear PAR corresponds to the crest factor of the corresponding signal type.

6.1.12 Determination of probe modulation factor

The probe modulation factor indicates the relation between the measured RMS (average) field strength values and the peak field strength of a modulated signal, which will be used by the data evaluation software to calculate from measured RMS values to peak field values for HAC evaluation. It can be determined by comparing a CW signal with a modulated signal having the same peak envelope power as defined in ANSI C63.19 Annex C.3.1.

The following procedure according to the recommendations of DASY5 HAC application note chapter 28.6 has been used:

The probe remains in the position with the highest field strength found during system check. The probe is illuminated with a signal using the same modulation as the DUT (The WD itself or an emulated signal generated by the CMU 200) on the center of the WD's frequency band. The output power is adjusted to the standard peak envelope power of the WD's modulation system and measured with a spectrum analyzer in linear mode with 0 Hz span (ANSI recommendation) and/or a power meter being able to measure Peak envelope power (FCC recommendation). The field strength at this position is recorded using the multi meter function of DASY5 software. Then a CW signal is adjusted to the same frequency and peak reading as the modulated signal measured with spectrum analyzer or power meter. This signal is fed to the validation dipole and the measured field strength is recorded. The ratio of the CW to the modulated signal reading is the modulation factor.

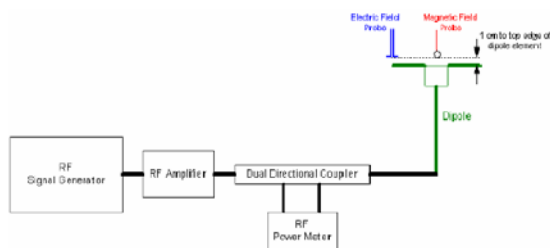

Modulation Factor = Measured E/H-Field (CW signal) / Measured E/H-Field (modulated signal)

For E-field probes the following formula is generally valid:

$$(\text{Probe Modulation Factor})^2 = \text{Crest Factor}$$

For GSM with 1 of 8 timeslots in use the PMF should be ≈ 2.82

For H-field probes the modulation factor differs with amplitude, frequency, modulation and probe.

Specific information about the determination of the probe modulation factor (manufacturer application note) is attached to the calibration document delivered together with this test report.

Measured PAR and PMF

frequency (MHz)	probe type	signal type	peak-to average ratio (dB)	measured field strength with DASY4 System	probe modulation factor
835	ER3DV6	CW	0.0	166.0 V/m	---
835	ER3DV6	80% AM	5.1	113.7 V/m	1.46
835	ER3DV6	GSM	9.1	55.9 V/m	2.97
1730	ER3DV6	CW	0.0	151.5 V/m	---
1730	ER3DV6	80% AM	5.1	94.6 V/m	1.60
1880	ER3DV6	CW	0.0	137.2 V/m	---
1880	ER3DV6	80% AM	5.1	86.0 V/m	1.60
1880	ER3DV6	GSM	9.1	46.2 V/m	2.97
835	H3DV6	CW	0.0	0.448 A/m	---
835	H3DV6	80% AM	5.1	0.308 A/m	1.45
835	H3DV6	GSM	9.1	0.157 A/m	2.86
1730	H3DV6	CW	0.0	0.513 A/m	---
1730	H3DV6	80% AM	5.1	0.350 A/m	1.46
1880	H3DV6	CW	0.0	0.475 A/m	---
1880	H3DV6	80% AM	5.1	0.324 A/m	1.47
1880	H3DV6	GSM	9.1	0.202 A/m	2.36

Table 4: Results system check

) * Peak and average output power levels were measured using the Rhode & Schwarz NRP Power Meter.

Important note:

According to manufacturer information diode based probes are inherently non-symmetric and tend to peak detection for modulated signals. SPEAG's E-field probes are designed such they are largely symmetric and accurate RMS can be obtained from pulsed signals applying the correct crest factor. The same feature could not be applied for the H-field probes such that the RMS value cannot be detected for signals other than CW without additional calibration.

So probe modulation factors of H-field probes differ more or less from those determined for E-field probes or expected target values.

In DASY52 52.8.1(838) the crest factor and probe modulation factor handling has been separated.

For HAC evaluation with SPEAG's SEMCAD software the above listed probe modulation factors need to be entered additionally, so that time averaged values are automatically calculated to slotted peak field strength values.

The crest factor setting is still necessary as it is used to perform the compensation of the diode compression on the peak power (DASY5 user manual chapter 4.4.2).

6.2 Conducted power measurements

For the measurements a Rohde & Schwarz Radio Communication Tester CMU 200 was used. The output power was measured using an integrated RF connector and attached RF cable.

6.2.1 Conducted power measurements GSM 850 MHz

Channel / frequency	modulation	timeslots	slotted avg. power
128 / 824.2 MHz	GMSK	1	33.2dBm
190 / 836.6 MHz	GMSK	1	33.2dBm
251 / 848.0 MHz	GMSK	1	33.2dBm

Table 5: Test results conducted power measurement GSM 850 MHz

6.2.2 Conducted power measurements GSM 1900 MHz

Channel / frequency	modulation	timeslots	slotted avg. power
512 / 1850.2 MHz	GMSK	1	30.1dBm
661 / 1880.0 MHz	GMSK	1	30.1dBm
810 / 1909.8 MHz	GMSK	1	30.1dBm

Table 6: Test results conducted power measurement GSM 1900 MHz

6.2.3 Conducted power measurements WCDMA FDD V (850 MHz)

Max. RMS output power 850 MHz (FDD V) / dBm			
mode	Channel / frequency		
	4132 / 826.4 MHz	4182 / 836.6 MHz	4233 / 846.6 MHz
AMR 12,2 kbit/s	24.2	24.1	24.0

Table 7: Test results conducted power measurement WCDMA 850

6.2.4 Conducted power measurements WCDMA FDD IV (1700 MHz)

Max. RMS output power FDD IV (1700MHz) / dBm			
mode	Channel / frequency		
	1312 / 1712.4 MHz	1412 / 1732.4 MHz	1513 / 1752.6 MHz
AMR 12,2 kbit/s	23.1	22.9	23.0

Table 8: Test results conducted power measurement WCDMA 1700

6.2.5 Conducted power measurements WCDMA FDD II (1900 MHz)

Max. RMS output power 1900 MHz (FDD II) / dBm			
mode	Channel / frequency		
	9262 / 1852.4 MHz	9400 / 1880.0 MHz	9538 / 1907.6 MHz
AMR 12,2 kbit/s	22.5	22.5	22.5

Table 9: Test results conducted power measurement WCDMA 1900

6.3 Test results

The following tables summarize the worst case E- and H-field results of the measured field distributions shown in Annex B. In GSM band exclusion blocks have been applied in the area of highest E-field. In WCDMA bands no exclusion blocks were applied.

6.3.1 Test Results at speaker position

Hearing Aid Compatibility results for E-Field					
Channel / frequency	Location (x, y)	Max E-Field (peak)	M3 limit	category	air temperature
128 / 824.2 MHz	(1.5, 25)	167.5 V/m	266.1 V/m	M3	21.7 °C
190 / 836.6 MHz	(1, 21)	173.2 V/m	266.1 V/m	M3	21.7 °C
251 / 848.8 MHz	(2.5, 25)	178.4 V/m	266.1 V/m	M3	21.7 °C
251 / 848.8 MHz	worst case	188.5 V/m	266.1 V/m	M3	21.7 °C
512 / 1850.2 MHz	(-2.5, 25)	55.81 V/m	84.1 V/m	M3	21.7 °C
661 / 1880.0 MHz	(-3.0, 25)	52.92 V/m	84.1 V/m	M3	21.7 °C
810 / 1909.8 MHz	(-4.5, 25)	51.12 V/m	84.1 V/m	M3	21.7 °C
512 / 1850.2 MHz	worst case	59.93 V/m	84.1 V/m	M3	21.7 °C

Table 10: Test results GSM 850 and 1900 MHz (E-field) at speaker position

Hearing Aid Compatibility results for E-Field					
Channel / frequency	Location (x, y)	Max E-Field (peak)	M3 limit	category	air temperature
4132 / 826.4 MHz	(1.5, 25)	63.93 V/m	266.1 V/m	M4	21.7 °C
4182 / 836.4 MHz	(2, 25)	59.56 V/m	266.1 V/m	M4	21.7 °C
4233 / 846.6 MHz	(2, 25)	70.91 V/m	266.1 V/m	M4	21.7 °C
4233 / 846.6 MHz	worst case	75.16 V/m	266.1 V/m	M4	21.7 °C
1312 / 1712.4 MHz	(-2.5, 25)	27.83 V/m	84.1 V/m	M4	21.7 °C
1412 / 1732.4 MHz	(-2.5, 25)	26.24 V/m	84.1 V/m	M4	21.7 °C
1513 / 1752.6 MHz	(-1.5, 25)	28.26 V/m	84.1 V/m	M4	21.7 °C
1513 / 1752.6 MHz	worst case	30.41 V/m	84.1 V/m	M4	21.7 °C
9262 / 1852.4 MHz	(-2, 25)	23.42 V/m	84.1 V/m	M4	21.7 °C
9400 / 1880.0 MHz	(-1.5, 25)	23.36 V/m	84.1 V/m	M4	21.7 °C
9538 / 1907.6 MHz	(-5, 25)	22.83 V/m	84.1 V/m	M4	21.7 °C
9262 / 1852.4 MHz	worst case	25.09 V/m	84.1 V/m	M4	21.7 °C

Table 11: Test results WCDMA FDD II, FDD IV and FDD V (E-field) at speaker position

Hearing Aid Compatibility results for H-Field					
Channel / frequency	Location (x, y)	Max H-Field (peak)	M3 limit	category	air temperature
128 / 824.2 MHz	(25, -25)	0.283 A/m	0.8 A/m	M4	21.7 °C
190 / 836.6 MHz	(25, -25)	0.306 A/m	0.8 A/m	M4	21.7 °C
251 / 848.8 MHz	(25, -25)	0.321 A/m	0.8 A/m	M4	21.7 °C
251 / 848.8 MHz	worst case	0.327 A/m	0.8 A/m	M4	21.7 °C
512 / 1850.2 MHz	(-6.5, -1.5)	0.106 A/m	0.25 A/m	M4	21.7 °C
661 / 1880.0 MHz	(-1.5, -4.5)	0.110 A/m	0.25 A/m	M4	21.7 °C
810 / 1909.8 MHz	(-3.5, -2.5)	0.107 A/m	0.25 A/m	M4	21.7 °C
661 / 1880.0 MHz	worst case	0.111 A/m	0.25 A/m	M4	21.7 °C

Table 12: Test results GSM 850 and 1900 MHz (H-field) at speaker position

Hearing Aid Compatibility results for H-Field					
Channel / frequency	Location (x, y)	Max H-Field (peak)	M3 limit	category	air temperature
4132 / 826.4 MHz	(25, -25)	0.118 A/m	0.8 A/m	M4	21.7 °C
4182 / 836.4 MHz	(25, -25)	0.106 A/m	0.8 A/m	M4	21.7 °C
4233 / 846.6 MHz	(25, -25)	0.118 A/m	0.8 A/m	M4	21.7 °C
4132 / 826.4 MHz	worst case	0.120 A/m	0.8 A/m	M4	21.7 °C
1312 / 1712.4 MHz	(1.5, -5.5)	0.068 A/m	0.25 A/m	M4	21.7 °C
1412 / 1732.4 MHz	(2.5, -7)	0.065 A/m	0.25 A/m	M4	21.7 °C
1513 / 1752.6 MHz	(1.5, -5)	0.076 A/m	0.25 A/m	M4	21.7 °C
1513 / 1752.6 MHz	worst case	0.077 A/m	0.25 A/m	M4	21.7 °C
9262 / 1852.4 MHz	(-7, -3)	0.056 A/m	0.25 A/m	M4	21.7 °C
9400 / 1880.0 MHz	(-1.5, -5.5)	0.060 A/m	0.25 A/m	M4	21.7 °C
9538 / 1907.6 MHz	(-2, -4)	0.057 A/m	0.25 A/m	M4	21.7 °C
9400 / 1880.0 MHz	worst case	0.061 A/m	0.25 A/m	M4	21.7 °C

Table 13: Test results WCDMA FDD II, FDD IV and FDD V (H-field) at speaker position

Overall category: M3

6.3.2 General description of test procedures

The device was tested using a CMU 200 communications tester as controller unit to set test channels and maximum output power to the DUT, as well as for measuring the conducted peak power. The conducted output power was measured using an integrated RF connector and attached RF cable.

Worst case configuration evaluation was performed at channel with highest field level by rotating the probe 360° at azimuth axis (see annex A.2) and calculation to maximum peak.

7 Test equipment and ancillaries used for tests

To simplify the identification of the test equipment and/or ancillaries which were used, the reporting of the relevant test cases only refer to the test item number as specified in the table below.

used	Equipment	Type	Manufacturer	Serial No.	Last Calibration	Frequency (months)
<input checked="" type="checkbox"/>	E-Field Probe	ER3DV6	Schmid & Partner Engineering AG	2262	January 9, 2012	12
<input checked="" type="checkbox"/>	H-Field Probe	H3DV6	Schmid & Partner Engineering AG	6086	January 14, 2012	12
<input checked="" type="checkbox"/>	835 MHz System Validation Dipole	CD900V3	Schmid & Partner Engineering AG	1027	May 8, 2012	12
<input checked="" type="checkbox"/>	1880 MHz System Validation Dipole	CD1880V3	Schmid & Partner Engineering AG	1021	May 8, 2012	12
<input checked="" type="checkbox"/>	Data acquisition electronics	DAE3V1	Schmid & Partner Engineering AG	477	May 9, 2012	12
<input checked="" type="checkbox"/>	Software	DASY52 52.8.1	Schmid & Partner Engineering AG	---	N/A	--
<input checked="" type="checkbox"/>	HAC test arch	SD HAC P01 BA	Schmid & Partner Engineering AG	1022	N/A	--
<input checked="" type="checkbox"/>	Universal Radio Communication Tester	CMU 200	Rohde & Schwarz	106826	March 06, 2012	12
<input checked="" type="checkbox"/>	Signal Generator	8665A	Hewlett Packard	2833A00112	January 6, 2012	12
<input checked="" type="checkbox"/>	Amplifier	M20.40.30	Nucleudes	35/2001	N/A	--
<input checked="" type="checkbox"/>	Power Meter	NRP	Rohde & Schwarz	101367	January 6, 2011	24
<input checked="" type="checkbox"/>	Power Meter Sensor	NRP Z22	Rohde & Schwarz	100227	January 9, 2012	12
<input checked="" type="checkbox"/>	Power Meter Sensor	NRP Z22	Rohde & Schwarz	100234	January 9, 2012	12

8 Observations

No observations exceeding those reported with the single test cases have been made.

Annex A: System performance check

Date/Time: 08.12.2012 13:07:30

HAC-RF-System check

DUT: HAC-Dipole 835 MHz; Type: D835V3; Serial: 1027

Communication System: CW; Frequency: **835 MHz**; Duty Cycle: 1:1

Medium parameters used: $\sigma = 0$ mho/m, $\epsilon_r = 1$; $\rho = 0$ kg/m³

Phantom section: TCoil Section

DASY5 Configuration:

- Probe: ER3DV6 - SN2262; ConvF(1, 1, 1); Calibrated: 09.01.2012;
- Sensor-Surface: 0mm (Fix Surface)
- Electronics: DAE3 Sn477; Calibrated: 09.05.2012
- Phantom: HAC Test Arch with AMCC; Type: SD HAC P01 BA; Serial: 1007+1022
- Measurement SW: DASY52 52.8.2(969); Postprocessing SW: SEMCAD X 14.6.6(6824)

Dipole E-Field 835/E Scan - measurement distance = 10mm/Hearing Aid Compatibility Test at 10mm distance (41x361x1): Interpolated grid: dx=0.5000 mm, dy=0.5000 mm

Device Reference Point: 0, 0, -6.3 mm

Reference Value = 104.1 V/m; Power Drift = 0.04 dB

PMR not calibrated. PMF = 1.000 is applied.

Maximum value of Total (interpolated) = 166.0 V/m

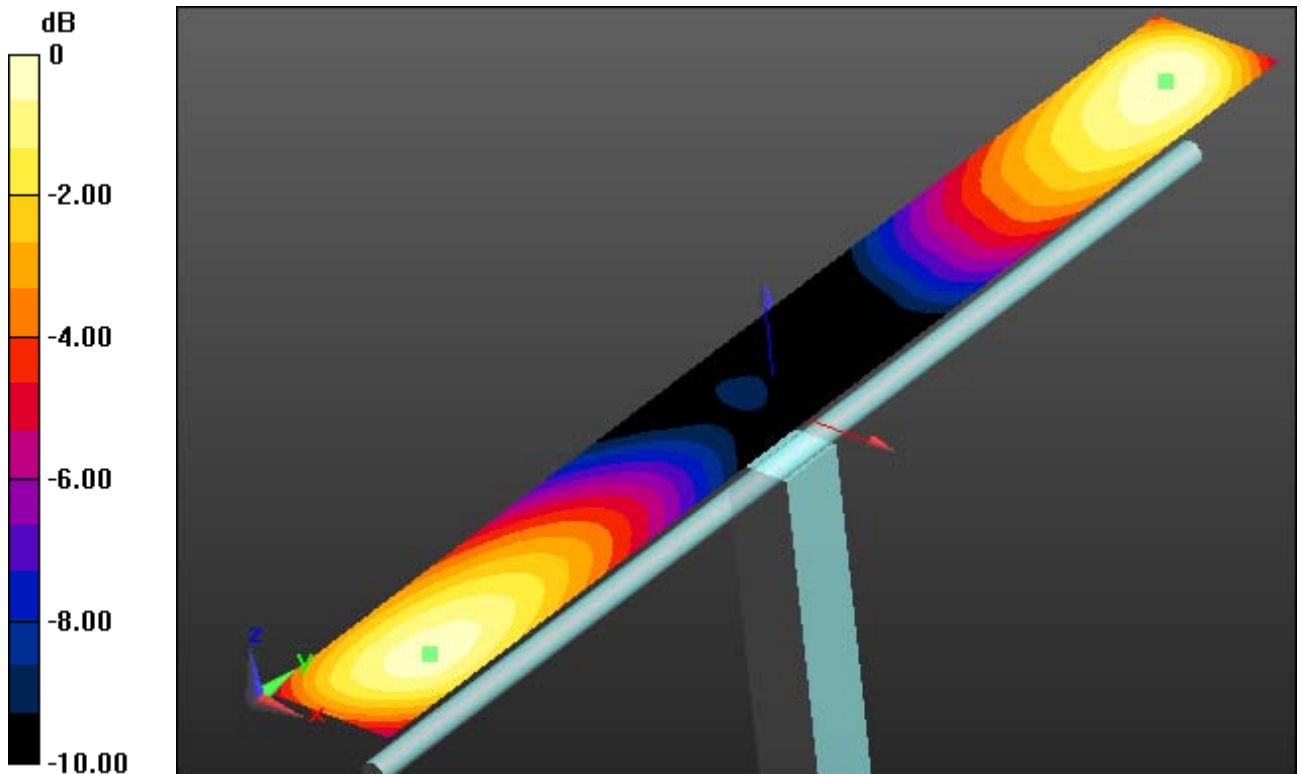

0 dB = 166.0 V/m = 44.40 dB V/m

Date/Time: 08.12.2012 13:35:59

HAC-RF-System check

DUT: HAC Dipole 1880 MHz; Type: CD1880V3; Serial: 1021

Communication System: CW; Frequency: **1730 MHz** ;Duty Cycle: 1:1

Medium parameters used: $\sigma = 0$ mho/m, $\epsilon_r = 1$; $\rho = 0$ kg/m³

Phantom section: TCoil Section

DASY5 Configuration:

- Probe: ER3DV6 - SN2262; ConvF(1, 1, 1); Calibrated: 09.01.2012;
- Sensor-Surface: 0mm (Fix Surface)
- Electronics: DAE3 Sn477; Calibrated: 09.05.2012
- Phantom: HAC Test Arch with AMCC; Type: SD HAC P01 BA; Serial: 1007+1022
- Measurement SW: DASY52 52.8.2(969); Postprocessing SW: SEMCAD X 14.6.6(6824)

Dipole E-Field 1880/E Scan - measurement distance = 10mm/Hearing Aid Compatibility Test at 10mm distance (41x361x1):

Interpolated grid: dx=0.5000 mm, dy=0.5000 mm

Device Reference Point: 0, 0, -6.3 mm

Reference Value = 169.2 V/m; Power Drift = 0.01 dB

PMR not calibrated. PMF = 1.000 is applied.

Maximum value of Total (interpolated) = 151.5 V/m

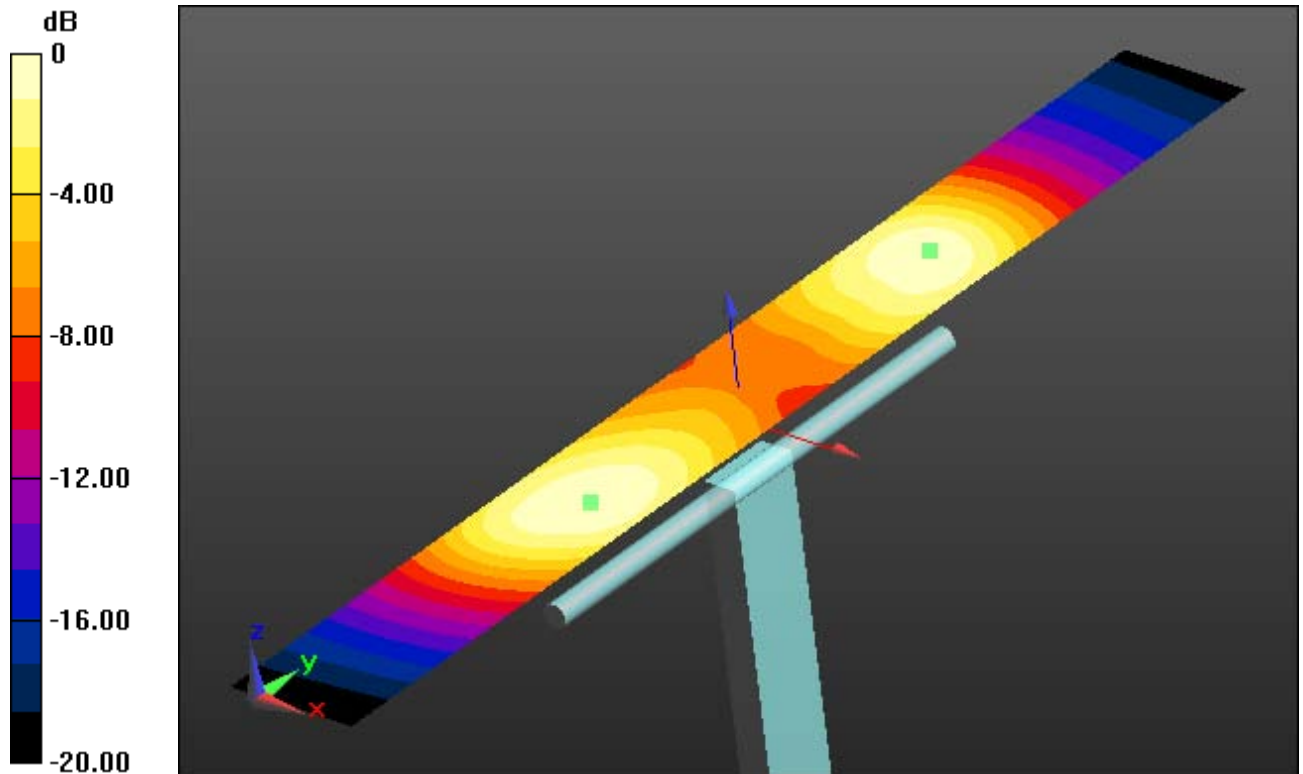

0 dB = 151.5 V/m = 43.61 dB V/m

Date/Time: 08.12.2012 13:51:07

HAC-RF-System check

DUT: HAC Dipole 1880 MHz; Type: CD1880V3; Serial: 1021

Communication System: CW; Frequency: **1880 MHz**; Duty Cycle: 1:1

Medium parameters used: $\sigma = 0$ mho/m, $\epsilon_r = 1$; $\rho = 0$ kg/m³

Phantom section: TCoil Section

DASY5 Configuration:

- Probe: ER3DV6 - SN2262; ConvF(1, 1, 1); Calibrated: 09.01.2012;
- Sensor-Surface: 0mm (Fix Surface)
- Electronics: DAE3 Sn477; Calibrated: 09.05.2012
- Phantom: HAC Test Arch with AMCC; Type: SD HAC P01 BA; Serial: 1007+1022
- Measurement SW: DASY52 52.8.2(969); Postprocessing SW: SEMCAD X 14.6.6(6824)

Dipole E-Field 1880/E Scan - measurement distance = 10mm/Hearing Aid Compatibility Test at 10mm distance (41x181x1): Interpolated grid: dx=0.5000 mm, dy=0.5000 mm

Device Reference Point: 0, 0, -6.3 mm

Reference Value = 154.2 V/m; Power Drift = -0.01 dB

PMR not calibrated. PMF = 1.000 is applied.

Maximum value of Total (interpolated) = 137.2 V/m

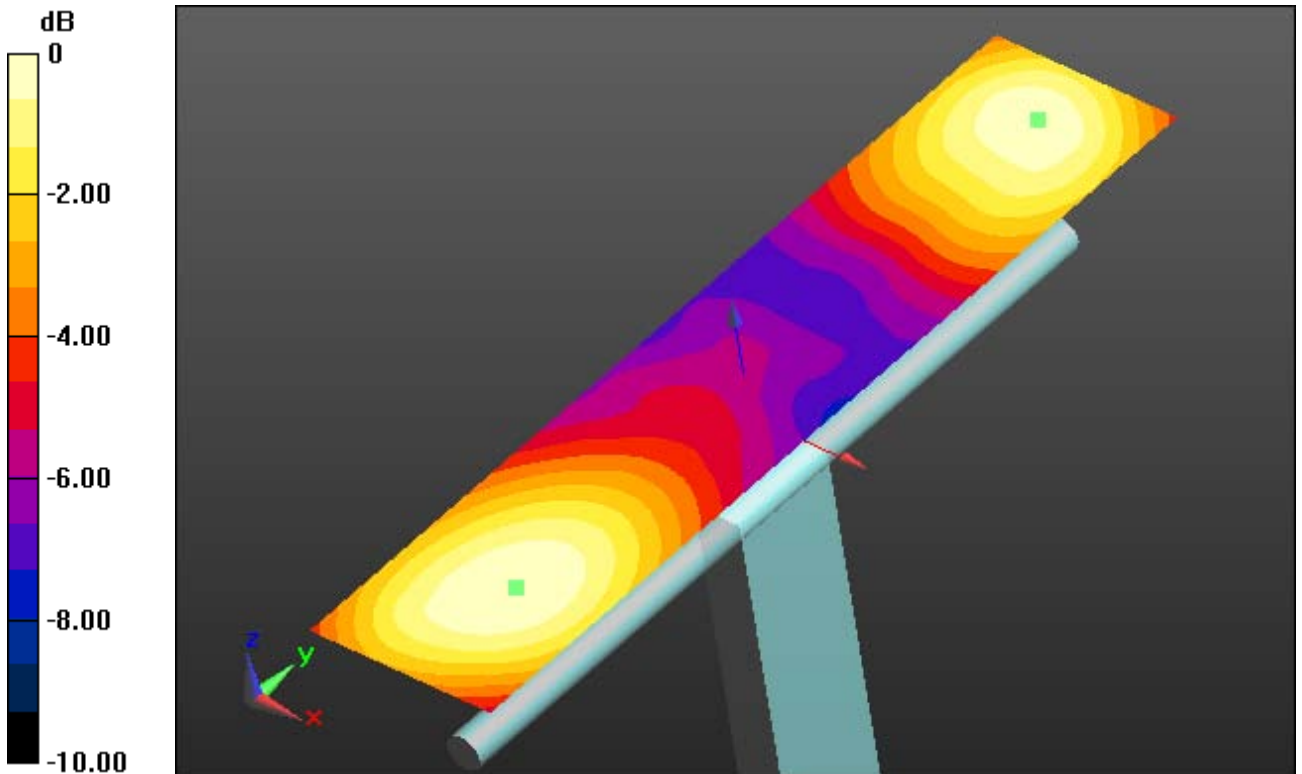

0 dB = 137.2 V/m = 42.75 dB V/m

Date/Time: 10.12.2012 07:00:26

HAC-RF-System check

DUT: HAC-Dipole 835 MHz; Type: D835V3; Serial: 1027

Communication System: CW; Frequency: **835 MHz**; Duty Cycle: 1:1

Medium parameters used: $\sigma = 0$ mho/m, $\epsilon_r = 1$; $\rho = 0$ kg/m³

Phantom section: TCoil Section

DASY5 Configuration:

- Probe: H3DV6 - SN6086; ; Calibrated: 14.01.2012
- Sensor-Surface: 0mm (Fix Surface)
- Electronics: DAE3 Sn477; Calibrated: 09.05.2012
- Phantom: HAC Test Arch with AMCC; Type: SD HAC P01 BA; Serial: 1007+1022
- Measurement SW: DASY52 52.8.2(969); Postprocessing SW: SEMCAD X 14.6.6(6824)

Dipole H-Field 835/H Scan - measurement distance = 10mm/Hearing Aid Compatibility Test 10mm (41x361x1): Interpolated grid: dx=0.5000 mm, dy=0.5000 mm

Device Reference Point: 0, 0, -6.3 mm

Reference Value = 0.4750 V/m; Power Drift = 0.00 dB

PMR not calibrated. PMF = 1.000 is applied.

Maximum value of Total (interpolated) = 0.4477 A/m

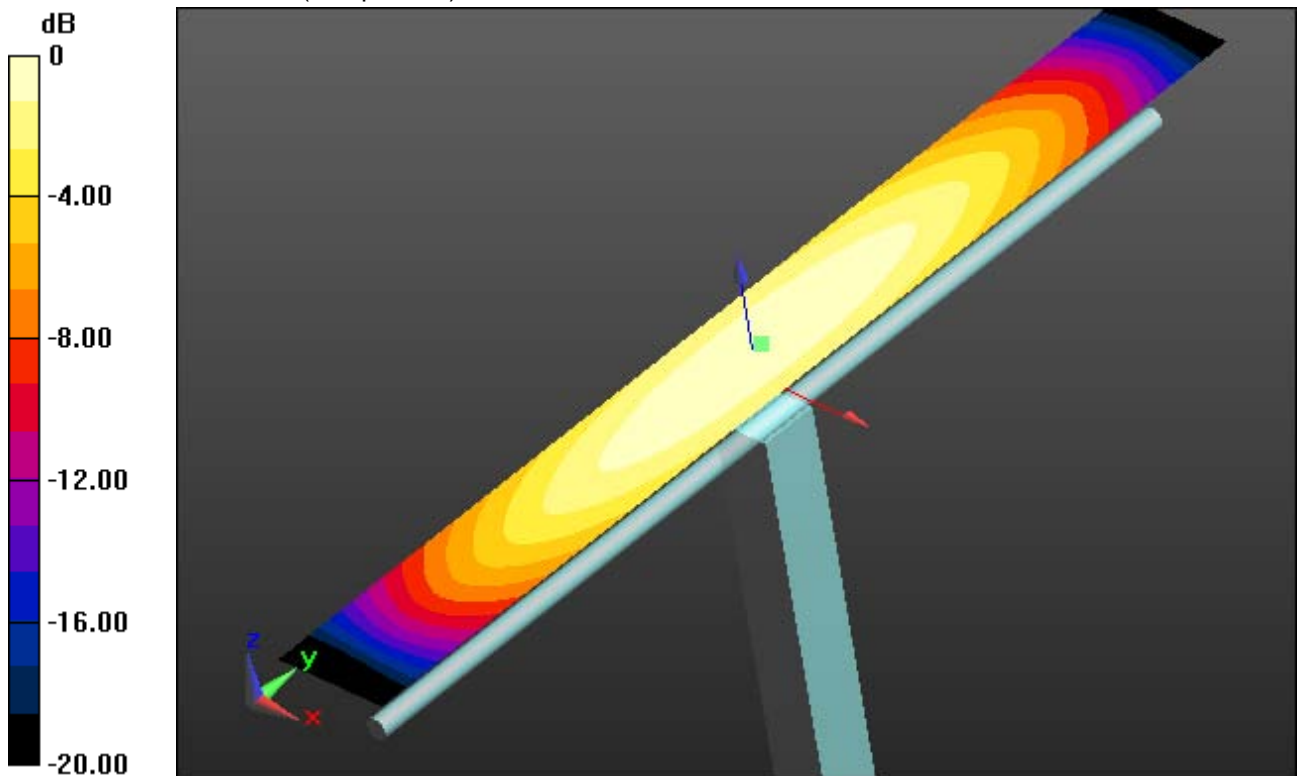

0 dB = 0.4477 A/m = -6.98 dB A/m

Date/Time: 10.12.2012 06:46:24

HAC-RF-System check

DUT: HAC Dipole 1880 MHz; Type: CD1880V3; Serial: 1021

Communication System: CW; Frequency: **1730 MHz**; Duty Cycle: 1:1

Medium parameters used: $\sigma = 0$ mho/m, $\epsilon_r = 1$; $\rho = 0$ kg/m³

Phantom section: TCoil Section

DASY5 Configuration:

- Probe: H3DV6 - SN6086; ; Calibrated: 14.01.2012
- Sensor-Surface: 0mm (Fix Surface)
- Electronics: DAE3 Sn477; Calibrated: 09.05.2012
- Phantom: HAC Test Arch with AMCC; Type: SD HAC P01 BA; Serial: 1007+1022
- Measurement SW: DASY52 52.8.2(969); Postprocessing SW: SEMCAD X 14.6.6(6824)

Dipole H-Field 1880/H Scan - measurement distance = 10mm/Hearing Aid Compatibility Test 10mm (41x181x1): Interpolated grid: dx=0.5000 mm, dy=0.5000 mm

Device Reference Point: 0, 0, -6.3 mm

Reference Value = 0.5450 V/m; Power Drift = 0.01 dB

PMR not calibrated. PMF = 1.000 is applied.

Maximum value of Total (interpolated) = 0.5125 A/m

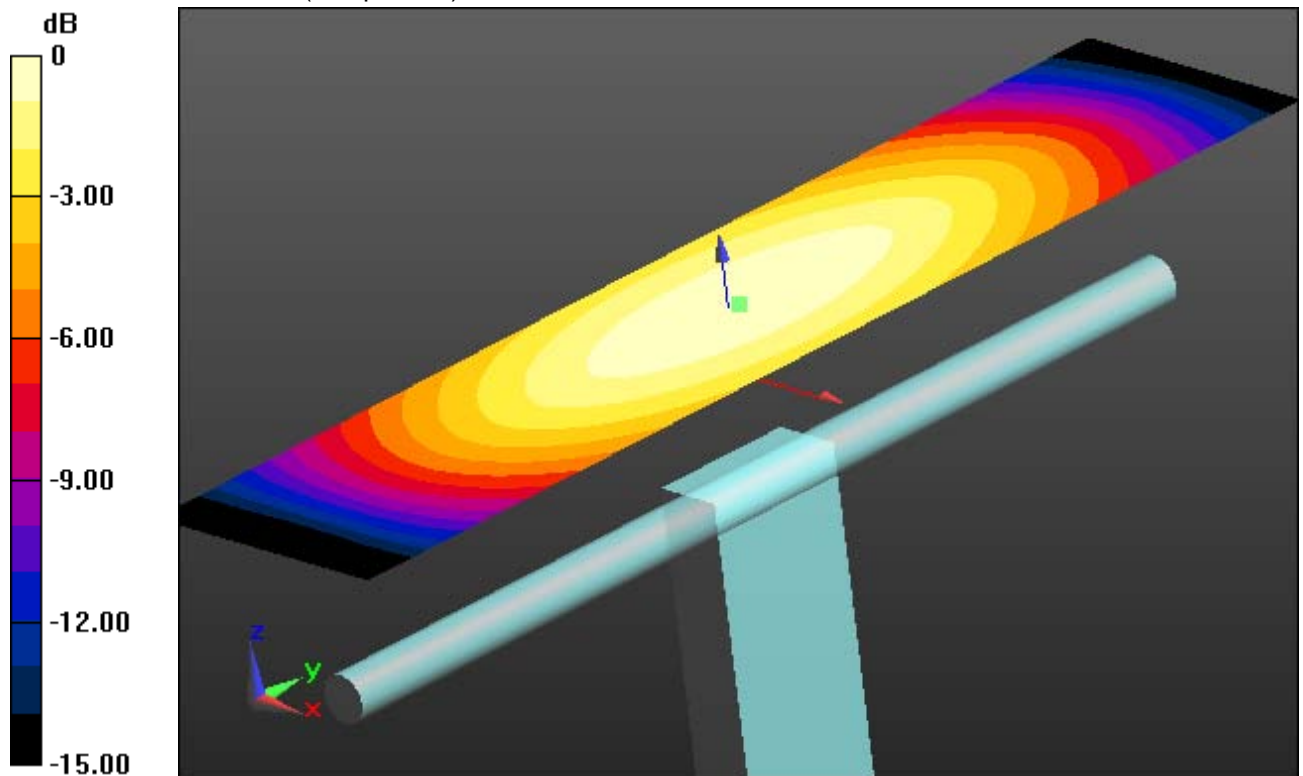

0 dB = 0.5125 A/m = -5.81 dB A/m

Date/Time: 10.12.2012 06:30:28

HAC-RF-System check

DUT: HAC Dipole 1880 MHz; Type: CD1880V3; Serial: 1021

Communication System: CW; Frequency: **1880 MHz**; Duty Cycle: 1:1

Medium parameters used: $\sigma = 0$ mho/m, $\epsilon_r = 1$; $\rho = 0$ kg/m³

Phantom section: TCoil Section

DASY5 Configuration:

- Probe: H3DV6 - SN6086; ; Calibrated: 14.01.2012
- Sensor-Surface: 0mm (Fix Surface)
- Electronics: DAE3 Sn477; Calibrated: 09.05.2012
- Phantom: HAC Test Arch with AMCC; Type: SD HAC P01 BA; Serial: 1007+1022
- Measurement SW: DASY52 52.8.2(969); Postprocessing SW: SEMCAD X 14.6.6(6824)

Dipole H-Field 1880/H Scan - measurement distance = 10mm/Hearing Aid Compatibility Test 10mm (41x181x1): Interpolated grid: dx=0.5000 mm, dy=0.5000 mm

Device Reference Point: 0, 0, -6.3 mm

Reference Value = 0.5030 V/m; Power Drift = 0.02 dB

PMR not calibrated. PMF = 1.000 is applied.

Maximum value of Total (interpolated) = 0.4750 A/m

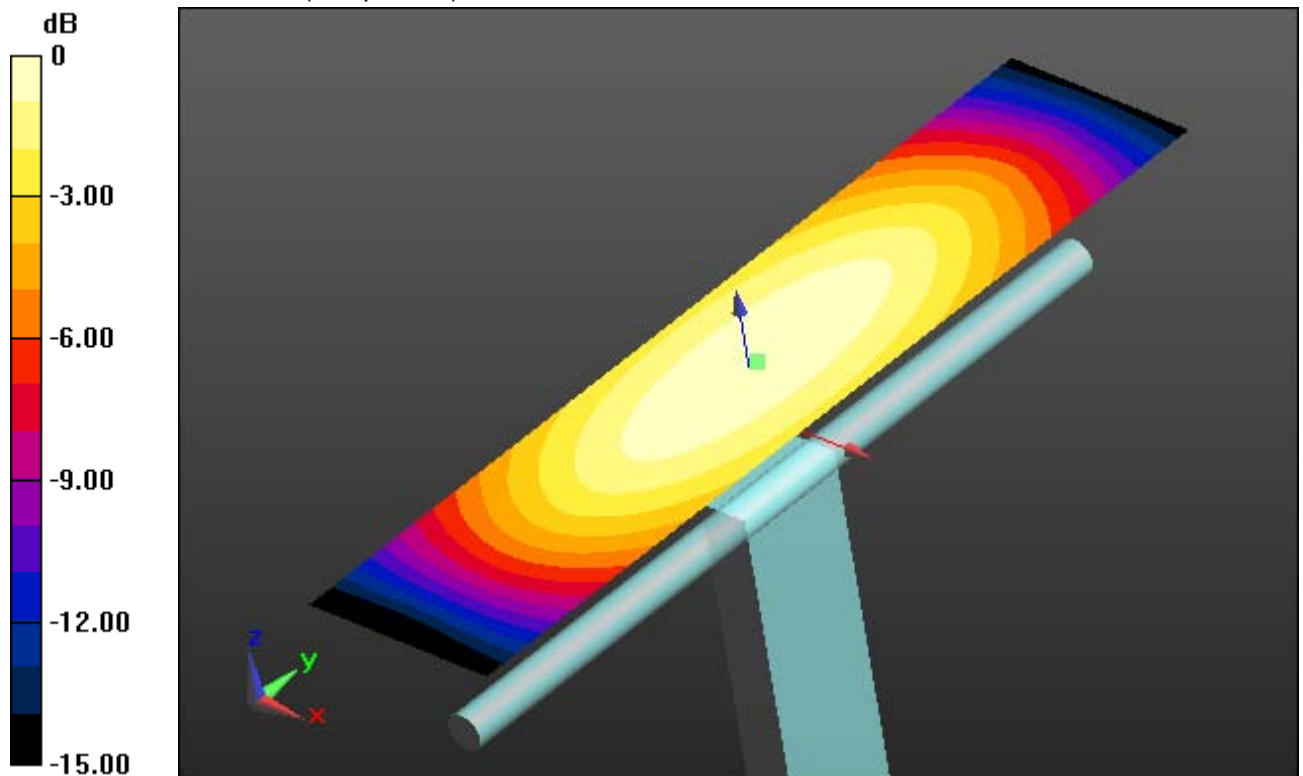

0 dB = 0.4750 A/m = -6.47 dB A/m

Annex B: DASY4 measurement results

Annex B.1: GSM 835MHz

Date/Time: 08.12.2012 14:51:50

HAC_E

DUT: Sony; Type: PM-0280-BV; Serial: CB5A1MAPY5

Communication System: Generic GSM; Frequency: 824.2 MHz; Duty Cycle: 1:8.30042

Medium parameters used: $\sigma = 0$ mho/m, $\epsilon_r = 1$; $\rho = 0$ kg/m³

Phantom section: TCoil Section

DASY5 Configuration:

- Probe: ER3DV6 - SN2262; ConvF(1, 1, 1); Calibrated: 09.01.2012;

- Sensor-Surface: (Fix Surface)

- Electronics: DAE3 Sn477; Calibrated: 09.05.2012

- Phantom: HAC Test Arch with AMCC; Type: SD HAC P01 BA; Serial: 1007+1022

- Measurement SW: DASY52 52.8.2(969); Postprocessing SW: SEMCAD X 14.6.6(6824)

HAC GSM850/E Scan - ER3D - 2007: 15 mm from Probe Center to the Device low/Hearing Aid Compatibility Test (101x101x1): Interpolated grid:

dx=0.5000 mm, dy=0.5000 mm

Device Reference Point: 0, 0, -6.3 mm

Reference Value = 27.22 V/m; Power Drift = 0.05 dB

PMR not calibrated. PMF = 2.970 is applied.

E-field emissions = 167.5 V/m

Near-field category: M3 (AWF -5 dB)

PMF scaled E-field

Grid 1 M4 138.8 V/m	Grid 2 M4 146.6 V/m	Grid 3 M4 138.4 V/m
Grid 4 M3 153.5 V/m	Grid 5 M3 162.0 V/m	Grid 6 M3 151.8 V/m
Grid 7 M3 162.5 V/m	Grid 8 M3 167.5 V/m	Grid 9 M3 153.9 V/m

Category	AWF (dB)	Limits for E-Field Emissions (V/m) < 960MHz	Limits for H-Field Emissions (A/m) < 960 MHz
M1	0	631 - 1122	1.91 - 3.39
	-5	473.2 - 841.4	1.43 - 2.54
M2	0	354.8 - 631	1.07 - 1.91
	-5	266.1 - 473.2	0.8 - 1.43
M3	0	199.5 - 354.8	0.6 - 1.07
	-5	149.6 - 266.1	0.45 - 0.8
M4	0	<199.5	<0.6
	-5	<149.6	<0.45

Cursor:

Total = 167.5 V/m

E Category: M3
Location: 1.5, 25, 8.7 mm

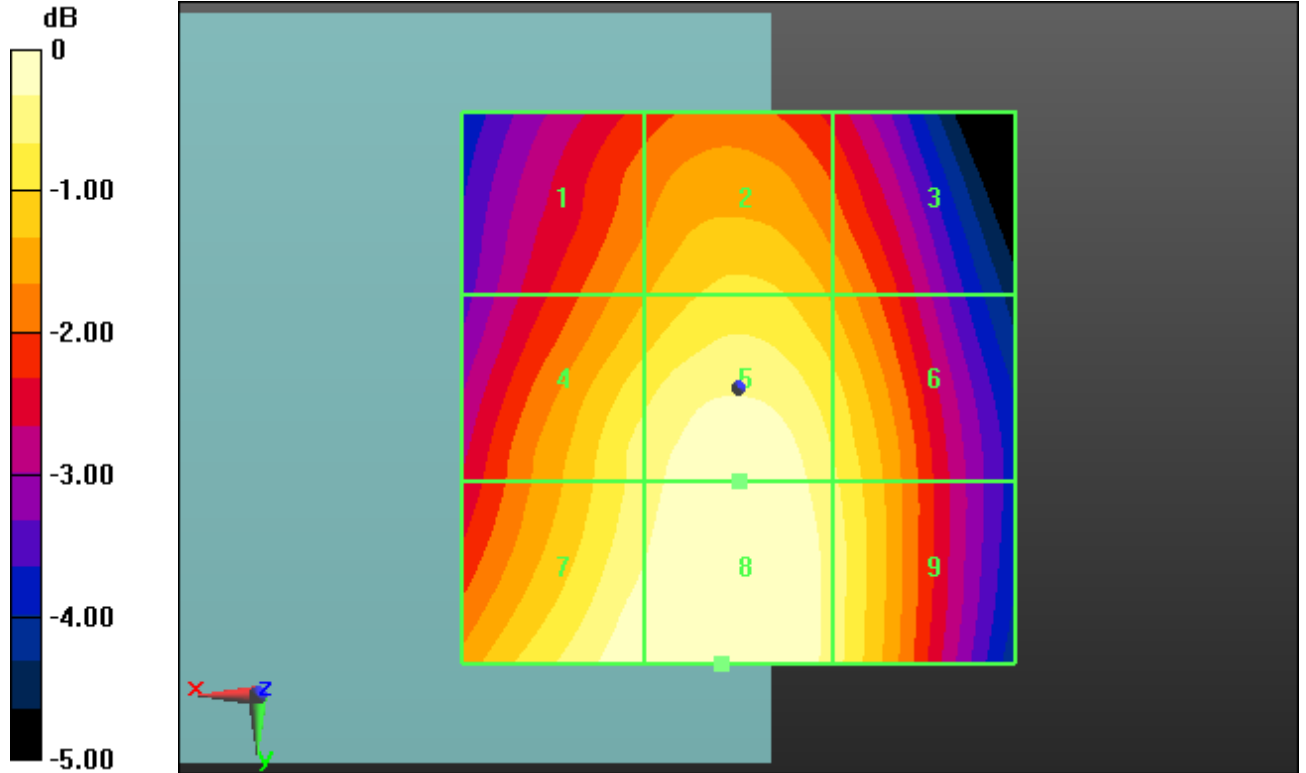

0 dB = 162.4 V/m = 44.21 dB V/m

Date/Time: 08.12.2012 14:59:49

HAC_E

DUT: Sony; Type: PM-0280-BV; Serial: CB5A1MAPY5

Communication System: Generic GSM; Frequency: 836.6 MHz; Duty Cycle: 1:8.30042

Medium parameters used: $\sigma = 0$ mho/m, $\epsilon_r = 1$; $\rho = 0$ kg/m³

Phantom section: TCoil Section

DASY5 Configuration:

- Probe: ER3DV6 - SN2262; ConvF(1, 1, 1); Calibrated: 09.01.2012;
- Sensor-Surface: (Fix Surface)
- Electronics: DAE3 Sn477; Calibrated: 09.05.2012
- Phantom: HAC Test Arch with AMCC; Type: SD HAC P01 BA; Serial: 1007+1022
- Measurement SW: DASY52 52.8.2(969); Postprocessing SW: SEMCAD X 14.6.6(6824)

HAC GSM850/E Scan - ER3D - 2007: 15 mm from Probe Center to the Device middle/Hearing Aid Compatibility Test (101x101x1): Interpolated grid:

dx=0.5000 mm, dy=0.5000 mm

Device Reference Point: 0, 0, -6.3 mm

Reference Value = 29.39 V/m; Power Drift = -0.02 dB

PMR not calibrated. PMF = 2.970 is applied.

E-field emissions = 173.2 V/m

Near-field category: M3 (AWF -5 dB)

PMF scaled E-field

Grid 1 M4 147.0 V/m	Grid 2 M3 154.9 V/m	Grid 3 M4 147.5 V/m
Grid 4 M3 160.6 V/m	Grid 5 M3 169.4 V/m	Grid 6 M3 158.5 V/m
Grid 7 M3 168.4 V/m	Grid 8 M3 173.2 V/m	Grid 9 M3 159.7 V/m

Category	AWF (dB)	Limits for E-Field Emissions (V/m) < 960MHz	Limits for H-Field Emissions (A/m) < 960 MHz
M1	0	631 - 1122	1.91 - 3.39
	-5	473.2 - 841.4	1.43 - 2.54
M2	0	354.8 - 631	1.07 - 1.91
	-5	266.1 - 473.2	0.8 - 1.43
M3	0	199.5 - 354.8	0.6 - 1.07
	-5	149.6 - 266.1	0.45 - 0.8
M4	0	<199.5	<0.6
	-5	<149.6	<0.45

Cursor:

Total = 173.2 V/m

E Category: M3

Location: 1, 21, 8.7 mm

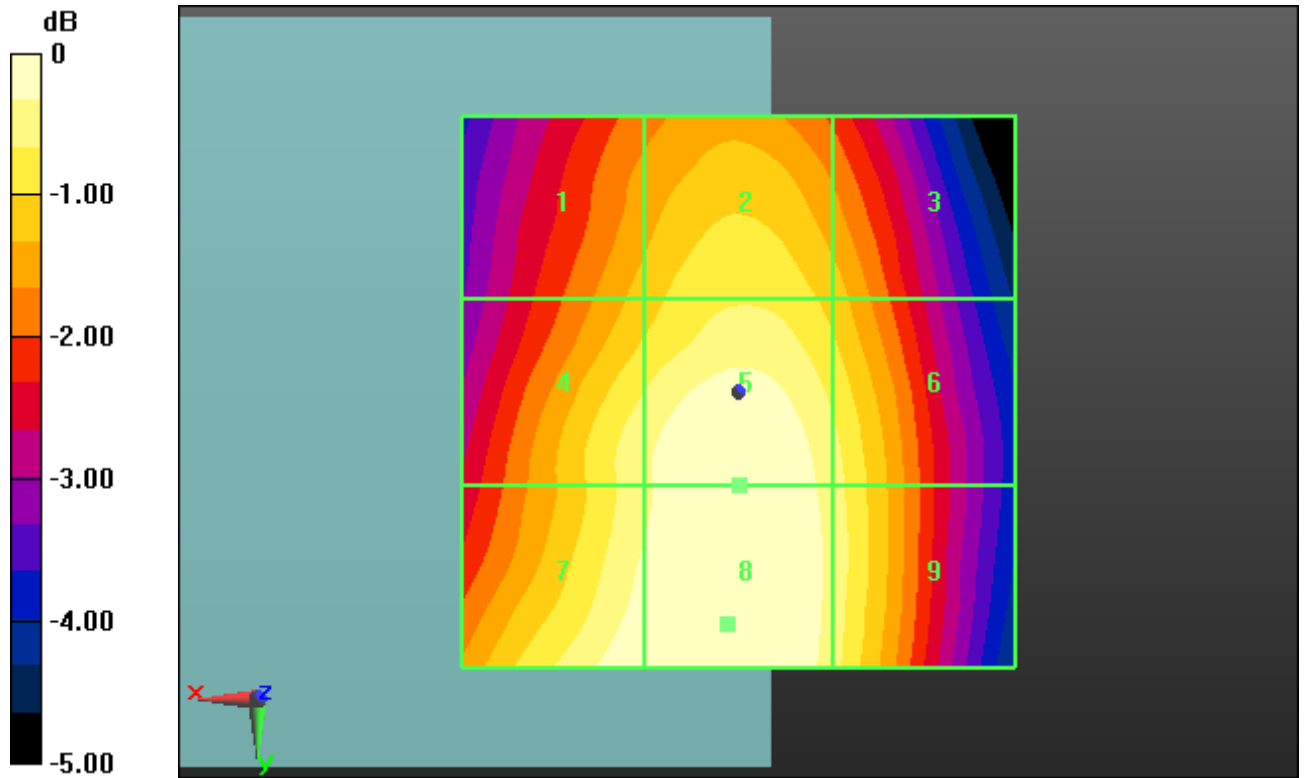

0 dB = 168.0 V/m = 44.51 dB V/m

Date/Time: 08.12.2012 15:04:55

HAC_E

DUT: Sony; Type: PM-0280-BV; Serial: CB5A1MAPY5

Communication System: Generic GSM; Frequency: 848.6 MHz; Duty Cycle: 1:8.30042

Medium parameters used: $\sigma = 0$ mho/m, $\epsilon_r = 1$; $\rho = 0$ kg/m³

Phantom section: TCoil Section

DASY5 Configuration:

- Probe: ER3DV6 - SN2262; ConvF(1, 1, 1); Calibrated: 09.01.2012;
- Sensor-Surface: (Fix Surface)
- Electronics: DAE3 Sn477; Calibrated: 09.05.2012
- Phantom: HAC Test Arch with AMCC; Type: SD HAC P01 BA; Serial: 1007+1022
- Measurement SW: DASY52 52.8.2(969); Postprocessing SW: SEMCAD X 14.6.6(6824)

HAC GSM850/E Scan - ER3D - 2007: 15 mm from Probe Center to the Device high/Hearing Aid Compatibility Test (101x101x1): Interpolated grid:

dx=0.5000 mm, dy=0.5000 mm

Device Reference Point: 0, 0, -6.3 mm

Reference Value = 29.81 V/m; Power Drift = 0.01 dB

PMR not calibrated. PMF = 2.970 is applied.

E-field emissions = 178.4 V/m

Near-field category: M3 (AWF -5 dB)

PMF scaled E-field

Grid 1 M4 145.0 V/m	Grid 2 M3 155.0 V/m	Grid 3 M4 148.4 V/m
Grid 4 M3 161.4 V/m	Grid 5 M3 171.3 V/m	Grid 6 M3 161.2 V/m
Grid 7 M3 172.9 V/m	Grid 8 M3 178.4 V/m	Grid 9 M3 163.8 V/m

Category	AWF (dB)	Limits for E-Field Emissions (V/m) < 960MHz	Limits for H-Field Emissions (A/m) < 960 MHz
M1	0	631 - 1122	1.91 - 3.39
	-5	473.2 - 841.4	1.43 - 2.54
M2	0	354.8 - 631	1.07 - 1.91
	-5	266.1 - 473.2	0.8 - 1.43
M3	0	199.5 - 354.8	0.6 - 1.07
	-5	149.6 - 266.1	0.45 - 0.8
M4	0	<199.5	<0.6
	-5	<149.6	<0.45

Cursor:

Total = 178.4 V/m

E Category: M3

Location: 2.5, 25, 8.7 mm

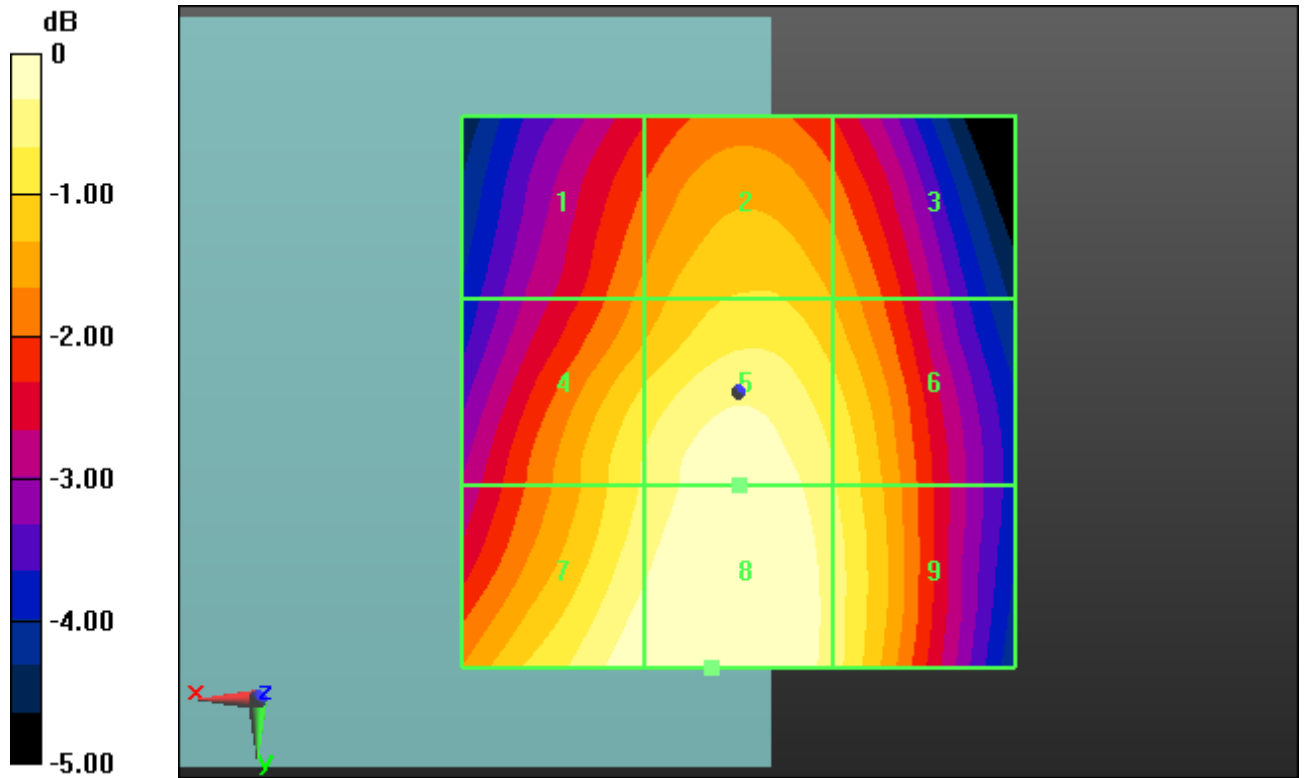

0 dB = 173.1 V/m = 44.77 dB V/m

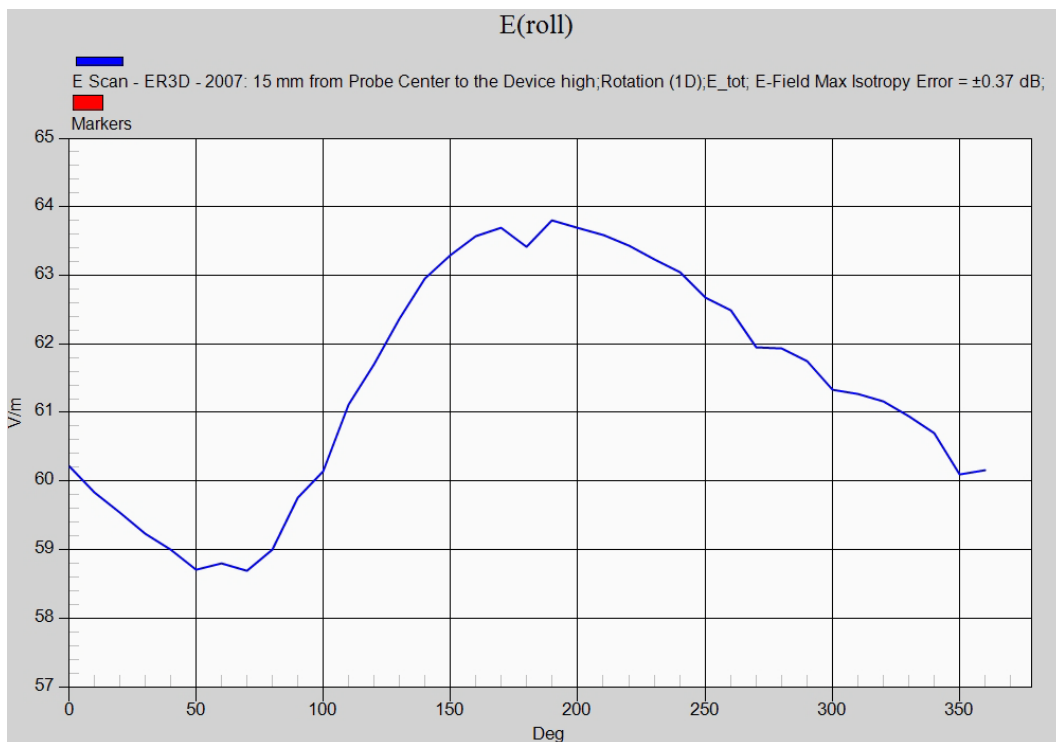

rot 0°	rot max.	percentage deviation	max. field strength (V/m)	worst case calculated (V/m)
60.2	63.8	5.64%	178.4	188.5

Date/Time: 10.12.2012 09:55:09

HAC-RF

DUT: Sony; Type: PM-0280-BV; Serial: CB5A1MAPY5

Communication System: Generic GSM; Frequency: 824.2 MHz; Duty Cycle: 1:8.30042

Medium parameters used: $\sigma = 0$ mho/m, $\epsilon_r = 1$; $\rho = 0$ kg/m³

Phantom section: TCoil Section

DASY5 Configuration:

- Probe: H3DV6 - SN6086; ; Calibrated: 14.01.2012
- Sensor-Surface: (Fix Surface)
- Electronics: DAE3 Sn477; Calibrated: 09.05.2012
- Phantom: HAC Test Arch with AMCC; Type: SD HAC P01 BA; Serial: 1007+1022
- Measurement SW: DASY52 52.8.2(969); Postprocessing SW: SEMCAD X 14.6.6(6824)

Device H-Field measurement GSM 850/H Scan - H3DV6: 15 mm from Probe Center to the Device Low/Hearing Aid Compatibility Test (101x101x1):

Interpolated grid: dx=0.5000 mm, dy=0.5000 mm

Device Reference Point: 0, 0, -6.3 mm

Reference Value = 0.04300 A/m; Power Drift = 0.07 dB

PMR not calibrated. PMF = 2.860 is applied.

H-field emissions = 0.2829 A/m

Near-field category: M4 (AWF -5 dB)

PMF scaled H-field

Grid 1 M4 0.283 A/m	Grid 2 M4 0.192 A/m	Grid 3 M4 0.119 A/m
Grid 4 M4 0.254 A/m	Grid 5 M4 0.173 A/m	Grid 6 M4 0.100 A/m
Grid 7 M4 0.271 A/m	Grid 8 M4 0.172 A/m	Grid 9 M4 0.090 A/m

Category	AWF (dB)	Limits for E-Field Emissions (V/m) < 960MHz	Limits for H-Field Emissions (A/m) < 960 MHz
M1	0	631 - 1122	1.91 - 3.39
	-5	473.2 - 841.4	1.43 - 2.54
M2	0	354.8 - 631	1.07 - 1.91
	-5	266.1 - 473.2	0.8 - 1.43
M3	0	199.5 - 354.8	0.6 - 1.07
	-5	149.6 - 266.1	0.45 - 0.8
M4	0	<199.5	<0.6
	-5	<149.6	<0.45

Cursor:

Total = 0.2829 A/m

H Category: M4

Location: 25, -25, 8.7 mm

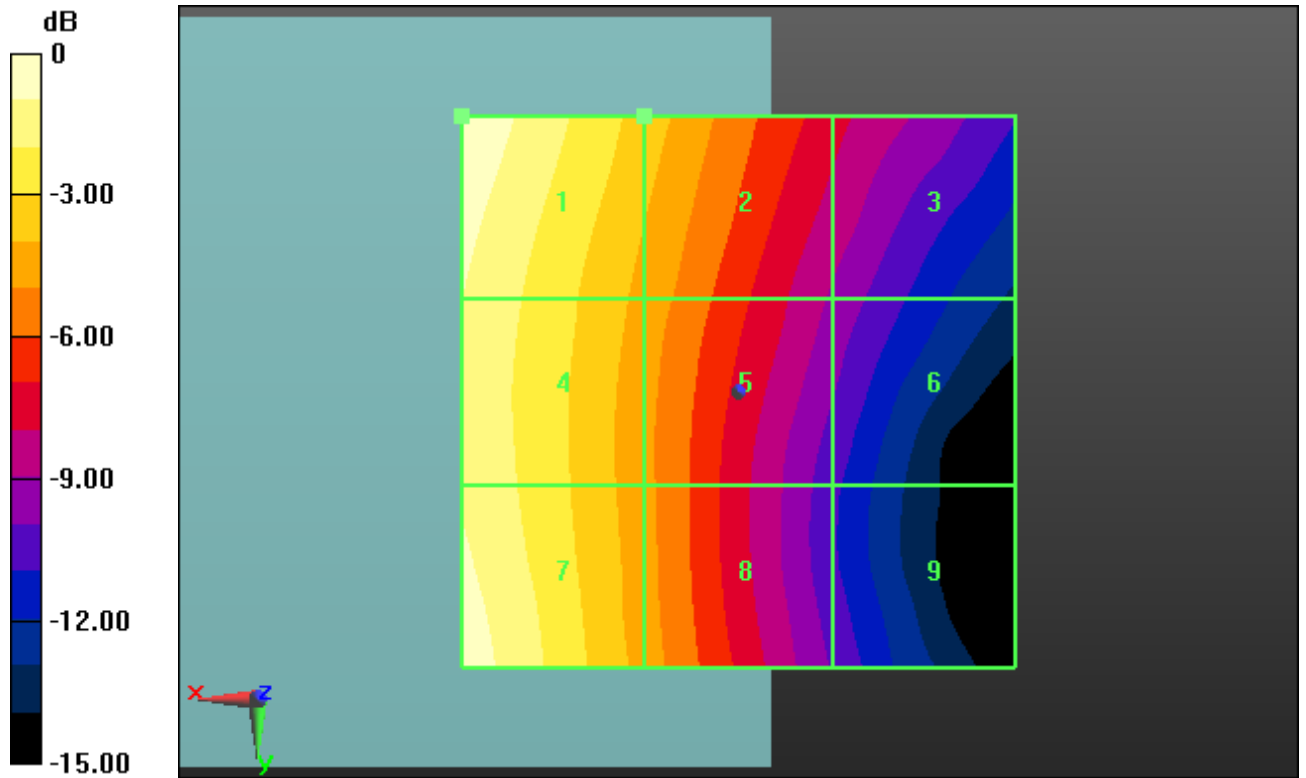

0 dB = 0.2850 A/m = -10.90 dB A/m

Date/Time: 10.12.2012 10:10:58

HAC-RF

DUT: Sony; Type: PM-0280-BV; Serial: CB5A1MAPY5

Communication System: Generic GSM; Frequency: 836.6 MHz; Duty Cycle: 1:8.30042

Medium parameters used: $\sigma = 0$ mho/m, $\epsilon_r = 1$; $\rho = 0$ kg/m³

Phantom section: TCoil Section

DASY5 Configuration:

- Probe: H3DV6 - SN6086; ; Calibrated: 14.01.2012
- Sensor-Surface: (Fix Surface)
- Electronics: DAE3 Sn477; Calibrated: 09.05.2012
- Phantom: HAC Test Arch with AMCC; Type: SD HAC P01 BA; Serial: 1007+1022
- Measurement SW: DASY52 52.8.2(969); Postprocessing SW: SEMCAD X 14.6.6(6824)

Device H-Field measurement GSM 850/H Scan - H3DV6: 15 mm from Probe Center to the Device Middle/Hearing Aid Compatibility Test (101x101x1):

Interpolated grid: dx=0.5000 mm, dy=0.5000 mm

Device Reference Point: 0, 0, -6.3 mm

Reference Value = 0.04800 A/m; Power Drift = 0.06 dB

PMR not calibrated. PMF = 2.860 is applied.

H-field emissions = 0.3056 A/m

Near-field category: M4 (AWF -5 dB)

PMF scaled H-field

Grid 1 M4 0.306 A/m	Grid 2 M4 0.207 A/m	Grid 3 M4 0.125 A/m
Grid 4 M4 0.281 A/m	Grid 5 M4 0.189 A/m	Grid 6 M4 0.108 A/m
Grid 7 M4 0.305 A/m	Grid 8 M4 0.195 A/m	Grid 9 M4 0.107 A/m

Category	AWF (dB)	Limits for E-Field Emissions (V/m) < 960MHz	Limits for H-Field Emissions (A/m) < 960 MHz
M1	0	631 - 1122	1.91 - 3.39
	-5	473.2 - 841.4	1.43 - 2.54
M2	0	354.8 - 631	1.07 - 1.91
	-5	266.1 - 473.2	0.8 - 1.43
M3	0	199.5 - 354.8	0.6 - 1.07
	-5	149.6 - 266.1	0.45 - 0.8
M4	0	<199.5	<0.6
	-5	<149.6	<0.45

Cursor:

Total = 0.3056 A/m

H Category: M4

Location: 25, -25, 8.7 mm

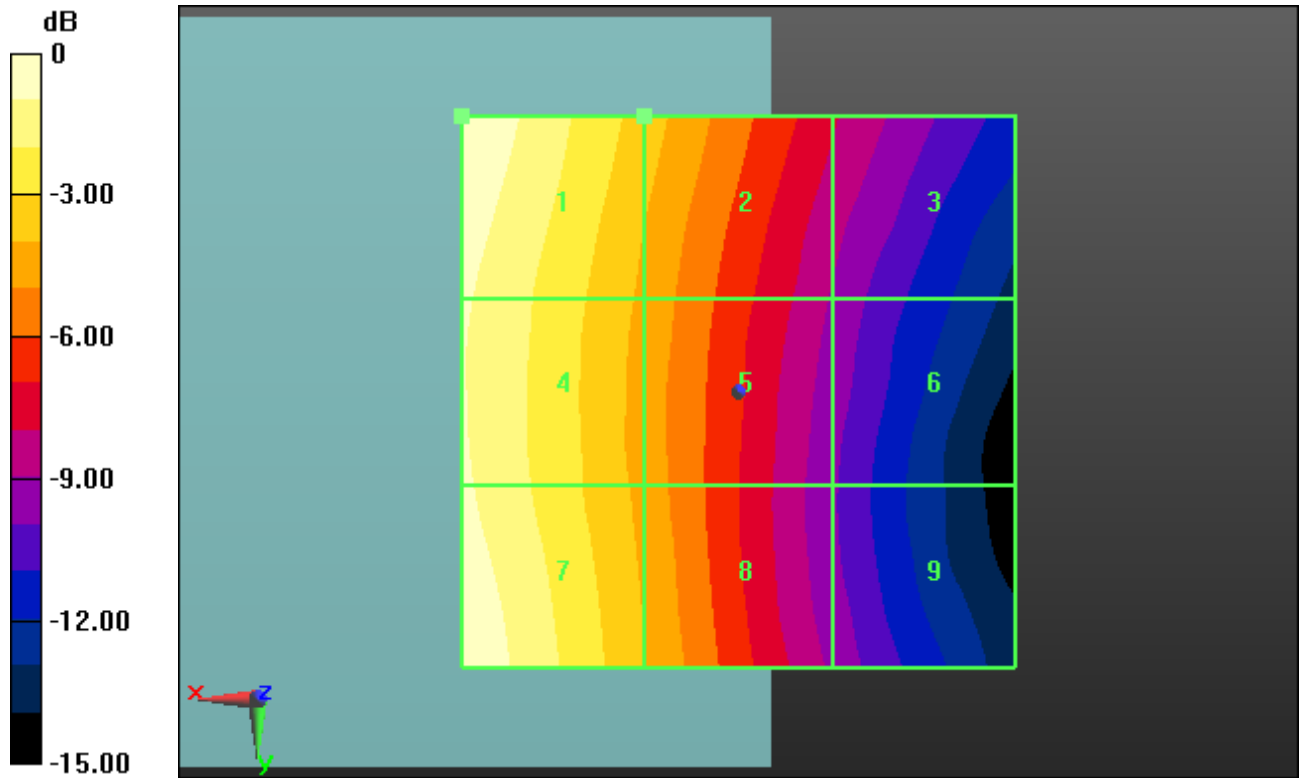

0 dB = 0.3078 A/m = -10.23 dB A/m

Date/Time: 10.12.2012 10:05:32

HAC-RF

DUT: Sony; Type: PM-0280-BV; Serial: CB5A1MAPY5

Communication System: Generic GSM; Frequency: 848.6 MHz; Duty Cycle: 1:8.30042

Medium parameters used: $\sigma = 0$ mho/m, $\epsilon_r = 1$; $\rho = 0$ kg/m³

Phantom section: TCoil Section

DASY5 Configuration:

- Probe: H3DV6 - SN6086; ; Calibrated: 14.01.2012
- Sensor-Surface: (Fix Surface)
- Electronics: DAE3 Sn477; Calibrated: 09.05.2012
- Phantom: HAC Test Arch with AMCC; Type: SD HAC P01 BA; Serial: 1007+1022
- Measurement SW: DASY52 52.8.2(969); Postprocessing SW: SEMCAD X 14.6.6(6824)

Device H-Field measurement GSM 850/H Scan - H3DV6: 15 mm from Probe Center to the Device High/Hearing Aid Compatibility Test (101x101x1):

Interpolated grid: dx=0.5000 mm, dy=0.5000 mm

Device Reference Point: 0, 0, -6.3 mm

Reference Value = 0.05500 A/m; Power Drift = 0.00 dB

PMR not calibrated. PMF = 2.860 is applied.

H-field emissions = 0.3207 A/m

Near-field category: M4 (AWF -5 dB)

PMF scaled H-field

Grid 1 M4 0.321 A/m	Grid 2 M4 0.225 A/m	Grid 3 M4 0.145 A/m
Grid 4 M4 0.295 A/m	Grid 5 M4 0.206 A/m	Grid 6 M4 0.129 A/m
Grid 7 M4 0.314 A/m	Grid 8 M4 0.207 A/m	Grid 9 M4 0.118 A/m

Category	AWF (dB)	Limits for E-Field Emissions (V/m) < 960MHz	Limits for H-Field Emissions (A/m) < 960 MHz
M1	0	631 - 1122	1.91 - 3.39
	-5	473.2 - 841.4	1.43 - 2.54
M2	0	354.8 - 631	1.07 - 1.91
	-5	266.1 - 473.2	0.8 - 1.43
M3	0	199.5 - 354.8	0.6 - 1.07
	-5	149.6 - 266.1	0.45 - 0.8
M4	0	<199.5	<0.6
	-5	<149.6	<0.45

Cursor:

Total = 0.3207 A/m

H Category: M4

Location: 25, -25, 8.7 mm

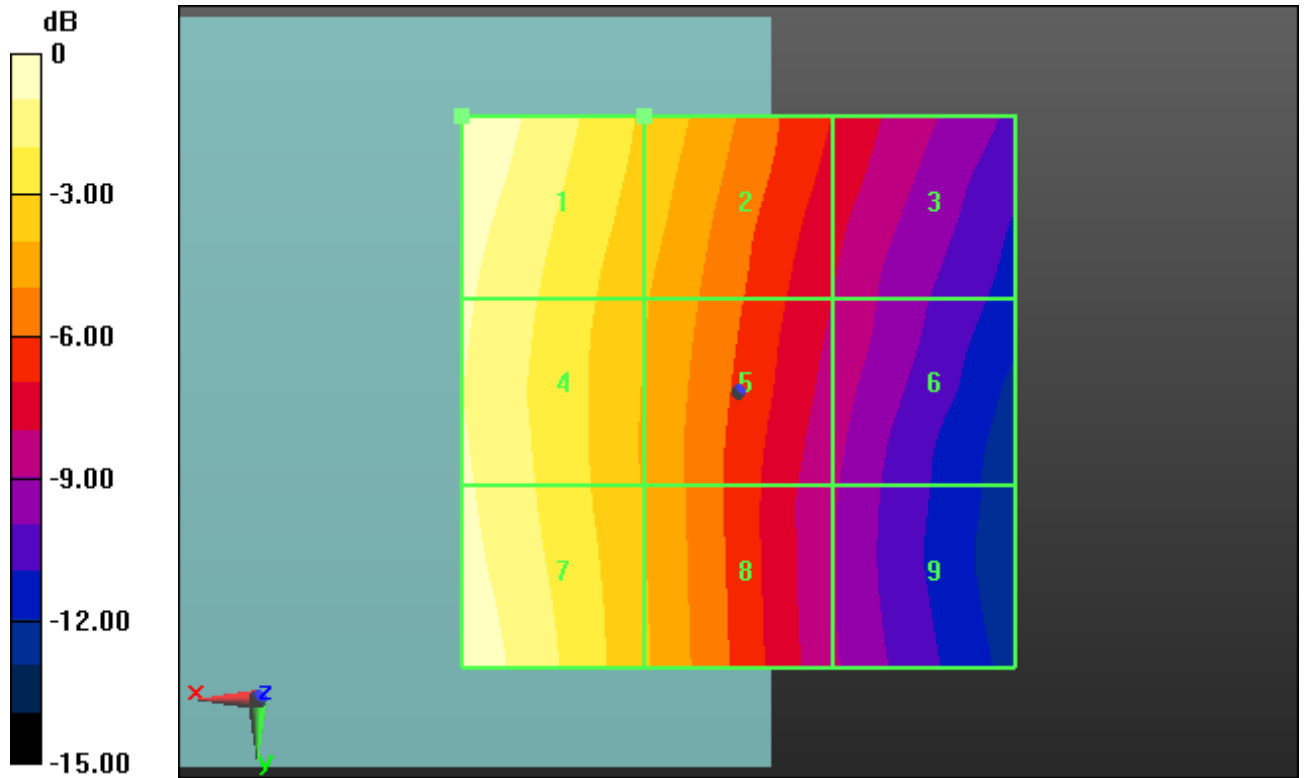

0 dB = 0.3231 A/m = -9.81 dB A/m

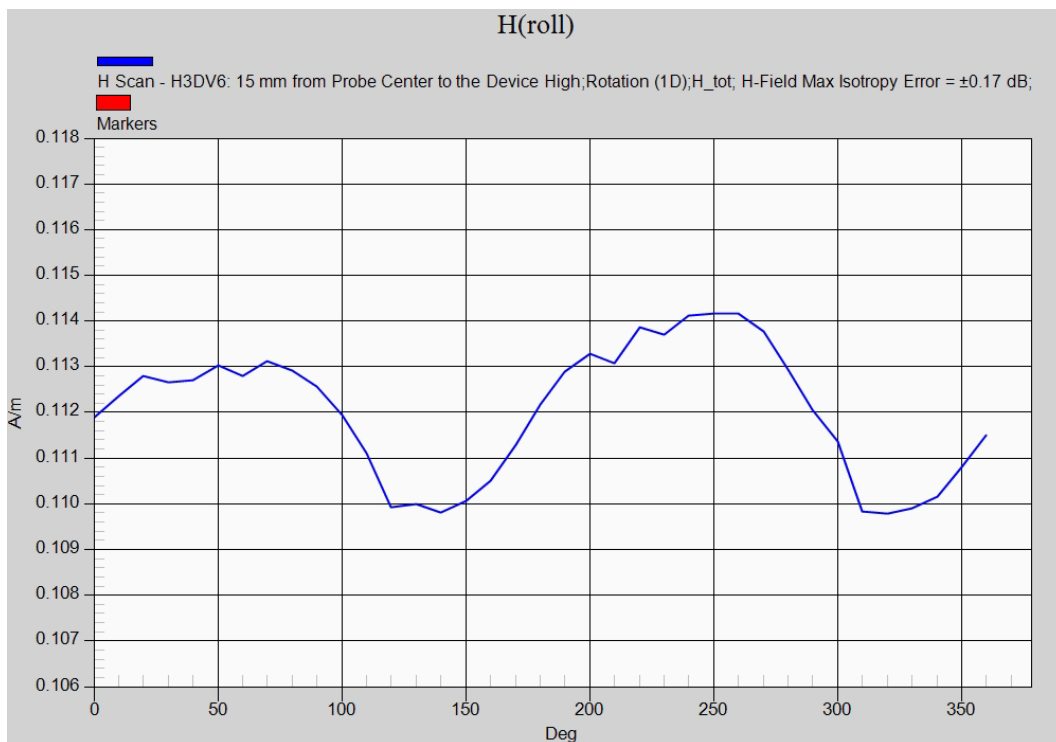

rot 0°	rot max.	percentage deviation	max. field strength (A/m)	worst case calculated (A/m)
0.112	0.114	1.75%	0.321	0.327

Annex B.2: GSM 1880MHz

Date/Time: 08.12.2012 14:33:59

HAC_GSM1880_E

DUT: Sony; Type: PM-0280-BV; Serial: CB5A1MAPY5

Communication System: Generic GSM; Frequency: 1850.2 MHz; Duty Cycle: 1:8.30042

Medium parameters used: $\sigma = 0$ mho/m, $\epsilon_r = 1$; $\rho = 0$ kg/m³

Phantom section: TCoil Section

DASY5 Configuration:

- Probe: ER3DV6 - SN2262; ConvF(1, 1, 1); Calibrated: 09.01.2012;
- Sensor-Surface: (Fix Surface)
- Electronics: DAE3 Sn477; Calibrated: 09.05.2012
- Phantom: HAC Test Arch with AMCC; Type: SD HAC P01 BA; Serial: 1007+1022
- Measurement SW: DASY52 52.8.2(969); Postprocessing SW: SEMCAD X 14.6.6(6824)

HAC GSM1900/E Scan - ER3D - 2007: 15 mm from Probe Center to the Device/Hearing Aid Compatibility Test (101x101x1): Interpolated grid: dx=0.5000 mm, dy=0.5000 mm

Device Reference Point: 0, 0, -6.3 mm

Reference Value = 10.25 V/m; Power Drift = -0.08 dB

PMR not calibrated. PMF = 2.970 is applied.

E-field emissions = 55.81 V/m

Near-field category: M3 (AWF -5 dB)

PMF scaled E-field

Grid 1 M4 45.25 V/m	Grid 2 M4 45.57 V/m	Grid 3 M4 40.21 V/m
Grid 4 M4 22.75 V/m	Grid 5 M4 32.64 V/m	Grid 6 M4 32.80 V/m
Grid 7 M3 47.77 V/m	Grid 8 M3 55.81 V/m	Grid 9 M3 53.74 V/m

Category	AWF (dB)	Limits for E-Field Emissions (V/m) > 960MHz	Limits for H-Field Emissions (A/m) > 960MHz
M1	0	199.5 - 354.8	0.6 - 1.07
	-5	149.6 - 266.1	0.45 - 0.8
M2	0	112.2 - 199.5	0.34 - 0.6
	-5	84.1 - 149.6	0.25 - 0.45
M3	0	63.1 - 112.2	0.19 - 0.34
	-5	47.3 - 84.1	0.14 - 0.25
M4	0	<63.1	<0.19
	-5	<47.3	<0.14

Cursor:

Total = 55.81 V/m

E Category: M3

Location: -2.5, 25, 8.7 mm

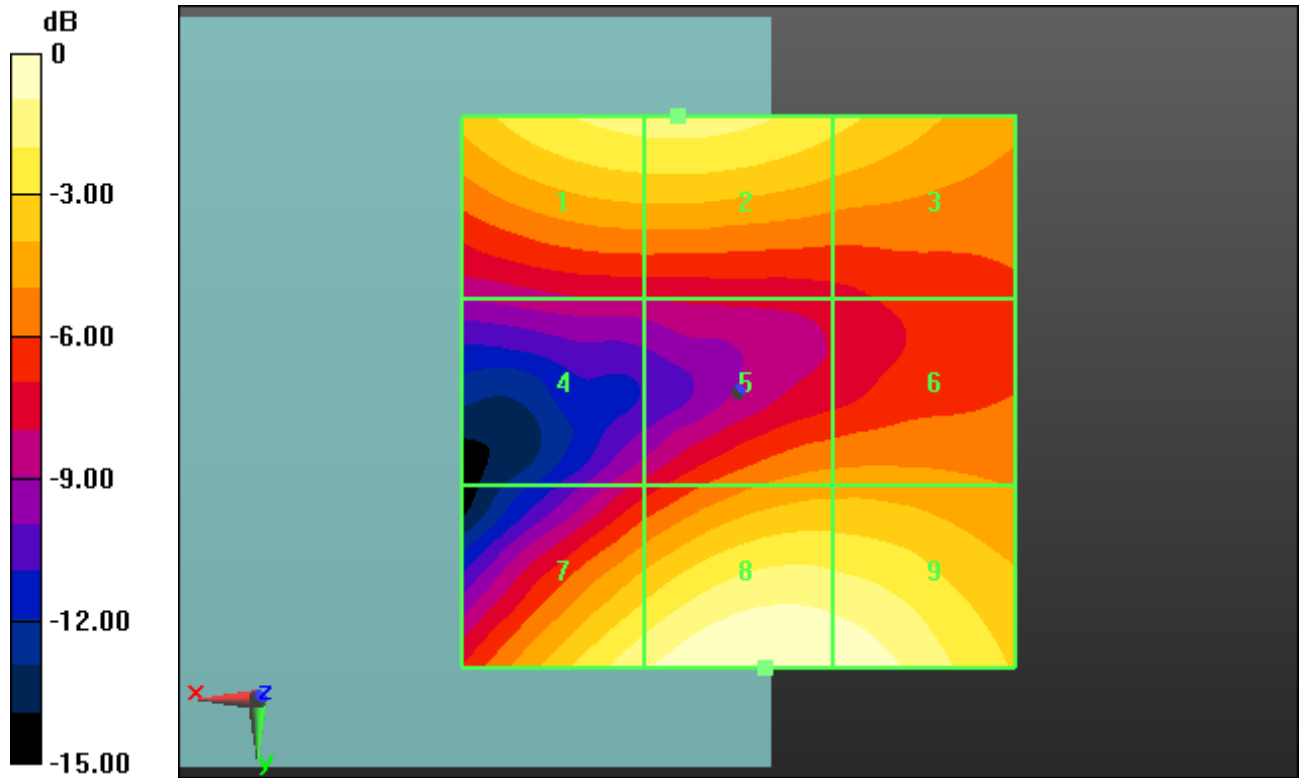

0 dB = 54.13 V/m = 34.67 dB V/m

Date/Time: 08.12.2012 14:39:09

HAC_GSM1880_E

DUT: Sony; Type: PM-0280-BV; Serial: CB5A1MAPY5

Communication System: Generic GSM; Frequency: 1880 MHz; Duty Cycle: 1:8.30042

Medium parameters used: $\sigma = 0$ mho/m, $\epsilon_r = 1$; $\rho = 0$ kg/m³

Phantom section: TCoil Section

DASY5 Configuration:

- Probe: ER3DV6 - SN2262; ConvF(1, 1, 1); Calibrated: 09.01.2012;
- Sensor-Surface: (Fix Surface)
- Electronics: DAE3 Sn477; Calibrated: 09.05.2012
- Phantom: HAC Test Arch with AMCC; Type: SD HAC P01 BA; Serial: 1007+1022
- Measurement SW: DASY52 52.8.2(969); Postprocessing SW: SEMCAD X 14.6.6(6824)

HAC GSM1900/E Scan - ER3D - 2007: 15 mm from Probe Center to the Device 2/Hearing Aid Compatibility Test (101x101x1): Interpolated grid: dx=0.5000 mm, dy=0.5000 mm

Device Reference Point: 0, 0, -6.3 mm

Reference Value = 9.797 V/m; Power Drift = -0.00 dB

PMR not calibrated. PMF = 2.970 is applied.

E-field emissions = 52.92 V/m

Near-field category: M3 (AWF -5 dB)

PMF scaled E-field

Grid 1 M4 41.27 V/m	Grid 2 M4 41.59 V/m	Grid 3 M4 37.90 V/m
Grid 4 M4 22.56 V/m	Grid 5 M4 32.87 V/m	Grid 6 M4 32.87 V/m
Grid 7 M4 44.97 V/m	Grid 8 M3 52.92 V/m	Grid 9 M3 50.94 V/m

Category	AWF (dB)	Limits for E-Field Emissions (V/m) > 960MHz	Limits for H-Field Emissions (A/m) > 960MHz
M1	0	199.5 - 354.8	0.6 - 1.07
	-5	149.6 - 266.1	0.45 - 0.8
M2	0	112.2 - 199.5	0.34 - 0.6
	-5	84.1 - 149.6	0.25 - 0.45
M3	0	63.1 - 112.2	0.19 - 0.34
	-5	47.3 - 84.1	0.14 - 0.25
M4	0	<63.1	<0.19
	-5	<47.3	<0.14

Cursor:

Total = 52.92 V/m

E Category: M3

Location: -3, 25, 8.7 mm

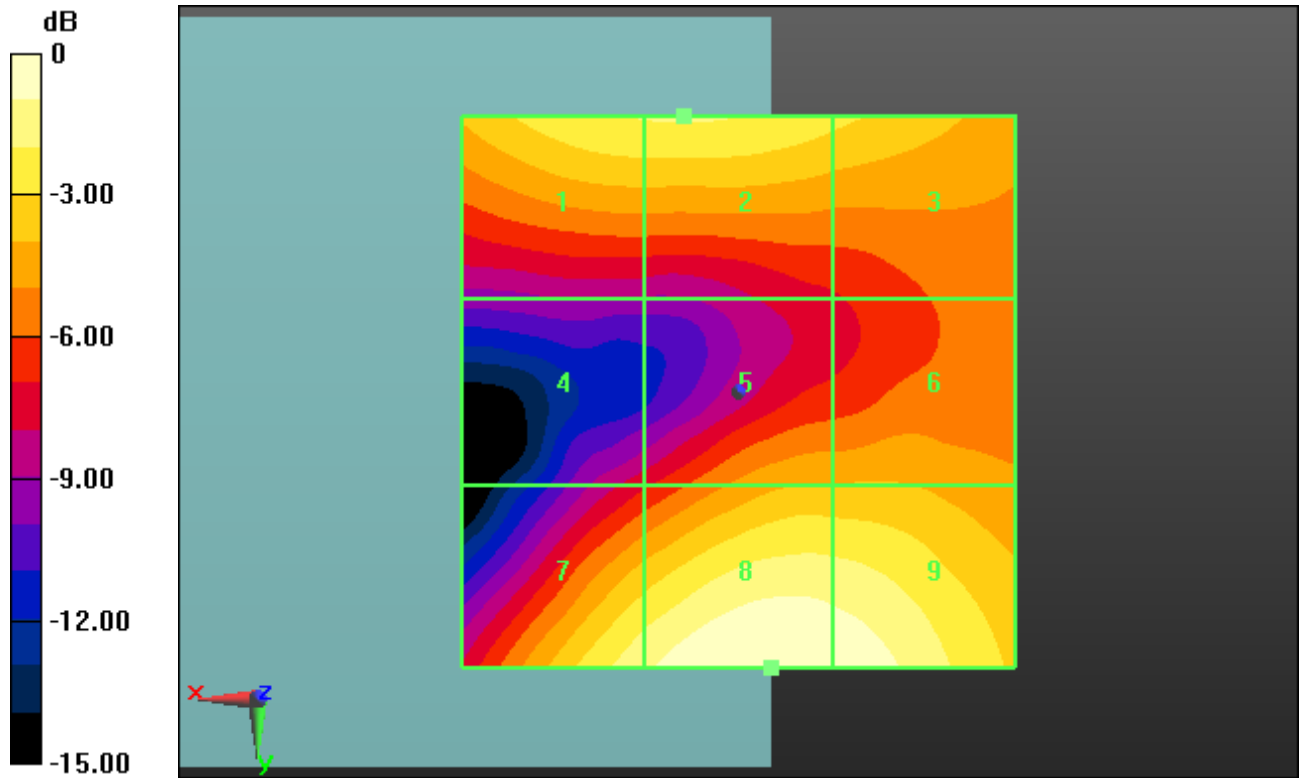

0 dB = 51.33 V/m = 34.21 dB V/m

Date/Time: 08.12.2012 14:44:16

HAC_GSM1880_E

DUT: Sony; Type: PM-0280-BV; Serial: CB5A1MAPY5

Communication System: Generic GSM; Frequency: 1909.8 MHz; Duty Cycle: 1:8.30042

Medium parameters used: $\sigma = 0$ mho/m, $\epsilon_r = 1$; $\rho = 0$ kg/m³

Phantom section: TCoil Section

DASY5 Configuration:

- Probe: ER3DV6 - SN2262; ConvF(1, 1, 1); Calibrated: 09.01.2012;
- Sensor-Surface: (Fix Surface)
- Electronics: DAE3 Sn477; Calibrated: 09.05.2012
- Phantom: HAC Test Arch with AMCC; Type: SD HAC P01 BA; Serial: 1007+1022
- Measurement SW: DASY52 52.8.2(969); Postprocessing SW: SEMCAD X 14.6.6(6824)

HAC GSM1900/E Scan - ER3D - 2007: 15 mm from Probe Center to the Device 3/Hearing Aid Compatibility Test (101x101x1): Interpolated grid: dx=0.5000 mm, dy=0.5000 mm

Device Reference Point: 0, 0, -6.3 mm

Reference Value = 10.45 V/m; Power Drift = -0.01 dB

PMR not calibrated. PMF = 2.970 is applied.

E-field emissions = 51.12 V/m

Near-field category: M3 (AWF -5 dB)

PMF scaled E-field

Grid 1 M4 44.97 V/m	Grid 2 M4 46.66 V/m	Grid 3 M4 43.29 V/m
Grid 4 M4 21.13 V/m	Grid 5 M4 30.06 V/m	Grid 6 M4 30.47 V/m
Grid 7 M4 41.78 V/m	Grid 8 M3 51.12 V/m	Grid 9 M3 50.05 V/m

Category	AWF (dB)	Limits for E-Field Emissions (V/m) > 960MHz	Limits for H-Field Emissions (A/m) > 960MHz
M1	0	199.5 - 354.8	0.6 - 1.07
	-5	149.6 - 266.1	0.45 - 0.8
M2	0	112.2 - 199.5	0.34 - 0.6
	-5	84.1 - 149.6	0.25 - 0.45
M3	0	63.1 - 112.2	0.19 - 0.34
	-5	47.3 - 84.1	0.14 - 0.25
M4	0	<63.1	<0.19
	-5	<47.3	<0.14

Cursor:

Total = 51.12 V/m

E Category: M3

Location: -4.5, 25, 8.7 mm

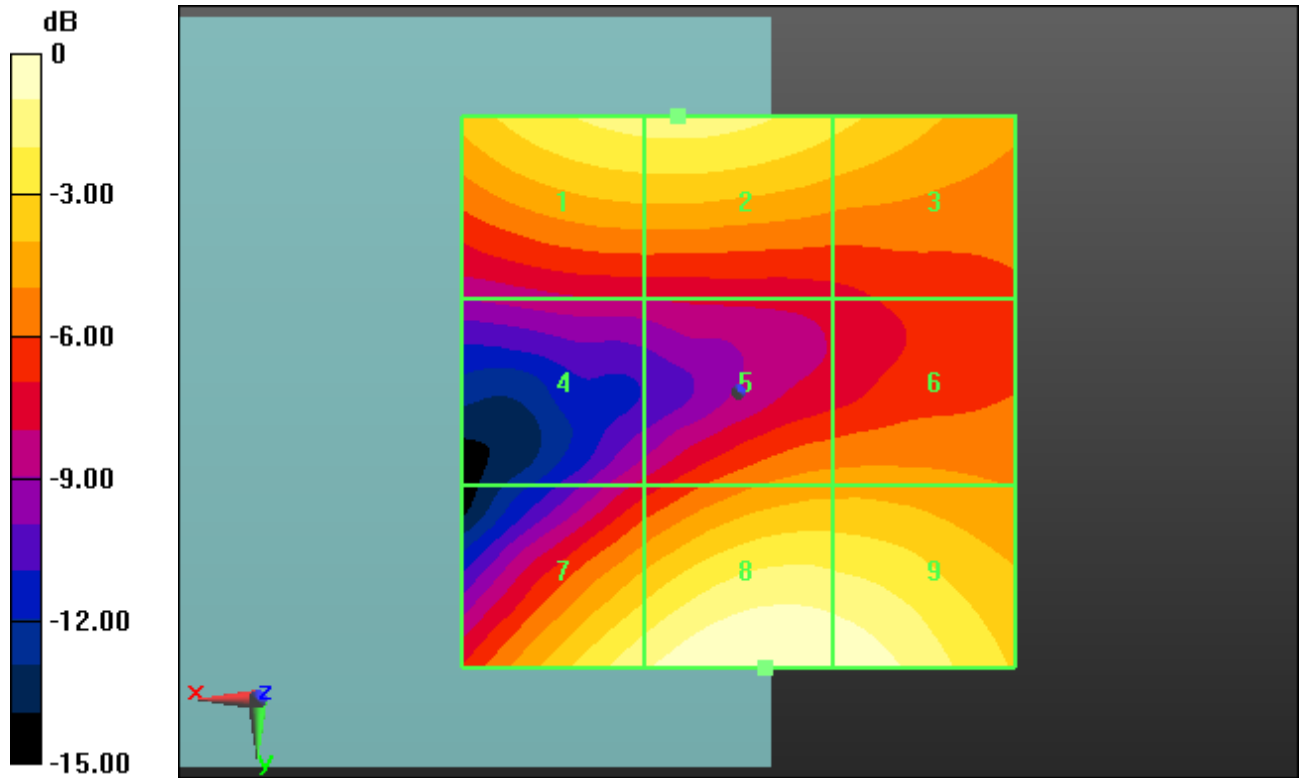

0 dB = 49.59 V/m = 33.91 dB V/m

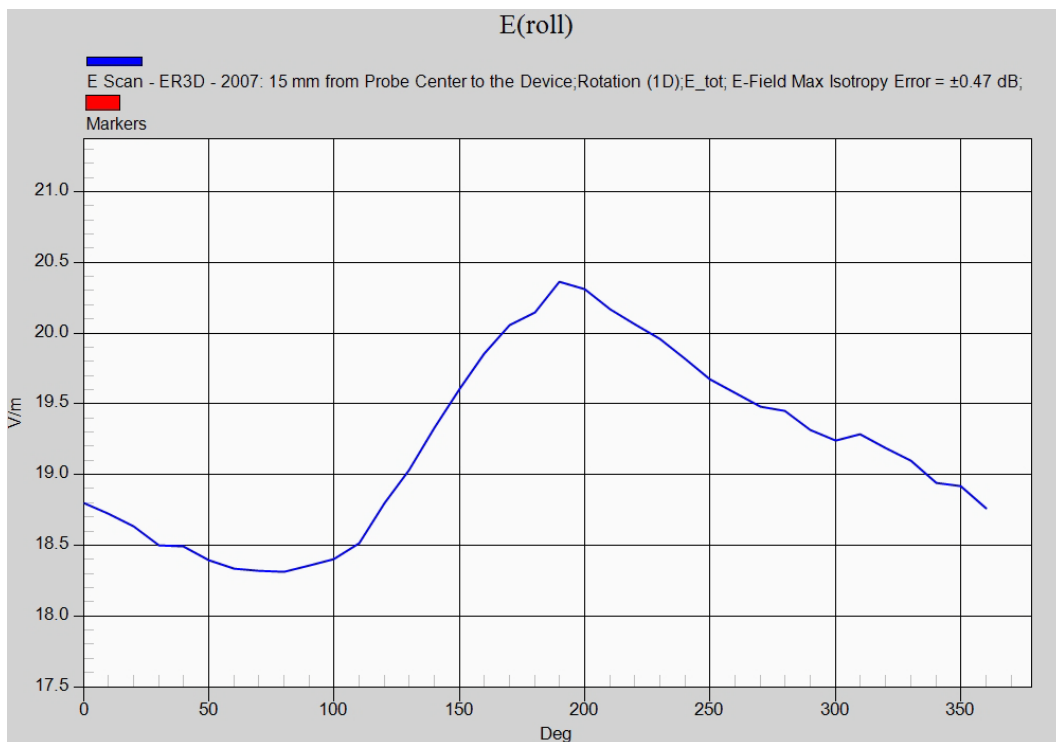

rot 0°	rot max.	percentage deviation	max. field strength (V/m)	worst case calculated (V/m)
18.8	20.3	7.39%	55.81	59.93

Date/Time: 10.12.2012 09:24:27

HAC-RF

DUT: Sony; Type: PM-0280-BV; Serial: CB5A1MAPY5

Communication System: Generic GSM; Frequency: 1850.2 MHz; Duty Cycle: 1:8.30042

Medium parameters used: $\sigma = 0$ mho/m, $\epsilon_r = 1$; $\rho = 0$ kg/m³

Phantom section: TCoil Section

DASY5 Configuration:

- Probe: H3DV6 - SN6086; ; Calibrated: 14.01.2012
- Sensor-Surface: (Fix Surface)
- Electronics: DAE3 Sn477; Calibrated: 09.05.2012
- Phantom: HAC Test Arch with AMCC; Type: SD HAC P01 BA; Serial: 1007+1022
- Measurement SW: DASY52 52.8.2(969); Postprocessing SW: SEMCAD X 14.6.6(6824)

Device H-Field measurement GSM 1900/H Scan - H3DV6: 15 mm from Probe Center to the Device Low/Hearing Aid Compatibility Test

(101x101x1): Interpolated grid: dx=0.5000 mm, dy=0.5000 mm

Device Reference Point: 0, 0, -6.3 mm

Reference Value = 0.05100 A/m; Power Drift = 0.027 dB

PMR not calibrated. PMF = 2.360 is applied.

H-field emissions = 0.1063 A/m

Near-field category: M4 (AWF -5 dB)

PMF scaled H-field

Grid 1 M4 0.085 A/m	Grid 2 M4 0.104 A/m	Grid 3 M4 0.104 A/m
Grid 4 M4 0.088 A/m	Grid 5 M4 0.106 A/m	Grid 6 M4 0.106 A/m
Grid 7 M4 0.089 A/m	Grid 8 M4 0.101 A/m	Grid 9 M4 0.100 A/m

Category	AWF (dB)	Limits for E-Field Emissions (V/m) > 960MHz	Limits for H-Field Emissions (A/m) > 960MHz
M1	0	199.5 - 354.8	0.6 - 1.07
	-5	149.6 - 266.1	0.45 - 0.8
M2	0	112.2 - 199.5	0.34 - 0.6
	-5	84.1 - 149.6	0.25 - 0.45
M3	0	63.1 - 112.2	0.19 - 0.34
	-5	47.3 - 84.1	0.14 - 0.25
M4	0	<63.1	<0.19
	-5	<47.3	<0.14

Cursor:

Total = 0.1063 A/m

H Category: M4

Location: -6.5, -1.5, 8.7 mm

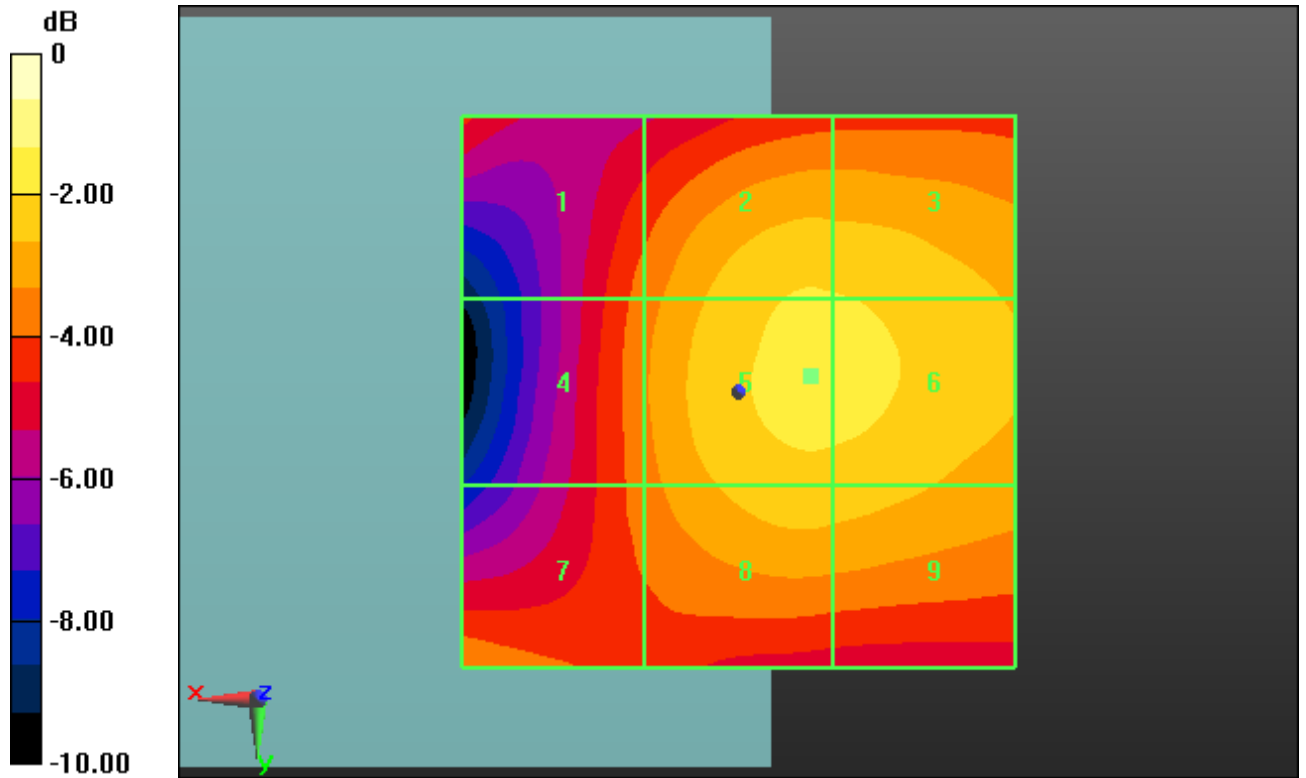

0 dB = 0.1298 A/m = -17.73 dB A/m

Date/Time: 10.12.2012 09:29:39

HAC-RF

DUT: Sony; Type: PM-0280-BV; Serial: CB5A1MAPY5

Communication System: Generic GSM; Frequency: 1880 MHz; Duty Cycle: 1:8.30042

Medium parameters used: $\sigma = 0$ mho/m, $\epsilon_r = 1$; $\rho = 0$ kg/m³

Phantom section: TCoil Section

DASY5 Configuration:

- Probe: H3DV6 - SN6086; ; Calibrated: 14.01.2012
- Sensor-Surface: (Fix Surface)
- Electronics: DAE3 Sn477; Calibrated: 09.05.2012
- Phantom: HAC Test Arch with AMCC; Type: SD HAC P01 BA; Serial: 1007+1022
- Measurement SW: DASY52 52.8.2(969); Postprocessing SW: SEMCAD X 14.6.6(6824)

Device H-Field measurement GSM 1900/H Scan - H3DV6: 15 mm from Probe Center to the Device Middle/Hearing Aid Compatibility Test

(101x101x1): Interpolated grid: dx=0.5000 mm, dy=0.5000 mm

Device Reference Point: 0, 0, -6.3 mm

Reference Value = 0.05500 A/m; Power Drift = 0.09 dB

PMR not calibrated. PMF = 2.360 is applied.

H-field emissions = 0.1101 A/m

Near-field category: M4 (AWF -5 dB)

PMF scaled H-field

Grid 1 M4 0.099 A/m	Grid 2 M4 0.109 A/m	Grid 3 M4 0.106 A/m
Grid 4 M4 0.099 A/m	Grid 5 M4 0.110 A/m	Grid 6 M4 0.107 A/m
Grid 7 M4 0.093 A/m	Grid 8 M4 0.102 A/m	Grid 9 M4 0.099 A/m

Category	AWF (dB)	Limits for E-Field Emissions (V/m) > 960MHz	Limits for H-Field Emissions (A/m) > 960MHz
M1	0	199.5 - 354.8	0.6 - 1.07
	-5	149.6 - 266.1	0.45 - 0.8
M2	0	112.2 - 199.5	0.34 - 0.6
	-5	84.1 - 149.6	0.25 - 0.45
M3	0	63.1 - 112.2	0.19 - 0.34
	-5	47.3 - 84.1	0.14 - 0.25
M4	0	<63.1	<0.19
	-5	<47.3	<0.14

Cursor:

Total = 0.1101 A/m

H Category: M4

Location: -1.5, -4.5, 8.7 mm

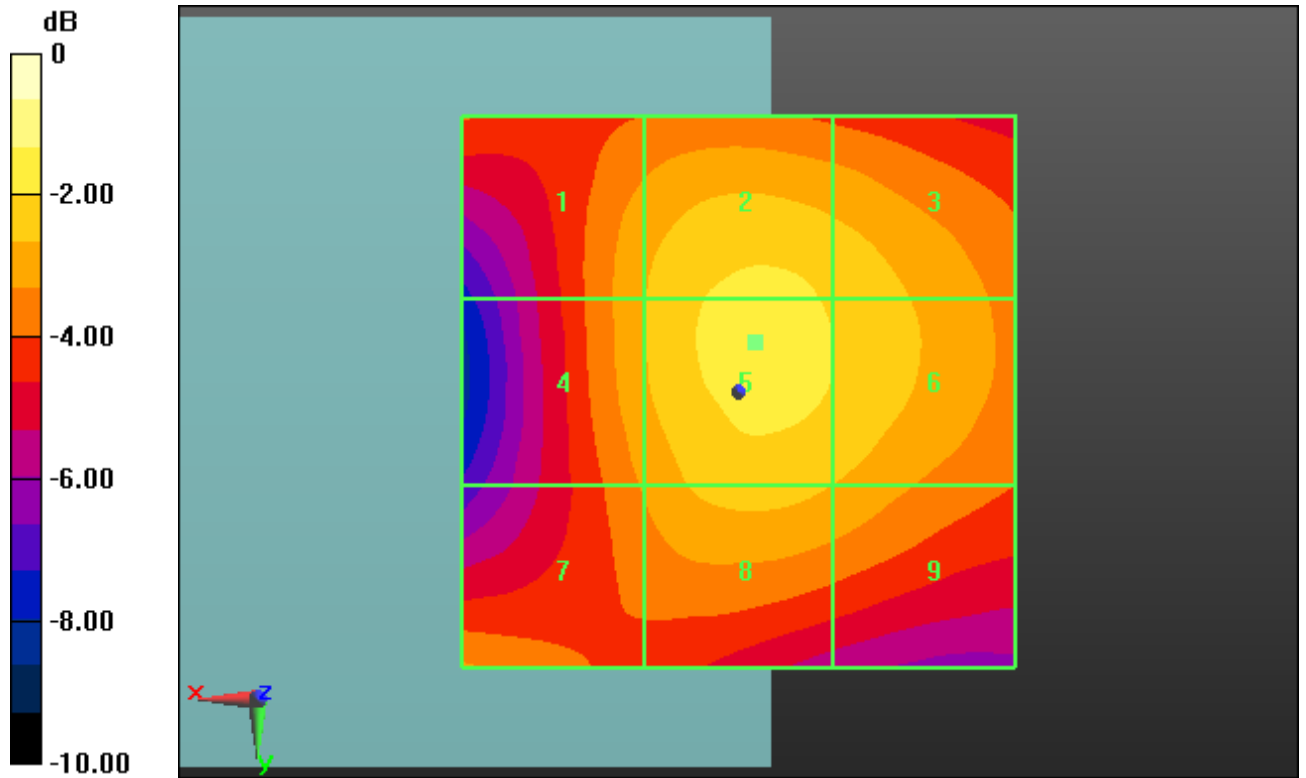

0 dB = 0.1345 A/m = -17.43 dB A/m

Date/Time: 10.12.2012 09:35:33

HAC-RF

DUT: Sony; Type: PM-0280-BV; Serial: CB5A1MAPY5

Communication System: Generic GSM; Frequency: 1909.8 MHz; Duty Cycle: 1:8.30042

Medium parameters used: $\sigma = 0$ mho/m, $\epsilon_r = 1$; $\rho = 0$ kg/m³

Phantom section: TCoil Section

DASY5 Configuration:

- Probe: H3DV6 - SN6086; ; Calibrated: 14.01.2012
- Sensor-Surface: (Fix Surface)
- Electronics: DAE3 Sn477; Calibrated: 09.05.2012
- Phantom: HAC Test Arch with AMCC; Type: SD HAC P01 BA; Serial: 1007+1022
- Measurement SW: DASY52 52.8.2(969); Postprocessing SW: SEMCAD X 14.6.6(6824)

Device H-Field measurement GSM 1900/H Scan - H3DV6: 15 mm from Probe Center to the Device High/Hearing Aid Compatibility Test

(101x101x1): Interpolated grid: dx=0.5000 mm, dy=0.5000 mm

Device Reference Point: 0, 0, -6.3 mm

Reference Value = 0.05400 A/m; Power Drift = 0.05 dB

PMR not calibrated. PMF = 2.360 is applied.

H-field emissions = 0.1066 A/m

Near-field category: M4 (AWF -5 dB)

PMF scaled H-field

Grid 1 M4 0.094 A/m	Grid 2 M4 0.104 A/m	Grid 3 M4 0.102 A/m
Grid 4 M4 0.094 A/m	Grid 5 M4 0.107 A/m	Grid 6 M4 0.105 A/m
Grid 7 M4 0.088 A/m	Grid 8 M4 0.100 A/m	Grid 9 M4 0.098 A/m

Category	AWF (dB)	Limits for E-Field Emissions (V/m) > 960MHz	Limits for H-Field Emissions (A/m) > 960MHz
M1	0	199.5 - 354.8	0.6 - 1.07
	-5	149.6 - 266.1	0.45 - 0.8
M2	0	112.2 - 199.5	0.34 - 0.6
	-5	84.1 - 149.6	0.25 - 0.45
M3	0	63.1 - 112.2	0.19 - 0.34
	-5	47.3 - 84.1	0.14 - 0.25
M4	0	<63.1	<0.19
	-5	<47.3	<0.14

Cursor:

Total = 0.1066 A/m

H Category: M4

Location: -3.5, -2.5, 8.7 mm

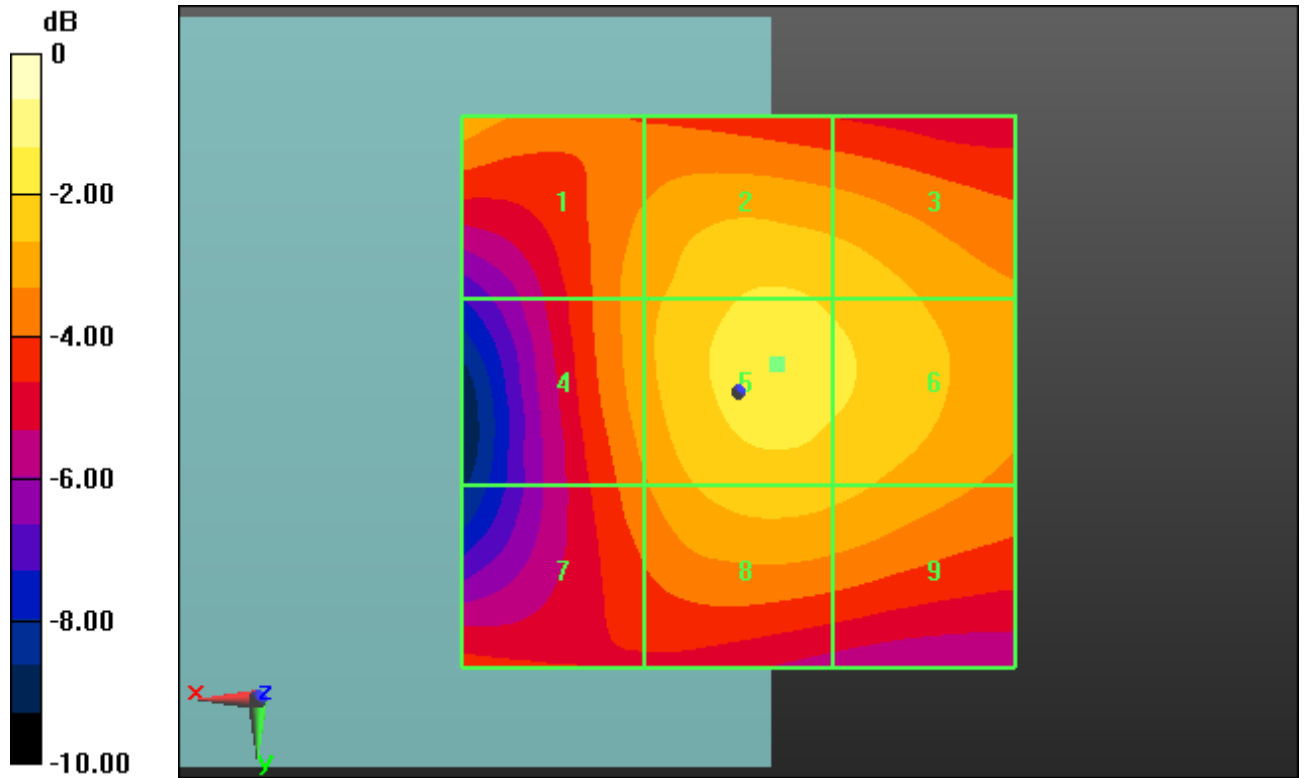

0 dB = 0.1301 A/m = -17.71 dB A/m

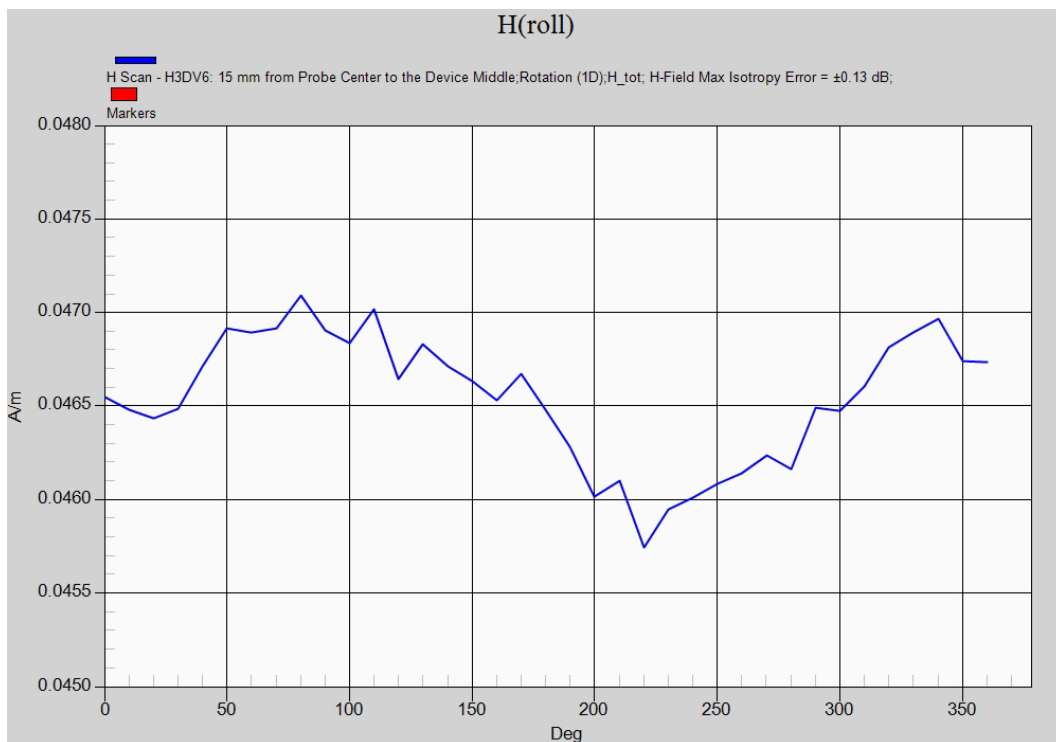

rot 0°	rot max.	percentage deviation	max. field strength (A/m)	worst case calculated (A/m)
0.0465	0.0471	1.27%	0.110	0.111

Annex B.3: WCDMA FDD V 835MHz

Date/Time: 08.12.2012 15:17:42

HAC_E

DUT: Sony; Type: PM-0280-BV; Serial: CB5A1MAPY5

Communication System: WCDMA FDD V; Frequency: 826.4 MHz; Duty Cycle: 1:1

Medium parameters used: $\sigma = 0$ mho/m, $\epsilon_r = 1$; $\rho = 0$ kg/m³

Phantom section: TCoil Section

DASY5 Configuration:

- Probe: ER3DV6 - SN2262; ConvF(1, 1, 1); Calibrated: 09.01.2012;
- Sensor-Surface: (Fix Surface)
- Electronics: DAE3 Sn477; Calibrated: 09.05.2012
- Phantom: HAC Test Arch with AMCC; Type: SD HAC P01 BA; Serial: 1007+1022
- Measurement SW: DASY52 52.8.2(969); Postprocessing SW: SEMCAD X 14.6.6(6824)

HAC WCDMA FDD V/E Scan - ER3D - 2007: 15 mm from Probe Center to the Device low/Hearing Aid Compatibility Test (101x101x1): Interpolated grid:

dx=0.5000 mm, dy=0.5000 mm

Device Reference Point: 0, 0, -6.3 mm

Reference Value = 34.39 V/m; Power Drift = 0.04 dB

PMR not calibrated. PMF = 1.000 is applied.

E-field emissions = 63.93 V/m

Near-field category: M4 (AWF 0 dB)

PMF scaled E-field

Grid 1 M4 52.79 V/m	Grid 2 M4 58.60 V/m	Grid 3 M4 56.73 V/m
Grid 4 M4 57.90 V/m	Grid 5 M4 61.89 V/m	Grid 6 M4 58.44 V/m
Grid 7 M4 61.51 V/m	Grid 8 M4 63.93 V/m	Grid 9 M4 58.59 V/m

Cursor:

Total = 63.93 V/m

E Category: M4

Location: 1.5, 25, 8.7 mm

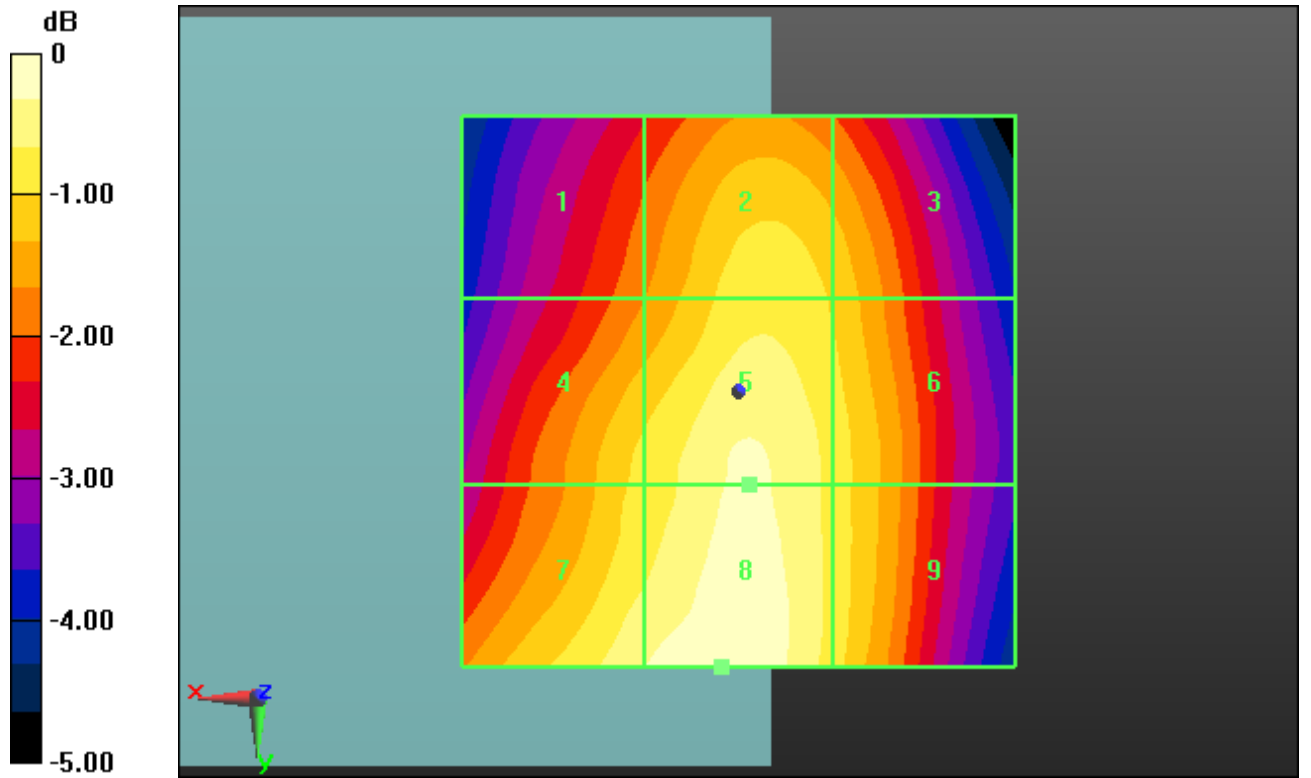

Date/Time: 08.12.2012 15:26:17

HAC_E

DUT: Sony; Type: PM-0280-BV; Serial: CB5A1MAPY5

Communication System: WCDMA FDD V; Frequency: 836.4 MHz; Duty Cycle: 1:1

Medium parameters used: $\sigma = 0$ mho/m, $\epsilon_r = 1$; $\rho = 0$ kg/m³

Phantom section: TCoil Section

DASY5 Configuration:

- Probe: ER3DV6 - SN2262; ConvF(1, 1, 1); Calibrated: 09.01.2012;
- Sensor-Surface: (Fix Surface)
- Electronics: DAE3 Sn477; Calibrated: 09.05.2012
- Phantom: HAC Test Arch with AMCC; Type: SD HAC P01 BA; Serial: 1007+1022
- Measurement SW: DASY52 52.8.2(969); Postprocessing SW: SEMCAD X 14.6.6(6824)

HAC WCDMA FDD V/E Scan - ER3D - 2007: 15 mm from Probe Center to the Device middle/Hearing Aid Compatibility Test (101x101x1): Interpolated grid:

dx=0.5000 mm, dy=0.5000 mm

Device Reference Point: 0, 0, -6.3 mm

Reference Value = 29.24 V/m; Power Drift = 0.00 dB

PMR not calibrated. PMF = 1.000 is applied.

E-field emissions = 59.56 V/m

Near-field category: M4 (AWF 0 dB)

PMF scaled E-field

Grid 1 M4 48.16 V/m	Grid 2 M4 51.37 V/m	Grid 3 M4 49.10 V/m
Grid 4 M4 53.83 V/m	Grid 5 M4 56.97 V/m	Grid 6 M4 52.97 V/m
Grid 7 M4 57.53 V/m	Grid 8 M4 59.56 V/m	Grid 9 M4 53.84 V/m

Cursor:

Total = 59.56 V/m

E Category: M4

Location: 2, 25, 8.7 mm

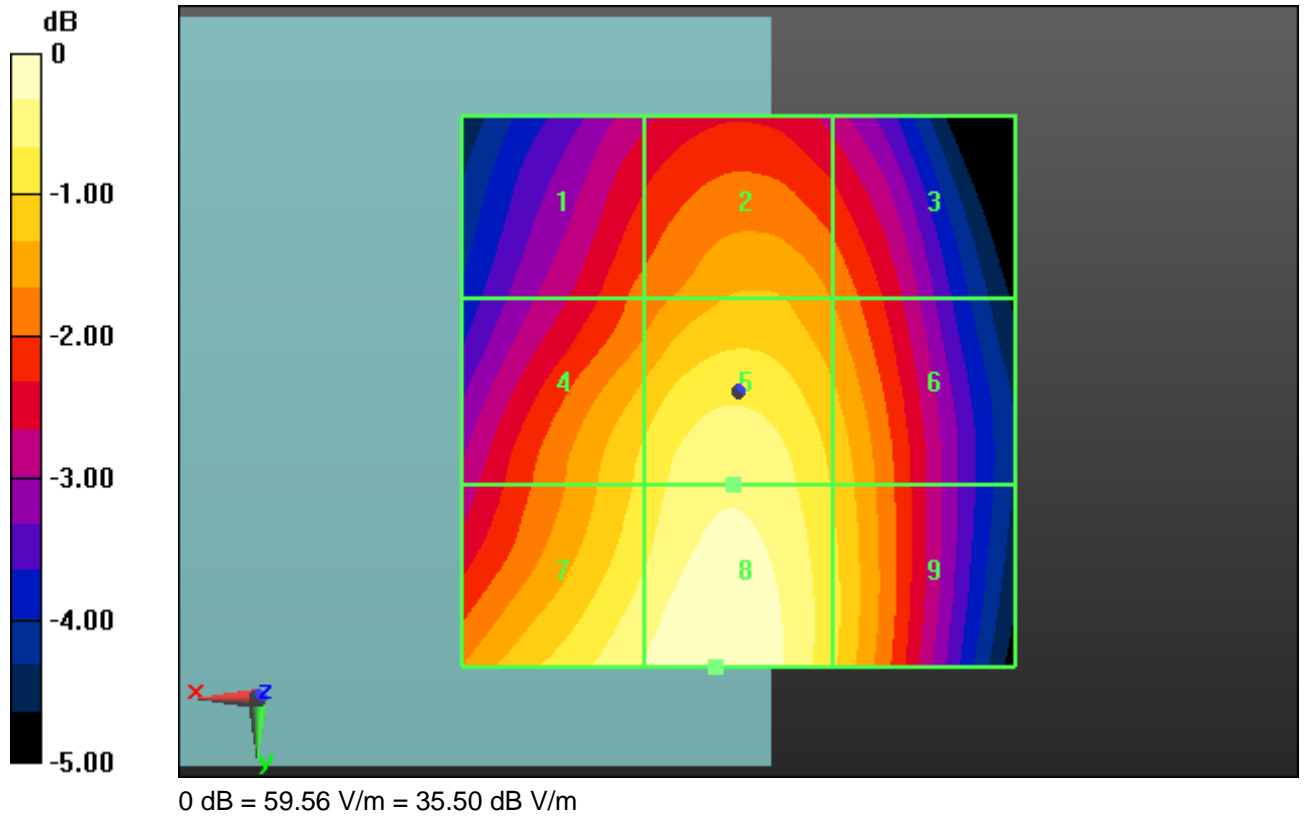

Date/Time: 08.12.2012 15:31:52

HAC_E

DUT: Sony; Type: PM-0280-BV; Serial: CB5A1MAPY5

Communication System: WCDMA FDD V; Frequency: 846.6 MHz; Duty Cycle: 1:1

Medium parameters used: $\sigma = 0$ mho/m, $\epsilon_r = 1$; $\rho = 0$ kg/m³

Phantom section: TCoil Section

DASY5 Configuration:

- Probe: ER3DV6 - SN2262; ConvF(1, 1, 1); Calibrated: 09.01.2012;
- Sensor-Surface: (Fix Surface)
- Electronics: DAE3 Sn477; Calibrated: 09.05.2012
- Phantom: HAC Test Arch with AMCC; Type: SD HAC P01 BA; Serial: 1007+1022
- Measurement SW: DASY52 52.8.2(969); Postprocessing SW: SEMCAD X 14.6.6(6824)

HAC WCDMA FDD V/E Scan - ER3D - 2007: 15 mm from Probe Center to the Device high/Hearing Aid Compatibility Test (101x101x1): Interpolated grid:

dx=0.5000 mm, dy=0.5000 mm

Device Reference Point: 0, 0, -6.3 mm

Reference Value = 32.14 V/m; Power Drift = 0.04 dB

PMR not calibrated. PMF = 1.000 is applied.

E-field emissions = 70.91 V/m

Near-field category: M4 (AWF 0 dB)

PMF scaled E-field

Grid 1 M4 55.41 V/m	Grid 2 M4 57.99 V/m	Grid 3 M4 54.37 V/m
Grid 4 M4 63.77 V/m	Grid 5 M4 67.11 V/m	Grid 6 M4 62.32 V/m
Grid 7 M4 68.78 V/m	Grid 8 M4 70.91 V/m	Grid 9 M4 64.26 V/m

Cursor:

Total = 70.91 V/m

E Category: M4

Location: 2, 25, 8.7 mm

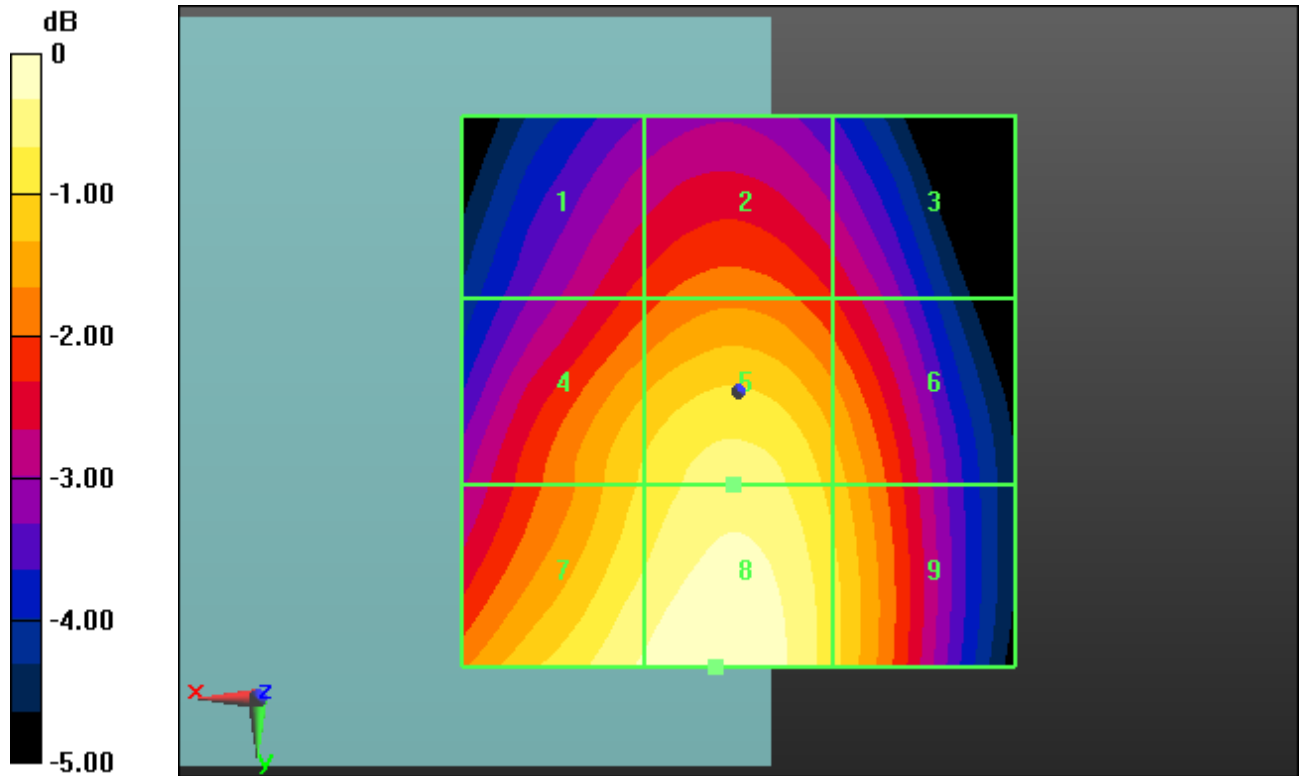

0 dB = 70.91 V/m = 37.01 dB V/m

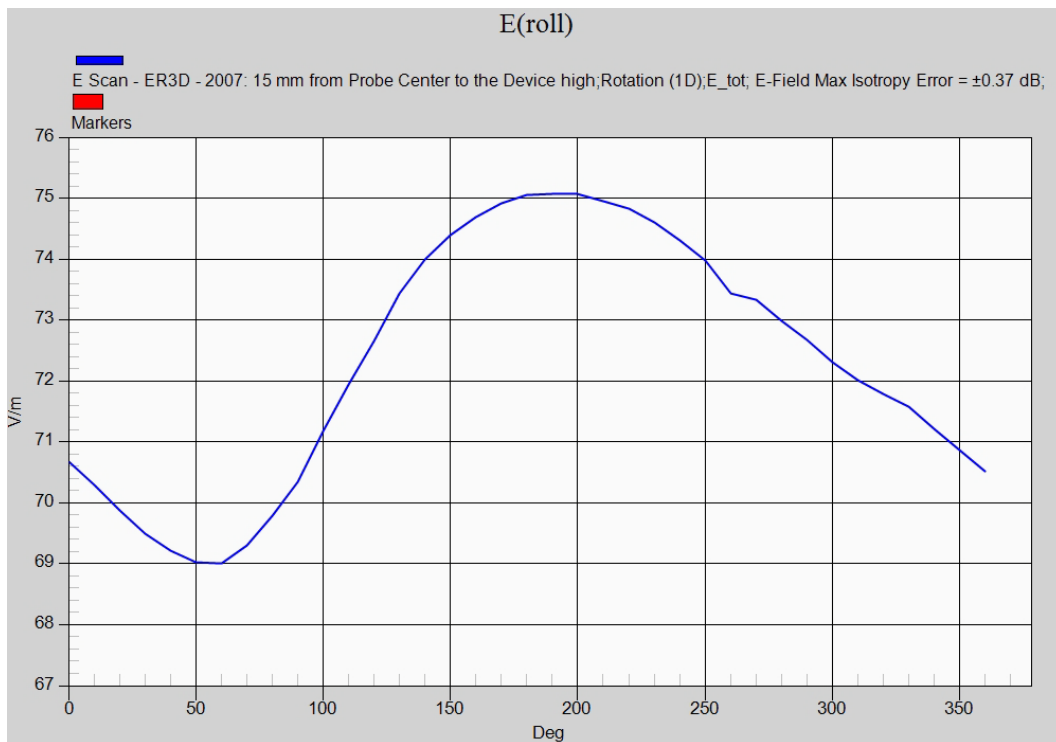

rot 0°	rot max.	percentage deviation	max. field strength (V/m)	worst case calculated (V/m)
70.6	75.1	5.99%	70.91	75.16

Date/Time: 10.12.2012 09:07:06

HAC-RF

DUT: Sony; Type: PM-0280-BV; Serial: CB5A1MAPY5

Communication System: WCDMA FDD V; Frequency: 826.4 MHz; Duty Cycle: 1:1

Medium parameters used: $\sigma = 0$ mho/m, $\epsilon_r = 1$; $\rho = 0$ kg/m³

Phantom section: TCoil Section

DASY5 Configuration:

- Probe: H3DV6 - SN6086; ; Calibrated: 14.01.2012
- Sensor-Surface: (Fix Surface)
- Electronics: DAE3 Sn477; Calibrated: 09.05.2012
- Phantom: HAC Test Arch with AMCC; Type: SD HAC P01 BA; Serial: 1007+1022
- Measurement SW: DASY52 52.8.2(969); Postprocessing SW: SEMCAD X 14.6.6(6824)

Device H-Field measurement WCDMA FDD V/H Scan - H3DV6: 15 mm from Probe Center to the Device Low/Hearing Aid Compatibility Test

(101x101x1): Interpolated grid: dx=0.5000 mm, dy=0.5000 mm

Device Reference Point: 0, 0, -6.3 mm

Reference Value = 0.05200 A/m; Power Drift = 0.00 dB

PMR not calibrated. PMF = 1.000 is applied.

H-field emissions = 0.1184 A/m

Near-field category: M4 (AWF 0 dB)

PMF scaled H-field

Grid 1 M4 0.118 A/m	Grid 2 M4 0.085 A/m	Grid 3 M4 0.053 A/m
Grid 4 M4 0.104 A/m	Grid 5 M4 0.073 A/m	Grid 6 M4 0.044 A/m
Grid 7 M4 0.104 A/m	Grid 8 M4 0.067 A/m	Grid 9 M4 0.036 A/m

Cursor:

Total = 0.1184 A/m

H Category: M4

Location: 25, -25, 8.7 mm

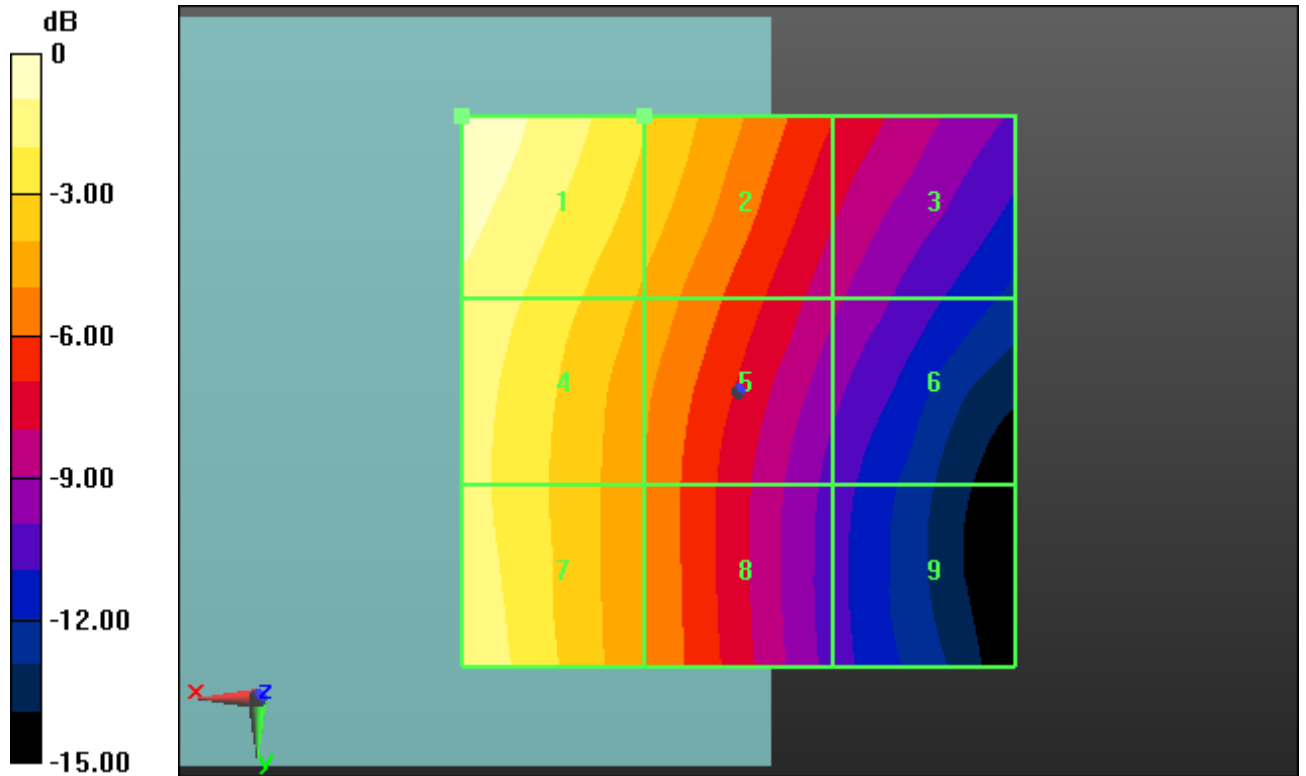

0 dB = 0.1184 A/m = -18.53 dB A/m

Date/Time: 10.12.2012 09:12:11

HAC-RF

DUT: Sony; Type: PM-0280-BV; Serial: CB5A1MAPY5

Communication System: WCDMA FDD V; Frequency: 836.4 MHz; Duty Cycle: 1:1

Medium parameters used: $\sigma = 0$ mho/m, $\epsilon_r = 1$; $\rho = 0$ kg/m³

Phantom section: TCoil Section

DASY5 Configuration:

- Probe: H3DV6 - SN6086; ; Calibrated: 14.01.2012
- Sensor-Surface: (Fix Surface)
- Electronics: DAE3 Sn477; Calibrated: 09.05.2012
- Phantom: HAC Test Arch with AMCC; Type: SD HAC P01 BA; Serial: 1007+1022
- Measurement SW: DASY52 52.8.2(969); Postprocessing SW: SEMCAD X 14.6.6(6824)

Device H-Field measurement WCDMA FDD V/H Scan - H3DV6: 15 mm from Probe Center to the Device Middle/Hearing Aid Compatibility Test

(101x101x1): Interpolated grid: dx=0.5000 mm, dy=0.5000 mm

Device Reference Point: 0, 0, -6.3 mm

Reference Value = 0.05900 A/m; Power Drift = -0.01 dB

PMR not calibrated. PMF = 1.000 is applied.

H-field emissions = 0.1059 A/m

Near-field category: M4 (AWF 0 dB)

PMF scaled H-field

Grid 1 M4 0.106 A/m	Grid 2 M4 0.079 A/m	Grid 3 M4 0.048 A/m
Grid 4 M4 0.098 A/m	Grid 5 M4 0.077 A/m	Grid 6 M4 0.045 A/m
Grid 7 M4 0.099 A/m	Grid 8 M4 0.068 A/m	Grid 9 M4 0.038 A/m

Cursor:

Total = 0.1059 A/m

H Category: M4

Location: 25, -25, 8.7 mm

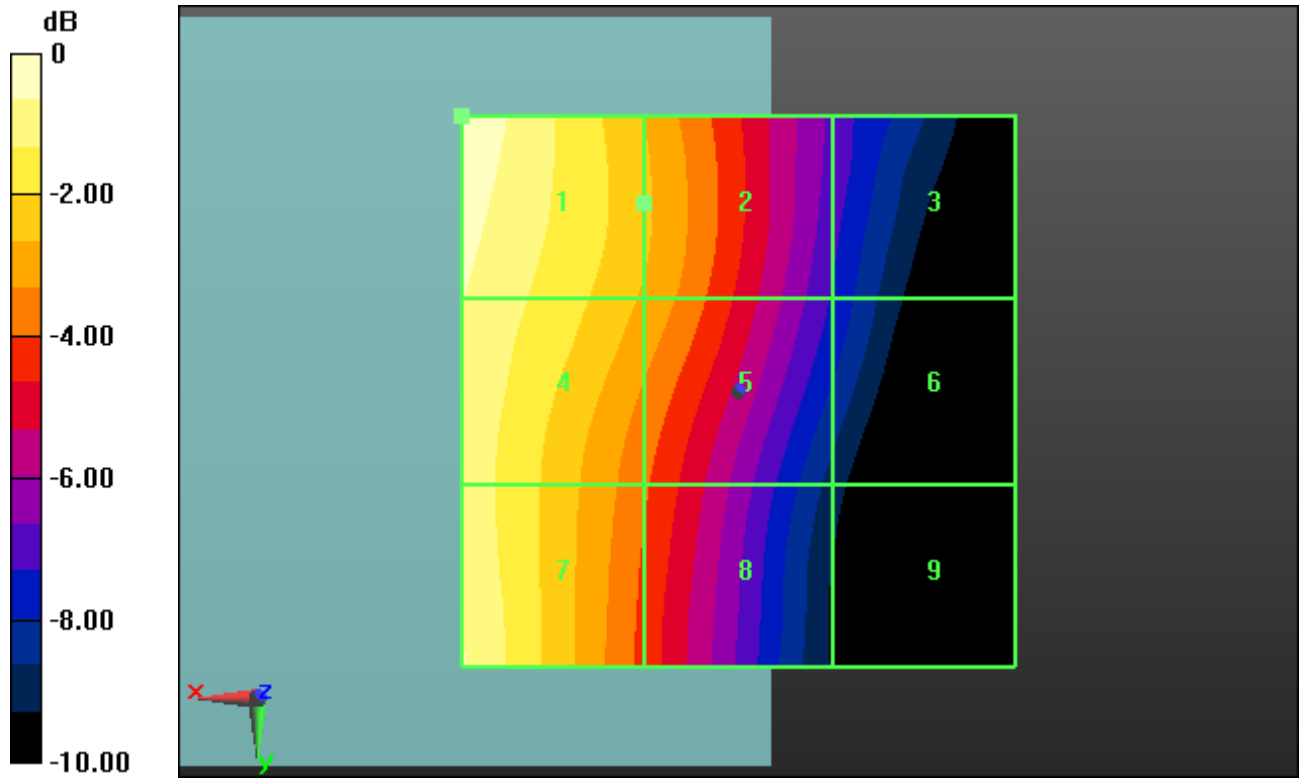

0 dB = 0.1059 A/m = -19.50 dB A/m

Date/Time: 10.12.2012 09:17:18

HAC-RF

DUT: Sony; Type: PM-0280-BV; Serial: CB5A1MAPY5

Communication System: WCDMA FDD V; Frequency: 846.6 MHz; Duty Cycle: 1:1

Medium parameters used: $\sigma = 0$ mho/m, $\epsilon_r = 1$; $\rho = 0$ kg/m³

Phantom section: TCoil Section

DASY5 Configuration:

- Probe: H3DV6 - SN6086; ; Calibrated: 14.01.2012
- Sensor-Surface: (Fix Surface)
- Electronics: DAE3 Sn477; Calibrated: 09.05.2012
- Phantom: HAC Test Arch with AMCC; Type: SD HAC P01 BA; Serial: 1007+1022
- Measurement SW: DASY52 52.8.2(969); Postprocessing SW: SEMCAD X 14.6.6(6824)

Device H-Field measurement WCDMA FDD V/H Scan - H3DV6: 15 mm from Probe Center to the Device High/Hearing Aid Compatibility Test

(101x101x1): Interpolated grid: dx=0.5000 mm, dy=0.5000 mm

Device Reference Point: 0, 0, -6.3 mm

Reference Value = 0.07400 A/m; Power Drift = 0.07 dB

PMR not calibrated. PMF = 1.000 is applied.

H-field emissions = 0.1182 A/m

Near-field category: M4 (AWF 0 dB)

PMF scaled H-field

Grid 1 M4 0.118 A/m	Grid 2 M4 0.094 A/m	Grid 3 M4 0.058 A/m
Grid 4 M4 0.114 A/m	Grid 5 M4 0.093 A/m	Grid 6 M4 0.057 A/m
Grid 7 M4 0.116 A/m	Grid 8 M4 0.083 A/m	Grid 9 M4 0.047 A/m

Cursor:

Total = 0.1182 A/m

H Category: M4

Location: 25, -25, 8.7 mm

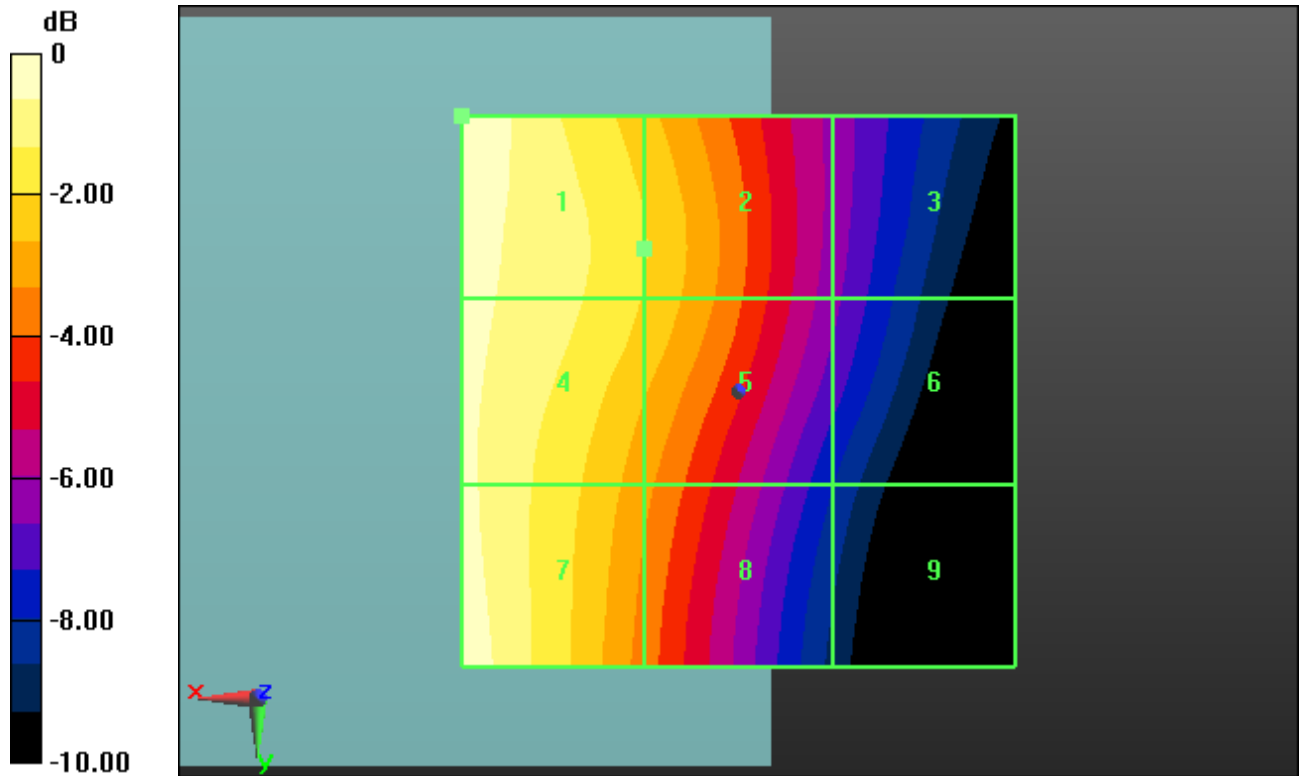

0 dB = 0.1182 A/m = -18.55 dB A/m

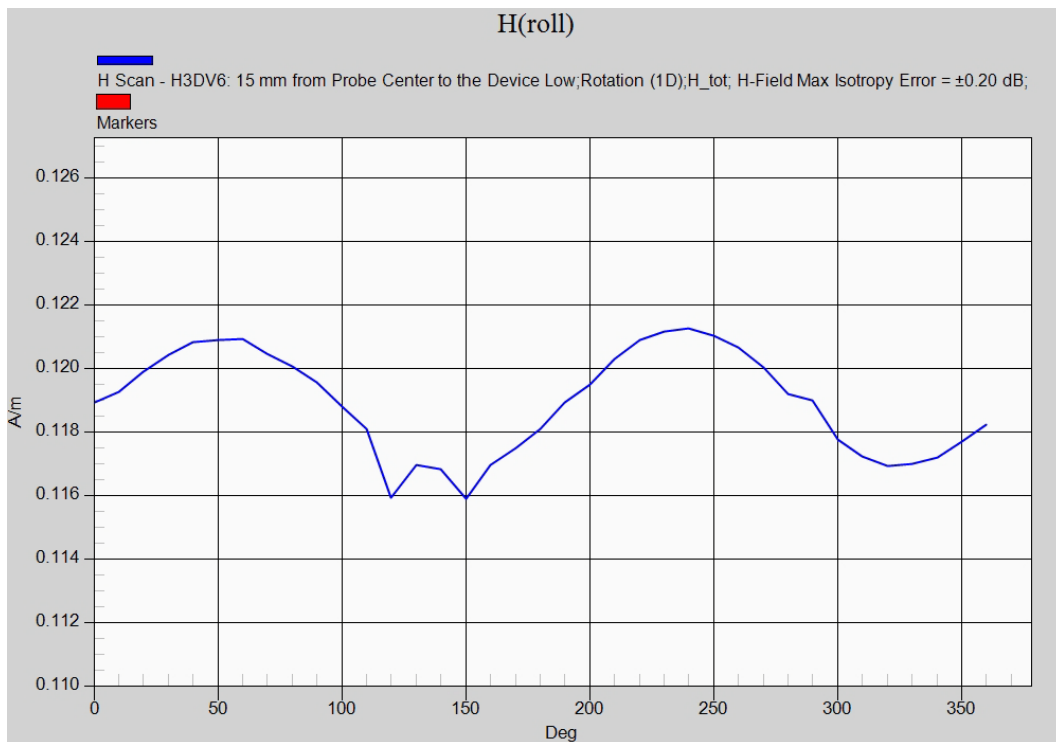

rot 0°	rot max.	percentage deviation	max. field strength (A/m)	worst case calculated (A/m)
0.119	0.121	1.65%	0.118	0.120

Annex B.4: WCDMA FDD IV 1730MHz

Date/Time: 08.12.2012 15:37:47

HAC_E

DUT: Sony; Type: PM-0280-BV; Serial: CB5A1MAPY5

Communication System: WCDMA FDD IV; Frequency: 1712.4 MHz; Duty Cycle: 1:1

Medium parameters used: $\sigma = 0$ mho/m, $\epsilon_r = 1$; $\rho = 0$ kg/m³

Phantom section: TCoil Section

DASY5 Configuration:

- Probe: ER3DV6 - SN2262; ConvF(1, 1, 1); Calibrated: 09.01.2012;
- Sensor-Surface: (Fix Surface)
- Electronics: DAE3 Sn477; Calibrated: 09.05.2012
- Phantom: HAC Test Arch with AMCC; Type: SD HAC P01 BA; Serial: 1007+1022
- Measurement SW: DASY52 52.8.2(969); Postprocessing SW: SEMCAD X 14.6.6(6824)

HAC WCDMA FDD IV/E Scan - ER3D - 2007: 15 mm from Probe Center to the Device low/Hearing Aid Compatibility Test (101x101x1): Interpolated grid:

dx=0.5000 mm, dy=0.5000 mm

Device Reference Point: 0, 0, -6.3 mm

Reference Value = 14.92 V/m; Power Drift = 0.13 dB

PMR not calibrated. PMF = 1.000 is applied.

E-field emissions = 27.83 V/m

Near-field category: M4 (AWF 0 dB)

PMF scaled E-field

Grid 1 M4 20.07 V/m	Grid 2 M4 17.26 V/m	Grid 3 M4 15.33 V/m
Grid 4 M4 13.77 V/m	Grid 5 M4 19.17 V/m	Grid 6 M4 19.16 V/m
Grid 7 M4 24.10 V/m	Grid 8 M4 27.83 V/m	Grid 9 M4 26.94 V/m

Cursor:

Total = 27.83 V/m

E Category: M4

Location: -2.5, 25, 8.7 mm

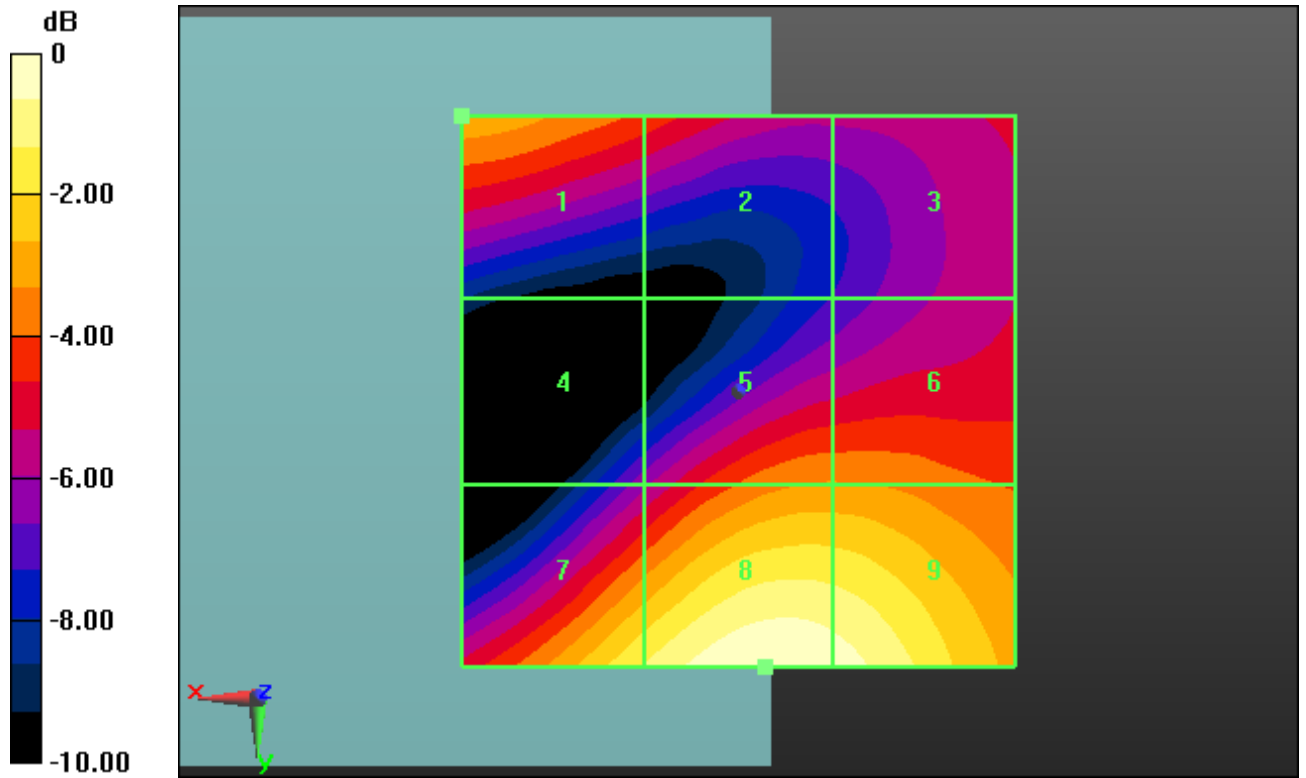

0 dB = 27.83 V/m = 28.89 dB V/m

Date/Time: 08.12.2012 15:43:33

HAC_E

DUT: Sony; Type: PM-0280-BV; Serial: CB5A1MAPY5

Communication System: WCDMA FDD IV; Frequency: 1732.4 MHz; Duty Cycle: 1:1

Medium parameters used: $\sigma = 0$ mho/m, $\epsilon_r = 1$; $\rho = 0$ kg/m³

Phantom section: TCoil Section

DASY5 Configuration:

- Probe: ER3DV6 - SN2262; ConvF(1, 1, 1); Calibrated: 09.01.2012;
- Sensor-Surface: (Fix Surface)
- Electronics: DAE3 Sn477; Calibrated: 09.05.2012
- Phantom: HAC Test Arch with AMCC; Type: SD HAC P01 BA; Serial: 1007+1022
- Measurement SW: DASY52 52.8.2(969); Postprocessing SW: SEMCAD X 14.6.6(6824)

HAC WCDMA FDD IV/E Scan - ER3D - 2007: 15 mm from Probe Center to the Device middle/Hearing Aid Compatibility Test (101x101x1): Interpolated grid:

dx=0.5000 mm, dy=0.5000 mm

Device Reference Point: 0, 0, -6.3 mm

Reference Value = 13.27 V/m; Power Drift = -0.10 dB

PMR not calibrated. PMF = 1.000 is applied.

E-field emissions = 26.24 V/m

Near-field category: M4 (AWF 0 dB)

PMF scaled E-field

Grid 1 M4 18.48 V/m	Grid 2 M4 16.34 V/m	Grid 3 M4 13.57 V/m
Grid 4 M4 13.81 V/m	Grid 5 M4 18.90 V/m	Grid 6 M4 18.83 V/m
Grid 7 M4 23.05 V/m	Grid 8 M4 26.24 V/m	Grid 9 M4 25.48 V/m

Cursor:

Total = 26.24 V/m

E Category: M4

Location: -2.5, 25, 8.7 mm

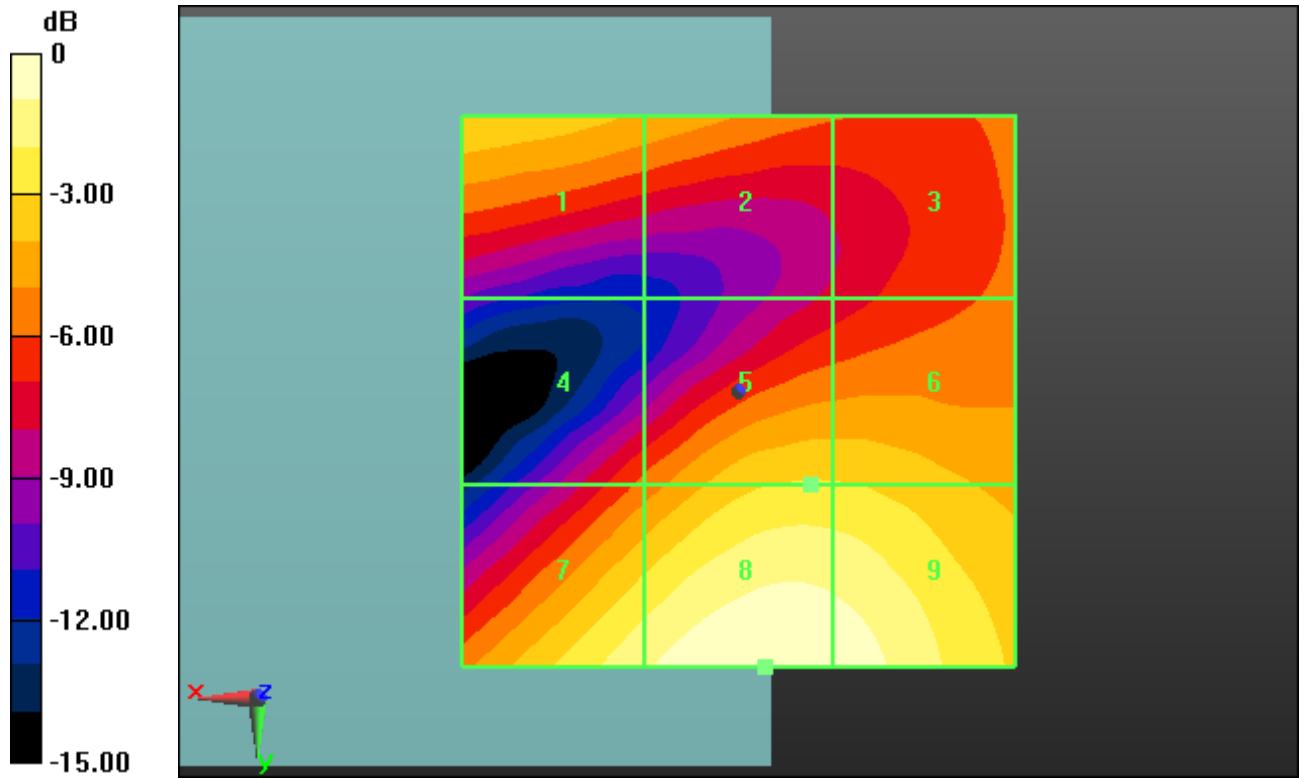

0 dB = 26.24 V/m = 28.38 dB V/m

Date/Time: 08.12.2012 15:48:43

HAC_E

DUT: Sony; Type: PM-0280-BV; Serial: CB5A1MAPY5

Communication System: WCDMA FDD IV; Frequency: 1752.6 MHz; Duty Cycle: 1:1

Medium parameters used: $\sigma = 0$ mho/m, $\epsilon_r = 1$; $\rho = 0$ kg/m³

Phantom section: TCoil Section

DASY5 Configuration:

- Probe: ER3DV6 - SN2262; ConvF(1, 1, 1); Calibrated: 09.01.2012;
- Sensor-Surface: (Fix Surface)
- Electronics: DAE3 Sn477; Calibrated: 09.05.2012
- Phantom: HAC Test Arch with AMCC; Type: SD HAC P01 BA; Serial: 1007+1022
- Measurement SW: DASY52 52.8.2(969); Postprocessing SW: SEMCAD X 14.6.6(6824)

HAC WCDMA FDD IV/E Scan - ER3D - 2007: 15 mm from Probe Center to the Device high/Hearing Aid Compatibility Test (101x101x1): Interpolated grid:

dx=0.5000 mm, dy=0.5000 mm

Device Reference Point: 0, 0, -6.3 mm

Reference Value = 14.65 V/m; Power Drift = 0.07 dB

PMR not calibrated. PMF = 1.000 is applied.

E-field emissions = 28.26 V/m

Near-field category: M4 (AWF 0 dB)

PMF scaled E-field

Grid 1 M4 21.96 V/m	Grid 2 M4 20.36 V/m	Grid 3 M4 15.76 V/m
Grid 4 M4 14.21 V/m	Grid 5 M4 19.74 V/m	Grid 6 M4 19.67 V/m
Grid 7 M4 25.06 V/m	Grid 8 M4 28.26 V/m	Grid 9 M4 26.90 V/m

Cursor:

Total = 28.26 V/m

E Category: M4

Location: -1.5, 25, 8.7 mm

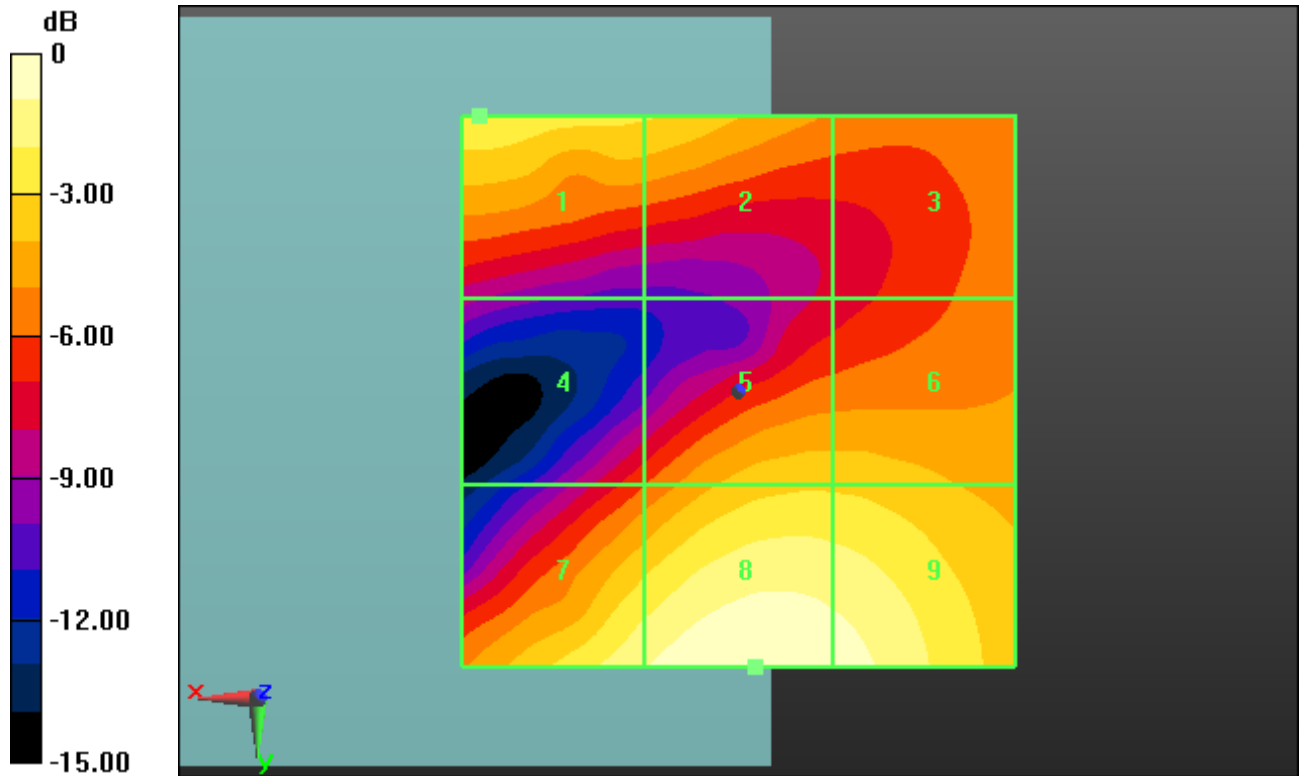

0 dB = 28.26 V/m = 29.02 dB V/m

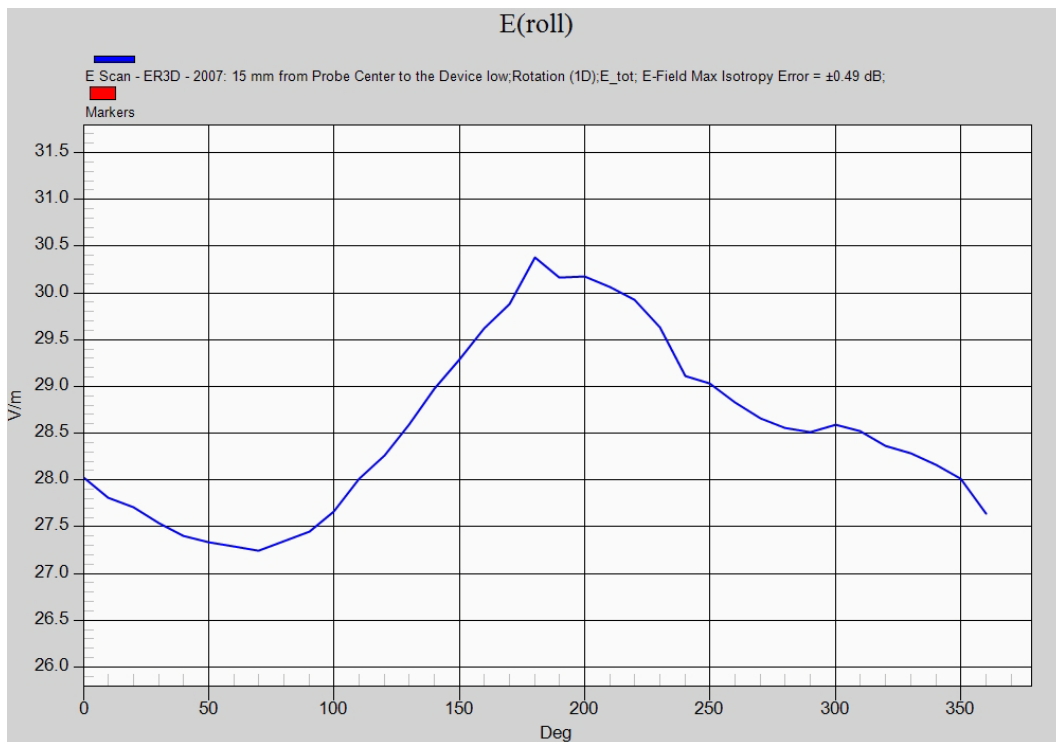

rot 0°	rot max.	percentage deviation	max. field strength (V/m)	worst case calculated (V/m)
28	30.3	7.59%	28.26	30.41

Date/Time: 10.12.2012 08:47:04

HAC-RF

DUT: Sony; Type: PM-0280-BV; Serial: CB5A1MAPY5

Communication System: WCDMA FDD IV; Frequency: 1712.4 MHz; Duty Cycle: 1:1

Medium parameters used: $\sigma = 0$ mho/m, $\epsilon_r = 1$; $\rho = 0$ kg/m³

Phantom section: TCoil Section

DASY5 Configuration:

- Probe: H3DV6 - SN6086; ; Calibrated: 14.01.2012
- Sensor-Surface: (Fix Surface)
- Electronics: DAE3 Sn477; Calibrated: 09.05.2012
- Phantom: HAC Test Arch with AMCC; Type: SD HAC P01 BA; Serial: 1007+1022
- Measurement SW: DASY52 52.8.2(969); Postprocessing SW: SEMCAD X 14.6.6(6824)

Device H-Field measurement WCDMA FDD IV/H Scan - H3DV6: 15 mm from Probe Center to the Device Low/Hearing Aid Compatibility Test

(101x101x1): Interpolated grid: dx=0.5000 mm, dy=0.5000 mm

Device Reference Point: 0, 0, -6.3 mm

Reference Value = 0.07600 A/m; Power Drift = 0.01 dB

PMR not calibrated. PMF = 1.000 is applied.

H-field emissions = 0.06822 A/m

Near-field category: M4 (AWF 0 dB)

PMF scaled H-field

Grid 1 M4 0.066 A/m	Grid 2 M4 0.068 A/m	Grid 3 M4 0.063 A/m
Grid 4 M4 0.066 A/m	Grid 5 M4 0.068 A/m	Grid 6 M4 0.063 A/m
Grid 7 M4 0.066 A/m	Grid 8 M4 0.064 A/m	Grid 9 M4 0.058 A/m

Cursor:

Total = 0.06822 A/m

H Category: M4

Location: 1.5, -5.5, 8.7 mm

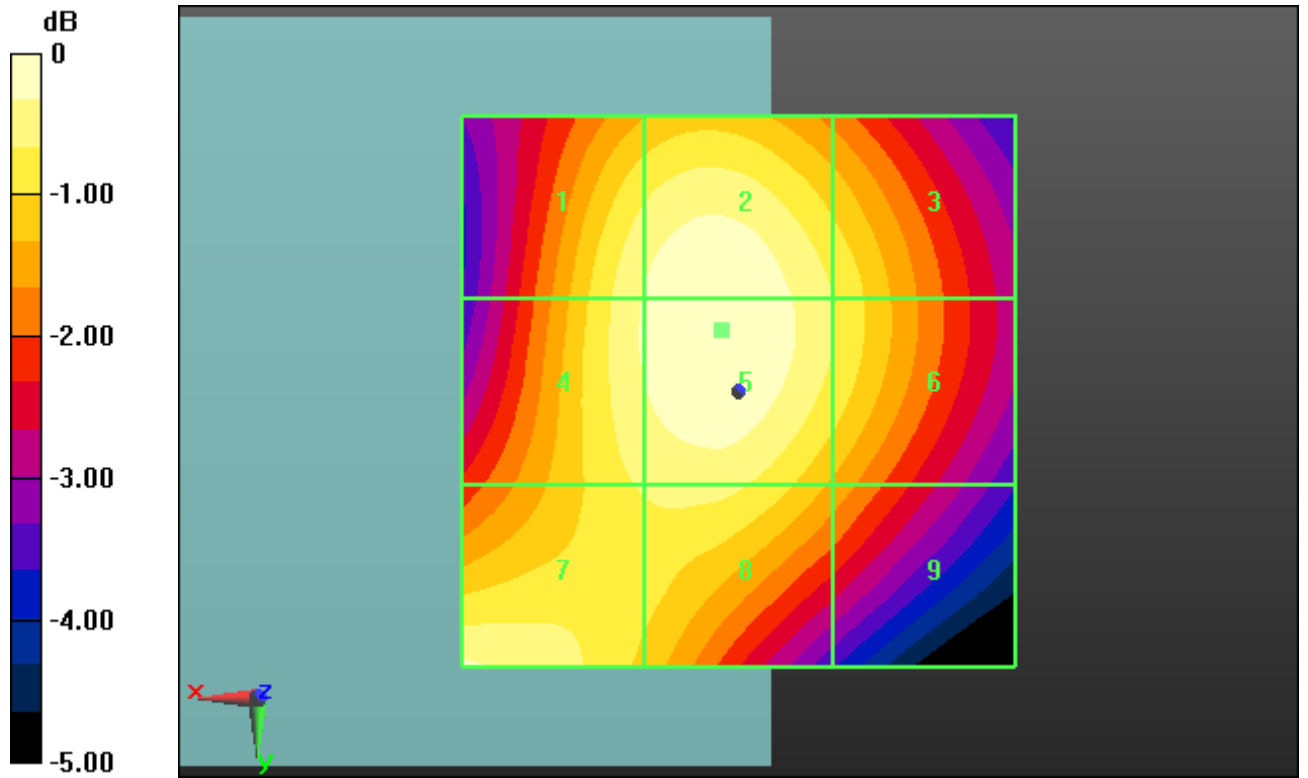

0 dB = 0.06822 A/m = -23.32 dB A/m

Date/Time: 10.12.2012 08:52:11

HAC-RF

DUT: Sony; Type: PM-0280-BV; Serial: CB5A1MAPY5

Communication System: WCDMA FDD IV; Frequency: 1732.4 MHz; Duty Cycle: 1:1

Medium parameters used: $\sigma = 0$ mho/m, $\epsilon_r = 1$; $\rho = 0$ kg/m³

Phantom section: TCoil Section

DASY5 Configuration:

- Probe: H3DV6 - SN6086; ; Calibrated: 14.01.2012
- Sensor-Surface: (Fix Surface)
- Electronics: DAE3 Sn477; Calibrated: 09.05.2012
- Phantom: HAC Test Arch with AMCC; Type: SD HAC P01 BA; Serial: 1007+1022
- Measurement SW: DASY52 52.8.2(969); Postprocessing SW: SEMCAD X 14.6.6(6824)

Device H-Field measurement WCDMA FDD IV/H Scan - H3DV6: 15 mm from Probe Center to the Device Middle/Hearing Aid Compatibility Test

(101x101x1): Interpolated grid: dx=0.5000 mm, dy=0.5000 mm

Device Reference Point: 0, 0, -6.3 mm

Reference Value = 0.07300 A/m; Power Drift = -0.10 dB

PMR not calibrated. PMF = 1.000 is applied.

H-field emissions = 0.06501 A/m

Near-field category: M4 (AWF 0 dB)

PMF scaled H-field

Grid 1 M4 0.063 A/m	Grid 2 M4 0.065 A/m	Grid 3 M4 0.060 A/m
Grid 4 M4 0.063 A/m	Grid 5 M4 0.065 A/m	Grid 6 M4 0.060 A/m
Grid 7 M4 0.063 A/m	Grid 8 M4 0.060 A/m	Grid 9 M4 0.054 A/m

Cursor:

Total = 0.06501 A/m

H Category: M4

Location: 2.5, -7, 8.7 mm

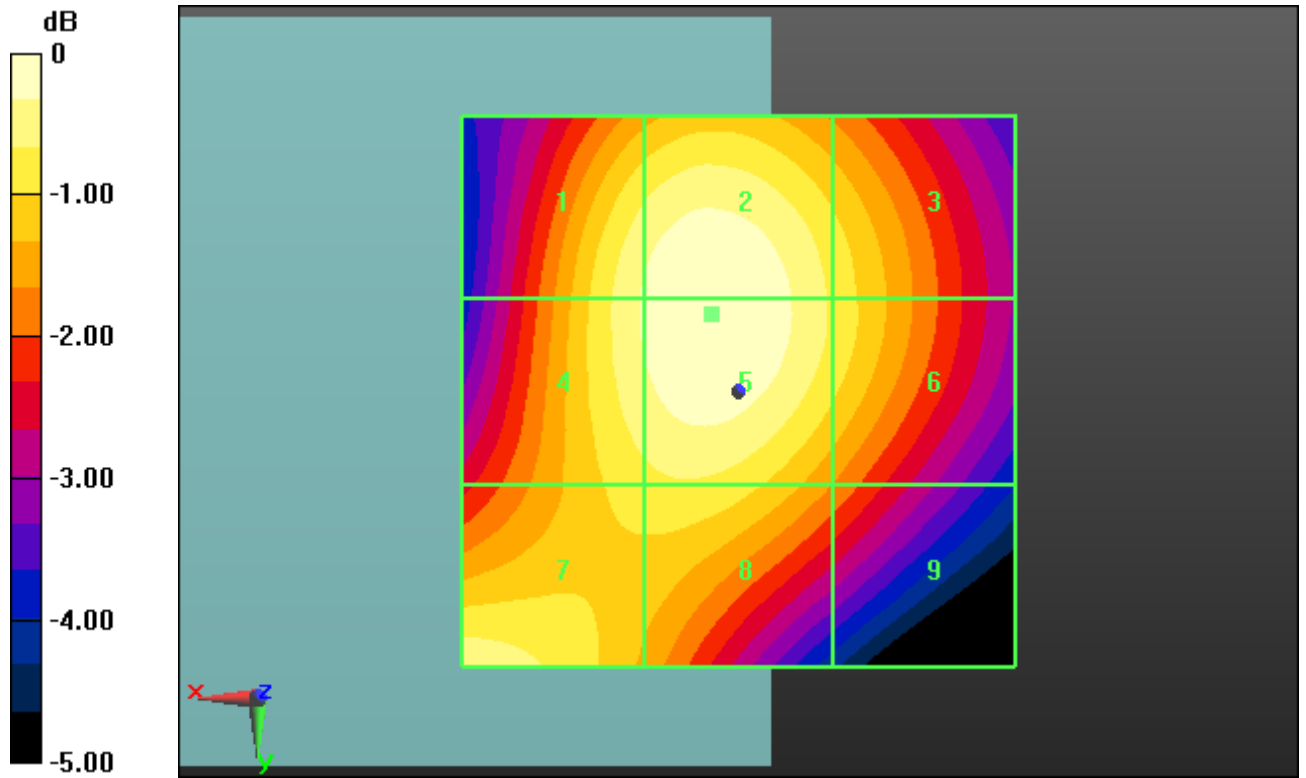

0 dB = 0.06501 A/m = -23.74 dB A/m

Date/Time: 10.12.2012 08:57:05

HAC-RF

DUT: Sony; Type: PM-0280-BV; Serial: CB5A1MAPY5

Communication System: WCDMA FDD IV; Frequency: 1752.6 MHz; Duty Cycle: 1:1

Medium parameters used: $\sigma = 0$ mho/m, $\epsilon_r = 1$; $\rho = 0$ kg/m³

Phantom section: TCoil Section

DASY5 Configuration:

- Probe: H3DV6 - SN6086; ; Calibrated: 14.01.2012
- Sensor-Surface: (Fix Surface)
- Electronics: DAE3 Sn477; Calibrated: 09.05.2012
- Phantom: HAC Test Arch with AMCC; Type: SD HAC P01 BA; Serial: 1007+1022
- Measurement SW: DASY52 52.8.2(969); Postprocessing SW: SEMCAD X 14.6.6(6824)

Device H-Field measurement WCDMA FDD IV/H Scan - H3DV6: 15 mm from Probe Center to the Device High/Hearing Aid Compatibility Test

(101x101x1): Interpolated grid: dx=0.5000 mm, dy=0.5000 mm

Device Reference Point: 0, 0, -6.3 mm

Reference Value = 0.08700 A/m; Power Drift = 0.06 dB

PMR not calibrated. PMF = 1.000 is applied.

H-field emissions = 0.07591 A/m

Near-field category: M4 (AWF 0 dB)

PMF scaled H-field

Grid 1 M4 0.073 A/m	Grid 2 M4 0.076 A/m	Grid 3 M4 0.071 A/m
Grid 4 M4 0.073 A/m	Grid 5 M4 0.076 A/m	Grid 6 M4 0.071 A/m
Grid 7 M4 0.069 A/m	Grid 8 M4 0.070 A/m	Grid 9 M4 0.065 A/m

Cursor:

Total = 0.07591 A/m

H Category: M4

Location: 1.5, -5, 8.7 mm

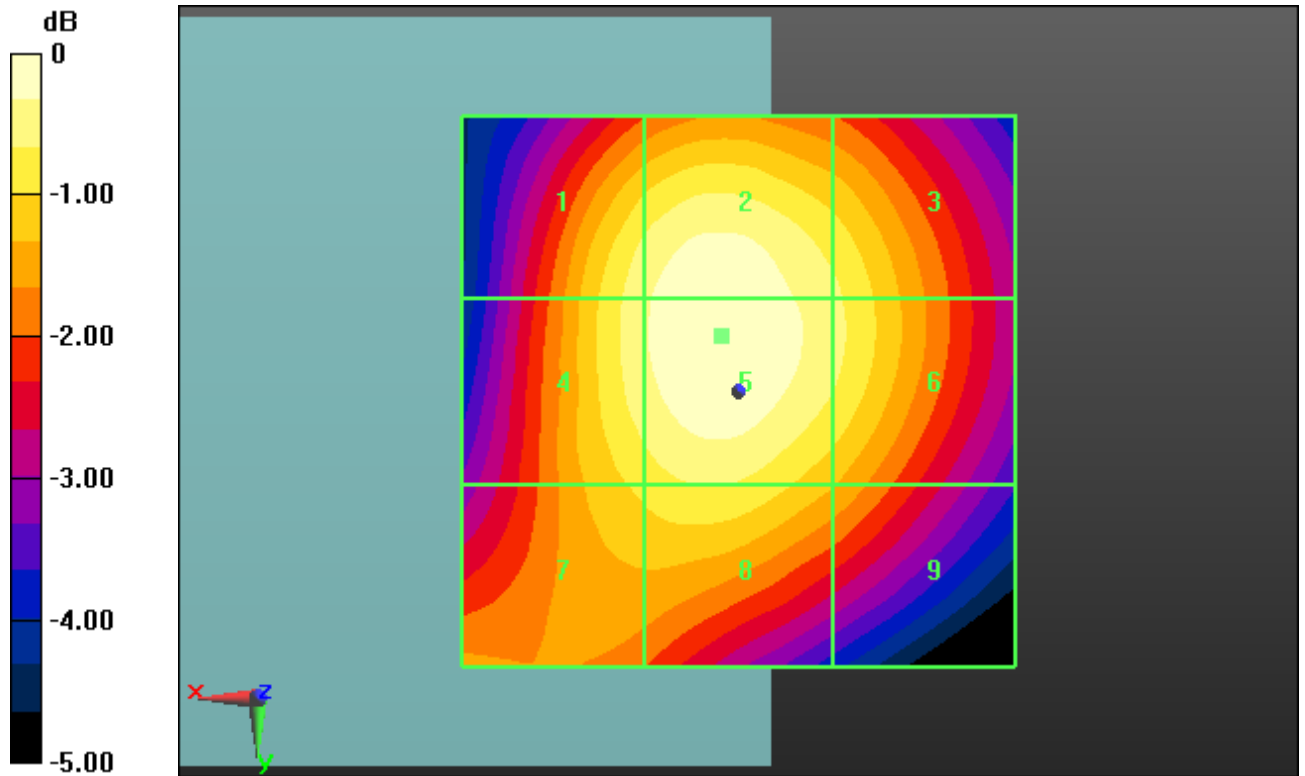

0 dB = 0.07591 A/m = -22.39 dB A/m

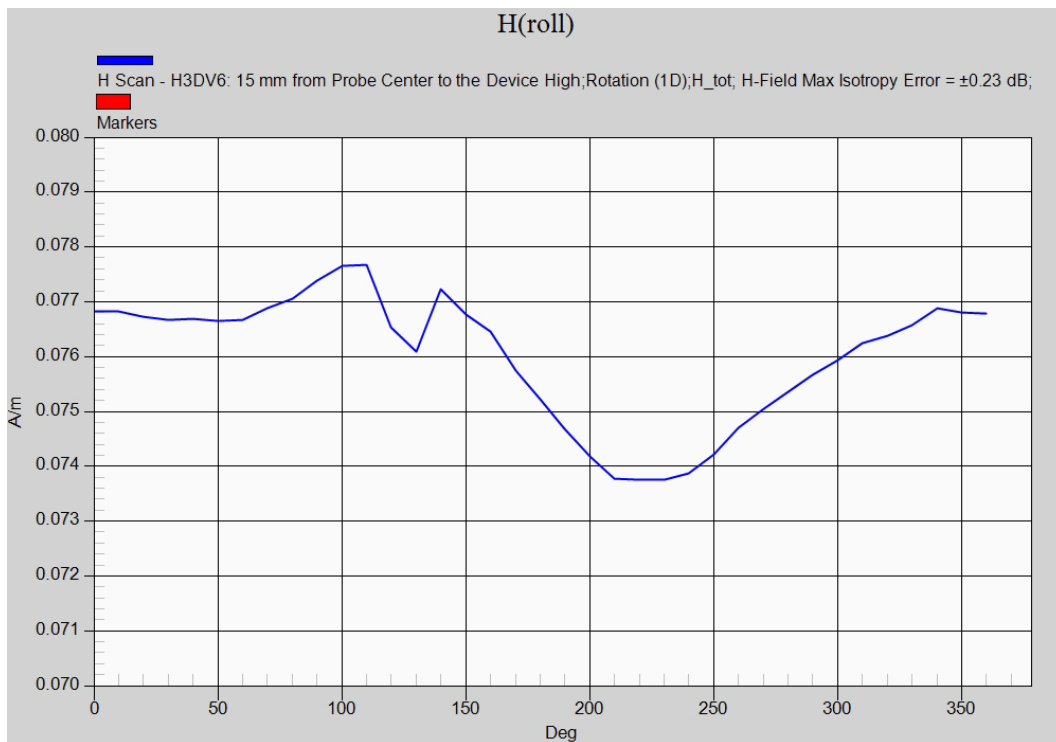

rot 0°	rot max.	percentage deviation	max. field strength (A/m)	worst case calculated (A/m)
0.0768	0.0776	1.03%	0.076	0.077

Annex B.5: WCDMA FDD II 1880MHz

Date/Time: 08.12.2012 15:54:23

HAC_E

DUT: Sony; Type: PM-0280-BV; Serial: CB5A1MAPY5

Communication System: WCDMA FDD II; Frequency: 1852.5 MHz; Duty Cycle: 1:1

Medium parameters used: $\sigma = 0$ mho/m, $\epsilon_r = 1$; $\rho = 0$ kg/m³

Phantom section: TCoil Section

DASY5 Configuration:

- Probe: ER3DV6 - SN2262; ConvF(1, 1, 1); Calibrated: 09.01.2012;
- Sensor-Surface: (Fix Surface)
- Electronics: DAE3 Sn477; Calibrated: 09.05.2012
- Phantom: HAC Test Arch with AMCC; Type: SD HAC P01 BA; Serial: 1007+1022
- Measurement SW: DASY52 52.8.2(969); Postprocessing SW: SEMCAD X 14.6.6(6824)

HAC WCDMA FDD II/E Scan - ER3D - 2007: 15 mm from Probe Center to the Device low/Hearing Aid Compatibility Test (101x101x1): Interpolated grid:

dx=0.5000 mm, dy=0.5000 mm

Device Reference Point: 0, 0, -6.3 mm

Reference Value = 12.27 V/m; Power Drift = -0.00 dB

PMR not calibrated. PMF = 1.000 is applied.

E-field emissions = 23.42 V/m

Near-field category: M4 (AWF 0 dB)

PMF scaled E-field

Grid 1 M4 18.70 V/m	Grid 2 M4 19.18 V/m	Grid 3 M4 17.17 V/m
Grid 4 M4 9.533 V/m	Grid 5 M4 13.87 V/m	Grid 6 M4 13.83 V/m
Grid 7 M4 19.85 V/m	Grid 8 M4 23.42 V/m	Grid 9 M4 22.49 V/m

Cursor:

Total = 23.42 V/m

E Category: M4

Location: -2, 25, 8.7 mm

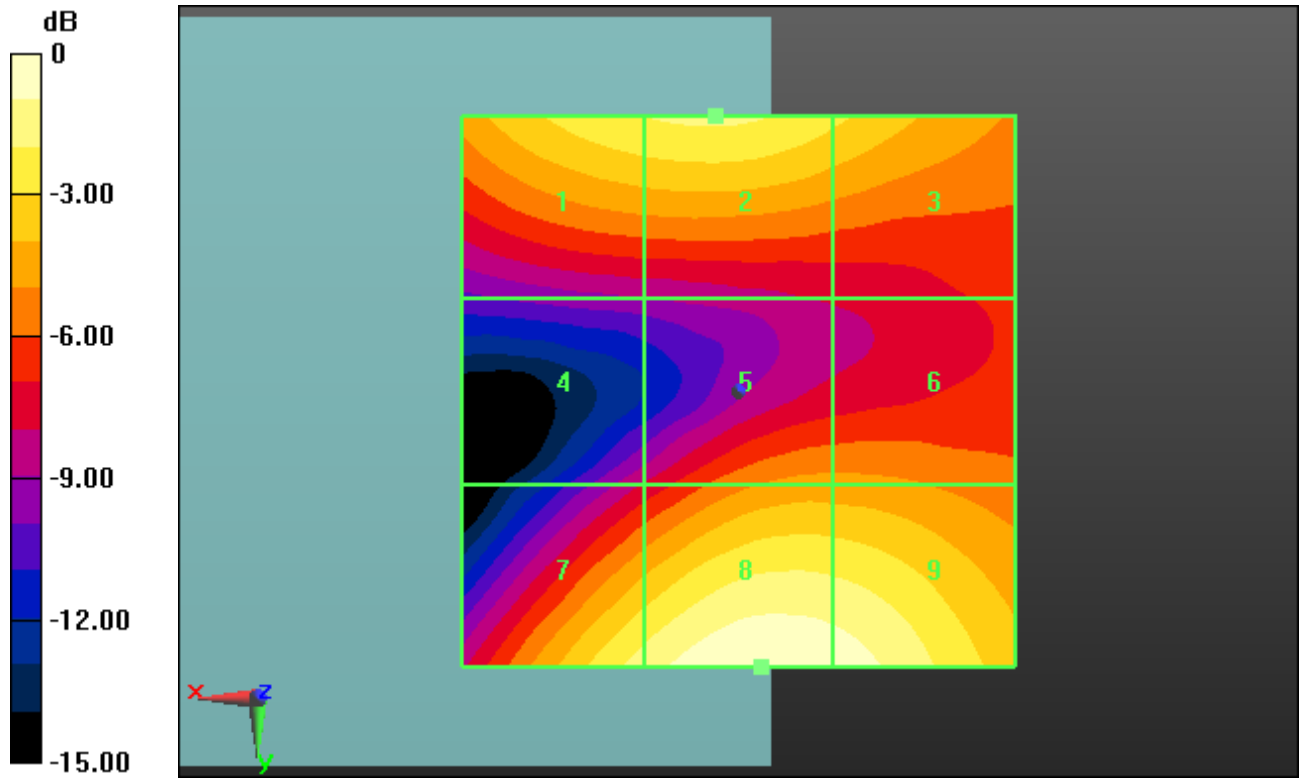

0 dB = 23.42 V/m = 27.39 dB V/m

Date/Time: 08.12.2012 15:59:32

HAC_E**DUT: Sony; Type: PM-0280-BV; Serial: CB5A1MAPY5**

Communication System: WCDMA FDD II; Frequency: 1880 MHz; Duty Cycle: 1:1

Medium parameters used: $\sigma = 0$ mho/m, $\epsilon_r = 1$; $\rho = 0$ kg/m³

Phantom section: TCoil Section

DASY5 Configuration:

- Probe: ER3DV6 - SN2262; ConvF(1, 1, 1); Calibrated: 09.01.2012;
- Sensor-Surface: (Fix Surface)
- Electronics: DAE3 Sn477; Calibrated: 09.05.2012
- Phantom: HAC Test Arch with AMCC; Type: SD HAC P01 BA; Serial: 1007+1022
- Measurement SW: DASY52 52.8.2(969); Postprocessing SW: SEMCAD X 14.6.6(6824)

HAC WCDMA FDD II/E Scan - ER3D - 2007: 15 mm from Probe Center to the Device middle/Hearing Aid Compatibility Test (101x101x1): Interpolated grid:

dx=0.5000 mm, dy=0.5000 mm

Device Reference Point: 0, 0, -6.3 mm

Reference Value = 12.45 V/m; Power Drift = 0.01 dB

PMR not calibrated. PMF = 1.000 is applied.

E-field emissions = 23.36 V/m

Near-field category: M4 (AWF 0 dB)

PMF scaled E-field

Grid 1 M4 17.37 V/m	Grid 2 M4 18.02 V/m	Grid 3 M4 16.78 V/m
Grid 4 M4 10.09 V/m	Grid 5 M4 14.67 V/m	Grid 6 M4 14.67 V/m
Grid 7 M4 19.57 V/m	Grid 8 M4 23.36 V/m	Grid 9 M4 22.30 V/m

Cursor:

Total = 23.36 V/m

E Category: M4

Location: -1.5, 25, 8.7 mm

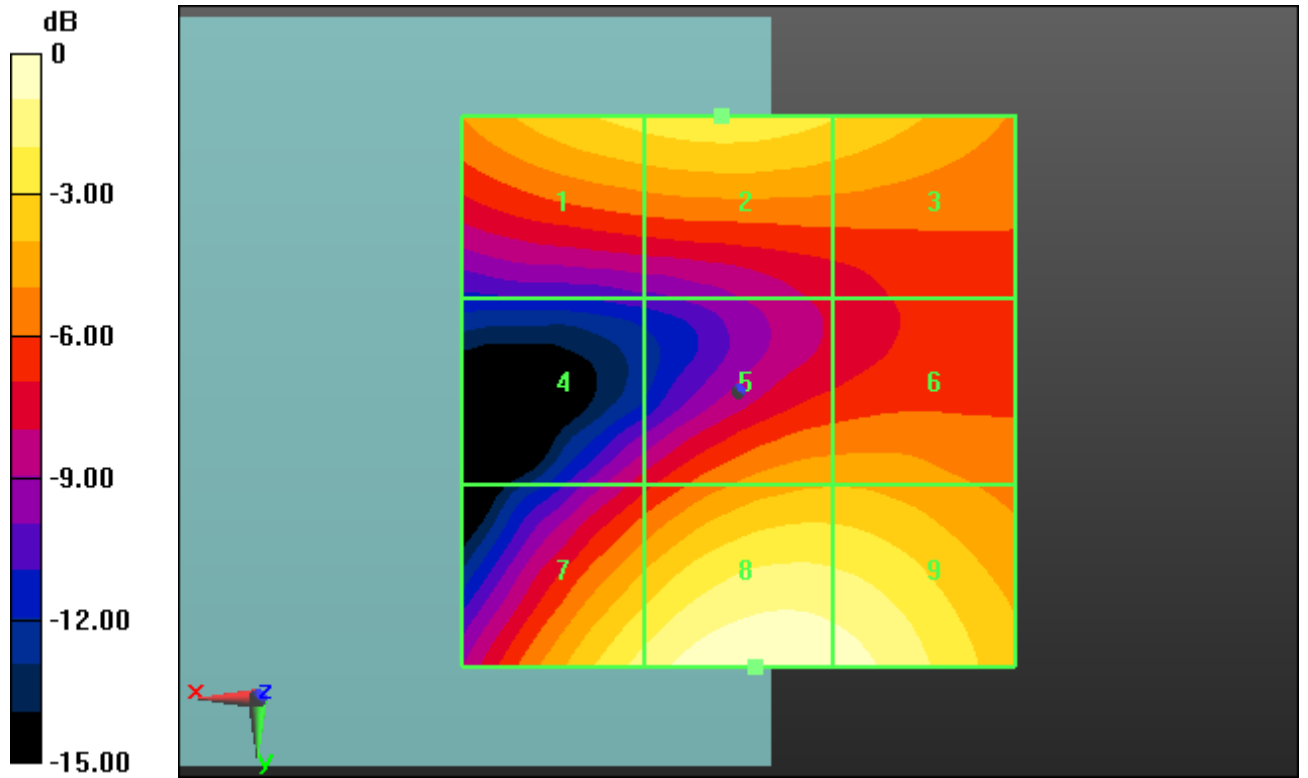

0 dB = 23.36 V/m = 27.37 dB V/m

Date/Time: 08.12.2012 16:05:32

HAC_E

DUT: Sony; Type: PM-0280-BV; Serial: CB5A1MAPY5

Communication System: WCDMA FDD II; Frequency: 1907.6 MHz; Duty Cycle: 1:1

Medium parameters used: $\sigma = 0$ mho/m, $\epsilon_r = 1$; $\rho = 0$ kg/m³

Phantom section: TCoil Section

DASY5 Configuration:

- Probe: ER3DV6 - SN2262; ConvF(1, 1, 1); Calibrated: 09.01.2012;
- Sensor-Surface: (Fix Surface)
- Electronics: DAE3 Sn477; Calibrated: 09.05.2012
- Phantom: HAC Test Arch with AMCC; Type: SD HAC P01 BA; Serial: 1007+1022
- Measurement SW: DASY52 52.8.2(969); Postprocessing SW: SEMCAD X 14.6.6(6824)

HAC WCDMA FDD II/E Scan - ER3D - 2007: 15 mm from Probe Center to the Device high/Hearing Aid Compatibility Test (101x101x1): Interpolated grid:

dx=0.5000 mm, dy=0.5000 mm

Device Reference Point: 0, 0, -6.3 mm

Reference Value = 13.10 V/m; Power Drift = 0.11 dB

PMR not calibrated. PMF = 1.000 is applied.

E-field emissions = 22.83 V/m

Near-field category: M4 (AWF 0 dB)

PMF scaled E-field

Grid 1 M4 18.76 V/m	Grid 2 M4 20.27 V/m	Grid 3 M4 19.18 V/m
Grid 4 M4 8.289 V/m	Grid 5 M4 13.54 V/m	Grid 6 M4 13.65 V/m
Grid 7 M4 18.10 V/m	Grid 8 M4 22.83 V/m	Grid 9 M4 22.31 V/m

Cursor:

Total = 22.83 V/m

E Category: M4

Location: -5, 25, 8.7 mm

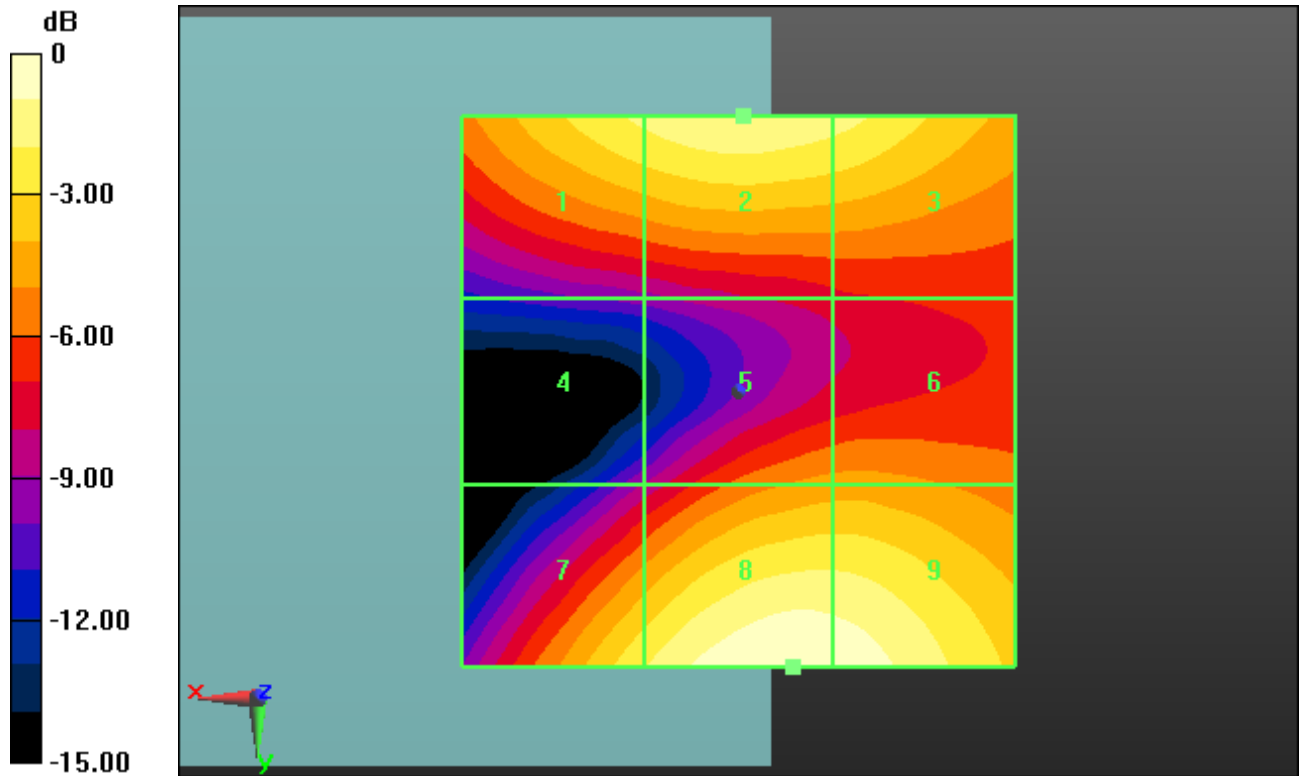

0 dB = 22.83 V/m = 27.17 dB V/m

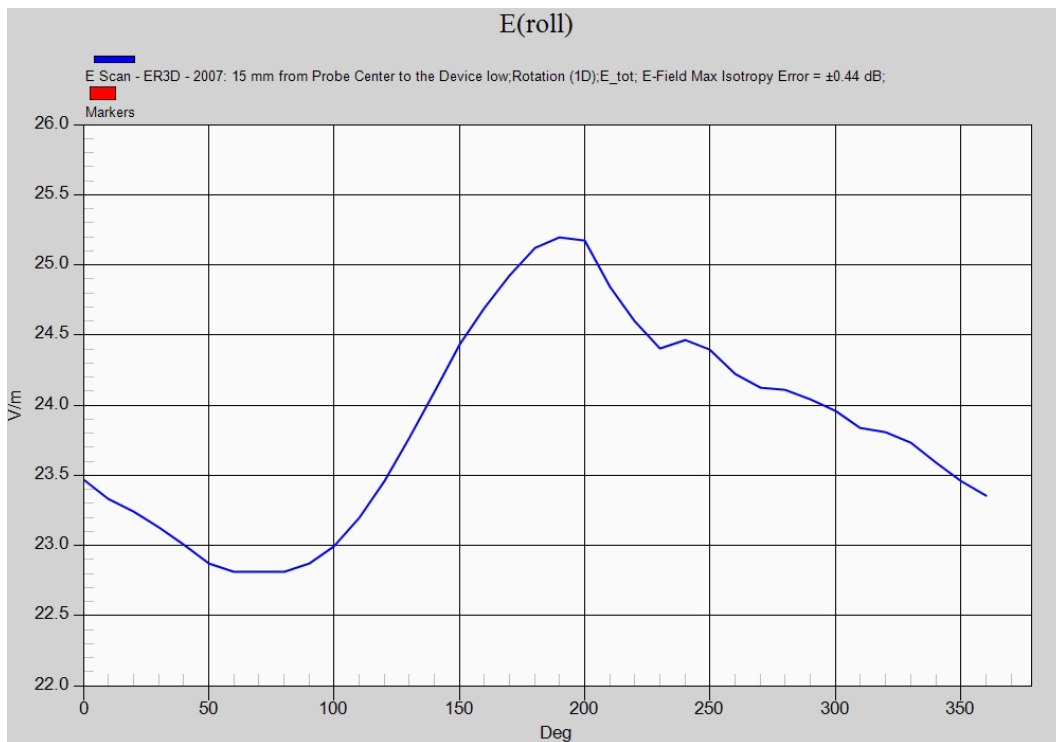

rot 0°	rot max.	percentage deviation	max. field strength (V/m)	worst case calculated (V/m)
23.4	25.2	7.14%	23.42	25.09

Date/Time: 10.12.2012 08:26:47

HAC-RF

DUT: Sony; Type: PM-0280-BV; Serial: CB5A1MAPY5

Communication System: WCDMA FDD II; Frequency: 1852.5 MHz; Duty Cycle: 1:1

Medium parameters used: $\sigma = 0$ mho/m, $\epsilon_r = 1$; $\rho = 0$ kg/m³

Phantom section: TCoil Section

DASY5 Configuration:

- Probe: H3DV6 - SN6086; ; Calibrated: 14.01.2012
- Sensor-Surface: (Fix Surface)
- Electronics: DAE3 Sn477; Calibrated: 09.05.2012
- Phantom: HAC Test Arch with AMCC; Type: SD HAC P01 BA; Serial: 1007+1022
- Measurement SW: DASY52 52.8.2(969); Postprocessing SW: SEMCAD X 14.6.6(6824)

Device H-Field measurement WCDMA FDD II/H Scan - H3DV6: 15 mm from Probe Center to the Device Low/Hearing Aid Compatibility Test

(101x101x1): Interpolated grid: dx=0.5000 mm, dy=0.5000 mm

Device Reference Point: 0, 0, -6.3 mm

Reference Value = 0.06500 A/m; Power Drift = 0.03 dB

PMR not calibrated. PMF = 1.000 is applied.

H-field emissions = 0.05616 A/m

Near-field category: M4 (AWF 0 dB)

PMF scaled H-field

Grid 1 M4 0.046 A/m	Grid 2 M4 0.055 A/m	Grid 3 M4 0.055 A/m
Grid 4 M4 0.047 A/m	Grid 5 M4 0.056 A/m	Grid 6 M4 0.056 A/m
Grid 7 M4 0.047 A/m	Grid 8 M4 0.052 A/m	Grid 9 M4 0.052 A/m

Cursor:

Total = 0.05616 A/m

H Category: M4

Location: -7, -3, 8.7 mm

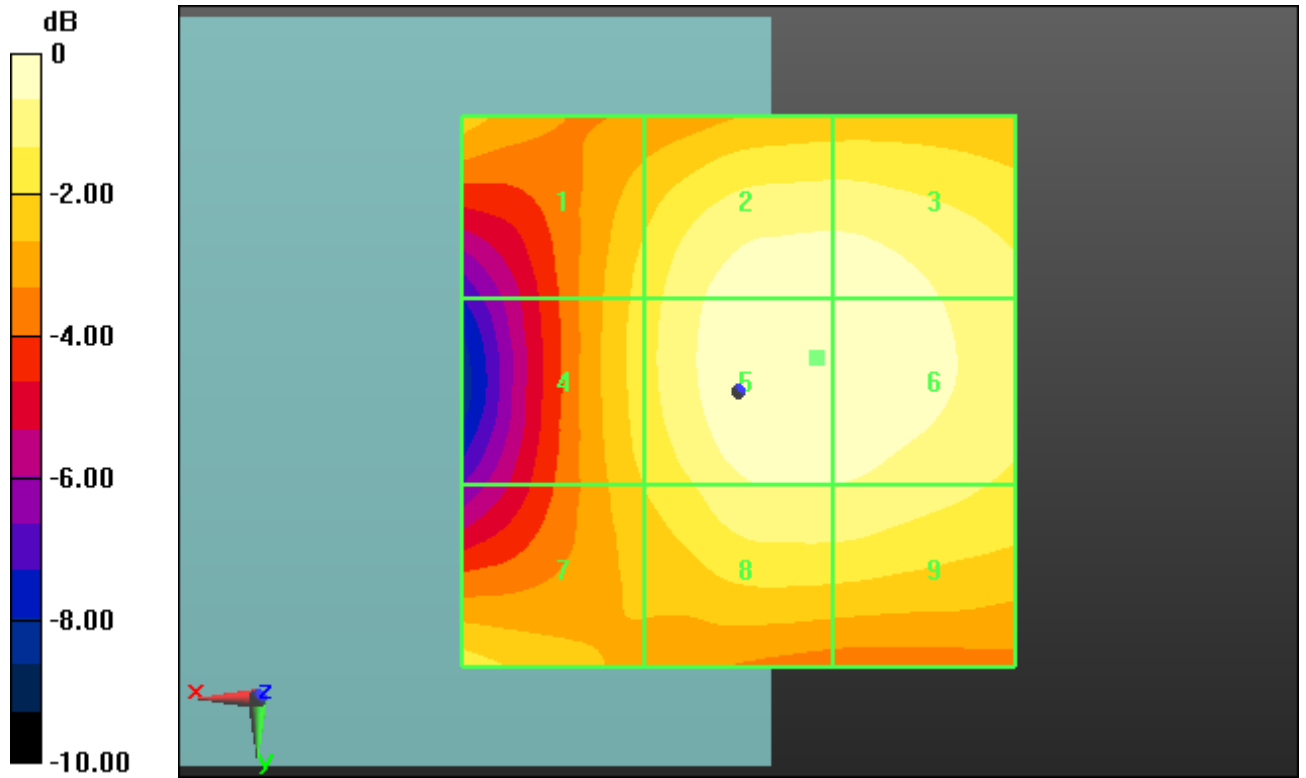

0 dB = 0.05616 A/m = -25.01 dB A/m

Date/Time: 10.12.2012 08:31:42

HAC-RF

DUT: Sony; Type: PM-0280-BV; Serial: CB5A1MAPY5

Communication System: WCDMA FDD II; Frequency: 1880 MHz; Duty Cycle: 1:1

Medium parameters used: $\sigma = 0$ mho/m, $\epsilon_r = 1$; $\rho = 0$ kg/m³

Phantom section: TCoil Section

DASY5 Configuration:

- Probe: H3DV6 - SN6086; ; Calibrated: 14.01.2012
- Sensor-Surface: (Fix Surface)
- Electronics: DAE3 Sn477; Calibrated: 09.05.2012
- Phantom: HAC Test Arch with AMCC; Type: SD HAC P01 BA; Serial: 1007+1022
- Measurement SW: DASY52 52.8.2(969); Postprocessing SW: SEMCAD X 14.6.6(6824)

Device H-Field measurement WCDMA FDD II/H Scan - H3DV6: 15 mm from Probe Center to the Device Middle/Hearing Aid Compatibility Test

(101x101x1): Interpolated grid: dx=0.5000 mm, dy=0.5000 mm

Device Reference Point: 0, 0, -6.3 mm

Reference Value = 0.06600 A/m; Power Drift = 0.049 dB

PMR not calibrated. PMF = 1.000 is applied.

H-field emissions = 0.06005 A/m

Near-field category: M4 (AWF 0 dB)

PMF scaled H-field

Grid 1 M4 0.055 A/m	Grid 2 M4 0.060 A/m	Grid 3 M4 0.058 A/m
Grid 4 M4 0.055 A/m	Grid 5 M4 0.060 A/m	Grid 6 M4 0.058 A/m
Grid 7 M4 0.051 A/m	Grid 8 M4 0.054 A/m	Grid 9 M4 0.053 A/m

Cursor:

Total = 0.06005 A/m

H Category: M4

Location: -1.5, -5.5, 8.7 mm

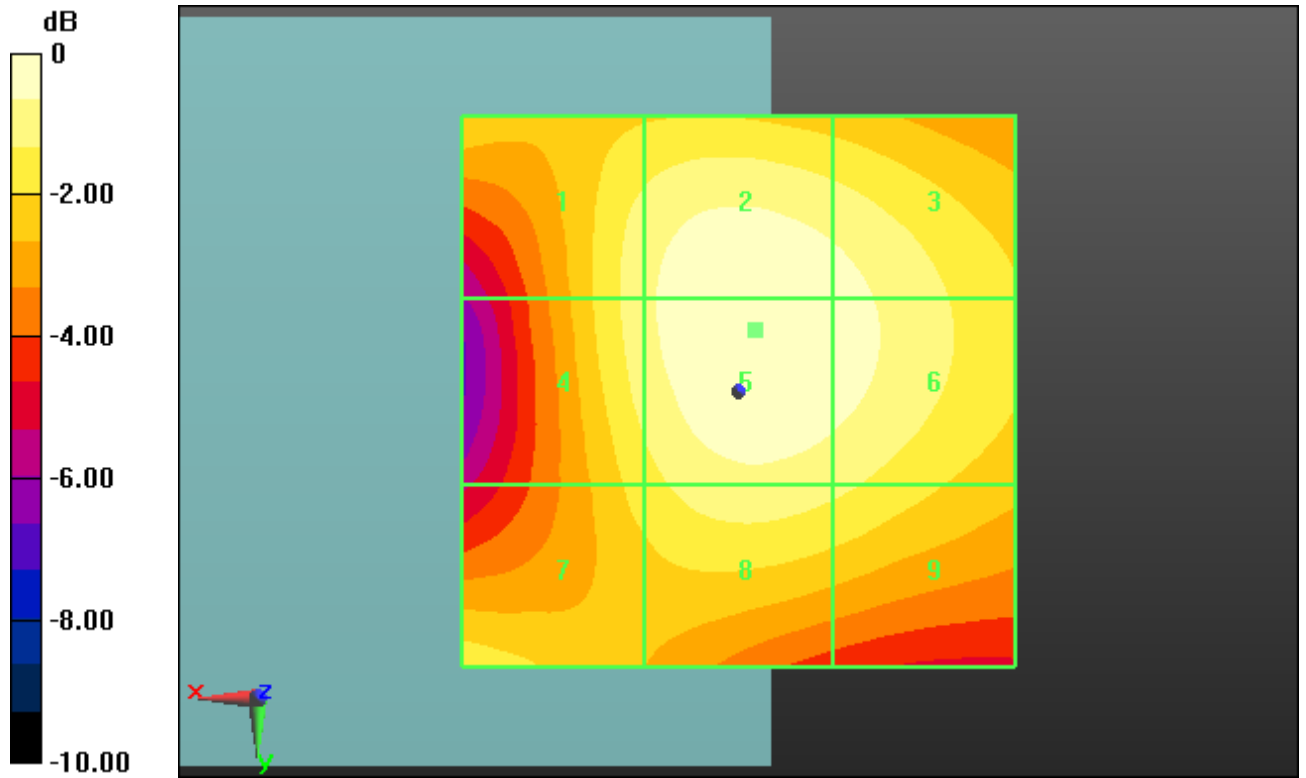

0 dB = 0.06005 A/m = -24.43 dB A/m

Date/Time: 10.12.2012 08:40:51

HAC-RF

DUT: Sony; Type: PM-0280-BV; Serial: CB5A1MAPY5

Communication System: WCDMA FDD II; Frequency: 1907.6 MHz; Duty Cycle: 1:1

Medium parameters used: $\sigma = 0$ mho/m, $\epsilon_r = 1$; $\rho = 0$ kg/m³

Phantom section: TCoil Section

DASY5 Configuration:

- Probe: H3DV6 - SN6086; ; Calibrated: 14.01.2012
- Sensor-Surface: (Fix Surface)
- Electronics: DAE3 Sn477; Calibrated: 09.05.2012
- Phantom: HAC Test Arch with AMCC; Type: SD HAC P01 BA; Serial: 1007+1022
- Measurement SW: DASY52 52.8.2(969); Postprocessing SW: SEMCAD X 14.6.6(6824)

Device H-Field measurement WCDMA FDD II/H Scan - H3DV6: 15 mm from Probe Center to the Device High/Hearing Aid Compatibility Test

(101x101x1): Interpolated grid: dx=0.5000 mm, dy=0.5000 mm

Device Reference Point: 0, 0, -6.3 mm

Reference Value = 0.06700 A/m; Power Drift = 0.08 dB

PMR not calibrated. PMF = 1.000 is applied.

H-field emissions = 0.05738 A/m

Near-field category: M4 (AWF 0 dB)

PMF scaled H-field

Grid 1 M4 0.051 A/m	Grid 2 M4 0.057 A/m	Grid 3 M4 0.055 A/m
Grid 4 M4 0.050 A/m	Grid 5 M4 0.057 A/m	Grid 6 M4 0.056 A/m
Grid 7 M4 0.046 A/m	Grid 8 M4 0.053 A/m	Grid 9 M4 0.052 A/m

Cursor:

Total = 0.05738 A/m

H Category: M4

Location: -2, -4, 8.7 mm

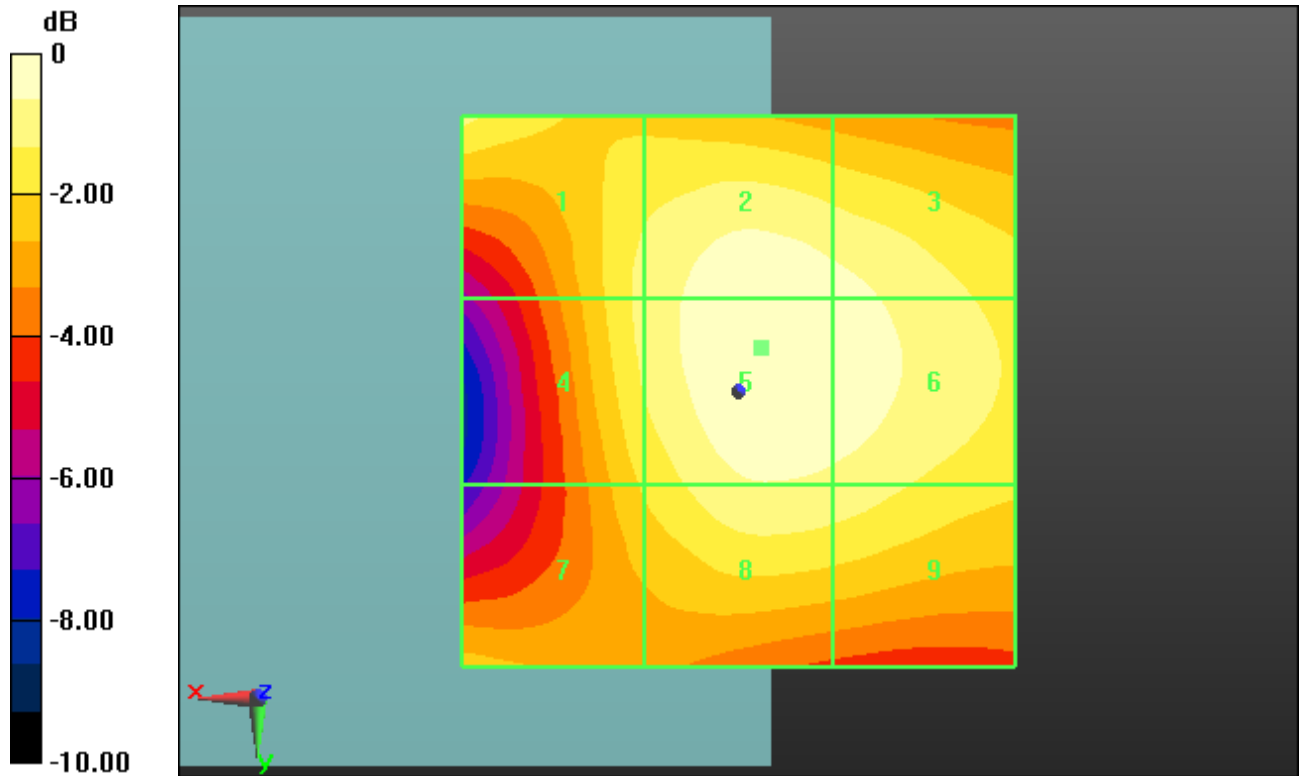

0 dB = 0.05738 A/m = -24.82 dB A/m

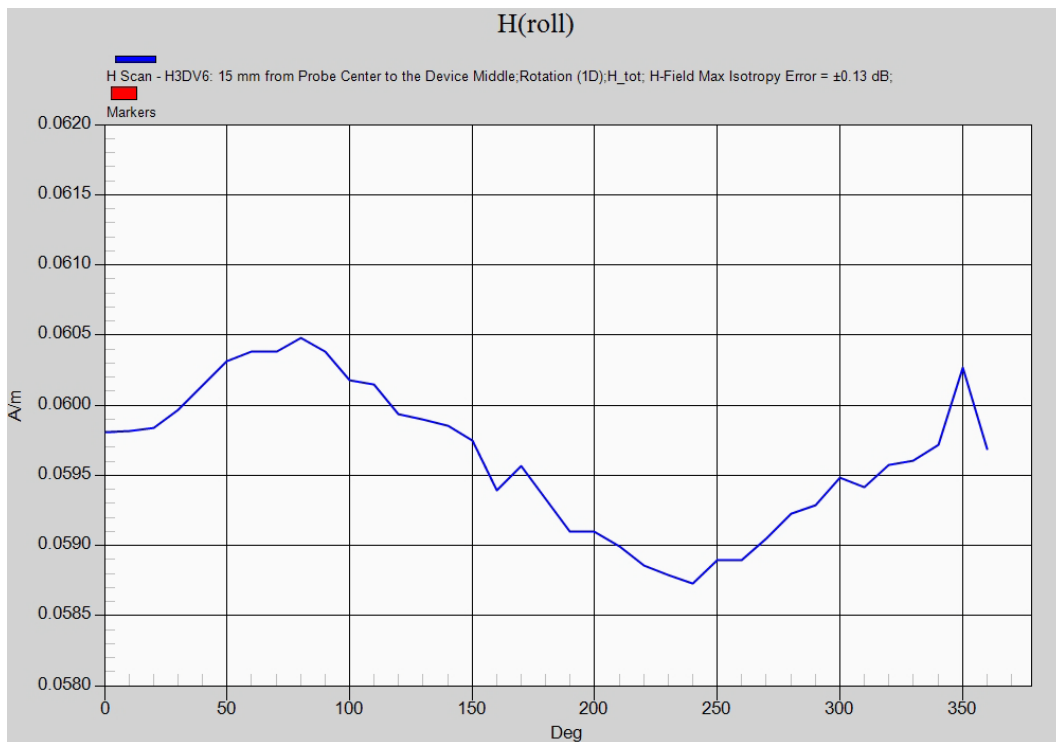

rot 0°	rot max.	percentage deviation	max. field strength (A/m)	worst case calculated (A/m)
0.0598	0.0605	1.16%	0.060	0.061

Annex C: Photo documentation

Photo documentation is described in the additional document:

Appendix to test report no. 1-4254/12-70-03 Photo documentation

Annex D: Calibration parameters

Calibration parameters are described in the additional document:

Appendix to test report no. 1-4254/12-70-03 Calibration data and system validation information

Annex E: Document History

Version	Applied Changes	Date of Release
	Initial Release	2012-12-11

Annex F: Further Information

Glossary

BW	-	Bandwidth
DUT	-	Device under Test
EUT	-	Equipment under Test
FCC	-	Federal Communication Commission
FCC ID	-	Company Identifier at FCC
HW	-	Hardware
IC	-	Industry Canada
Inv. No.	-	Inventory number
LTE	-	Long Term Evolution
N/A	-	not applicable
OET	-	Office of Engineering and Technology
RB	-	resource block(s)
SAR	-	Specific Absorption Rate
S/N	-	Serial Number
SW	-	Software