

TEST REPORT

Test report no.: 1-4254/12-61-19-A



Deutsche
 Akkreditierungsstelle
 D-PL-12076-01-01

Testing laboratory

CETECOM ICT Services GmbH
 Untertuerkheimer Strasse 6 – 10
 66117 Saarbruecken / Germany
 Phone: + 49 681 5 98 - 0
 Fax: + 49 681 5 98 - 9075
 Internet: <http://www.cetecom.com>
 e-mail: ict@cetecom.com

Accredited Testing Laboratory:

The testing laboratory (area of testing) is accredited according to DIN EN ISO/IEC 17025 (2005) by the Deutsche Akkreditierungsstelle GmbH (DAkkS). The accreditation is valid for the scope of testing procedures as stated in the accreditation certificate with the registration number: D-PL-12076-01-01
 Area of Testing: Radio/Satellite Communications

Applicant

Sony Mobile Communications AB
 Nya Vattentornet
 22188 Lund / SWEDEN
 Phone: +46 46 19 30 00
 Fax: +46 46 19 32 95
 Contact: Håkan Sjöberg
 e-mail: hakan.sjoberg@sonymobile.com
 Phone: +46 46 19 35 59

Manufacturer

Sony Mobile Communications AB
 Nya Vattentornet
 22188 Lund / SWEDEN

Test standard/s

47 CFR Part 22 Title 47 of the Code of Federal Regulations; Chapter I
 Part 22 - Public mobile services

RSS - 132 Issue 2 Spectrum Management and Telecommunications Policy - Radio Standards
 Specifications
 Cellular Telephones Employing New Technologies Operating in the Bands 824-849
 MHz and 869-894 MHz

For further applied test standards please refer to section 3 of this test report.

Test Item

Kind of test item: GSM Mobile Phone GPRS/EGPRS 850/900/1800/1900; UMTS HSPA FDDI/V/VIII; LTE FDD 1/3/5/7/8/20; WLAN a/b/g/n; BT 3.1; BT LE; RFID; FM Rx; A-GPS

Model name: PM-0240-BV

FCC ID: PY7PM-0240

IC: 4170B-PM0240

Frequency: LTE Band V 824 MHz to 849 MHz

Technology tested: LTE

Antenna: Integrated antenna

Power Supply: 3.7 V DC by Li -polymer battery

Temperature Range: -30°C to +60 °C

Test report authorised:

2013-01-30 Stefan BöS
 Senior Testing Manager

Test performed:

2013-01-30 Marco Bertolino
 Testing Manager

1 Table of contents	
1	Table of contents2
2	General information3
2.1	Notes and disclaimer3
2.2	Application details.....3
3	Test standard/s3
4	Test environment.....4
5	Test item4
5.1	Additional information4
6	Test laboratories sub-contracted4
7	Summary of measurement results5
7.1	LTE band V5
8	RF measurements6
8.1	Description of test setup6
8.1.1	Radiated measurements.....6
8.1.2	Conducted measurements.....7
8.2	RSP100 test report cover sheet / performance test data8
8.3	Results LTE band V9
8.4	Antenna gain9
8.4.1	RF output power10
8.4.2	Frequency stability13
8.4.3	Spurious emissions radiated16
8.4.4	Spurious emissions conducted21
8.4.5	Block edge compliance41
8.4.6	Occupied bandwidth50
9	Test equipment and ancillaries used for tests60
10	Observations60
Annex A	Document history61
Annex B	Further information.....61
Annex C	Accreditation Certificate62

2 General information

2.1 Notes and disclaimer

The test results of this test report relate exclusively to the test item specified in this test report. CETECOM ICT Services GmbH does not assume responsibility for any conclusions and generalizations drawn from the test results with regard to other specimens or samples of the type of the equipment represented by the test item.

The test report may only be reproduced or published in full. Reproduction or publication of extracts from the report requires the prior written approval of CETECOM ICT Services GmbH.

The testing service provided by CETECOM ICT Services GmbH has been rendered under the current "General Terms and Conditions for CETECOM ICT Services GmbH".

CETECOM ICT Services GmbH will not be liable for any loss or damage resulting from false, inaccurate, inappropriate or incomplete product information provided by the customer.

Under no circumstances does the CETECOM ICT Services GmbH test report include any endorsement or warranty regarding the functionality, quality or performance of any other product or service provided.

Under no circumstances does the CETECOM ICT Services GmbH test report include or imply any product or service warranties from CETECOM ICT Services GmbH, including, without limitation, any implied warranties of merchantability, fitness for purpose, or non-infringement, all of which are expressly disclaimed by CETECOM ICT Services GmbH.

All rights and remedies regarding vendor's products and services for which CETECOM ICT Services GmbH has prepared this test report shall be provided by the party offering such products or services and not by CETECOM ICT Services GmbH.

In no case this test report can be considered as a Letter of Approval.

2.2 Application details

Date of receipt of order:	2012-11-02
Date of receipt of test item:	2012-11-12
Start of test:	2012-11-23
End of test:	2012-11-27
Person(s) present during the test:	-/-

3 Test standard/s

Test standard	Date	Test standard description
47 CFR Part 22	2010-10	Title 47 of the Code of Federal Regulations; Chapter I Part 22 - Public mobile services
RSS - 132 Issue 2	2005-09	Spectrum Management and Telecommunications Policy - Radio Standards Specifications Cellular Telephones Employing New Technologies Operating in the Bands 824-849 MHz and 869-894 MHz

4 Test environment

Temperature:	T_{nom}	+22 °C during room temperature tests
	T_{max}	+60 °C during high temperature tests
	T_{min}	-30 °C during low temperature tests
Relative humidity content:		52 %
Barometric pressure:		not relevant for this kind of testing
Power supply:	V_{nom}	3.7 V DC by Li -polymer battery
	V_{max}	4.4 V
	V_{min}	3.3 V

5 Test item

Kind of test item	:	GSM Mobile Phone GPRS/EGPRS 850/900/1800/1900; UMTS HSPA FDDI/V/VIII; LTE FDD 1/3/5/7/8/20; WLAN a/b/g/n; BT 3.1; BT LE; RFID; FM Rx; A-GPS
Type identification	:	PM-0240-BV
S/N serial number	:	Conducted units: CB5121TUBU Radiated units: CB5121SWDK; CB5121TU0P
HW hardware status	:	SP1.2
SW software status	:	10.1.A.0.194, 10.1.A.1.17
Frequency band [MHz]	:	LTE Band V 824 MHz to 849 MHz
Type of modulation	:	QPSK, 16-QAM
Antenna	:	Integrated antenna
Power supply	:	3.7 V DC by Li -polymer battery
Temperature range	:	-30°C to +60 °C

5.1 Additional information

Test setup- and EUT-photos are included in test report 1-4254/12-61-03

6 Test laboratories sub-contracted

None

7 Summary of measurement results

- No deviations from the technical specifications were ascertained
- There were deviations from the technical specifications ascertained

TC identifier	Description	verdict	date	Remark
RF-Testing	CFR Part 22 RSS 132	passed	2013-01-30	-/-

7.1 LTE band V

Test Case	temperature conditions	power source voltages	Pass	Fail	NA	NP	Remark
RF Output Power	Nominal	Nominal	<input checked="" type="checkbox"/>	<input type="checkbox"/>	<input type="checkbox"/>	<input type="checkbox"/>	-/-
Frequency Stability	Nominal	Nominal	<input checked="" type="checkbox"/>	<input type="checkbox"/>	<input type="checkbox"/>	<input type="checkbox"/>	-/-
Spurious Emissions Radiated	Nominal	Nominal	<input checked="" type="checkbox"/>	<input type="checkbox"/>	<input type="checkbox"/>	<input type="checkbox"/>	-/-
Spurious Emissions Conducted	Nominal	Nominal	<input checked="" type="checkbox"/>	<input type="checkbox"/>	<input type="checkbox"/>	<input type="checkbox"/>	-/-
Block Edge Compliance	Nominal	Nominal	<input checked="" type="checkbox"/>	<input type="checkbox"/>	<input type="checkbox"/>	<input type="checkbox"/>	-/-
Occupied Bandwidth	Nominal	Nominal	<input checked="" type="checkbox"/>	<input type="checkbox"/>	<input type="checkbox"/>	<input type="checkbox"/>	-/-

Note: NA = Not applicable; NP = Not performed

8 RF measurements

8.1 Description of test setup

For the spurious measurements we use the substitution method according TIA/EIA 603.

8.1.1 Radiated measurements

The radiated emissions from the EUT are performed in a semi anechoic chamber. The EUT is placed on a conductive turntable and powered with nominal voltage. The signalling is performed either from outside the chamber with a signalling unit (AP or other) by air link using a signalling antenna or directly by special test software from the customer.

Semi anechoic chamber

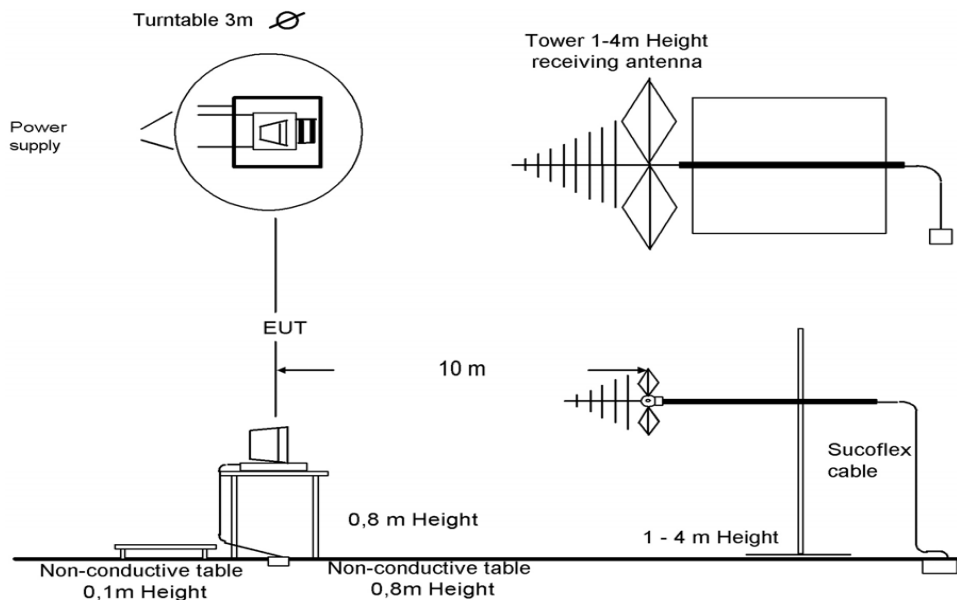

Picture 1: Diagram radiated measurements

9 kHz - 30 MHz:	active loop antenna
30 MHz – 1 GHz:	tri-log antenna
> 1 GHz:	horn antenna

8.1.2 Conducted measurements

The EUT's RF signal is coupled out by the antenna connector which is supplied by the manufacturer. The signal is first 10dB attenuated before it is power divided (~6dB loss per branch). One of the signal paths is connected to the signalling unit (AP or other), the other one is connected to the spectrum analyzer. The specific losses for both signal paths are first checked within a calibration. The measurement readings on the signalling unit/spectrum analyzer are corrected by the specific test set-up loss. The attenuator, power divider, signalling unit and the spectrum analyzer are impedance matched on 50 Ohm. If special software is used, there is no power divider necessary.

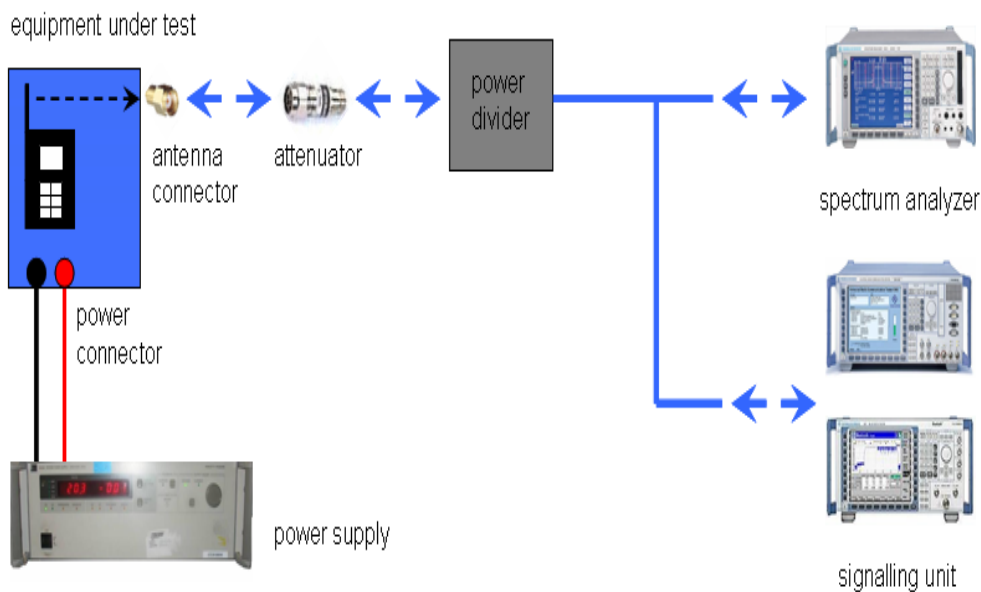

Picture 2: Diagram conducted measurements

The term measuring receiver refers to either a selective voltmeter or a spectrum analyser.

Frequency being measured f	Measuring receiver bandwidth 6 dB	Spectrum analyser bandwidth 3dB
$f < 150 \text{ kHz}$	200 Hz or	300 Hz
$150 \text{ kHz} \leq f < 25 \text{ MHz}$	9 kHz or	10 kHz
$25 \text{ MHz} \leq f < 1000 \text{ MHz}$	120 kHz or	100 kHz
$1000 \text{ MHz} \leq f$		1 MHz
NOTE: Specific requirements in CEPT/ERC/Recommendation 70-03 [2] shall be applied where applicable.		

8.2 RSP100 test report cover sheet / performance test data

Test Report Number	:	1-4254/12-61-19-A			
Equipment Model Number	:	PM-0240-BV			
Certification Number	:	4170B-PM0240			
Manufacturer (complete Address)	:	Sony Mobile Communications AB Nya Vattentorget 22188 Lund / SWEDEN			
Tested to radio standards specification no.	:	RSS - 132 Issue 2			
Open Area Test Site IC No.	:	IC 3462C-1			
Frequency Range	:	LTE band 5 - 824.7 MHz to 848.3 MHz			
GPS receiver turned	:	On			
RF-power [dBm] (max.)	1.4	Channel bandwidth	Conducted	ERP / EIRP	Mode
		24.15 dBm	19.33 dBm	QPSK	
	3	23.37 dBm	18.53 dBm	16-QAM	
		24.05 dBm	19.33 dBm	QPSK	
	5	22.98 dBm	18.35 dBm	16-QAM	
		24.14 dBm	19.17 dBm	QPSK	
	10	23.52 dBm	18.17 dBm	16-QAM	
		24.24 dBm	19.06 dBm	QPSK	
			22.43 dBm	18.09 dBm	16-QAM
	Occupied bandwidth (99%-BW) [MHz]	1.4	1075		QPSK
1081			16-QAM		
3		2688		QPSK	
		2688		16-QAM	
5		4480		QPSK	
		4480		16-QAM	
10		8960		QPSK	
		8960		16-QAM	
Type of modulation		:	QPSK; 16QAM		
Emission Designator (TRC-43)		1.4	1M08G7D		QPSK
	1M08W7D		16-QAM		
	3	2M69G7D		QPSK	
		2M69W7D		16-QAM	
	5	4M48G7D		QPSK	
		4M48W7D		16-QAM	
	10	8M96G7D		QPSK	
		8M96W7D		16-QAM	
	Antenna Information	:	integrated antenna		
	Transmitter Spurious (worst case) [dBm]	:	-41 dBm @ 4 GHz (noise floor / peak)		
Receiver Spurious (worst case) [dBμV/m @ 3m]	:	48 @ 12.5 GHz (noise floor / peak)			

ATTESTATION:

DECLARATION OF COMPLIANCE:

I attest that the testing was performed or supervised by me; that the test measurements were made in accordance with the above-mentioned Industry Canada standard(s); and that the equipment identified in this application has been subjected to all the applicable test conditions specified in the Industry Canada standards and all of the requirements of the standard have been met.

Laboratory Manager:

2013-01-30

Marco Bertolino

Date

Name



Signature

8.3 Results LTE band V

The EUT was set to transmit the maximum power.

8.4 Antenna gain

Measurement:

The antenna gain of the complete system is calculated by the difference of radiated power in EIRP and the conducted power of the module. Measured with 1.4 MHz Bandwidth and 100% RB.

Measurement parameters:

Measurement parameter
Measured with CMW 500

Results:

T_{nom}	V_{nom}	lowest channel 824.7 MHz	middle channel 836.5 MHz	highest channel 848.3 MHz
Conducted power [dBm]		23.0	23.1	23.0
Radiated power [dBm]		16.5	17.9	19.3
Gain [dBi] Calculated		-6.5	-5.2	-3.7
Measurement uncertainty			± 1.5 dB (cond.) / ± 3 dB (rad.)	

8.4.1 RF output power

Description:

This paragraph contains average power, peak output power and ERP measurements for the mobile station. In all cases, the peak output power is within the required mask (this mask is specified in the JTC standards, TIA PN3389 Vol. 1 Chap 7, and is no FCC requirement).

Measurement:

The mobile was set up for the maximum output power with pseudo random data modulation.

To determine the Peak-To-Average Power Ratio (PAPR) the measurement was performed with the Power Complementary Cumulative Distribution Function (CCDF).

Measurement parameters
Measured with CMW500

Limits:

FCC	IC
CFR Part 22.913 CFR Part 2.1046	RSS 132
Nominal Peak Output Power	
+38.45 dBm	
In measuring transmissions in this band using an average power technique, the peak-to-average ratio (PAR) of the transmission may not exceed 13 dB.	

Results:

Output Power (conducted)						
Bandwidth (MHz)	Frequency (MHz)	Resource block allocation	Average Output Power (dBm) QPSK	Peak to Average Ratio (dB)	Average Output Power (dBm) 16-QAM	Peak to Average Ratio (dB)
1.4	824.7	1 RB low	23.94	5.06	22.82	5.91
		1 RB high	23.95	5.15	22.75	5.94
		50% RB mid	23.71	4.89	22.81	6.12
		100% RB	23.02	5.68	22.06	6.71
	836.5	1 RB low	24.14	4.87	23.33	5.51
		1 RB high	24.15	4.86	23.37	5.54
		50% RB mid	24.02	4.73	22.93	6.24
		100% RB	23.11	5.71	21.92	6.75
	848.3	1 RB low	23.97	4.63	22.60	5.91
		1 RB high	23.93	4.53	22.62	5.72
		50% RB mid	24.01	5.33	23.18	6.08
		100% RB	23.03	6.16	22.23	6.43
3	825.5	1 RB low	24.00	5.12	22.96	5.10
		1 RB high	24.05	5.08	22.98	5.04
		50% RB mid	23.01	5.51	21.95	6.65
		100% RB	22.85	5.88	21.85	6.49
	836.5	1 RB low	24.01	4.56	22.70	5.80
		1 RB high	24.03	4.52	22.73	5.78
		50% RB mid	23.04	5.77	22.28	6.23
		100% RB	23.10	6.05	22.01	6.55
	847.5	1 RB low	23.96	4.80	22.55	6.33
		1 RB high	23.89	4.75	22.52	6.30
		50% RB mid	23.07	5.89	22.01	6.59
		100% RB	23.03	6.20	22.05	6.77
5	826.5	1 RB low	24.00	4.67	23.19	6.12
		1 RB high	24.00	4.64	23.12	6.12
		50% RB mid	22.89	5.92	21.99	6.42
		100% RB	22.77	6.09	21.79	7.15
	836.5	1 RB low	23.92	4.88	23.40	5.06
		1 RB high	24.14	4.84	23.52	5.05
		50% RB mid	23.01	6.20	22.08	6.75
		100% RB	22.95	6.06	21.82	7.28
	846.5	1 RB low	23.96	4.70	22.64	5.96
		1 RB high	23.92	4.60	22.61	5.86
		50% RB mid	23.05	5.81	21.96	6.82
		100% RB	22.87	6.08	21.87	7.28

10	829	1 RB low	24.08	5.17	23.11	5.90
		1 RB high	24.05	4.75	23.16	5.72
		50% RB mid	22.88	6.29	21.89	6.86
		100% RB	22.62	6.14	21.57	7.23
	836.5	1 RB low	24.14	5.12	23.32	5.74
		1 RB high	24.24	5.14	23.42	5.74
		50% RB mid	22.96	5.94	22.00	6.75
		100% RB	22.75	6.05	21.78	7.17
	844	1 RB low	24.10	5.09	23.32	5.74
		1 RB high	24.18	5.09	23.43	5.73
		50% RB mid	22.94	5.89	22.00	6.75
		100% RB	22.76	6.25	21.79	7.06
Measurement uncertainty			± 0.5 dB			

The radiated output power was measured with the lowest supported channel bandwidth and with the maximum number of resource blocks.

All other bandwidths were calculated with the corresponding antenna gain (with full resource blocks).

Output Power (radiated)			
Bandwidth (MHz)	Frequency (MHz)	Average Output Power (dBm)	
		QPSK	16-QAM
1.4	824.7	16.50	15.36
	836.5	17.91	16.72
	848.3	19.33	18.53
3	825.5	16.15	15.15
	836.5	17.90	16.81
	847.5	19.33	18.35
5	826.5	16.07	15.09
	836.5	17.75	16.62
	846.5	19.17	18.17
10	829.0	15.92	14.87
	836.5	17.55	16.58
	844.0	19.06	18.09
Measurement uncertainty		± 3.0 dB	

Result: Passed

8.4.2 Frequency stability

Description:

In order to measure the carrier frequency under the condition of AFC lock, it is necessary to make measurements with the mobile station in a “call mode”. This is accomplished with the use of a R&S CMW500 DIGITAL RADIOCOMMUNICATION TESTER.

1. Measure the carrier frequency at room temperature.
2. Subject the mobile station to overnight soak at -30 C.
3. With the mobile station, powered with V_{nom} , connected to the CMW500 and in a simulated call on channel 4180 (centre channel), measure the carrier frequency. These measurements should be made within two minutes of powering up the mobile station, to prevent significant self warming.
4. Repeat the above measurements at 10°C increments from -30°C to +60°C. Allow at least 1.5 hours at each temperature, unpowered, before making measurements.
5. Remeasure carrier frequency at room temperature with V_{nom} . Vary supply voltage from V_{min} to V_{max} , in 0.1 Volt steps remeasuring carrier frequency at each voltage. Pause at V_{nom} for 1.5 hours unpowered, to allow any self heating to stabilize, before continuing.
6. At all temperature levels hold the temperature to +/- 0.5°C during the measurement procedure.

Measurement:

Measurement parameters	
Detector:	Measured with CMW500
Sweep time:	
Video bandwidth:	
Resolution bandwidth:	
Span:	
Trace-Mode:	

Limits:

FCC	IC
CFR Part 22.355 CFR Part 2.1055	RSS 132
Frequency Stability	
± 0.1 ppm	

Results:**AFC FREQ ERROR versus VOLTAGE**

Voltage (V)	Frequency Error (Hz)	Frequency Error (%)	Frequency Error (ppm)
3.3	-11	-0,00000132	-0,0132
3.4	7	0,00000084	0,0084
3.5	-7	-0,00000084	-0,0084
3.6	-5	-0,00000060	-0,0060
3.7	9	0,00000108	0,0108
3.8	-8	-0,00000096	-0,0096
3.9	-5	-0,00000060	-0,0060
4.0	-10	-0,00000120	-0,0120
4.1	-7	-0,00000084	-0,0084
4.2	9	0,00000108	0,0108
4.3	-7	-0,00000084	-0,0084
4.4	-12	-0,00000143	-0,0143

AFC FREQ ERROR versus TEMPERATURE

Temperature (°C)	Frequency Error (Hz)	Frequency Error (%)	Frequency Error (ppm)
-30	-16	-0,00000191	-0,0191
-20	-15	-0,00000179	-0,0179
-10	-9	-0,00000108	-0,0108
± 0	6	0,00000072	0,0072
10	9	0,00000108	0,0108
20	-8	-0,00000096	-0,0096
30	-13	-0,00000155	-0,0155
40	-8	-0,00000096	-0,0096
50	-10	-0,00000120	-0,0120
60	-16	-0,00000191	-0,0191

Frequency Error vs. Voltage

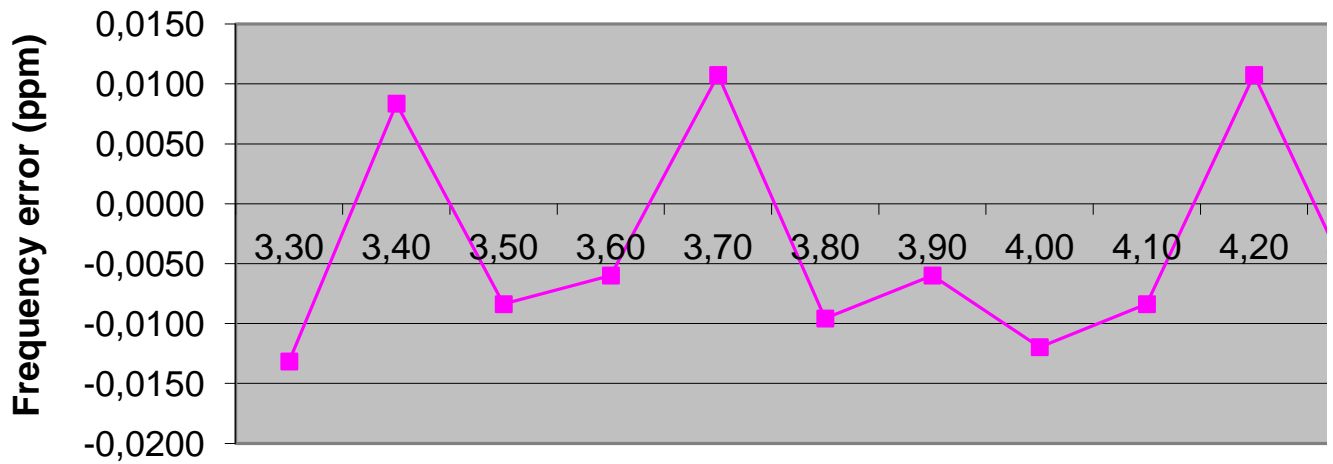

Frequency Error vs. Temperature

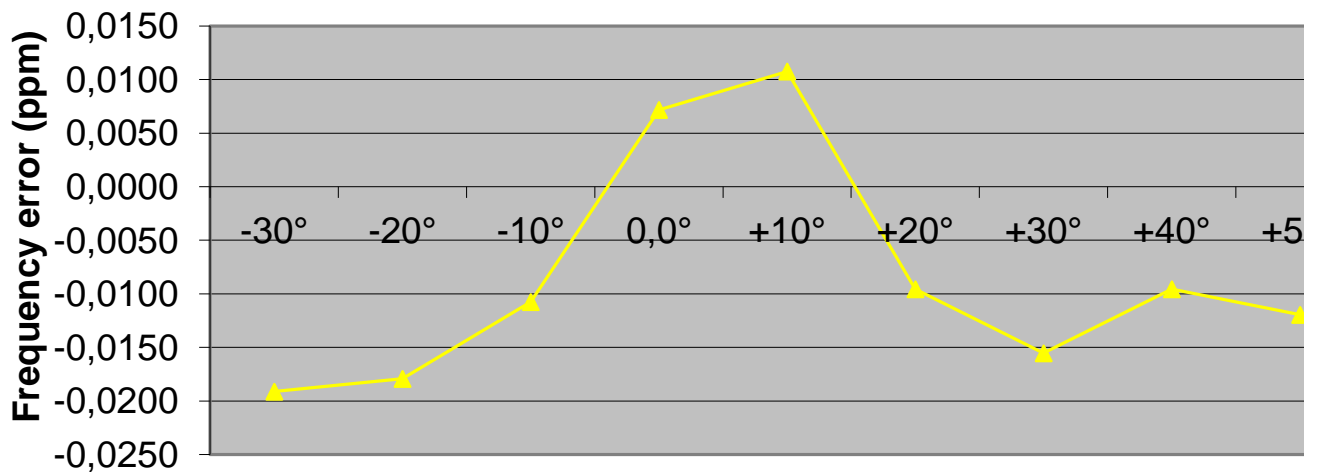

Result: Passed

8.4.3 Spurious emissions radiated

Description:

The following steps outline the procedure used to measure the radiated emissions from the mobile station. The site is constructed in accordance with ANSI C63.4:2009 requirements and is recognized by the FCC to be in compliance for a 3 and a 10 meter site. The spectrum was scanned from 30 MHz to the 10th harmonic of the highest frequency generated within the equipment, which is the transmitted carrier that can be as high as 846.6 MHz. This was rounded up to 12 GHz. The resolution bandwidth is set as outlined in Part 22.917. The spectrum was scanned with the mobile station transmitting at carrier frequencies that pertain to low, mid and high channels of the LTE band V.

The final open field emission (here 10m semi-anechoic chamber listed by FCC) test procedure is as follows:

- a) The test item was placed on a 0.8 meter high non-conductive stand at a 3 meter test distance from the receive antenna.
- b) The antenna output was terminated in a 50 ohm load (if possible).
- c) A double ridged wave guide antenna was placed on an adjustable height antenna mast 3 meters from the test item for emission measurements.
- d) Detected emissions were maximized at each frequency by rotating the test item and adjusting the receive antenna height and polarization. The maximum meter reading was recorded. The radiated emission measurements of the harmonics of the transmit frequency through the 10th harmonic were measured with peak detector and 1 MHz bandwidth. If the harmonic could not be detected above the noise floor, the ambient level was recorded. The equivalent power into a dipole antenna was calculated from the field intensity levels measured at 3 meters.
- e) Now each detected emissions were substituted by the substitution method, in accordance with the TIA/EIA 603.

Measurement:

Measurement parameters	
Detector:	Peak
Sweep time:	2 sec.
Video bandwidth:	Below 1 GHz: 100 kHz Above 1 GHz: 1 MHz
Resolution bandwidth:	Below 1 GHz: 100 kHz Above 1 GHz: 1 MHz
Span:	100 MHz Steps
Trace-Mode:	Max Hold

Limits:

FCC	IC
CFR Part 22.917 CFR Part 2.1053	RSS 132
Spurious Emissions Radiated	
Attenuation $\geq 43 + 10\log(P)$ (P, Power in Watts)	
-13 dBm	

Results:

Radiated emissions measurements were made only at the center carrier frequency of the LTE band V (836.5 MHz). It was decided that measurements at this carrier frequency would be sufficient to demonstrate compliance with emissions limits because it was seen that all the significant spurs occur well outside the band and no radiation was seen from a carrier in one block of the LTE band V into any of the other blocks. The equipment must still, however, meet emissions requirements with the carrier at all frequencies over which it is capable of operating and it is the manufacturer's responsibility to verify this.

The final open field radiated levels are presented on the next pages. All measurements were done in horizontal and vertical polarization; the plots show the worst case. The plots show only the middle channel. If spurious were detected, the lowest and highest channel were checked too. The found values are stated in the table below.

As can be seen from this data, the emissions from the test item were within the specification limit.

QPSK:

SPURIOUS EMISSION LEVEL (dBm)								
Harmonic	Lowest channel Freq. (MHz)	Level [dBm]	Harmonic	Middle channel Freq. (MHz)	Level [dBm]	Harmonic	Highest channel Freq. (MHz)	Level [dBm]
2	1658.0	No peaks detected!	2	1673.0	No peaks detected!	2	1688.0	No peaks detected!
3	2487.0		3	2509.5		3	2532.0	
4	3316.0		4	3346.0		4	3376.0	
5	4145.0		5	4182.5		5	4220.0	
6	4974.0		6	5019.0		6	5064.0	
7	5803.0		7	5855.5		7	5908.0	
8	6632.0		8	6692.0		8	6752.0	
9	7461.0		9	7528.5		9	7596.0	
10	8290.0		10	8365.0		10	8440.0	
Measurement uncertainty						± 3dB		

16-QAM:

SPURIOUS EMISSION LEVEL (dBm)								
Harmonic	Lowest channel Freq. (MHz)	Level [dBm]	Harmonic	Middle channel Freq. (MHz)	Level [dBm]	Harmonic	Highest channel Freq. (MHz)	Level [dBm]
2	1658.0	No peaks detected!	2	1673.0	No peaks detected!	2	1688.0	No peaks detected!
3	2487.0		3	2509.5		3	2532.0	
4	3316.0		4	3346.0		4	3376.0	
5	4145.0		5	4182.5		5	4220.0	
6	4974.0		6	5019.0		6	5064.0	
7	5803.0		7	5855.5		7	5908.0	
8	6632.0		8	6692.0		8	6752.0	
9	7461.0		9	7528.5		9	7596.0	
10	8290.0		10	8365.0		10	8440.0	
Measurement uncertainty						± 3dB		

Result: Passed

QPSK with 10 MHz channel bandwidth

Plot 1: Channel 20525 (Traffic mode up to 30 MHz)

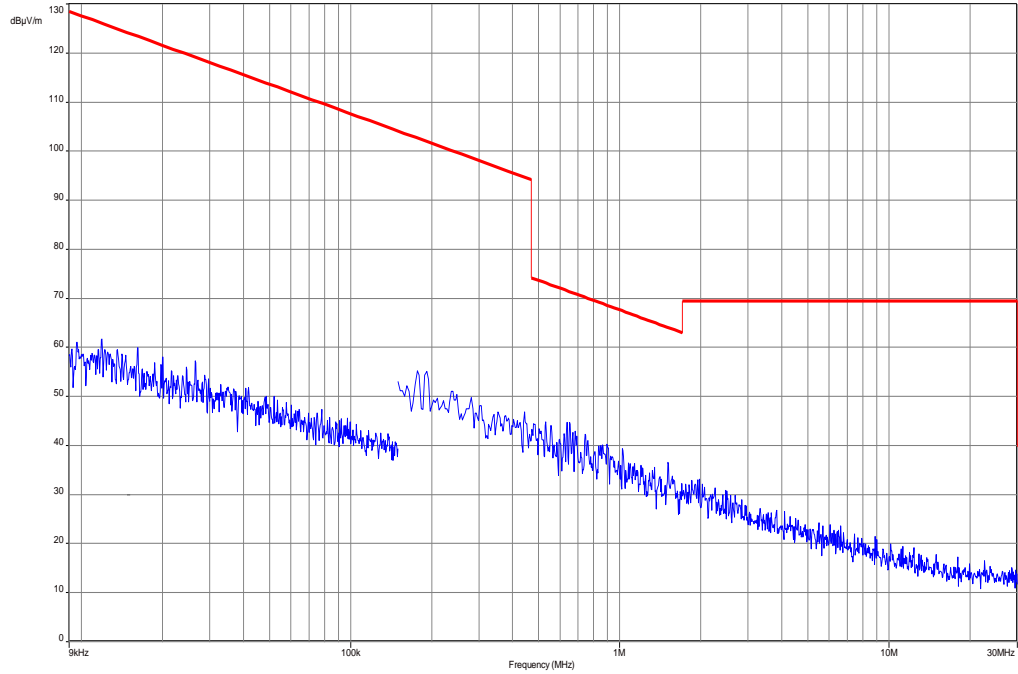

Plot 2: Channel 20525 (30 MHz – 12.75 GHz)

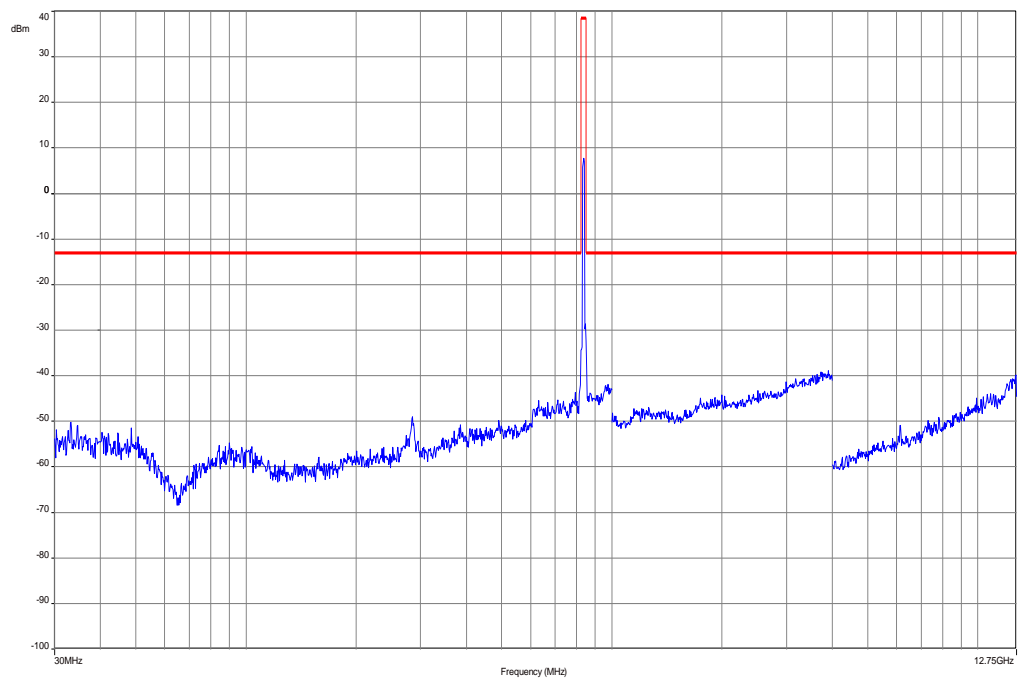

16-QAM with 10 MHz channel bandwidth

Plot 3: Channel 20525 (Traffic mode up to 30 MHz)

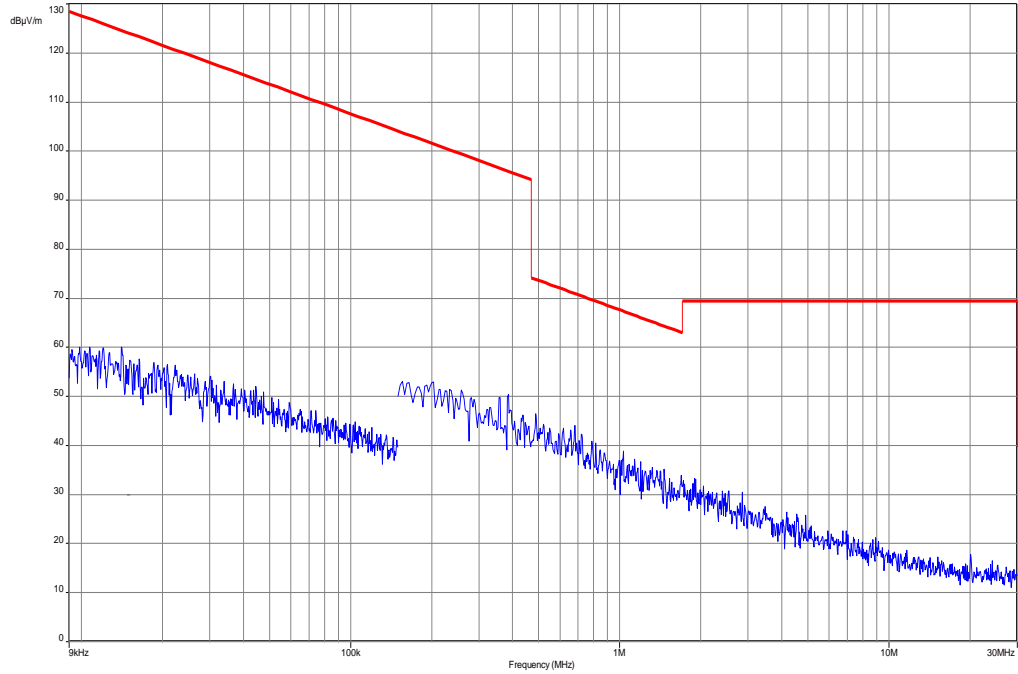

Plot 4: Channel 20525 (30 MHz – 12.75 GHz)

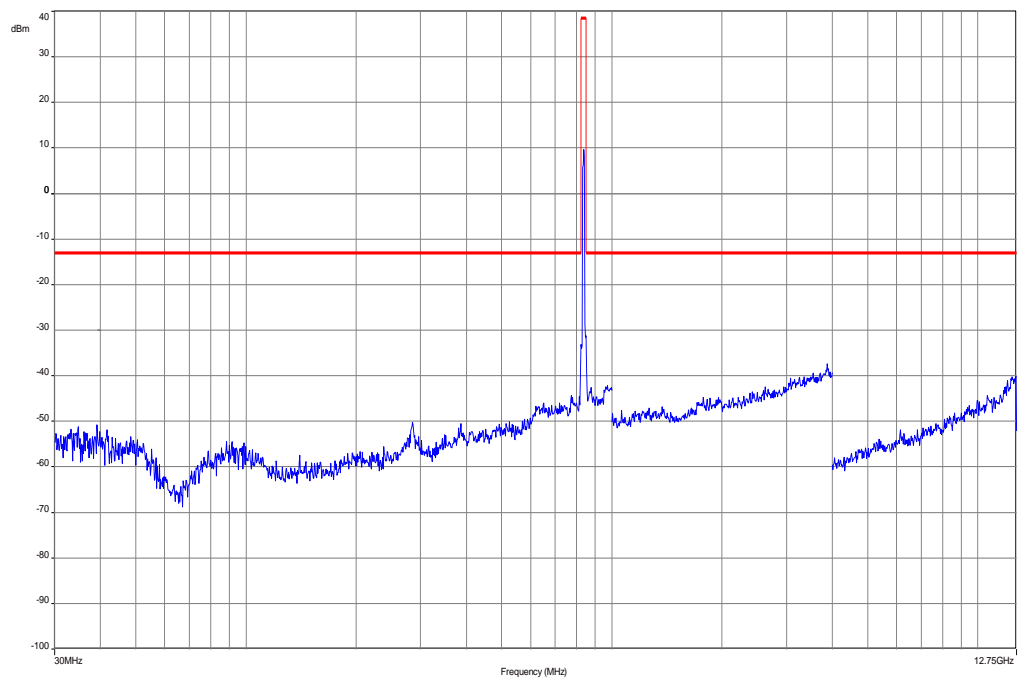

8.4.4 Spurious emissions conducted

Description:

The following steps outline the procedure used to measure the conducted emissions from the mobile station.

1. Determine frequency range for measurements: From CFR 2.1057 the spectrum should be investigated from the lowest radio frequency generated in the equipment up to at least the 10th harmonic of the carrier frequency. For the mobile station equipment tested, this equates to a frequency range of 13 MHz to 9 GHz, data taken from 10 MHz to 25 GHz.
2. Determine mobile station transmits frequencies: below outlines the band edge frequencies pertinent to conducted emissions testing.

Measurement:

Measurement parameters	
Detector:	Peak
Sweep time:	Auto
Video bandwidth:	Pre-measurement with 1 MHz On spurious detection re-measurement below 1 GHz with 100 kHz Above 1 GHz with 1 MHz
Resolution bandwidth:	Pre-measurement with 1 MHz On spurious detection re-measurement below 1 GHz with 100 kHz Above 1 GHz with 1 MHz
Span:	10 MHz – 25 GHz
Trace-Mode:	Max Hold

Limits:

FCC	IC
CFR Part 22.917 CFR Part 2.1051	RSS 132
Spurious Emissions Conducted	
Attenuation $\geq 43 + 10\log(P)$ (P, Power in Watts)	
-13 dBm	

Results: for 1.4 MHz channel bandwidth

QPSK

SPURIOUS EMISSION LEVEL (dBm)								
Harmonic	Lowest channel Freq. (MHz)	Level [dBm]	Harmonic	Middle channel Freq. (MHz)	Level [dBm]	Harmonic	Highest channel Freq. (MHz)	Level [dBm]
2	1649.4	No peaks detected!	2	1673.0	No peaks detected!	2	1696,6	No peaks detected!
3	2474.1		3	2509.5		3	2544,9	
4	3298.8		4	3346.0		4	3393,2	
5	4123.5		5	4182.5		5	4241,5	
6	4948.2		6	5019.0		6	5089,8	
7	5772.9		7	5855.5		7	5938,1	
8	6597.6		8	6692.0		8	6786,4	
9	7422.3		9	7258.5		9	7634,7	
10	8247.0		10	8365.0		10	8483	
Measurement uncertainty						± 0.5dB		

16-QAM

SPURIOUS EMISSION LEVEL (dBm)								
Harmonic	Lowest channel Freq. (MHz)	Level [dBm]	Harmonic	Middle channel Freq. (MHz)	Level [dBm]	Harmonic	Highest channel Freq. (MHz)	Level [dBm]
2	1649.4	No peaks detected!	2	1673.0	No peaks detected!	2	1696.6	No peaks detected!
3	2474.1		3	2509.5		3	2544.9	
4	3298.8		4	3346.0		4	3393.2	
5	4123.5		5	4182.5		5	4241.5	
6	4948.2		6	5019.0		6	5089.8	
7	5772.9		7	5855.5		7	5938.1	
8	6597.6		8	6692.0		8	6786.4	
9	7422.3		9	7258.5		9	7634.7	
10	8247.0		10	8365.0		10	8483.0	
Measurement uncertainty						± 0.5dB		

Results: for 5 MHz channel bandwidth

QPSK

SPURIOUS EMISSION LEVEL (dBm)								
Harmonic	Lowest channel Freq. (MHz)	Level [dBm]	Harmonic	Middle channel Freq. (MHz)	Level [dBm]	Harmonic	Highest channel Freq. (MHz)	Level [dBm]
2	1653.0	No peaks detected!	2	1673.0	No peaks detected!	2	1693.0	No peaks detected!
3	2479.5		3	2509.5		3	2539.5	
4	3306.0		4	3346.0		4	3386.0	
5	4132.5		5	4182.5		5	4232.5	
6	4959.0		6	5019.0		6	5079.0	
7	5785.5		7	5855.5		7	5925.5	
8	6612.0		8	6692.0		8	6772.0	
9	7438.5		9	7528.5		9	7618.5	
10	8265.0		10	8365.0		10	8465.0	
Measurement uncertainty						± 0.5dB		

16-QAM

SPURIOUS EMISSION LEVEL (dBm)								
Harmonic	Lowest channel Freq. (MHz)	Level [dBm]	Harmonic	Middle channel Freq. (MHz)	Level [dBm]	Harmonic	Highest channel Freq. (MHz)	Level [dBm]
2	1653.0	No peaks detected!	2	1673.0	No peaks detected!	2	1693.0	No peaks detected!
3	2479.5		3	2509.5		3	2539.5	
4	3306.0		4	3346.0		4	3386.0	
5	4132.5		5	4182.5		5	4232.5	
6	4959.0		6	5019.0		6	5079.0	
7	5785.5		7	5855.5		7	5925.5	
8	6612.0		8	6692.0		8	6772.0	
9	7438.5		9	7528.5		9	7618.5	
10	8265.0		10	8365.0		10	8465.0	
Measurement uncertainty						± 0.5dB		

Results: for 10 MHz channel bandwidth

QPSK

SPURIOUS EMISSION LEVEL (dBm)								
Harmonic	Lowest channel Freq. (MHz)	Level [dBm]	Harmonic	Middle channel Freq. (MHz)	Level [dBm]	Harmonic	Highest channel Freq. (MHz)	Level [dBm]
2	1658.0	No peaks detected!	2	1673.0	No peaks detected!	2	1688.0	No peaks detected!
3	2487.0		3	2509.5		3	2532.0	
4	3316.0		4	3346.0		4	3376.0	
5	4145.0		5	4182.5		5	4220.0	
6	4974.0		6	5019.0		6	5064.0	
7	5803.0		7	5855.5		7	5908.0	
8	6632.0		8	6692.0		8	6752.0	
9	7461.0		9	7528.5		9	7596.0	
10	8290.0		10	8365.0		10	8440.0	
Measurement uncertainty						± 0.5dB		

16-QAM

SPURIOUS EMISSION LEVEL (dBm)								
Harmonic	Lowest channel Freq. (MHz)	Level [dBm]	Harmonic	Middle channel Freq. (MHz)	Level [dBm]	Harmonic	Highest channel Freq. (MHz)	Level [dBm]
2	1658.0	No peaks detected!	2	1673.0	No peaks detected!	2	1688.0	No peaks detected!
3	2487.0		3	2509.5		3	2532.0	
4	3316.0		4	3346.0		4	3376.0	
5	4145.0		5	4182.5		5	4220.0	
6	4974.0		6	5019.0		6	5064.0	
7	5803.0		7	5855.5		7	5908.0	
8	6632.0		8	6692.0		8	6752.0	
9	7461.0		9	7528.5		9	7596.0	
10	8290.0		10	8365.0		10	8440.0	
Measurement uncertainty						± 0.5dB		

Result: Passed

Plots: QPSK with 1.4 MHz channel bandwidth

Plot 1: Lowest Channel (10 MHz - 25 GHz)

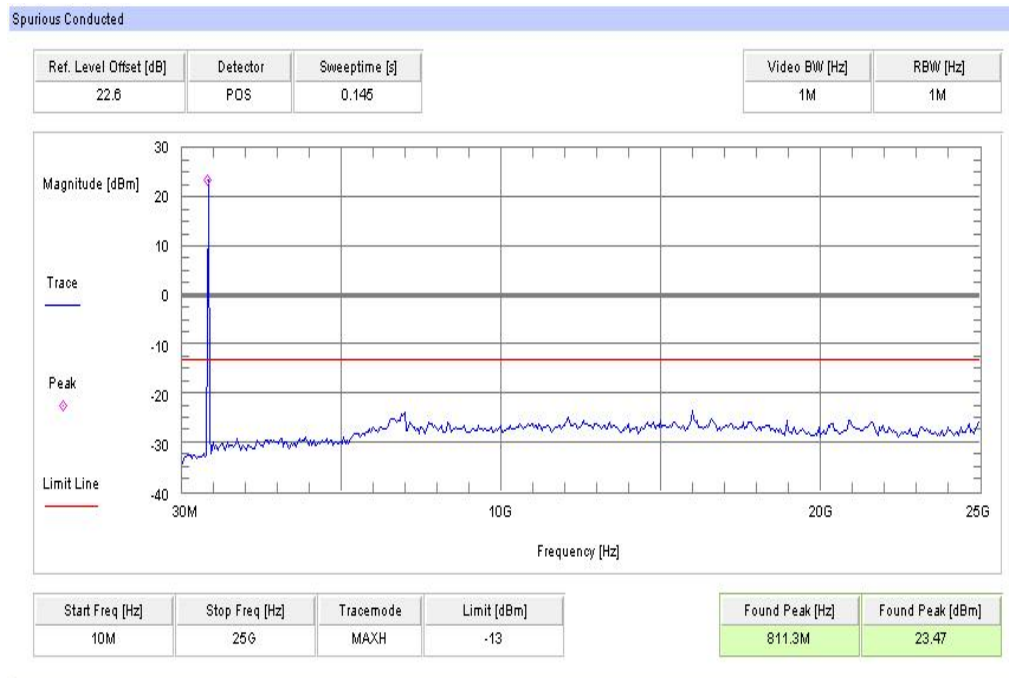

Plot 2: Middle Channel (10 MHz - 25 GHz)

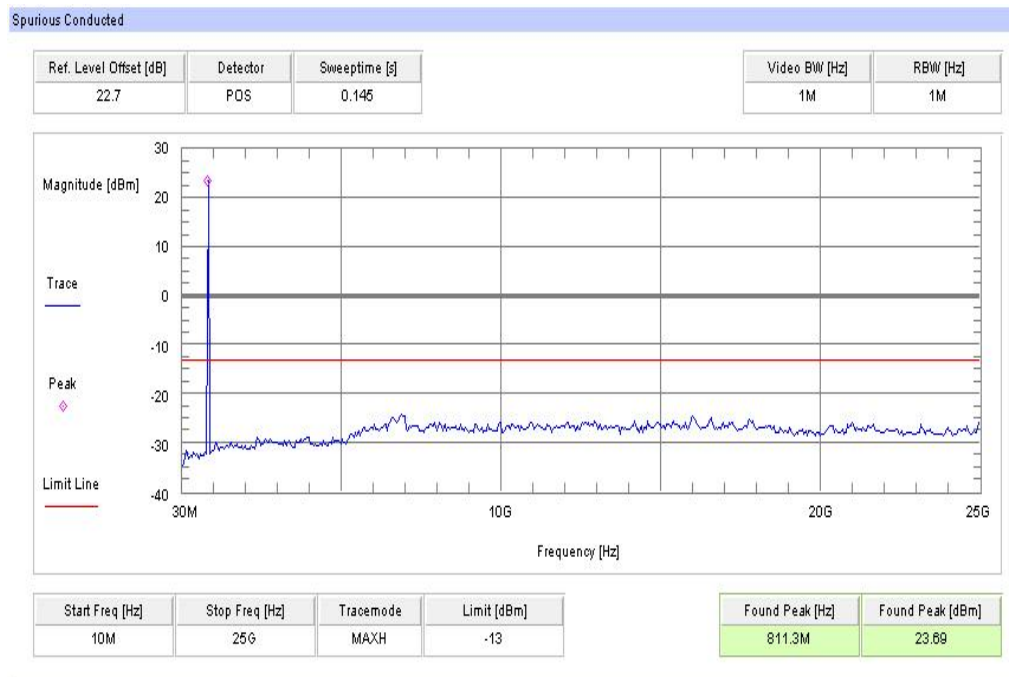

Plot 3: Highest Channel (10 MHz - 25 GHz)

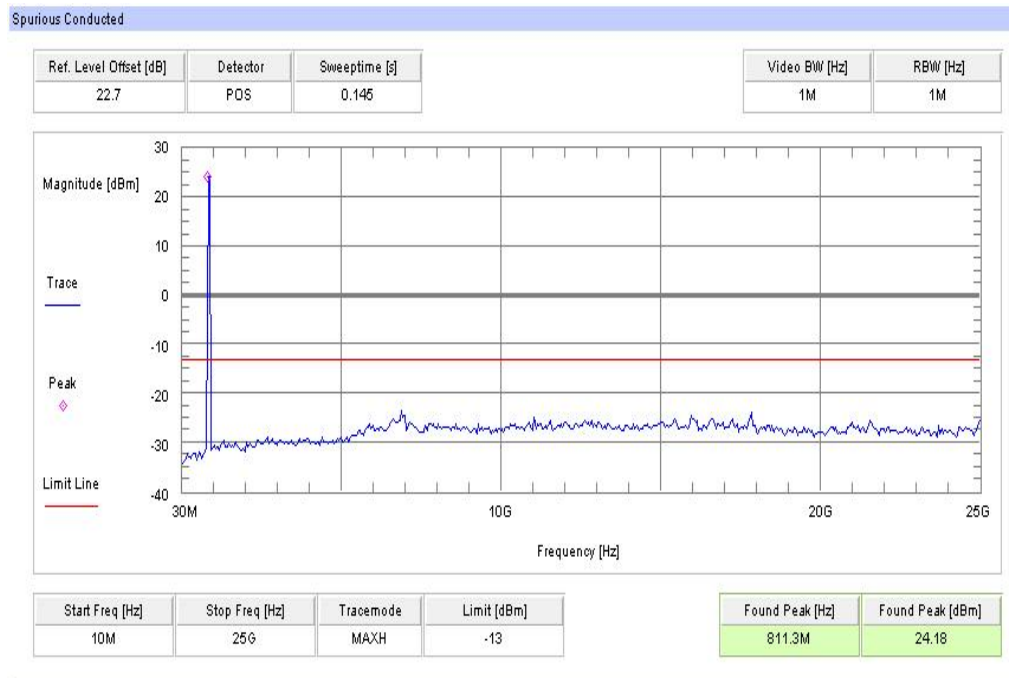

Plots: 16-QAM with 1.4 MHz channel bandwidth

Plot 4: Lowest Channel (10 MHz - 25 GHz)

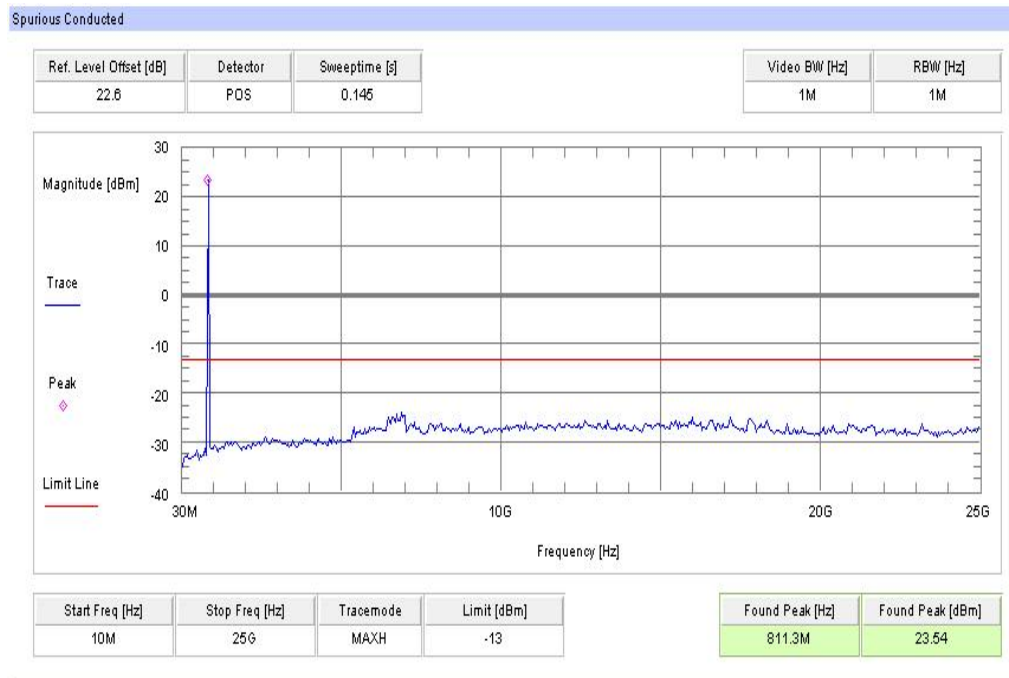

Plot 5: Middle Channel (10 MHz - 25 GHz)

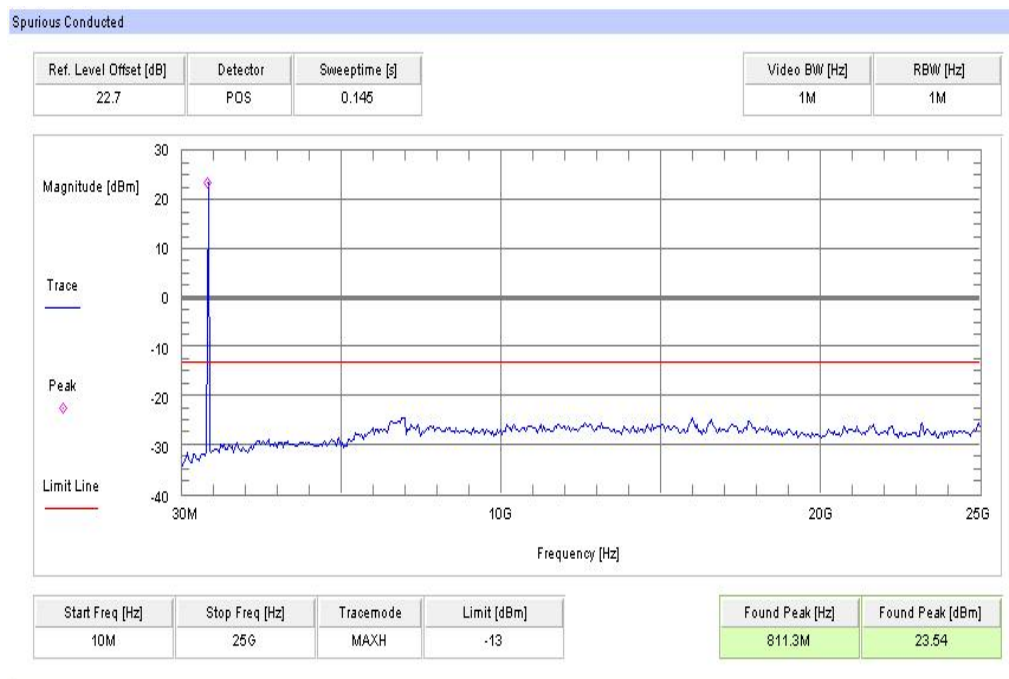

Plot 6: Highest Channel (10 MHz - 25 GHz)

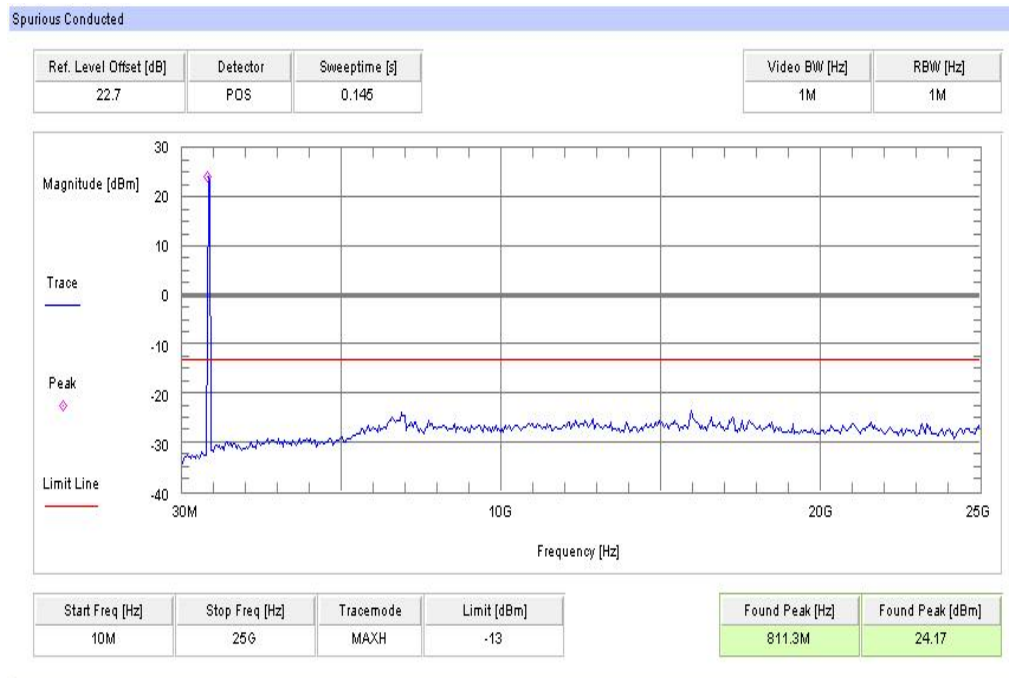

Plots: QPSK with 3 MHz channel bandwidth

Plot 1: Lowest Channel (10 MHz - 25 GHz)

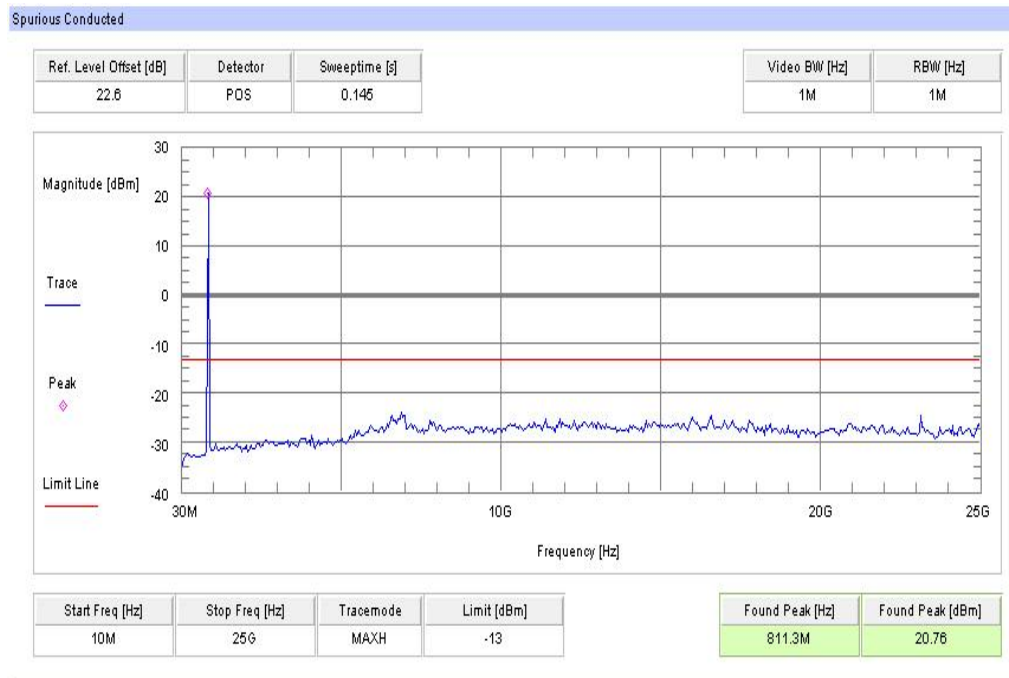

Plot 2: Middle Channel (10 MHz - 25 GHz)

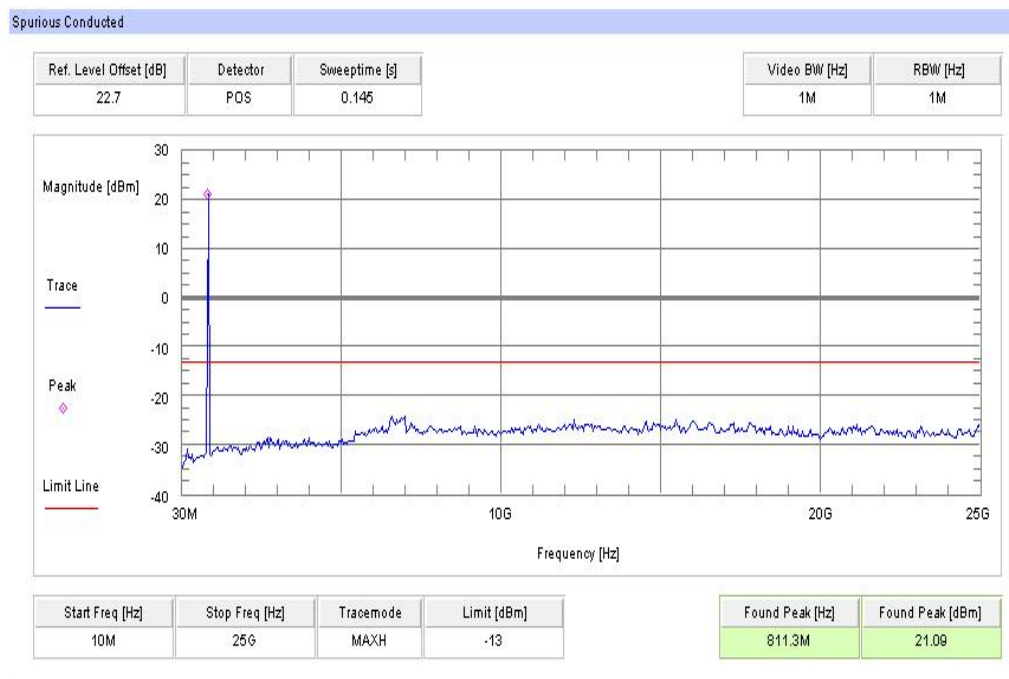

Plot 3: Highest Channel (10 MHz - 25 GHz)

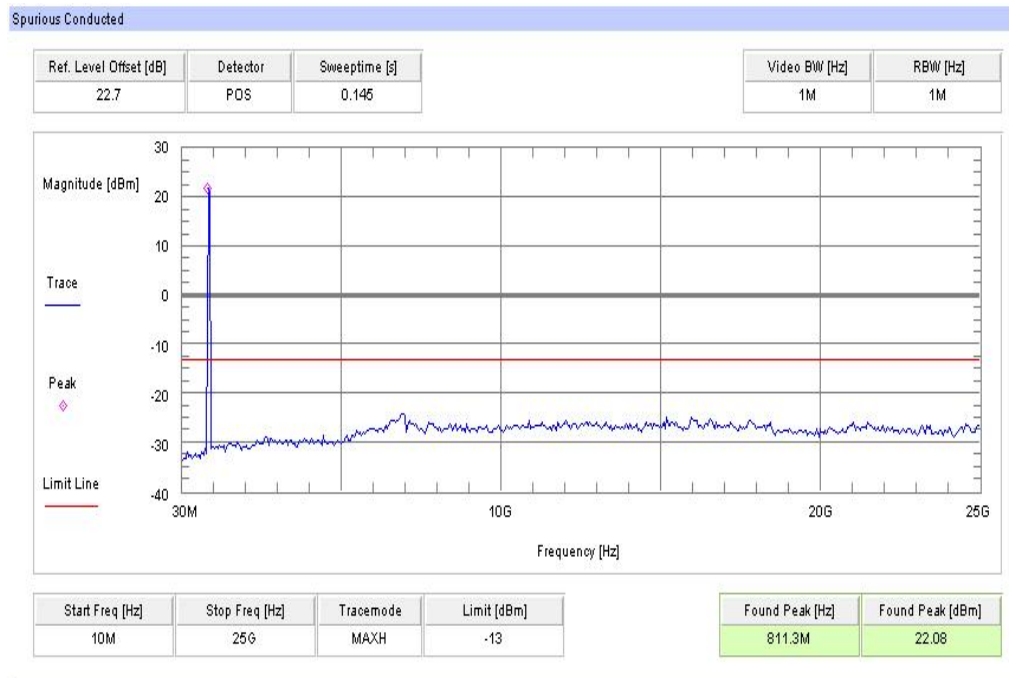

Plots: 16-QAM with 3 MHz channel bandwidth

Plot 4: Lowest Channel (10 MHz - 25 GHz)

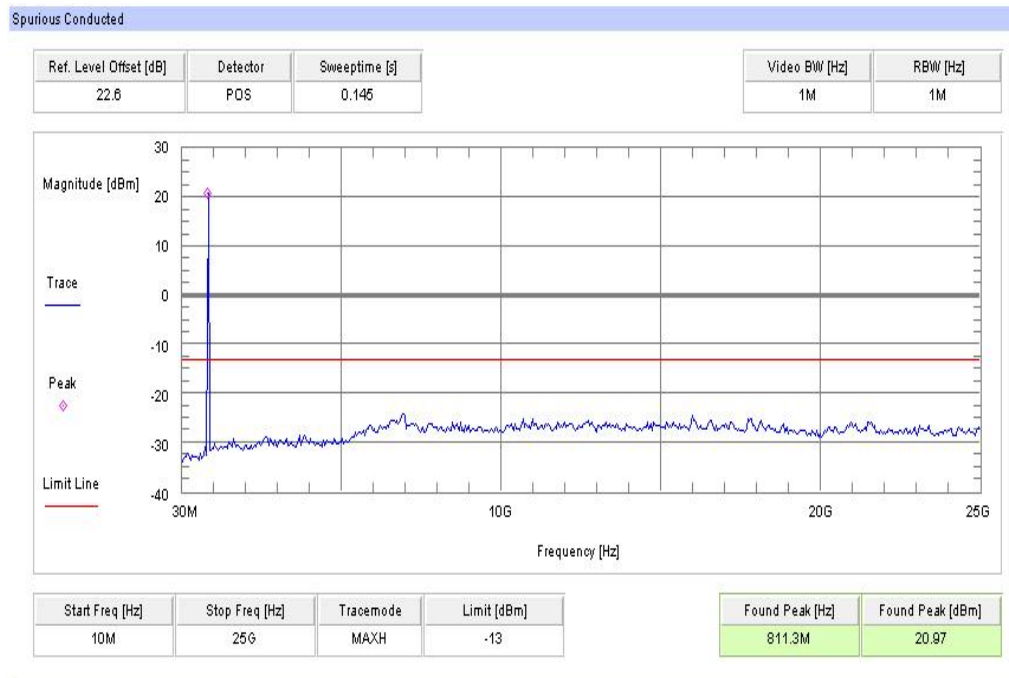

Plot 5: Middle Channel (10 MHz - 25 GHz)

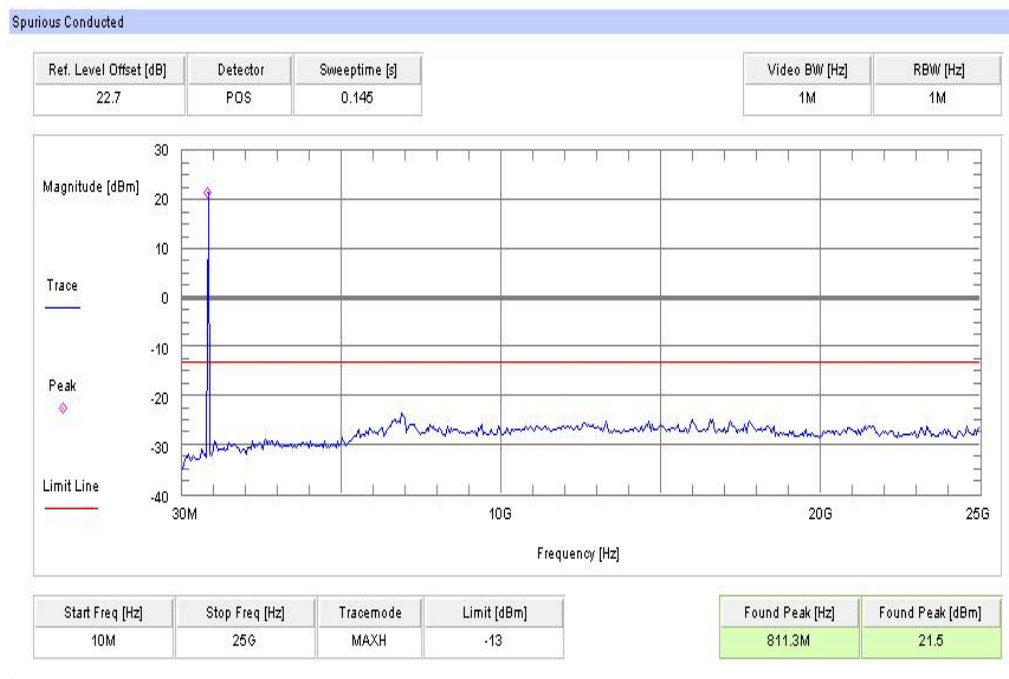

Plot 6: Highest Channel (10 MHz - 25 GHz)

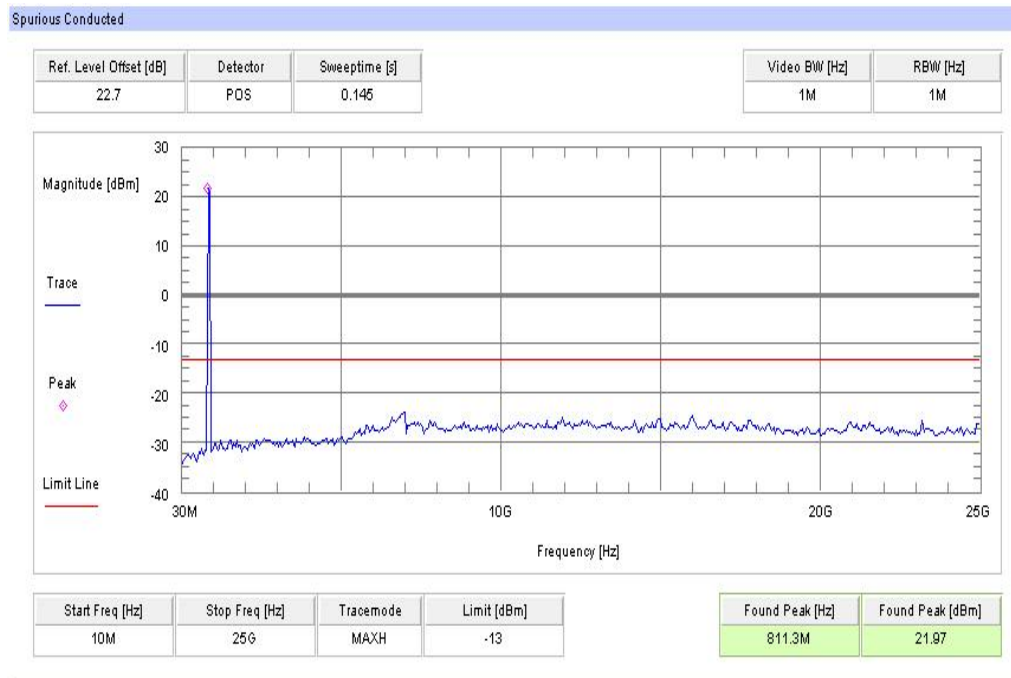

Plots: QPSK with 5 MHz channel bandwidth

Plot 1: Lowest Channel (10 MHz - 25 GHz)

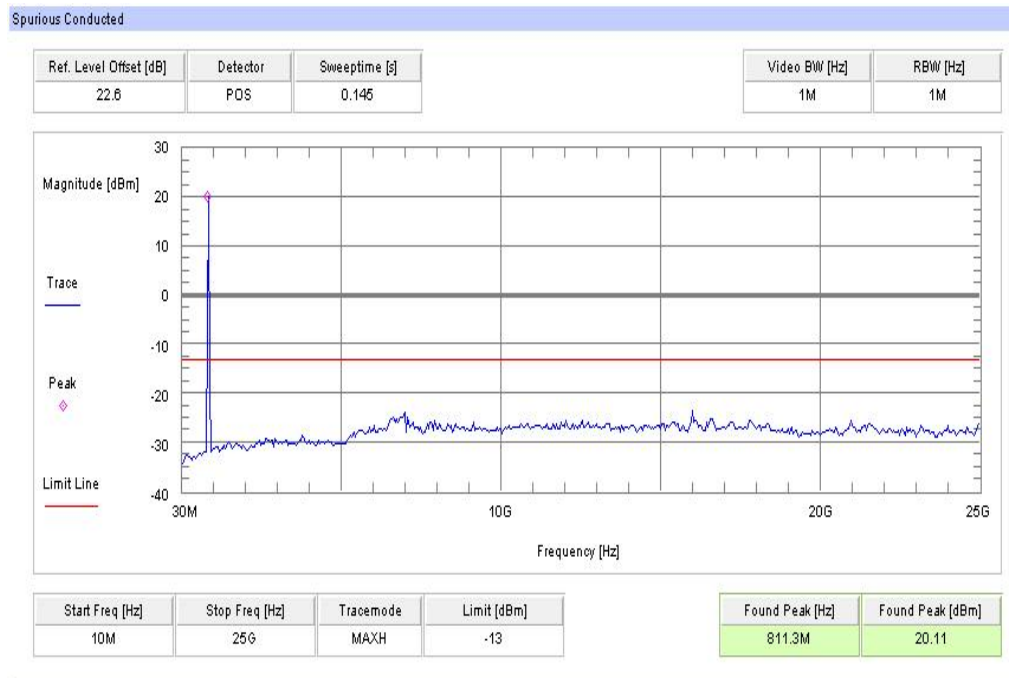

Plot 2: Middle Channel (10 MHz - 25 GHz)

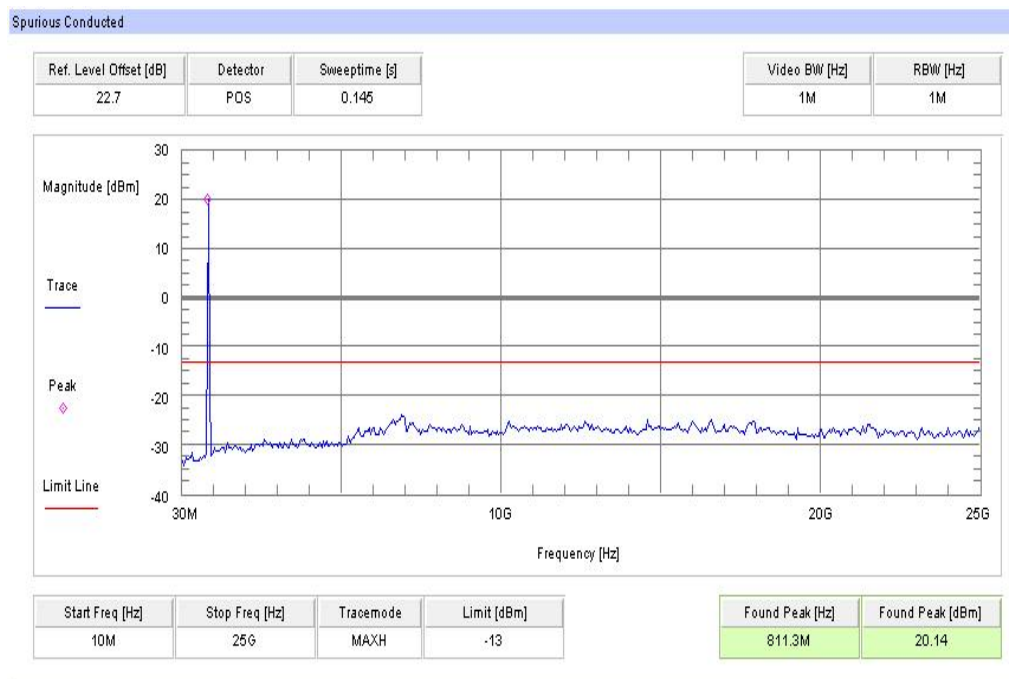

Plot 3: Highest Channel (10 MHz - 25 GHz)

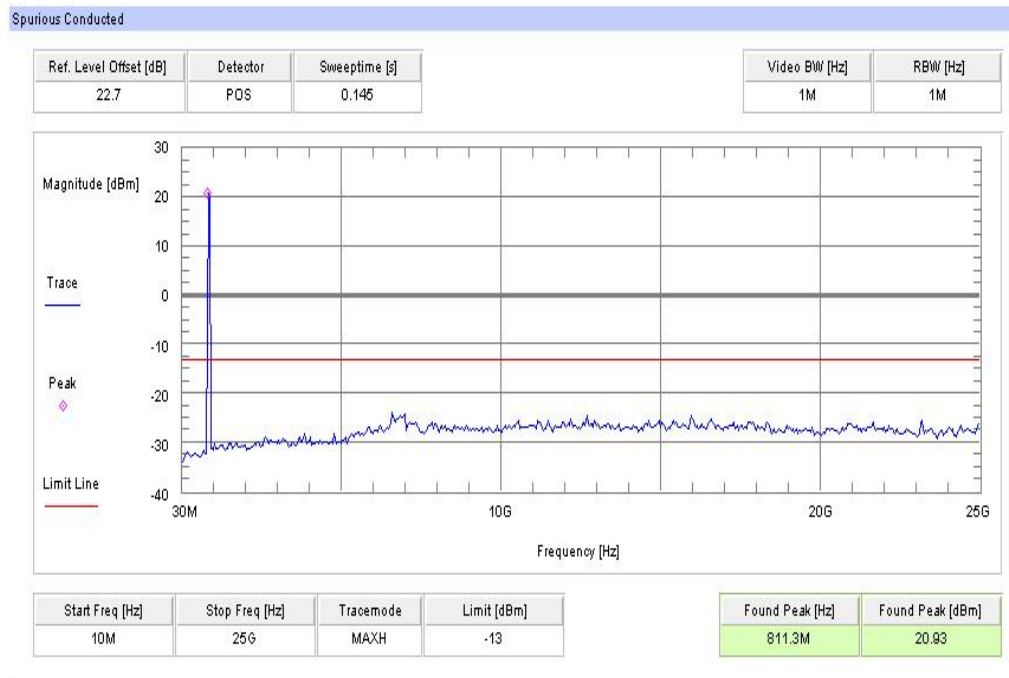

Plots: 16-QAM with 5 MHz channel bandwidth

Plot 4: Lowest Channel (10 MHz - 25 GHz)

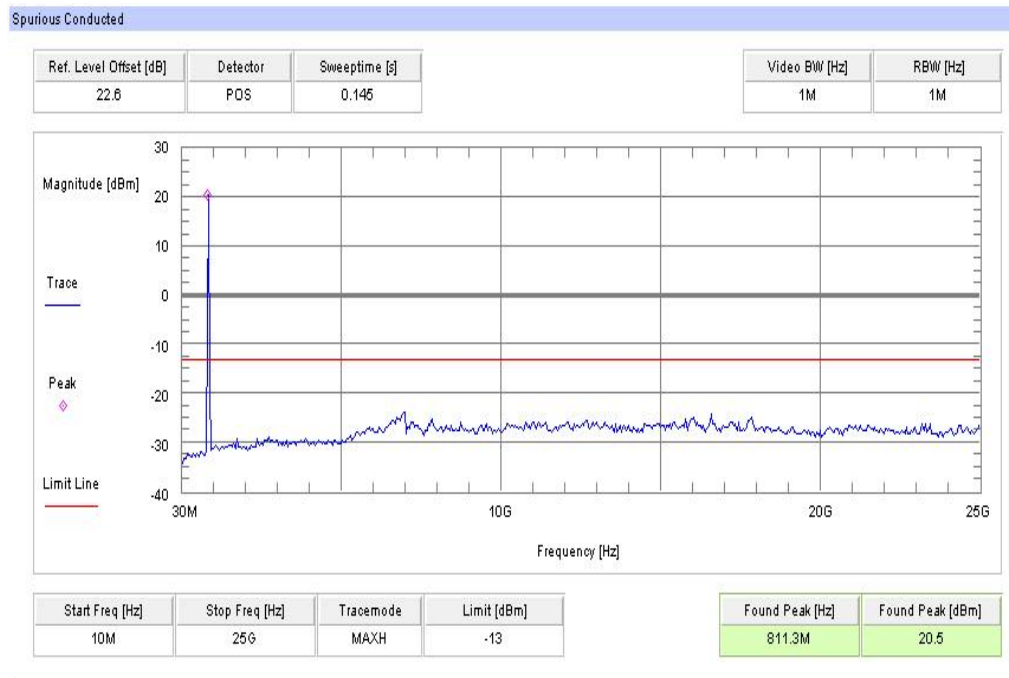

Plot 5: Middle Channel (10 MHz - 25 GHz)

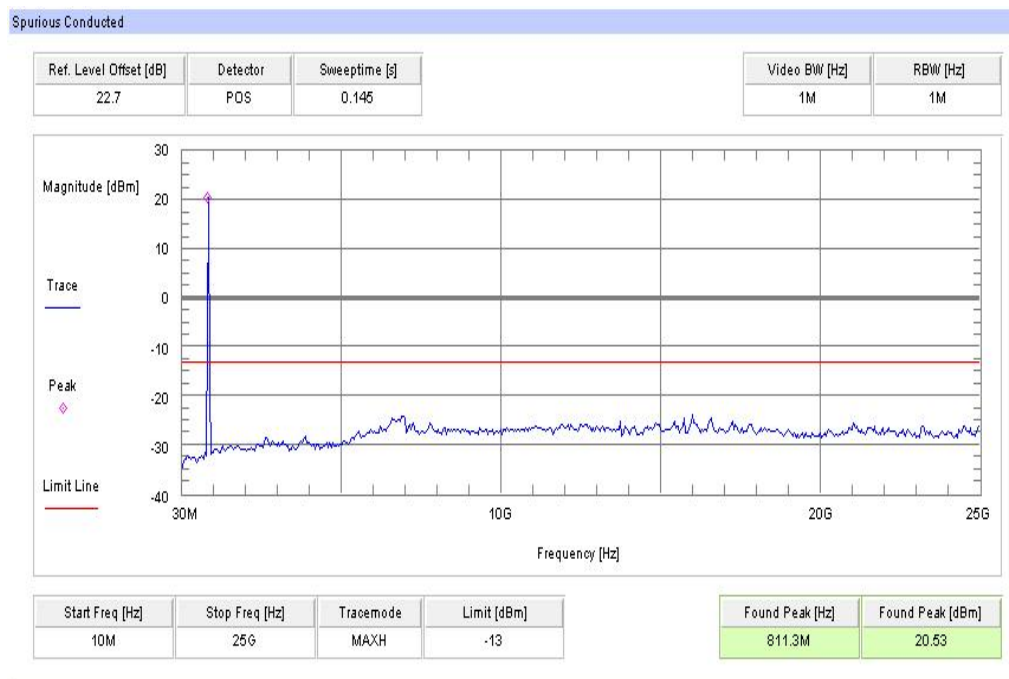

Plot 6: Highest Channel (10 MHz - 25 GHz)

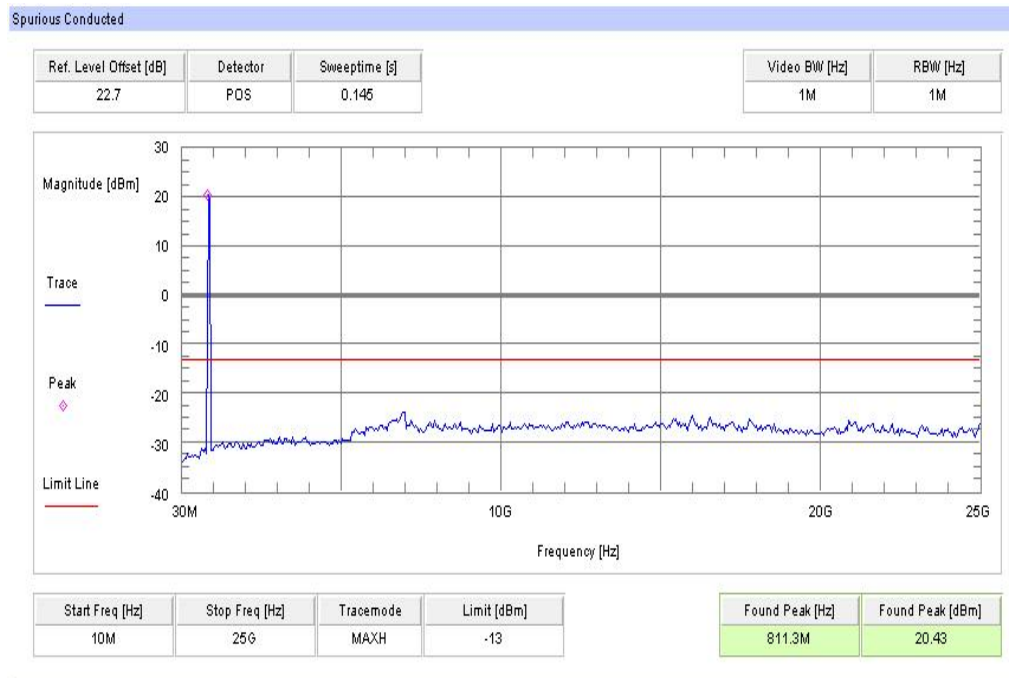

Plots: QPSK with 10 MHz channel bandwidth

Plot 1: Lowest Channel (10 MHz - 25 GHz)

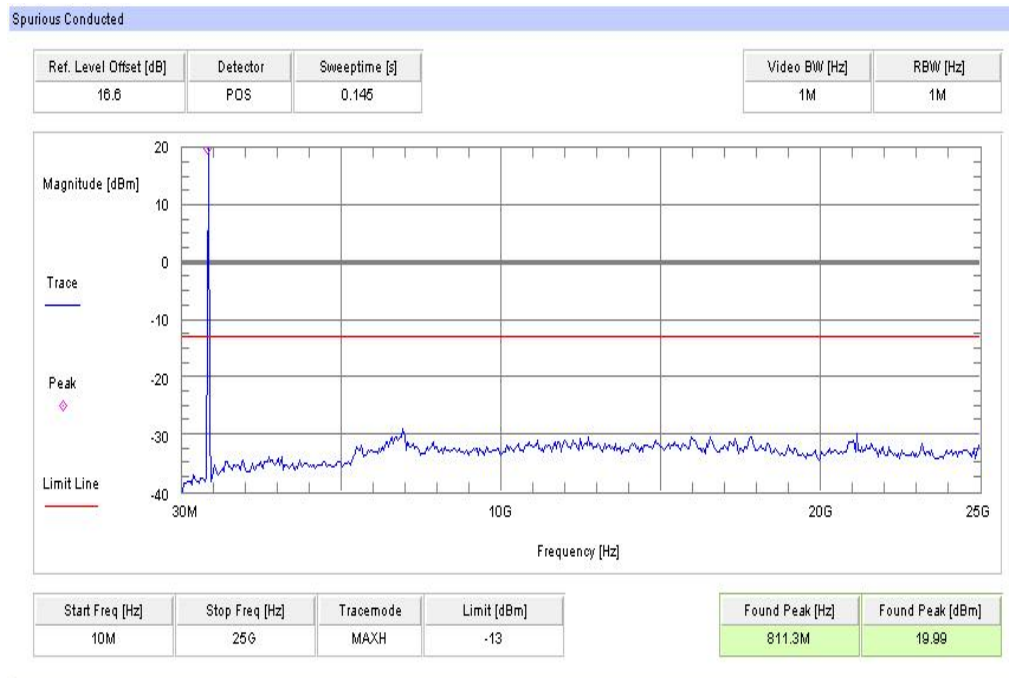

Plot 2: Middle Channel (10 MHz - 25 GHz)

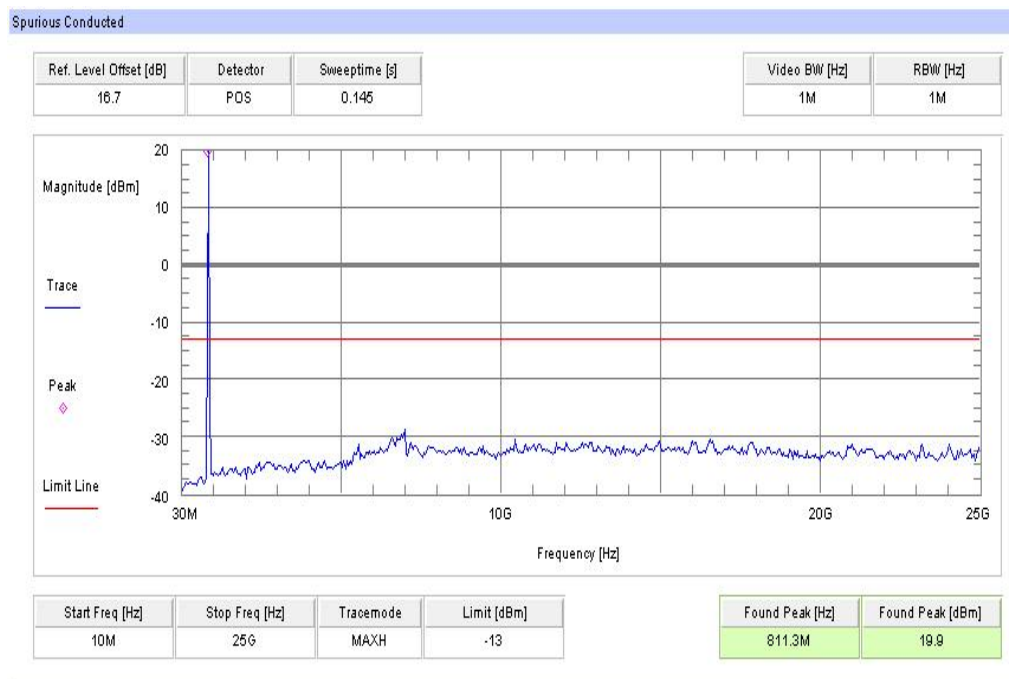

Plot 3: Highest Channel (10 MHz - 25 GHz)

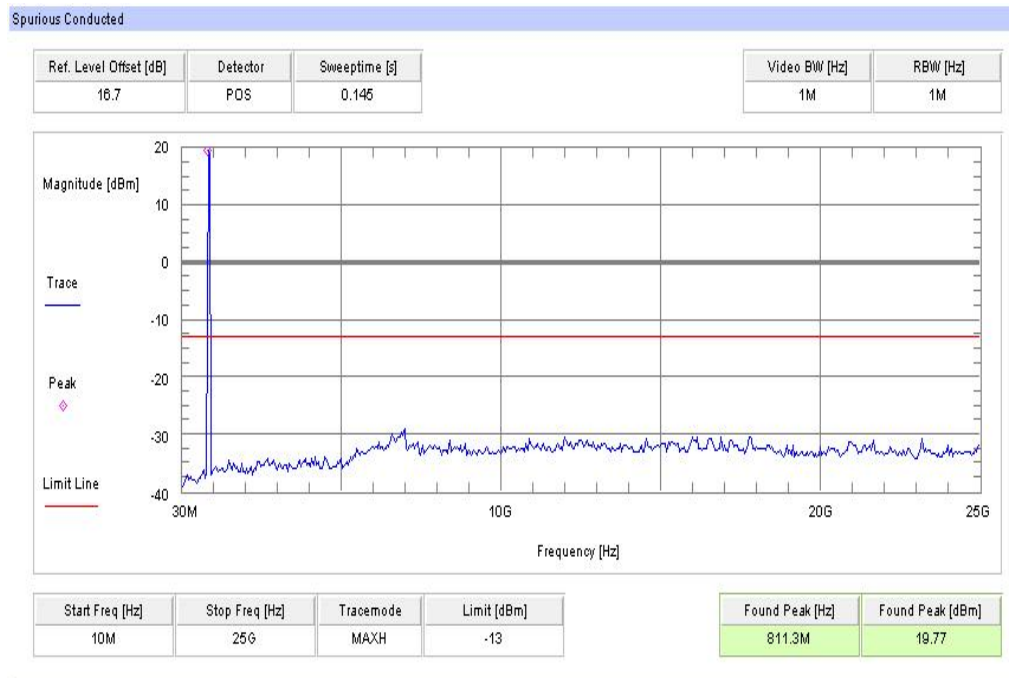

Plots: 16-QAM with 10 MHz channel bandwidth

Plot 4: Lowest Channel (10 MHz - 25 GHz)

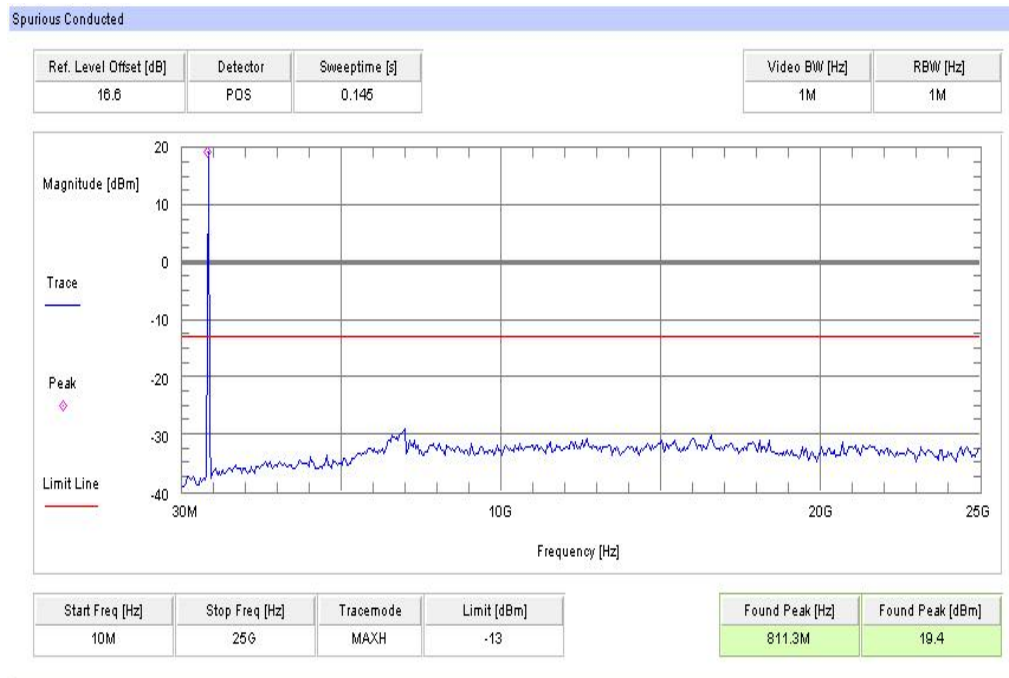

Plot 5: Middle Channel (10 MHz - 25 GHz)

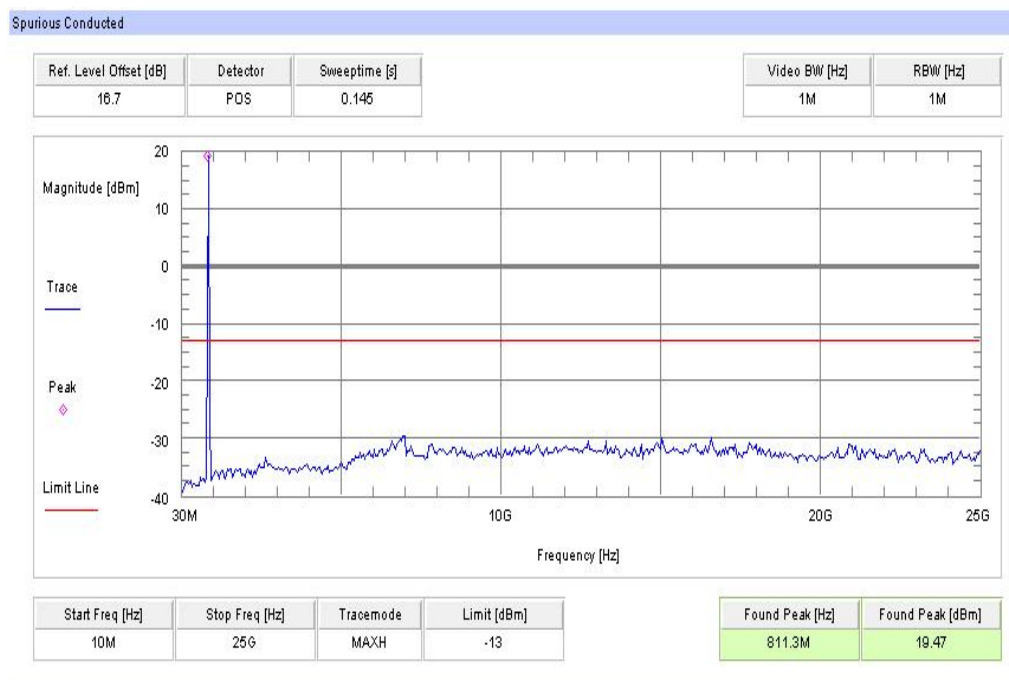

Plot 6: Highest Channel (10 MHz - 25 GHz)

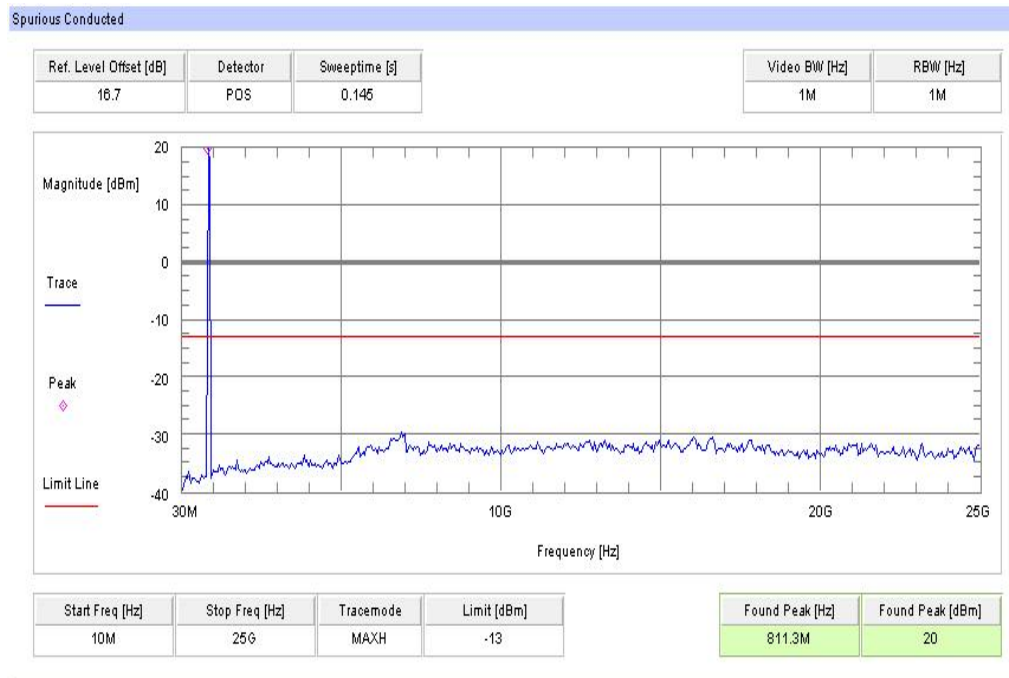

8.4.5 Block edge compliance

Description:

The spectrum at the band edges must comply with the spurious emissions limits.

Measurement:

Measurement parameters	
Detector:	RMS
Sweep time:	60 s
Video bandwidth:	30 kHz
Resolution bandwidth:	30 kHz
Span:	1 MHz
Trace-Mode:	Max Hold

Limits:

FCC	IC
CFR Part 22.917 CFR Part 2.1051	RSS 132
Block Edge Compliance	
<p>Part 22.917 specifies that “the power of any emission outside of the authorized operating frequency ranges must be attenuated below the transmitting power (P) by a factor of at least 43 + 10 log(P) dB.”</p> <p>However, in publication number 890810, The FCC Office of Engineering and Technology specified the following correction to the limits when a resolution bandwidth smaller than 1% of the emission bandwidth is used:</p> <p>“An alternative is to add an additional correction factor of 10 Log (RBW1/ RBW2) to the 43 +10 log(P) limit. RBW1 is the narrower measurement resolution bandwidth and RBW2 is either the 1% emissions bandwidth or 1 MHz.”</p> <p>When using a 30 kHz bandwidth, this yields a -5.23 adjustment to the limit [10 log(30kHz/100kHz) = -5.23]. When this adjustment is applied to the limit, the limit becomes -18.23 dBm.</p>	
-18.23 dBm	

Results: 1.4 MHz channel bandwidth

Plot 1: Lowest channel – QPSK

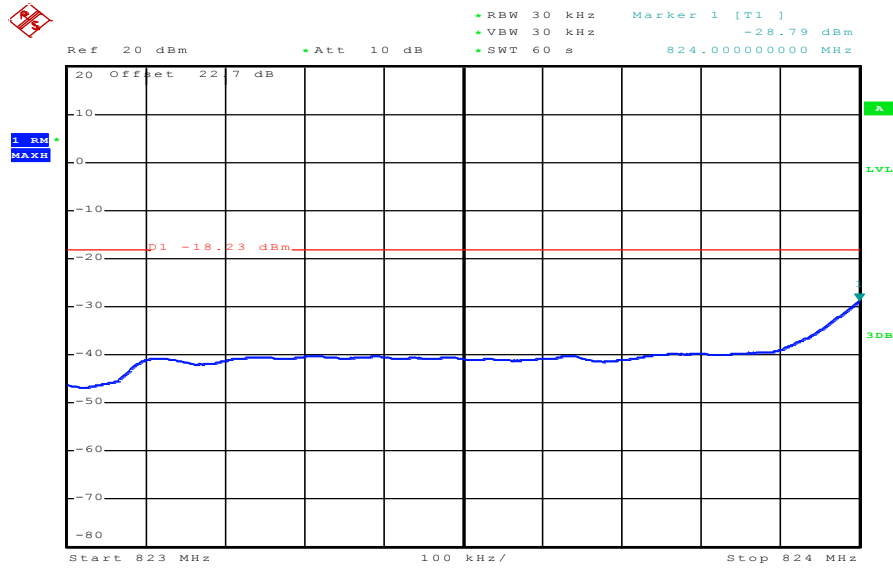

Date: 27.NOV.2012 13:44:18

Plot 2: Highest channel – QPSK

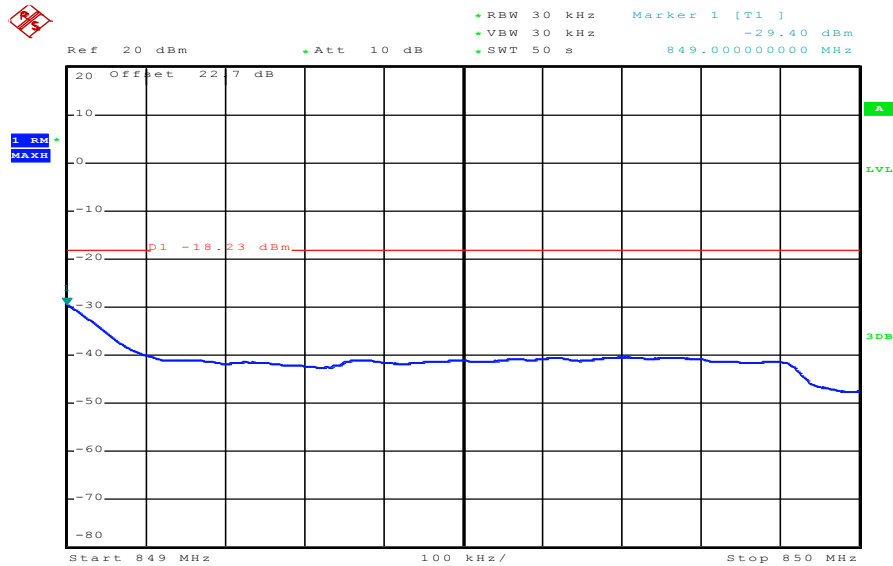

Date: 27.NOV.2012 13:48:02

Plot 3: Lowest channel – 16-QAM

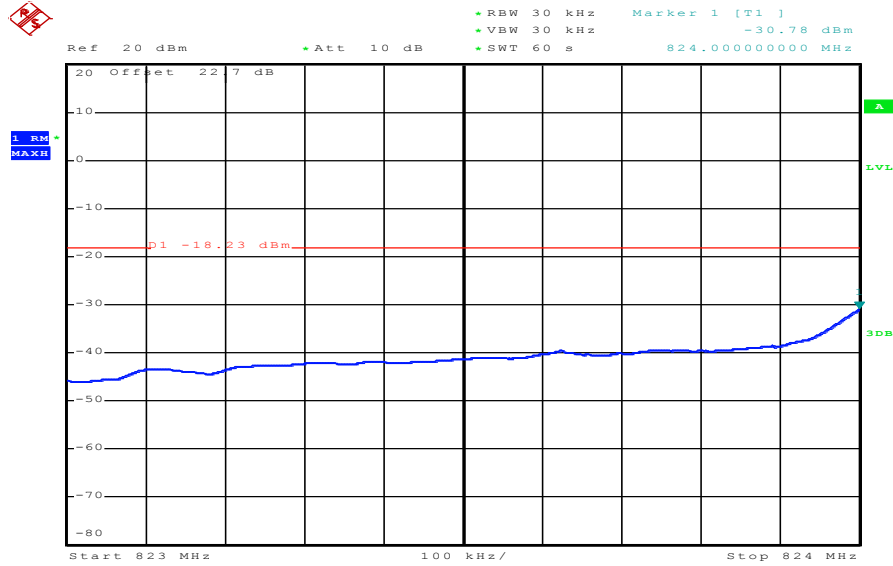

Date: 27.NOV.2012 13:42:44

Plot 4: Highest channel – 16-QAM

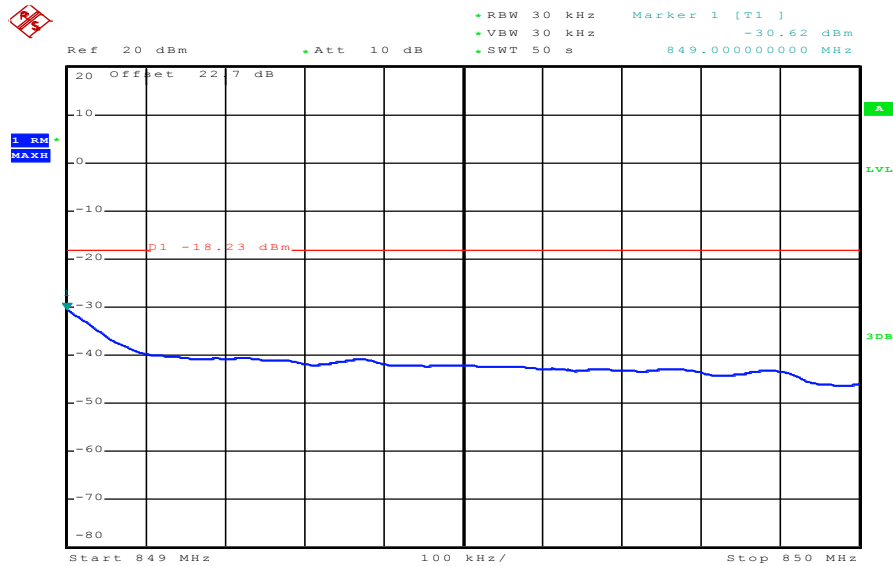

Date: 27.NOV.2012 13:49:33

Results: 3 MHz channel bandwidth

Plot 1: Lowest channel – QPSK

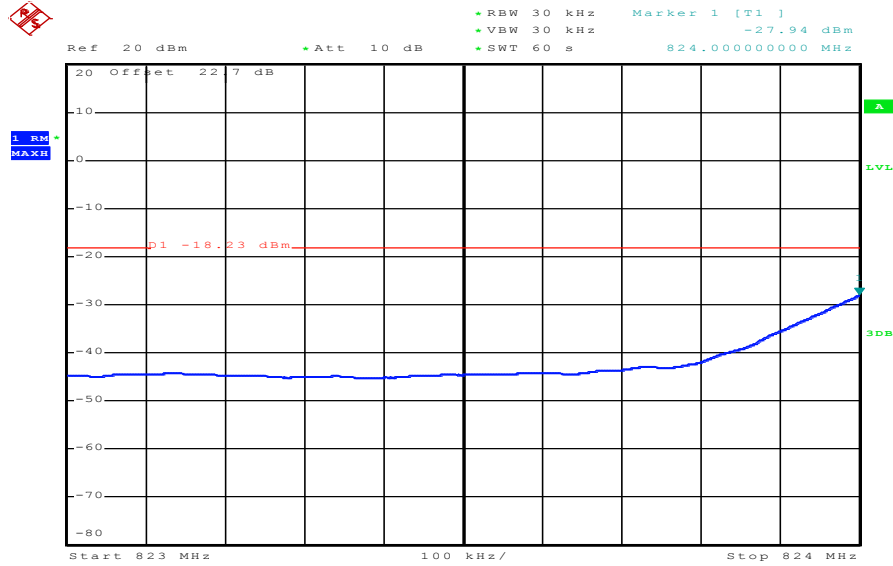

Date: 27.NOV.2012 12:29:18

Plot 2: Highest channel – QPSK

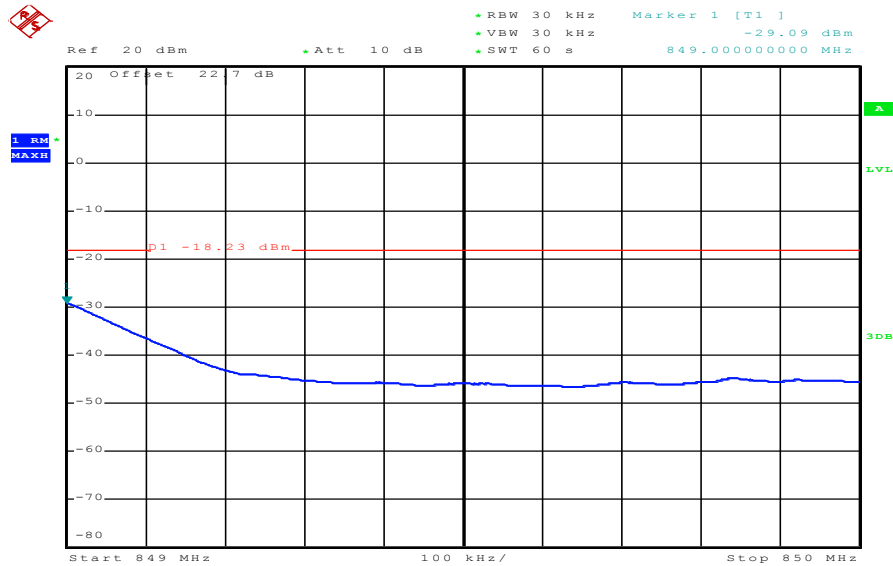

Date: 27.NOV.2012 12:19:38

Plot 3: Lowest channel – 16-QAM

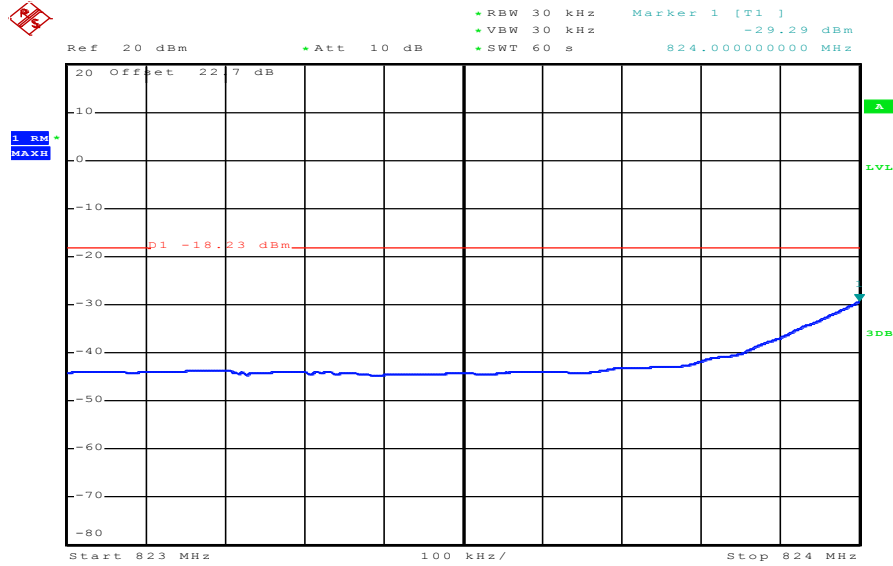

Date: 27.NOV.2012 12:27:42

Plot 4: Highest channel – 16-QAM

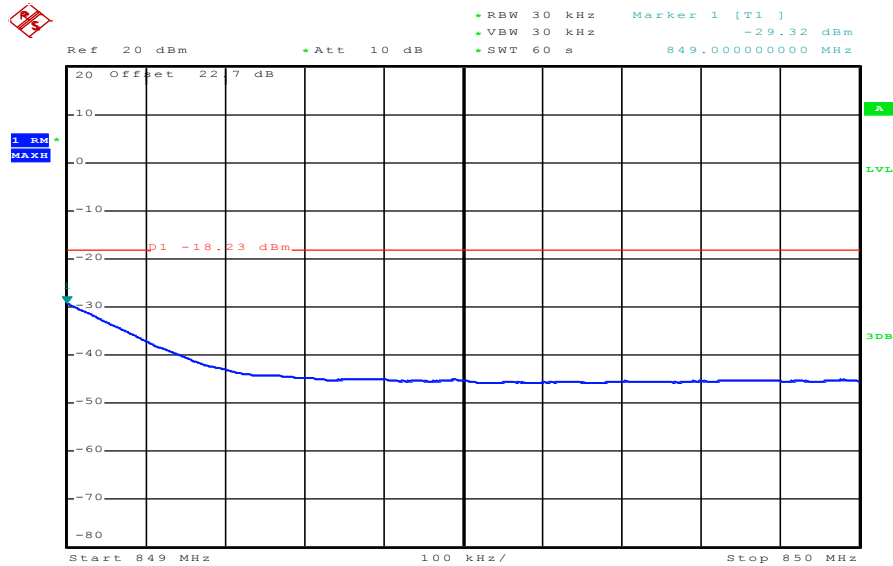

Date: 27.NOV.2012 12:21:20

Results: 5 MHz channel bandwidth

Plot 1: Lowest channel – QPSK

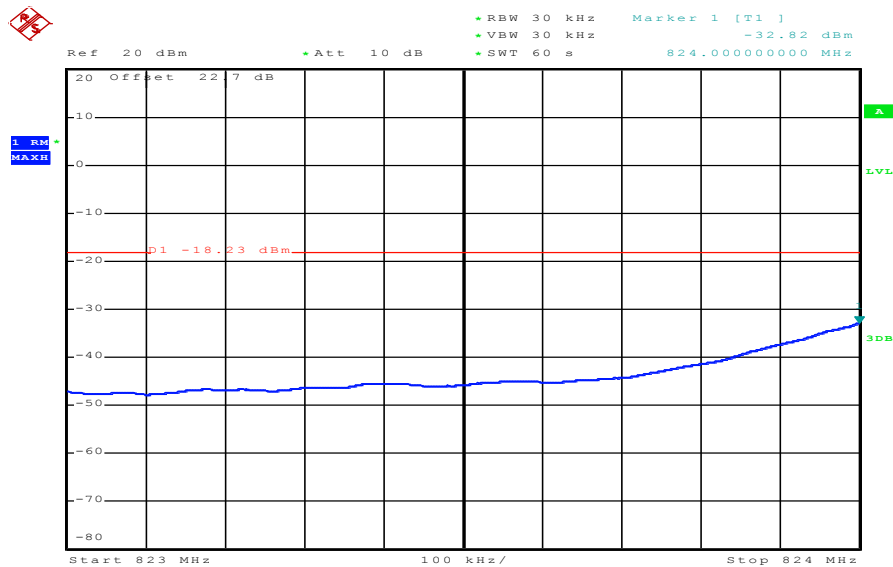

Date: 27.NOV.2012 12:43:40

Plot 2: Highest channel – QPSK

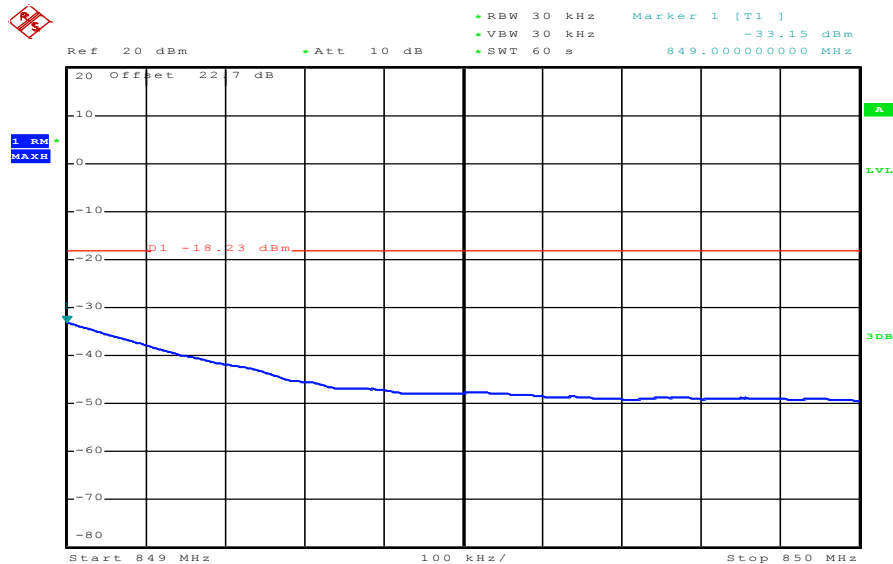

Date: 27.NOV.2012 13:03:56

Plot 3: Lowest channel – 16-QAM

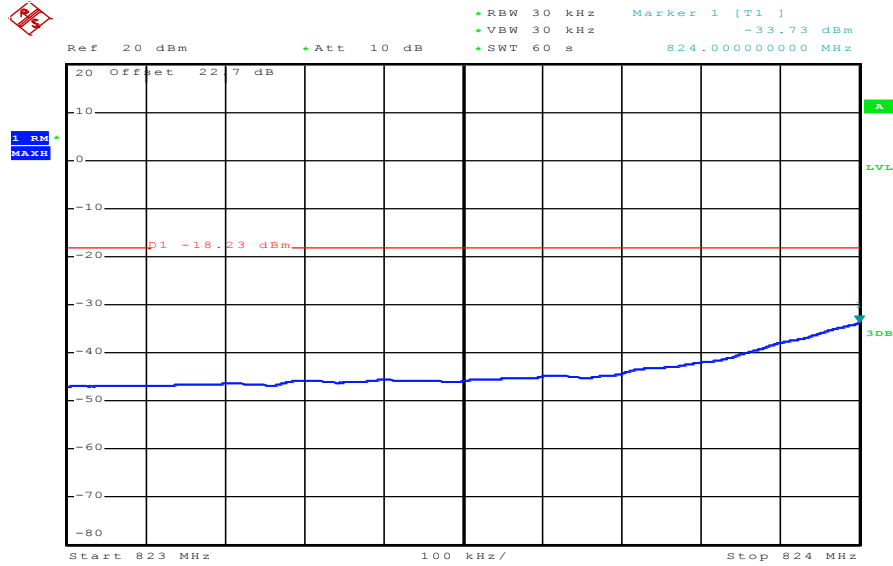

Date: 27.NOV.2012 12:47:45

Plot 4: Highest channel – 16-QAM

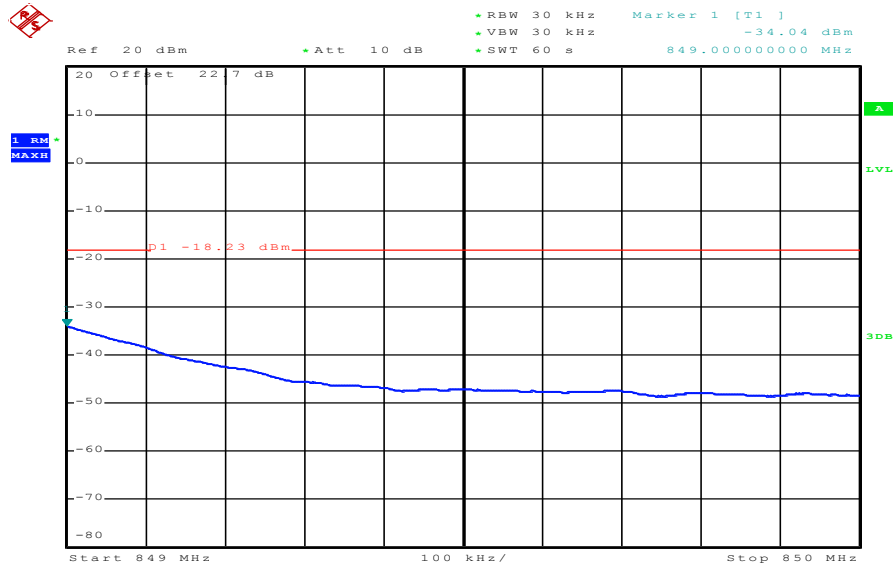

Date: 27.NOV.2012 13:10:34

Results: 10 MHz channel bandwidth

Plot 1: Lowest channel – QPSK

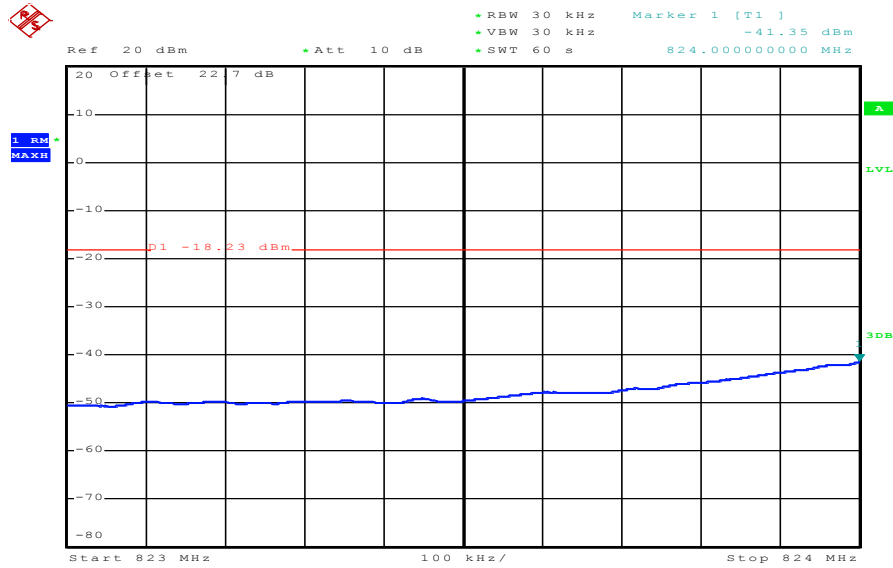

Date: 27.NOV.2012 13:23:26

Plot 2: Highest channel – QPSK

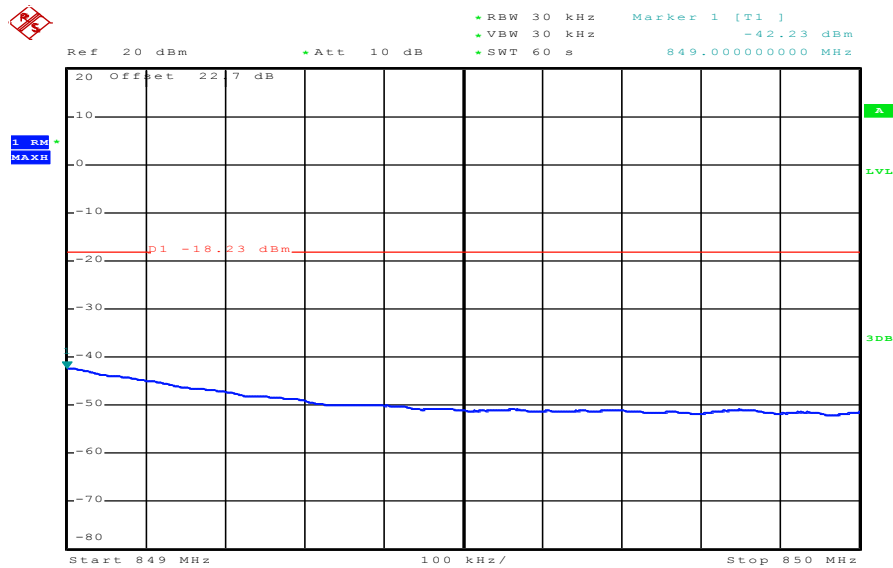

Date: 27.NOV.2012 13:34:27

Plot 3: Lowest channel – 16-QAM

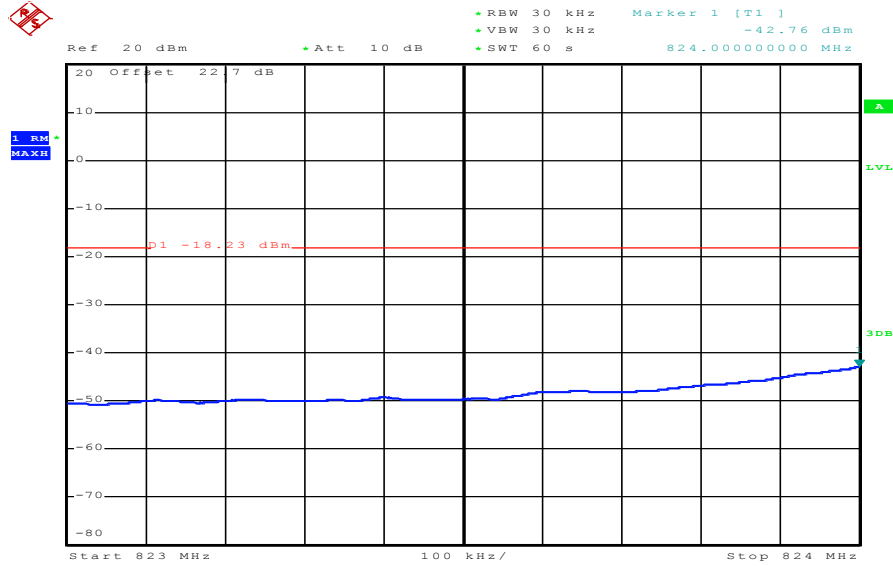

Date: 27.NOV.2012 13:21:48

Plot 4: Highest channel – 16-QAM

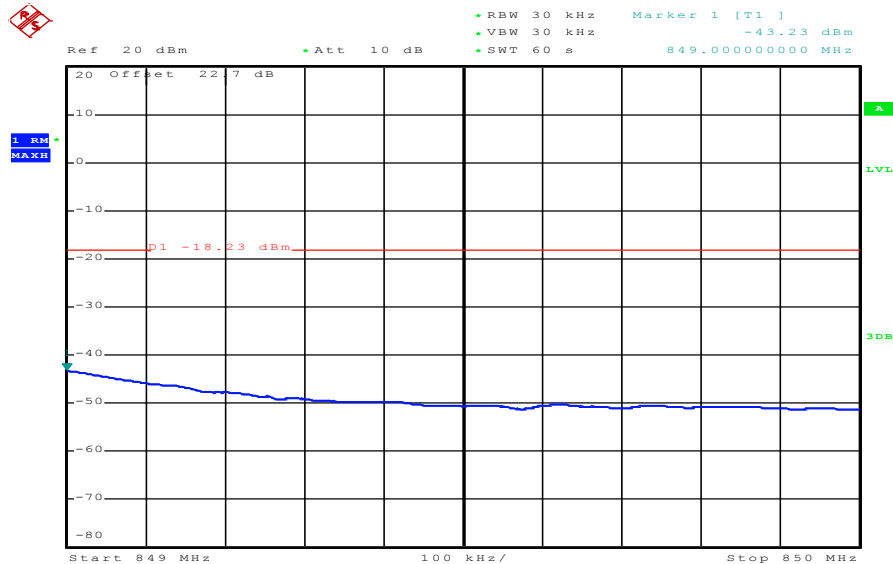

Date: 27.NOV.2012 13:32:43

Result: Passed

8.4.6 Occupied bandwidth

Description:

Measurement of the occupied bandwidth of the transmitted signal.

Measurement:

Similar to conducted emissions, occupied bandwidth measurements are only provided for selected frequencies in order to reduce the amount of submitted data. Data were taken at the extreme and mid frequencies of the LTE band V. The table below lists the measured 99% power and -26dBc occupied bandwidths. Spectrum analyzer plots are included on the following pages.

Measurement parameters	
Detector:	Peak
Sweep time:	Auto
Video bandwidth:	10 kHz
Resolution bandwidth:	10 kHz
Span:	2 x nominal BW
Trace-Mode:	Max Hold

Limits:

FCC	IC
CFR Part 22.917 CFR Part 2.1049	RSS 132
Occupied Bandwidth	
Spectrum must fall completely in the specified band	

Results:

Occupied Bandwidth – QPSK		
Bandwidth (MHz)	99% OBW (kHz)	-26 dBc BW (kHz)
1.4	1075	1232
3.0	2688	2880
5.0	4480	4720
10.0	8960	9240
Measurement uncertainty	± 10 kHz	

Occupied Bandwidth – 16-QAM		
Bandwidth (MHz)	99% OBW (kHz)	-26 dBc BW (kHz)
1.4	1081	1238
3.0	2688	2856
5.0	4480	4740
10.0	8960	9240
Measurement uncertainty	± 10 kHz	

Result: **Passed**

Plots: QPSK

Plot 1: 1.4 MHz (99% - OBW)

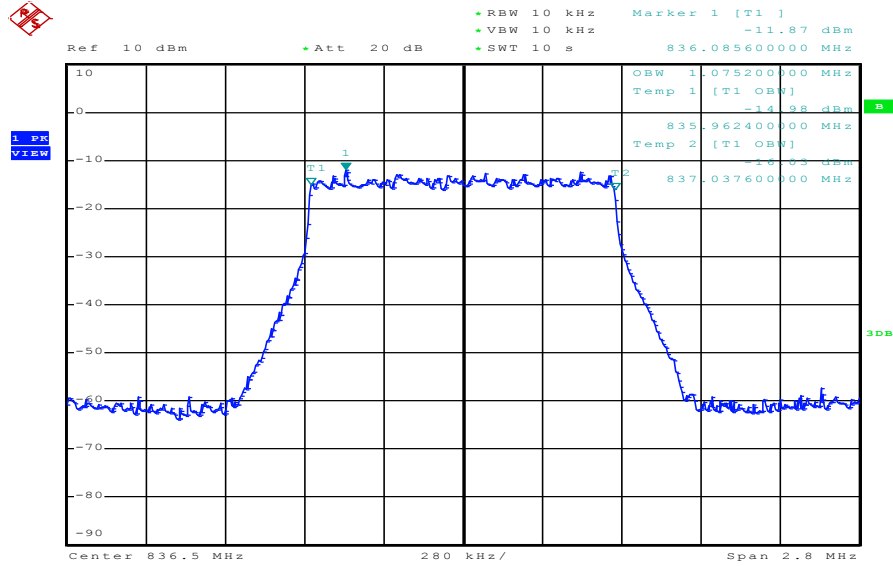

Date: 27.NOV.2012 13:55:37

Plot 2: 1.4 MHz (-26 dBc BW)

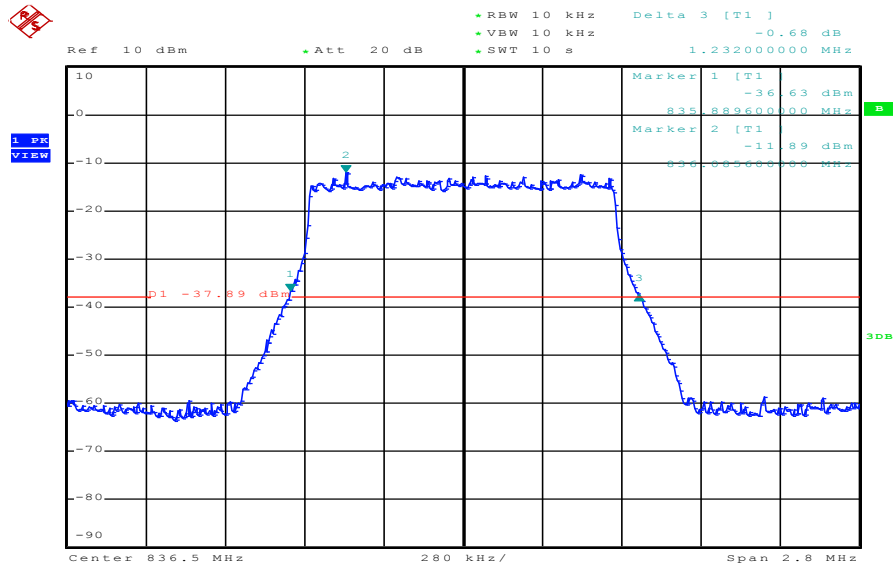

Date: 27.NOV.2012 13:54:41

Plot 3: 3 MHz (99% - OBW)

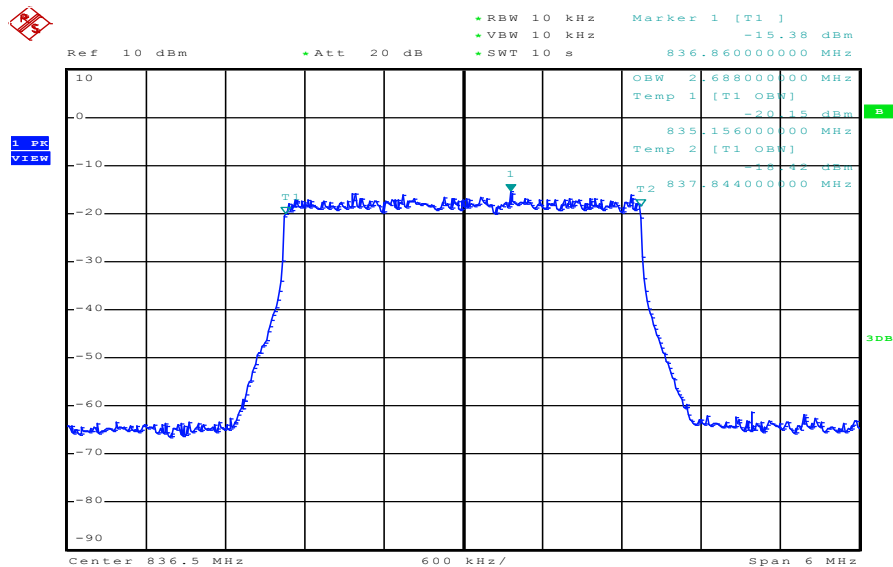

Date: 27.NOV.2012 12:32:47

Plot 4: 3 MHz (-26 dBc BW)

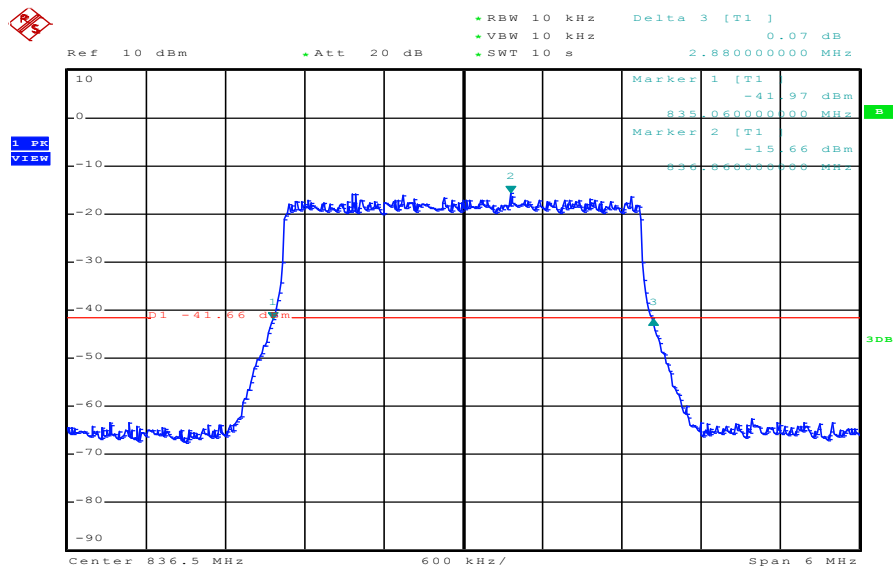

Date: 27.NOV.2012 12:34:25

Plot 5: 5 MHz (99% - OBW)

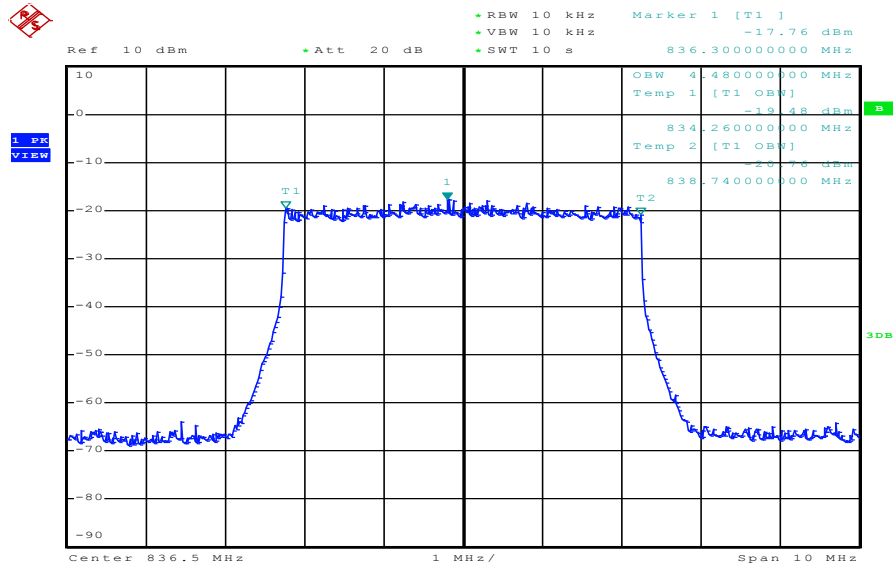

Date: 27.NOV.2012 12:59:22

Plot 6: 5 MHz (-26 dBc BW)

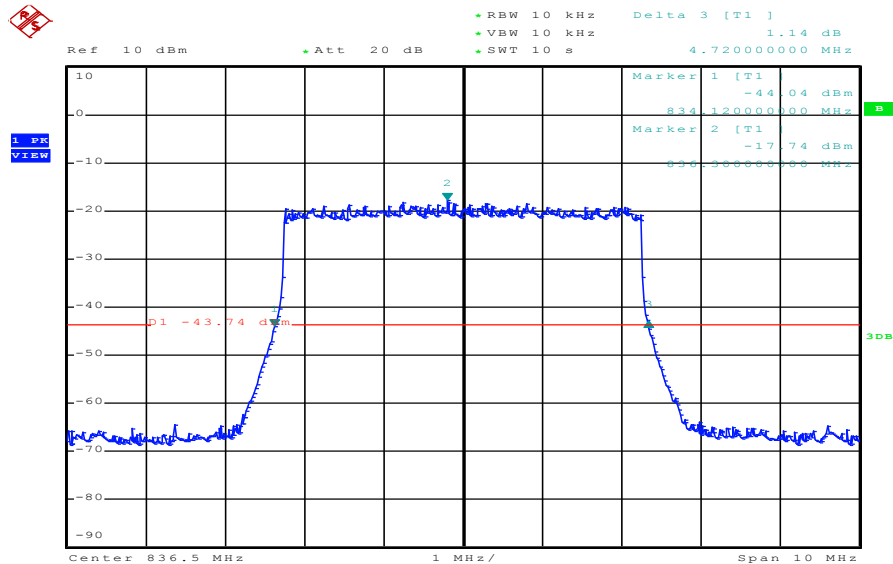

Date: 27.NOV.2012 12:58:28

Plot 7: 10 MHz (99% - OBW)

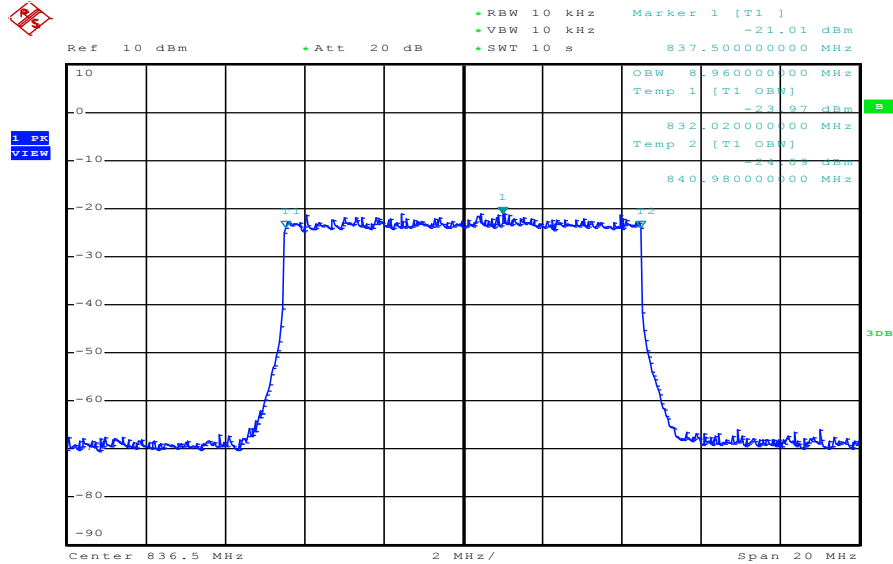

Date: 27.NOV.2012 13:26:12

Plot 8: 10 MHz (-26 dBc BW)

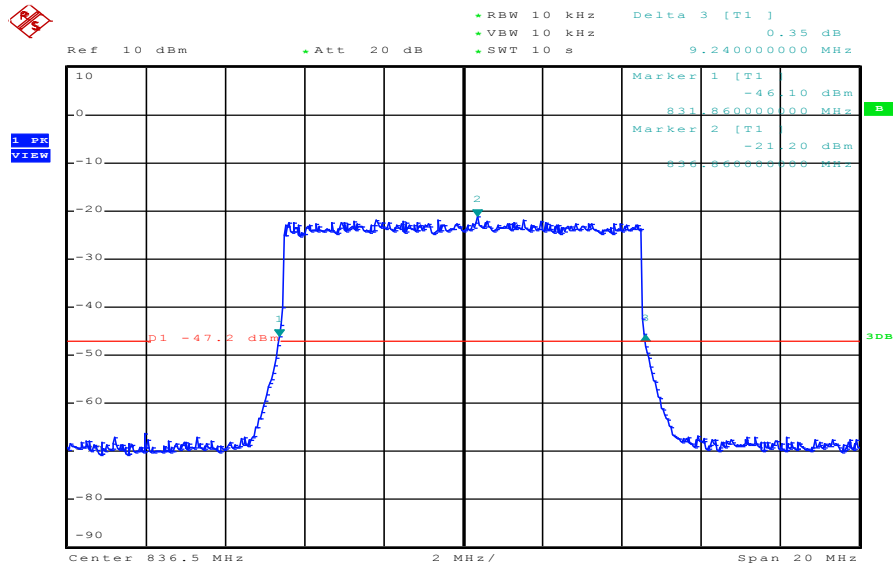

Date: 27.NOV.2012 13:27:32

Plots: 16-QAM

Plot 1: 1.4 MHz (99% - OBW)

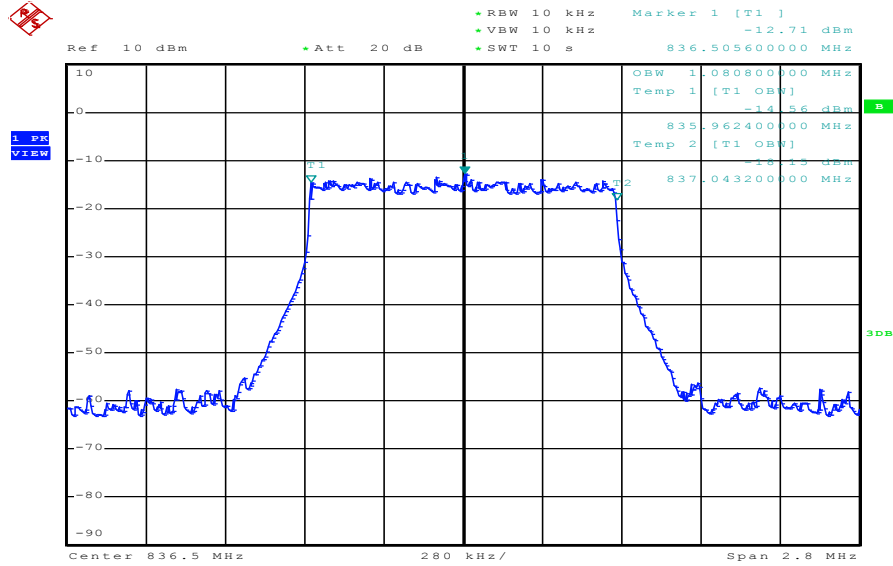

Date: 27.NOV.2012 13:51:46

Plot 2: 1.4 MHz (-26 dBc BW)

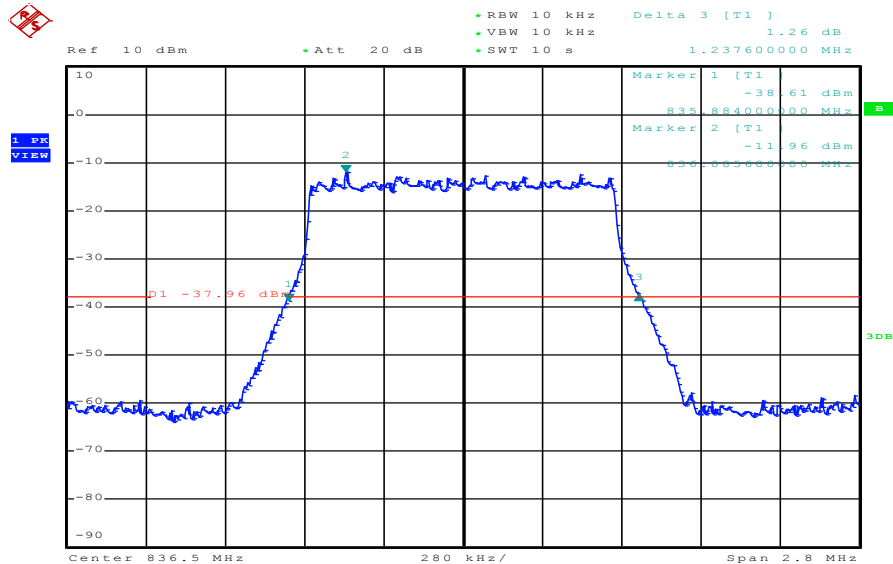

Date: 27.NOV.2012 13:53:16

Plot 3: 3 MHz (99% - OBW)

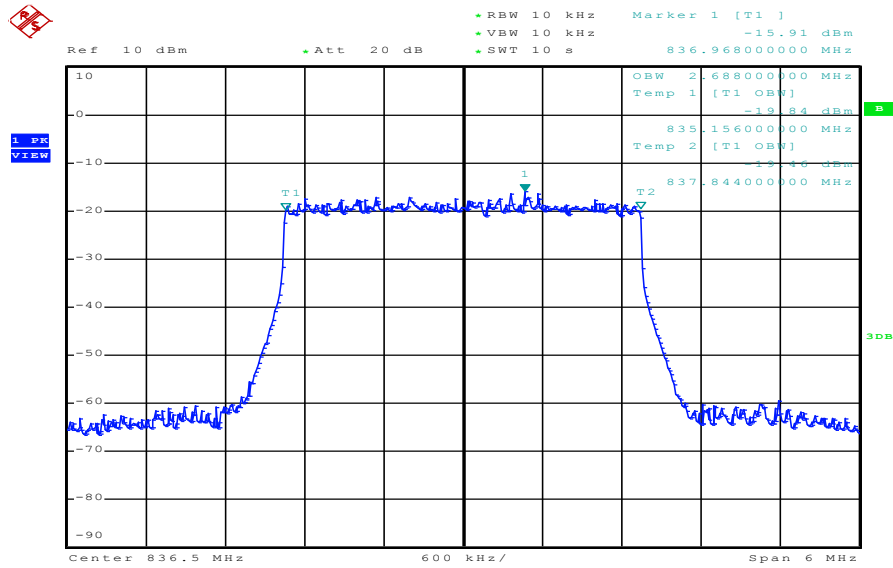

Date: 27.NOV.2012 12:36:48

Plot 4: 3 MHz (-26 dBc BW)

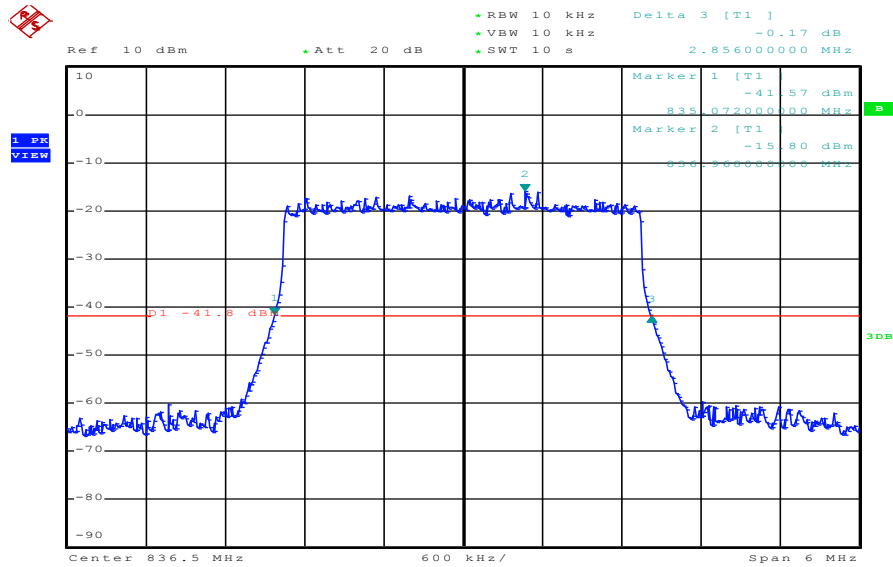

Date: 27.NOV.2012 12:35:52

Plot 5: 5 MHz (99% - OBW)

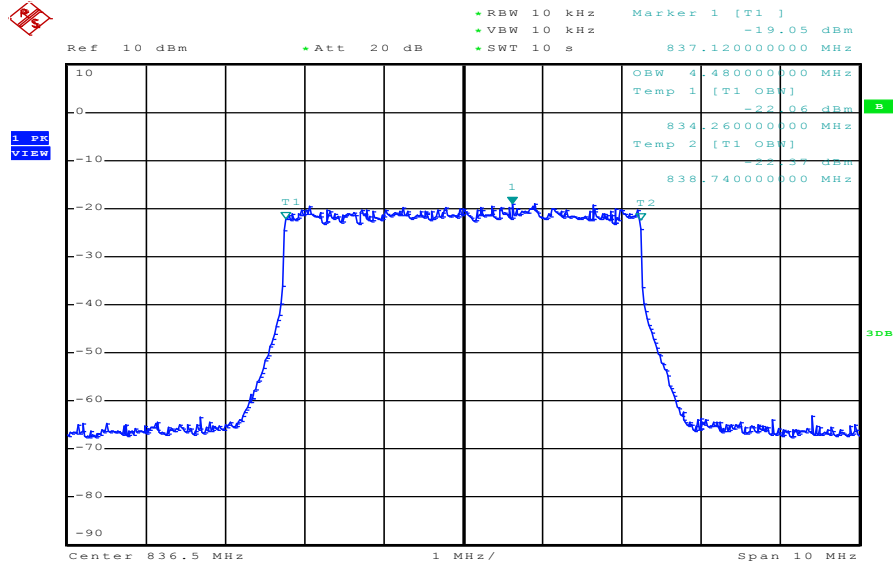

Date: 27.NOV.2012 12:50:02

Plot 6: 5 MHz (-26 dBc BW)

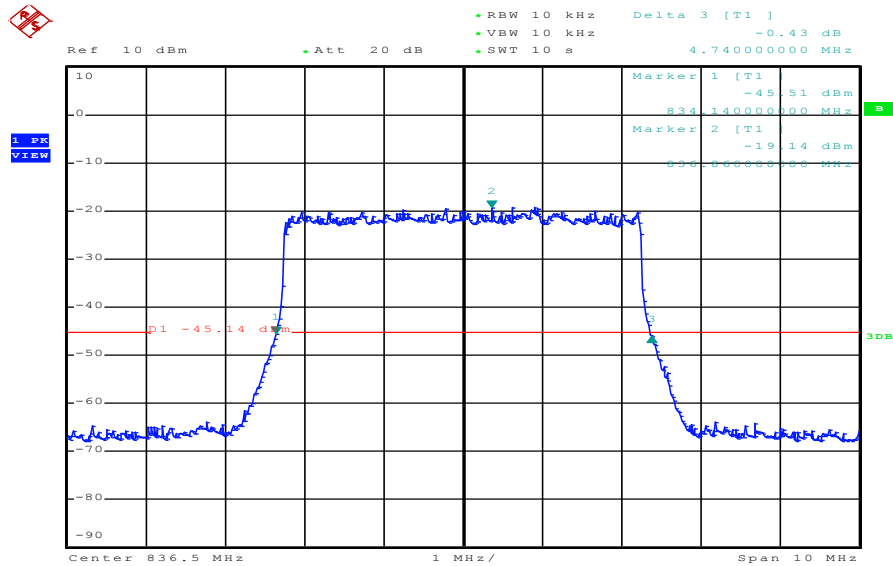

Date: 27.NOV.2012 12:51:23

Plot 7: 10 MHz (99% - OBW)

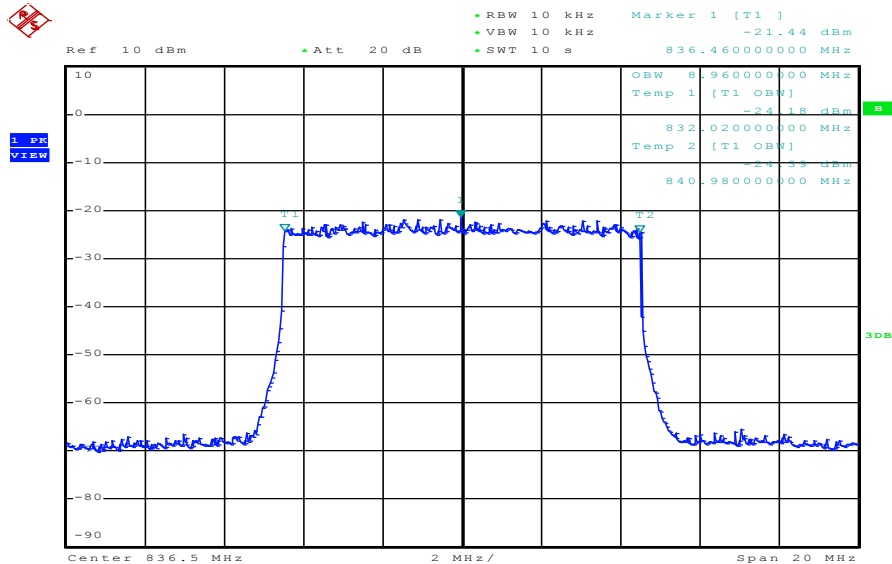

Date: 27.NOV.2012 13:29:53

Plot 8: 10 MHz (-26 dBc BW)

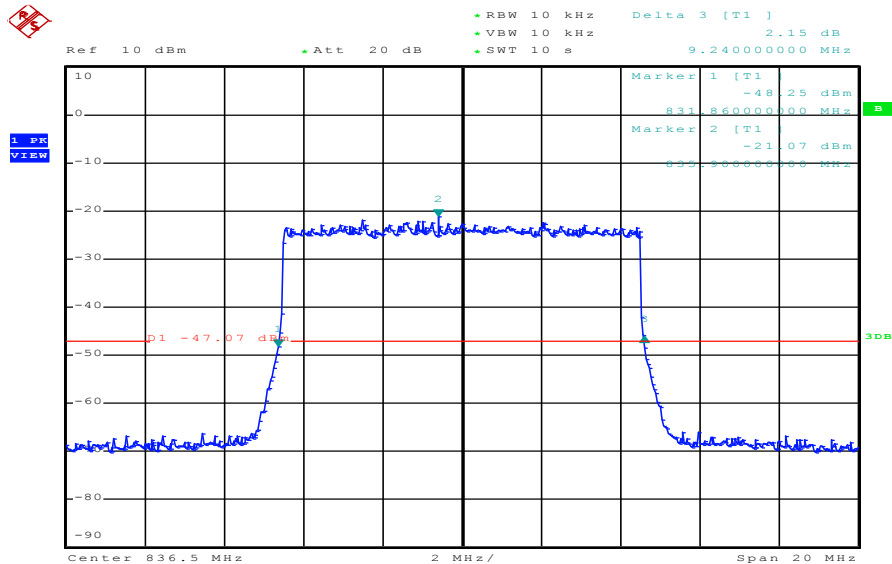

Date: 27.NOV.2012 13:28:49

9 Test equipment and ancillaries used for tests

Typically, the calibrations of the test apparatus are commissioned to and performed by an accredited calibration laboratory. The calibration intervals are determined in accordance with the DIN EN ISO/IEC 17025. In addition to the external calibrations, the laboratory executes comparison measurements with other calibrated test systems or effective verifications. Weekly chamber inspections and range calibrations are performed. Where possible, rf-generating and signalling equipment as well as measuring receivers and analyzers are connected to an external high-precision 10 MHz reference (GPS-based or rubidium frequency standard).

In order to simplify the identification of the equipment used at some special tests, some items of test equipment and ancillaries can be provided with an identifier or number in the equipment list below (Labor/Item).

No.	Lab / Item	Equipment	Type	Manufact.	Serial No.	INV. No Cetecom	Kind of Calibration	Last Calibration	Next Calibration
1	n. a.	Double-Ridged Waveguide Horn Antenna 1-18.0GHz	3115	EMCO	8812-3088	300001032	vkII!	11.05.2011	11.05.2013
2	n. a.	Active Loop Antenna	6502	EMCO	2210	300001015	ne		
3	n. a.	Anechoic chamber	FAC 3/5m	MWB / TDK	87400/02	300000996	ev		
4	9	Isolating Transformer	MPL IEC625 Bus Regeltrennt ravo	Erfi	91350	300001155	ne		
5	n. a.	Three-Way Power Splitter, 50 Ohm	11850C	HP Meßtechnik		300000997	ne		
6	n. a.	Amplifier	js42-00502650-28-5a	Parzich GMBH	928979	300003143	ne		
7	n. a.	TRILOG Broadband Test-Antenna 30 MHz - 3 GHz	VULB9163	Schwarzbeck	371	300003854	vkII!	14.10.2011	14.10.2014
8	n. a.	MXE EMI Receiver 20 Hz bis 26,5 GHz	N9038A	Agilent Technologies	MY51210197	300004405	k	19.12.2011	19.12.2012
9	n. a.	Temperature Test Chamber	VT 4002	Heraeus Voetsch	521/83761	300002326	Ve	20.09.2011	20.09.2013
10	n. a.	Signal Analyzer 40 GHz	FSV40	R&S	101042	300004xxx	k	22.10.2012	22.10.2013
11	n. a.	DC Power Supply 0 – 32V	1108-32	Heiden	001802	300001383	Ve	23.06.2010	23.06.2013
12	n. a.	Switch / Control Unit	3488A	HP Meßtechnik	2605e08770	300001443	ne		
13	n. a.	Signal Analyzer 20Hz-26,5GHz-150 to + 30 DBM	FSIQ26	R&S	835111/0004	300002678	Ve		
14	n. a.	Wideband Radio Communication Tester	CMW500	R&S	102375	300004187_0			

Agenda: Kind of Calibration

k	calibration / calibrated	EK	limited calibration
ne	not required (k, ev, izw, zw not required)	zw	cyclical maintenance (external cyclical maintenance)
ev	periodic self verification	izw	internal cyclical maintenance
Ve	long-term stability recognized	g	blocked for accredited testing
vkII!	Attention: extended calibration interval	*)	next calibration ordered / currently in progress
NK!	Attention: not calibrated		

10 Observations

No observations exceeding those reported with the single test cases have been made.

Annex A Document history

Version	Applied changes	Date of release
1.0	Initial release	2012-11-28
-A	Add antenna gain table	2013-01-30

Annex B Further information**Glossary**

AVG	-	Average
DUT	-	Device under test
EMC	-	Electromagnetic Compatibility
EN	-	European Standard
EUT	-	Equipment under test
ETSI	-	European Telecommunications Standard Institute
FCC	-	Federal Communication Commission
FCC ID	-	Company Identifier at FCC
HW	-	Hardware
IC	-	Industry Canada
Inv. No.	-	Inventory number
N/A	-	Not applicable
PP	-	Positive peak
QP	-	Quasi peak
S/N	-	Serial number
SW	-	Software

Annex C Accreditation Certificate



Deutsche Akkreditierungsstelle GmbH
German Accreditation Body

Entrusted according to Section 8 subsection 1 AkkStelleG in connection with Section 1 subsection 1 AkkStelleGBV
Signatory to the Multilateral Agreements of EA, ILAC and IAF for Mutual Recognition

Accreditation



The Deutsche Akkreditierungsstelle GmbH (German Accreditation Body) attests that the testing laboratory

CETECOM ICT Services GmbH
Untertürkheimer Straße 6-10
66117 Saarbrücken

is competent under the terms of DIN EN ISO/IEC 17025:2005 to carry out tests in the following fields:

- Wired communications and DECT
- Acoustic
- Radio
- Shirt Range Devices (SRD)
- RFID
- WiMax and Richtfunk
- Mobile radio (GSM / DCS), Over the Air (OTA) Performance
- Electromagnetic Compatibility (EMC) incl. Automotive
- Product safety
- SAR and Hearing Aid Compatibility (HAC)
- Environmental simulation
- Smart Card Terminals
- Bluetooth
- Wi-Fi-Services

The accreditation certificate shall only apply in connection with the notice of accreditation of 13.04.2011 with the accreditation number D-PL-12076-01 and is valid until 03.09.2014. It comprises the cover sheet, the reverse side of the cover sheet and the following annex with a total of 82 pages.

Registration number of the certificate: **D-PL-12076-01-01**

Frankfurt am Main, 13.04.2011

Dipl.-Ing. (FH) Eberhard Egner
Head of Division 2

This document is a translation. The definitive version is the original German accreditation certificate.
See annex overleaf.

Front side of certificate

Deutsche Akkreditierungsstelle GmbH

Office Berlin
Spittelmarkt 10
10117 Berlin

Office Frankfurt am Main
Gartenstraße 6
60594 Frankfurt am Main

Office Braunschweig
Bundesallee 100
38116 Braunschweig

The publication of extracts of the accreditation certificate is subject to the prior written approval by Deutsche Akkreditierungsstelle GmbH (DAKKS). Exempted is the unchanged form of separate disseminations of the cover sheet by the conformity assessment body mentioned overleaf.

No impression shall be made that the accreditation also extends to fields beyond the scope of accreditation attested by DAKKS.

The accreditation was granted pursuant to the Act on the Accreditation Body (AkkStelleG) of 31 July 2009 (Federal Law Gazette I p. 2625) and the Regulation (EC) No 765/2008 of the European Parliament and of the Council of 9 July 2008 setting out the requirements for accreditation and market surveillance relating to the marketing of products (Official Journal of the European Union L 218 of 9 July 2008, p. 30). DAKKS is a signatory to the Multilateral Agreements for Mutual Recognition of the European co-operation for Accreditation (EA), International Accreditation Forum (IAF) and International Laboratory Accreditation Cooperation (ILAC). The signatories to these agreements recognise each other's accreditations.

The up-to-date state of membership can be retrieved from the following websites:
EA: www.european-accreditation.org
ILAC: www.ilac.org
IAF: www.iaf.nu

Back side of certificate

Note:

The current certificate including annex is published on our website (see link below) or may be received from CETECOM ICT Services on request.

http://www.cetecom.com/fileadmin/de/CETECOM_D_Saarbruecken/accreditations_Jan_2010/DAKKS_Akkredi_Urk_EN17025-En_incl_Annex.pdf