**CETECOM™****CETECOM ICT Services**
consulting - testing - certification >>>**TEST REPORT**

Test report no.: 1-4254/12-61-02-A

Deutsche
Akkreditierungsstelle
D-PL-12076-01-01**Testing laboratory**

CETECOM ICT Services GmbH
Untertuerkheimer Strasse 6 – 10
66117 Saarbruecken / Germany
Phone: + 49 681 5 98 - 0
Fax: + 49 681 5 98 - 9075
Internet: <http://www.cetecom.com>
e-mail: ict@cetecom.com

Accredited Testing Laboratory:

The testing laboratory (area of testing) is accredited according to DIN EN ISO/IEC 17025 (2005) by the Deutsche Akkreditierungsstelle GmbH (DAkkS). The accreditation is valid for the scope of testing procedures as stated in the accreditation certificate with the registration number: D-PL-12076-01-01
Area of Testing: Radio/Satellite Communications

Applicant

Sony Mobile Communications AB
Nya Vattentornet
22188 Lund / SWEDEN
Phone: +46 46 19 30 00
Fax: +46 46 19 32 95
Contact: Håkan Sjöberg
e-mail: hakan.sjoberg@sonymobile.com
Phone: +46 46 19 35 59

Manufacturer

Sony Mobile Communications AB
Nya Vattentornet
22188 Lund / SWEDEN

Test standard/s

47 CFR Part 22	Title 47 of the Code of Federal Regulations; Chapter I Part 22 - Public mobile services
47 CFR Part 24	Title 47 of the Code of Federal Regulations; Chapter I Part 24 - Personal communications services
RSS - 132 Issue 2	Spectrum Management and Telecommunications Policy - Radio Standards Specifications Cellular Telephones Employing New Technologies Operating in the Bands 824-849 MHz and 869-894 MHz

For further applied test standards please refer to section 3 of this test report.

Test Item

Kind of test item:	GSM Mobile Phone GPRS/EGPRS 850/900/1800/1900; UMTS HSPA FDDI/V/VIII; LTE FDD 1/3/5/7/8/20; WLAN a/b/g/n; BT 3.1; BT LE; RFID; FM Rx; A-GPS
Model name:	PM-0240-BV
FCC ID:	PY7PM-0240
IC:	4170B-PM0240
Frequency:	GSM: 824.2 – 848.8 MHz, 1850.2 – 1909.8 MHz UMTS: 826.4 – 846.6 MHz
Technology tested:	GSM / Edge; UMTS
Antenna:	Integrated antenna
Power Supply:	3.7 V DC by Li - polymer battery
Temperature Range:	-30°C to +60°C

Test report authorised:

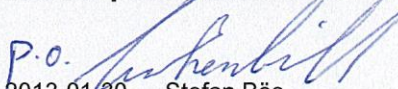
2013-01-30 Stefan Börs
Senior Testing Manager

Test performed:

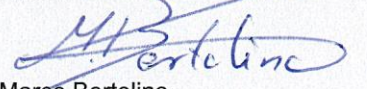
2013-01-30 Marco Bertolino
Testing Manager

1 Table of contents

1	Table of contents	2
2	General information	3
2.1	Notes and disclaimer	3
2.2	Application details.....	3
3	Test standard/s	3
4	Test environment.....	4
5	Test item	4
5.1	Additional information	4
6	Test laboratories sub-contracted	4
7	Summary of measurement results	5
7.1	GSM 850.....	5
7.2	PCS 1900	5
7.3	UMTS band V.....	6
8	RF measurements	7
8.1	Description of test setup	7
8.1.1	Radiated measurements.....	7
8.1.2	Conducted measurements.....	8
8.2	RSP100 test report cover sheet / performance test data	9
8.3	Results GSM 850	10
8.3.1	RF output power	10
8.3.2	Frequency stability	12
8.3.3	Spurious emissions radiated	15
8.3.4	Spurious emissions conducted	18
8.3.5	Block edge compliance	22
8.3.6	Occupied bandwidth	25
8.4	Results PCS 1900	33
8.4.1	RF output power	33
8.4.2	Frequency stability	35
8.4.3	Spurious emissions radiated	38
8.4.4	Spurious emissions conducted	42
8.4.5	Block edge compliance	46
8.4.6	Occupied bandwidth	49
8.5	Results UMTS band V	57
8.5.1	RF output power	57
8.5.2	Frequency stability	59
8.5.3	Spurious emissions radiated	62
8.5.4	Spurious emissions conducted	65
8.5.5	Block edge compliance	69
8.5.6	Occupied bandwidth	71
9	Test equipment and ancillaries used for tests	75
10	Observations	76
Annex A	Document history	77
Annex B	Further information.....	77
Annex C	Accreditation Certificate	78

2 General information

2.1 Notes and disclaimer

The test results of this test report relate exclusively to the test item specified in this test report. CETECOM ICT Services GmbH does not assume responsibility for any conclusions and generalizations drawn from the test results with regard to other specimens or samples of the type of the equipment represented by the test item.

The test report may only be reproduced or published in full. Reproduction or publication of extracts from the report requires the prior written approval of CETECOM ICT Services GmbH.

The testing service provided by CETECOM ICT Services GmbH has been rendered under the current "General Terms and Conditions for CETECOM ICT Services GmbH".

CETECOM ICT Services GmbH will not be liable for any loss or damage resulting from false, inaccurate, inappropriate or incomplete product information provided by the customer.

Under no circumstances does the CETECOM ICT Services GmbH test report include any endorsement or warranty regarding the functionality, quality or performance of any other product or service provided.

Under no circumstances does the CETECOM ICT Services GmbH test report include or imply any product or service warranties from CETECOM ICT Services GmbH, including, without limitation, any implied warranties of merchantability, fitness for purpose, or non-infringement, all of which are expressly disclaimed by CETECOM ICT Services GmbH.

All rights and remedies regarding vendor's products and services for which CETECOM ICT Services GmbH has prepared this test report shall be provided by the party offering such products or services and not by CETECOM ICT Services GmbH.

In no case this test report can be considered as a Letter of Approval.

2.2 Application details

Date of receipt of order:	2012-11-02
Date of receipt of test item:	2012-11-05
Start of test:	2012-11-08
End of test:	2013-01-29
Person(s) present during the test:	-/-

3 Test standard/s

Test standard	Date	Test standard description
47 CFR Part 22	2010-10	Title 47 of the Code of Federal Regulations; Chapter I Part 22 - Public mobile services
47 CFR Part 24	2010-10	Title 47 of the Code of Federal Regulations; Chapter I Part 24 - Personal communications services
RSS - 132 Issue 2	2005-09	Spectrum Management and Telecommunications Policy - Radio Standards Specifications Cellular Telephones Employing New Technologies Operating in the Bands 824-849 MHz and 869-894 MHz
RSS - 133 Issue 5	2009-02	Spectrum Management and Telecommunications Policy - Radio Standards Specifications 2 GHz Personal Communication Services

4 Test environment

Temperature:	T_{nom}	+22 °C during room temperature tests
	T_{max}	+60 °C during high temperature tests
	T_{min}	-30 °C during low temperature tests
Relative humidity content:		55 %
Barometric pressure:		not relevant for this kind of testing
Power supply:	V_{nom}	3.7 V DC by Li - polymer battery
	V_{max}	4.4 V
	V_{min}	3.3 V

5 Test item

Kind of test item	:	GSM Mobile Phone GPRS/EGPRS 850/900/1800/1900; UMTS HSPA FDDI/V/VIII; LTE FDD 1/3/5/7/8/20; WLAN a/b/g/n; BT 3.1; BT LE; RFID; FM Rx; A-GPS
Type identification	:	PM-0240-BV
S/N serial number	:	Conducted units: CB5121TUBU; CB5122ZPX2 Radiated units: CB5121SWDK; CB5121TU0P; CB5122ZPX2
HW hardware status	:	SP1.2
SW software status	:	10.1.A.0.194, 10.1.A.1.17
Frequency band [MHz]	:	GSM: 824.2 – 848.8 MHz, 1850.2 – 1909.8 MHz UMTS: 826.4 – 846.6 MHz
Type of modulation	:	GMSK, 8-PSK, QPSK
Antenna	:	Integrated antenna
Power supply	:	3.7 V DC by Li - polymer battery
Temperature range	:	-30°C to +60 °C

5.1 Additional information

Test setup- and EUT-photos are included in test report 1-4254/12-61-03

6 Test laboratories sub-contracted

None

7 Summary of measurement results

- No deviations from the technical specifications were ascertained
- There were deviations from the technical specifications ascertained

TC identifier	Description	verdict	date	Remark
RF-Testing	CFR Part 22, 24 RSS 132, 133	passed	2013-01-30	-/-

7.1 GSM 850

Test Case	temperature conditions	power source voltages	Pass	Fail	NA	NP	Remark
RF Output Power	Nominal	Nominal	<input checked="" type="checkbox"/>	<input type="checkbox"/>	<input type="checkbox"/>	<input type="checkbox"/>	-/-
Frequency Stability	Nominal	Nominal	<input checked="" type="checkbox"/>	<input type="checkbox"/>	<input type="checkbox"/>	<input type="checkbox"/>	-/-
Spurious Emissions Radiated	Nominal	Nominal	<input checked="" type="checkbox"/>	<input type="checkbox"/>	<input type="checkbox"/>	<input type="checkbox"/>	-/-
Spurious Emissions Conducted	Nominal	Nominal	<input checked="" type="checkbox"/>	<input type="checkbox"/>	<input type="checkbox"/>	<input type="checkbox"/>	-/-
Block Edge Compliance	Nominal	Nominal	<input checked="" type="checkbox"/>	<input type="checkbox"/>	<input type="checkbox"/>	<input type="checkbox"/>	-/-
Occupied Bandwidth	Nominal	Nominal	<input checked="" type="checkbox"/>	<input type="checkbox"/>	<input type="checkbox"/>	<input type="checkbox"/>	-/-

Note: NA = Not applicable; NP = Not performed

7.2 PCS 1900

Test Case	temperature conditions	power source voltages	Pass	Fail	NA	NP	Remark
RF Output Power	Nominal	Nominal	<input checked="" type="checkbox"/>	<input type="checkbox"/>	<input type="checkbox"/>	<input type="checkbox"/>	-/-
Frequency Stability	Nominal	Nominal	<input checked="" type="checkbox"/>	<input type="checkbox"/>	<input type="checkbox"/>	<input type="checkbox"/>	-/-
Spurious Emissions Radiated	Nominal	Nominal	<input checked="" type="checkbox"/>	<input type="checkbox"/>	<input type="checkbox"/>	<input type="checkbox"/>	-/-
Spurious Emissions Conducted	Nominal	Nominal	<input checked="" type="checkbox"/>	<input type="checkbox"/>	<input type="checkbox"/>	<input type="checkbox"/>	-/-
Block Edge Compliance	Nominal	Nominal	<input checked="" type="checkbox"/>	<input type="checkbox"/>	<input type="checkbox"/>	<input type="checkbox"/>	-/-
Occupied Bandwidth	Nominal	Nominal	<input checked="" type="checkbox"/>	<input type="checkbox"/>	<input type="checkbox"/>	<input type="checkbox"/>	-/-

Note: NA = Not applicable; NP = Not performed

7.3 UMTS band V

Test Case	temperature conditions	power source voltages	Pass	Fail	NA	NP	Remark
RF Output Power	Nominal	Nominal	<input checked="" type="checkbox"/>	<input type="checkbox"/>	<input type="checkbox"/>	<input type="checkbox"/>	-/-
Frequency Stability	Nominal	Nominal	<input checked="" type="checkbox"/>	<input type="checkbox"/>	<input type="checkbox"/>	<input type="checkbox"/>	-/-
Spurious Emissions Radiated	Nominal	Nominal	<input checked="" type="checkbox"/>	<input type="checkbox"/>	<input type="checkbox"/>	<input type="checkbox"/>	-/-
Spurious Emissions Conducted	Nominal	Nominal	<input checked="" type="checkbox"/>	<input type="checkbox"/>	<input type="checkbox"/>	<input type="checkbox"/>	-/-
Block Edge Compliance	Nominal	Nominal	<input checked="" type="checkbox"/>	<input type="checkbox"/>	<input type="checkbox"/>	<input type="checkbox"/>	-/-
Occupied Bandwidth	Nominal	Nominal	<input checked="" type="checkbox"/>	<input type="checkbox"/>	<input type="checkbox"/>	<input type="checkbox"/>	-/-

Note: NA = Not applicable; NP = Not performed

8 RF measurements

8.1 Description of test setup

For the spurious measurements we use the substitution method according TIA/EIA 603.

8.1.1 Radiated measurements

The radiated emissions from the EUT are performed in a semi anechoic chamber. The EUT is placed on a conductive turntable and powered with nominal voltage. The signalling is performed either from outside the chamber with a signalling unit (AP or other) by air link using a signalling antenna or directly by special test software from the customer.

Semi anechoic chamber

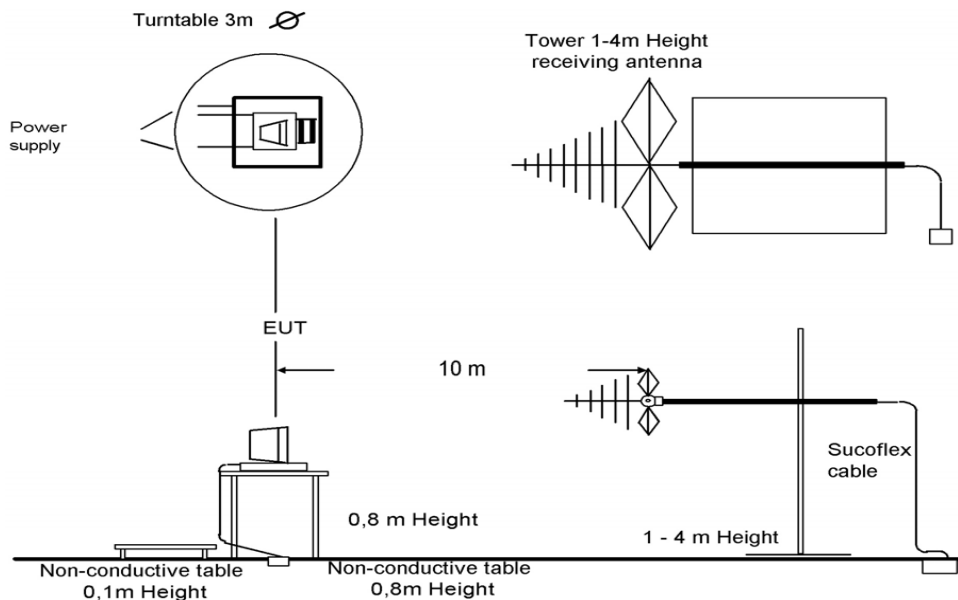

Picture 1: Diagram radiated measurements

9 kHz - 30 MHz:	active loop antenna
30 MHz – 1 GHz:	tri-log antenna
> 1 GHz:	horn antenna

8.1.2 Conducted measurements

The EUT's RF signal is coupled out by the antenna connector which is supplied by the manufacturer. The signal is first 10dB attenuated before it is power divided (~6dB loss per branch). One of the signal paths is connected to the signalling unit (AP or other), the other one is connected to the spectrum analyzer. The specific losses for both signal paths are first checked within a calibration. The measurement readings on the signalling unit/spectrum analyzer are corrected by the specific test set-up loss. The attenuator, power divider, signalling unit and the spectrum analyzer are impedance matched on 50 Ohm. If special software is used, there is no power divider necessary.

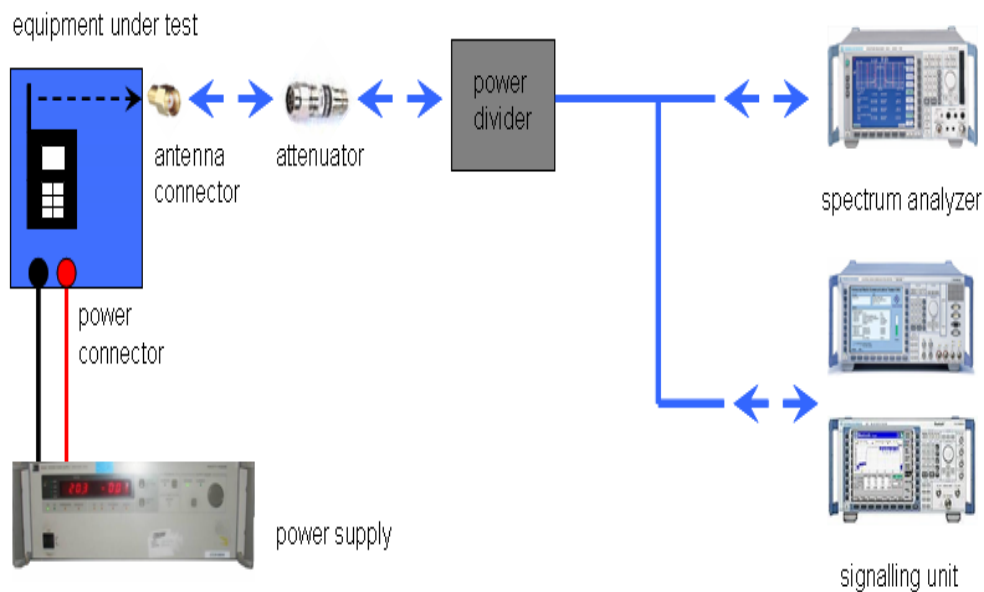

Picture 2: Diagram conducted measurements

The term measuring receiver refers to either a selective voltmeter or a spectrum analyser.

Frequency being measured f	Measuring receiver bandwidth 6 dB	Spectrum analyser bandwidth 3dB
$f < 150 \text{ kHz}$	200 Hz or	300 Hz
$150 \text{ kHz} \leq f < 25 \text{ MHz}$	9 kHz or	10 kHz
$25 \text{ MHz} \leq f < 1000 \text{ MHz}$	120 kHz or	100 kHz
$1000 \text{ MHz} \leq f$		1 MHz
NOTE: Specific requirements in CEPT/ERC/Recommendation 70-03 [2] shall be applied where applicable.		

8.2 RSP100 test report cover sheet / performance test data

Test Report Number	:	1-4254/12-61-02-A			
Equipment Model Number	:	PM-0240-BV			
Certification Number	:	4170B-PM0240			
Manufacturer (complete Address)	:	Sony Mobile Communications AB Nya Vattentornet 22188 Lund / SWEDEN			
Tested to radio standards specification no.	:	RSS - 132 Issue 2, RSS - 133 Issue 5			
Open Area Test Site IC No.	:	IC 3462C-1			
Frequency Range	:	GSM: 824.2 – 848.8 MHz, 1850.2 – 1909.8 MHz			
GPS receiver turned	:	On			
RF-power [dBm] (max.)	:	Band	Conducted	ERP / EIRP	Mode
		GSM850	31.9 dBm	27.9 dBm	GMSK
			28.3 dBm	24.5 dBm	8-PSK
		GSM1900	28.5 dBm	33.0 dBm	GMSK
			26.8 dBm	31.3 dBm	8-PSK
		WCDMA 850	25.1 dBm	21.4 dBm	QPSK
		WCDMA 1700	-/-	-/-	QPSK
WCDMA 1900	-/-	-/-	QPSK		
Occupied bandwidth (99%-BW) [kHz]	:	GSM850	289	GMSK	
			277	8-PSK	
		GSM1900	283	GMSK	
			287	8-PSK	
		WCDMA 850	4581	QPSK	
		WCDMA 1700	-/-	QPSK	
WCDMA 1900	-/-	QPSK			
Type of modulation	:	GMSK; 8-PSK; QPSK; 16QAM			
Emission Designator (TRC-43)	:	GSM850	289KGXW	GMSK	
			277KG7W	8-PSK	
		GSM1900	283KGXW	GMSK	
			287KG7W	8-PSK	
		WCDMA 850	4M58F9W	QPSK	
		WCDMA 1700	-/-	QPSK	
WCDMA 1900	-/-	QPSK			
Antenna Information	:	Integrated antenna			
Transmitter Spurious (worst case) [dBm]	:	48 @ 12.5 GHz			
Receiver Spurious (worst case)[dBµV/m @ 3m]:	:	48 @ 12.5 GHz			

**ATTESTATION:
DECLARATION OF COMPLIANCE:**

I attest that the testing was performed or supervised by me; that the test measurements were made in accordance with the above-mentioned Industry Canada standard(s); and that the equipment identified in this application has been subjected to all the applicable test conditions specified in the Industry Canada standards and all of the requirements of the standard have been met.

Laboratory Manager:

2013-01-30
Date

Marco Bertolino
Name

Signature

8.3 Results GSM 850

All GSM-band measurements are done in GSM mode only (circuit switched). All relevant tests have been repeated using 8-PSK modulation if EDGE mode is supported. All tests were performed with one timeslot in uplink activated and one timeslot in downlink activated. For each mode the highest output power was determined and used.

8.3.1 RF output power

Description:

This paragraph contains average power, peak output power and ERP measurements for the mobile station. In all cases, the peak output power is within the required mask (this mask is specified in the JTC standards, TIA PN3389 Vol. 1 Chap 7, and is no FCC requirement).

Measurement:

The mobile was set up for the maximum output power with pseudo random data modulation.

Measurement parameters	
Detector:	Peak and RMS (Power in Burst)
Sweep time:	Auto
Video bandwidth:	1 MHz
Resolution bandwidth:	1 MHz
Span:	Zero Span
Trace-Mode:	Max Hold

Limits:

FCC	IC
CFR Part 22.913 CFR Part 2.1046	RSS 132
Nominal Peak Output Power	
+38.45 dBm	
In measuring transmissions in this band using an average power technique, the peak-to-average ratio (PAR) of the transmission may not exceed 13 dB.	

Results:

Output Power (conducted) GMSK mode		
Frequency (MHz)	Average Output Power (dBm)	Peak to Average Ratio (dB)
824.2	31.9	0.16
836.4	31.7	0.14
848.8	31.6	0.14
Measurement uncertainty	± 0.5 dB	

Output Power (conducted) 8-PSK mode		
Frequency (MHz)	Average Output Power (dBm)	Peak to Average Ratio (dB)
824.2	28.3	3.12
836.4	28.0	3.27
848.8	28.2	3.19
Measurement uncertainty	± 0.5 dB	

Output Power (radiated) GMSK mode	
Frequency (MHz)	Average Output Power (dBm) - ERP
824.2	25.2
836.4	26.5
848.8	27.9
Measurement uncertainty	± 2.0 dB

Output Power (radiated) 8-PSK mode	
Frequency (MHz)	Average Output Power (dBm) - ERP
824.2	21.6
836.4	22.8
848.8	24.5
Measurement uncertainty	± 2.0 dB

Result: Passed

8.3.2 Frequency stability

Description:

In order to measure the carrier frequency under the condition of AFC lock, it is necessary to make measurements with the mobile station in a “call mode”. This is accomplished with the use of a R&S CMU200 DIGITAL RADIOCOMMUNICATION TESTER.

1. Measure the carrier frequency at room temperature.
2. Subject the mobile station to overnight soak at -30 C.
3. With the mobile station, powered with V_{nom} , connected to the CMU200 and in a simulated call on channel 189 (centre channel), measure the carrier frequency. These measurements should be made within two minutes of powering up the mobile station, to prevent significant self warming.
4. Repeat the above measurements at 10°C increments from -30°C to +60°C. Allow at least 1.5 hours at each temperature, unpowered, before making measurements.
5. Remeasure carrier frequency at room temperature with V_{nom} . Vary supply voltage from V_{min} to V_{max} , in 0.1 Volt steps remeasuring carrier frequency at each voltage. Pause at V_{nom} for 1.5 hours unpowered, to allow any self heating to stabilize, before continuing.
6. At all temperature levels hold the temperature to +/- 0.5°C during the measurement procedure.

Measurement:

Measurement parameters	
Detector:	Measured with CMU200
Sweep time:	
Video bandwidth:	
Resolution bandwidth:	
Span:	
Trace-Mode:	

Limits:

FCC	IC
CFR Part 22.355 CFR Part 2.1055	RSS 132
Frequency Stability	
± 2.5 ppm	

Results:**AFC FREQ ERROR versus VOLTAGE**

Voltage (V)	Frequency Error (Hz)	Frequency Error (%)	Frequency Error (ppm)
3.3	-11	-0.00000132	-0.0132
3.4	7	0.00000084	0.0084
3.5	-7	-0.00000084	-0.0084
3.6	-5	-0.00000060	-0.0060
3.7	9	0.00000108	0.0108
3.8	-8	-0.00000096	-0.0096
3.9	-5	-0.00000060	-0.0060
4.0	-10	-0.00000120	-0.0120
4.1	-7	-0.00000084	-0.0084
4.2	9	0.00000108	0.0108
4.3	-7	-0.00000084	-0.0084
4.4	-12	-0.00000143	-0.0143

AFC FREQ ERROR versus TEMPERATURE

Temperature (°C)	Frequency Error (Hz)	Frequency Error (%)	Frequency Error (ppm)
-30	-16	-0.00000191	-0.0191
-20	-15	-0.00000179	-0.0179
-10	-9	-0.00000108	-0.0108
± 0	6	0.00000072	0.0072
10	9	0.00000108	0.0108
20	-8	-0.00000096	-0.0096
30	-13	-0.00000155	-0.0155
40	-8	-0.00000096	-0.0096
50	-10	-0.00000120	-0.0120
60	-16	-0.00000191	-0.0191

Frequency Error vs. Voltage

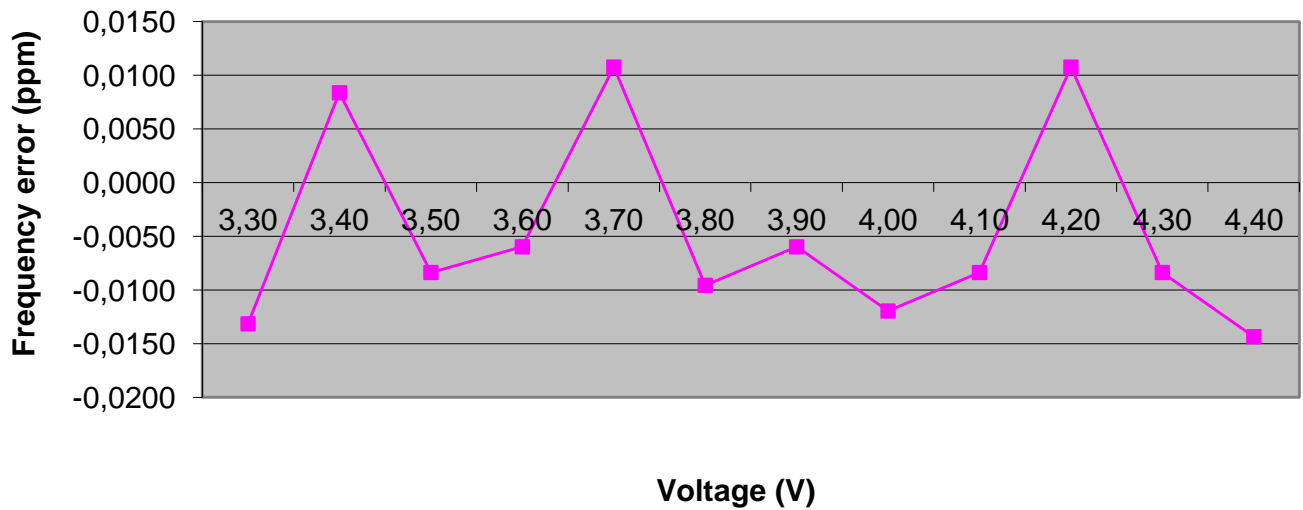

Frequency Error vs. Temperature

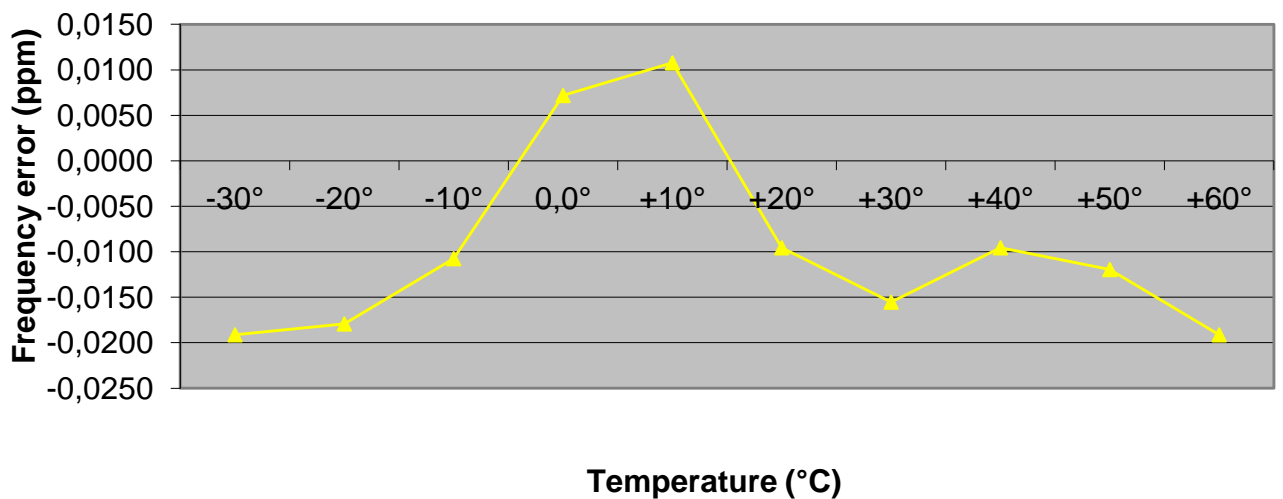

Result: **Passed**

8.3.3 Spurious emissions radiated

Description:

The following steps outline the procedure used to measure the radiated emissions from the mobile station. The site is constructed in accordance with ANSI C63.4:2009 requirements and is recognized by the FCC to be in compliance for a 3 and a 10 meter site. The spectrum was scanned from 30 MHz to the 10th harmonic of the highest frequency generated within the equipment, which is the transmitted carrier that can be as high as 848.8 MHz. This was rounded up to 12 GHz. The resolution bandwidth is set as outlined in Part 22.917. The spectrum was scanned with the mobile station transmitting at carrier frequencies that pertain to low, mid and high channels of the GSM-850 band.

The final open field emission (here 10m semi-anechoic chamber listed by FCC) test procedure is as follows:

- a) The test item was placed on a 0.8 meter high non-conductive stand at a 3 meter test distance from the receive antenna.
- b) The antenna output was terminated in a 50 ohm load (if possible).
- c) A double ridged wave guide antenna was placed on an adjustable height antenna mast 3 meters from the test item for emission measurements.
- d) Detected emissions were maximized at each frequency by rotating the test item and adjusting the receive antenna height and polarization. The maximum meter reading was recorded. The radiated emission measurements of the harmonics of the transmit frequency through the 10th harmonic were measured with peak detector and 1 MHz bandwidth. If the harmonic could not be detected above the noise floor, the ambient level was recorded. The equivalent power into a dipole antenna was calculated from the field intensity levels measured at 3 meters.
- e) Now each detected emissions were substituted by the substitution method, in accordance with the TIA/EIA 603.

Measurement:

Measurement parameters	
Detector:	Peak
Sweep time:	2 sec.
Video bandwidth:	Below 1 GHz: 100 kHz Above 1 GHz: 1 MHz
Resolution bandwidth:	Below 1 GHz: 100 kHz Above 1 GHz: 1 MHz
Span:	100 MHz Steps
Trace-Mode:	Max Hold

Limits:

FCC	IC
CFR Part 22.917 CFR Part 2.1053	RSS 132
Spurious Emissions Radiated	
Attenuation $\geq 43 + 10\log(P)$ (P, Power in Watts)	
-13 dBm	

Results:

Radiated emissions measurements were made only at the upper, center, and lower carrier frequencies of the GSM-850 band (824.2 MHz, 836.4 MHz and 848.8 MHz). It was decided that measurements at these three carrier frequencies would be sufficient to demonstrate compliance with emissions limits because it was seen that all the significant spurs occur well outside the band and no radiation was seen from a carrier in one block of the GSM-850 band into any of the other blocks. The equipment must still, however, meet emissions requirements with the carrier at all frequencies over which it is capable of operating and it is the manufacturer's responsibility to verify this.

The final open field radiated levels are presented on the next pages. All measurements were done in horizontal and vertical polarization; the plots show the worst case. The plots show only the middle channel. If spurious were detected, the lowest and highest channel were checked too. The found values are stated in the table below.

As can be seen from this data, the emissions from the test item were within the specification limit.

SPURIOUS EMISSION LEVEL (dBm)								
Harmonic	Ch. 128 Freq. (MHz)	Level [dBm]	Harmonic	Ch. 189 Freq. (MHz)	Level [dBm]	Harmonic	Ch. 251 Freq. (MHz)	Level [dBm]
2	1648.4	No emission detected closer than 20 dB to the limit line.	2	1672.8	No emission detected closer than 20 dB to the limit line.	2	1697.6	No emission detected closer than 20 dB to the limit line.
3	2472.6		3	2509.2		3	2546.4	
4	3296.8		4	3345.6		4	3395.2	
5	4121.0		5	4182.0		5	4244.0	
6	4945.2		6	5018.4		6	5092.8	
7	5769.4		7	5854.8		7	5941.6	
8	6593.6		8	6691.2		8	6790.4	
9	7417.8		9	7527.6		9	7639.2	
10	8242.0		10	8364.0		10	8488.0	
Measurement uncertainty						± 3dB		

Result: Passed

Plots:

Plot 1: Channel 189 (Traffic mode up to 30 MHz)

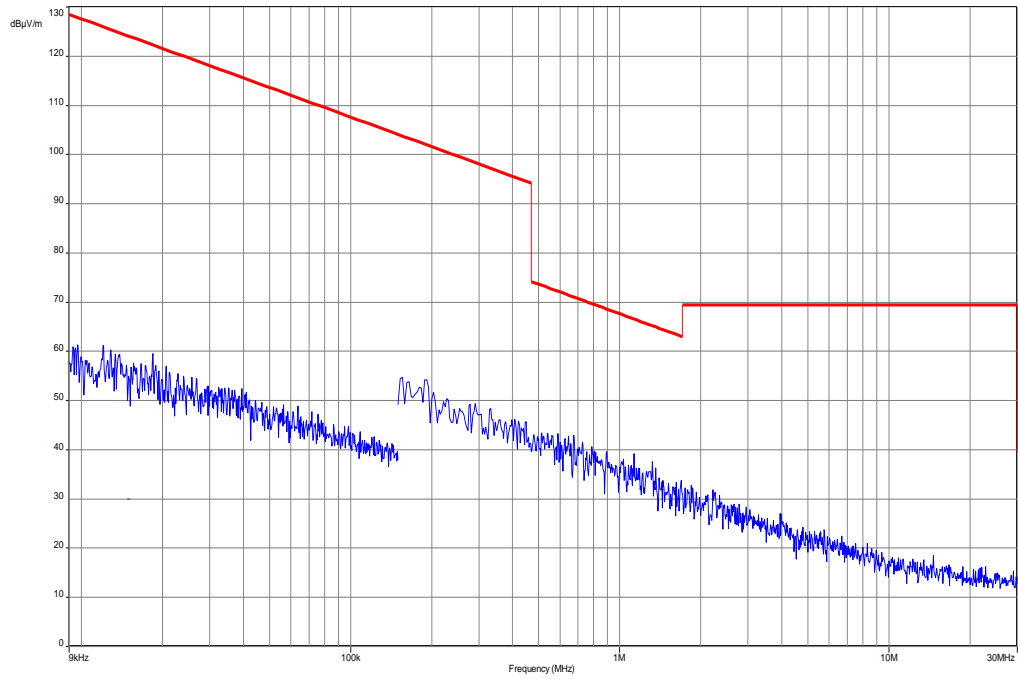

Plot 2: Channel 189 (30 MHz – 12.75 GHz)

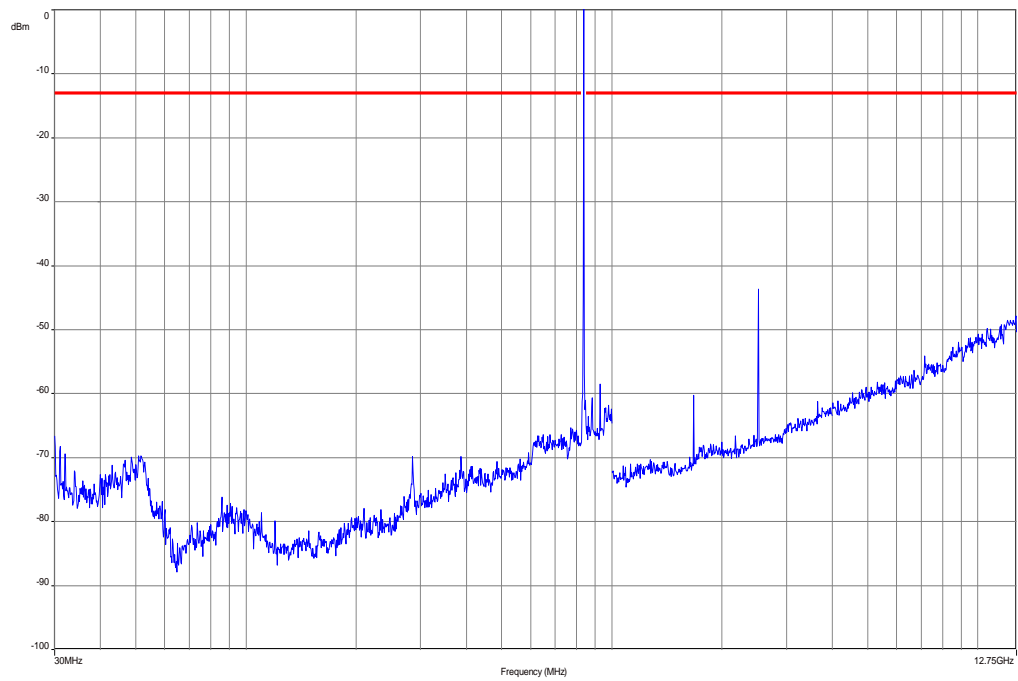

8.3.4 Spurious emissions conducted

Description:

The following steps outline the procedure used to measure the conducted emissions from the mobile station.

1. Determine frequency range for measurements: From CFR 2.1057 the spectrum should be investigated from the lowest radio frequency generated in the equipment up to at least the 10th harmonic of the carrier frequency. For the mobile station equipment tested, this equates to a frequency range of 13 MHz to 9 GHz, data taken from 10 MHz to 12 GHz.
2. Determine mobile station transmits frequencies: below outlines the band edge frequencies pertinent to conducted emissions testing.

GSM-850 Transmitter Channel Frequency
 128 824.2 MHz
 189 836.4 MHz
 251 848.8 MHz

Measurement:

Measurement parameters	
Detector:	Peak
Sweep time:	Auto
Video bandwidth:	Pre-measurement with 1 MHz On spurious detection re-measurement below 1 GHz with 100 kHz Above 1 GHz with 1 MHz
Resolution bandwidth:	Pre-measurement with 1 MHz On spurious detection re-measurement below 1 GHz with 100 kHz Above 1 GHz with 1 MHz
Span:	30 MHz – 25 GHz
Trace-Mode:	Max Hold

Limits:

FCC	IC
CFR Part 22.917 CFR Part 2.1051	RSS 132
Spurious Emissions Conducted	
Attenuation $\geq 43 + 10\log(P)$ (P, Power in Watts)	
-13 dBm	

Results:

SPURIOUS EMISSION LEVEL (dBm)								
Harmonic	Ch. 128 Freq. (MHz)	Level [dBm]	Harmonic	Ch. 189 Freq. (MHz)	Level [dBm]	Harmonic	Ch. 251 Freq. (MHz)	Level [dBm]
2	1648.4	No emission detected closer than 15 dB to the limit line.	2	1672.8	No emission detected closer than 15 dB to the limit line.	2	1697.6	No emission detected closer than 15 dB to the limit line.
3	2472.6		3	2509.2		3	2546.4	
4	3296.8		4	3345.6		4	3395.2	
5	4121.0		5	4182.0		5	4244.0	
6	4945.2		6	5018.4		6	5092.8	
7	5769.4		7	5854.8		7	5941.6	
8	6593.6		8	6691.2		8	6790.4	
9	7417.8		9	7527.6		9	7639.2	
10	8242.0		10	8364.0		10	8488.0	
Measurement uncertainty						± 3dB		

Result: Passed

Plots:

Plot 1: Channel 128 (10 MHz - 25 GHz)

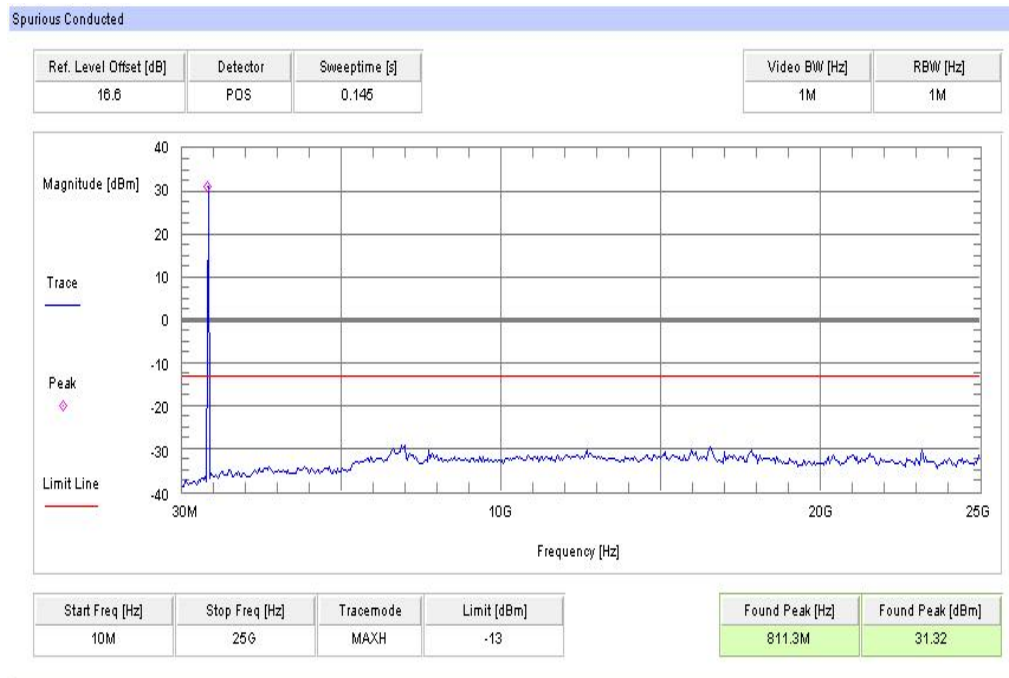

Plot 2: Channel 189 (10 MHz - 25 GHz)

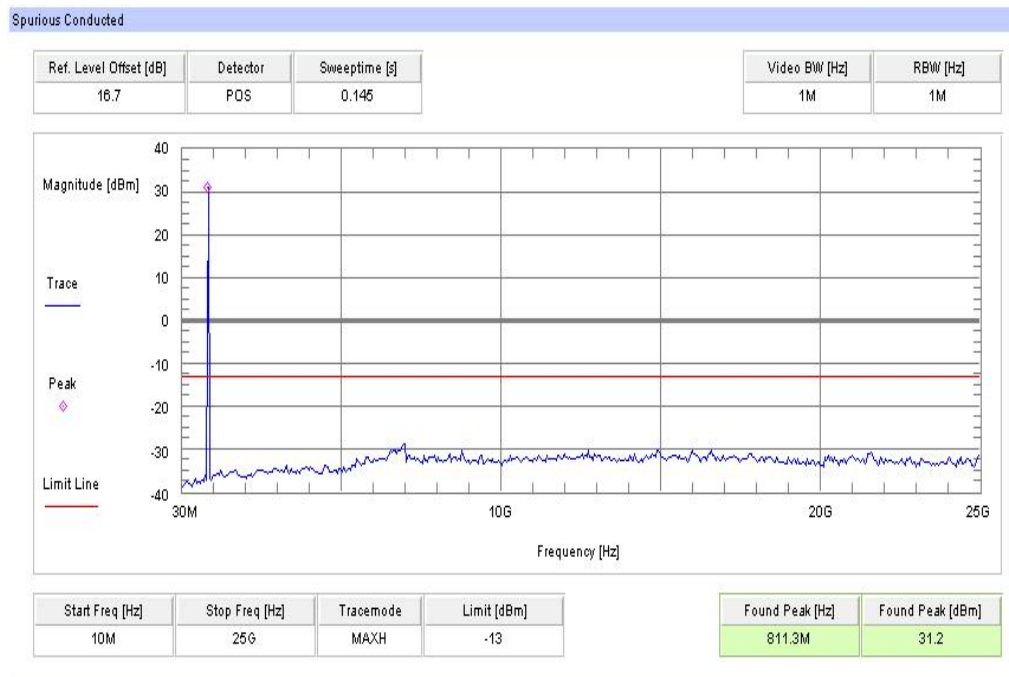

Plot 3: Channel 251 (10 MHz - 25 GHz)

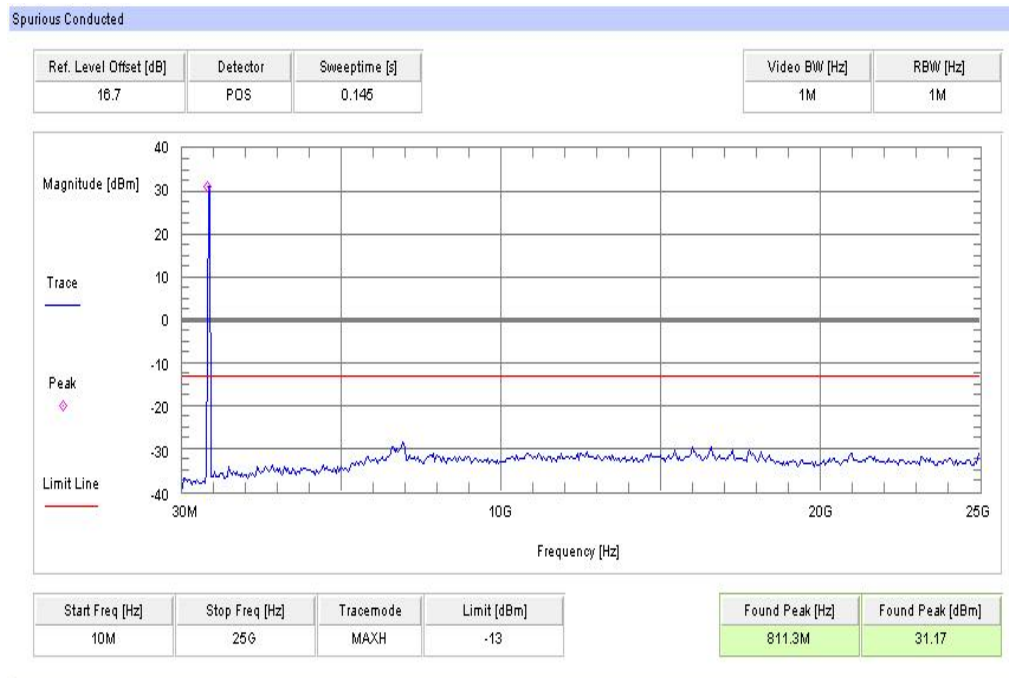

8.3.5 Block edge compliance

Description:

The spectrum at the band edges must comply with the spurious emissions limits.

Measurement:

Measurement parameters	
Detector:	RMS
Sweep time:	Auto
Video bandwidth:	3 kHz
Resolution bandwidth:	3 kHz
Span:	1 MHz
Trace-Mode:	Max Hold

Limits:

FCC	IC
CFR Part 22.917 CFR Part 2.1051	RSS 132
Block Edge Compliance	
Attenuation $\geq 43 + 10\log(P)$ (P, Power in Watts)	
-13 dBm	

Plots:

Plot 1: Channel 128 (GSM-mode)



Plot 2: Channel 251 (GSM-mode)



Plot 3: Channel 128 (EDGE-mode)

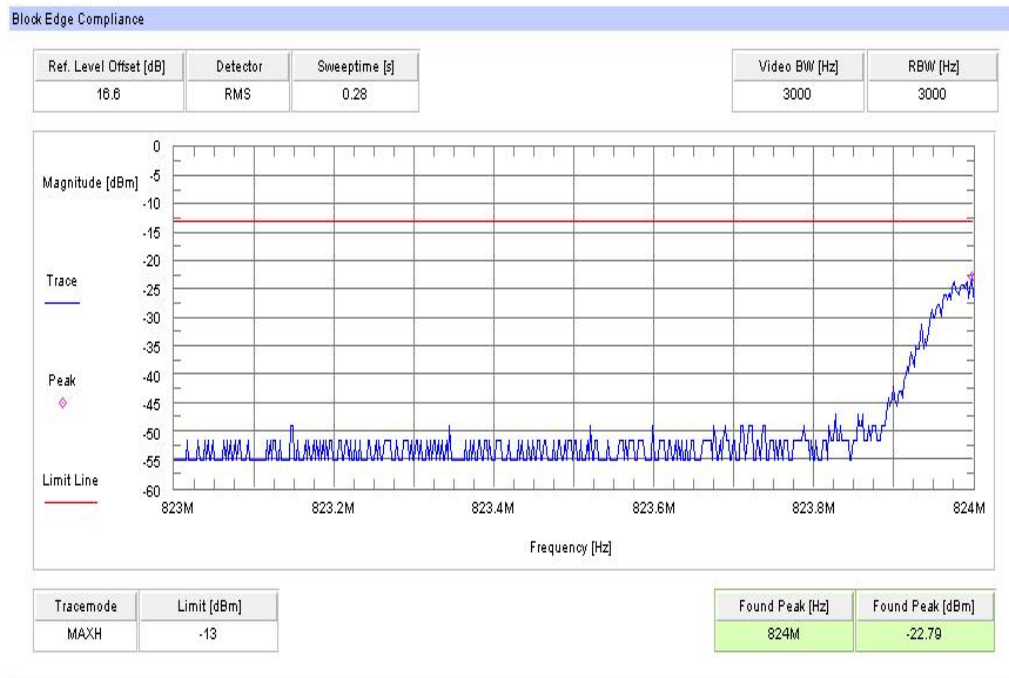

Plot 4: Channel 251 (EDGE-mode)



Result: Passed

8.3.6 Occupied bandwidth

Description:

Measurement of the occupied bandwidth of the transmitted signal.

Measurement:

Similar to conducted emissions, occupied bandwidth measurements are only provided for selected frequencies in order to reduce the amount of submitted data. Data were taken at the extreme and mid frequencies of the GSM-850 frequency band. The table below lists the measured 99% power and -26dBc occupied bandwidths. Spectrum analyzer plots are included on the following pages.

Part 22.917 requires a measurement bandwidth of at least 1% of the occupied bandwidth. For ca. 300 kHz, this equates to a resolution bandwidth of at least 3 kHz. For this testing, a resolution bandwidth 3.0 kHz was used.

Measurement parameters	
Detector:	Peak
Sweep time:	Auto
Video bandwidth:	30 kHz
Resolution bandwidth:	10 kHz
Span:	1 MHz
Trace-Mode:	Max Hold

Limits:

FCC	IC
CFR Part 22.917 CFR Part 2.1049	RSS 132
Occupied Bandwidth	
Spectrum must fall completely in the specified band	

Results:

Occupied Bandwidth - GMSK mode		
Frequency (MHz)	99% OBW (kHz)	-26 dBc BW (kHz)
824.2	289	323
836.4	271	315
848.8	273	317
Measurement uncertainty	± 3 kHz	

Occupied Bandwidth - EDGE mode		
Frequency (MHz)	99% OBW (kHz)	-26 dBc BW (kHz)
824.2	275	305
836.4	277	317
848.8	273	313
Measurement uncertainty	± 3 kHz	

Result: Passed

Plots:

Plot 1: Channel 128 (99% - OBW)



Plot 2: Channel 128 (-26 dBc BW)

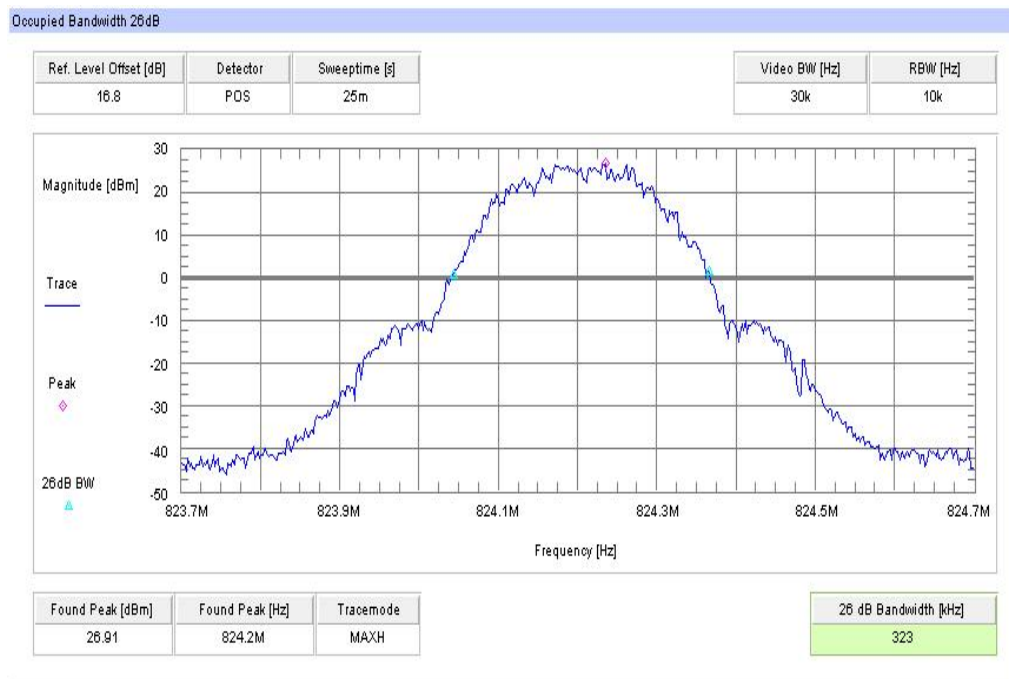

Plot 3: Channel 189 (99% - OBW)



Plot 4: Channel 189 (-26 dBc BW)

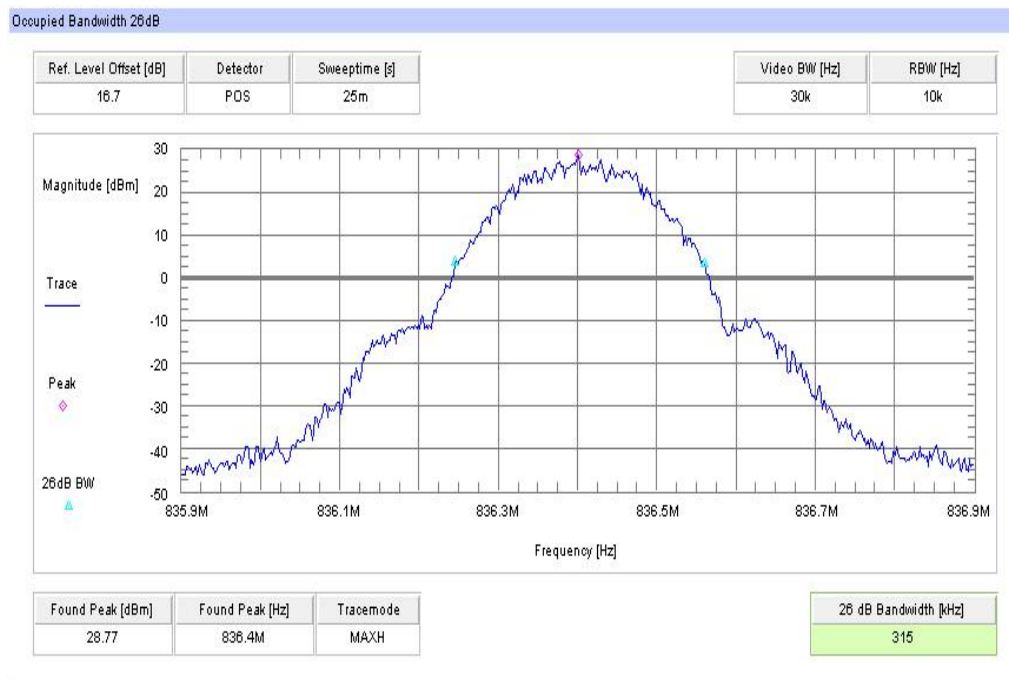

Plot 5: Channel 251 (99% - OBW)

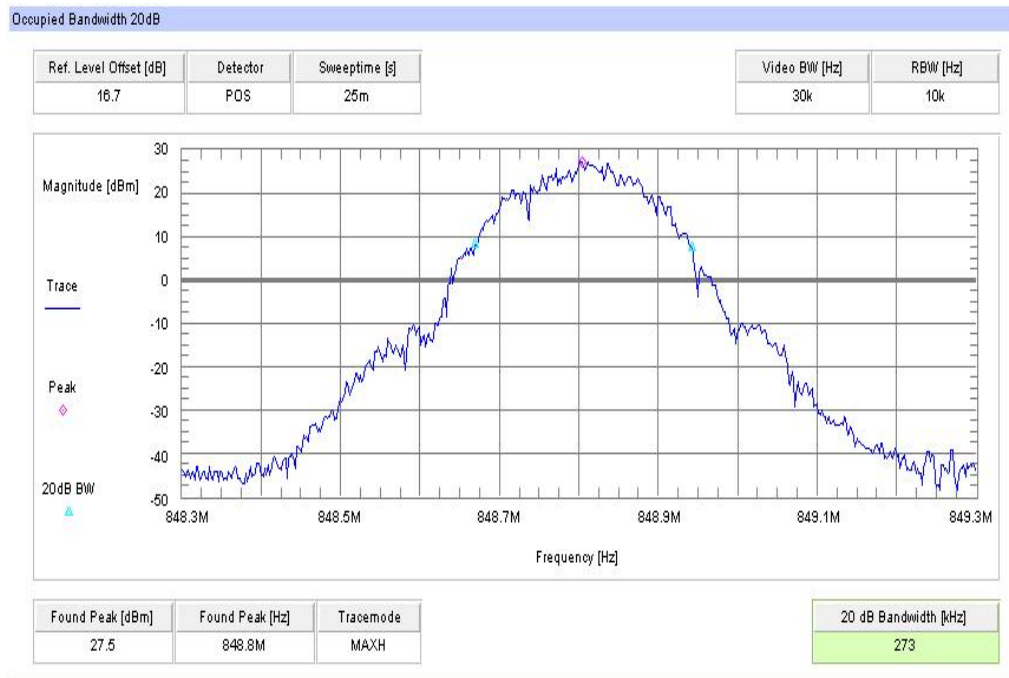

Plot 6: Channel 251 (-26 dBc BW)

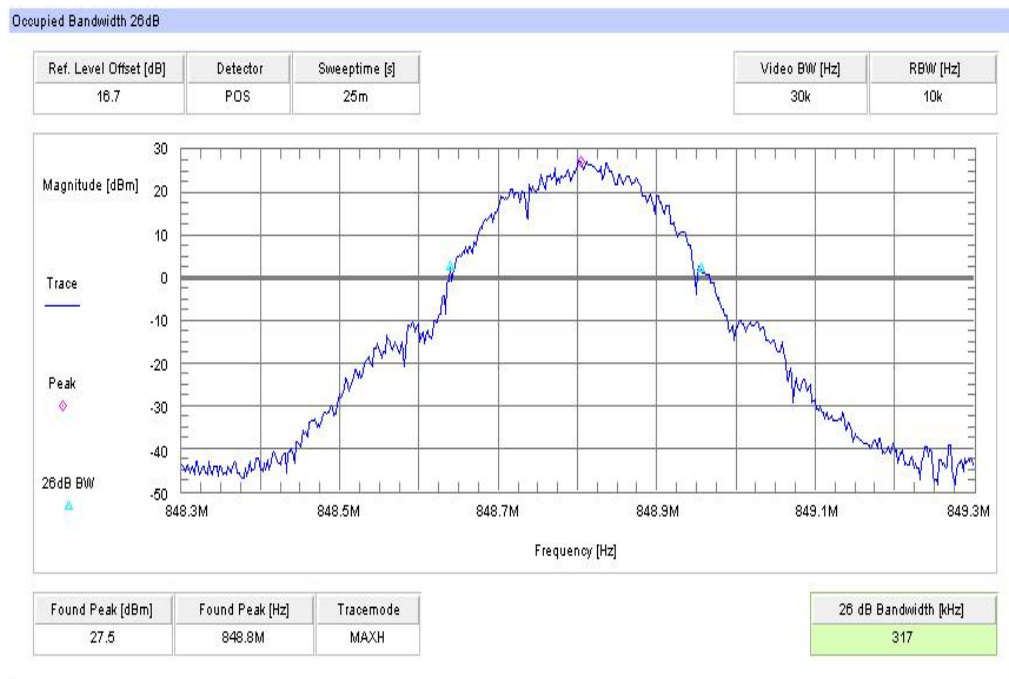

Plot 7: Channel 128 (99% - OBW) - EDGE



Plot 8: Channel 128 (-26 dBc BW) - EDGE

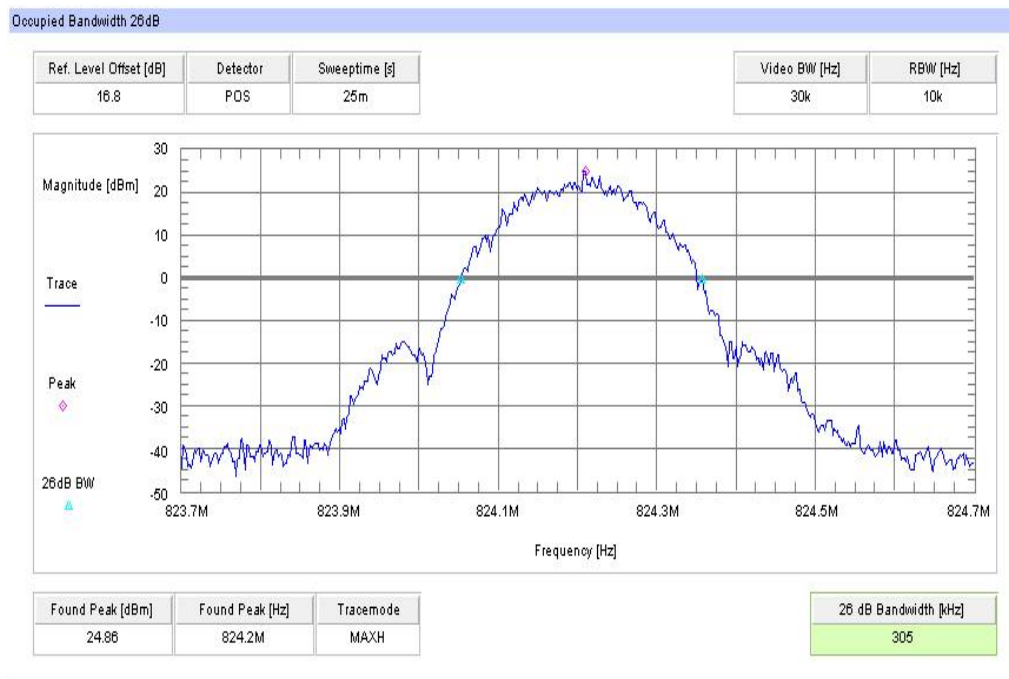

Plot 9: Channel 189 (99% - OBW) - EDGE

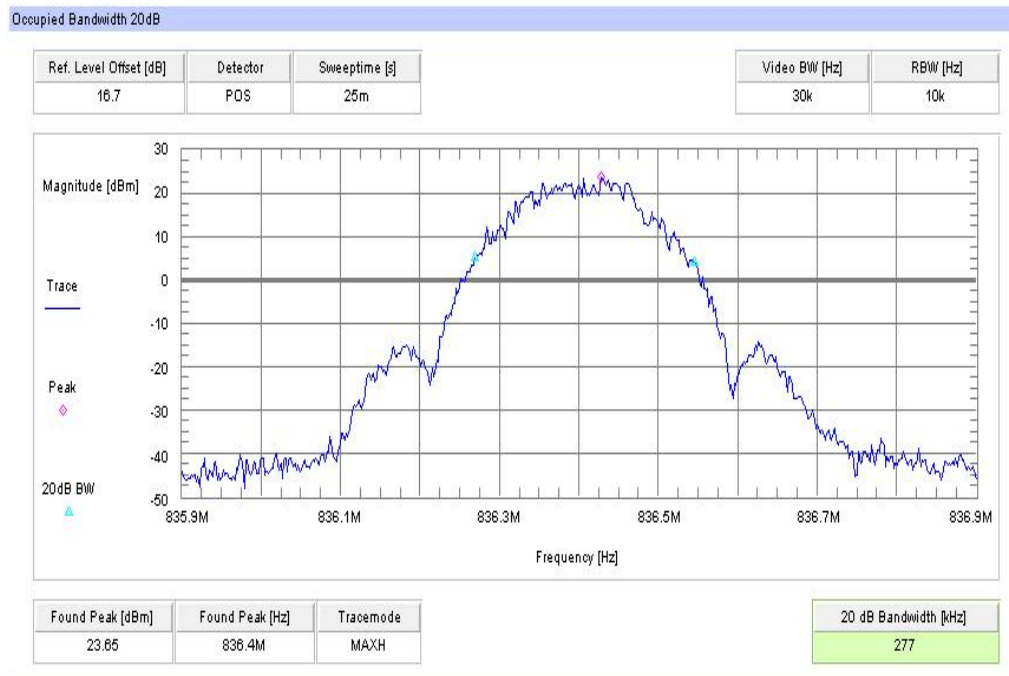

Plot 10: Channel 189 (-26 dBc BW) - EDGE

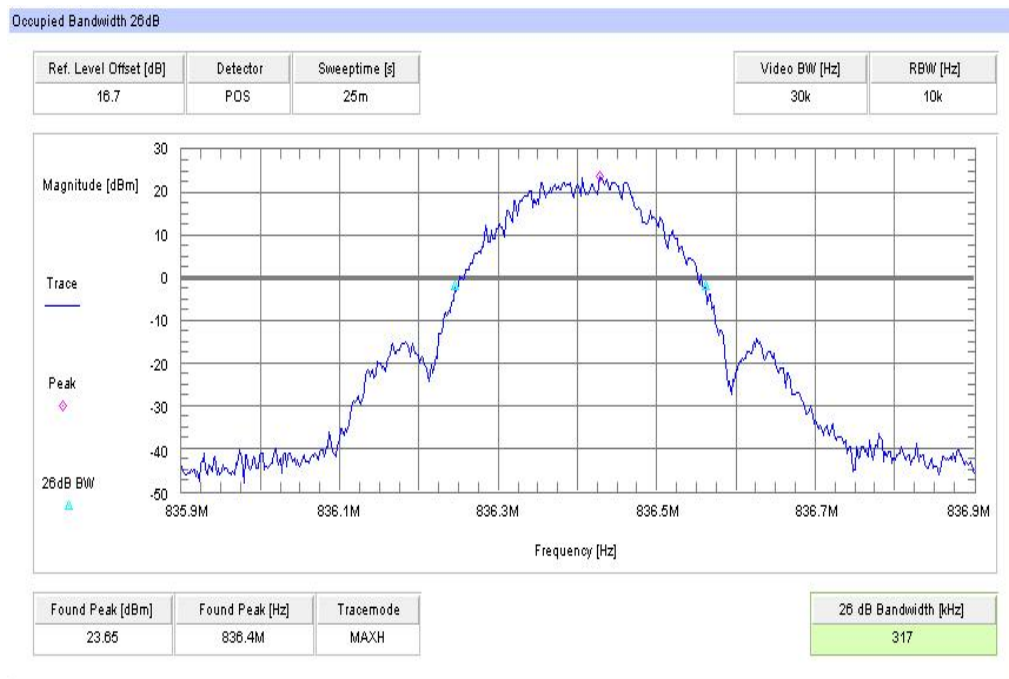

Plot 11: Channel 251 (99% - OBW) - EDGE

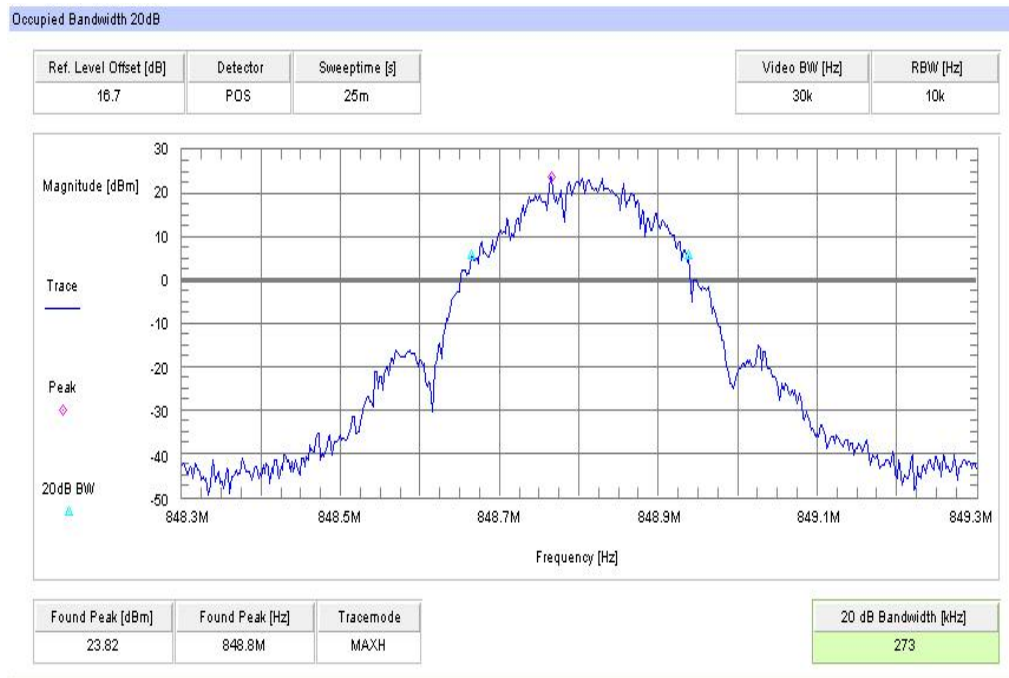

Plot 12: Channel 251 (-26 dBc BW) - EDGE

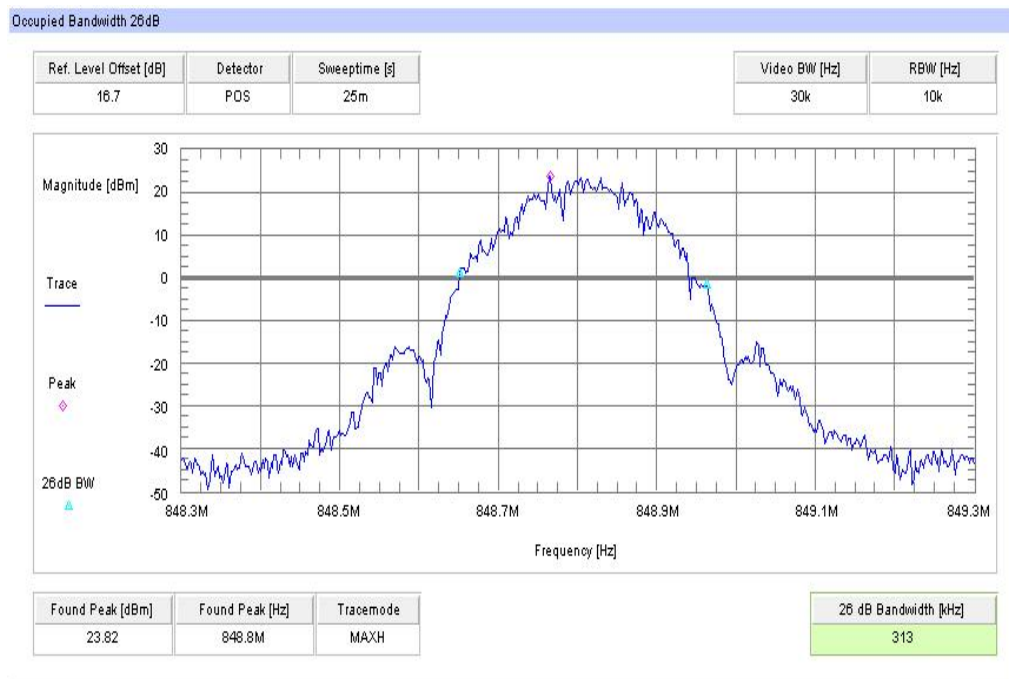

8.4 Results PCS 1900

All GSM-band measurements are done in GSM mode only (circuit switched).

All relevant tests have been repeated using 8-PSK modulation if EDGE mode is supported. All tests were performed with one timeslot in uplink activated and one timeslot in downlink activated. For each mode the highest output power was determined and used.

8.4.1 RF output power

Description:

This paragraph contains average power, peak output power and EIRP measurements for the mobile station. In all cases, the peak output power is within the required mask (this mask is specified in the JTC standards, TIA PN3389 Vol. 1 Chap 7, and is no FCC requirement).

Measurement:

The mobile was set up for the maximum output power with pseudo random data modulation.

Measurement parameters	
Detector:	Peak and RMS (Power in Burst)
Sweep time:	Auto
Video bandwidth:	1 MHz
Resolution bandwidth:	1 MHz
Span:	Zero Span
Trace-Mode:	Max Hold

Limits:

FCC	IC
CFR Part 24.232 CFR Part 2.1046	RSS 133
Nominal Peak Output Power	
+33.00 dBm In measuring transmissions in this band using an average power technique, the peak-to-average ratio (PAR) of the transmission may not exceed 13 dB.	

Results:

Output Power (conducted) GMSK mode		
Frequency (MHz)	Average Output Power (dBm)	Peak to Average Ratio (dB)
1850.2	28.39	0.05
1880.0	28.24	0.07
1909.8	28.49	0.08
Measurement uncertainty	± 0.5 dB	

Output Power (conducted) 8-PSK mode		
Frequency (MHz)	Average Output Power (dBm)	Peak to Average Ratio (dB)
1850.2	26.56	3.15
1880.0	26.76	2.93
1909.8	26.48	3.07
Measurement uncertainty	± 0.5 dB	

Output Power (radiated) GMSK mode	
Frequency (MHz)	Average Output Power (dBm) - EIRP
1850.2	32.0
1880.0	32.8
1909.8	33.0
Measurement uncertainty	± 2.0 dB

Output Power (radiated) 8-PSK mode	
Frequency (MHz)	Average Output Power (dBm) - EIRP
1850.2	30.17
1880.0	31.32
1909.8	30.99
Measurement uncertainty	± 2.0 dB

Result: **Passed**

8.4.2 Frequency stability

Description:

In order to measure the carrier frequency under the condition of AFC lock, it is necessary to make measurements with the mobile station in a “call mode”. This is accomplished with the use of a R&S CMU200 DIGITAL RADIOCOMMUNICATION TESTER.

1. Measure the carrier frequency at room temperature.
2. Subject the mobile station to overnight soak at -30 C.
3. With the mobile station, powered with V_{nom} , connected to the CMU200 and in a simulated call on channel 661 (centre channel), measure the carrier frequency. These measurements should be made within two minutes of powering up the mobile station, to prevent significant self warming.
4. Repeat the above measurements at 10°C increments from -30°C to +60°C. Allow at least 1.5 hours at each temperature, unpowered, before making measurements.
5. Remeasure carrier frequency at room temperature with V_{nom} . Vary supply voltage from V_{min} to V_{max} , in 0.1 Volt steps remeasuring carrier frequency at each voltage. Pause at V_{nom} for 1.5 hours unpowered, to allow any self heating to stabilize, before continuing.
6. At all temperature levels hold the temperature to +/- 0.5°C during the measurement procedure.

Measurement:

Measurement parameters	
Detector:	Measured with CMU200
Sweep time:	
Video bandwidth:	
Resolution bandwidth:	
Span:	
Trace-Mode:	

Limits:

FCC	IC
CFR Part 24.235 CFR Part 2.1055	RSS 133
Frequency Stability	
The frequency stability shall be sufficient to ensure that the fundamental emission stays within the authorized frequency block.	

Results:**AFC FREQ ERROR versus VOLTAGE**

Voltage (V)	Frequency Error (Hz)	Frequency Error (%)	Frequency Error (ppm)
3.3	-18	-0.0000096	-0.0096
3.4	-23	-0.0000122	-0.0122
3.5	-21	-0.0000112	-0.0112
3.6	-23	-0.0000122	-0.0122
3.7	-20	-0.0000106	-0.0106
3.8	-15	-0.0000080	-0.0080
3.9	-15	-0.0000080	-0.0080
4.0	-16	-0.0000085	-0.0085
4.1	-20	-0.0000106	-0.0106
4.2	-22	-0.0000117	-0.0117
4.3	-24	-0.0000128	-0.0128
4.4	-25	-0.0000133	-0.0133

AFC FREQ ERROR versus TEMPERATURE

Temperature (°C)	Frequency Error (Hz)	Frequency Error (%)	Frequency Error (ppm)
-30	-27	-0.0000144	-0.0144
-20	-31	-0.0000165	-0.0165
-10	9	0.0000048	0.0048
± 0	-19	-0.0000101	-0.0101
10	-10	-0.0000053	-0.0053
20	-11	-0.0000059	-0.0059
30	10	0.0000053	0.0053
40	-25	-0.0000133	-0.0133
50	-23	-0.0000122	-0.0122
60	-25	-0.0000133	-0.0133

Frequency Error vs. Voltage

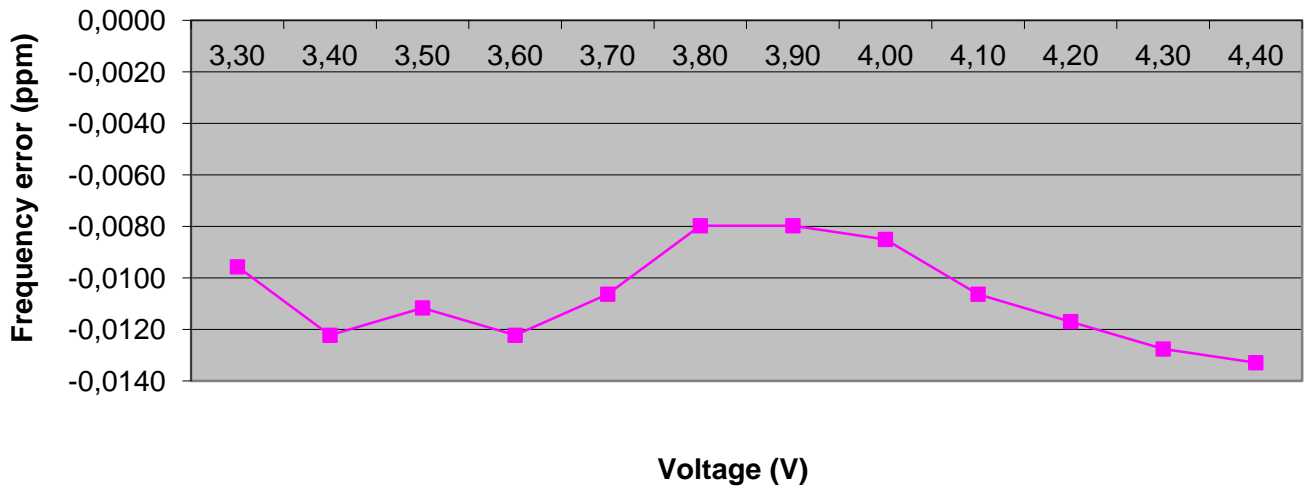

Frequency Error vs. Temperature

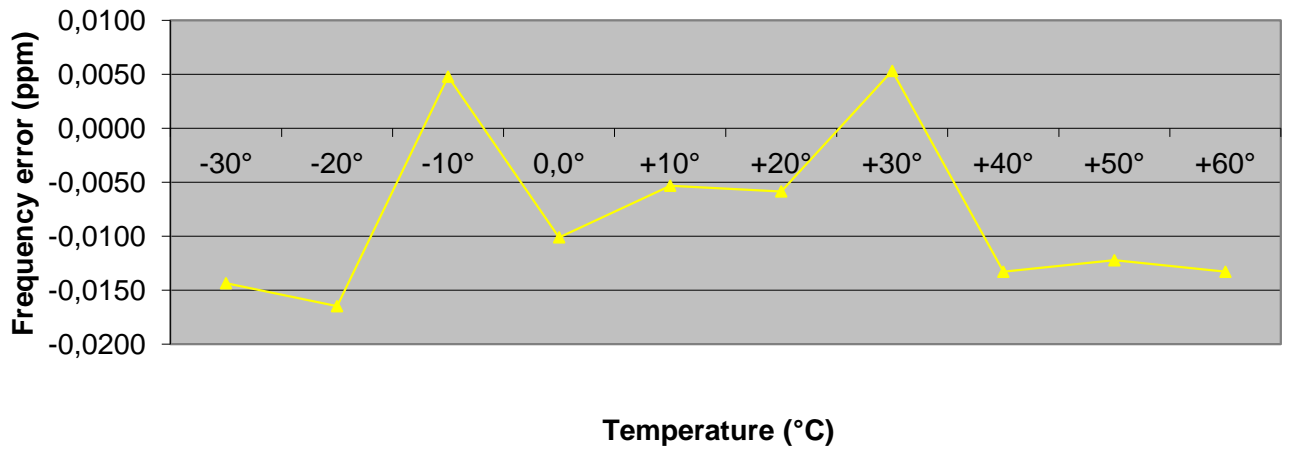

Result: Passed

8.4.3 Spurious emissions radiated

Description:

The following steps outline the procedure used to measure the radiated emissions from the mobile station. The site is constructed in accordance with ANSI C63.4:2009 requirements and is recognized by the FCC to be in compliance for a 3 and a 10 meter site. The spectrum was scanned from 30 MHz to the 10th harmonic of the highest frequency generated within the equipment, which is the transmitted carrier that can be as high as 1910 MHz. This was rounded up to 20 GHz. The resolution bandwidth is set as outlined in Part 24.238. The spectrum was scanned with the mobile station transmitting at carrier frequencies that pertain to low, mid and high channels of the PCS1900 band.

The final open field emission (here 10m semi-anechoic chamber listed by FCC) test procedure is as follows:

- a) The test item was placed on a 0.8 meter high non-conductive stand at a 3 meter test distance from the receive antenna.
- b) The antenna output was terminated in a 50 ohm load (if possible).
- c) A double ridged wave guide antenna was placed on an adjustable height antenna mast 3 meters from the test item for emission measurements.
- d) Detected emissions were maximized at each frequency by rotating the test item and adjusting the receive antenna height and polarization. The maximum meter reading was recorded. The radiated emission measurements of the harmonics of the transmit frequency through the 10th harmonic were measured with peak detector and 1 MHz bandwidth. If the harmonic could not be detected above the noise floor, the ambient level was recorded. The equivalent power into a dipole antenna was calculated from the field intensity levels measured at 3 meters.
- e) Now each detected emissions were substituted by the substitution method, in accordance with the TIA/EIA 603.

Measurement:

Measurement parameters	
Detector:	Peak
Sweep time:	2 sec.
Video bandwidth:	Below 1 GHz: 100 kHz Above 1 GHz: 1 MHz
Resolution bandwidth:	Below 1 GHz: 100 kHz Above 1 GHz: 1 MHz
Span:	100 MHz Steps
Trace-Mode:	Max Hold

Limits:

FCC	IC
CFR Part 24.238 CFR Part 2.1053	RSS 133
Spurious Emissions Radiated	
Attenuation $\geq 43 + 10\log(P)$ (P, Power in Watts)	
-13 dBm	

Results:

Radiated emissions measurements were made only at the upper, center, and lower carrier frequencies of the PCS1900 band (1850.2 MHz, 1880.0 MHz and 1909.8 MHz). It was decided that measurements at these three carrier frequencies would be sufficient to demonstrate compliance with emissions limits because it was seen that all the significant spurs occur well outside the band and no radiation was seen from a carrier in one block of the PCS1900 band into any of the other blocks. The equipment must still, however, meet emissions requirements with the carrier at all frequencies over which it is capable of operating and it is the manufacturer's responsibility to verify this.

The final open field radiated levels are presented on the next pages. All measurements were done in horizontal and vertical polarization; the plots show the worst case. The plots show only the middle channel. If spurious were detected, the lowest and highest channel were checked too. The found values are stated in the table below.

As can be seen from this data, the emissions from the test item were within the specification limit.

SPURIOUS EMISSION LEVEL (dBm)								
Harmonic	Ch. 512 Freq. (MHz)	Level [dBm]	Harmonic	Ch. 661 Freq. (MHz)	Level [dBm]	Harmonic	Ch. 810 Freq. (MHz)	Level [dBm]
2	3700.4	No emission detected closer than 20 dB to the limit line.	2	3760.0	No emission detected closer than 20 dB to the limit line.	2	3819.6	No emission detected closer than 20 dB to the limit line.
3	5550.6		3	5640.0		3	5729.4	
4	7400.8		4	7520.0		4	7639.2	
5	9251.0		5	9400.0		5	9549.0	
6	11101.2		6	11280.0		6	11458.8	
7	12951.4		7	13160.0		7	13368.6	
8	14801.6		8	15040.0		8	15278.4	
9	16651.8		9	16920.0		9	17188.2	
10	18502.0		10	18800.0		10	19098.0	
Measurement uncertainty						± 3dB		

Result: Passed

Plots:

Plot 1: Channel 661 (Traffic mode up to 30 MHz)

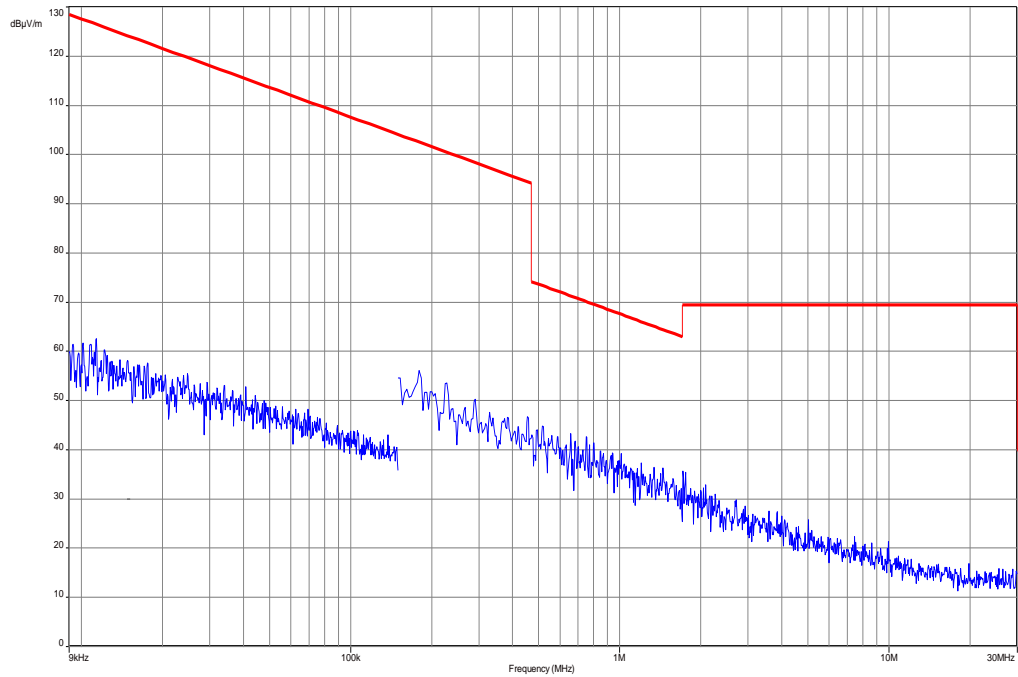

Plot 2: Channel 661 (30 MHz – 12.75 GHz)

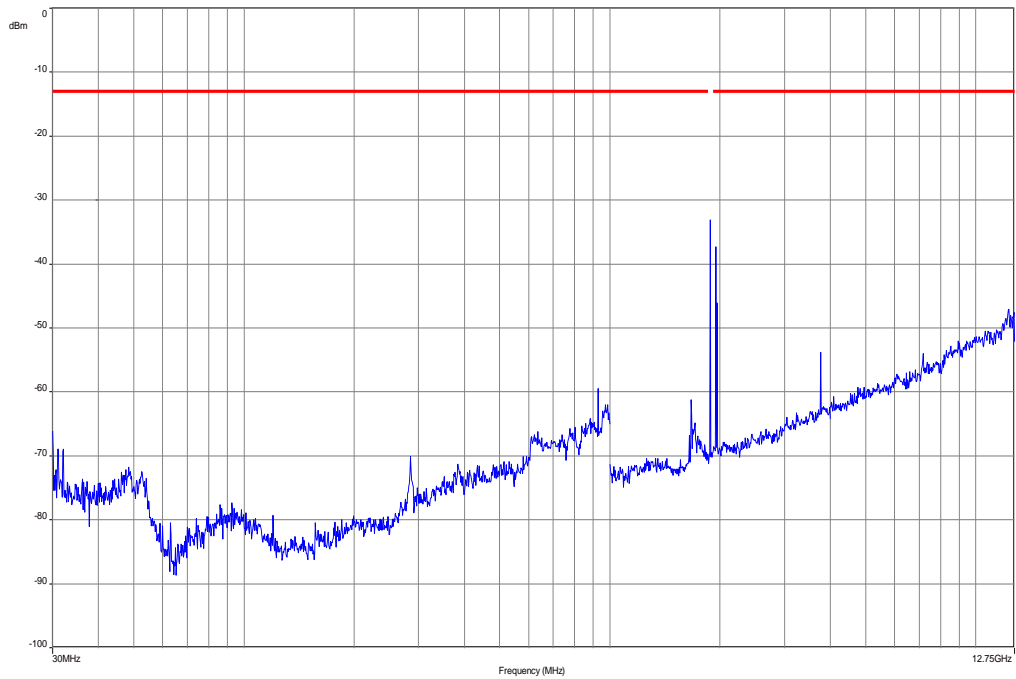

Carrier notched with 1.9 GHz rejection filter

Plot 3: Channel 661 (12.75 GHz – 18 GHz)

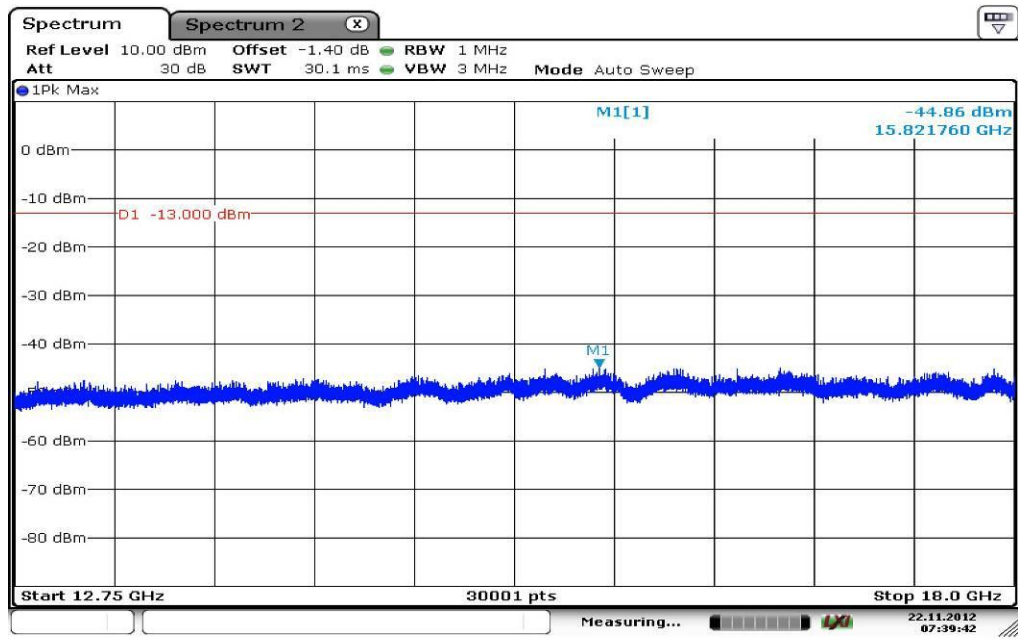

Date: 22.NOV.2012 07:39:43

Plot 4: Channel 661 (18 GHz – 25 GHz)

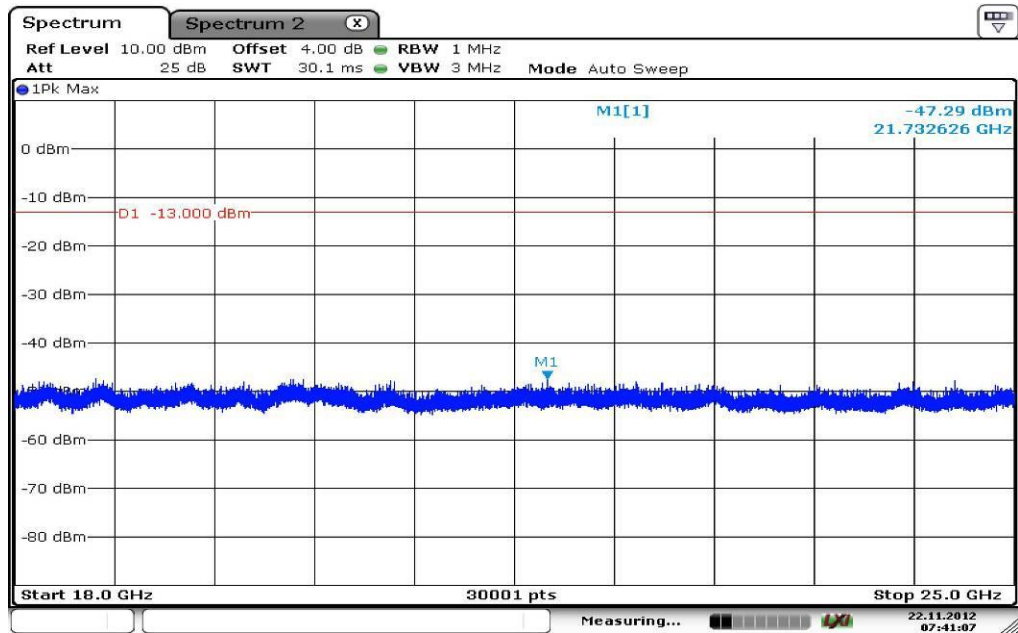

Date: 22.NOV.2012 07:41:07

8.4.4 Spurious emissions conducted

Description:

The following steps outline the procedure used to measure the conducted emissions from the mobile station.

1. Determine frequency range for measurements: From CFR 2.1057 the spectrum should be investigated from the lowest radio frequency generated in the equipment up to at least the 10th harmonic of the carrier frequency. For the mobile station equipment tested, this equates to a frequency range of 13 MHz to 19.1 GHz, data taken from 10 MHz to 20 GHz.
2. Determine mobile station transmits frequencies: below outlines the band edge frequencies pertinent to conducted emissions testing.

PCS1900 Transmitter Channel Frequency

512 1850.2 MHz

661 1880.0 MHz

810 1909.8 MHz

Measurement:

Measurement parameters	
Detector:	Peak
Sweep time:	Auto
Video bandwidth:	Pre-measurement with 1 MHz On spurious detection re-measurement below 1 GHz with 100 kHz Above 1 GHz with 1 MHz
Resolution bandwidth:	Pre-measurement with 1 MHz On spurious detection re-measurement below 1 GHz with 100 kHz Above 1 GHz with 1 MHz
Span:	30 MHz – 25 GHz
Trace-Mode:	Max Hold

Limits:

FCC	IC
CFR Part 24.238 CFR Part 2.1051	RSS 133
Spurious Emissions Conducted	
Attenuation $\geq 43 + 10\log(P)$ (P, Power in Watts)	
-13 dBm	

Results:

SPURIOUS EMISSION LEVEL (dBm)								
Harmonic	Ch. 512 Freq. (MHz)	Level [dBm]	Harmonic	Ch. 661 Freq. (MHz)	Level [dBm]	Harmonic	Ch. 810 Freq. (MHz)	Level [dBm]
2	3700.4	No emission detected closer than 15 dB to the limit line.	2	3760.0	No emission detected closer than 15 dB to the limit line.	2	3819.6	No emission detected closer than 15 dB to the limit line.
3	5550.6		3	5640.0		3	5729.4	
4	7400.8		4	7520.0		4	7639.2	
5	9251.0		5	9400.0		5	9549.0	
6	11101.2		6	11280.0		6	11458.8	
7	12951.4		7	13160.0		7	13368.6	
8	14801.6		8	15040.0		8	15278.4	
9	16651.8		9	16920.0		9	17188.2	
10	18502.0		10	18800.0		10	19098.0	
Measurement uncertainty						± 3dB		

Result: Passed

Plots:

Plot 1: Channel 512 (10 MHz - 25 GHz)

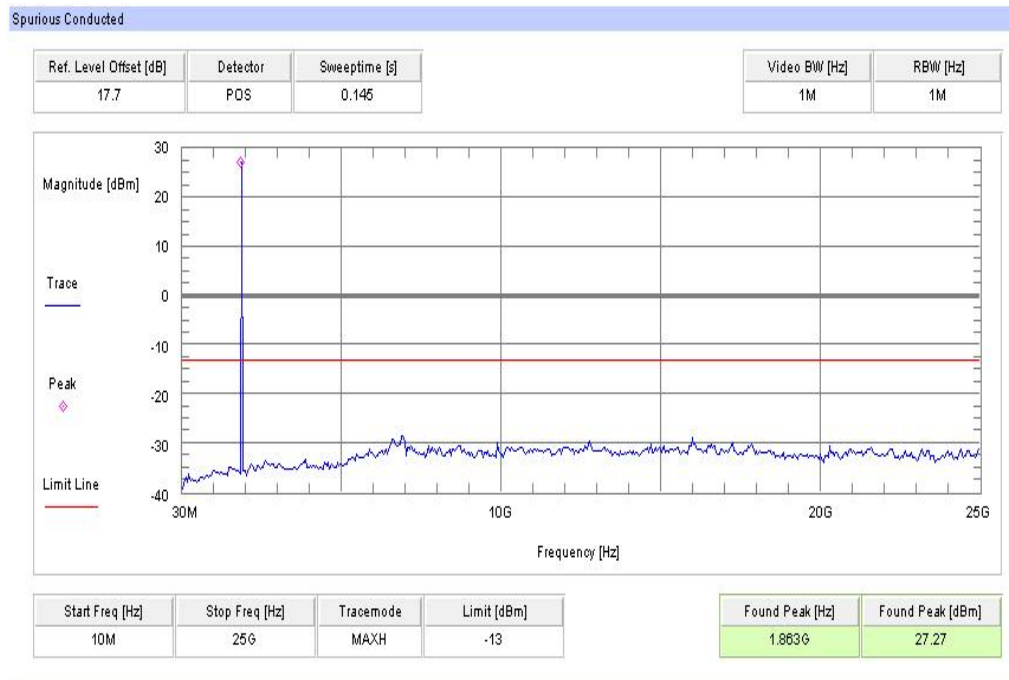

Plot 2: Channel 661 (10 MHz - 25 GHz)

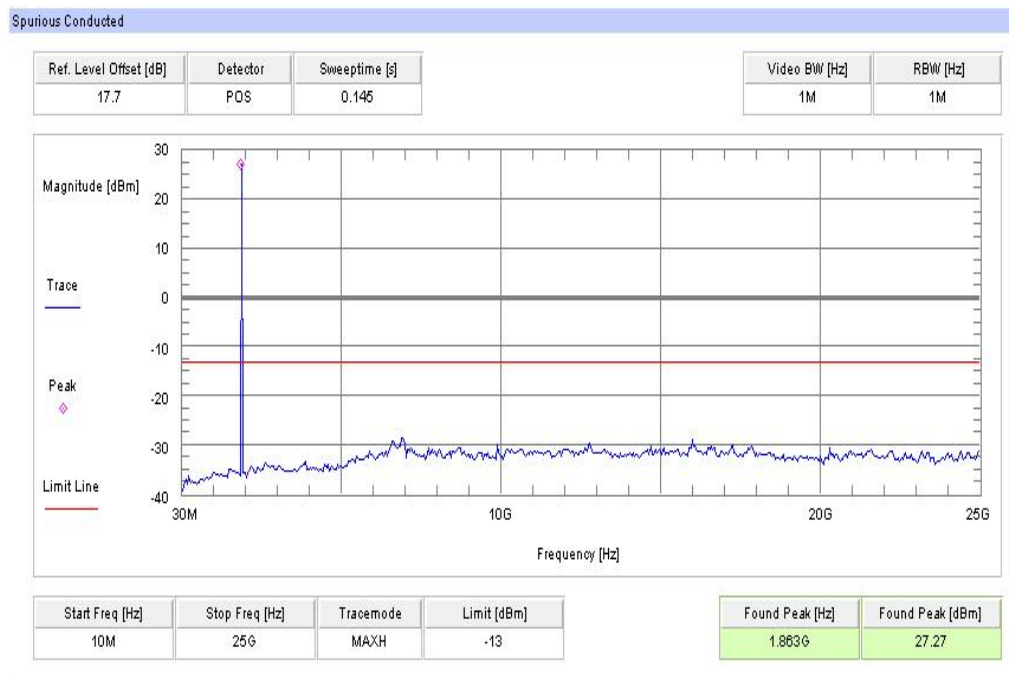

Plot 3: Channel 810 (10 MHz - 25 GHz)

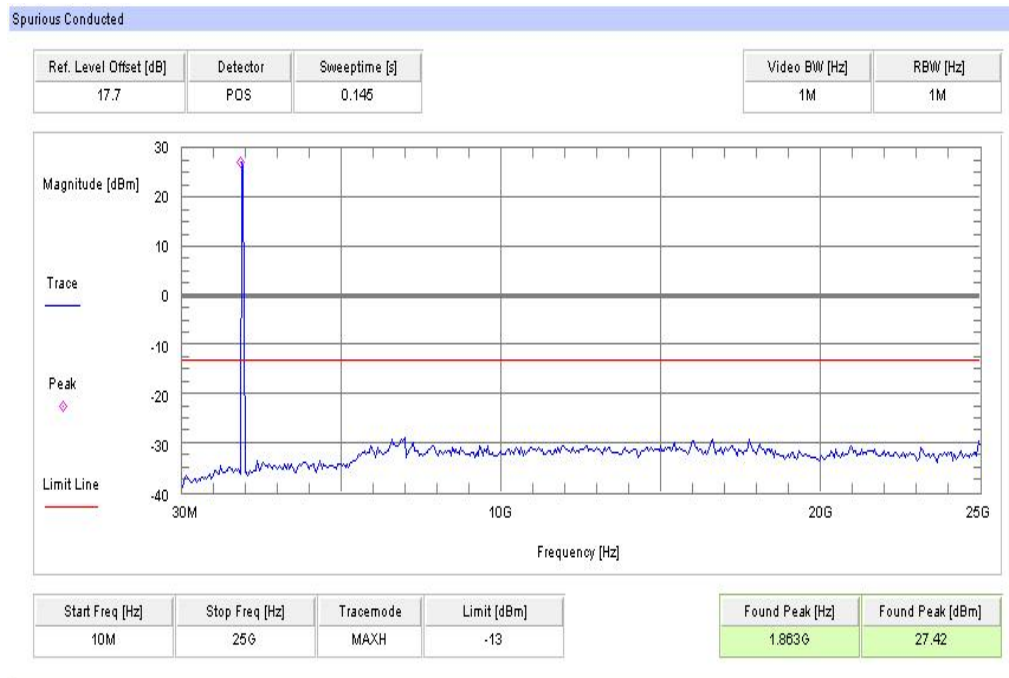

8.4.5 Block edge compliance

Description:

The spectrum at the band edges must comply with the spurious emissions limits.

Measurement:

Measurement parameters	
Detector:	RMS
Sweep time:	Auto
Video bandwidth:	3 kHz
Resolution bandwidth:	3 kHz
Span:	1 MHz
Trace-Mode:	Max Hold

Limits:

FCC	IC
CFR Part 24.238 CFR Part 2.1051	RSS 133
Block Edge Compliance	
Attenuation $\geq 43 + 10\log(P)$ (P, Power in Watts)	
-13 dBm	

Plots:

Plot 1: Channel 512 (GSM-mode)

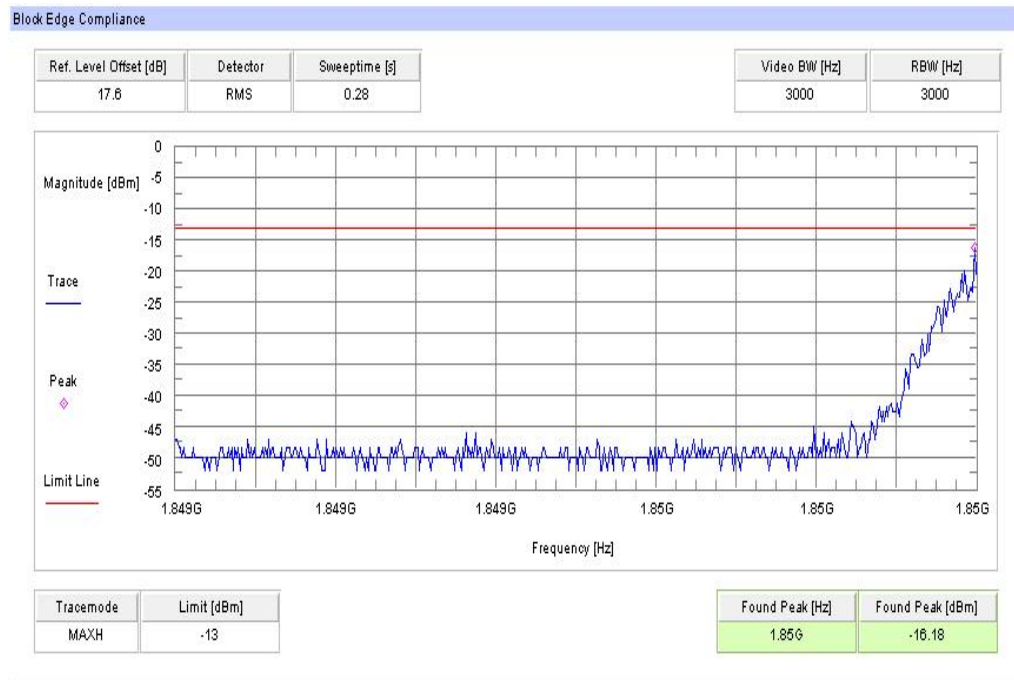

Plot 2: Channel 810 (GSM-mode)

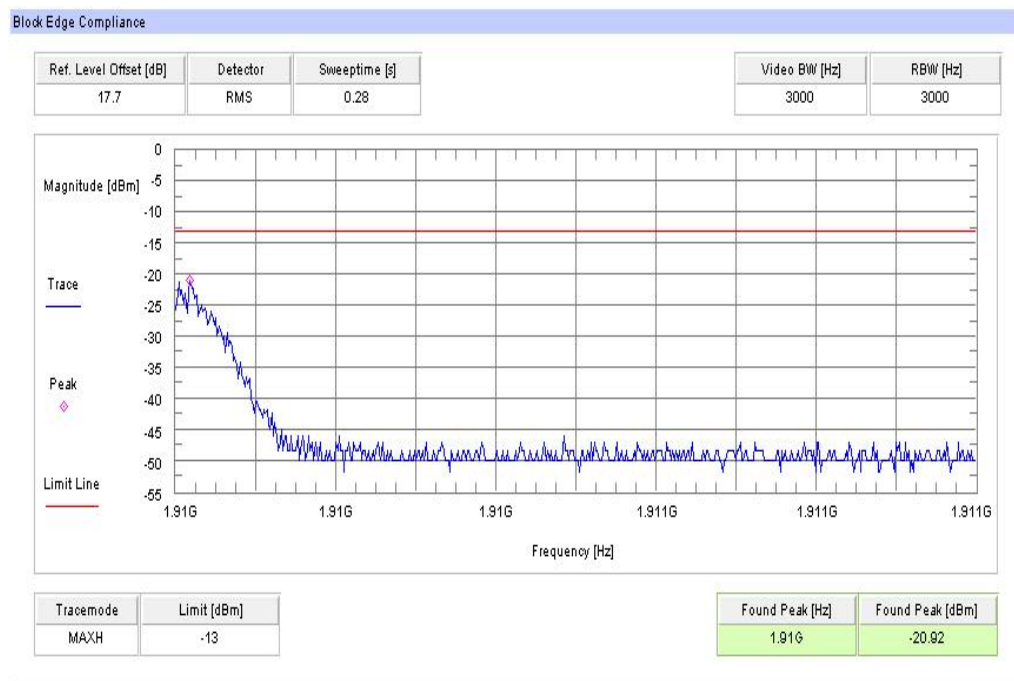

Plot 3: Channel 512 (EDGE-mode)

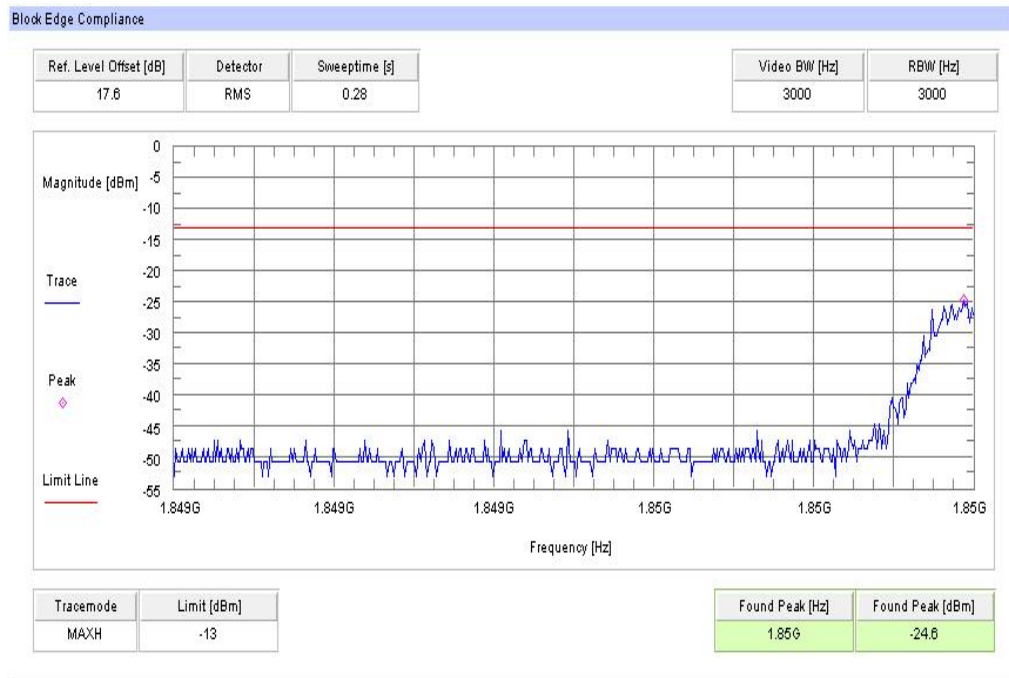

Plot 4: Channel 810 (EDGE-mode)

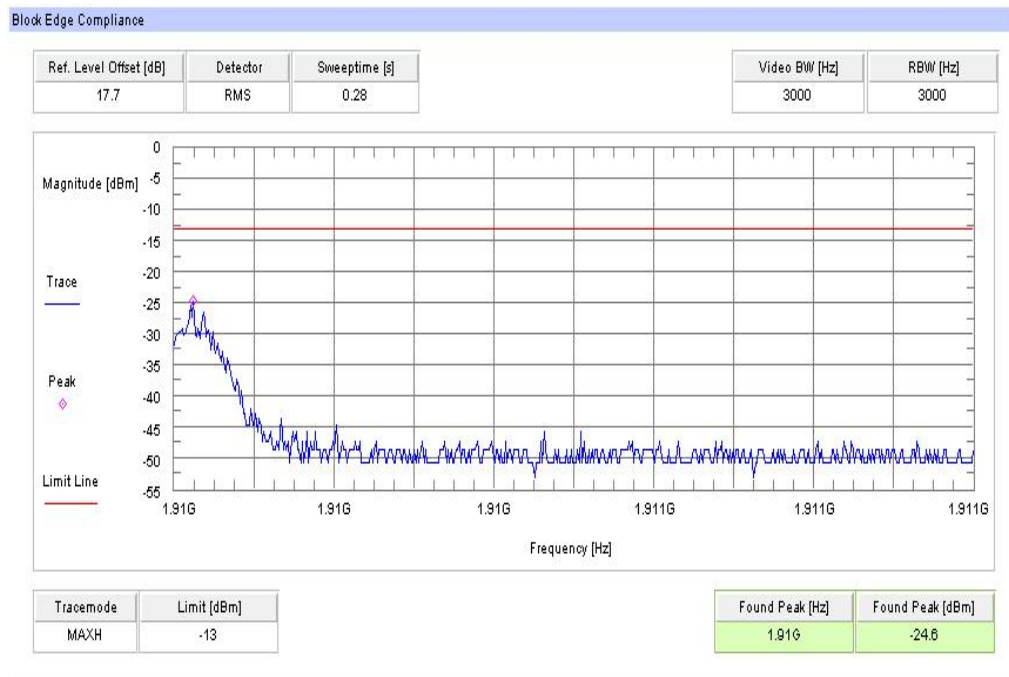

Result: Passed

8.4.6 Occupied bandwidth

Description:

Measurement of the occupied bandwidth of the transmitted signal.

Measurement:

Similar to conducted emissions, occupied bandwidth measurements are only provided for selected frequencies in order to reduce the amount of submitted data. Data were taken at the extreme and mid frequencies of the PCS1900 frequency band. The table below lists the measured 99% power and -26dBc occupied bandwidths. Spectrum analyzer plots are included on the following pages.

Part 24.238 requires a measurement bandwidth of at least 1% of the occupied bandwidth. For ca. 300 kHz, this equates to a resolution bandwidth of at least 3.0 kHz. For this testing, a resolution bandwidth 3.0 kHz was used.

Measurement parameters	
Detector:	Peak
Sweep time:	Auto
Video bandwidth:	30 kHz
Resolution bandwidth:	10 kHz
Span:	1 MHz
Trace-Mode:	Max Hold

Limits:

FCC	IC
CFR Part 24.238 CFR Part 2.1049	RSS 133
Occupied Bandwidth	
Spectrum must fall completely in the specified band	

Results:

Occupied Bandwidth - GMSK mode		
Frequency (MHz)	99% OBW (kHz)	-26 dBc BW (kHz)
1850.2	277	323
1880.0	283	313
1909.8	267	313
Measurement uncertainty	± 3 kHz	

Occupied Bandwidth - EDGE mode		
Frequency (MHz)	99% OBW (kHz)	-26 dBc BW (kHz)
1850.2	267	295
1880.0	273	313
1909.8	287	319
Measurement uncertainty	± 3 kHz	

Result: Passed

Plots:

Plot 1: Channel 512 (99% - OBW)

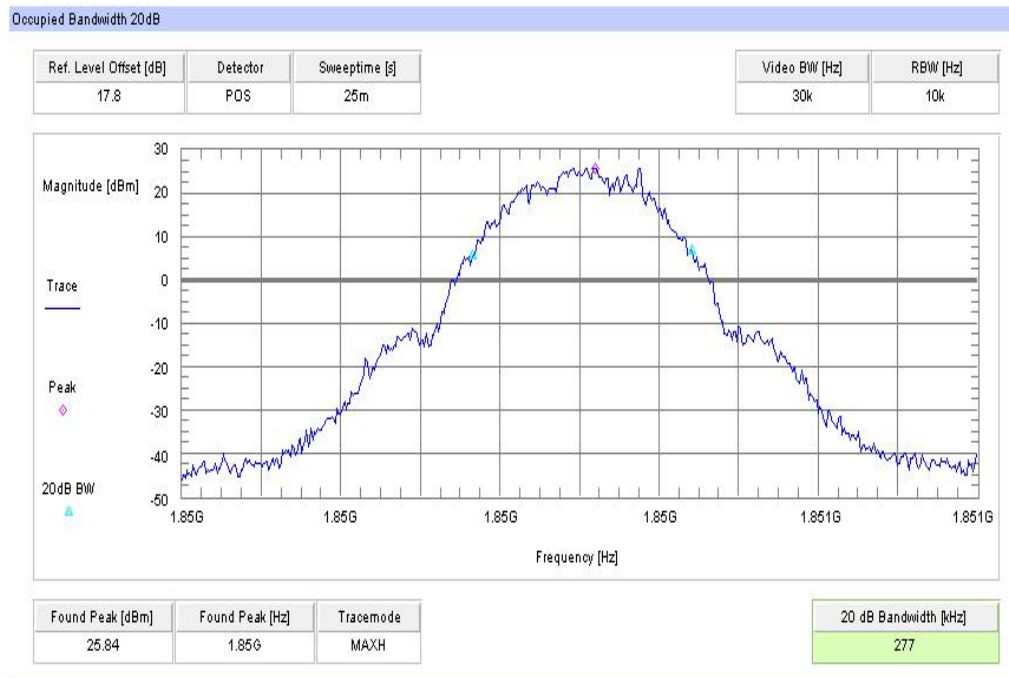

Plot 2: Channel 512 (-26 dBc BW)

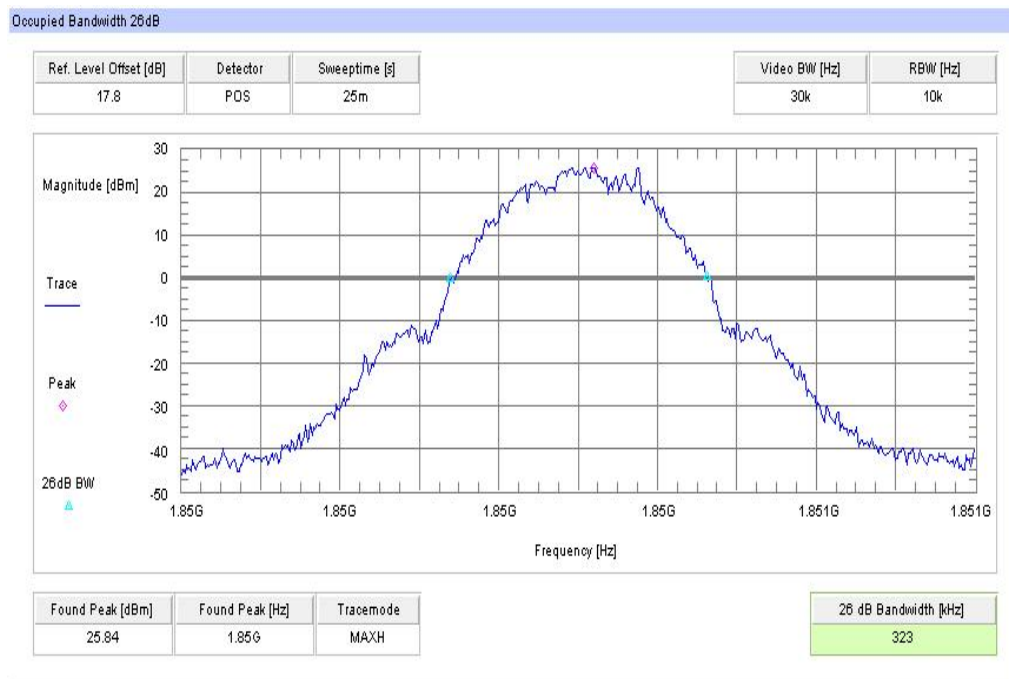

Plot 3: Channel 661 (99% - OBW)

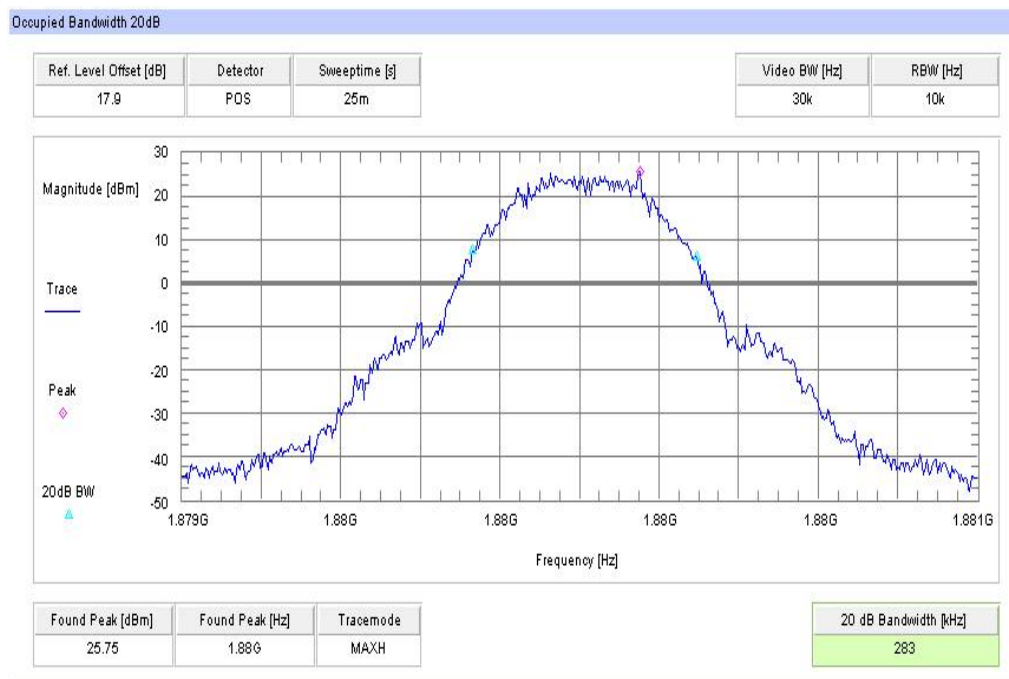

Plot 4: Channel 661 (-26 dBc BW)

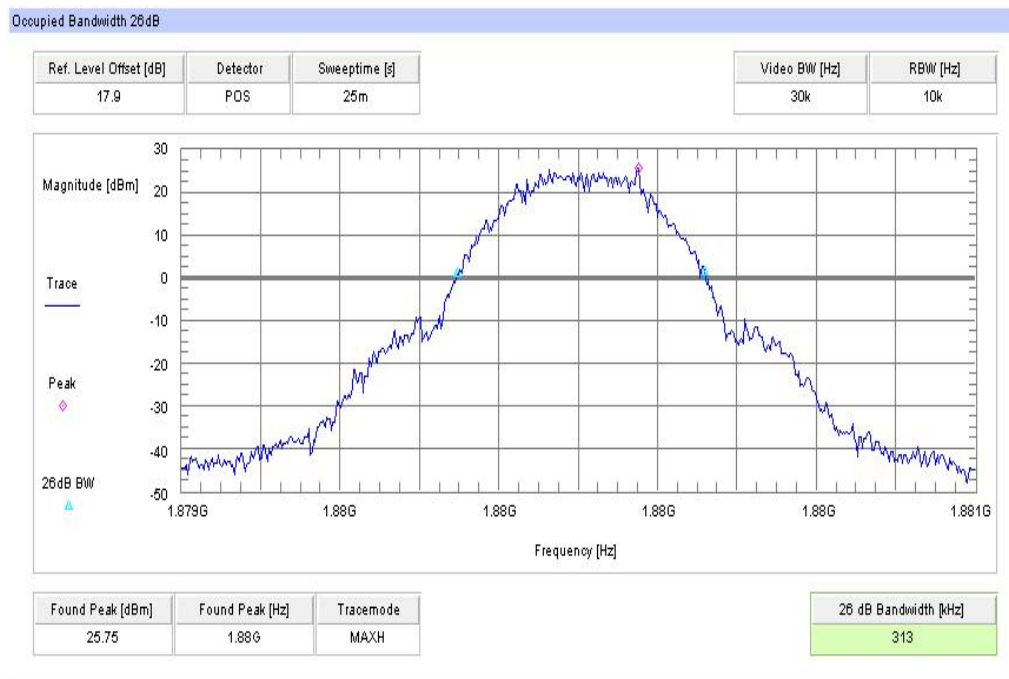

Plot 5: Channel 810 (99% - OBW)



Plot 6: Channel 810 (-26 dBc BW)

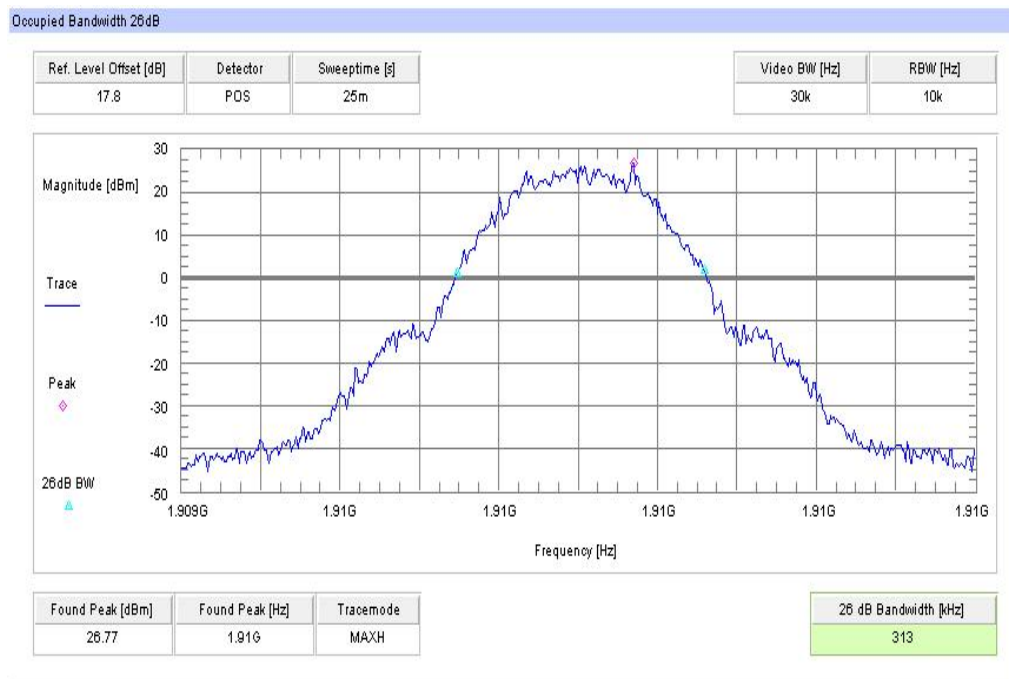

Plot 7: Channel 512 (99% - OBW) - EDGE

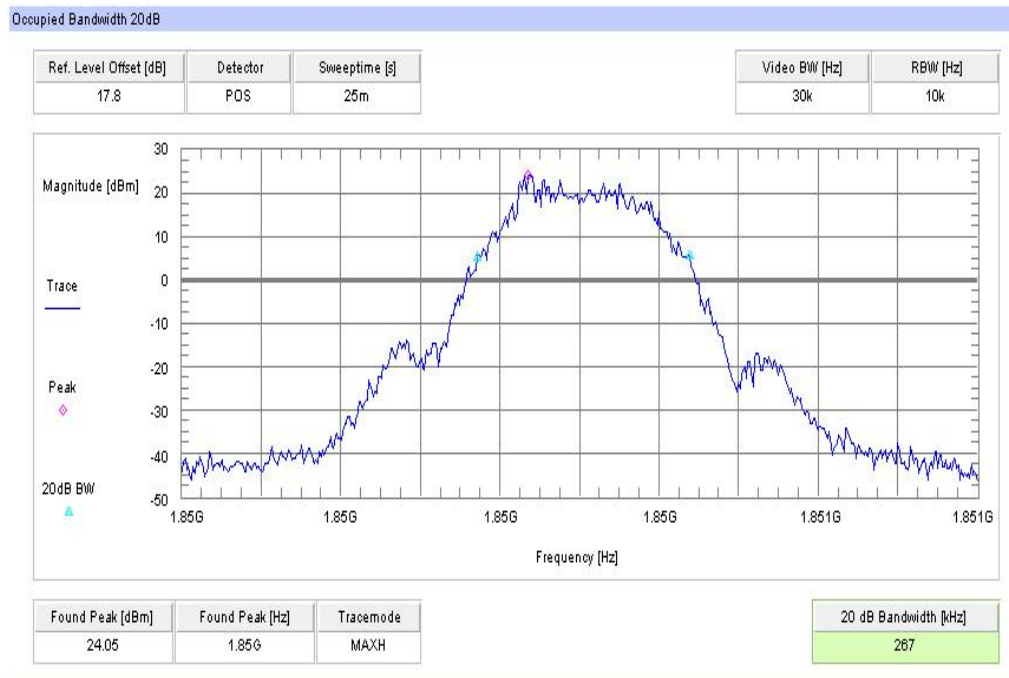

Plot 8: Channel 512 (-26 dBc BW) - EDGE

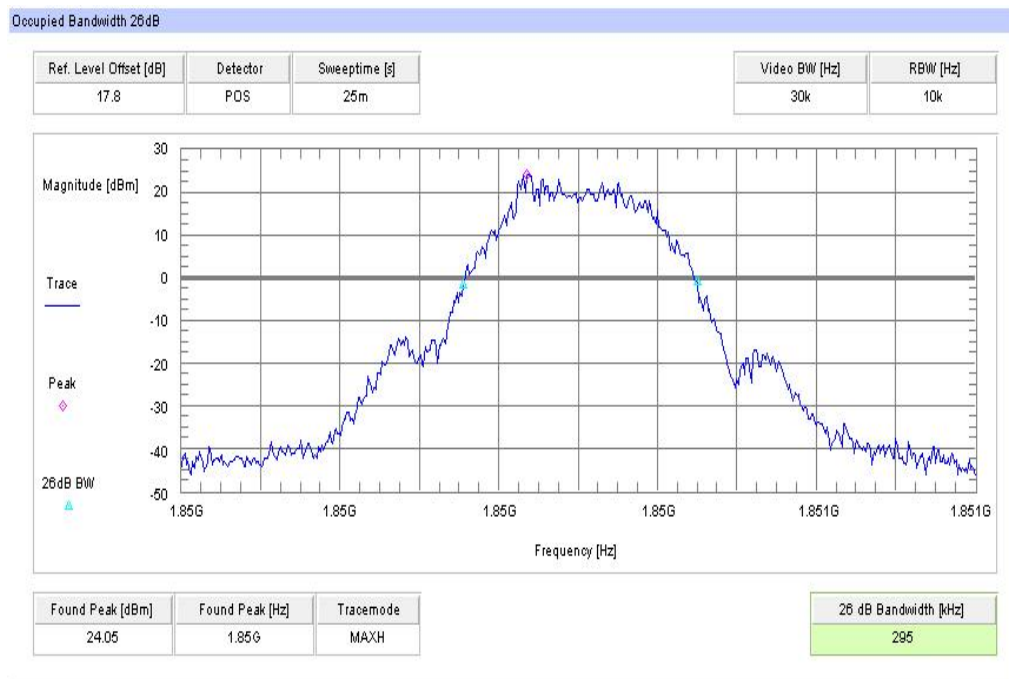

Plot 9: Channel 661 (99% - OBW) - EDGE

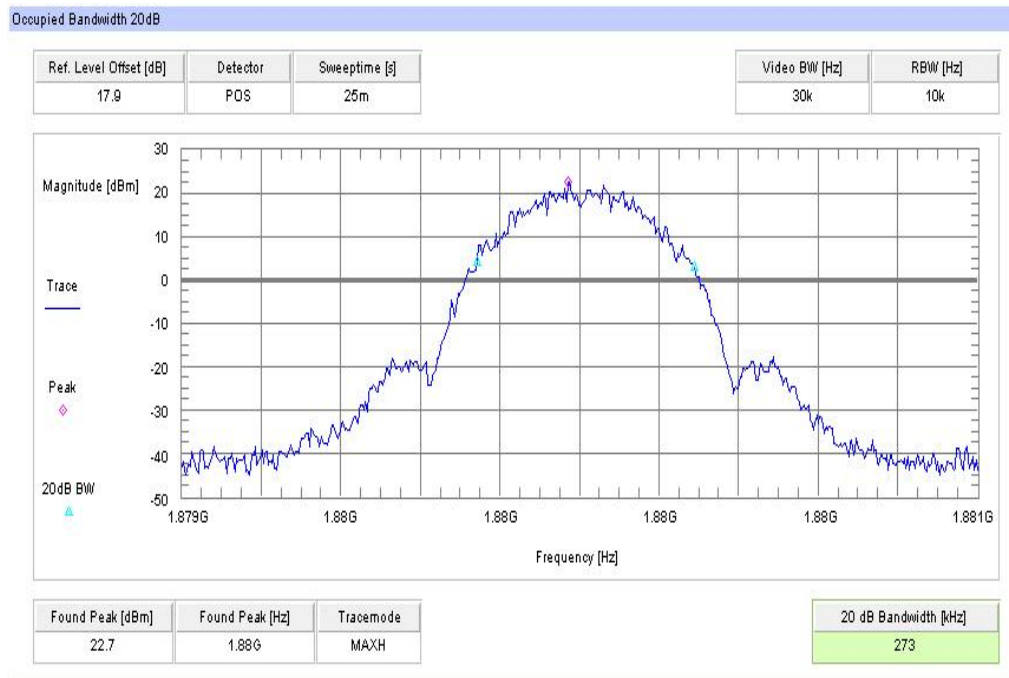

Plot 10: Channel 661 (-26 dBc BW) - EDGE

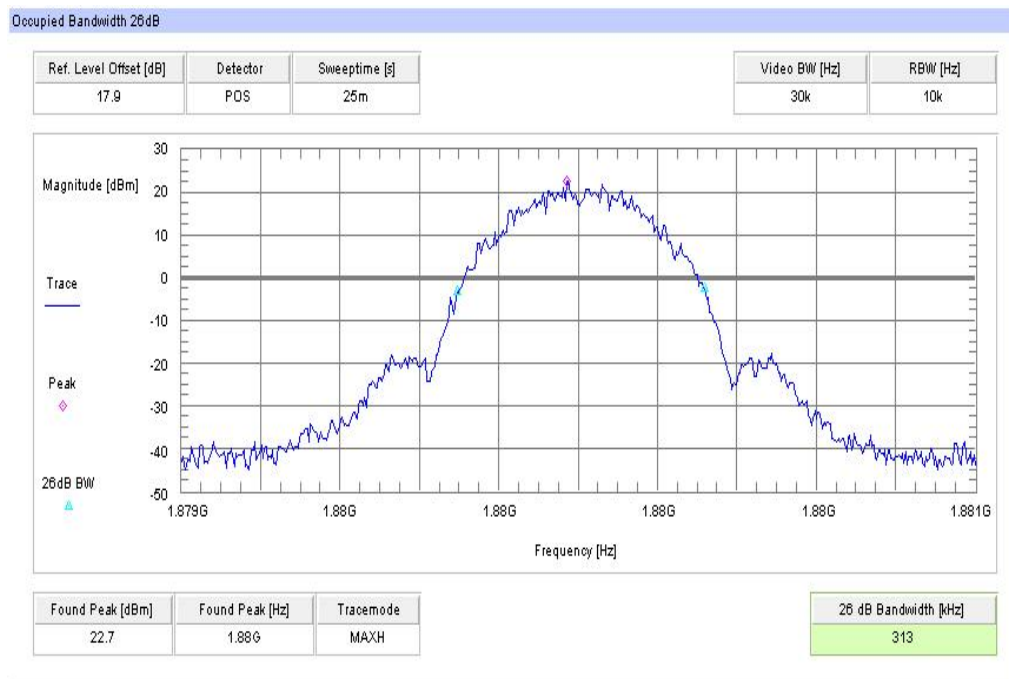

Plot 11: Channel 810 (99% - OBW) - EDGE

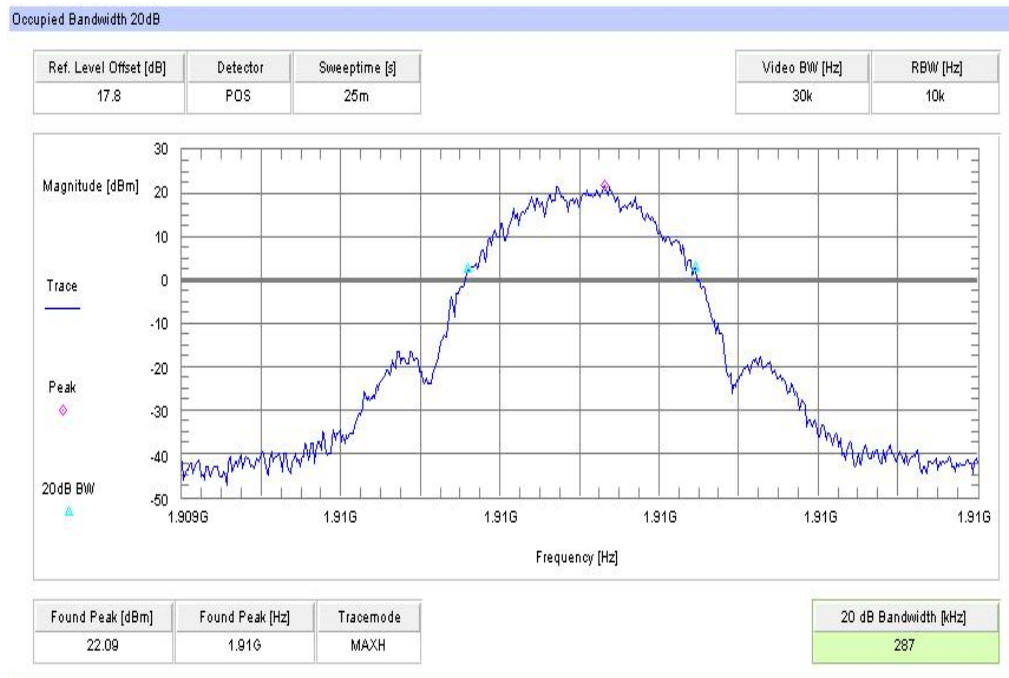

Plot 12: Channel 810 (-26 dBc BW) - EDGE

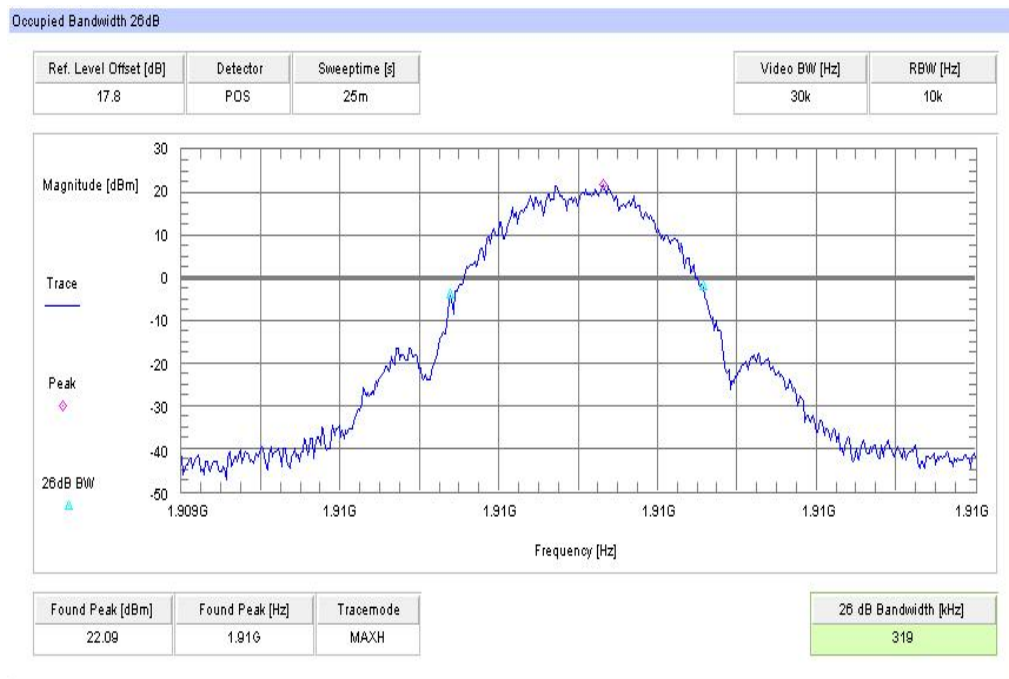

8.5 Results UMTS band V

All UMTS-band measurements are done in WCDMA mode only.

The connection was established with the following setup: WCDMA CS-RMC, Max Power (All Bit up)

8.5.1 RF output power

Description:

This paragraph contains average power, peak output power and ERP measurements for the mobile station. In all cases, the peak output power is within the required mask (this mask is specified in the JTC standards, TIA PN3389 Vol. 1 Chap 7, and is no FCC requirement).

Measurement:

The mobile was set up for the maximum output power with pseudo random data modulation.

To determine the Peak-To-Average Power Ratio (PAPR) the measurement was performed with the Power Complementary Cumulative Distribution Function (CCDF).

Measurement parameters	
Detector:	Peak and RMS (Power in Burst)
Sweep time:	Auto
Video bandwidth:	10 MHz
Resolution bandwidth:	10 MHz
Span:	Zero Span
Trace-Mode:	Max Hold

Limits:

FCC	IC
CFR Part 22.913 CFR Part 2.1046	RSS 132
Nominal Peak Output Power	
+38.45 dBm	
In measuring transmissions in this band using an average power technique, the peak-to-average ratio (PAR) of the transmission may not exceed 13 dB.	

Results:

Output Power (conducted) WCDMA mode		
Frequency (MHz)	Average Output Power (dBm)	Peak to Average Ratio (dB)
826.4	25.0	3.10
836.0	25.1	3.06
846.6	25.1	3.04
Measurement uncertainty	± 0.5 dB	

Output Power (radiated) WCDMA mode	
Frequency (MHz)	Average Output Power (dBm) - ERP
826.4	18.3
836.0	19.9
846.6	21.4
Measurement uncertainty	± 2.0 dB

Result: Passed

8.5.2 Frequency stability

Description:

In order to measure the carrier frequency under the condition of AFC lock, it is necessary to make measurements with the mobile station in a “call mode”. This is accomplished with the use of a R&S CMU200 DIGITAL RADIOCOMMUNICATION TESTER.

1. Measure the carrier frequency at room temperature.
2. Subject the mobile station to overnight soak at -30 C.
3. With the mobile station, powered with V_{nom} , connected to the CMU200 and in a simulated call on channel 4180 (centre channel), measure the carrier frequency. These measurements should be made within two minutes of powering up the mobile station, to prevent significant self warming.
4. Repeat the above measurements at 10°C increments from -30°C to +60°C. Allow at least 1.5 hours at each temperature, unpowered, before making measurements.
5. Remeasure carrier frequency at room temperature with V_{nom} . Vary supply voltage from V_{min} to V_{max} , in 0.1 Volt steps remeasuring carrier frequency at each voltage. Pause at V_{nom} for 1.5 hours unpowered, to allow any self heating to stabilize, before continuing.
6. At all temperature levels hold the temperature to +/- 0.5°C during the measurement procedure.

Measurement:

Measurement parameters	
Detector:	Measured with CMU200
Sweep time:	
Video bandwidth:	
Resolution bandwidth:	
Span:	
Trace-Mode:	

Limits:

FCC	IC
CFR Part 22.355 CFR Part 2.1055	RSS 132
Frequency Stability	
± 0.1 ppm	

Results:

AFC FREQ ERROR versus VOLTAGE

Voltage (V)	Frequency Error (Hz)	Frequency Error (%)	Frequency Error (ppm)
3.3	4	0.00000048	0.0048
3.4	2	0.00000024	0.0024
3.5	-2	-0.00000024	-0.0024
3.6	3	0.00000036	0.0036
3.7	3	0.00000036	0.0036
3.8	-2	-0.00000024	-0.0024
3.9	-3	-0.00000036	-0.0036
4.0	-2	-0.00000024	-0.0024
4.1	3	0.00000036	0.0036
4.2	-3	-0.00000036	-0.0036
4.3	3	0.00000036	0.0036
4.4	-3	-0.00000036	-0.0036

AFC FREQ ERROR versus TEMPERATURE

Temperature (°C)	Frequency Error (Hz)	Frequency Error (%)	Frequency Error (ppm)
-30	-2	-0.00000024	-0.0024
-20	-3	-0.00000036	-0.0036
-10	3	0.00000036	0.0036
± 0	3	0.00000036	0.0036
10	2	0.00000024	0.0024
20	-2	-0.00000024	-0.0024
30	3	0.00000036	0.0036
40	3	0.00000036	0.0036
50	4	0.00000048	0.0048
60	-3	-0.00000036	-0.0036

Frequency Error vs. Voltage

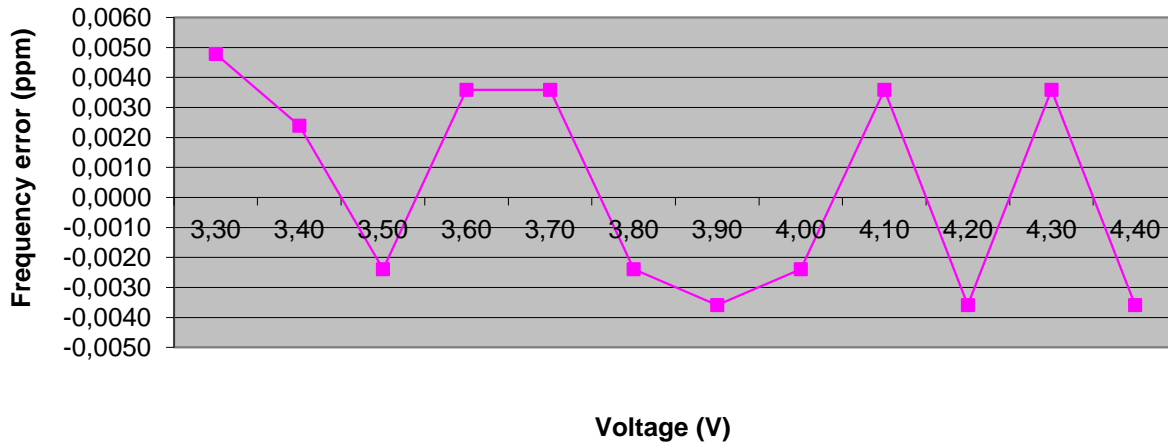

Frequency Error vs. Temperature

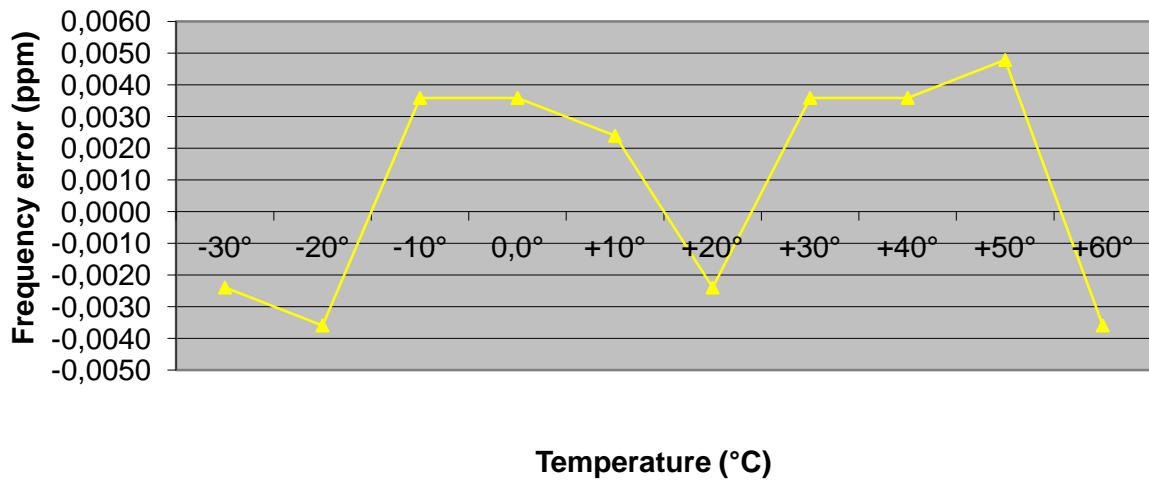

Result: Passed

8.5.3 Spurious emissions radiated

Description:

The following steps outline the procedure used to measure the radiated emissions from the mobile station. The site is constructed in accordance with ANSI C63.4:2009 requirements and is recognized by the FCC to be in compliance for a 3 and a 10 meter site. The spectrum was scanned from 30 MHz to the 10th harmonic of the highest frequency generated within the equipment, which is the transmitted carrier that can be as high as 846.6 MHz. This was rounded up to 12 GHz. The resolution bandwidth is set as outlined in Part 22.917. The spectrum was scanned with the mobile station transmitting at carrier frequencies that pertain to low, mid and high channels of the UMTS band V.

The final open field emission (here 10m semi-anechoic chamber listed by FCC) test procedure is as follows:

- a) The test item was placed on a 0.8 meter high non-conductive stand at a 3 meter test distance from the receive antenna.
- b) The antenna output was terminated in a 50 ohm load (if possible).
- c) A double ridged wave guide antenna was placed on an adjustable height antenna mast 3 meters from the test item for emission measurements.
- d) Detected emissions were maximized at each frequency by rotating the test item and adjusting the receive antenna height and polarization. The maximum meter reading was recorded. The radiated emission measurements of the harmonics of the transmit frequency through the 10th harmonic were measured with peak detector and 1 MHz bandwidth. If the harmonic could not be detected above the noise floor, the ambient level was recorded. The equivalent power into a dipole antenna was calculated from the field intensity levels measured at 3 meters.
- e) Now each detected emissions were substituted by the substitution method, in accordance with the TIA/EIA 603.

Measurement:

Measurement parameters	
Detector:	Peak
Sweep time:	2 sec.
Video bandwidth:	Below 1 GHz: 100 kHz Above 1 GHz: 1 MHz
Resolution bandwidth:	Below 1 GHz: 100 kHz Above 1 GHz: 1 MHz
Span:	100 MHz Steps
Trace-Mode:	Max Hold

Limits:

FCC	IC
CFR Part 22.917 CFR Part 2.1053	RSS 132
Spurious Emissions Radiated	
Attenuation $\geq 43 + 10\log(P)$ (P, Power in Watts)	
-13 dBm	

Results:

Radiated emissions measurements were made only at the upper, center, and lower carrier frequencies of the UMTS band V (826.4 MHz, 836.0 MHz and 846.6 MHz). It was decided that measurements at these three carrier frequencies would be sufficient to demonstrate compliance with emissions limits because it was seen that all the significant spurs occur well outside the band and no radiation was seen from a carrier in one block of the UMTS band V into any of the other blocks. The equipment must still, however, meet emissions requirements with the carrier at all frequencies over which it is capable of operating and it is the manufacturer's responsibility to verify this.

The final open field radiated levels are presented on the next pages. All measurements were done in horizontal and vertical polarization; the plots show the worst case. The plots show only the middle channel. If spurious were detected, the lowest and highest channel were checked too. The found values are stated in the table below.

As can be seen from this data, the emissions from the test item were within the specification limit.

SPURIOUS EMISSION LEVEL (dBm)								
Harmonic	Ch. 4132 Freq. (MHz)	Level [dBm]	Harmonic	Ch. 4180 Freq. (MHz)	Level [dBm]	Harmonic	Ch. 4233 Freq. (MHz)	Level [dBm]
2	1652.8	No emission detected closer than 20 dB to the limit line.	2	1672.0	No emission detected closer than 20 dB to the limit line.	2	1693.2	No emission detected closer than 20 dB to the limit line.
3	2479.2		3	2508.0		3	2539.8	
4	3305.6		4	3344.0		4	3386.4	
5	4132.0		5	4180.0		5	4233.0	
6	4958.4		6	5016.0		6	5079.6	
7	5784.8		7	5852.0		7	5926.2	
8	6611.2		8	6688.0		8	6772.8	
9	7437.6		9	7524.0		9	7619.4	
10	8264.0		10	8360.0		10	8466.0	
Measurement uncertainty						± 3dB		

Result: Passed

Plots:

Plot 1: Channel 4180 (Traffic mode up to 30 MHz)

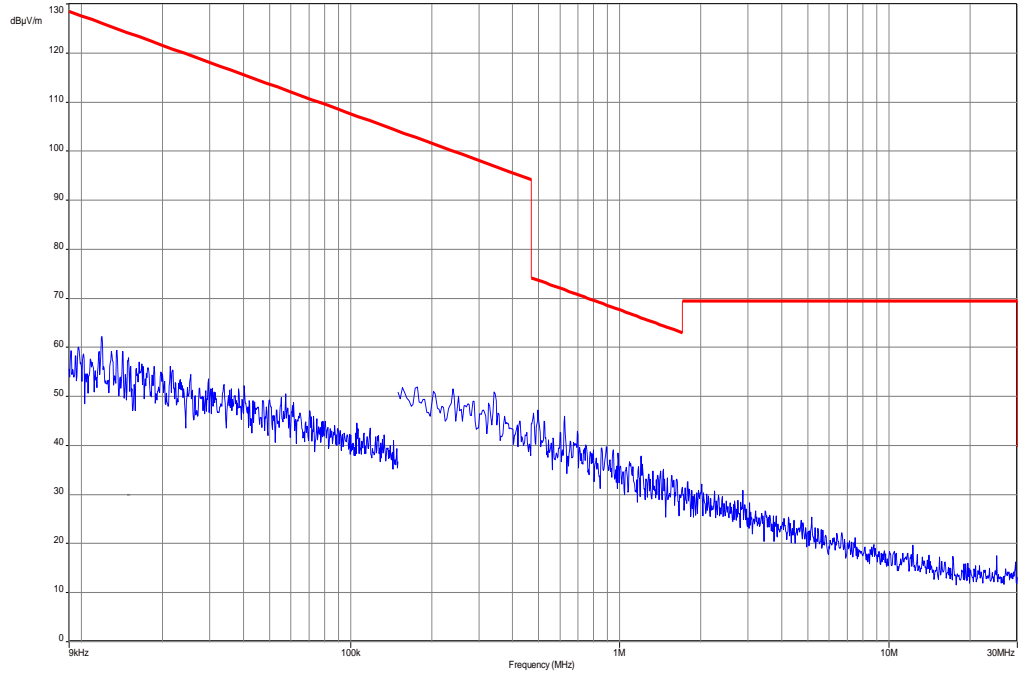

Plot 2: Channel 4180 (30 MHz – 12.75 GHz)

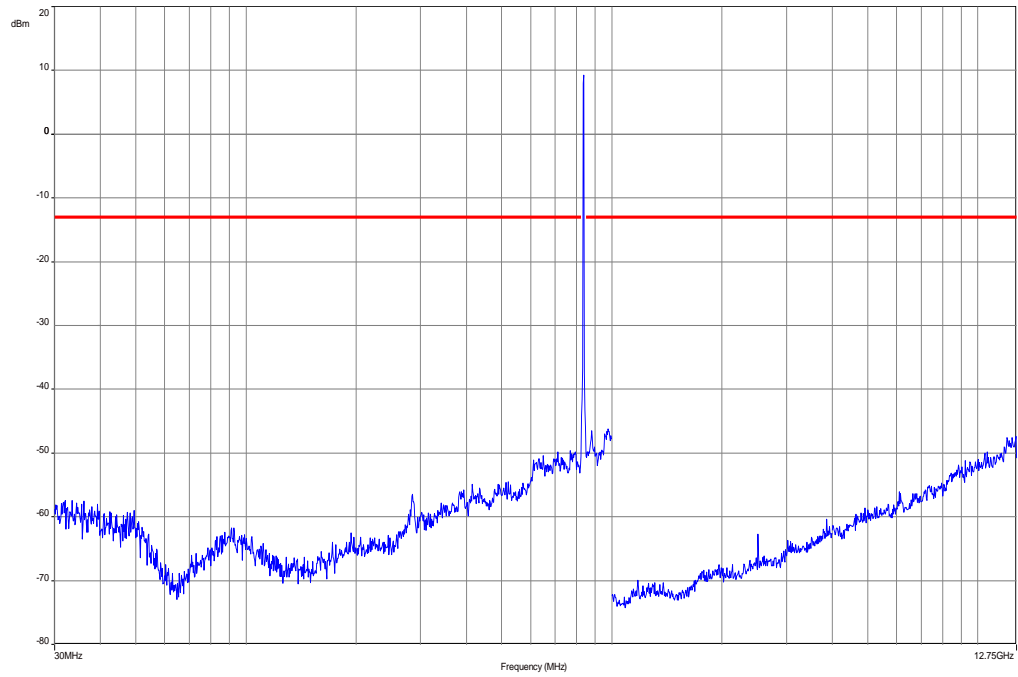

8.5.4 Spurious emissions conducted

Description:

The following steps outline the procedure used to measure the conducted emissions from the mobile station.

1. Determine frequency range for measurements: From CFR 2.1057 the spectrum should be investigated from the lowest radio frequency generated in the equipment up to at least the 10th harmonic of the carrier frequency. For the mobile station equipment tested, this equates to a frequency range of 13 MHz to 9 GHz, data taken from 10 MHz to 12 GHz.
2. Determine mobile station transmits frequencies: below outlines the band edge frequencies pertinent to conducted emissions testing.

UMTS band V Transmitter Channel Frequency
 4132 826.4 MHz
 4180 836.0 MHz
 4233 846.6 MHz

Measurement:

Measurement parameters	
Detector:	Peak
Sweep time:	Auto
Video bandwidth:	Pre-measurement with 1 MHz On spurious detection re-measurement below 1 GHz with 100 kHz Above 1 GHz with 1 MHz
Resolution bandwidth:	Pre-measurement with 1 MHz On spurious detection re-measurement below 1 GHz with 100 kHz Above 1 GHz with 1 MHz
Span:	30 MHz – 25 GHz
Trace-Mode:	Max Hold

Limits:

FCC	IC
CFR Part 22.917 CFR Part 2.1051	RSS 132
Spurious Emissions Conducted	
Attenuation $\geq 43 + 10\log(P)$ (P, Power in Watts)	
-13 dBm	

Results:

SPURIOUS EMISSION LEVEL (dBm)								
Harmonic	Ch. 4132 Freq. (MHz)	Level [dBm]	Harmonic	Ch. 4180 Freq. (MHz)	Level [dBm]	Harmonic	Ch. 4233 Freq. (MHz)	Level [dBm]
2	1652.8	No emission detected closer than 15 dB to the limit line.	2	1672.0	No emission detected closer than 15 dB to the limit line.	2	1693.2	No emission detected closer than 15 dB to the limit line.
3	2479.2		3	2508.0		3	2539.8	
4	3305.6		4	3344.0		4	3386.4	
5	4132.0		5	4180.0		5	4233.0	
6	4958.4		6	5016.0		6	5079.6	
7	5784.8		7	5852.0		7	5926.2	
8	6611.2		8	6688.0		8	6772.8	
9	7437.6		9	7524.0		9	7619.4	
10	8264.0		10	8360.0		10	8466.0	
Measurement uncertainty						± 3dB		

Result: Passed

Plots:

Plot 1: Channel 4132 (10 MHz - 25 GHz)

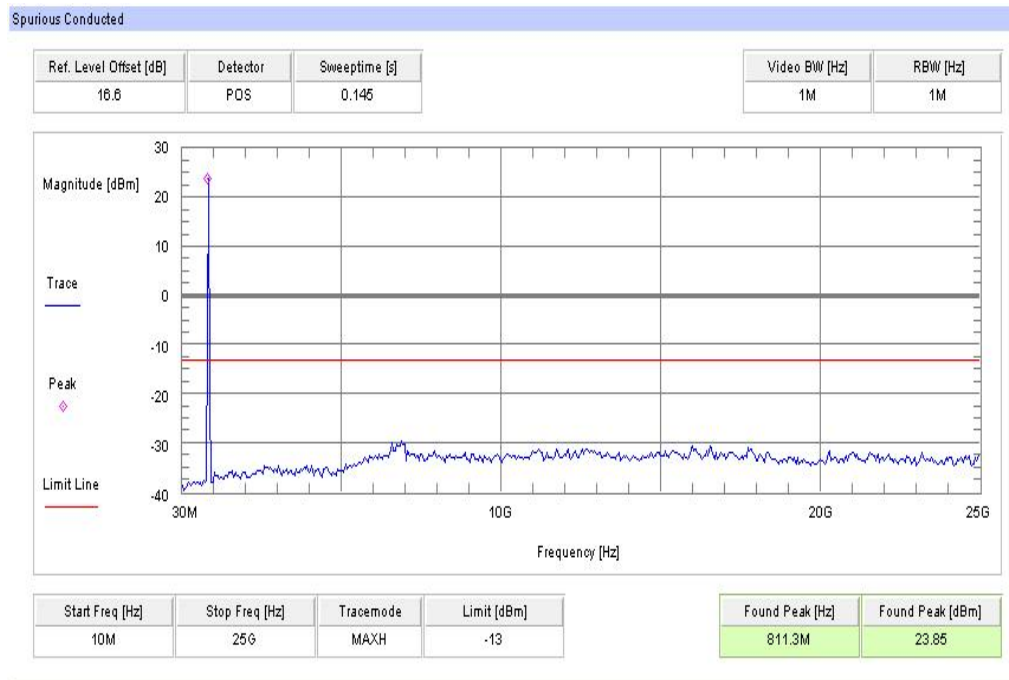

Plot 2: Channel 4180 (10 MHz - 25 GHz)

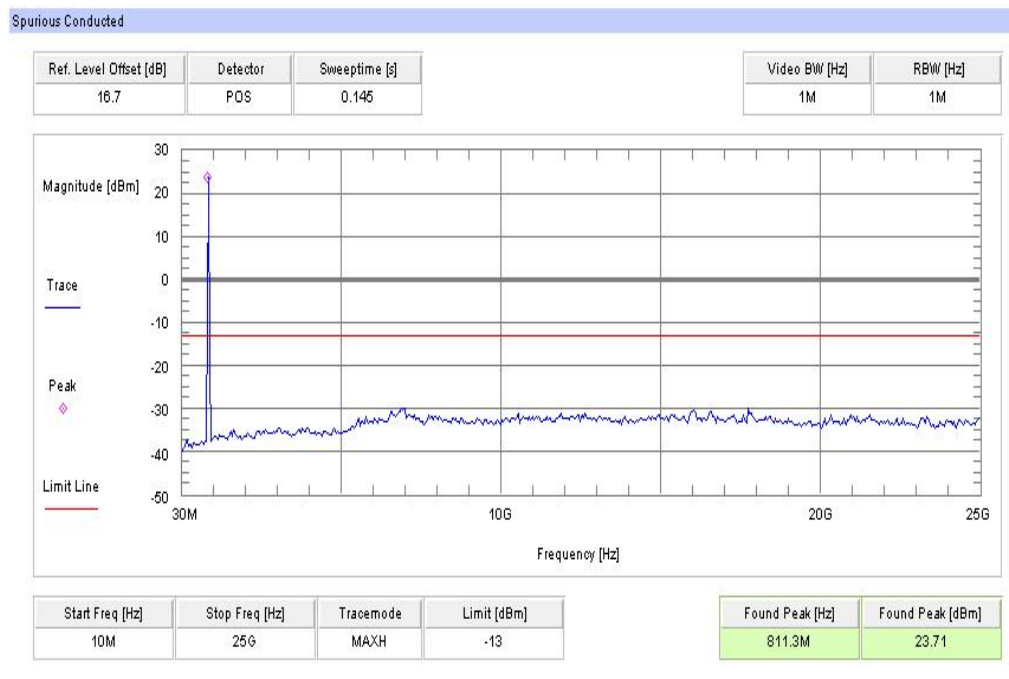

Plot 3: Channel 4233 (10 MHz - 25 GHz)

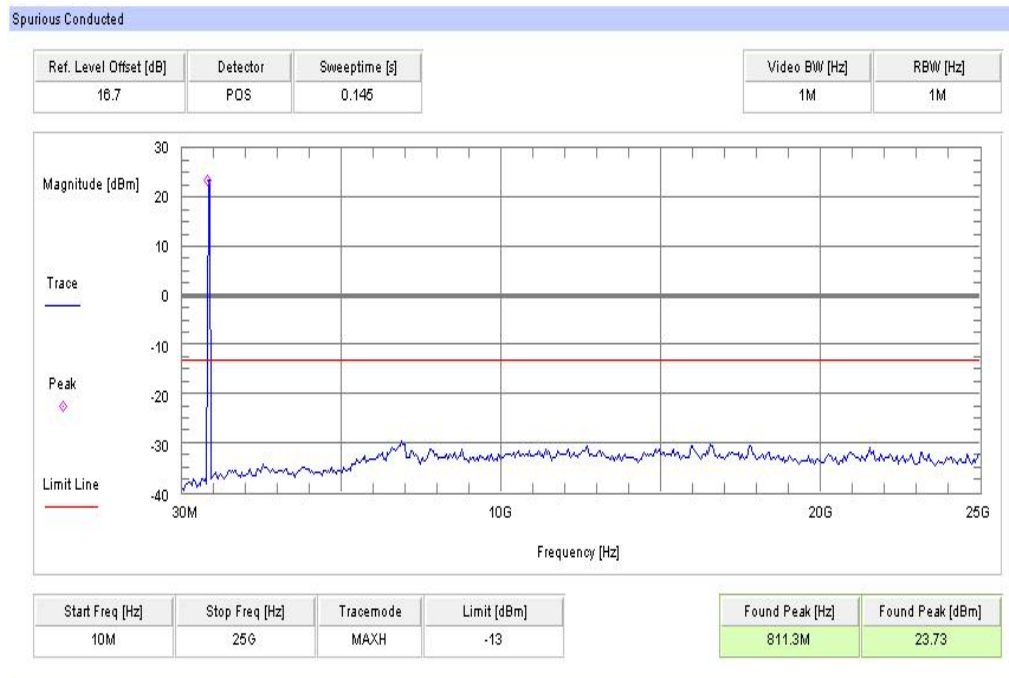

8.5.5 Block edge compliance

Description:

The spectrum at the band edges must comply with the spurious emissions limits.

Measurement:

Measurement parameters	
Detector:	RMS
Sweep time:	20 sec.
Video bandwidth:	30 kHz
Resolution bandwidth:	30 kHz
Span:	1 MHz
Trace-Mode:	Max Hold

Limits:

FCC	IC
CFR Part 22.917 CFR Part 2.1051	RSS 132
Block Edge Compliance	
<p>Part 22.917 specifies that “the power of any emission outside of the authorized operating frequency ranges must be attenuated below the transmitting power (P) by a factor of at least 43 + 10 log(P) dB.”</p> <p>However, in publication number 890810, The FCC Office of Engineering and Technology specified the following correction to the limits when a resolution bandwidth smaller than 1% of the emission bandwidth is used:</p> <p>“An alternative is to add an additional correction factor of 10 Log (RBW1/ RBW2) to the 43 +10 log(P) limit. RBW1 is the narrower measurement resolution bandwidth and RBW2 is either the 1% emissions bandwidth or 1 MHz.”</p> <p>When using a 30 kHz bandwidth, this yields a -2.2185 adjustment to the limit [10 log(30kHz/50kHz) = -2.2185]. When this adjustment is applied to the limit, the limit becomes -15.2185.</p>	
-15.22 dBm	

Plots:

Plot 1: Channel 4132

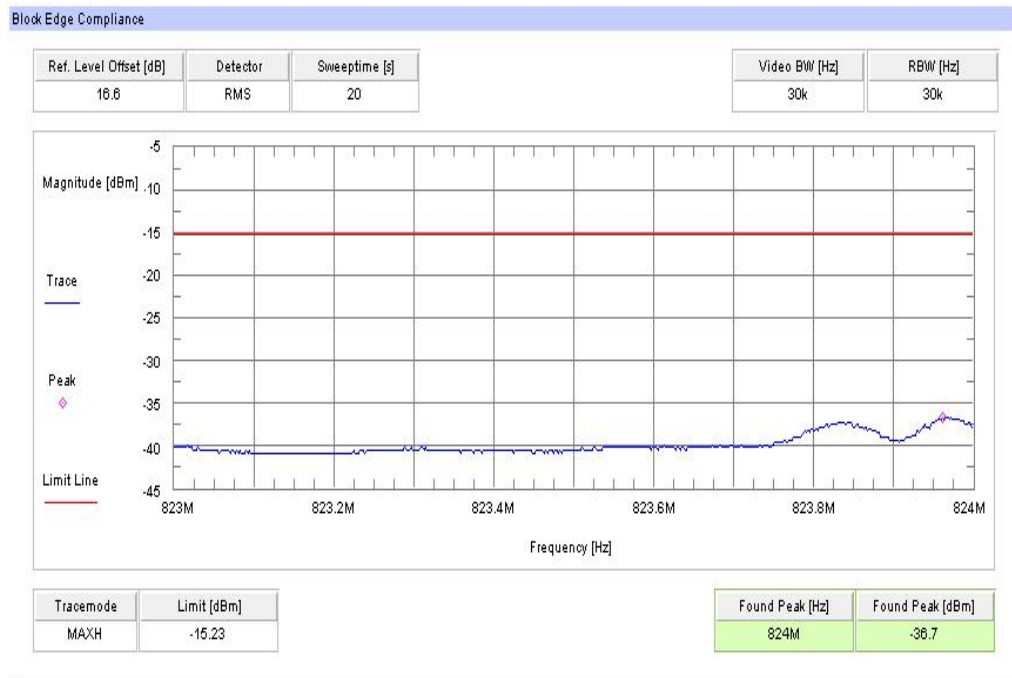

Plot 2: Channel 4233



Result: Passed

8.5.6 Occupied bandwidth

Description:

Measurement of the occupied bandwidth of the transmitted signal.

Measurement:

Similar to conducted emissions, occupied bandwidth measurements are only provided for selected frequencies in order to reduce the amount of submitted data. Data were taken at the extreme and mid frequencies of the UMTS band V. The table below lists the measured 99% power and -26dBc occupied bandwidths. Spectrum analyzer plots are included on the following pages.

Part 22.917 requires a measurement bandwidth of at least 1% of the occupied bandwidth. For ca. 4700 kHz, this equates to a resolution bandwidth of at least 50 kHz. For this testing, a resolution bandwidth 100 kHz was used.

Measurement parameters	
Detector:	Peak
Sweep time:	Auto
Video bandwidth:	300 kHz
Resolution bandwidth:	100 kHz
Span:	6 MHz
Trace-Mode:	Max Hold

Limits:

FCC	IC
CFR Part 22.917 CFR Part 2.1049	RSS 132
Occupied Bandwidth	
Spectrum must fall completely in the specified band	

Results:

Occupied Bandwidth		
Frequency (MHz)	99% OBW (kHz)	-26 dBc BW (kHz)
826.4	4569	4689
836.0	4557	4689
846.6	4581	4677
Measurement uncertainty	± 100 kHz	

Result: Passed

Plots:

Plot 1: Channel 4132 (99% - OBW)

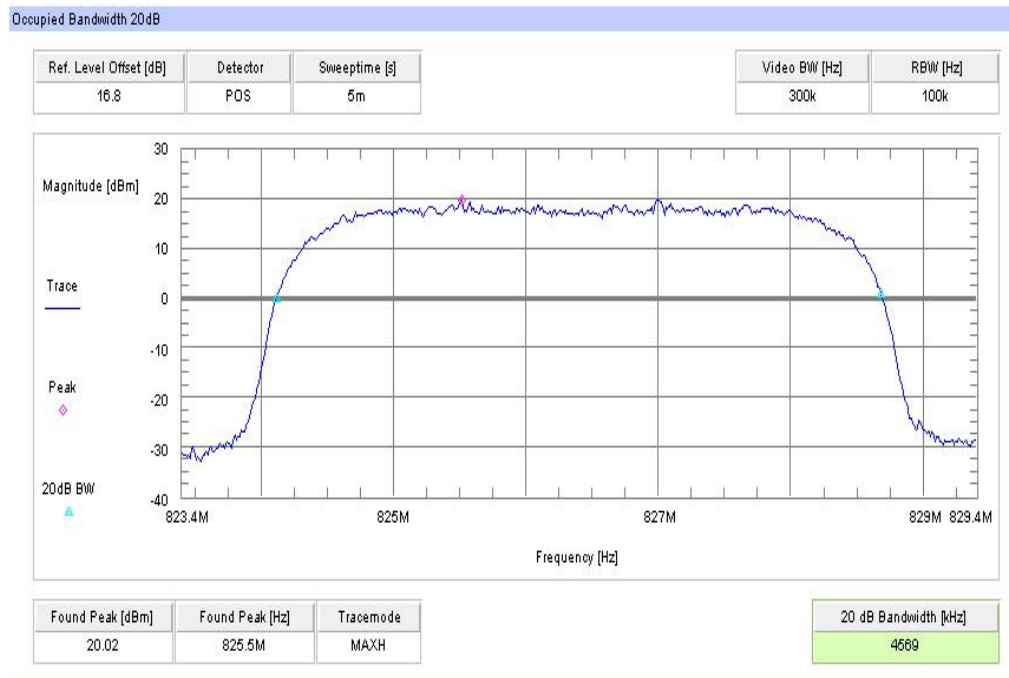

Plot 2: Channel 4132 (-26 dBc BW)

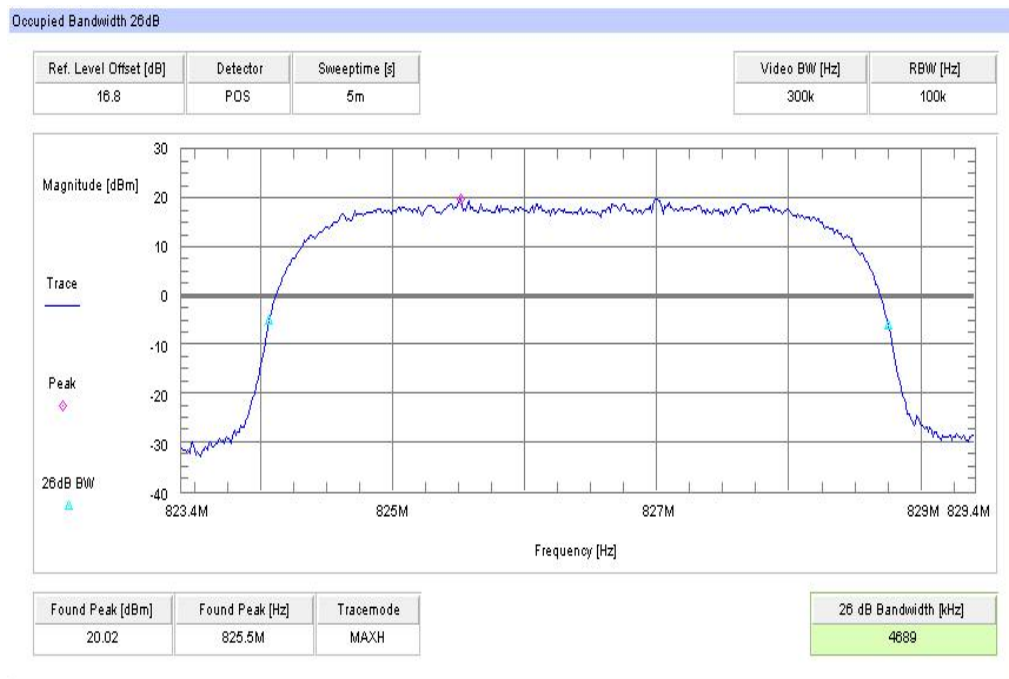

Plot 3: Channel 4180 (99% - OBW)

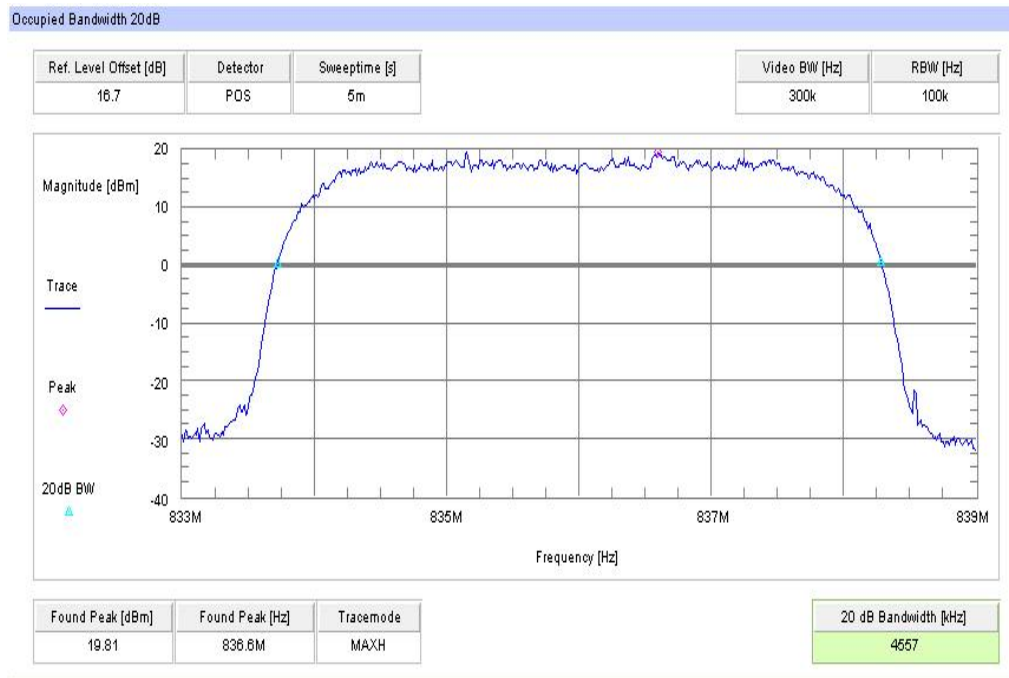

Plot 4: Channel 4180 (-26 dBc BW)

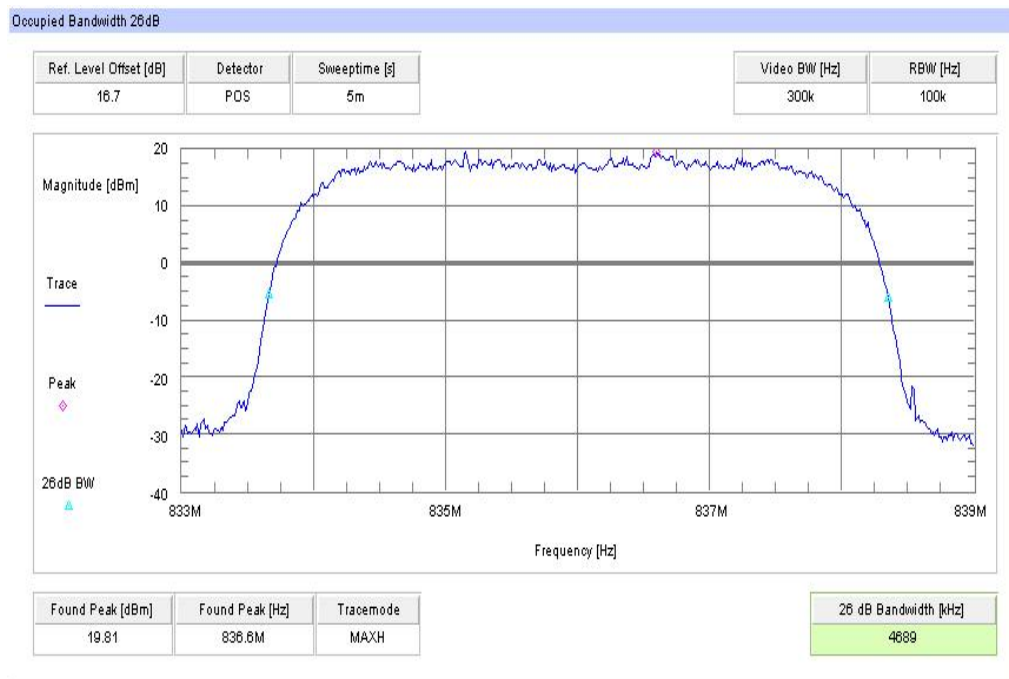

Plot 5: Channel 4233 (99% - OBW)

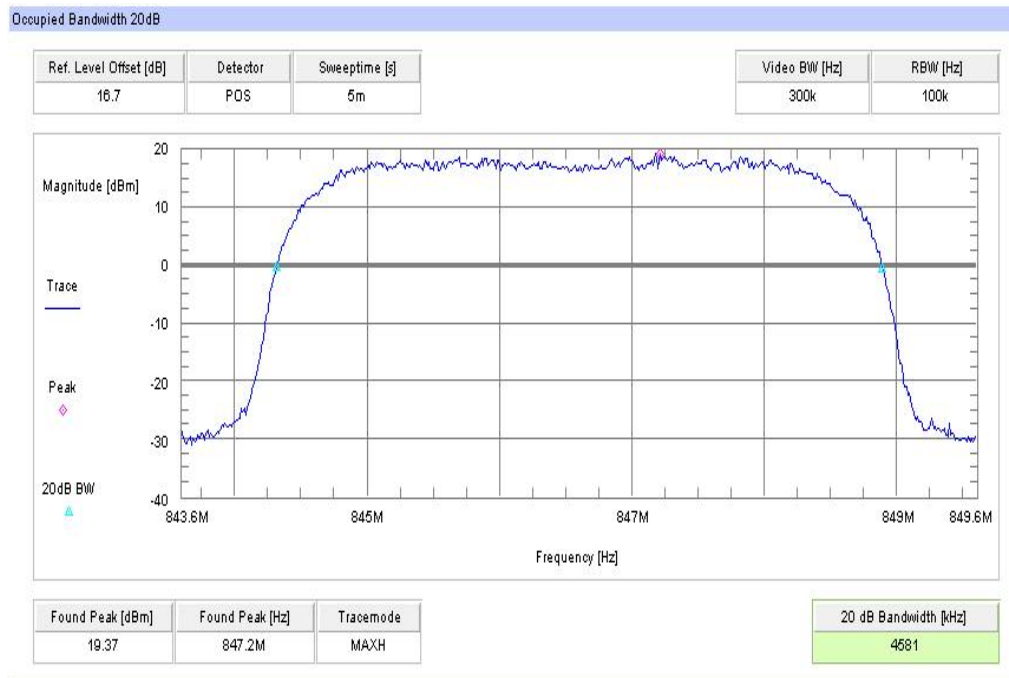

Plot 6: Channel 4233 (-26 dBc BW)

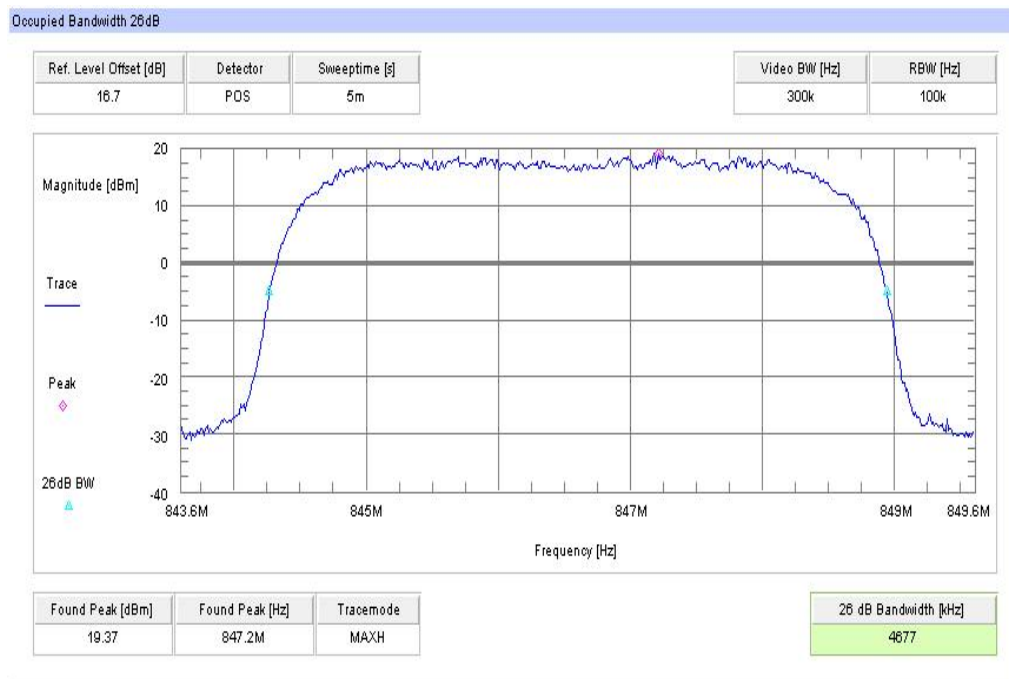

9 Test equipment and ancillaries used for tests

Typically, the calibrations of the test apparatus are commissioned to and performed by an accredited calibration laboratory. The calibration intervals are determined in accordance with the DIN EN ISO/IEC 17025. In addition to the external calibrations, the laboratory executes comparison measurements with other calibrated test systems or effective verifications. Weekly chamber inspections and range calibrations are performed. Where possible, rf-generating and signalling equipment as well as measuring receivers and analyzers are connected to an external high-precision 10 MHz reference (GPS-based or rubidium frequency standard).

In order to simplify the identification of the equipment used at some special tests, some items of test equipment and ancillaries can be provided with an identifier or number in the equipment list below (Labor/Item).

No.	Lab / Item	Equipment	Type	Manufact.	Serial No.	INV. No Cetecom	Kind of Calibration	Last Calibration	Next Calibration
1	n. a.	DC power supply, 60Vdc, 50A, 1200 W	6032A	HP Meßtechnik	2818A03450	300001040	Ve	12.01.2012	12.01.2015
2	n. a.	Double-Ridged Waveguide Horn Antenna 1-18.0GHz	3115	EMCO	8812-3088	300001032	vIKI!	11.05.2011	11.05.2013
3	n. a.	Active Loop Antenna	6502	EMCO	2210	300001015	ne		
4	n. a.	Anechoic chamber	FAC 3/5m	MWB / TDK	87400/02	300000996	ev		
5	n. a.	Switch / Control Unit	3488A	HP Meßtechnik	*	300000199	ne		
6	n. a.	Switch / Control Unit	3488A	HP Meßtechnik	2719A15013	300001156	ne		
7	9	Isolating Transformer	MPL IEC625 Bus Regeltrennt ravo	Erfi	91350	300001155	ne		
8	n. a.	Three-Way Power Splitter, 50 Ohm	11850C	HP Meßtechnik		300000997	ne		
9	n. a.	Amplifier	js42-00502650-28-5a	Parzich GMBH	928979	300003143	ne		
10	n. a.	Band Reject filter	WRCG185 5/1910-1835/1925-40/8SS	Wainwright	7	300003350	ev		
11	n. a.	Highpass Filter	WHKX7.0/1 8G-8SS	Wainwright	18	300003789	ne		
12	n. a.	TRIOLOG Broadband Test-Antenna 30 MHz - 3 GHz	VULB9163	Schwarzbeck	371	300003854	vIKI!	14.10.2011	14.10.2014
13	n. a.	MXE EMI Receiver 20 Hz bis 26,5 GHz	N9038A	Agilent Technologies	MY51210197	300004405	k	19.12.2011	19.12.2012
14	n. a.	Isolating Transformer	RT5A	Grundig	8041	300001626	g		
15	9	Artificial Mains 9 kHz to 30 MHz	ESH3-Z5	R&S	828576/020	300001210	Ve	06.01.2012	06.01.2014
16	n. a.	Relais Matrix	PSU	R&S	890167/024	300001168	ne		
17	11b	Microwave System Amplifier, 0.5-26.5 GHz	83017A	HP Meßtechnik	00419	300002268	ev		
18	A026	Std. Gain Horn Antenna 12.4 to 18.0 GHz	639	Narda		300000787	ne		
19	A028	Std. Gain Horn Antenna 18.0 to 26.5 GHz	638	Narda		300002440	ne		
20	n. a.	DC Power Supply 0 – 32V	1108-32	Heiden	001802	300001383	Ve	23.06.2010	23.06.2013
21	n. a.	Temperature Test Chamber	VT 4002	Heraeus Voetsch	521/83761	300002326	Ve	20.09.2011	20.09.2013
22	n. a.	Signal Analyzer 20Hz-26,5GHz-150 to + 30 DBM	FSiQ26	R&S	835111/0004	300002678	Ve		

23	n. a.	Universal Communication Tester	CMU200	R&S	103992	300003231	vIKI!	21.08.2012	21.08.2014
----	-------	--------------------------------------	--------	-----	--------	-----------	-------	------------	------------

Agenda: Kind of Calibration

k	calibration / calibrated	EK	limited calibration
ne	not required (k, ev, izw, zw not required)	zw	cyclical maintenance (external cyclical maintenance)
ev	periodic self verification	izw	internal cyclical maintenance
Ve	long-term stability recognized	g	blocked for accredited testing
vIKI!	Attention: extended calibration interval	*	next calibration ordered / currently in progress
NK!	Attention: not calibrated		

10 Observations

No observations exceeding those reported with the single test cases have been made.

Annex A Document history

Version	Applied changes	Date of release
1.0	Initial release	2012-11-30
-A	Editorial corrections	2013-01-30

Annex B Further information**Glossary**

AVG	-	Average
DUT	-	Device under test
EMC	-	Electromagnetic Compatibility
EN	-	European Standard
EUT	-	Equipment under test
ETSI	-	European Telecommunications Standard Institute
FCC	-	Federal Communication Commission
FCC ID	-	Company Identifier at FCC
HW	-	Hardware
IC	-	Industry Canada
Inv. No.	-	Inventory number
N/A	-	Not applicable
PP	-	Positive peak
QP	-	Quasi peak
S/N	-	Serial number
SW	-	Software

Annex C Accreditation Certificate



Deutsche Akkreditierungsstelle GmbH
German Accreditation Body

Entrusted according to Section 8 subsection 1 AkkStelleG in connection with Section 1 subsection 1 AkkStelleGBV
Signatory to the Multilateral Agreements of EA, ILAC and IAF for Mutual Recognition

Accreditation



The Deutsche Akkreditierungsstelle GmbH (German Accreditation Body) attests that the testing laboratory

CETECOM ICT Services GmbH
Untertürkheimer Straße 6-10
66117 Saarbrücken

is competent under the terms of DIN EN ISO/IEC 17025:2005 to carry out tests in the following fields:

- Wired communications and DECT
- Acoustic
- Radio
- Shirt Range Devices (SRD)
- RFID
- WiMax and Richtfunk
- Mobile radio (GSM / DCS), Over the Air (OTA) Performance
- Electromagnetic Compatibility (EMC) incl. Automotive
- Product safety
- SAR and Hearing Aid Compatibility (HAC)
- Environmental simulation
- Smart Card Terminals
- Bluetooth
- Wi-Fi-Services

The accreditation certificate shall only apply in connection with the notice of accreditation of 13.04.2011 with the accreditation number D-PL-12076-01 and is valid until 03.09.2014. It comprises the cover sheet, the reverse side of the cover sheet and the following annex with a total of 82 pages.

Registration number of the certificate: **D-PL-12076-01-01**

Frankfurt am Main, 13.04.2011

 Dipl.-Ing. (FH) Eger
 Head of Division 2

This document is a translation. The definitive version is the original German accreditation certificate.
See annex overleaf.

Front side of certificate

Deutsche Akkreditierungsstelle GmbH

Office Berlin
Spittelmarkt 10
10117 Berlin

Office Frankfurt am Main
Gartenstraße 6
60594 Frankfurt am Main

Office Braunschweig
Bundesallee 100
38116 Braunschweig

The publication of extracts of the accreditation certificate is subject to the prior written approval by Deutsche Akkreditierungsstelle GmbH (DAKKS). Exempted is the unchanged form of separate disseminations of the cover sheet by the conformity assessment body mentioned overleaf.

No impression shall be made that the accreditation also extends to fields beyond the scope of accreditation attested by DAKKS.

The accreditation was granted pursuant to the Act on the Accreditation Body (AkkStelleG) of 31 July 2009 (Federal Law Gazette I p. 2625) and the Regulation (EC) No 765/2008 of the European Parliament and of the Council of 9 July 2008 setting out the requirements for accreditation and market surveillance relating to the marketing of products (Official Journal of the European Union L 218 of 9 July 2008, p. 30). DAKKS is a signatory to the Multilateral Agreements for Mutual Recognition of the European co-operation for Accreditation (EA), International Accreditation Forum (IAF) and International Laboratory Accreditation Cooperation (ILAC). The signatories to these agreements recognise each other's accreditations.

The up-to-date state of membership can be retrieved from the following websites:
 EA: www.european-accreditation.org
 ILAC: www.ilac.org
 IAF: www.iaf.nu

Back side of certificate

Note:

The current certificate including annex is published on our website (see link below) or may be received from CETECOM ICT Services on request.

http://www.cetecom.com/fileadmin/de/CETECOM_D_Saarbruecken/accreditations_Jan_2010/DAKKS_Akkredi_Urk_EN17025-En_incl_Annex.pdf