

TEST REPORT

Test report no.: 1-4254/12-61-10-A



Testing laboratory

CETECOM ICT Services GmbH
Untertuerkheimer Strasse 6 – 10
66117 Saarbruecken / Germany
Phone: + 49 681 5 98 - 0
Fax: + 49 681 5 98 - 9075
Internet: <http://www.cetecom.com>
e-mail: ict@cetecom.com

Accredited Testing Laboratory:

The testing laboratory (area of testing) is accredited according to DIN EN ISO/IEC 17025 (2005) by the Deutsche Akkreditierungsstelle GmbH (DAkkS). The accreditation is valid for the scope of testing procedures as stated in the accreditation certificate with the registration number: D-PL-12076-01-01
Area of Testing: Radio/Satellite Communications

Applicant

Sony Mobile Communications AB
Nya Vattentornet
22188 Lund / SWEDEN
Phone: +46 46 19 30 00
Fax: +46 46 19 32 95
Contact: Håkan Sjöberg
e-mail: hakan.sjoberg@sonymobile.com
Phone: +46 46 19 35 59

Manufacturer

Sony Mobile Communications AB
Nya Vattentornet
22188 Lund / SWEDEN

Test standard/s

47 CFR Part 15	Title 47 of the Code of Federal Regulations; Chapter I Part 15 - Radio frequency devices
RSS - 210 Issue 8	Spectrum Management and Telecommunications - Radio Standards Specification Low-power Licence-exempt Radiocommunication Devices (All Frequency Bands): Category I Equipment

For further applied test standards please refer to section 3 of this test report.

Test Item

Kind of test item:	GSM Mobile Phone GPRS/EGPRS 850/900/1800/1900; UMTS HSPA FDDI/V/VIII; LTE FDD 1/3/5/7/8/20; WLAN a/b/g/n; BT 3.1; BT LE; RFID; FM Rx; A-GPS
Model name:	PM-0240-BV
FCC ID:	PY7PM-0240
IC:	4170B-PM0240
Frequency:	ISM band 5725 MHz to 5850 MHz (lowest channel 149 – 5745 MHz, highest channel 165 – 5825 MHz)
Technology tested:	WLAN (OFDM a, n HT20 & n HT40)
Antenna:	Integrated antenna
Power Supply:	3.7 V DC by Li - polymer battery
Temperature Range:	-20°C to +55 °C

Test report authorised:

2013-01-10 Stefan Bös
Senior Testing Manager

Test performed:

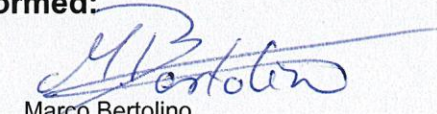
2013-01-10 Marco Bertolino
Testing Manager

1 Table of contents	
1	Table of contents2
2	General information3
2.1	Notes and disclaimer3
2.2	Application details.....3
3	Test standard/s3
3.1	Measurement guidance.....3
4	Test environment.....4
5	Test item4
6	Test laboratories sub-contracted4
7	Summary of measurement results5
8	RF measurements6
8.1	Description of test setup6
8.1.1	Radiated measurements.....6
8.1.2	Conducted measurements.....7
8.2	Additional comments7
8.3	RSP100 test report cover sheet / performance test data8
9	Measurement results.....9
9.1	Antenna gain9
9.2	Maximum output power12
9.3	Power spectral density19
9.4	Spectrum bandwidth – 6 dB25
9.5	Spectrum bandwidth – 20 dB31
9.6	Band edge compliance conducted37
9.7	Band edge compliance radiated37
9.8	TX spurious emissions conducted38
9.9	TX spurious emissions radiated46
9.10	RX spurious emissions radiated63
9.11	Spurious emissions radiated < 30 MHz67
9.12	Spurious emissions conducted < 30 MHz69
10	Test equipment and ancillaries used for tests72
11	Observations73
Annex A	Photographs of the test setup74
Annex B	External photographs of the EUT79
Annex C	Internal photographs of the EUT83
Annex D	Document history89
Annex E	Further information.....89
Annex F	Accreditation Certificate90

2 General information

2.1 Notes and disclaimer

The test results of this test report relate exclusively to the test item specified in this test report. CETECOM ICT Services GmbH does not assume responsibility for any conclusions and generalizations drawn from the test results with regard to other specimens or samples of the type of the equipment represented by the test item.

The test report may only be reproduced or published in full. Reproduction or publication of extracts from the report requires the prior written approval of CETECOM ICT Services GmbH.

The testing service provided by CETECOM ICT Services GmbH has been rendered under the current "General Terms and Conditions for CETECOM ICT Services GmbH".

CETECOM ICT Services GmbH will not be liable for any loss or damage resulting from false, inaccurate, inappropriate or incomplete product information provided by the customer.

Under no circumstances does the CETECOM ICT Services GmbH test report include any endorsement or warranty regarding the functionality, quality or performance of any other product or service provided.

Under no circumstances does the CETECOM ICT Services GmbH test report include or imply any product or service warranties from CETECOM ICT Services GmbH, including, without limitation, any implied warranties of merchantability, fitness for purpose, or non-infringement, all of which are expressly disclaimed by CETECOM ICT Services GmbH.

All rights and remedies regarding vendor's products and services for which CETECOM ICT Services GmbH has prepared this test report shall be provided by the party offering such products or services and not by CETECOM ICT Services GmbH.

In no case this test report can be considered as a Letter of Approval.

2.2 Application details

Date of receipt of order:	2012-11-02
Date of receipt of test item:	2012-11-12
Start of test:	2012-11-19
End of test:	2012-11-21
Person(s) present during the test:	-/-

3 Test standard/s

Test standard	Date	Test standard description
47 CFR Part 15	2010-10	Title 47 of the Code of Federal Regulations; Chapter I Part 15 - Radio frequency devices
RSS - 210 Issue 8	2010-12	Spectrum Management and Telecommunications - Radio Standards Specification Low-power Licence-exempt Radiocommunication Devices (All Frequency Bands): Category I Equipment

3.1 Measurement guidance

DTS : KDB 558074	2012-04	Guidance for Performing Compliance Measurements on Digital Transmission Systems (DTS) Operating Under §15.247
------------------	---------	---

4 Test environment

Temperature:	T_{nom}	+22 °C during room temperature tests
	T_{max}	+55 °C during high temperature tests
	T_{min}	-20 °C during low temperature tests
Relative humidity content:		46 %
Barometric pressure:		not relevant for this kind of testing
Power supply:	V_{nom}	3.7 V DC by Li - polymer battery
	V_{max}	4.1 V
	V_{min}	3.3 V

5 Test item

Kind of test item	:	GSM Mobile Phone GPRS/EGPRS 850/900/1800/1900; UMTS HSPA FDDI/V/VIII; LTE FDD 1/3/5/7/8/20; WLAN a/b/g/n; BT 3.1; BT LE; RFID; FM Rx; A-GPS
Type identification	:	PM-0240-BV
S/N serial number	:	Rad. CB5121SWF0, CB5121SWEK Cond. CB5121SWLW, CB5121SWNW
HW hardware status	:	SP1.2
SW software status	:	10.1.A.0.194, 10.1.A.1.17
Frequency band [MHz]	:	ISM band 5725 MHz to 5850 MHz (lowest channel 149 – 5745 MHz, highest channel 165 – 5825 MHz)
Type of radio transmission	:	OFDM
Use of frequency spectrum	:	
Channel access method	:	FDMA
Type of modulation	:	QPSK, 16-QAM, 64-QAM
Number of channels	:	a & n HT20 – mode: 5 n HT40 – mode: 2
Antenna	:	Integrated antenna
Power supply	:	3.7 V DC by Li - polymer battery
Temperature range	:	-20°C to +55 °C

6 Test laboratories sub-contracted

None

7 Summary of measurement results

- No deviations from the technical specifications were ascertained
- There were deviations from the technical specifications ascertained

TC Identifier	Description	Verdict	Date	Remark
RF-Testing	CFR Part 15 RSS 210, Issue 8	Passed	2013-01-10	-/-

Test specification clause	Test case	Temperature conditions	Power source voltages	Mode	Pass	Fail	NA	NP	Remark
§15.247(b)(4) RSS 210 / A8.4(2)	Antenna gain	Nominal	Nominal	OFDM	<input checked="" type="checkbox"/>	<input type="checkbox"/>	<input type="checkbox"/>	<input type="checkbox"/>	complies
§15.247(e) RSS 210 / A8.2(b)	Power spectral density	Nominal	Nominal	OFDM	<input checked="" type="checkbox"/>	<input type="checkbox"/>	<input type="checkbox"/>	<input type="checkbox"/>	complies
§15.247(a)(2) RSS 210 / A8.2(a)	Spectrum bandwidth - 6dB bandwidth	Nominal	Nominal	OFDM	<input checked="" type="checkbox"/>	<input type="checkbox"/>	<input type="checkbox"/>	<input type="checkbox"/>	complies
§15.247(a)(2) RSS 210 / A8.2(a)	Spectrum bandwidth - 20dB bandwidth	Nominal	Nominal	OFDM	<input checked="" type="checkbox"/>	<input type="checkbox"/>	<input type="checkbox"/>	<input type="checkbox"/>	complies
§15.247(b)(3) RSS-210 / A8.4(4)	Maximum output power	Nominal	Nominal	OFDM	<input checked="" type="checkbox"/>	<input type="checkbox"/>	<input type="checkbox"/>	<input type="checkbox"/>	complies
§15.247(d) RSS-210 / A8.5	Band edge compliance conducted	Nominal	Nominal	OFDM	<input checked="" type="checkbox"/>	<input type="checkbox"/>	<input type="checkbox"/>	<input type="checkbox"/>	complies
§15.205 RSS-210 / A8.5	Band edge compliance radiated	Nominal	Nominal	OFDM	<input checked="" type="checkbox"/>	<input type="checkbox"/>	<input type="checkbox"/>	<input type="checkbox"/>	complies
§15.247(d) RSS-210 / A8.5	TX spurious emissions conducted	Nominal	Nominal	OFDM	<input checked="" type="checkbox"/>	<input type="checkbox"/>	<input type="checkbox"/>	<input type="checkbox"/>	complies
§15.247(d) RSS-210 / A8.5	TX spurious emissions radiated	Nominal	Nominal	OFDM	<input checked="" type="checkbox"/>	<input type="checkbox"/>	<input type="checkbox"/>	<input type="checkbox"/>	complies
§15.109 RSS-Gen	RX spurious emissions radiated	Nominal	Nominal	-/-	<input checked="" type="checkbox"/>	<input type="checkbox"/>	<input type="checkbox"/>	<input type="checkbox"/>	complies
§15.209(a) RSS-Gen	TX spurious emissions radiated < 30 MHz	Nominal	Nominal	OFDM	<input checked="" type="checkbox"/>	<input type="checkbox"/>	<input type="checkbox"/>	<input type="checkbox"/>	complies
§15.107(a)	Conducted emissions < 30 MHz	Nominal	Nominal	OFDM	<input checked="" type="checkbox"/>	<input type="checkbox"/>	<input type="checkbox"/>	<input type="checkbox"/>	complies

Note: NA = Not Applicable; NP = Not Performed

8 RF measurements

8.1 Description of test setup

8.1.1 Radiated measurements

The radiated measurements are performed in vertical and horizontal plane in the frequency range from 9 kHz to 25 GHz in semi-anechoic chambers. The EUT is positioned on a non-conductive support with a height of 0.80 m above a conductive ground plane that covers the whole chamber. The receiving antennas are confirmed with specifications ANSI C63.2-1996 clause 15 and ANSI C63.4-2009 clause 4.1.5. These antennas can be moved over the height range between 1.0 m and 4.0 m in order to search for maximum field strength emitted from EUT. The measurement distances between EUT and receiving antennas are indicated in the test setups for the various frequency ranges. For each measurement, the EUT is rotated in all three axes until the maximum field strength is received. The wanted and unwanted emissions are received by spectrum analysers where the detector modes and resolution bandwidths over various frequency ranges are set according to requirement ANSI C63-4-2009 clause 4.2.

Antennas are confirmed with ANSI C63.2-1996 item 15.

Semi anechoic chamber

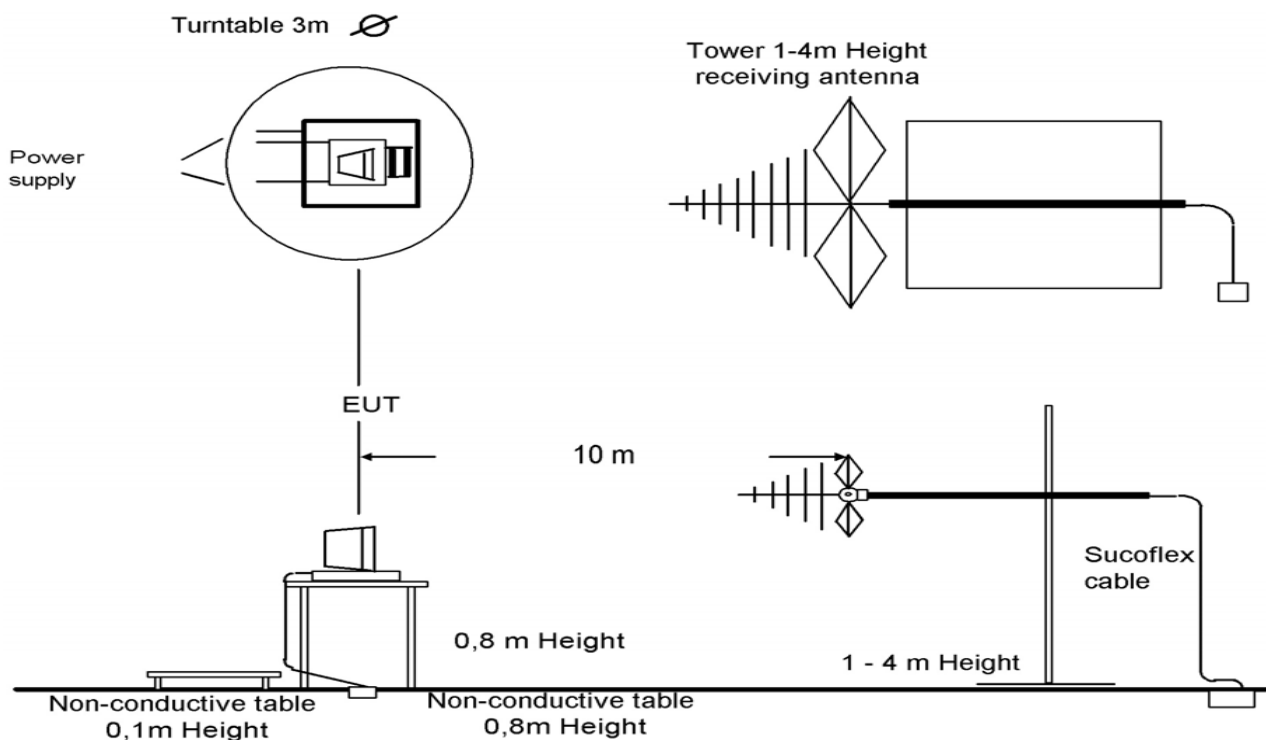

Picture 1: Diagram radiated measurements

9 kHz - 30 MHz:	active loop antenna
30 MHz – 1 GHz:	tri-log antenna
> 1 GHz:	horn antenna

The EUT is powered by an external power supply with nominal voltage. The signalling is performed from outside the chamber with a signalling unit (CMU200 or other) by air link using signalling antenna.

8.1.2 Conducted measurements

The EUT's RF signal is coupled out by the antenna connector which is supplied by the manufacturer. The signal is first 10dB attenuated before it is power divided (~6dB loss per branch). One of the signal paths is connected to the communication base Station (CMU200 or other), the other one is connected to the spectrum analyzer. The specific losses for both signal paths are first checked within a calibration. The measurement readings on the signalling unit/spectrum analyzer are corrected by the specific test set-up loss. The attenuator, power divider, signalling unit and the spectrum analyzer are impedance matched on 50 Ohm.

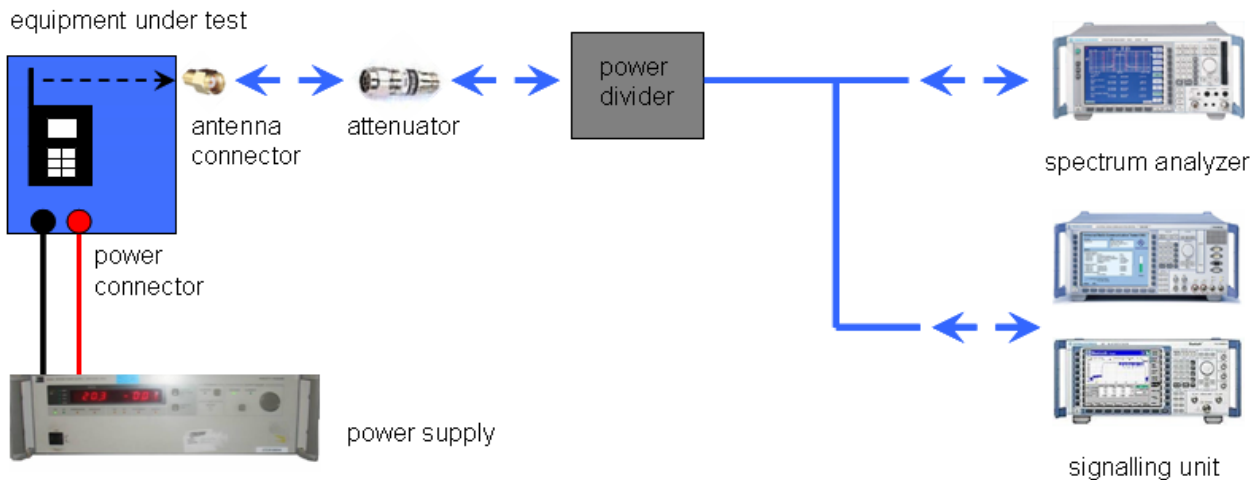

Picture 2: Diagram conducted measurements

8.2 Additional comments

Reference documents: WLAN Odin Gina SAR request and power data (SAR power verification)

a – mode: wbtX=channel,rate,2,1000,200,0,15,0,1

n HT 20 – mode: wbtX=channel,rate,3,1000,200,0,14,0,1

n HT 40 – mode: wbtX=channel,rate,3,2000,200,0,14,1,1

Special test descriptions: None

Configuration descriptions: None

- Test mode:
- No test mode available.
lperf was used to ping another device with the largest support packet size
 - Special software is used.
EUT is transmitting pseudo random data by itself

8.3 RSP100 test report cover sheet / performance test data

Test report number	:	1-4254/12-61-10-A
Equipment model number	:	PM-0240-BV
Certification number	:	4170B-PM0240
Manufacturer (complete address)	:	Sony Mobile Communications AB Nya Vattentorget 22188 Lund / SWEDEN
Tested to radio standards specification no.	:	RSS 210, Issue 8
Open area test site IC No.	:	IC 3462C-1
Frequency range	:	Lowest channel 5745 MHz, highest channel 5825 MHz
RF-power [W] (max.)	:	Conducted output power: 135.52 mW (OFDM / a – mode) 123.88 mW (OFDM / n – mode HT20) 136.77 mW (OFDM / n – mode HT40) Radiated output power: 138.04 mW (OFDM / a – mode) 140.28 mW (OFDM / n – mode HT20) 132.74 mW (OFDM / n – mode HT40)
Occupied bandwidth (99%-BW) [kHz]	:	OFDM / a – mode: 18.6 MHz OFDM / n – mode HT20: 18.3 MHz OFDM / n – mode HT40: 37.7 MHz
Type of modulation	:	QPSK, 16 – QAM, 64 – QAM
Emission designator (TRC-43)	:	18M6G7D (OFDM / a – mode) 18M3G7D (OFDM / n – mode HT20) 37M7G7D (OFDM / n – mode HT40)
Antenna information	:	Integrated antenna
Transmitter spurious (worst case) [dB μ V/m @ 3m]:		48 @ 12.5 GHz (noise floor / peak)
Receiver spurious (worst case) [dB μ V/m @ 3m]:		48 @ 12.5 GHz (noise floor / peak)

ATTESTATION:

DECLARATION OF COMPLIANCE:

I attest that the testing was performed or supervised by me; that the test measurements were made in accordance with the above-mentioned Industry Canada standard(s); and that the equipment identified in this application has been subjected to all the applicable test conditions specified in the Industry Canada standards and all of the requirements of the standard have been met.

Laboratory manager:

2013-01-10

Marco Bertolino

Date

Name

Signature

9 Measurement results

9.1 Antenna gain

Measurement:

The antenna gain of the complete system is calculated by the difference of radiated power in EIRP and the conducted power of the module. For normal WLAN devices, the DSSS mode is used.

Measurement parameters:

Measurement parameter	
Detector:	Peak
Sweep time:	5 s
Resolution bandwidth:	3 MHz
Video bandwidth:	10 MHz
Trace-Mode:	Max hold

Limits:

FCC	IC
Antenna Gain	
6 dBi	

Results:

T _{nom}	V _{nom}	lowest channel 5745 MHz	middle channel 5785 MHz	highest channel 5825 MHz
Conducted power [dBm]		17.07	17.33	17.66
Radiated power [dBm]		17.03	17.20	18.20
Gain [dBi] Calculated		-0.04	-0.13	+0.54
Measurement uncertainty			± 1.5 dB (cond.) / ± 3 dB (rad.)	

Result: **Passed**

Plots: conducted power for gain calculation

Plot 1: low channel

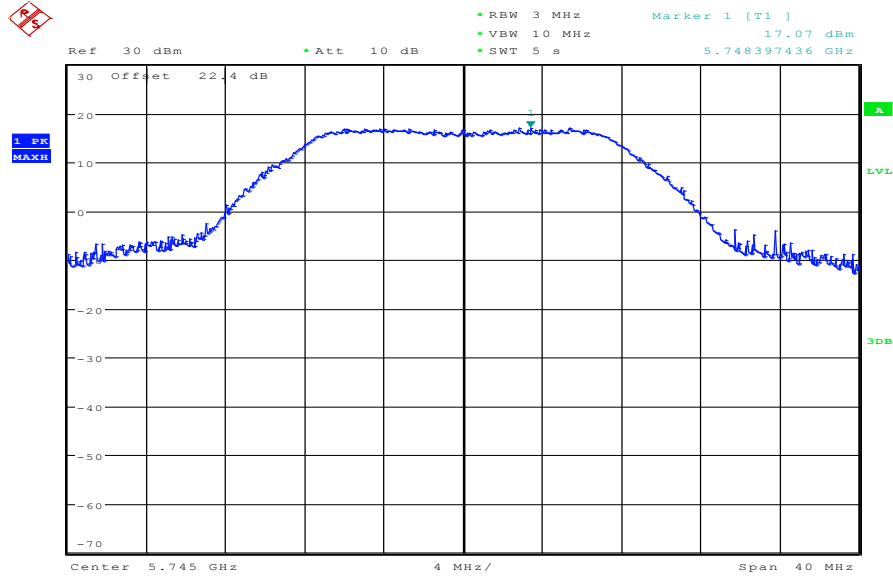

Date: 30.NOV.2012 12:42:45

Plot 2: middle channel

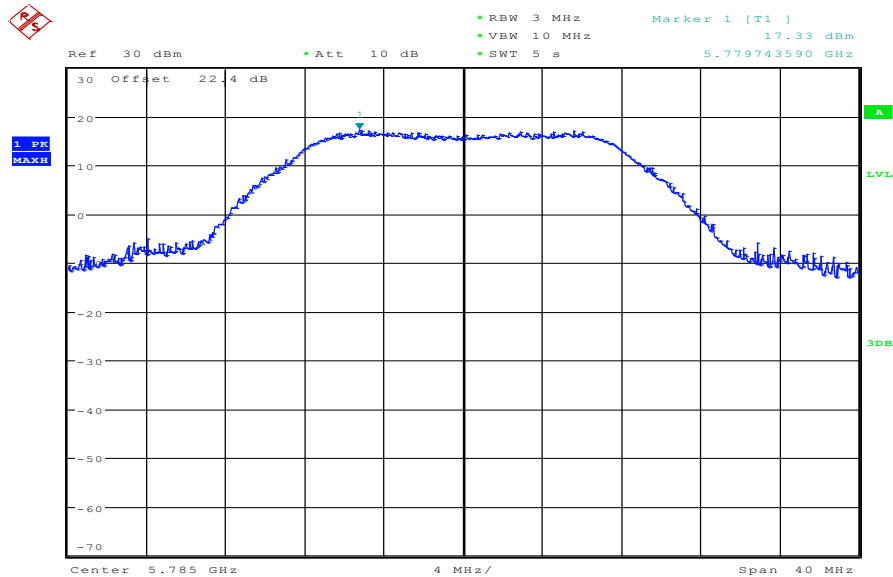

Date: 30.NOV.2012 12:44:06

Plot 3: high channel

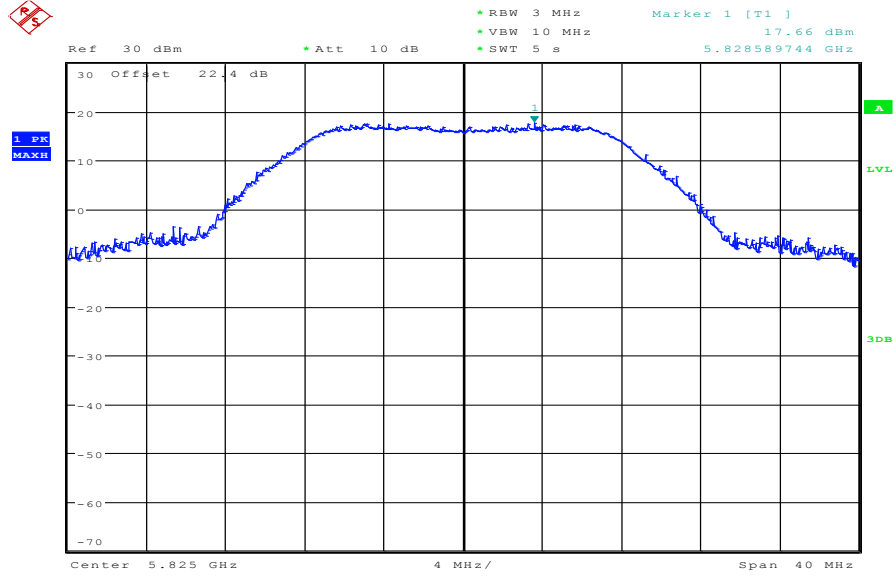

Date: 30.NOV.2012 12:45:27

9.2 Maximum output power

Description:

Measurement of the maximum output power conducted and radiated. The measurements are performed using the data rate producing the highest conducted output power. The determination of these data rates was performed at the beginning of the tests.

Measurement:

Measurement parameter	
Detector:	Peak
Sweep time:	Auto
Resolution bandwidth:	3 MHz / 10 MHz (at least 1 MHz)
Video bandwidth:	≥ 3 x RBW (or maximum of available setting)
Span:	> DTS bandwidth
Trace-Mode:	Max hold (allow trace to fully stabilize)

Limits:

FCC	IC
Maximum Output Power	
Conducted: 1.0 W – Antenna Gain max. 6 dBi	

Results: OFDM / a – mode

OFDM / a – mode Frequency	Maximum Output Power [dBm]		
	5745 MHz	5785 MHz	5825 MHz
Peak Output Power Conducted	20.76	21.32	20.86
Output Power Radiated – EIRP*)	20.72	21.19	21.40
Measurement uncertainty	± 1.5 dB (cond.) / ± 3 dB (rad.)		

*) calculated with Antenna gain

Result: Passed

Results: OFDM / n – mode HT20

OFDM / n – mode HT20 Frequency	Maximum Output Power [dBm]		
	5745 MHz	5785 MHz	5825 MHz
Peak Output Power Conducted	19.97	20.13	20.93
Output Power Radiated – EIRP*)	19.93	20.00	21.47
Measurement uncertainty	± 1.5 dB (cond.) / ± 3 dB (rad.)		

*) calculated with Antenna gain

Result: Passed**Results: OFDM / n – mode HT40**

OFDM / n – mode HT40 Frequency	Maximum Output Power [dBm]		
	5755 MHz	5795 MHz	-/-
Peak Output Power Conducted	21.07	21.36	-/-
Output Power Radiated – EIRP*)	21.03	21.23	-/-
Measurement uncertainty	± 1.5 dB (cond.) / ± 3 dB (rad.)		

*) calculated with Antenna gain

Result: Passed

Plots: OFDM / a – mode

Plot 1: TX mode, lowest channel

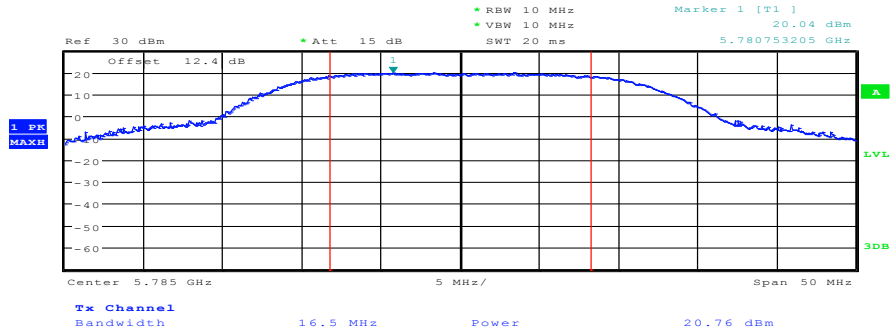

Date: 10.JAN.2013 09:32:49

Plot 2: TX mode, middle channel

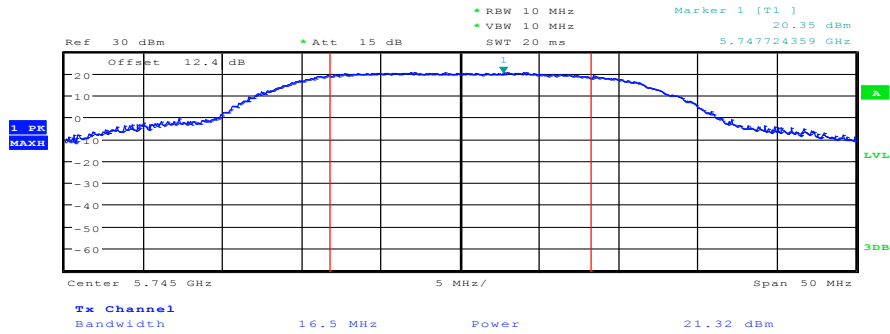

Date: 10.JAN.2013 09:27:12

Plot 3: TX mode, highest channel

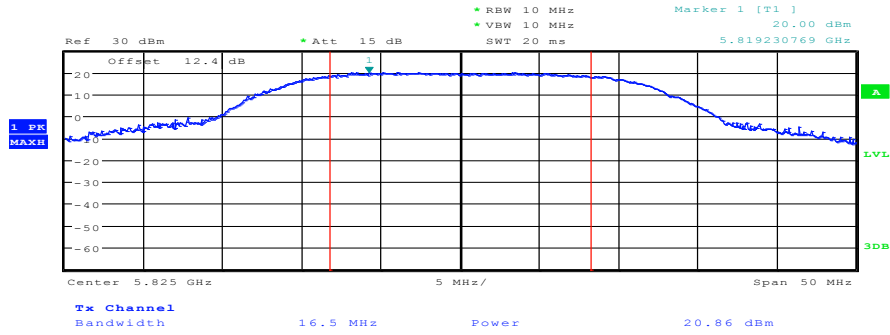

Date: 10.JAN.2013 09:38:20

Plots: OFDM / n – mode HT20

Plot 1: TX mode, lowest channel

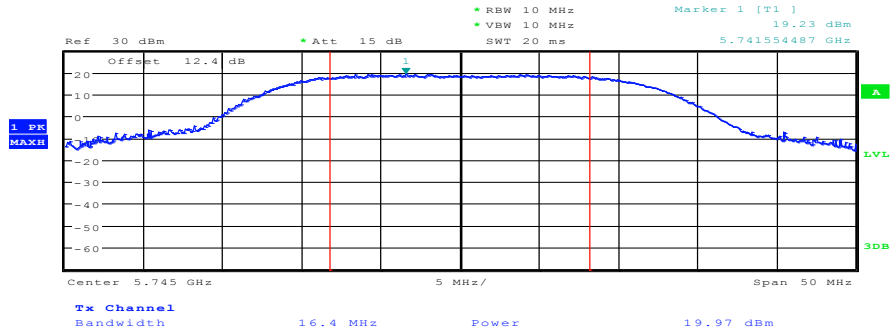

Date: 10.JAN.2013 09:50:20

Plot 2: TX mode, middle channel

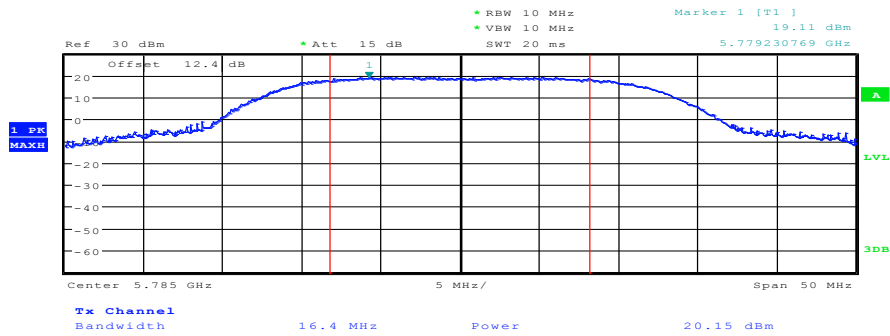

Date: 10.JAN.2013 09:53:46

Plot 3: TX mode, highest channel

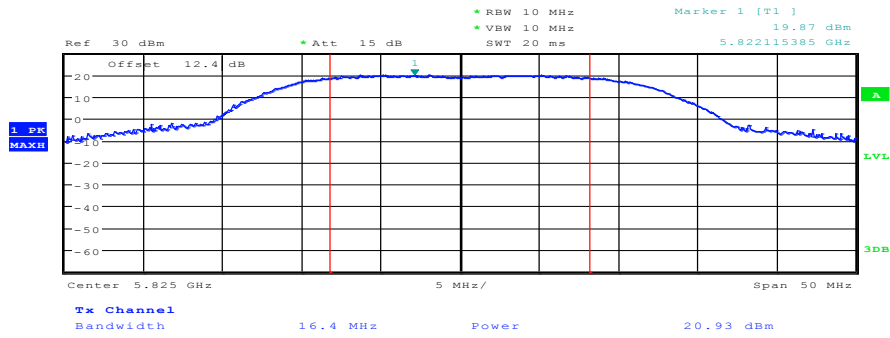

Date: 10.JAN.2013 10:16:59

Plots: OFDM / n – mode HT40

Plot 1: TX mode, lowest channel

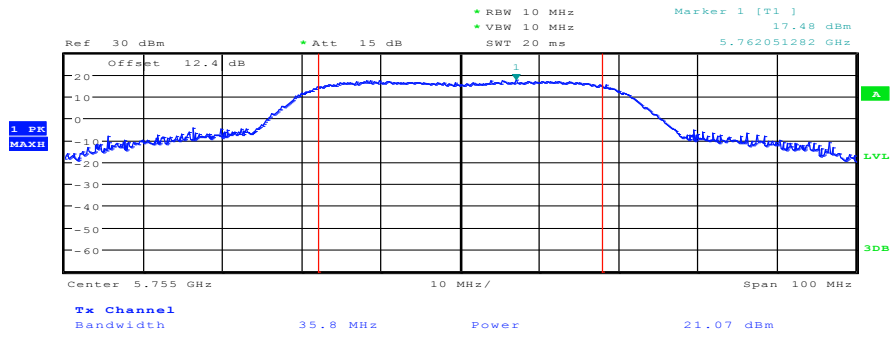

Date: 10.JAN.2013 10:21:53

Plot 2: TX mode, highest channel

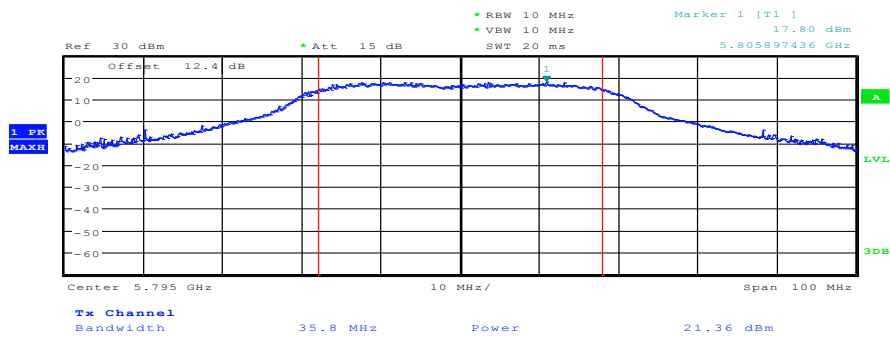

Date: 10.JAN.2013 10:28:02

9.3 Power spectral density

Description:

Measurement of the power spectral density of a digital modulated system. The measurement is repeated for both modulations at the lowest, middle and highest channel.

Measurement:

Measurement parameter	
Detector:	Peak
Sweep time:	Auto
Resolution bandwidth:	≥ 3 kHz
Video bandwidth:	≥ 3 x RBW
Span:	1.5 times of the DTS BW
Trace-Mode:	Max hold (allow trace to fully stabilize)

Limits:

FCC	IC
Power Spectral Density	
8 dBm (conducted)	

Results:

Modulation Frequency	Power Spectral density [dBm]		
	5725 MHz	5785 MHz	5825 MHz
OFDM / a – mode calculated value (to 3 kHz)	-13.60	-12.63	-12.25
OFDM / n – mode HT20 calculated value (to 3 kHz)	-14.05	-14.38	-13.77
Frequency	5755 MHz	5795 MHz	-/-
OFDM / n – mode HT40 calculated value (to 3 kHz)	-15.58	-15.20	-/-
Measurement uncertainty	± 1.5 dB		

Result: Passed

Plots: OFDM / a – mode

Plot 1: TX mode, lowest channel

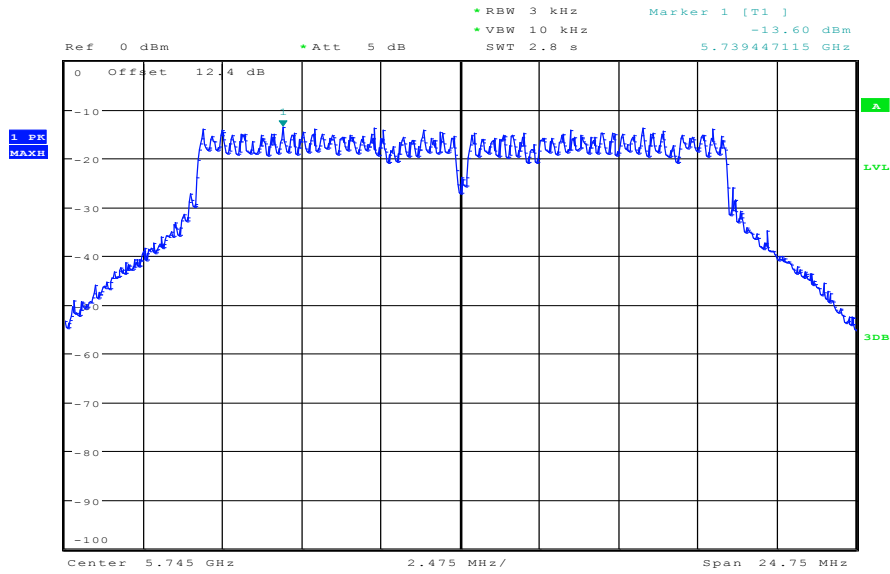

Date: 10.JAN.2013 11:05:06

Plot 2: TX mode, middle channel

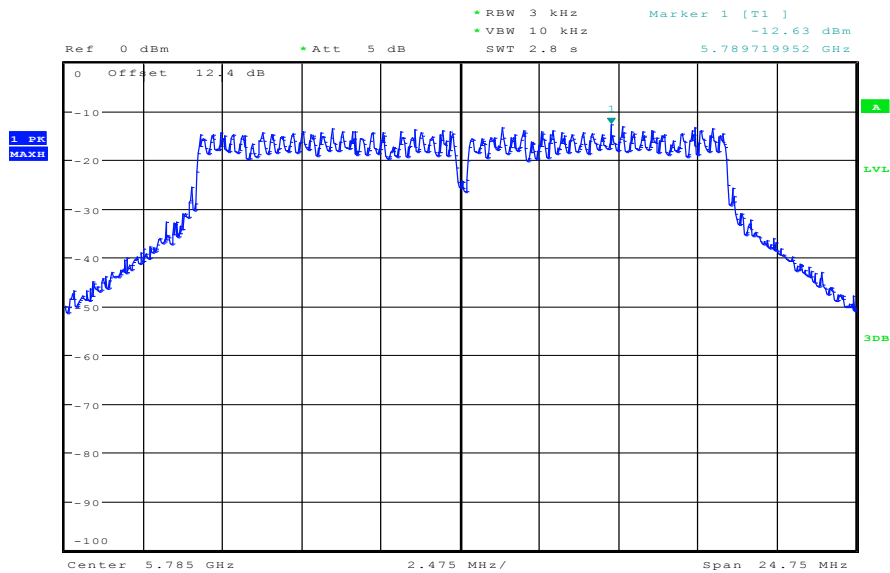

Date: 10.JAN.2013 11:07:12

Plot 3: TX mode, highest channel

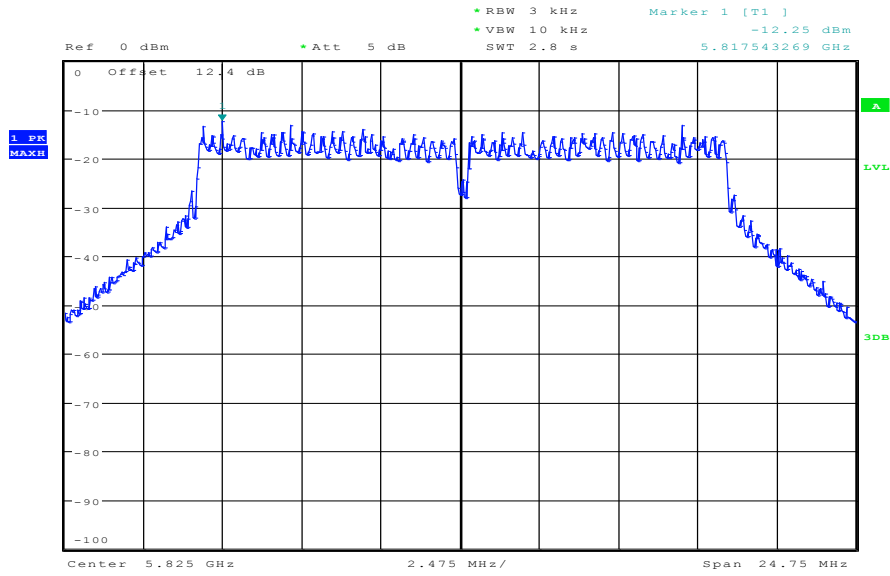

Date: 10.JAN.2013 11:09:09

Plots: OFDM / n – mode HT20

Plot 1: TX mode, lowest channel

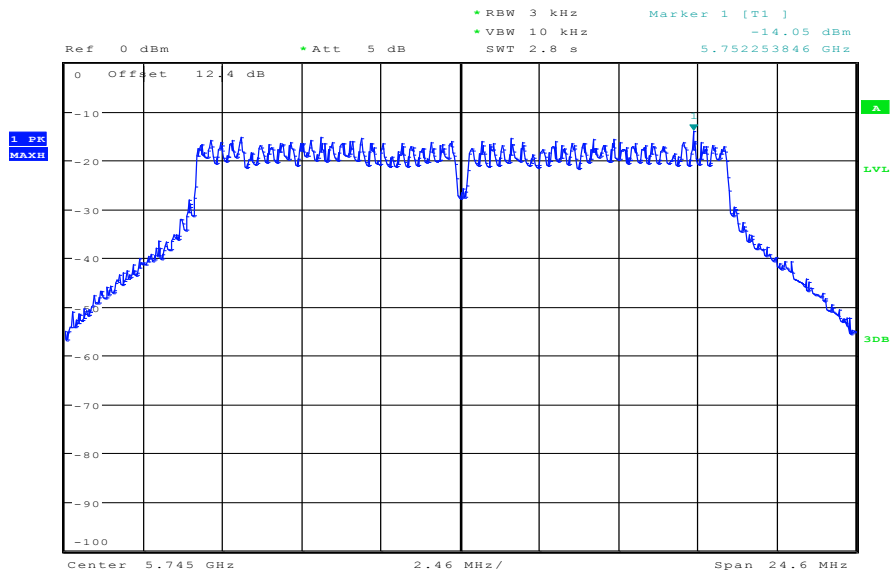

Date: 10.JAN.2013 10:55:09

Plot 2: TX mode, middle channel

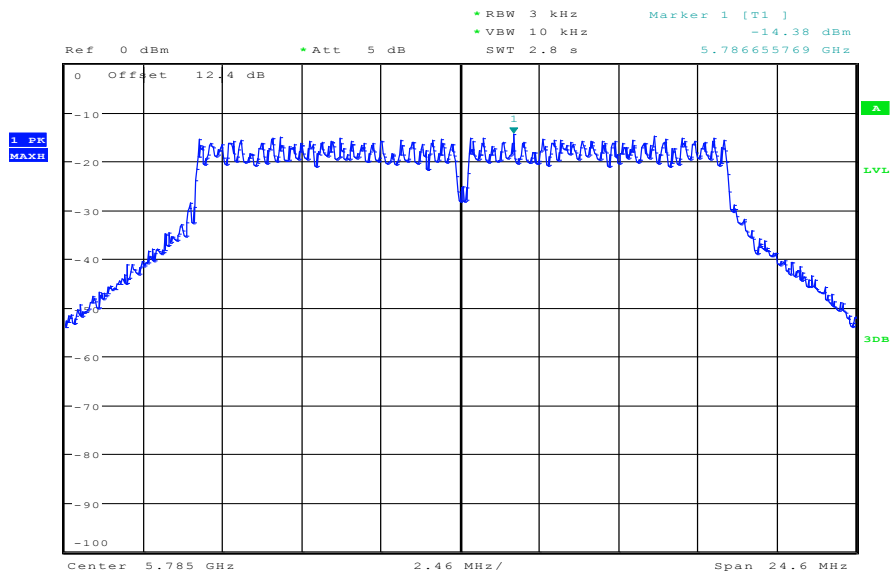

Date: 10.JAN.2013 10:56:36

Plot 3: TX mode, highest channel

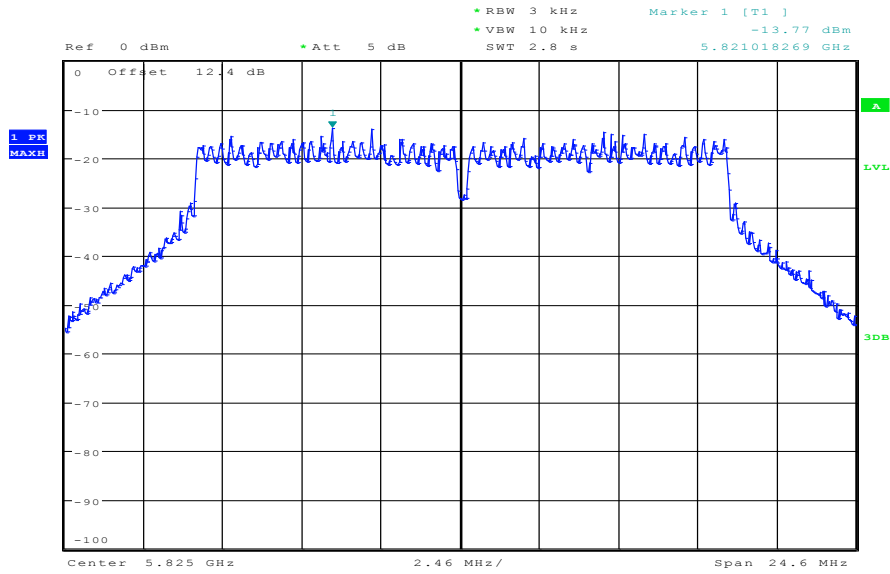

Date: 10.JAN.2013 10:58:28

Plots: OFDM / n – mode HT40

Plot 1: TX mode, lowest channel

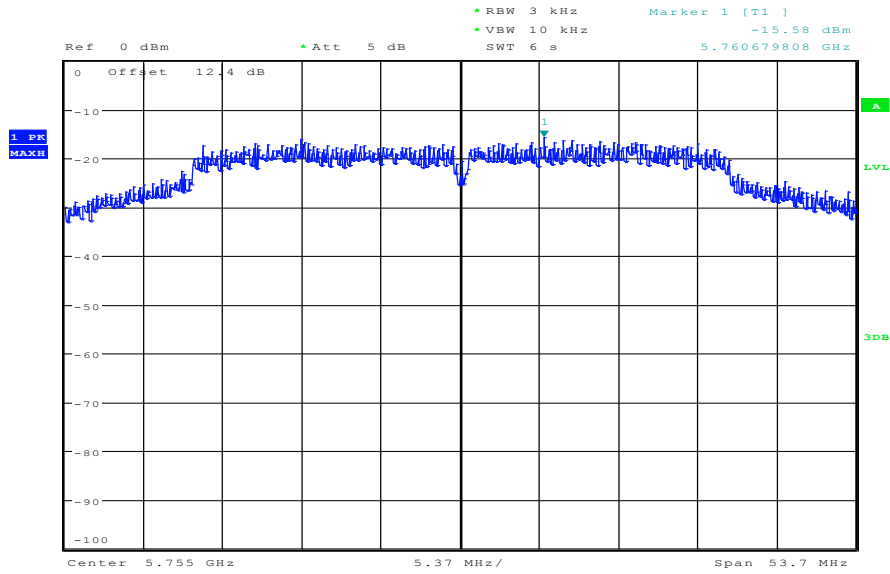

Date: 10.JAN.2013 10:51:26

Plot 2: TX mode, highest channel

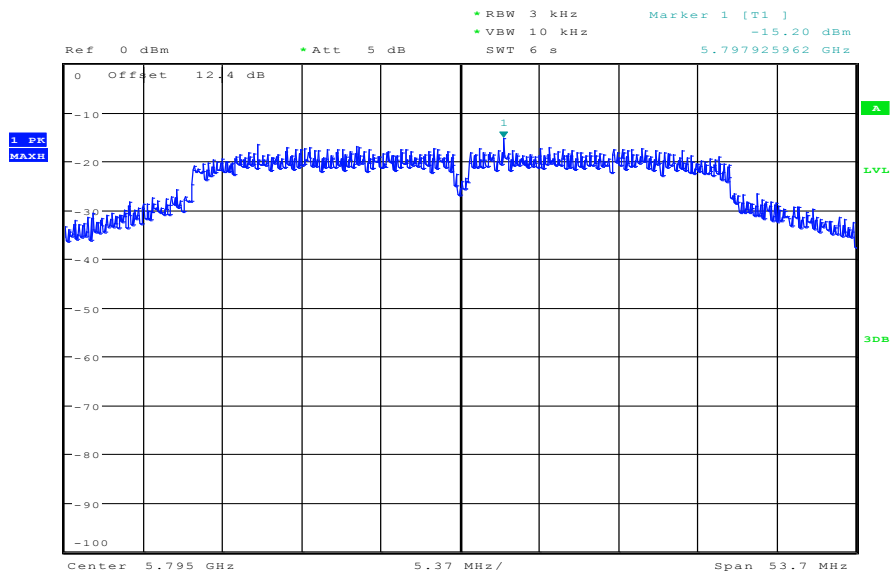

Date: 10.JAN.2013 10:47:56

9.4 Spectrum bandwidth – 6 dB

Description:

Measurement of the 6 dB bandwidth of the modulated signal.

Measurement:

Measurement parameter	
Detector:	Peak
Sweep time:	Auto
Resolution bandwidth:	1 - 5% of the DTS BW but not exceed 100 kHz
Video bandwidth:	≥ 3 x RBW
Span:	Complete signal
Trace-Mode:	Max hold (allow trace to stabilize)

Limits:

FCC	IC
Spectrum Bandwidth – 6 dB	
Systems using digital modulation techniques may operate in the 2400–2483.5 MHz band. The minimum 6 dB bandwidth shall be at least 500 kHz.	

Results:

Modulation Frequency	6 dB bandwidth [MHz]		
	Lowest channel	Middle channel	Highest channel
OFDM / a – mode	16.5	16.4	16.4
OFDM / n – mode HT20	16.4	16.4	16.4
OFDM / n – mode HT40	35.8	-/-	35.5
Measurement uncertainty	± RBW		

Result: **Passed**

Plots: OFDM / a – mode

Plot 1: TX mode, lowest channel

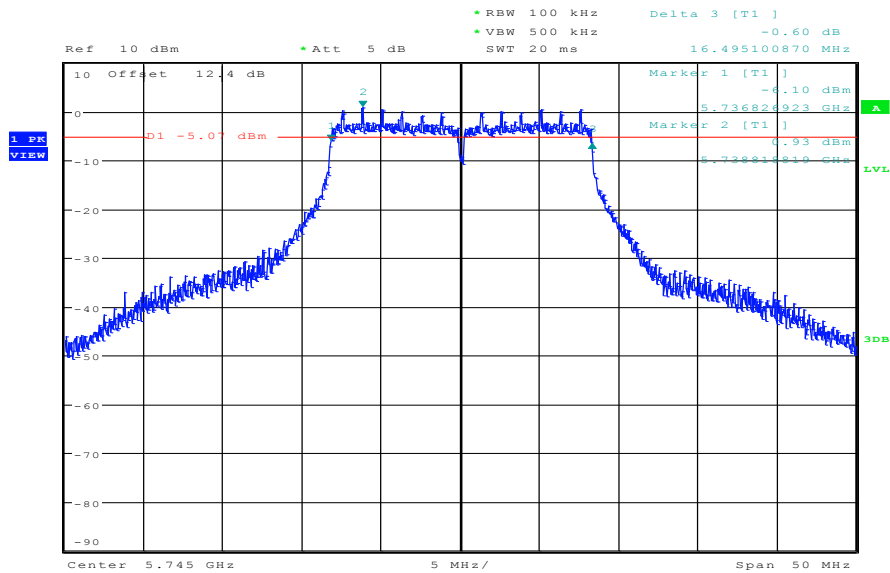

Date: 10.JAN.2013 08:28:30

Plot 2: TX mode, middle channel

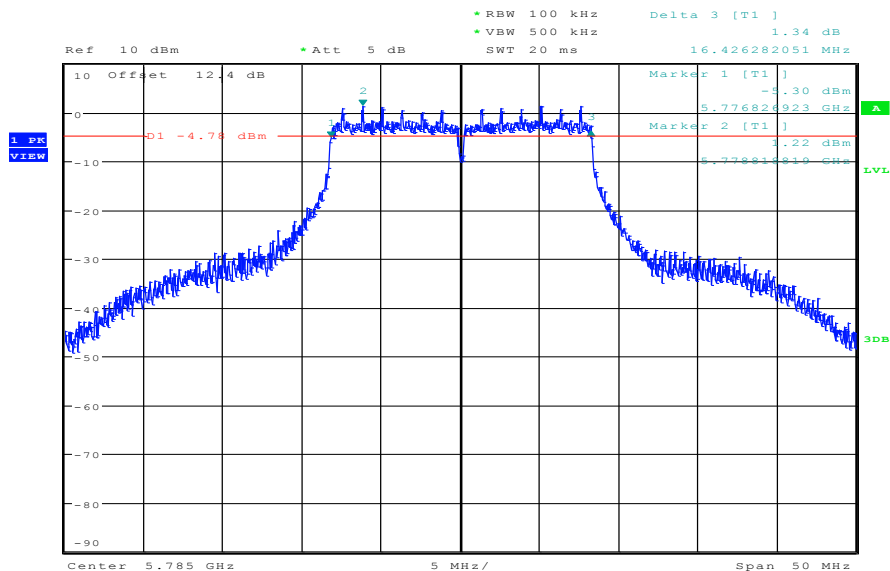

Date: 10.JAN.2013 08:33:58

Plot 3: TX mode, highest channel

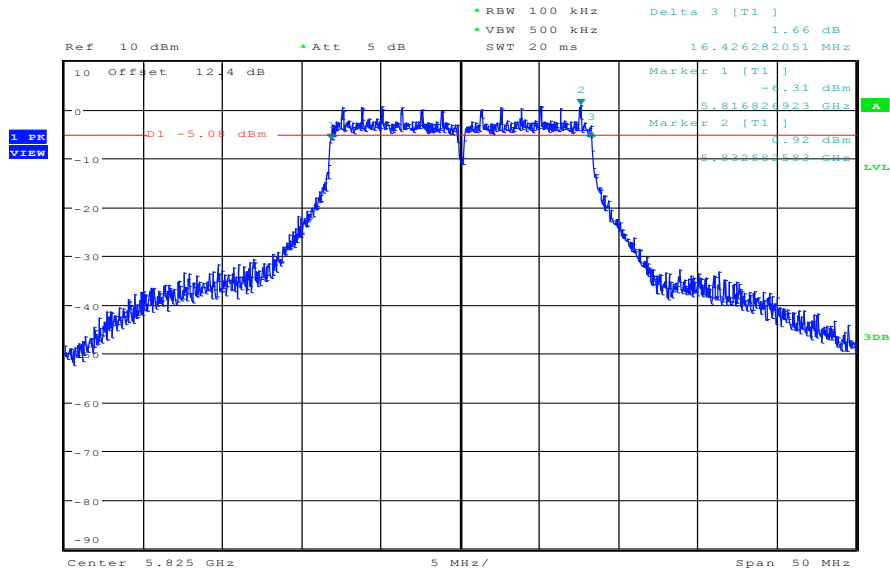

Date: 10.JAN.2013 08:36:38

Plots: OFDM / n – mode HT20

Plot 1: TX mode, lowest channel

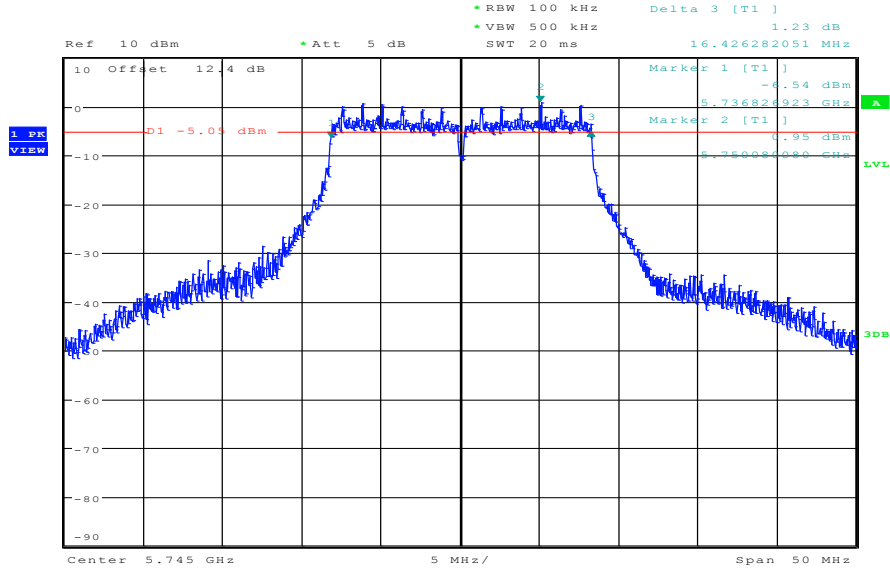

Date: 10.JAN.2013 08:40:14

Plot 2: TX mode, middle channel

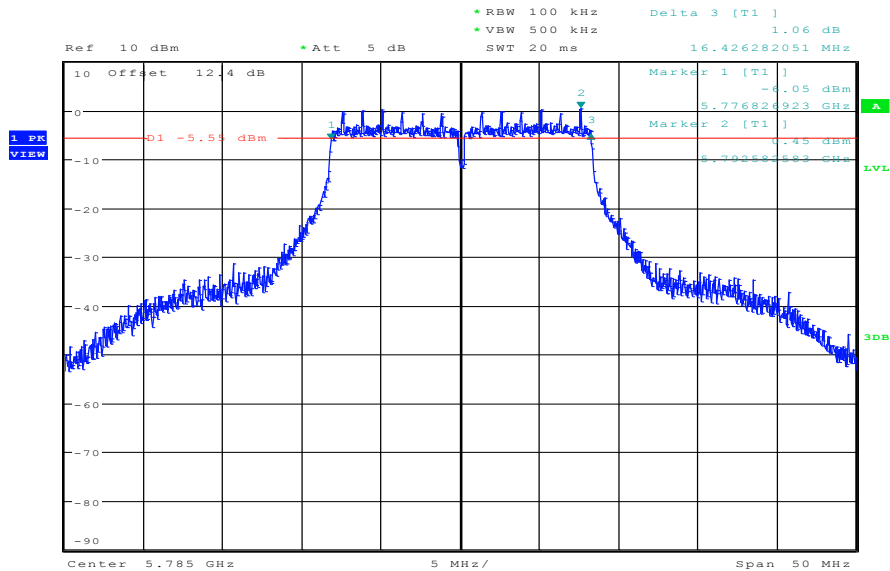

Date: 10.JAN.2013 08:47:25

Plot 3: TX mode, highest channel

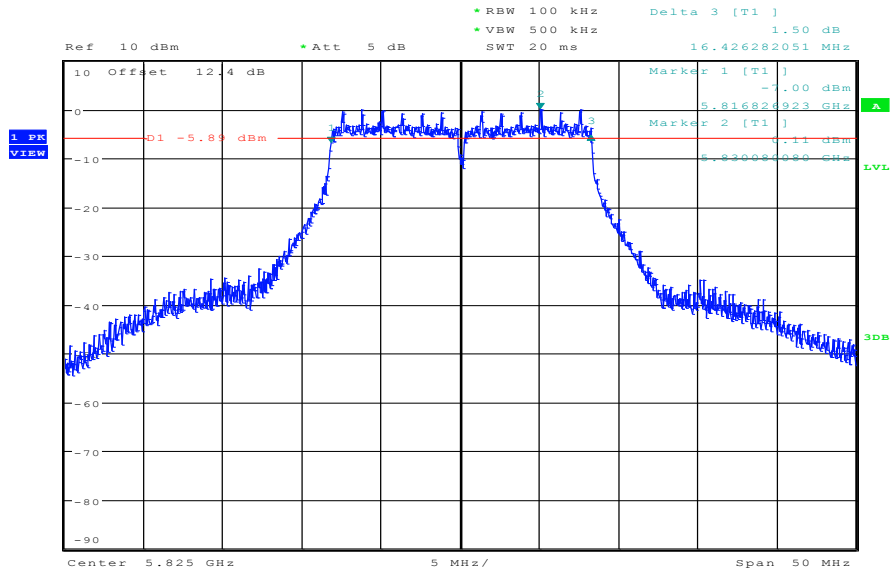

Date: 10.JAN.2013 08:49:50

Plots: OFDM / n – mode HT40

Plot 1: TX mode, lowest channel

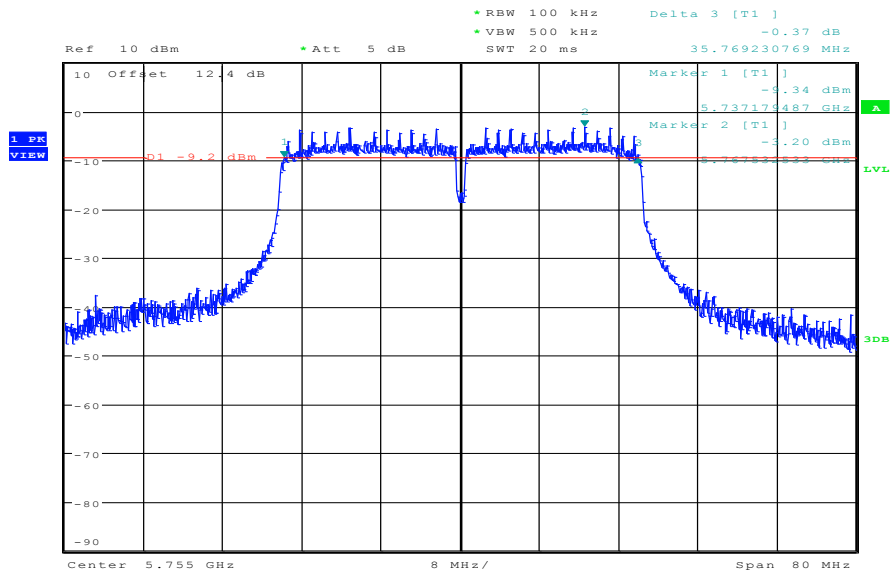

Date: 10.JAN.2013 08:55:11

Plot 2: TX mode, highest channel

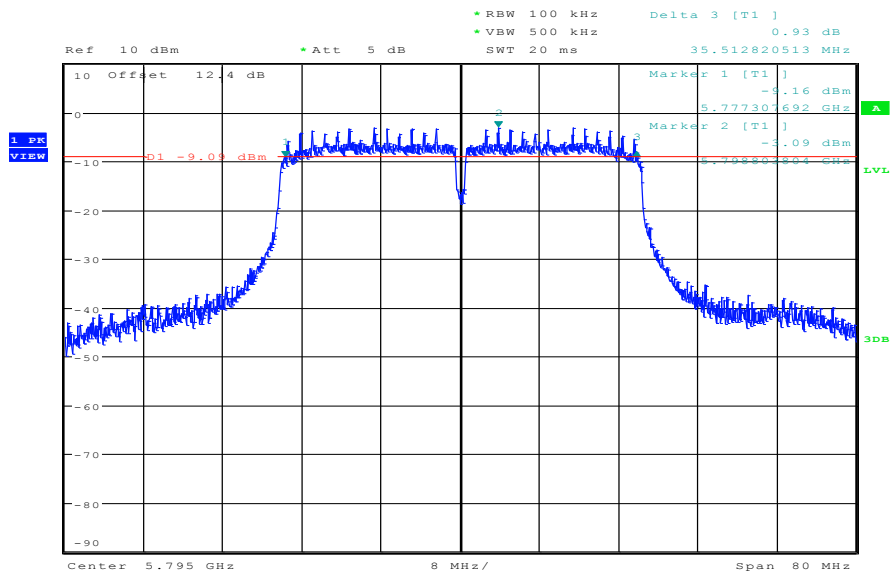

Date: 10.JAN.2013 08:59:34

9.5 Spectrum bandwidth – 20 dB

Description:

Measurement of the 20 dB bandwidth of the modulated signal.

Measurement:

Measurement parameter	
Detector:	Peak
Sweep time:	Auto
Resolution bandwidth:	1 - 5% of the DTS BW but not exceed 100 kHz
Video bandwidth:	≥ 3 x RBW
Span:	Complete signal
Trace-Mode:	Max hold (allow trace to stabilize)

Limits:

FCC	IC
Spectrum Bandwidth – 20 dB	
Systems using digital modulation techniques may operate in the 2400–2483.5 MHz band. The minimum 6 dB bandwidth shall be at least 500 kHz.	

Results:

Modulation Frequency	20 dB bandwidth [MHz]		
	Lowest channel	Middle channel	Highest channel
OFDM / a – mode	18.6	18.5	18.6
OFDM / n – mode HT20	18.3	18.0	18.2
OFDM / n – mode HT40	37.6	-/-	37.7
Measurement uncertainty	± RBW		

Result: **Passed**

Plots: OFDM / a – mode

Plot 1: TX mode, lowest channel

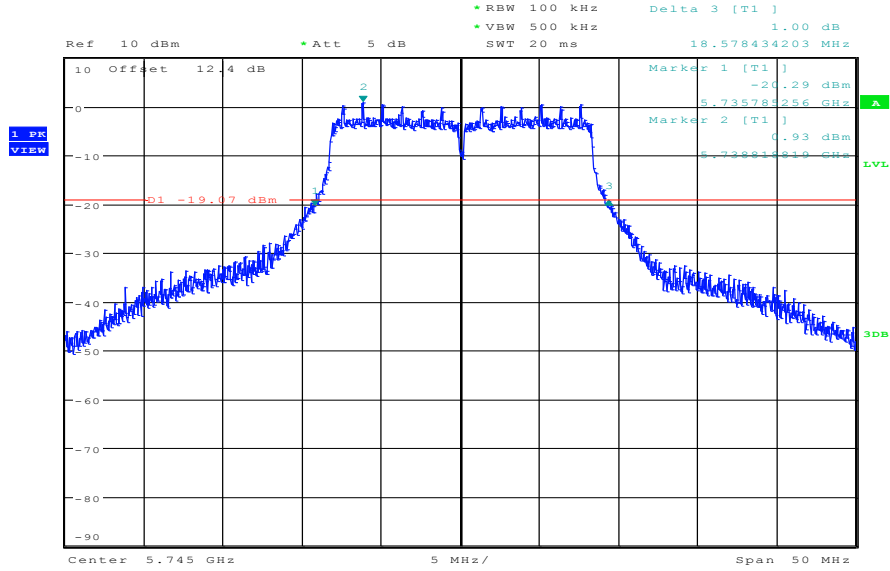

Date: 10.JAN.2013 08:29:05

Plot 2: TX mode, middle channel

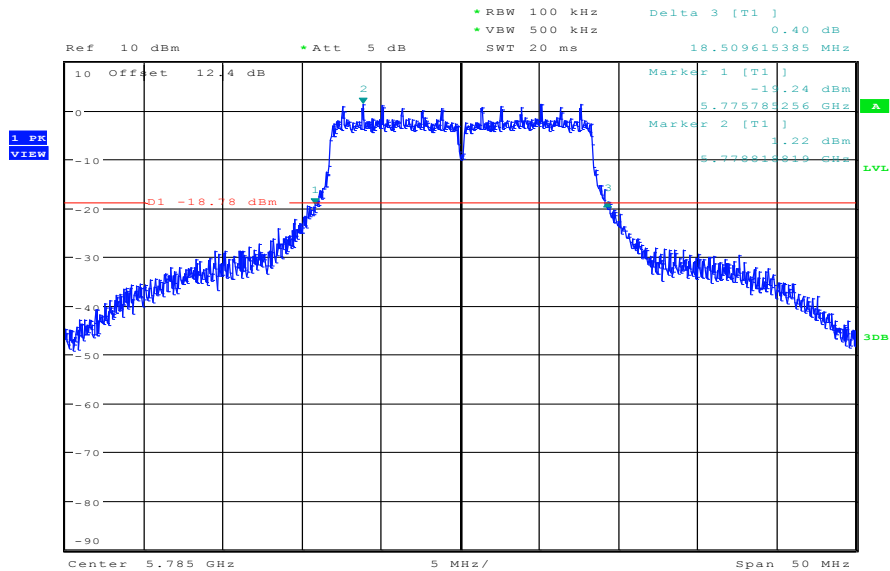

Date: 10.JAN.2013 08:34:41

Plot 3: TX mode, highest channel

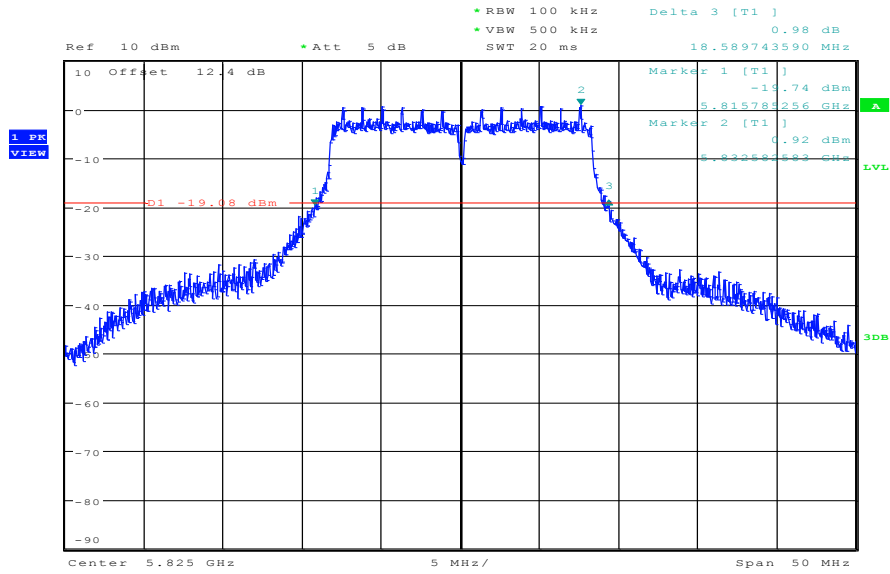

Date: 10.JAN.2013 08:37:26

Plots: OFDM / n – mode HT20

Plot 1: TX mode, lowest channel

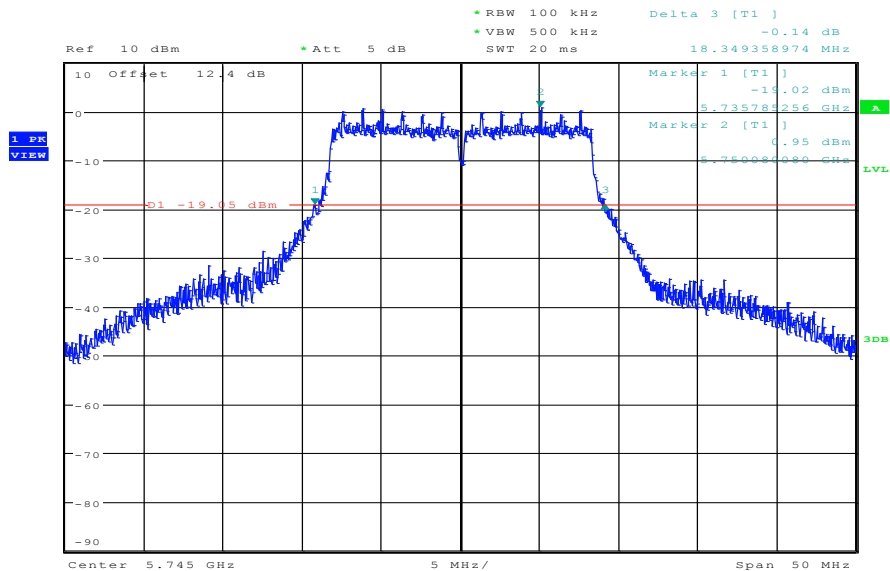

Date: 10.JAN.2013 08:40:45

Plot 2: TX mode, middle channel

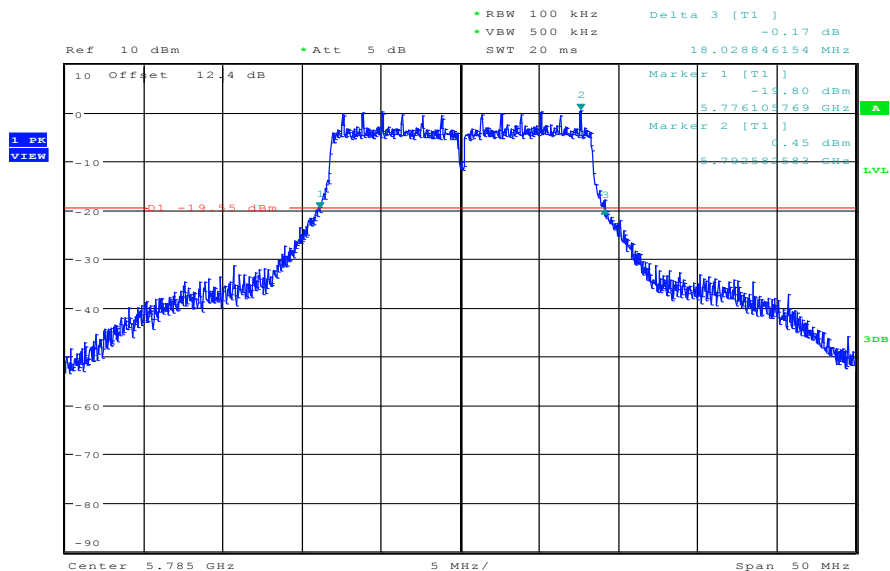

Date: 10.JAN.2013 08:47:58

Plot 3: TX mode, highest channel

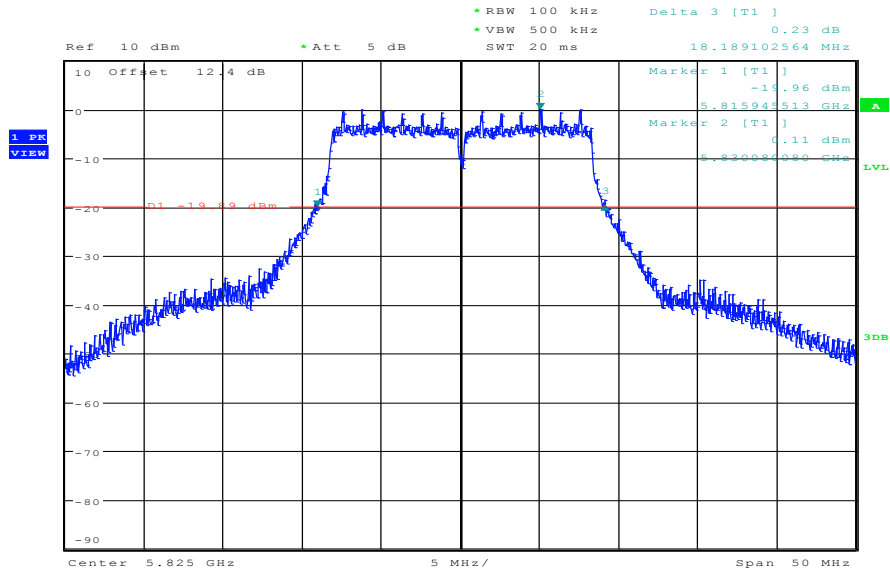

Date: 10.JAN.2013 08:50:32

Plots: OFDM / n – mode HT40

Plot 1: TX mode, lowest channel

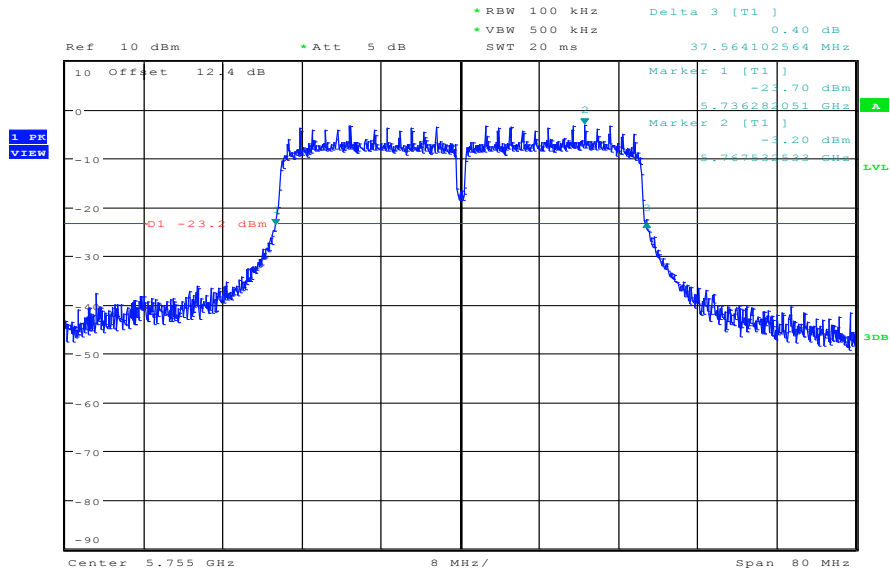

Date: 10.JAN.2013 08:55:40

Plot 2: TX mode, highest channel

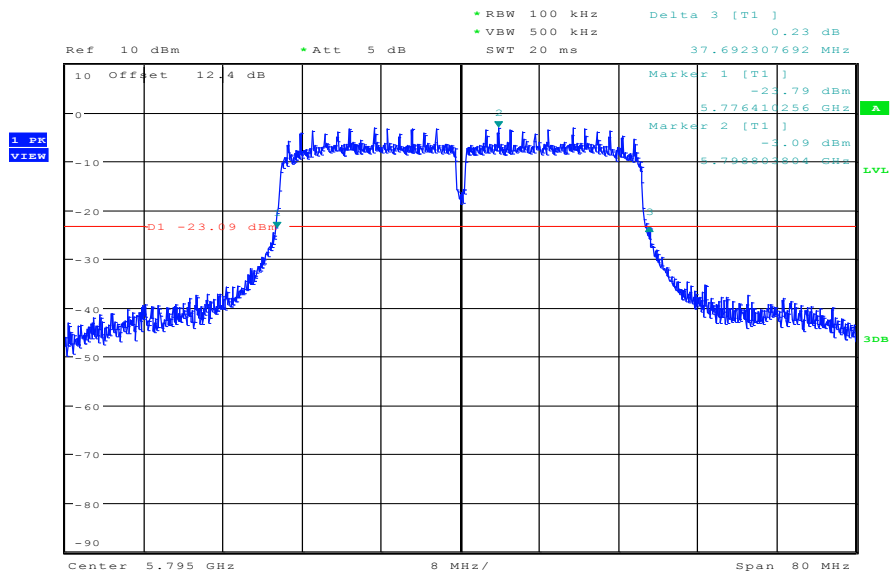

Date: 10.JAN.2013 09:00:12

9.6 Band edge compliance conducted

Not applicable! No restricted band close to used band!

9.7 Band edge compliance radiated

Not applicable! No restricted band close to used band!

9.8 TX spurious emissions conducted

Description:

Measurement of the conducted spurious emissions in transmit mode. The measurement is performed at the lowest, middle and highest channel. The measurement is repeated for all modulations.

Measurement:

Measurement parameter	
Detector:	Peak
Sweep time:	1s / 100 MHz
Resolution bandwidth:	F < 1 GHz: 100 kHz F > 1 GHz: 100 kHz
Video bandwidth:	F < 1 GHz: 500 kHz F > 1 GHz: 500 kHz
Span:	9 kHz to 25 GHz
Trace-Mode:	Max Hold

Limits:

FCC	IC
TX Spurious Emissions Conducted	
<p>In any 100 kHz bandwidth outside the frequency band in which the spread spectrum or digitally modulated intentional radiator is operating, the radio frequency power that is produced by the intentional radiator shall be at least 20 dB below that in the 100 kHz bandwidth within the band that contains the highest level of the desired power, based on either an RF conducted or a radiated measurement. Attenuation below the general limits specified in Section 15.209(a) is not required</p>	

Results: OFDM / a – mode

TX Spurious Emissions Conducted					
OFDM / a – mode					
f [MHz]		amplitude of emission [dBm]	limit max. allowed emission power	actual attenuation below frequency of operation [dB]	results
5745		-0.53	30 dBm		Operating frequency
No critical peaks detected. All detected emissions are below the -20 dBc criteria.			-20 dBc (peak) -30 dBc (average)		complies
5785		0.16	30 dBm		Operating frequency
No critical peaks detected. All detected emissions are below the -20 dBc criteria.			-20 dBc (peak) -30 dBc (average)		complies
5825		0.21	30 dBm		Operating frequency
No critical peaks detected. All detected emissions are below the -20 dBc criteria.			-20 dBc (peak) -30 dBc (average)		complies
Measurement uncertainty		± 3 dB			

Result: Passed

Results: OFDM / n – mode HT20

TX Spurious Emissions Conducted					
OFDM / n – mode HT20					
f [MHz]		amplitude of emission [dBm]	limit max. allowed emission power	actual attenuation below frequency of operation [dB]	results
5745		0.14	30 dBm		Operating frequency
No critical peaks detected. All detected emissions are below the -20 dBc criteria.			-20 dBc (peak) -30 dBc (average)		complies
5785		0.44	30 dBm		Operating frequency
No critical peaks detected. All detected emissions are below the -20 dBc criteria.			-20 dBc (peak) -30 dBc (average)		complies
5825		0.02	30 dBm		Operating frequency
No critical peaks detected. All detected emissions are below the -20 dBc criteria.			-20 dBc (peak) -30 dBc (average)		complies
Measurement uncertainty		± 3 dB			

Result: Passed

Results: OFDM / n – mode HT40

TX Spurious Emissions Conducted					
OFDM / n – mode HT40					
f [MHz]		amplitude of emission [dBm]	limit max. allowed emission power	actual attenuation below frequency of operation [dB]	results
5755		0.95	30 dBm		Operating frequency
No critical peaks detected. All detected emissions are below the -20 dBc criteria.			-20 dBc (peak) -30 dBc (average)		complies
5785		-3.4	30 dBm		Operating frequency
No critical peaks detected. All detected emissions are below the -20 dBc criteria.			-20 dBc (peak) -30 dBc (average)		complies
			30 dBm		Operating frequency
-/-			-20 dBc (peak) -30 dBc (average)		-/-
Measurement uncertainty		± 3 dB			

Result: Passed

Plots: OFDM / a – mode

Plot 1: TX mode, lowest channel, up to 40 GHz

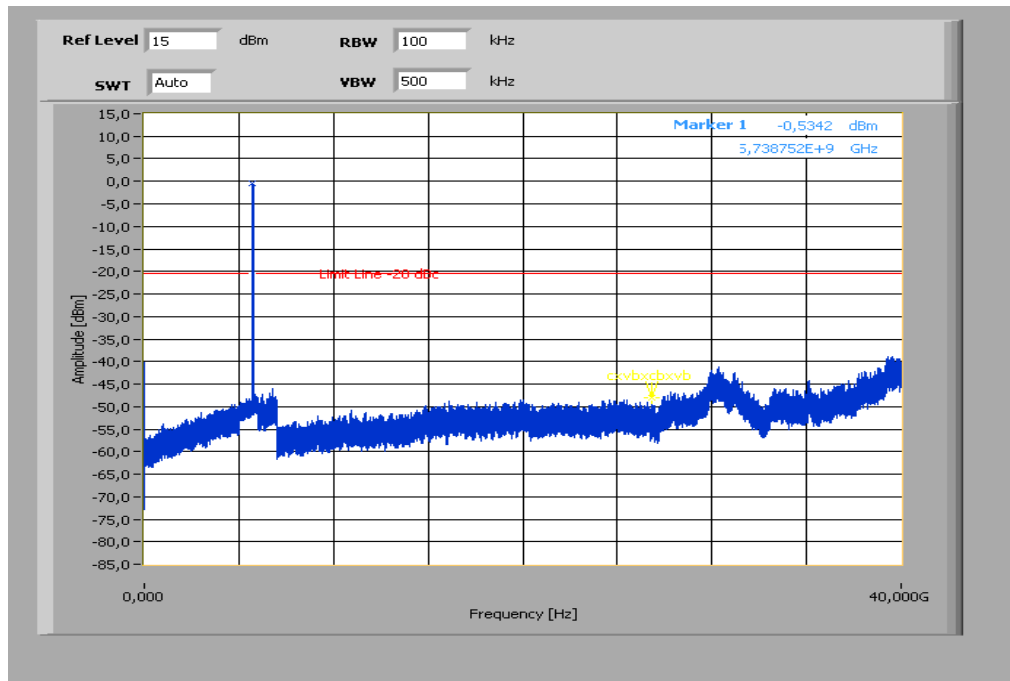

The peak at the beginning of the plot is the LO from the SA.

Plot 2: TX mode, middle channel, up to 40 GHz

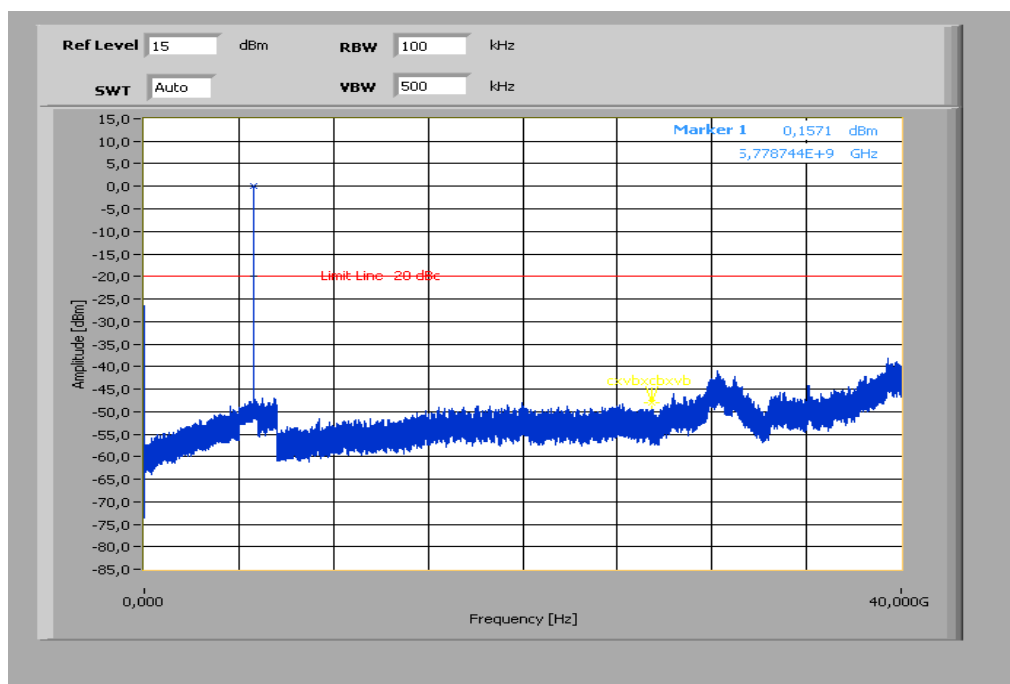

The peak at the beginning of the plot is the LO from the SA.

Plot 3: TX mode, highest channel, up to 40 GHz

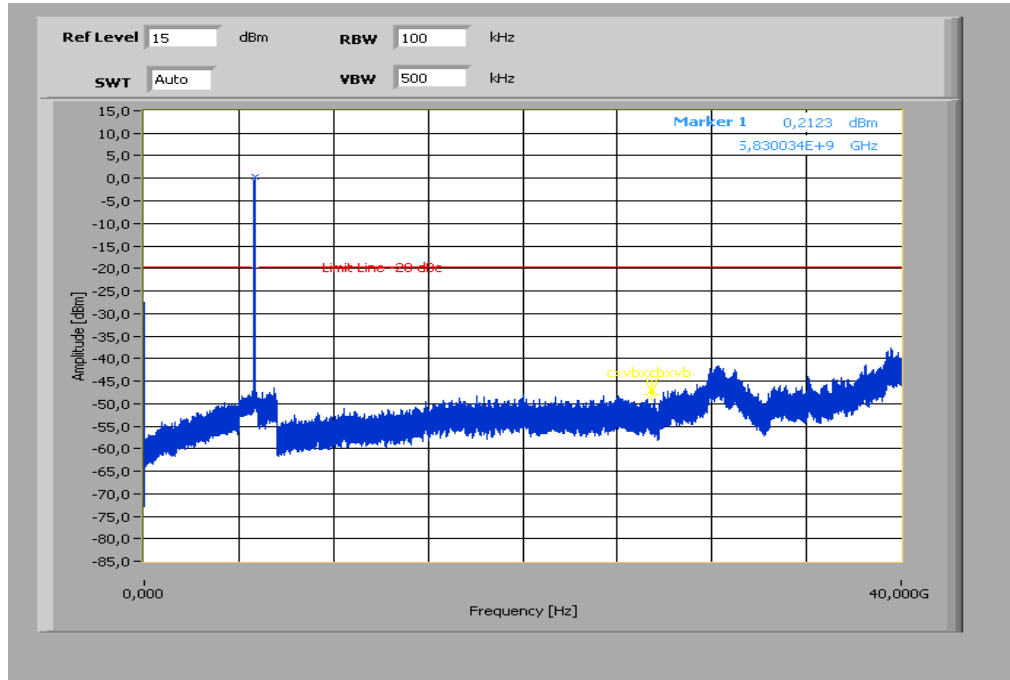

The peak at the beginning of the plot is the LO from the SA.

Plots: OFDM / n – mode HT20

Plot 1: TX mode, lowest channel, up to 40 GHz

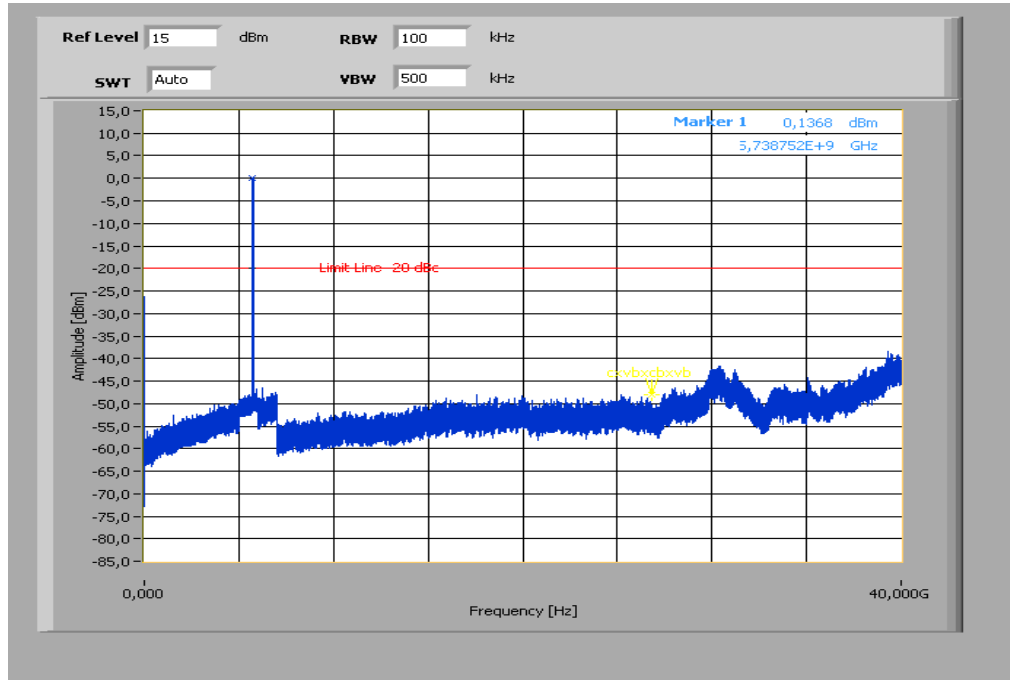

The peak at the beginning of the plot is the LO from the SA.

Plot 2: TX mode, middle channel, up to 40 GHz

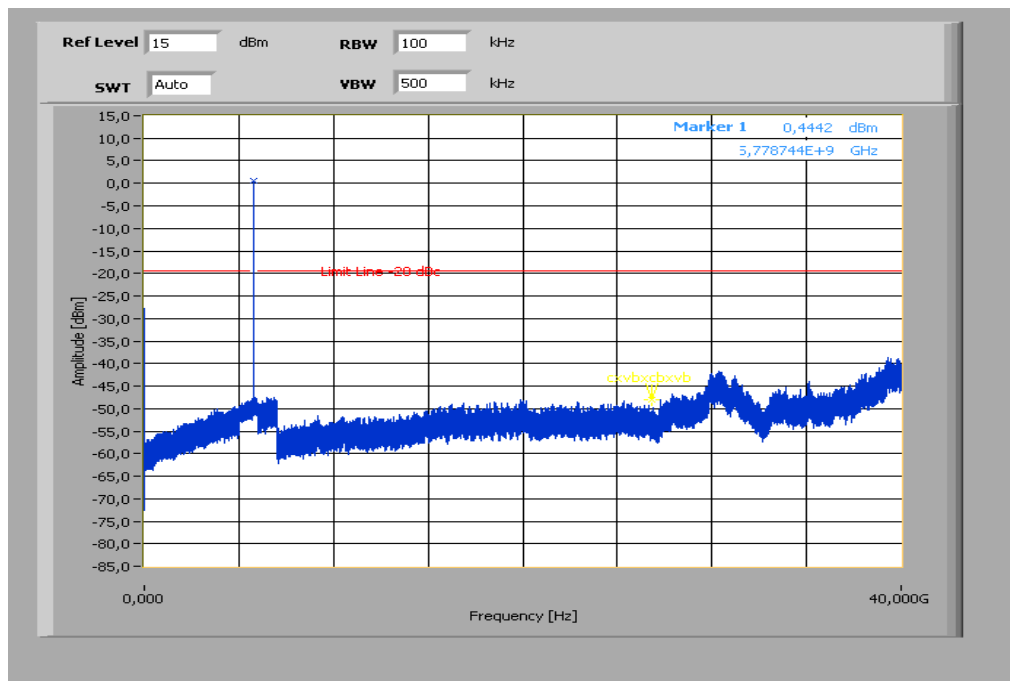

The peak at the beginning of the plot is the LO from the SA.

Plot 3: TX mode, highest channel, up to 40 GHz

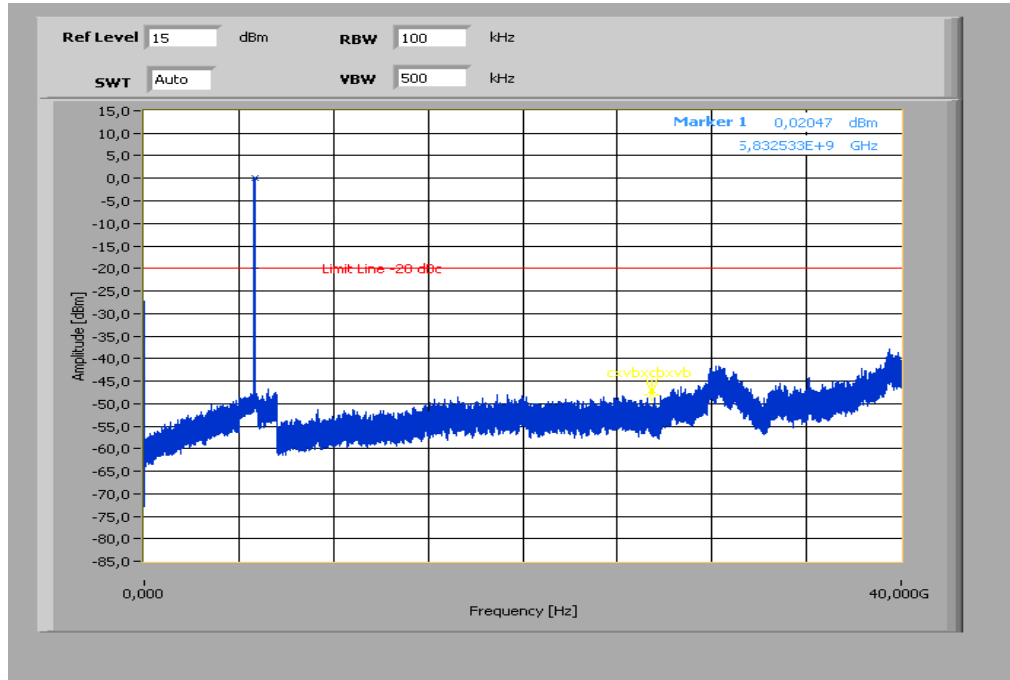

The peak at the beginning of the plot is the LO from the SA.

Plots: OFDM / n – mode HT40

Plot 1: TX mode, lowest channel, up to 40 GHz

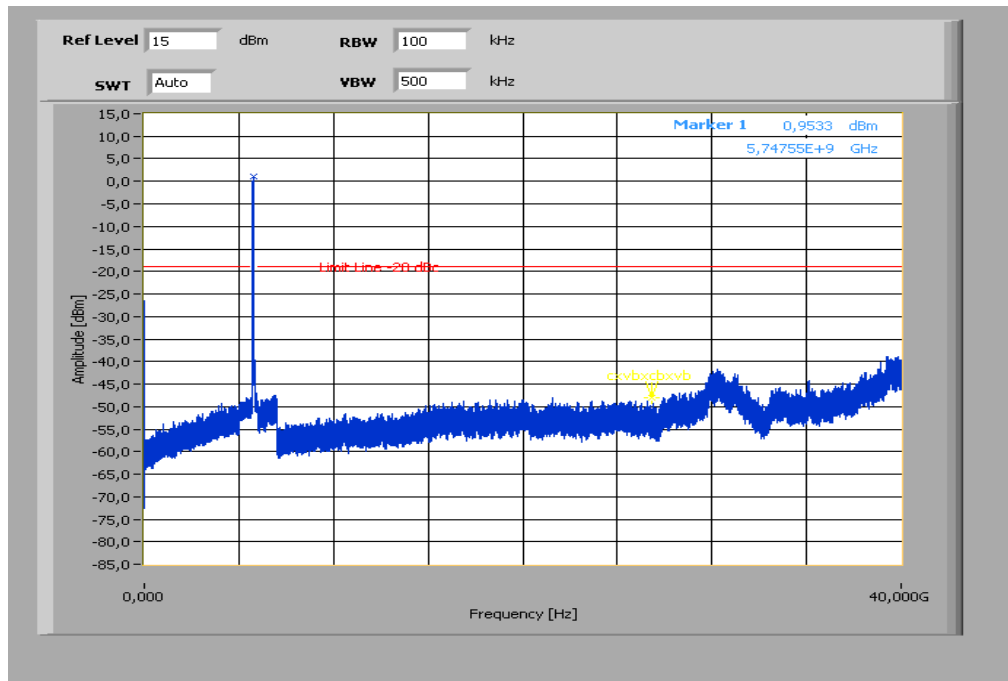

The peak at the beginning of the plot is the LO from the SA.

Plot 2: TX mode, highest channel, up to 40 GHz

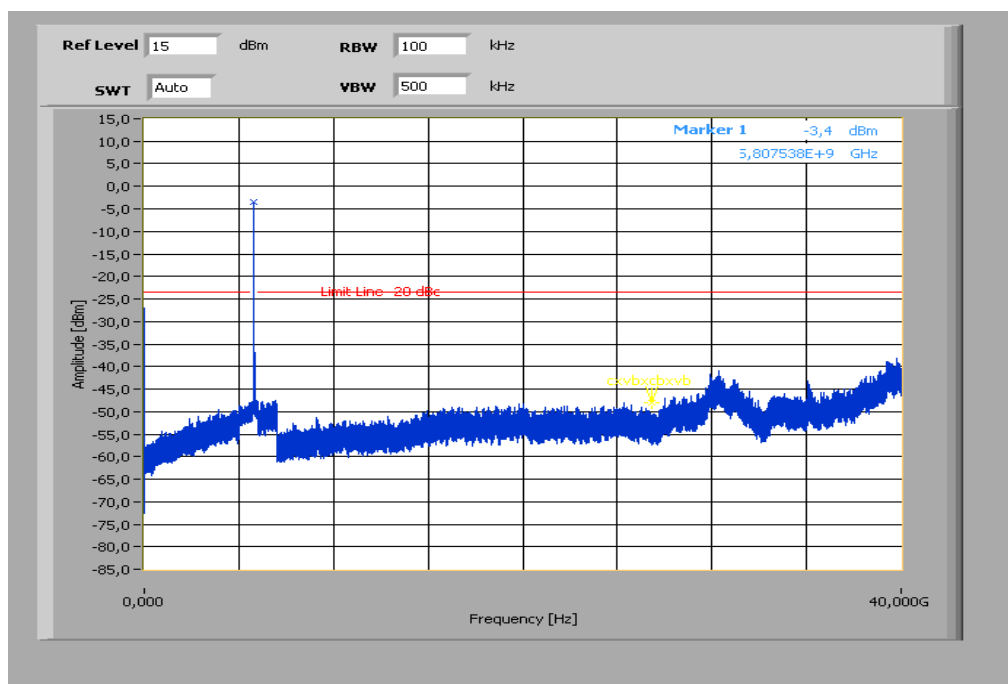

The peak at the beginning of the plot is the LO from the SA.

9.9 TX spurious emissions radiated

Description:

Measurement of the radiated spurious emissions in transmit mode. The measurement is performed at the lowest, middle and highest channel. The measurement is repeated for all modulations.

Measurement:

Measurement parameter	
Detector:	Peak / Quasi Peak / RMS
Sweep time:	Auto
Resolution bandwidth:	F > 1 GHz: 1 MHz F < 1 GHz: 100 kHz
Video bandwidth:	Sweep: 100 kHz Remeasurement: 10 Hz / 3 MHz
Span:	30 MHz to 40 GHz
Trace-Mode:	Max Hold
Measured Modulation	<input checked="" type="checkbox"/> OFDM a – mode <input checked="" type="checkbox"/> OFDM n – mode HT20 <input checked="" type="checkbox"/> OFDM n – mode HT40

The modulation with the highest output power was used to perform the transmitter spurious emissions. If spurious were detected a re-measurement was performed on the detected frequency with each modulation.

Limits:

FCC	IC	
TX Spurious Emissions Radiated		
In any 100 kHz bandwidth outside the frequency band in which the spread spectrum or digitally modulated intentional radiator is operating, the radio frequency power that is produced by the intentional radiator shall be at least 20 dB below that in the 100 kHz bandwidth within the band that contains the highest level of the desired power, based on either an RF conducted or a radiated measurement. Attenuation below the general limits specified in Section 15.209(a) is not required. In addition, radiated emissions which fall in the restricted bands, as defined in §15.205(a), must also comply with the radiated emission limits specified in §15.209(a) (see §15.205(c)).		
Frequency (MHz)	Field Strength (dBµV/m)	Measurement distance
30 - 88	30.0	10
88 – 216	33.5	10
216 – 960	36.0	10
Above 960	54.0	3

Results: OFDM / a – mode

TX Spurious Emissions Radiated [dBµV/m]								
OFDM / a – mode								
5745 MHz			5785 MHz			5825 MHz		
F [MHz]	Detector	Level [dBµV/m]	F [MHz]	Detector	Level [dBµV/m]	F [MHz]	Detector	Level [dBµV/m]
For emissions below 1 GHz, please take a look at the table below the 1 GHz plot.			For emissions below 1 GHz, please take a look at the table below the 1 GHz plot.			For emissions below 1 GHz, please take a look at the table below the 1 GHz plot.		
No critical emissions detected above 1 GHz, please take a look at the plots.			No critical emissions detected above 1 GHz, please take a look at the plots.			No critical emissions detected above 1 GHz, please take a look at the plots.		
Measurement uncertainty			± 3 dB					

Result: Passed

Results: OFDM / n – mode HT20

TX Spurious Emissions Radiated [dBµV/m]								
OFDM / n – mode HT20								
5745 MHz			5785 MHz			5825 MHz		
F [MHz]	Detector	Level [dBµV/m]	F [MHz]	Detector	Level [dBµV/m]	F [MHz]	Detector	Level [dBµV/m]
For emissions below 1 GHz, please take a look at the table below the 1 GHz plot.			For emissions below 1 GHz, please take a look at the table below the 1 GHz plot.			For emissions below 1 GHz, please take a look at the table below the 1 GHz plot.		
No critical emissions detected above 1 GHz, please take a look at the plots.			No critical emissions detected above 1 GHz, please take a look at the plots.			No critical emissions detected above 1 GHz, please take a look at the plots.		
Measurement uncertainty			± 3 dB					

Result: Passed

Results: OFDM / n – mode HT40

TX Spurious Emissions Radiated [dBµV/m]								
OFDM / n – mode HT40								
5755 MHz			5795 MHz			-/-		
F [MHz]	Detector	Level [dBµV/m]	F [MHz]	Detector	Level [dBµV/m]	F [MHz]	Detector	Level [dBµV/m]
For emissions below 1 GHz, please take a look at the table below the 1 GHz plot.			For emissions below 1 GHz, please take a look at the table below the 1 GHz plot.			-/-		
No critical emissions detected above 1 GHz, please take a look at the plots.			No critical emissions detected above 1 GHz, please take a look at the plots.			-/-		
Measurement uncertainty			± 3 dB					

Result: Passed

Note: Results of OFDM n – mode are added to show the compliance with the standard.

Plots: OFDM / n – mode HT20

Plot 1: Lowest channel, 30 MHz to 1 GHz, vertical & horizontal polarization

Common Information

EUT: PM-0240-BV
 Serial Number: CB5121SWEK
 Test Description: FCC part 15 C class B @ 10 m
 Operating Conditions: W-Lan n-mode HT20, mcs0, CH 149 + charging
 Operator Name: Medrow
 Comment: AC: 115 V / 60 Hz

Scan Setup: STAN_Fin [EMI radiated]

Hardware Setup: Electric Field (NOS)

Receiver:

Level Unit: dBµV/m

Subrange	Step Size	Detectors	IF BW	Meas. Time	Preamp
30 MHz - 2 GHz	60 kHz	QPK	120 kHz	1 s	20 dB

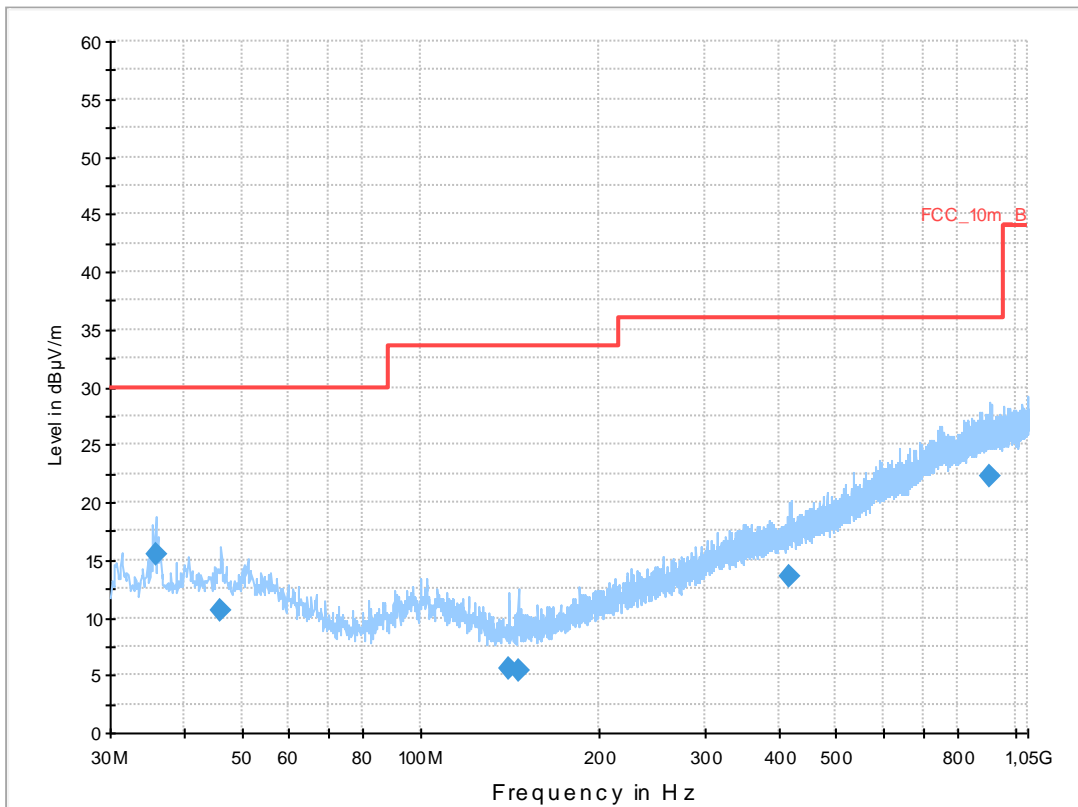

Final Result 1

Frequency (MHz)	QuasiPeak (dBµV/m)	Meas. Time (ms)	Bandwidth (kHz)	Height (cm)	Polarization	Azimuth (deg)	Corr. (dB)	Margin (dB)	Limit (dBµV/m)	Comment
35.760000	15.4	1000.0	120.000	250.0	V	114.0	13.1	14.6	30.0	
46.080000	10.6	1000.0	120.000	226.0	V	290.0	13.3	19.4	30.0	
140.400000	5.6	1000.0	120.000	270.0	V	305.0	8.7	27.9	33.5	
145.680000	5.3	1000.0	120.000	270.0	V	88.0	8.8	28.2	33.5	
418.200000	13.6	1000.0	120.000	270.0	H	188.0	17.2	22.4	36.0	
902.760000	22.3	1000.0	120.000	270.0	H	114.0	25.2	13.7	36.0	

Plot 2: Lowest channel, 1 GHz to 12.75 GHz, vertical & horizontal polarization

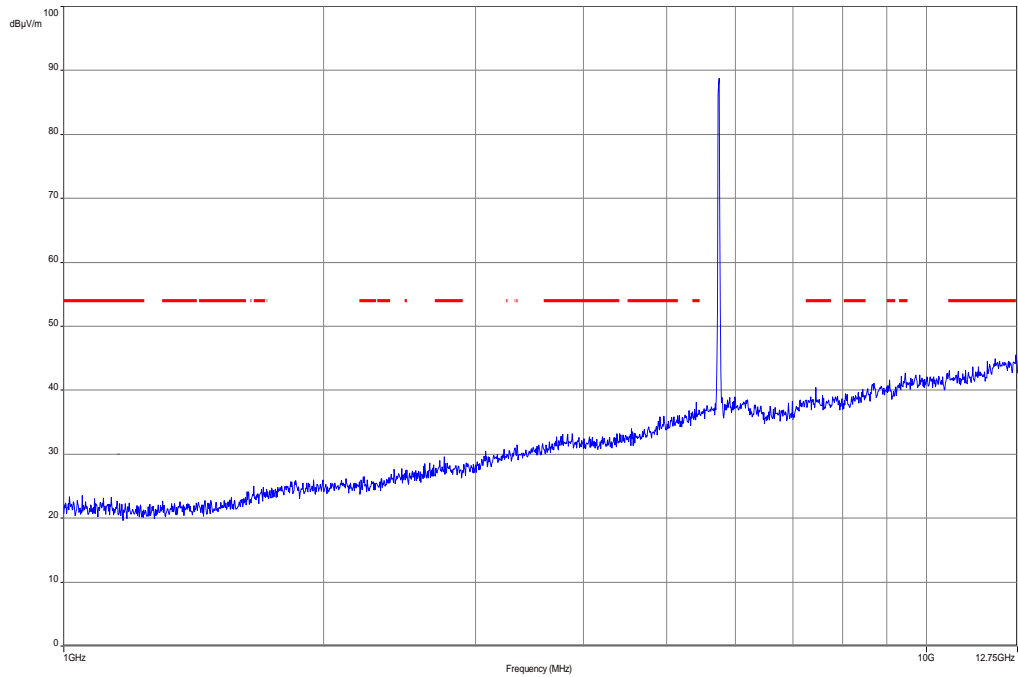

Plot 3: Lowest channel, 12.75 GHz to 18 GHz, vertical & horizontal polarization

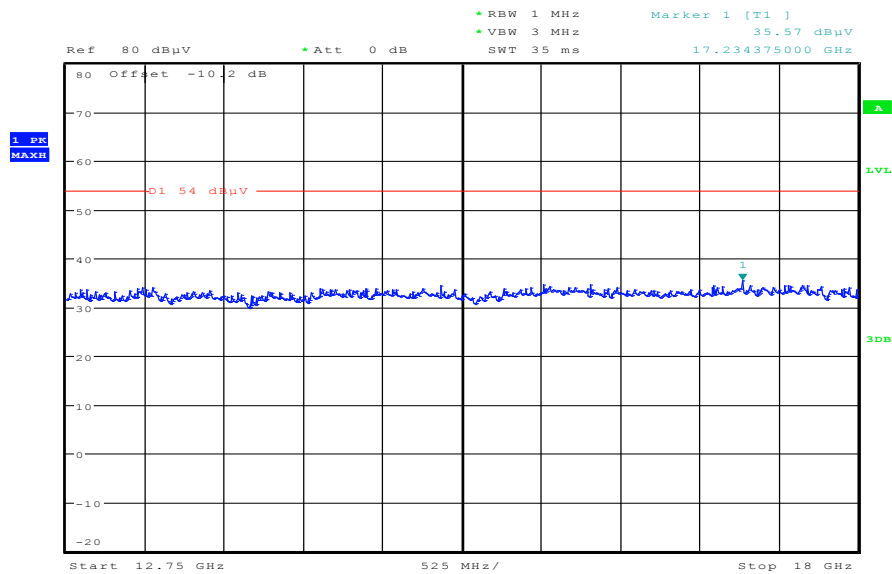

Date: 10.JAN.2013 11:26:12

Plot 4: Lowest channel, 18 GHz to 26 GHz, vertical & horizontal polarization

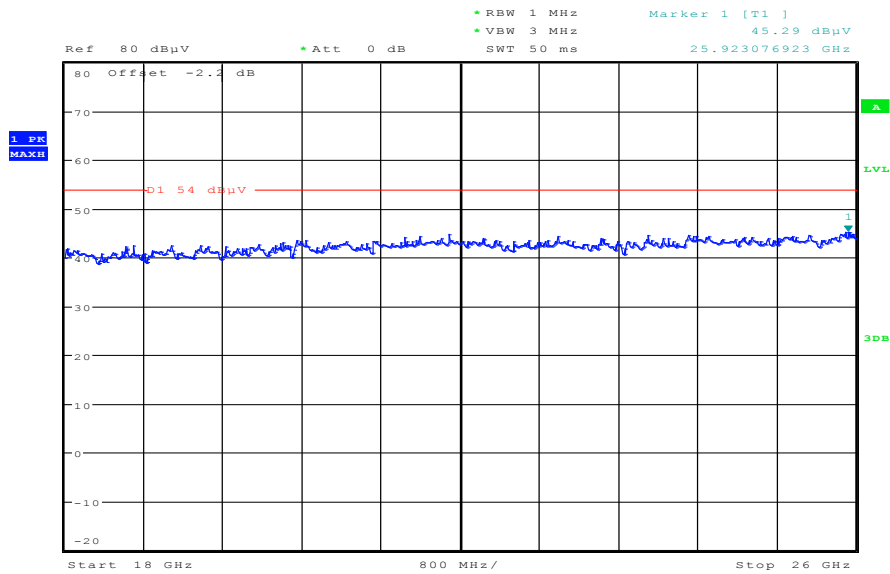

Date: 10.JAN.2013 11:36:43

Plot 5: Lowest channel, 26 GHz to 40 GHz, vertical & horizontal polarization

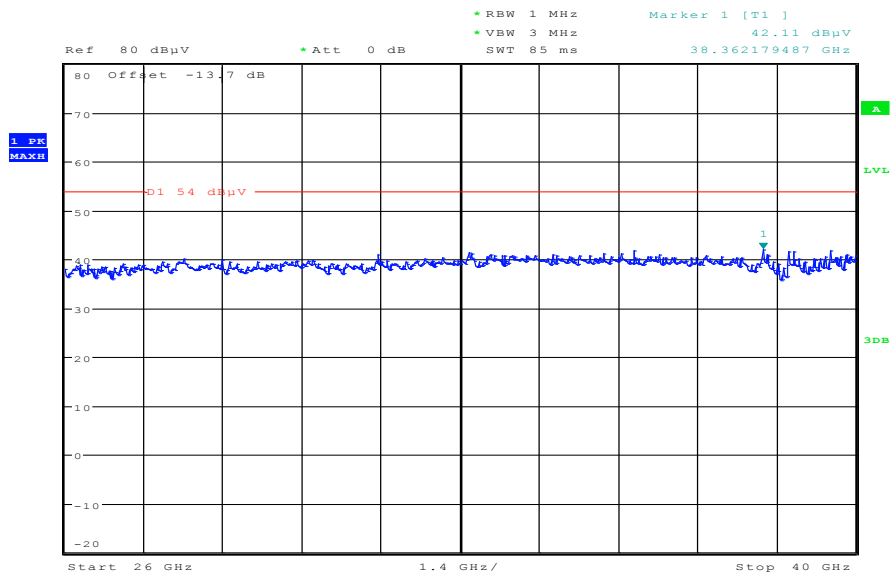

Date: 10.JAN.2013 11:52:15

Plot 6: Middle channel, 30 MHz to 1 GHz, vertical & horizontal polarization

Common Information

EUT: PM-0240-BV
 Serial Number: CB5121SWEK
 Test Description: FCC part 15 C class B @ 10m
 Operating Conditions: W-Lan n-mode HT20, mcs0, CH 157 + charging
 Operator Name: Medrow
 Comment: AC: 115 V / 60 Hz

Scan Setup: STAN_Fin [EMI radiated]

Hardware Setup: Electric Field (NOS)
 Receiver: [ESCI 3]
 Level Unit: dB μ V/m

Subrange	Step Size	Detectors	IF BW	Meas. Time	Preamp
30 MHz - 1 GHz	60 kHz	QPK	120 kHz	15 s	20 dB

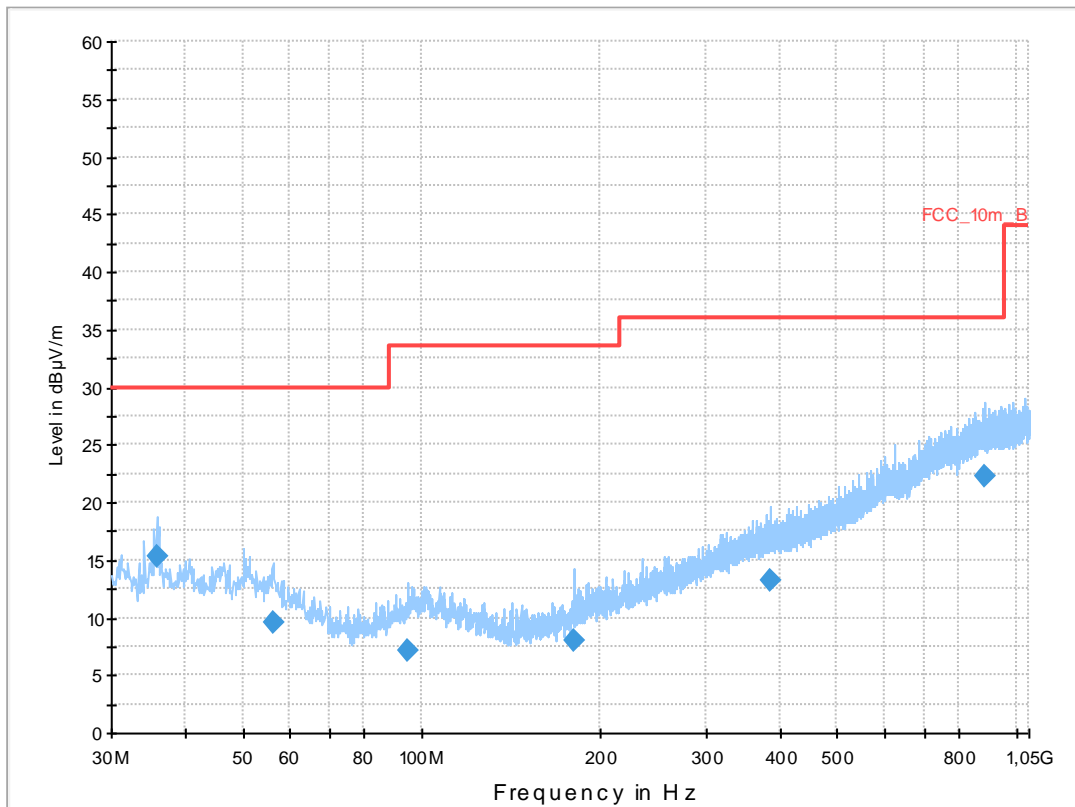

Final Result 1

Frequency (MHz)	Quasi Peak (dB μ V/m)	Meas. Time (ms)	Bandwidth (kHz)	Height (cm)	Polarization	Azimuth (deg)	Corr. (dB)	Margin (dB)	Limit (dB μ V/m)	Comment
35.760000	15.3	1000.0	120.00	270.0	V	246.0	13.1	14.7	30.0	
56.160000	9.5	1000.0	120.00	147.0	V	0.0	12.6	20.5	30.0	
94.560000	7.1	1000.0	120.00	198.0	V	0.0	11.2	26.4	33.5	
180.000000	7.9	1000.0	120.00	105.0	V	0.0	10.4	25.6	33.5	
386.280000	13.1	1000.0	120.00	98.0	H	329.0	16.7	22.9	36.0	
882.720000	22.2	1000.0	120.00	98.0	H	66.0	25.0	13.8	36.0	

Plot 7: Middle channel, 1 GHz to 12.75 GHz, vertical & horizontal polarization

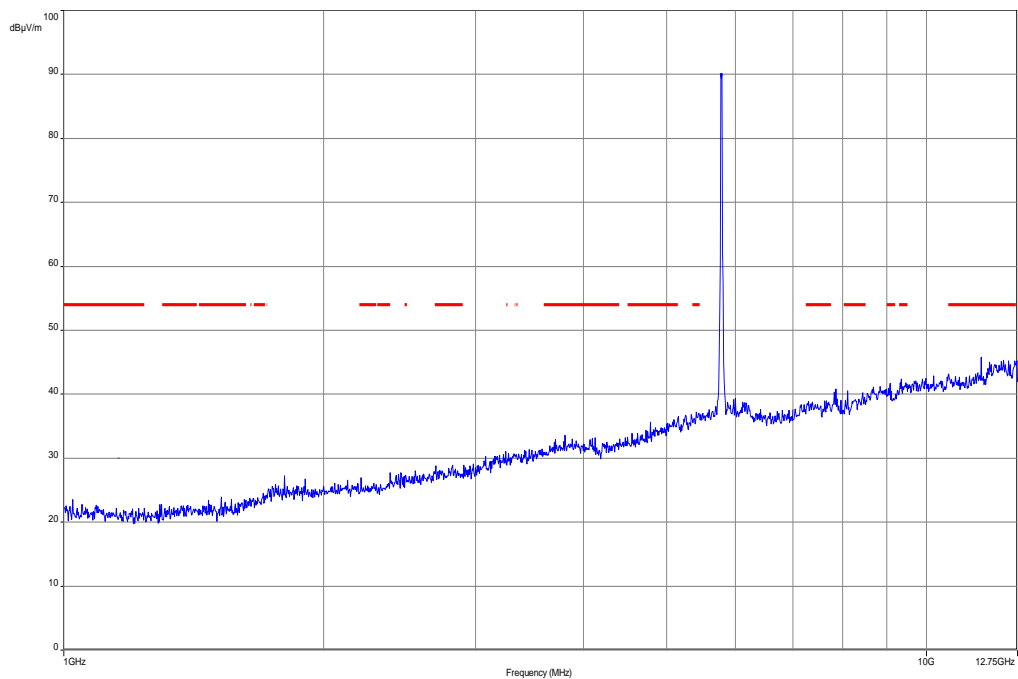

Plot 8: Middle channel, 12.75 GHz to 18 GHz, vertical & horizontal polarization

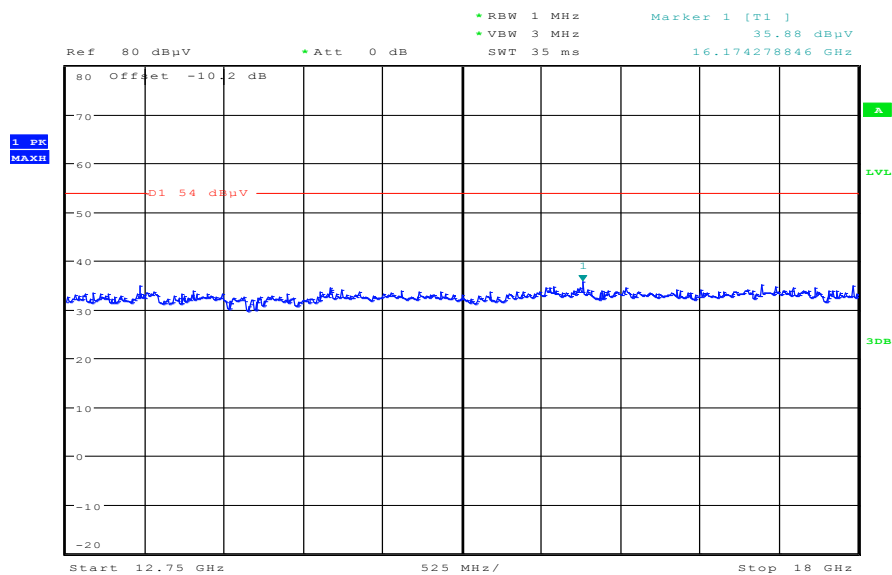

Date: 10.JAN.2013 11:27:14

Plot 9: Middle channel, 18 GHz to 26 GHz, vertical & horizontal polarization

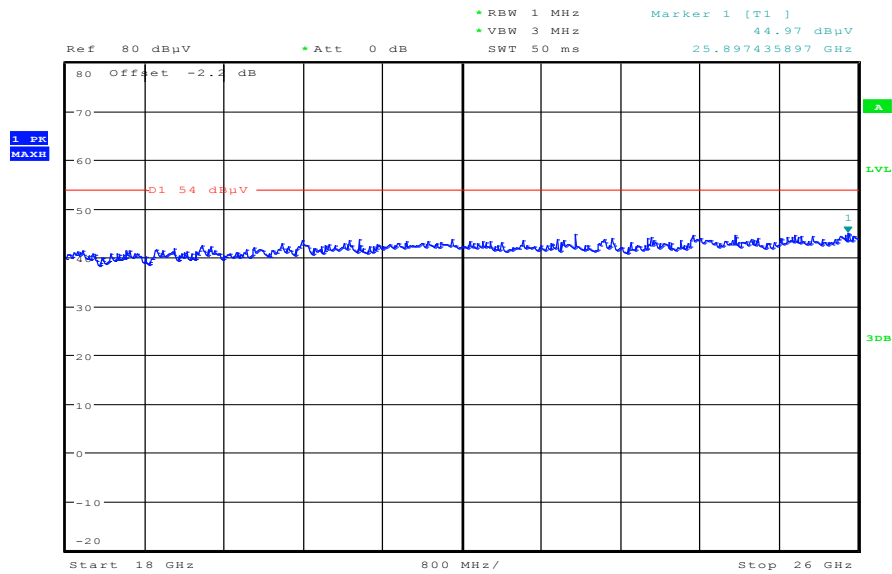

Date: 10.JAN.2013 11:37:29

Plot 10: Middle channel, 26 GHz to 40 GHz, vertical & horizontal polarization

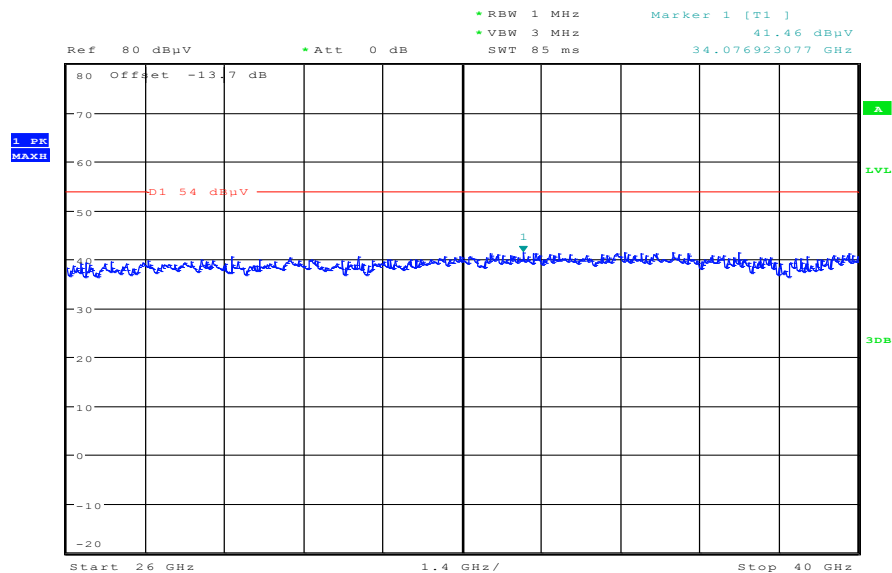

Date: 10.JAN.2013 11:51:17

Plot 11: Highest channel, 30 MHz to 1 GHz, vertical & horizontal polarization

Common Information

EUT: PM-0240-BV
 Serial Number: CB5121SWEK
 Test Description: FCC part 15 C class B @ 10 m
 Operating Conditions: W-Lan n-mode HT20, mcs0, CH 165 + charging
 Operator Name: Medrow
 Comment: AC 115V/60Hz

Scan Setup: STAN_Fin [EMI radiated]

Hardware Setup: Electric Field (NOS)
 Receiver: [ESCI 3]
 Level Unit: dBµV/m

Subrange	Step Size	Detectors	IF BW	Meas. Time	Preamp
30 MHz - 2 GHz	60 kHz	QPK	120 kHz	1 s	20 dB

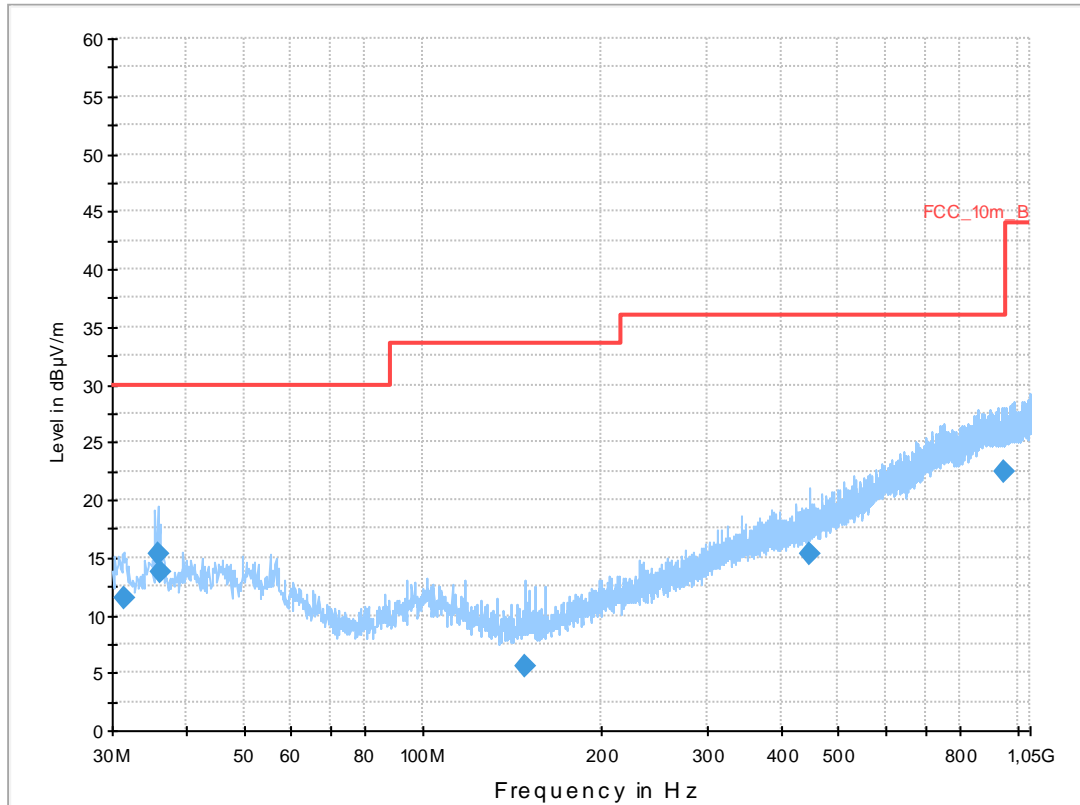

Final Result 1

Frequency (MHz)	QuasiPeak (dBµV/m)	Meas. Time (ms)	Bandwidth (kHz)	Height (cm)	Polarization	Azimuth (deg)	Corr. (dB)	Margin (dB)	Limit (dBµV/m)	Comment
31.320000	11.4	1000.0	120.000	109.0	V	261.0	12.6	18.6	30.0	
35.760000	15.2	1000.0	120.000	270.0	V	345.0	13.1	14.8	30.0	
36.120000	13.7	1000.0	120.000	253.0	V	199.0	13.1	16.3	30.0	
148.080000	5.5	1000.0	120.000	112.0	V	93.0	8.9	28.0	33.5	
447.960000	15.4	1000.0	120.000	98.0	V	53.0	17.6	20.6	36.0	
947.520000	22.4	1000.0	120.000	270.0	H	160.0	25.3	13.6	36.0	

Plot 12: Highest channel, 1 GHz to 12.75 GHz, vertical & horizontal polarization

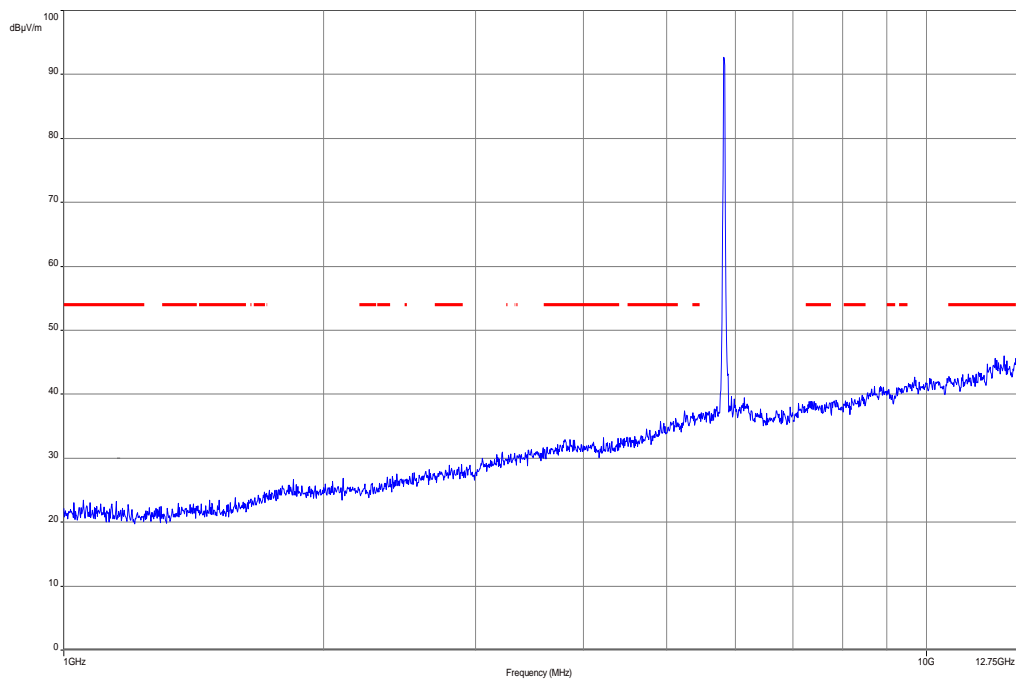

Plot 13: Highest channel, 12.75 GHz to 18 GHz, vertical & horizontal polarization

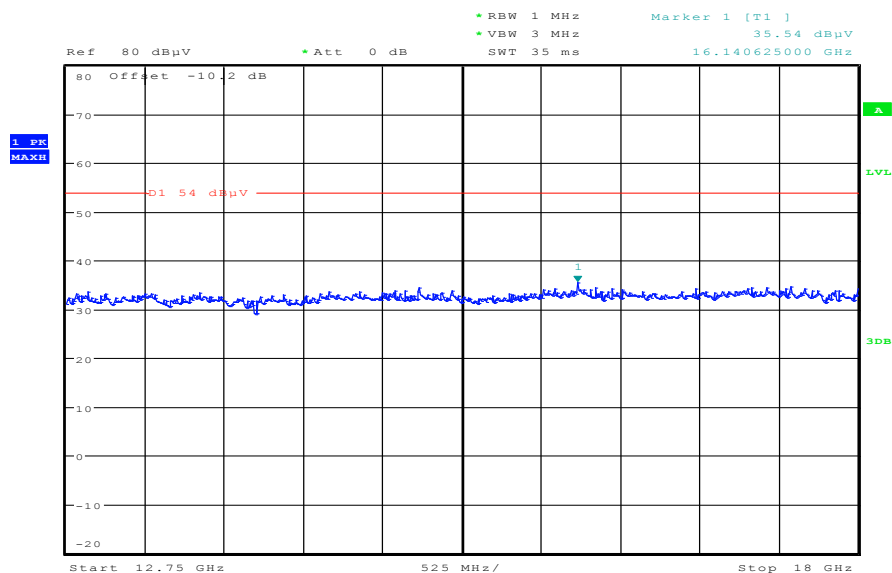

Date: 10.JAN.2013 11:28:11

Plot 14: Highest channel, 18 GHz to 26 GHz, vertical & horizontal polarization

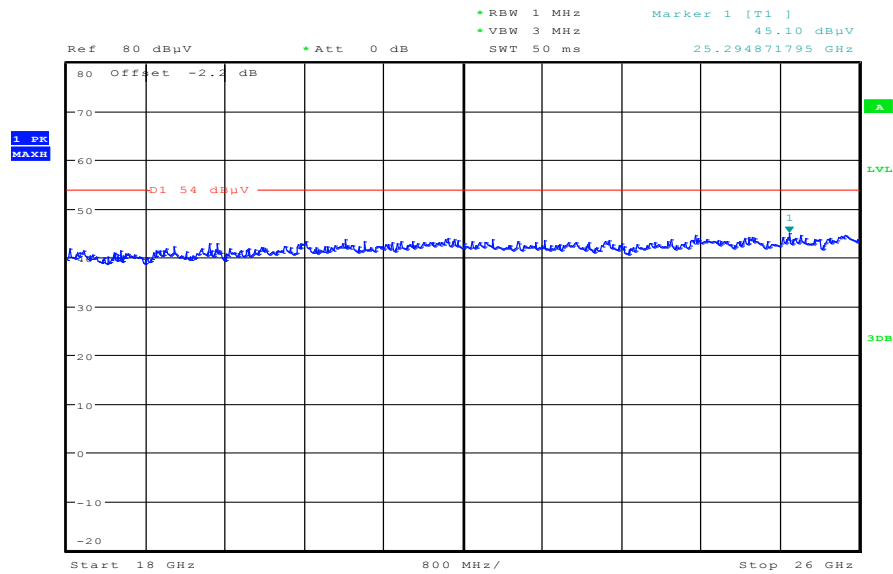

Date: 10.JAN.2013 11:38:13

Plot 15: Highest channel, 26 GHz to 40 GHz, vertical & horizontal polarization

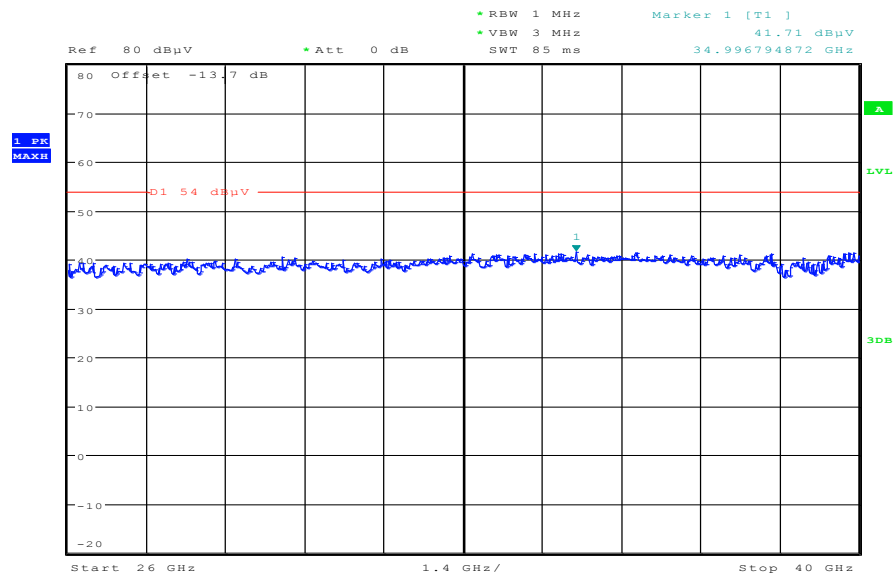

Date: 10.JAN.2013 11:50:30

Plots: OFDM / n – mode HT40

Plot 1: Lowest channel, 30 MHz to 1 GHz, vertical & horizontal polarization

Common Information

EUT: PM-0240-BV
 Serial Number: CB5121SWEK
 Test Description: FCC part 15 C class B @ 10 m
 Operating Conditions: W-Lan n-mode HT40, mcs0, CH 151 + charging
 Operator Name: Medrow
 Comment: AC 115V/60Hz

Scan Setup: STAN_Fin [EMI radiated]

Hardware Setup: Electric Field (NOS)
 Receiver: [ESCI 3]
 Level Unit: dBµV/m

Subrange	Step Size	Detectors	IF BW	Meas. Time	Preamp
30 MHz - 2 GHz	60 kHz	QPK	120 kHz	1 s	20 dB

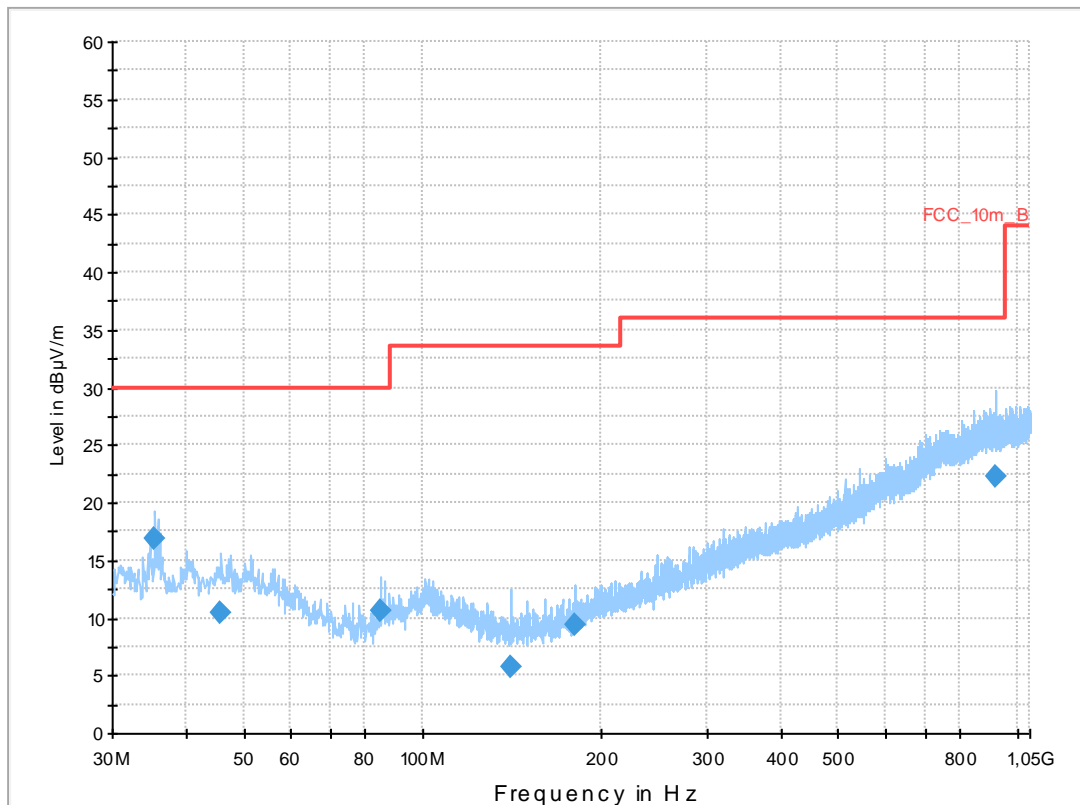

Final Result 1

Frequency (MHz)	QuasiPeak (dBµV/m)	Meas. Time (ms)	Bandwidth (kHz)	Height (cm)	Polarization	Azimuth (deg)	Corr. (dB)	Margin (dB)	Limit (dBµV/m)	Comment
35.400000	16.9	1000.0	120.000	111.0	V	290.0	13.1	13.1	30.0	
45.720000	10.5	1000.0	120.000	172.0	V	191.0	13.3	19.5	30.0	
84.720000	10.7	1000.0	120.000	189.0	V	20.0	9.8	19.3	30.0	
140.400000	5.7	1000.0	120.000	210.0	V	173.0	8.7	27.8	33.5	
180.000000	9.5	1000.0	120.000	98.0	V	345.0	10.4	24.0	33.5	
918.600000	22.3	1000.0	120.000	176.0	H	183.0	25.3	13.7	36.0	

Plot 2: Lowest channel, 1 GHz to 12.75 GHz, vertical & horizontal polarization

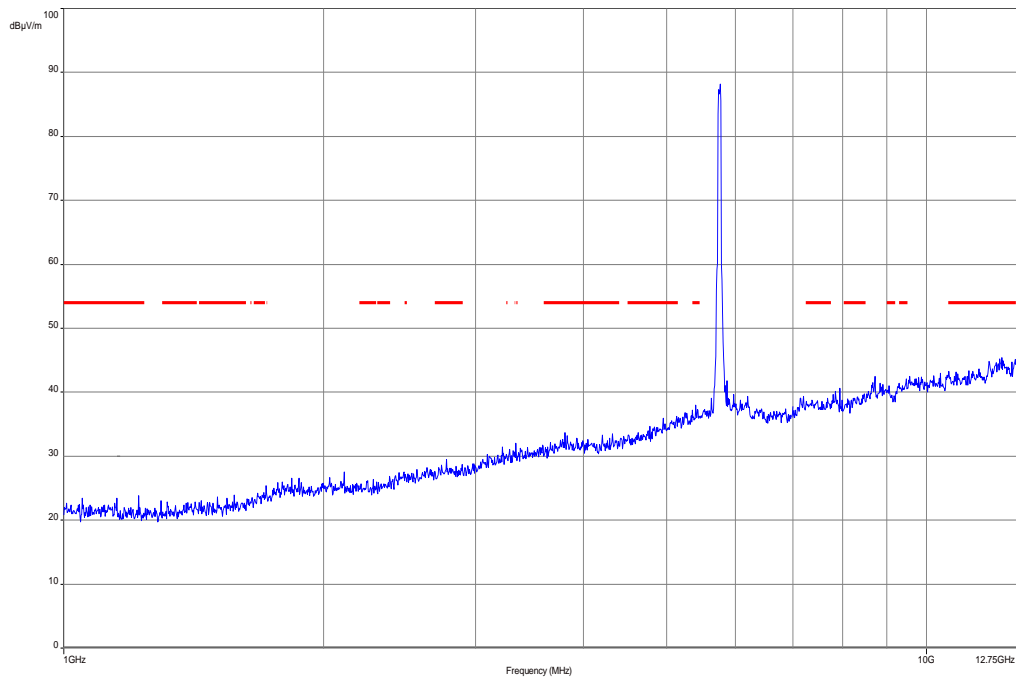

Plot 3: Lowest channel, 12.75 GHz to 18 GHz, vertical & horizontal polarization

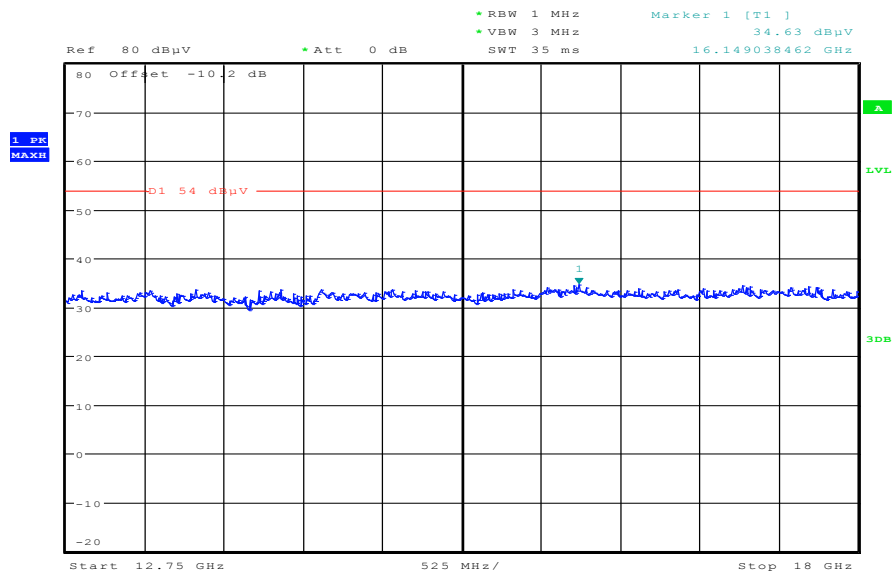

Date: 10.JAN.2013 11:29:43

Plot 4: Lowest channel, 18 GHz to 26 GHz, vertical & horizontal polarization

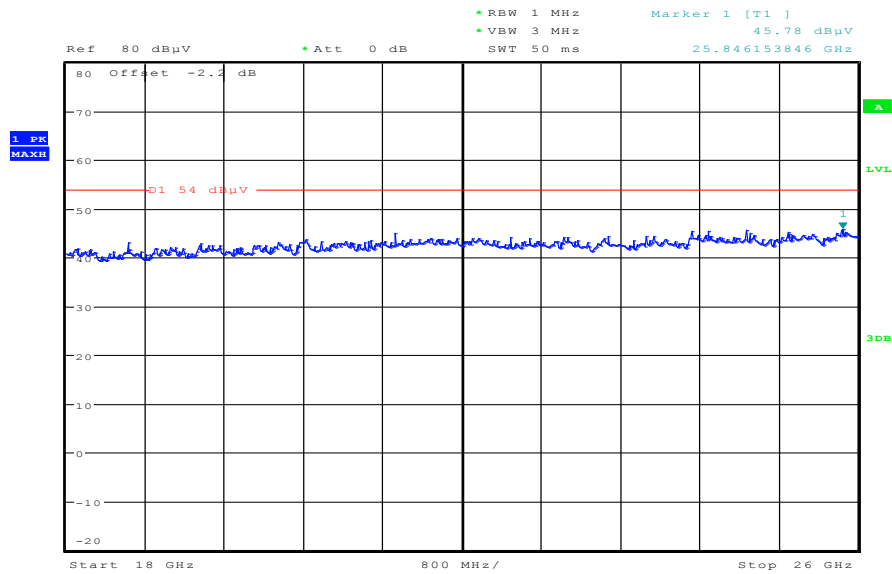

Date: 10.JAN.2013 11:33:27

Plot 5: Lowest channel, 26 GHz to 40 GHz, vertical & horizontal polarization

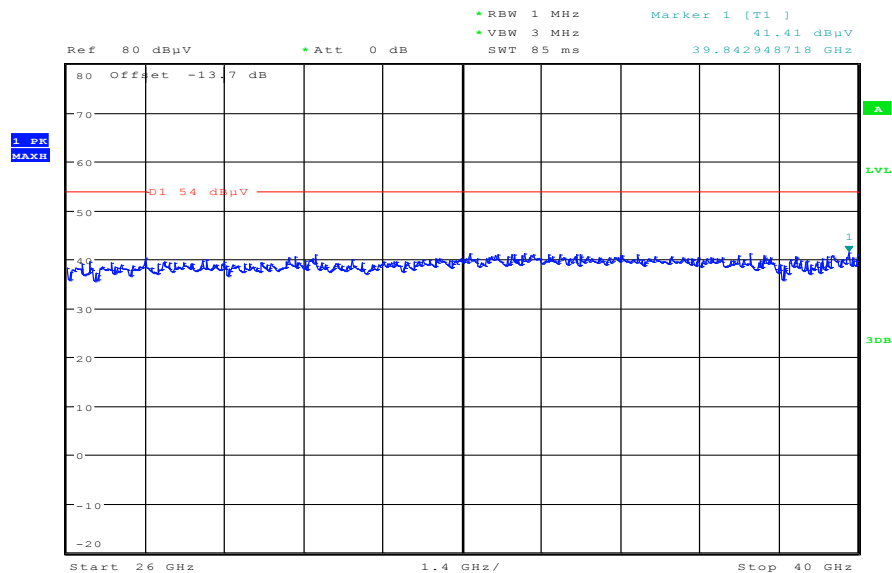

Date: 10.JAN.2013 11:53:21

Plot 6: Highest channel, 30 MHz to 1 GHz, vertical & horizontal polarization

Common Information

EUT: PM-0240-BV
 Serial Number: CB5121SWEK
 Test Description: FCC part 15 C class B @ 10 m
 Operating Conditions: W-Lan n-mode HT40, mcs0, CH 159 + charging
 Operator Name: Medrow
 Comment: AC 115V/60Hz

Scan Setup: STAN_Fin [EMI radiated]

Hardware Setup: Electric Field (NOS)
 Receiver: [ESCI 3]
 Level Unit: dB μ V/m

Subrange	Step Size	Detectors	IF BW	Meas. Time	Preamp
30 MHz - 2 GHz	60 kHz	QPK	120 kHz	1 s	20 dB

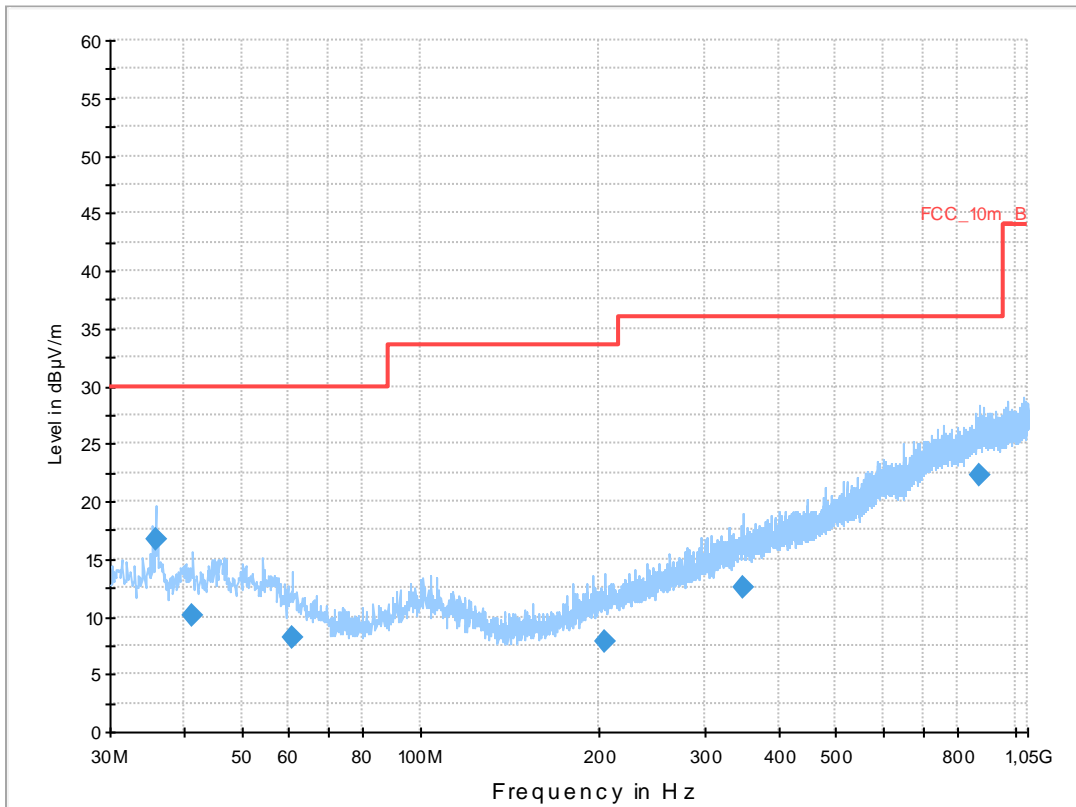

Final Result 1

Frequency (MHz)	QuasiPeak (dB μ V/m)	Meas. Time (ms)	Bandwidth (kHz)	Height (cm)	Polarization	Azimuth (deg)	Corr. (dB)	Margin (dB)	Limit (dB μ V/m)	Comment
35.760000	16.7	1000.0	120.000	170.0	V	159.0	13.1	13.3	30.0	
41.400000	10.1	1000.0	120.000	241.0	V	0.0	13.4	19.9	30.0	
60.720000	8.2	1000.0	120.000	239.0	H	286.0	11.4	21.8	30.0	
203.640000	7.8	1000.0	120.000	199.0	H	311.0	11.8	25.7	33.5	
349.200000	12.6	1000.0	120.000	270.0	V	0.0	16.0	23.4	36.0	
873.360000	22.2	1000.0	120.000	270.0	V	232.0	24.9	13.8	36.0	

Plot 7: Highest channel, 1 GHz to 12.75 GHz, vertical & horizontal polarization

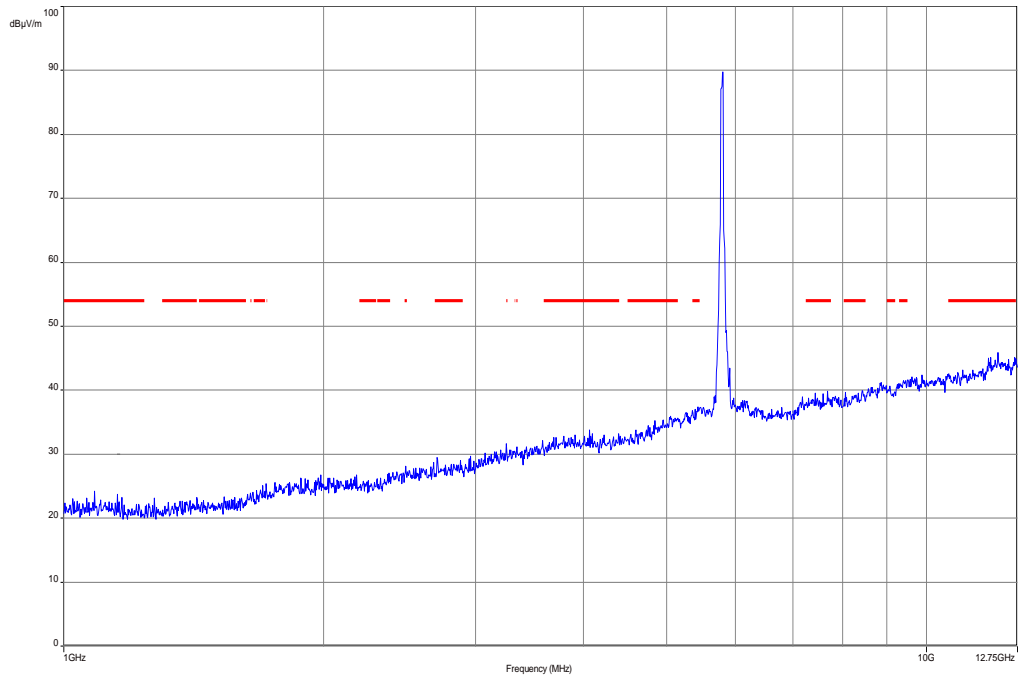

Plot 8: Highest channel, 12.75 GHz to 18 GHz, vertical & horizontal polarization

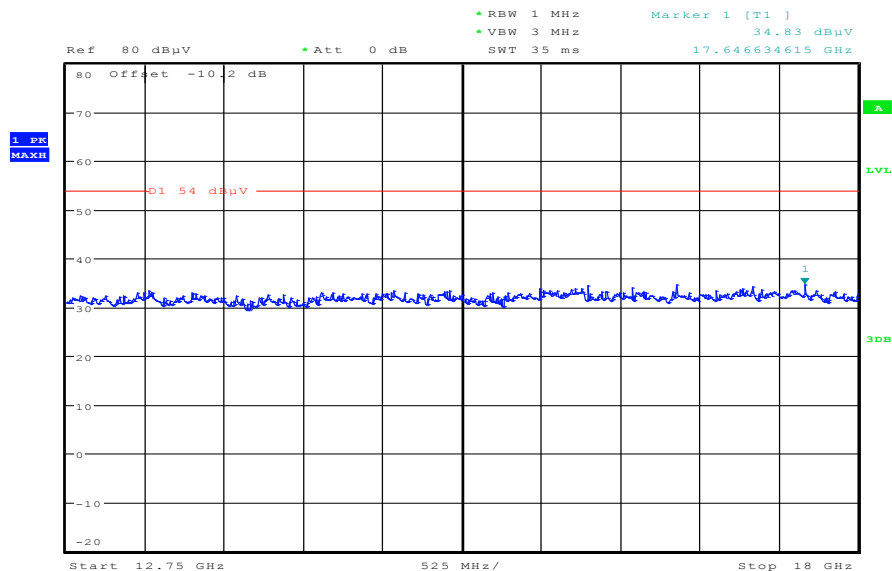

Date: 10.JAN.2013 11:29:57

Plot 9: Highest channel, 18 GHz to 26 GHz, vertical & horizontal polarization

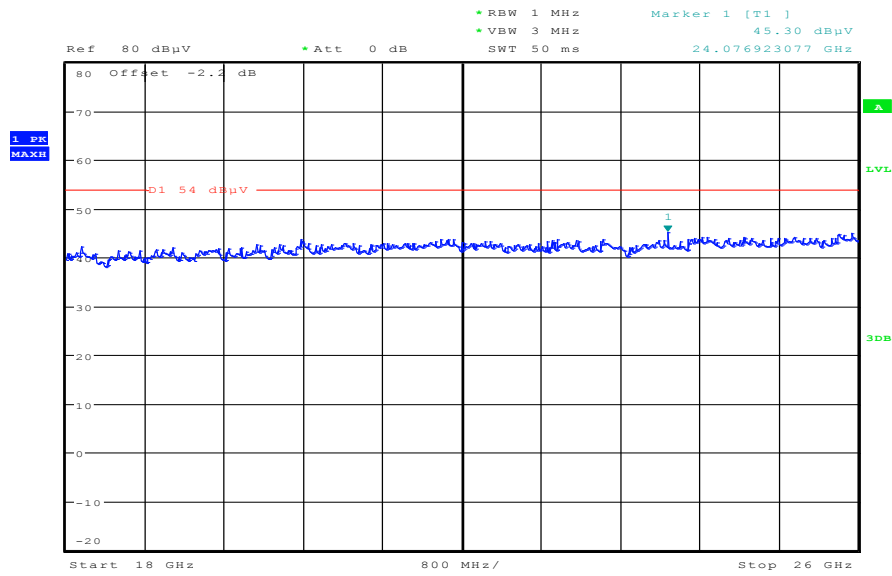

Date: 10.JAN.2013 11:34:10

Plot 10: Highest channel, 26 GHz to 40 GHz, vertical & horizontal polarization

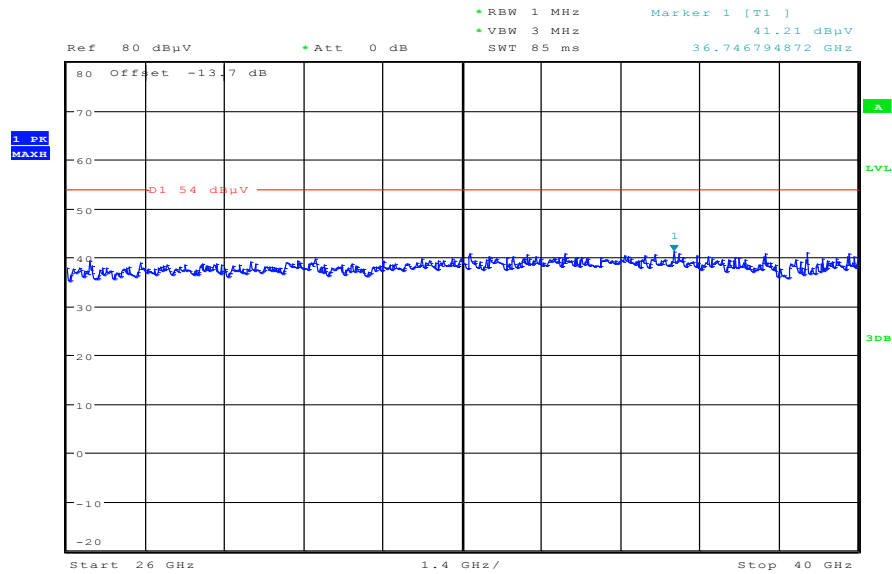

Date: 10.JAN.2013 11:53:31

9.10 RX spurious emissions radiated

Description:

Measurement of the radiated spurious emissions in idle/receive mode. The results are valid for both modes.

Measurement:

Measurement parameter	
Detector:	Peak / Quasi Peak / RMS
Sweep time:	Auto
Resolution bandwidth:	F > 1 GHz: 1 MHz F < 1 GHz: 100 kHz
Video bandwidth:	Sweep: 100 kHz Remeasurement: 10 Hz / 3 MHz
Span:	30 MHz to 25 GHz
Trace-Mode:	Max Hold

Limits:

FCC		IC
RX Spurious Emissions Radiated		
Frequency (MHz)	Field Strength (dBµV/m)	Measurement distance
30 - 88	30.0	10
88 – 216	33.5	10
216 – 960	36.0	10
Above 960	54.0	3

Results:

RX Spurious Emissions Radiated [dBµV/m]		
F [MHz]	Detector	Level [dBµV/m]
For emissions below 1 GHz, please take a look at the table below the 1 GHz plot.		
No emissions detected above 1 GHz.		
Measurement uncertainty	± 3 dB	

Result: Passed.

Plots: RX / Idle – mode

Plot 1: 30 MHz to 1 GHz, vertical & horizontal polarization

Common Information

EUT: PM-0240-BV
 Serial Number: CB5121SWDK
 Test Description: FCC part 15 class B @ 10 m
 Operating Conditions: W-Lan, IDLE + charging
 Operator Name: Medrow
 Comment: AC: 115 V / 60 Hz

Scan Setup: STAN_Fin [EMI radiated]

Hardware Setup: Electric Field (NOS)
 Receiver: [ESCI 3]
 Level Unit: dBµV/m

Subrange	Step Size	Detectors	IF BW	Meas. Time	Preamp
30 MHz - 2 GHz	60 kHz	QPK	120 kHz	1 s	20 dB

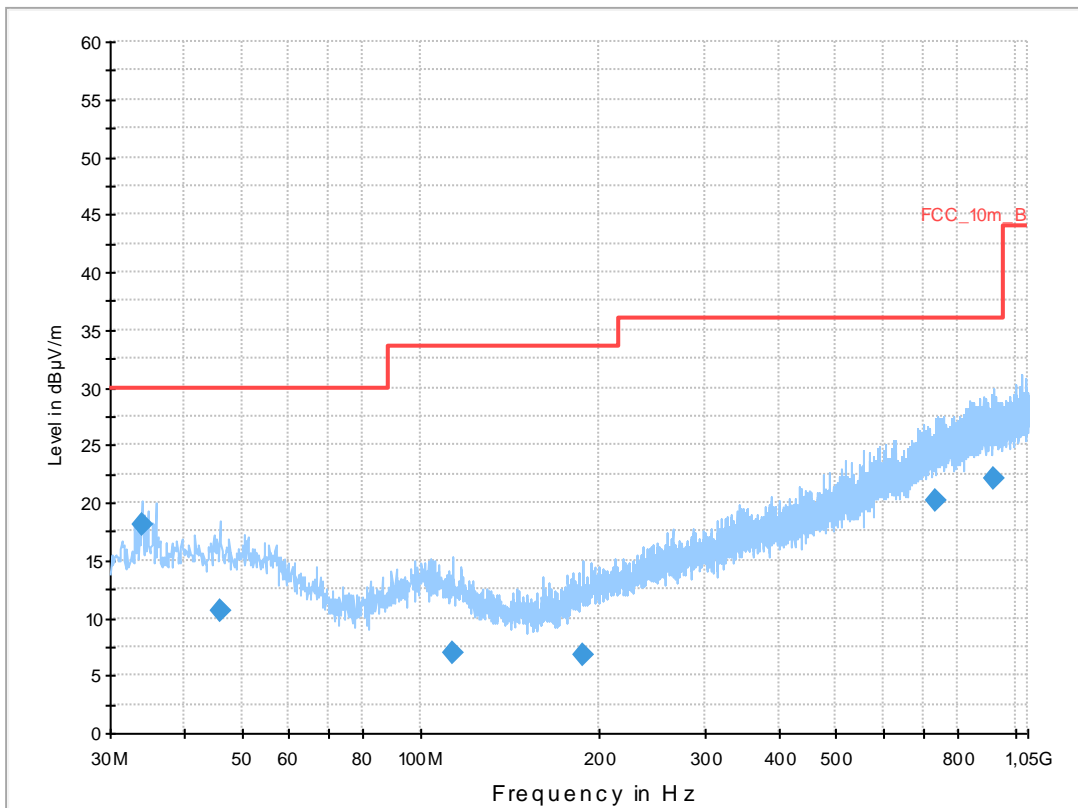

Final Result 1

Frequency (MHz)	QuasiPeak (dBµV/m)	Meas. Time (ms)	Bandwidth (kHz)	Height (cm)	Polarization	Azimuth (deg)	Corr. (dB)	Margin - QPK (dB)	Limit - QPK (dBµV/m)	Comment
34.062300	18.1	1000.0	120.000	104.0	V	261.0	12.9	11.9	30.0	
45.956400	10.6	1000.0	120.000	152.0	V	-10.0	13.3	19.4	30.0	
112.859400	7.0	1000.0	120.000	105.0	V	3.0	10.8	26.5	33.5	
187.250700	6.8	1000.0	120.000	105.0	V	90.0	10.9	26.7	33.5	
732.457350	20.2	1000.0	120.000	98.0	V	190.0	23.3	15.8	36.0	
918.365550	22.1	1000.0	120.000	98.0	H	0.0	25.3	13.9	36.0	

Plot 2: 1 GHz to 12.75 GHz, vertical & horizontal polarization

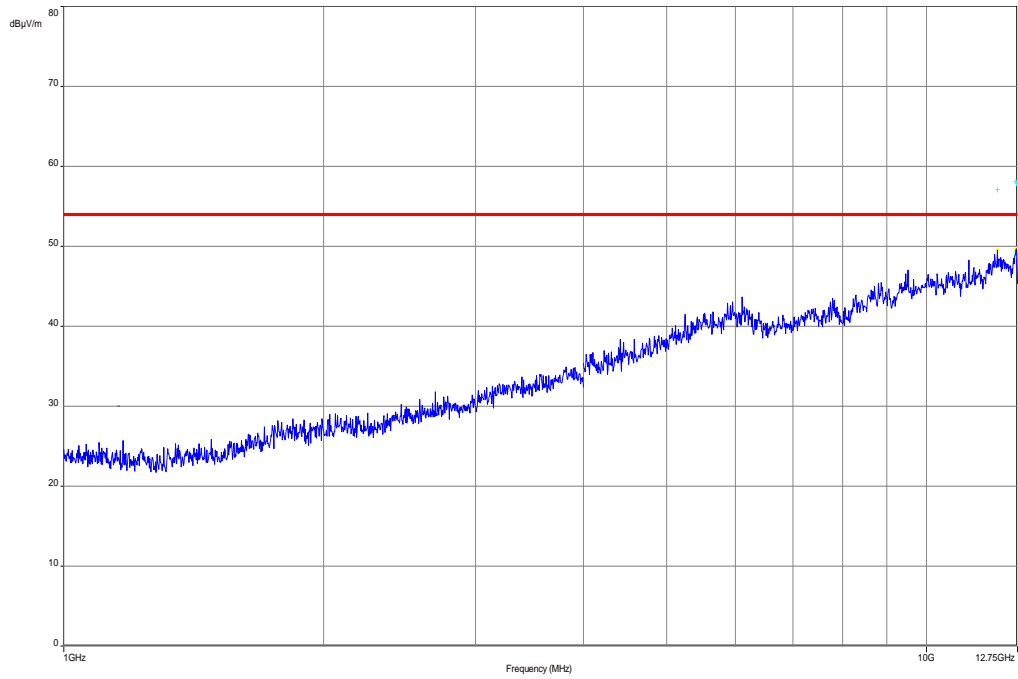

Plot 3: 12.75 GHz to 18 GHz, vertical & horizontal polarization

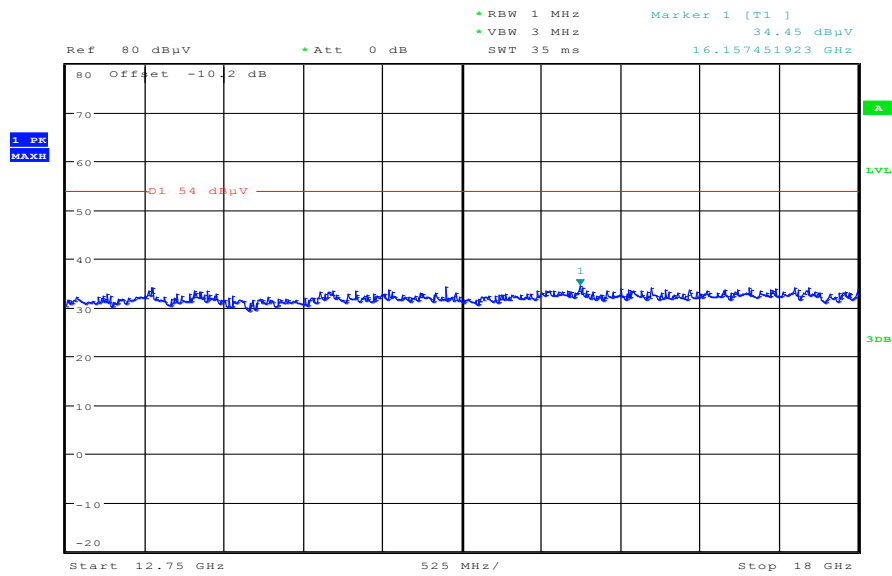

Date: 10.JAN.2013 11:30:18

Plot 4: 18 GHz to 26 GHz, vertical & horizontal polarization

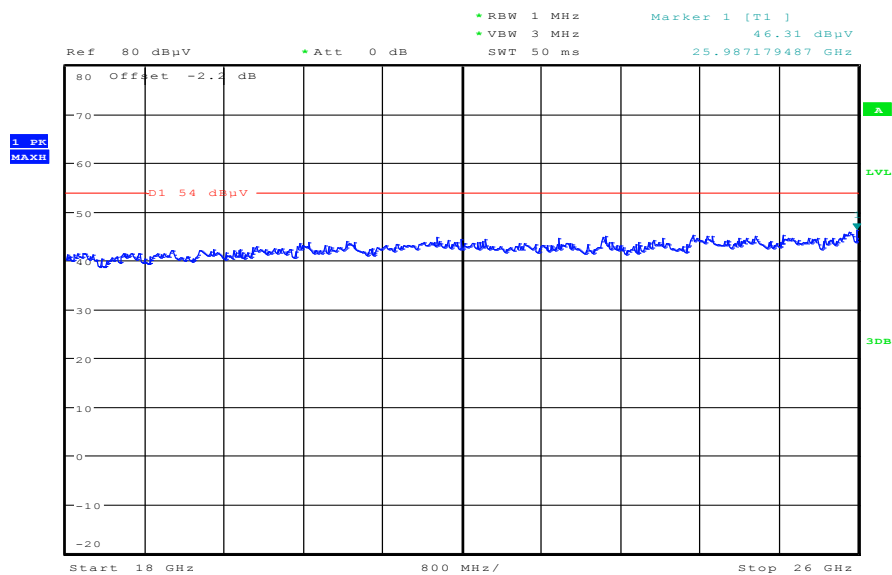

Date: 10.JAN.2013 11:31:41

Plot 5: 26 GHz to 40 GHz, vertical & horizontal polarization

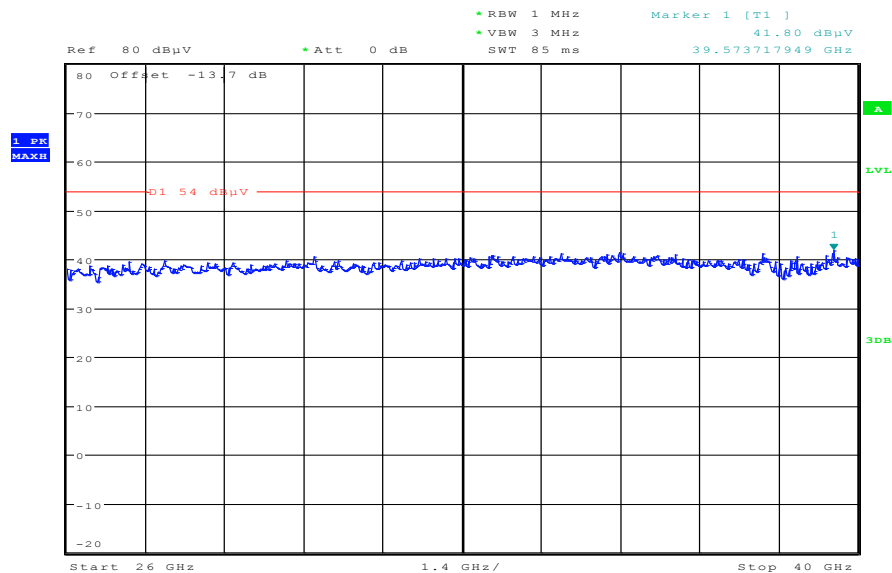

Date: 10.JAN.2013 12:00:55

9.11 Spurious emissions radiated < 30 MHz

Description:

Measurement of the radiated spurious emissions in transmit mode below 30 MHz. The EUT is set to mid channel. This measurement is representative for all channels and modes. If critical peaks are found the lowest channel and the highest channel will be measured too. The measurement is performed with the data rate producing the highest output power. The limits are recalculated to a measurement distance of 3 m with 40 dB/decade according CFR Part 2.

Measurement:

Measurement parameter	
Detector:	Peak / Quasi Peak
Sweep time:	Auto
Video bandwidth:	F < 150 kHz: 200 Hz F > 150 kHz: 9 kHz
Resolution bandwidth:	F < 150 kHz: 1 kHz F > 150 kHz: 100 kHz
Span:	9 kHz to 30 MHz
Trace-Mode:	Max Hold

Limits:

FCC		IC
TX Spurious Emissions Radiated < 30 MHz		
Frequency (MHz)	Field Strength (dBµV/m)	Measurement distance
0.009 – 0.490	2400/F(kHz)	300
0.490 – 1.705	24000/F(kHz)	30
1.705 – 30.0	30	30

Results:

TX Spurious Emissions Radiated < 30 MHz [dBµV/m]		
F [MHz]	Detector	Level [dBµV/m]
No peaks found.		
Measurement uncertainty	± 3 dB	

Result: Passed

Plots: TX mode

Plot 1: 9 kHz to 30 MHz

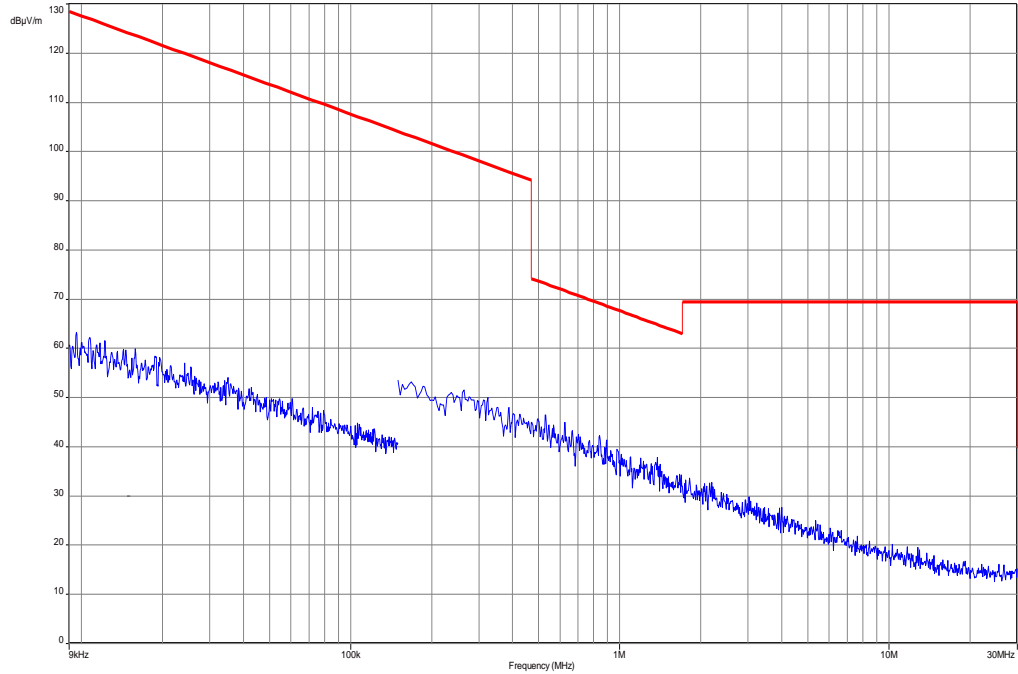

Plots: RX / Idle – mode

Plot 1: 9 kHz to 30 MHz

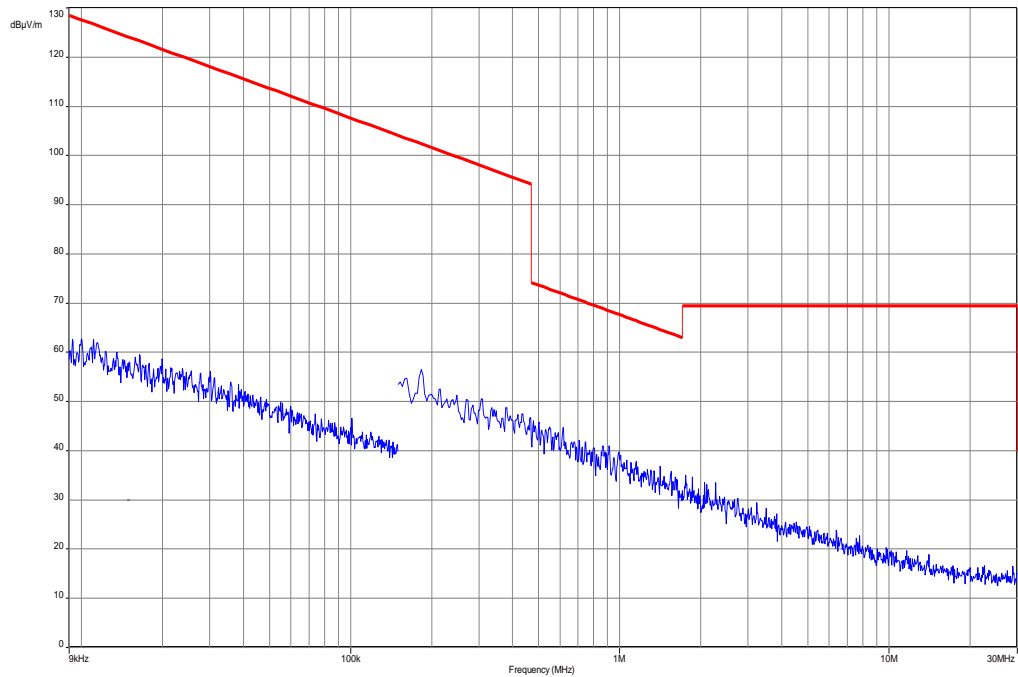

9.12 Spurious emissions conducted < 30 MHz

Description:

Measurement of the conducted spurious emissions in transmit mode below 30 MHz. The EUT is set to mid channel. This measurement is repeated for DSSS and OFDM modulation. If critical peaks are found the lowest channel and the highest channel will be measured too. The measurement is performed with the data rate producing the highest output power. Both power lines, phase and neutral line, are measured. Found peaks are remeasured with average and quasi peak detection to show compliance to the limits.

Measurement:

Measurement parameter	
Detector:	Peak - Quasi Peak / Average
Sweep time:	Auto
Video bandwidth:	F < 150 kHz: 200 Hz F > 150 kHz: 9 kHz
Resolution bandwidth:	F < 150 kHz: 1 kHz F > 150 kHz: 100 kHz
Span:	9 kHz to 30 MHz
Trace-Mode:	Max Hold

Limits:

FCC		IC	
TX Spurious Emissions Conducted < 30 MHz			
Frequency (MHz)	Quasi-Peak (dBµV/m)	Average (dBµV/m)	
0.15 – 0.5	66 to 56*	56 to 46*	
0.5 – 5	56	46	
5 – 30.0	60	50	

*Decreases with the logarithm of the frequency

Results:

TX Spurious Emissions Conducted < 30 MHz [dBµV/m]		
F [MHz]	Detector	Level [dBµV/m]
No critical peaks detected. All detected peak values are below the average limits.		
Measurement uncertainty	± 3 dB	

Result: Passed

Plots:

Plot 1: 9 kHz to 30 MHz / phase Line, TX mode

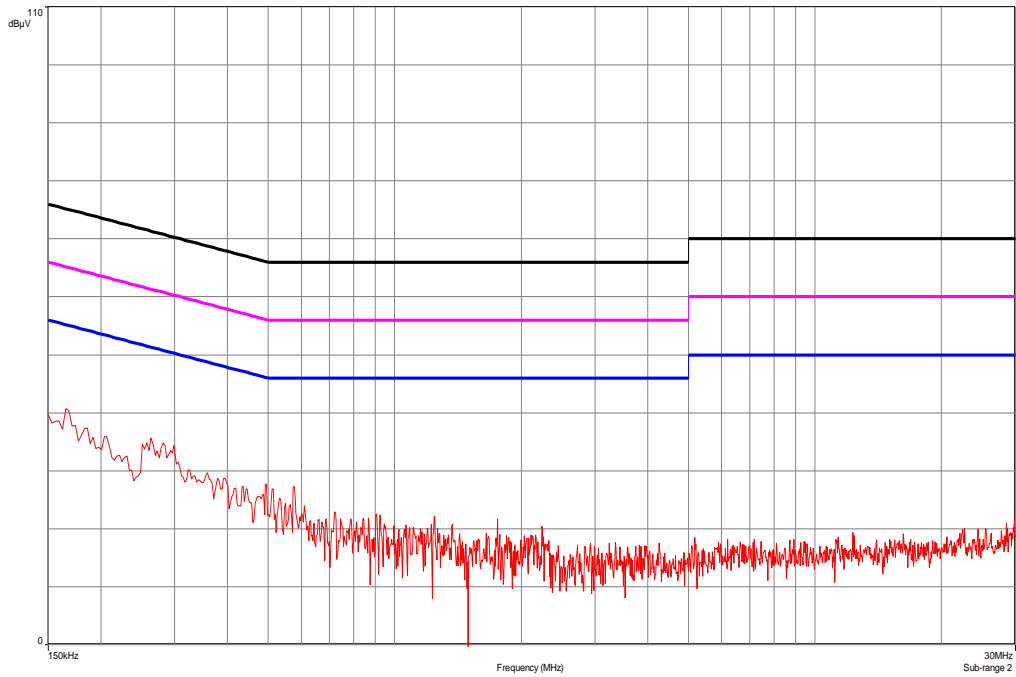

Plot 2: 9 kHz to 30 MHz / neutral Line, TX mode

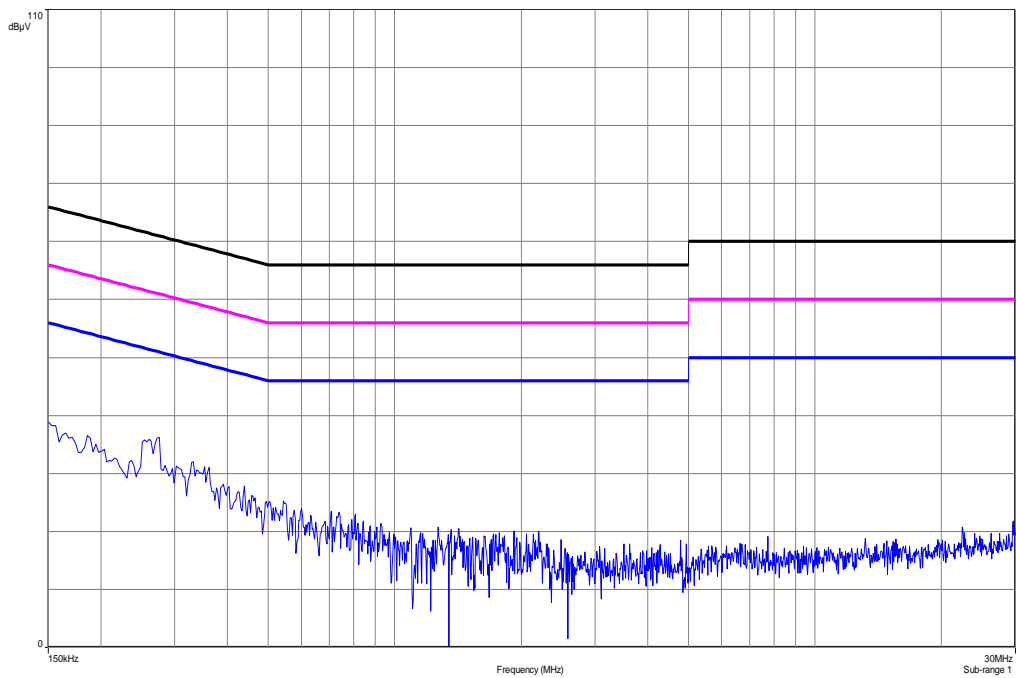

Plot 3: 9 kHz to 30 MHz / phase Line, RX mode

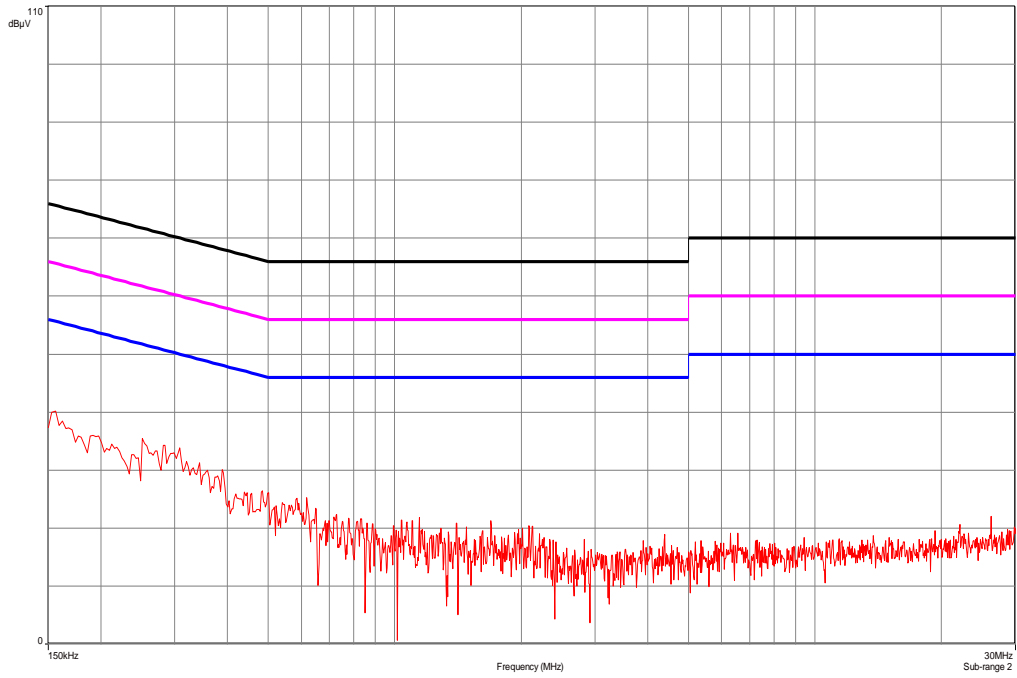

Plot 4: 9 kHz to 30 MHz / neutral Line, RX mode

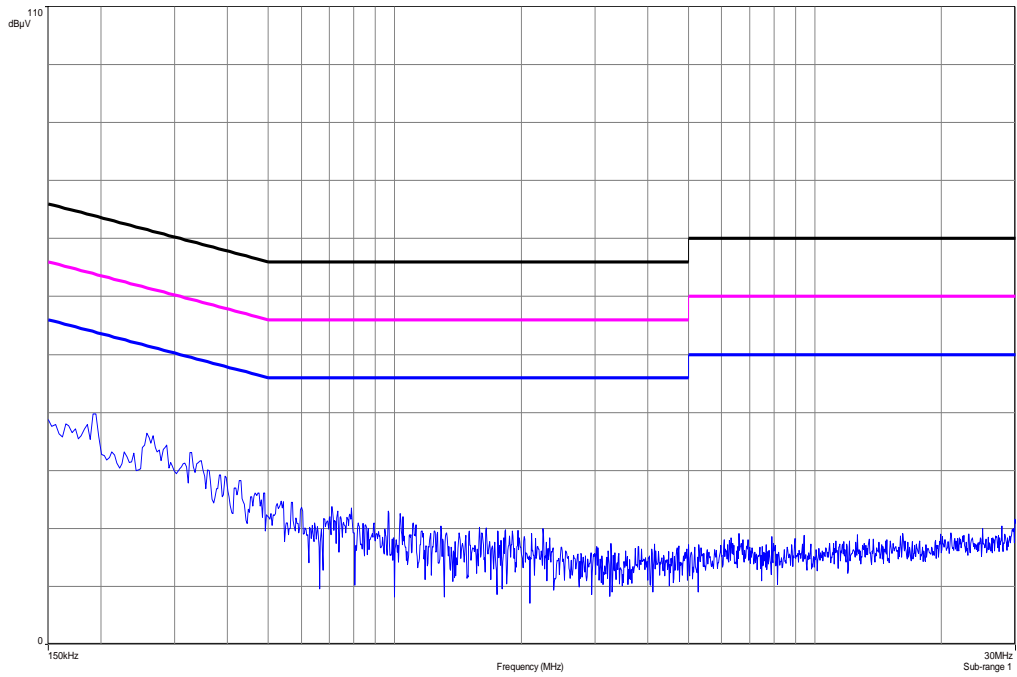

10 Test equipment and ancillaries used for tests

Typically, the calibrations of the test apparatus are commissioned to and performed by an accredited calibration laboratory. The calibration intervals are determined in accordance with the DIN EN ISO/IEC 17025. In addition to the external calibrations, the laboratory executes comparison measurements with other calibrated test systems or effective verifications. Weekly chamber inspections and range calibrations are performed. Where possible, rf-generating and signalling equipment as well as measuring receivers and analyzers are connected to an external high-precision 10 MHz reference (GPS-based or rubidium frequency standard).

In order to simplify the identification of the equipment used at some special tests, some items of test equipment and ancillaries can be provided with an identifier or number in the equipment list below (Labor/Item).

No.	Lab / Item	Equipment	Type	Manufact.	Serial No.	INV. No Cetecom	Kind of Calibration	Last Calibration	Next Calibration
1	45	Switch-Unit	3488A	HP Meßtechnik	2719A14505	300000368	g		
2	50	DC power supply, 60Vdc, 50A, 1200 W	6032A	HP Meßtechnik	2920A04466	300000580	ne		
3	n. a.	software	SPS_PHE 1.4f	Spitzberger & Spieß	B5981; 5D1081;B597 9	300000210	ne		
4	n. a.	EMI Test Receiver	ESCI 1166.5950. 03	R&S	100083	300003312	k	04.01.2012	04.01.2013
5	n. a.	Analyzer- Reference- System (Harmonics and Flicker)	ARS 16/1	SPS	A3509 07/0 0205	300003314	k	14.07.2011	14.07.2013
6	n. a.	Amplifier	JS42- 00502650- 28-5A	MITEQ	1084532	300003379	ev		
7	n. a.	Antenna Tower	Model 2175	ETS- LINDGREN	64762	300003745	izw		
8	n. a.	Positioning Controller	Model 2090	ETS- LINDGREN	64672	300003746	izw		
9	n. a.	Turntable Interface-Box	Model 105637	ETS- LINDGREN	44583	300003747	izw		
10	n. a.	TRILOG Broadband Test-Antenna 30 MHz - 3 GHz	VULB9163	Schwarzbe ck	295	300003787	k	12.04.2012	12.04.2014
11	n. a.	Spectrum- Analyzer	FSU26	R&S	200809	300003874	k	06.01.2012	06.01.2014
12	n. a.	DC power supply, 60Vdc, 50A, 1200 W	6032A	HP Meßtechnik	2818A03450	300001040	Ve	12.01.2012	12.01.2015
13	n. a.	Double-Ridged Waveguide Horn Antenna 1-18.0GHz	3115	EMCO	8812-3088	300001032	vIKI!	11.05.2011	11.05.2013
14	n. a.	Active Loop Antenna	6502	EMCO	2210	300001015	ne		
15	n. a.	Anechoic chamber	FAC 3/5m	MWB / TDK	87400/02	300000996	ev		
16	n. a.	Switch / Control Unit	3488A	HP Meßtechnik	*	300000199	ne		
17	n. a.	Switch / Control Unit	3488A	HP Meßtechnik	2719A15013	300001156	ne		
18	9	Isolating Transformer	MPL IEC625 Bus Regeltrennt ravo	Erfi	91350	300001155	ne		
19	n. a.	Three-Way Power Splitter, 50 Ohm	11850C	HP Meßtechnik		300000997	ne		
20	n. a.	Amplifier	js42- 00502650- 28-5a	Parzich GMBH	928979	300003143	ne		
21	n. a.	Highpass Filter	WHKX7.0/1 8G-8SS	Wainwright	18	300003789	ne		
22	n. a.	TRILOG Broadband Test-Antenna 30 MHz - 3 GHz	VULB9163	Schwarzbe ck	371	300003854	vIKI!	14.10.2011	14.10.2014

23	n. a.	MXE EMI Receiver 20 Hz bis 26.5 GHz	N9038A	Agilent Technologies	MY51210197	300004405	k	19.12.2011	19.12.2012
24	11b	Microwave System Amplifier, 0.5-26.5 GHz	83017A	HP Meßtechnik	00419	300002268	ev		
25	A025	Std. Gain Horn Antenna 12.4 to 18.0 GHz	639	Narda		300000786	ne		
26	A028	Std. Gain Horn Antenna 18.0 to 26.5 GHz	638	Narda		300002440	ne		
27	n. a.	Std. Gain Horn Antenna 26.5-40.0 GHz	V637	Narda	7911	300001752	ne		
28	n. a.	Broadband Low Noise Amplifier 18-50 GHz	CBL18503 070-XX	CERNEX	19338	300004273	ne		
29	n. a.	PXA Spectrum Analyzer 3Hz to 50GHz	N9030A PXA Signal Analyzer	Agilent Technologies	US51350267	300004338	k	12.01.2012	12.01.2013

Agenda: Kind of Calibration

- | | | | |
|------|--|-----|--|
| k | calibration / calibrated | EK | limited calibration |
| ne | not required (k, ev, izw, zw not required) | zw | cyclical maintenance (external cyclical maintenance) |
| ev | periodic self verification | izw | internal cyclical maintenance |
| Ve | long-term stability recognized | g | blocked for accredited testing |
| vk!! | Attention: extended calibration interval | *) | next calibration ordered / currently in progress |
| NK! | Attention: not calibrated | | |

11 Observations

No observations exceeding those reported with the single test cases have been made.