



## TEST REPORT

Test report no.: 1-4254/12-61-04-A



Deutsche  
Akkreditierungsstelle  
D-PL-12076-01-01

### Testing laboratory

**CETECOM ICT Services GmbH**  
Untertuerkheimer Strasse 6 – 10  
66117 Saarbruecken / Germany  
Phone: + 49 681 5 98 - 0  
Fax: + 49 681 5 98 - 9075  
Internet: <http://www.cetecom.com>  
e-mail: [ict@cetecom.com](mailto:ict@cetecom.com)

#### Accredited Testing Laboratory:

The testing laboratory (area of testing) is accredited according to DIN EN ISO/IEC 17025 (2005) by the Deutsche Akkreditierungsstelle GmbH (DAkkS). The accreditation is valid for the scope of testing procedures as stated in the accreditation certificate with the registration number: D-PL-12076-01-01  
Area of Testing: Radio/Satellite Communications

### Applicant

**Sony Mobile Communications AB**  
Nya Vattentornet  
22188 Lund / SWEDEN  
Phone: +46 46 19 30 00  
Fax: +46 46 19 32 95  
Contact: Håkan Sjöberg  
e-mail: [hakan.sjoberg@sonymobile.com](mailto:hakan.sjoberg@sonymobile.com)  
Phone: +46 46 19 35 59

### Manufacturer

**Sony Mobile Communications AB**  
Nya Vattentornet  
22188 Lund / SWEDEN

### Test standard/s

47 CFR Part 15	Title 47 of the Code of Federal Regulations; Chapter I Part 15 - Radio frequency devices
RSS - 210 Issue 8	Spectrum Management and Telecommunications - Radio Standards Specification Low-power Licence-exempt Radiocommunication Devices (All Frequency Bands): Category I Equipment

For further applied test standards please refer to section 3 of this test report.

### Test Item

Kind of test item:	GSM Mobile Phone GPRS/EGPRS 850/900/1800/1900; UMTS HSPA FDDI/V/VIII; LTE FDD 1/3/5/7/8/20; WLAN a/b/g/n; BT 3.1; BT LE; RFID; FM Rx; A-GPS
Model name:	PM-0240-BV
FCC ID:	PY7PM-0240
IC:	4170B-PM0240
Frequency:	ISM band 2400 MHz to 2483.5 MHz (lowest channel 00 – 2402 MHz, highest channel 78 – 2480 MHz)
Technology tested:	Bluetooth®, +EDR
Antenna:	Integrated antenna
Power Supply:	3.7 V DC by Li-polymer battery
Temperature Range:	-20°C to +55 °C

### Test report authorised:

  
p.o.  
2013-01-10 Joerg Warken  
Senior Testing Manager

### Test performed:

  
2013-01-10 Andreas Luckenbill  
Expert

<b>1 Table of contents</b>	
<b>1</b>	<b>Table of contents .....2</b>
<b>2</b>	<b>General information .....3</b>
2.1	Notes and disclaimer .....3
2.2	Application details.....3
<b>3</b>	<b>Test standard/s .....3</b>
<b>4</b>	<b>Test environment.....4</b>
<b>5</b>	<b>Test item .....4</b>
<b>6</b>	<b>Test laboratories sub-contracted .....4</b>
<b>7</b>	<b>Summary of measurement results .....5</b>
<b>8</b>	<b>RF measurements .....6</b>
8.1	Description of test setup .....6
8.1.1	Radiated measurements.....6
8.1.2	Conducted measurements.....7
8.2	Additional comments .....7
8.3	RSP100 test report cover sheet / performance test data .....8
<b>9</b>	<b>Measurement results.....9</b>
9.1	Antenna gain.....9
9.2	Power spectral density .....10
9.3	Carrier frequency separation .....11
9.4	Number of hopping channels.....13
9.5	Time of occupancy (dwell time) .....15
9.6	Spectrum bandwidth of a FHSS system – 20 dB bandwidth .....16
9.7	Maximum output power .....22
9.8	Band edge compliance conducted .....29
9.9	Band edge compliance radiated .....36
9.10	TX spurious emissions conducted .....40
9.11	TX spurious emissions radiated .....48
9.12	RX spurious emissions radiated .....59
9.13	Spurious emissions radiated < 30 MHz .....63
9.14	Spurious emissions conducted < 30 MHz.....65
<b>10</b>	<b>Test equipment and ancillaries used for tests .....68</b>
<b>11</b>	<b>Observations .....69</b>
<b>Annex A</b>	<b>Photographs of the test setup .....70</b>
<b>Annex B</b>	<b>External photographs of the EUT.....75</b>
<b>Annex C</b>	<b>Internal photographs of the EUT .....79</b>
<b>Annex D</b>	<b>Document history .....85</b>
<b>Annex E</b>	<b>Further information.....85</b>
<b>Annex F</b>	<b>Accreditation Certificate .....86</b>

## 2 General information

### 2.1 Notes and disclaimer

The test results of this test report relate exclusively to the test item specified in this test report. CETECOM ICT Services GmbH does not assume responsibility for any conclusions and generalizations drawn from the test results with regard to other specimens or samples of the type of the equipment represented by the test item.

The test report may only be reproduced or published in full. Reproduction or publication of extracts from the report requires the prior written approval of CETECOM ICT Services GmbH.

The testing service provided by CETECOM ICT Services GmbH has been rendered under the current "General Terms and Conditions for CETECOM ICT Services GmbH".

CETECOM ICT Services GmbH will not be liable for any loss or damage resulting from false, inaccurate, inappropriate or incomplete product information provided by the customer.

Under no circumstances does the CETECOM ICT Services GmbH test report include any endorsement or warranty regarding the functionality, quality or performance of any other product or service provided.

Under no circumstances does the CETECOM ICT Services GmbH test report include or imply any product or service warranties from CETECOM ICT Services GmbH, including, without limitation, any implied warranties of merchantability, fitness for purpose, or non-infringement, all of which are expressly disclaimed by CETECOM ICT Services GmbH.

All rights and remedies regarding vendor's products and services for which CETECOM ICT Services GmbH has prepared this test report shall be provided by the party offering such products or services and not by CETECOM ICT Services GmbH.

In no case this test report can be considered as a Letter of Approval.

### 2.2 Application details

Date of receipt of order:	2012-11-02
Date of receipt of test item:	2012-11-05
Start of test:	2012-11-06
End of test:	2013-01-09
Person(s) present during the test:	-/-

## 3 Test standard/s

Test standard	Date	Test standard description
47 CFR Part 15	2010-10	Title 47 of the Code of Federal Regulations; Chapter I Part 15 - Radio frequency devices
RSS - 210 Issue 8	2010-12	Spectrum Management and Telecommunications - Radio Standards Specification Low-power Licence-exempt Radiocommunication Devices (All Frequency Bands): Category I Equipment

#### 4 Test environment

Temperature:	$T_{nom}$	+22 °C during room temperature tests
	$T_{max}$	+55 °C during high temperature tests
	$T_{min}$	-20 °C during low temperature tests
Relative humidity content:		46 %
Barometric pressure:		not relevant for this kind of testing
Power supply:	$V_{nom}$	3.7 V DC by Li-polymer battery
	$V_{max}$	4.1 V
	$V_{min}$	3.3 V

#### 5 Test item

Kind of test item	:	GSM Mobile Phone GPRS/EGPRS 850/900/1800/1900; UMTS HSPA FDDI/V/VIII; LTE FDD 1/3/5/7/8/20; WLAN a/b/g/n; BT 3.1; BT LE; RFID; FM Rx; A-GPS
Type identification	:	PM-0240-BV
S/N serial number	:	Rad. CB5121SWF0, CB5121SWEK Cond. CB5121SWLW, CB5121SWNW
HW hardware status	:	SP1.2
SW software status	:	10.1.A.0.194, 10.1.A.1.17
Frequency band [MHz]	:	ISM band 2400 MHz to 2483.5 MHz (lowest channel 00 – 2402 MHz, highest channel 78 – 2480 MHz)
Type of radio transmission	:	FHSS
Use of frequency spectrum	:	
Type of modulation	:	GFSK, Pi/4-DQPSK, 8DPSK
Number of channels	:	79
Antenna	:	Integrated antenna
Power supply	:	3.7 V DC by Li-polymer battery
Temperature range	:	-20°C to +55 °C

#### 6 Test laboratories sub-contracted

None



## 7 Summary of measurement results

- No deviations from the technical specifications were ascertained
- There were deviations from the technical specifications ascertained

TC Identifier	Description	Verdict	Date	Remark
RF-Testing	CFR Part 15 RSS 210, Issue 8, Annex 8	Passed	2013-01-10	-/-

Test specification clause	Test case	Temperature conditions	Power source voltages	Mode	Pass	Fail	NA	NP	Remark
§15.247(b)(4) RSS 210 / A8.4(2)	Antenna gain	Nominal	Nominal	GFSK	<input checked="" type="checkbox"/>	<input type="checkbox"/>	<input type="checkbox"/>	<input type="checkbox"/>	complies
§15.247(e) RSS 210 / A8.2(b)	Power spectral density	Nominal	Nominal	GFSK Pi/4 DQPSK 8 DPSK	<input type="checkbox"/>	<input type="checkbox"/>	<input checked="" type="checkbox"/>	<input type="checkbox"/>	Not applicable for FHSS!
§15.247(a)(1) RSS 210 / A8.1(b)	Carrier frequency separation	Nominal	Nominal	GFSK	<input checked="" type="checkbox"/>	<input type="checkbox"/>	<input type="checkbox"/>	<input type="checkbox"/>	complies
§15.247(a)(1) RSS 210 / A8.1(d)	Number of hopping channels	Nominal	Nominal	GFSK	<input checked="" type="checkbox"/>	<input type="checkbox"/>	<input type="checkbox"/>	<input type="checkbox"/>	complies
§15.247(a)(1) (iii) RSS 210 / A8.3(1)	Time of occupancy (dwell time)	Nominal	Nominal	GFSK Pi/4 DQPSK 8 DPSK	<input checked="" type="checkbox"/>	<input type="checkbox"/>	<input type="checkbox"/>	<input type="checkbox"/>	complies
§15.247(a)(1) RSS 210 / A8.2(a)	Spectrum bandwidth of a FHSS system 20dB bandwidth	Nominal	Nominal	GFSK Pi/4 DQPSK 8 DPSK	<input checked="" type="checkbox"/> <input checked="" type="checkbox"/> <input checked="" type="checkbox"/>	<input type="checkbox"/> <input type="checkbox"/> <input type="checkbox"/>	<input type="checkbox"/> <input type="checkbox"/> <input type="checkbox"/>	<input type="checkbox"/> <input type="checkbox"/> <input type="checkbox"/>	complies
§15.247(b)(1) RSS-210 / A8.4(2)	Maximum output power	Nominal	Nominal	GFSK Pi/4 DQPSK 8 DPSK	<input checked="" type="checkbox"/> <input checked="" type="checkbox"/> <input checked="" type="checkbox"/>	<input type="checkbox"/> <input type="checkbox"/> <input type="checkbox"/>	<input type="checkbox"/> <input type="checkbox"/> <input type="checkbox"/>	<input type="checkbox"/> <input type="checkbox"/> <input type="checkbox"/>	complies
§15.247(d) RSS-210 / A8.5	Band edge compliance conducted	Nominal	Nominal	GFSK Pi/4 DQPSK 8 DPSK	<input checked="" type="checkbox"/> <input checked="" type="checkbox"/> <input checked="" type="checkbox"/>	<input type="checkbox"/> <input type="checkbox"/> <input type="checkbox"/>	<input type="checkbox"/> <input type="checkbox"/> <input type="checkbox"/>	<input type="checkbox"/> <input type="checkbox"/> <input type="checkbox"/>	complies
§15.205 RSS-210 / A8.5	Band edge compliance radiated	Nominal	Nominal	GFSK Pi/4 DQPSK 8 DPSK	<input checked="" type="checkbox"/> <input checked="" type="checkbox"/> <input checked="" type="checkbox"/>	<input type="checkbox"/> <input type="checkbox"/> <input type="checkbox"/>	<input type="checkbox"/> <input type="checkbox"/> <input type="checkbox"/>	<input type="checkbox"/> <input type="checkbox"/> <input type="checkbox"/>	complies
§15.247(d) RSS-210 / A8.5	TX spurious emissions conducted	Nominal	Nominal	GFSK Pi/4 DQPSK 8 DPSK	<input checked="" type="checkbox"/> <input checked="" type="checkbox"/> <input checked="" type="checkbox"/>	<input type="checkbox"/> <input type="checkbox"/> <input type="checkbox"/>	<input type="checkbox"/> <input type="checkbox"/> <input type="checkbox"/>	<input type="checkbox"/> <input type="checkbox"/> <input type="checkbox"/>	complies
§15.247(d) RSS-210 / A8.5	TX spurious emissions radiated	Nominal	Nominal	GFSK	<input checked="" type="checkbox"/>	<input type="checkbox"/>	<input type="checkbox"/>	<input type="checkbox"/>	complies
§15.109 RSS-Gen	RX spurious emissions radiated	Nominal	Nominal	-/-	<input checked="" type="checkbox"/>	<input type="checkbox"/>	<input type="checkbox"/>	<input type="checkbox"/>	complies
§15.209(a) RSS-Gen	TX spurious emissions radiated < 30 MHz	Nominal	Nominal	GFSK	<input checked="" type="checkbox"/>	<input type="checkbox"/>	<input type="checkbox"/>	<input type="checkbox"/>	complies
§15.107(a)	Conducted emissions < 30 MHz	Nominal	Nominal	GFSK	<input checked="" type="checkbox"/>	<input type="checkbox"/>	<input type="checkbox"/>	<input type="checkbox"/>	complies

**Note:** NA = Not Applicable; NP = Not Performed

## 8 RF measurements

### 8.1 Description of test setup

#### 8.1.1 Radiated measurements

The radiated measurements are performed in vertical and horizontal plane in the frequency range from 9 kHz to 25 GHz in semi-anechoic chambers. The EUT is positioned on a non-conductive support with a height of 0.80 m above a conductive ground plane that covers the whole chamber. The receiving antennas are confirmed with specifications ANSI C63.2-1996 clause 15 and ANSI C63.4-2009 clause 4.1.5. These antennas can be moved over the height range between 1.0 m and 4.0 m in order to search for maximum field strength emitted from EUT. The measurement distances between EUT and receiving antennas are indicated in the test setups for the various frequency ranges. For each measurement, the EUT is rotated in all three axes until the maximum field strength is received. The wanted and unwanted emissions are received by spectrum analysers where the detector modes and resolution bandwidths over various frequency ranges are set according to requirement ANSI C63-4-2009 clause 4.2.

Antennas are confirmed with ANSI C63.2-1996 item 15.

Semi anechoic chamber

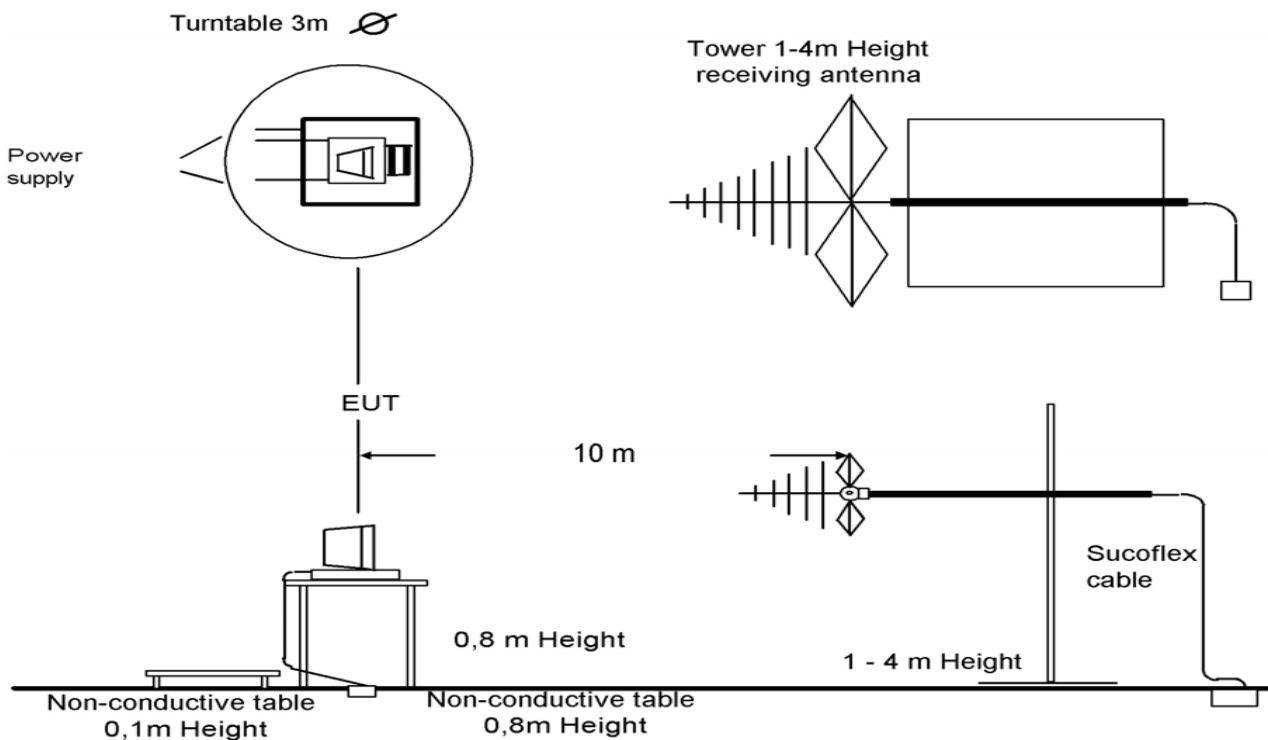

Picture 1: Diagram radiated measurements

9 kHz - 30 MHz:	active loop antenna
30 MHz – 1 GHz:	tri-log antenna
> 1 GHz:	horn antenna

All measurements are done in accordance with the Filing and Measurement Guidelines for Frequency Hopping Spread Spectrum Systems DA 00-705 and Appendix A "BLUETOOTH® APPROVALS". The EUT is powered by an external power supply with nominal voltage. The signalling is performed from outside the chamber with a signalling unit (CMU200 or other) by air link using signalling antenna.

### 8.1.2 Conducted measurements

The EUT's RF signal is coupled out by the antenna connector which is supplied by the manufacturer. The signal is first 10dB attenuated before it is power divided (~6dB loss per branch). One of the signal paths is connected to the communication base Station (CMU200 or other), the other one is connected to the spectrum analyzer. The specific losses for both signal paths are first checked within a calibration. The measurement readings on the signalling unit/spectrum analyzer are corrected by the specific test set-up loss. The attenuator, power divider, signalling unit and the spectrum analyzer are impedance matched on 50 Ohm.

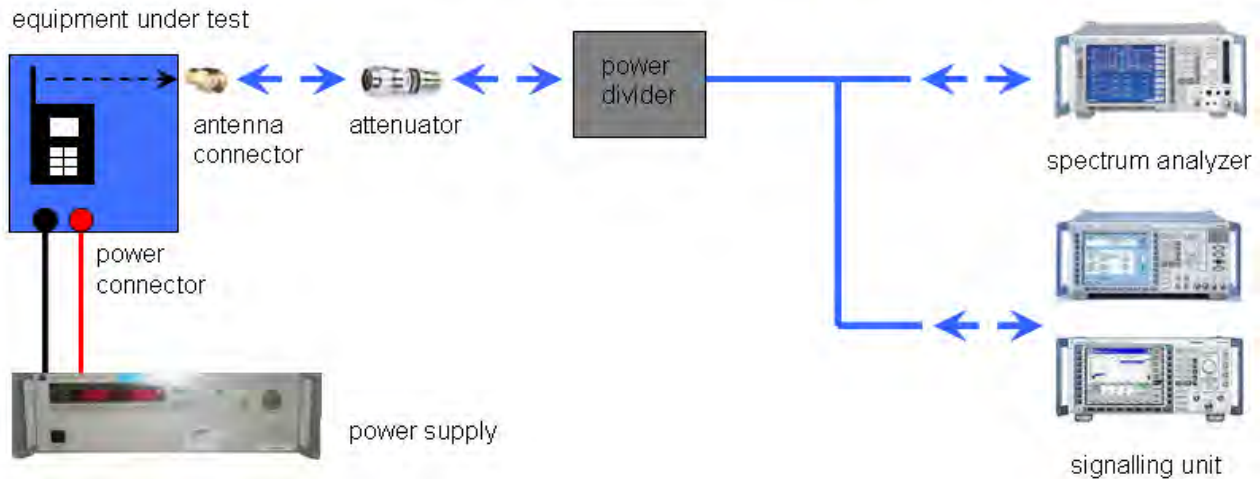

Picture 2: Diagram conducted measurements

### 8.2 Additional comments

The Bluetooth® word mark and logos are owned by the Bluetooth SIG Inc. and any use of such marks by Cetecom ICT Services GmbH is under license.

Reference documents: None

Special test descriptions: None

Configuration descriptions: TX tests: were performed with x-DH5 packets and static PRBS pattern payload.  
RX/Standby tests: BT test mode enabled, scan enabled, TX Idle

Test mode:

- Bluetooth Test mode loop back enabled (EUT is controlled over CBT/CMU)
- Special software is used. EUT is transmitting pseudo random data by itself

### 8.3 RSP100 test report cover sheet / performance test data

Test report number	:	1-4254/12-61-04-A
Equipment model number	:	PM-0240-BV
Certification number	:	4170B-PM0240
Manufacturer (complete address)	:	Sony Mobile Communications AB Nya Vattentorget 22188 Lund / SWEDEN
Tested to radio standards specification no.	:	RSS 210, Issue 8, Annex 8
Open area test site IC No.	:	IC 3462C-1
Frequency range	:	Lowest channel 2402 MHz, highest channel 2480 MHz
RF-power [W] (max.)	:	Cond.: 5.5 mW (GFSK modulation) EIRP: 4.4 mW (GFSK modulation) Cond.: 6.6 mW (Pi/4-DQPSK modulation) EIRP: 5.4 mW (Pi/4-DQPSK modulation) Cond.: 6.9 mW (8DPSK modulation) EIRP: 5.6 mW (8DPSK modulation)
Occupied bandwidth (99%-BW) [kHz]	:	1028 (GFSK modulation) 1317 (Pi/4-DQPSK modulation) 1317 (8DPSK modulation)
Type of modulation	:	FHSS technology with GFSK, Pi/4 DQPSK and 8 DPSK modulation.
Emission designator (TRC-43)	:	1028KFXD (GFSK modulation) 1M32GXD (Pi/4-DQPSK modulation) 1M32GXD (8DPSK modulation)
Antenna information	:	Integrated antenna
Transmitter spurious (worst case) [dB $\mu$ V/m @ 3m]:		48 dB $\mu$ V/m @ 3m (noise floor) Peak
Receiver spurious (worst case) [dB $\mu$ V/m @ 3m]:		48 dB $\mu$ V/m @ 3m (noise floor) Peak

#### ATTESTATION:

#### DECLARATION OF COMPLIANCE:

I attest that the testing was performed or supervised by me; that the test measurements were made in accordance with the above-mentioned Industry Canada standard(s); and that the equipment identified in this application has been subjected to all the applicable test conditions specified in the Industry Canada standards and all of the requirements of the standard have been met.

#### Laboratory manager:

2013-01-10      Andreas Luckenbill  
Date                      Name

  
Signature



## 9 Measurement results

### 9.1 Antenna gain

#### Measurement:

The antenna gain of the complete system is calculated by the difference of radiated power in EIRP and the conducted power of the module. For normal Bluetooth® devices, the GFSK modulation is used.

#### Measurement parameters:

Measurement parameter	
Detector:	Peak
Sweep time:	Auto
Video bandwidth:	3 MHz
Resolution bandwidth:	3 MHz
Span:	5 MHz
Trace-Mode:	Max hold

#### Limits:

FCC	IC
Antenna Gain	
6 dBi	

#### Results:

T <sub>nom</sub>	V <sub>nom</sub>	lowest channel 2402 MHz	middle channel 2441 MHz	highest channel 2480 MHz
Conducted power [dBm] Measured with GFSK modulation		5.9	7.4	6.8
Radiated power [dBm] Measured with GFSK modulation		6.4	5.0	3.2
Gain [dBi] Calculated		0.5	-2.4	-3.6

**Result: Passed**

## 9.2 Power spectral density

### Description:

Measurement of the power spectral density of a digital modulated system. This requirement is only valid for digitally modulated systems without hopping functionality.

### Measurement:

Measurement parameter	
Detector:	Peak
Sweep time:	500 s
Video bandwidth:	3 kHz
Resolution bandwidth:	3 kHz
Span:	150 kHz
Trace-Mode:	Max Hold

### Limits:

FCC	IC
Power Spectral Density	
For digitally modulated systems the transmitter power spectral density conducted from the transmitter to the antenna shall not be greater than 8 dBm in any 3 kHz band during any time interval of continuous transmission or over 1.0 second if the transmission exceeds 1.0-second duration.	

### Results:

Modulation	Power spectral density [dBm/3kHz]		
	2412 MHz	2437 MHz	2462 MHz
Frequency			
GFSK	<b>Not required for hopping systems!</b>		
Pi/4 DQPSK			
8DPSK			
Measurement uncertainty	± 1.5 dB		

### 9.3 Carrier frequency separation

**Description:**

Measurement of the carrier frequency separation of a hopping system. The carrier frequency separation is constant for all modulation-modes. We use GFSK-modulation to show compliance. EUT in hopping mode.

**Measurement:**

Measurement parameter	
Detector:	Peak
Sweep time:	Auto
Video bandwidth:	100 kHz
Resolution bandwidth:	100 kHz
Span:	4 MHz
Trace-Mode:	Max Hold

**Limits:**

FCC	IC
Carrier Frequency Separation	
Minimum 25 kHz or two-thirds of the 20 dB bandwidth of the hopping system whichever is greater.	

**Result:**

Carrier frequency separation	~ 1 MHz
------------------------------	---------

**Result: Passed**

**Plot:**

**Plot 1: Carrier frequency separation (GFSK modulation)**

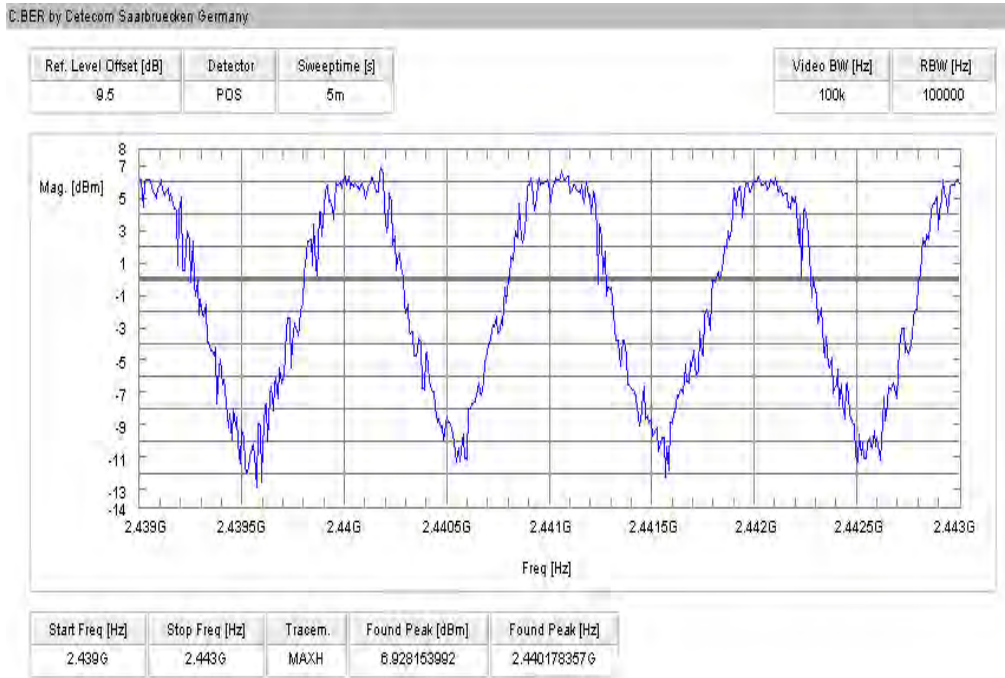



## 9.4 Number of hopping channels

### Description:

Measurement of the total number of used hopping channels. The number of hopping channels is constant for all modulation-modes. We use GFSK-modulation to show compliance. EUT in hopping mode.

### Measurement:

Measurement parameter	
Detector:	Peak
Sweep time:	Auto
Video bandwidth:	500 kHz
Resolution bandwidth:	500 kHz
Span:	Plot 1: 2400 – 2445 MHz Plot 2: 2445 – 2485 MHz
Trace-Mode:	Max Hold

### Limits:

FCC	IC
Number of hopping channels	
At least 15 non overlapping hopping channels	

### Result:

Number of hopping channels	79
----------------------------	----

**Result: Passed**

**Plots:**

**Plot 1: Number of hopping channels (GFSK modulation)**

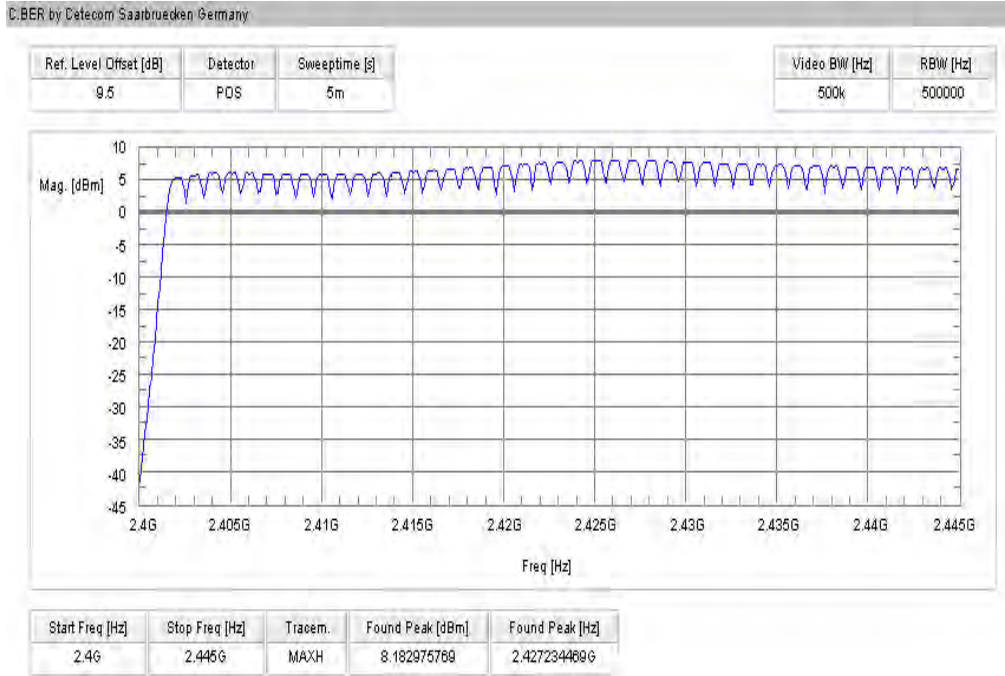

**Plot 2: Number of hopping channels (GFSK modulation)**

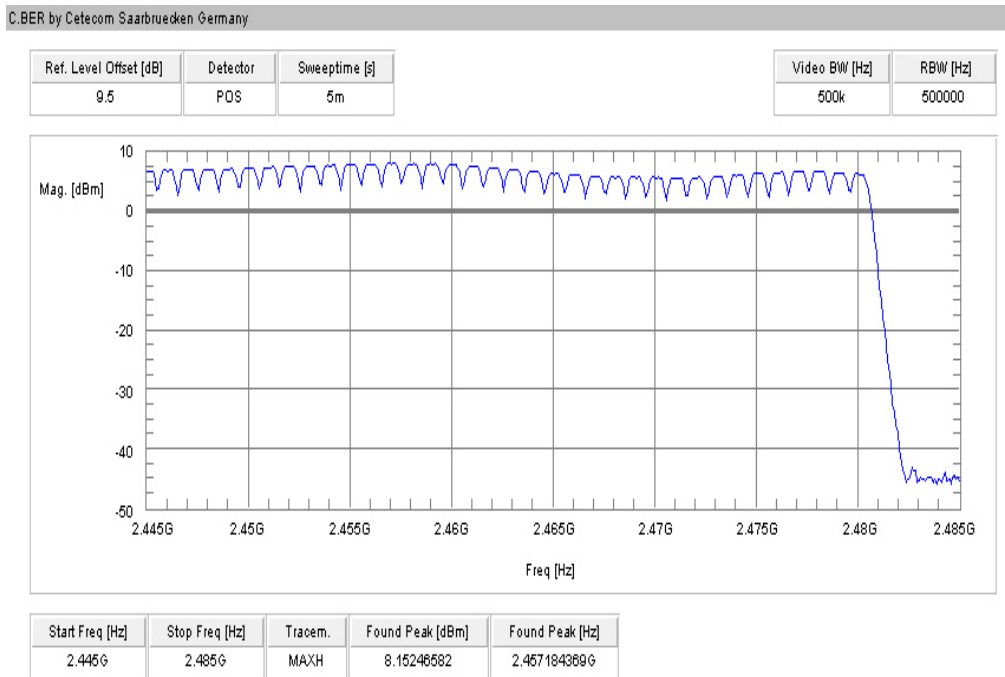

## 9.5 Time of occupancy (dwell time)

### Measurement:

For Bluetooth® devices no measurements mandatory depending on the fixed requirements according to the Bluetooth® Core Specifications!

### For Bluetooth® devices:

The channel staying time of 0.4 s within a 31.6 second period in data mode is constant for Bluetooth® devices and independent from the packet type (packet length). The calculation for a 31.6 second period is as follows:

Channel staying time = time slot length \* hop rate / number of hopping channels \* 31.6 s

Example for a DH1 packet (with a maximum length of one time slot)  
 Channel staying time =  $625 \mu\text{s} * 1600 * 1/\text{s} / 79 * 31.6 \text{ s} = 0.4 \text{ s}$  (in a 31.6 s period)

For multi-slot packets the hopping is reduced according to the length of the packet.

Example for a DH3 packet (with a maximum length of three time slots)  
 Channel staying time =  $3 * 625 \mu\text{s} * 1600/3 * 1/\text{s} / 79 * 31.6 \text{ s} = 0.4 \text{ s}$  (in a 31.6 s period)

Example for a DH5 packet (with a maximum length of five time slots)  
 Channel staying time =  $5 * 625 \mu\text{s} * 1600/5 * 1/\text{s} / 79 * 31.6 \text{ s} = 0.4 \text{ s}$  (in a 31.6 s period)

This is according to the Bluetooth® Core Specification V2.0 & V2.1 & V3.0 & V4.0 (+ critical errata) for all Bluetooth® devices.

### The following table shows the relations:

Packet Size	Pulse Width [ms] *	Max. number of transmissions per channel in 31.6 sec
DH1	0.366	640
DH3	1.622	214
DH5	2.870	128

\* according Bluetooth® specification

### Results:

Packet Size	Pulse Width [ms]*	Max. number of transmissions in 31.6 sec	Dwell time [Pulse width * Number of transmissions]
DH1	0.366	640	234.2 ms
DH3	1.622	214	347.1 ms
DH5	2.870	128	367.4 ms

### Limits:

FCC	IC
Time of occupancy (dwell time)	
The frequency hopping operation shall have an average time of occupancy on any frequency not exceeding 0.4 seconds within a duration in seconds equal to the number of hopping frequencies multiplied by 0.4.	

**Result: Passed**

## 9.6 Spectrum bandwidth of a FHSS system – 20 dB bandwidth

### Description:

Measurement of the 20dB bandwidth of the modulated signal. The measurement is performed according to the “Measurement Guidelines” (DA 00-705, March 30, 2000). EUT in single channel mode.

### Measurement:

Measurement parameter	
Detector:	Peak
Sweep time:	2 s
Video bandwidth:	30 kHz
Resolution bandwidth:	30 kHz
Span:	9 MHz
Trace-Mode:	Max Hold

### Limits:

FCC	IC
Spectrum bandwidth of a FHSS system – 20 dB bandwidth	
GFSK < 1500 kHz Pi/4 DQPSK < 1500 kHz 8DPSK < 1500 kHz	

### Results:

Modulation	20 dB BANDWIDTH [kHz]		
	2402 MHz	2441 MHz	2480 MHz
Frequency			
GFSK	956	992	1028
Pi/4 DQPSK	1263	1299	1317
8DPSK	1299	1281	1317
Measurement uncertainty	± 30 kHz		

**Result: Passed**



**Plots:**

**Plot 1:** lowest channel – 2402 MHz, GFSK modulation

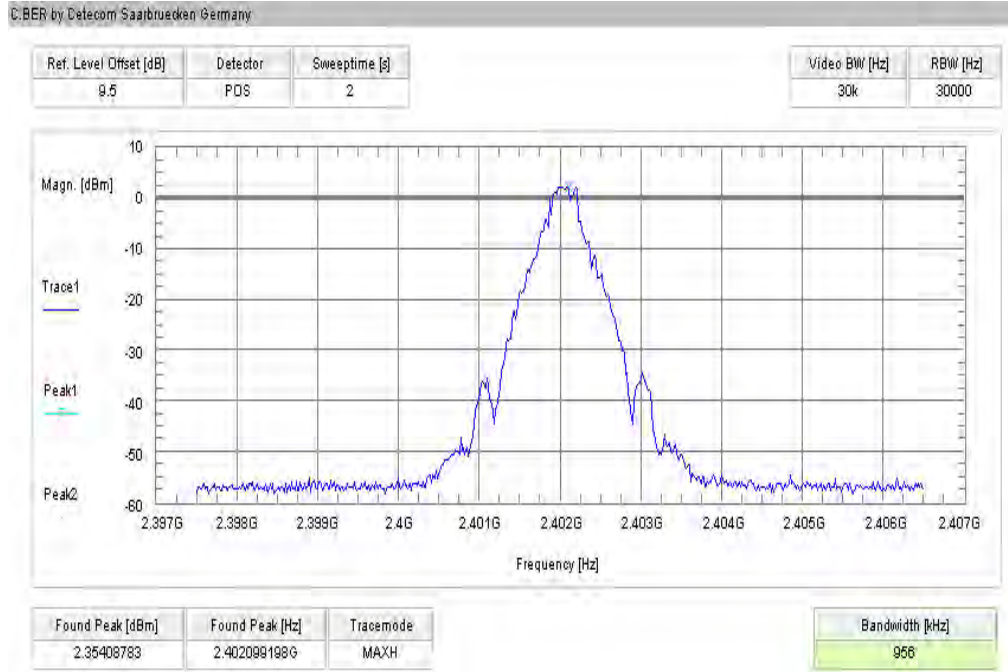

**Plot 2:** middle channel – 2441 MHz, GFSK modulation

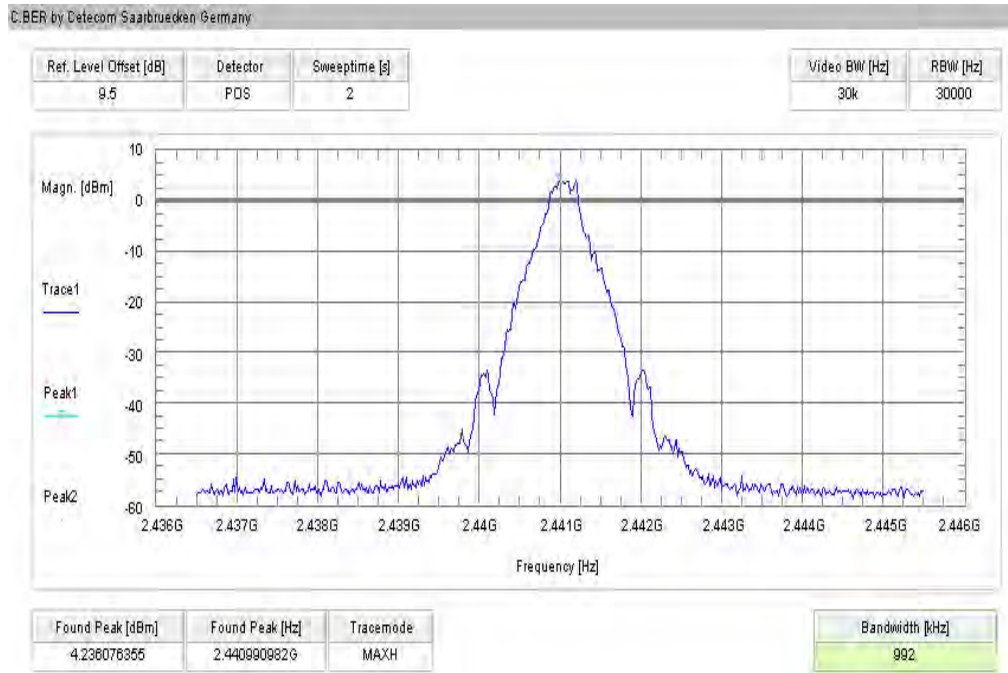

**Plot 3:** highest channel – 2480 MHz, GFSK modulation

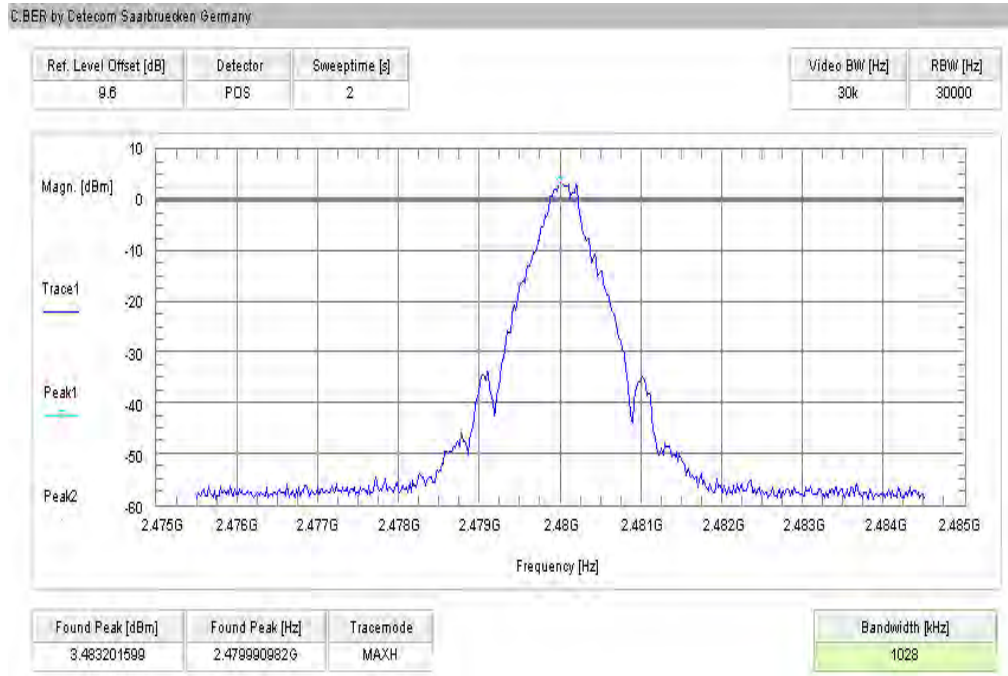

**Plot 4:** lowest channel – 2402 MHz, Pi / DQPSK modulation

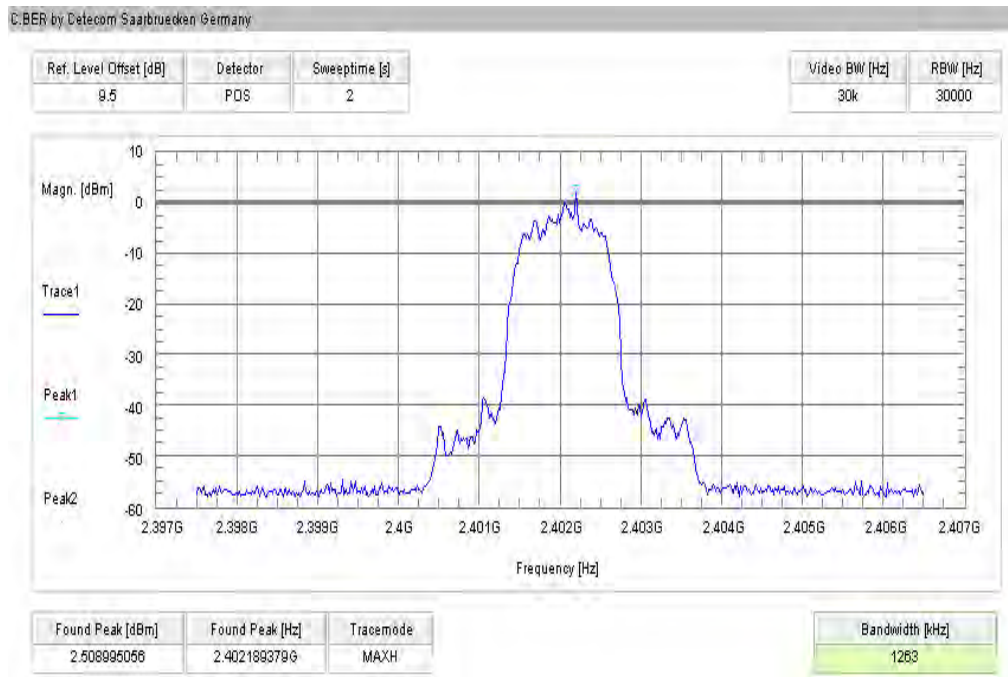

**Plot 5:** middle channel – 2441 MHz, Pi / DQPSK modulation

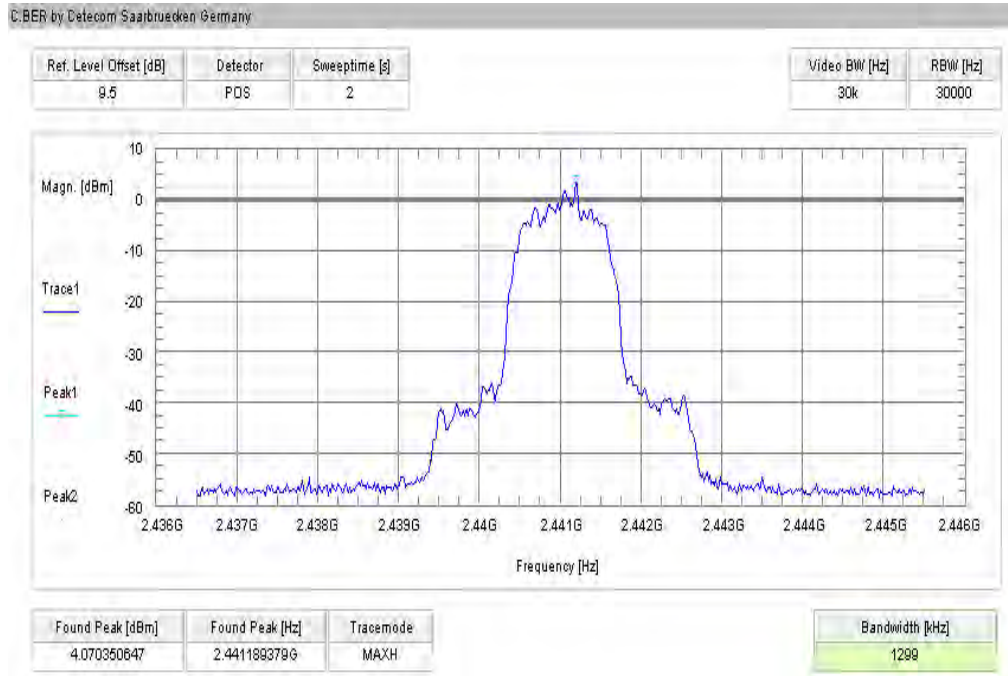

**Plot 6:** highest channel – 2480 MHz, Pi / DQPSK modulation

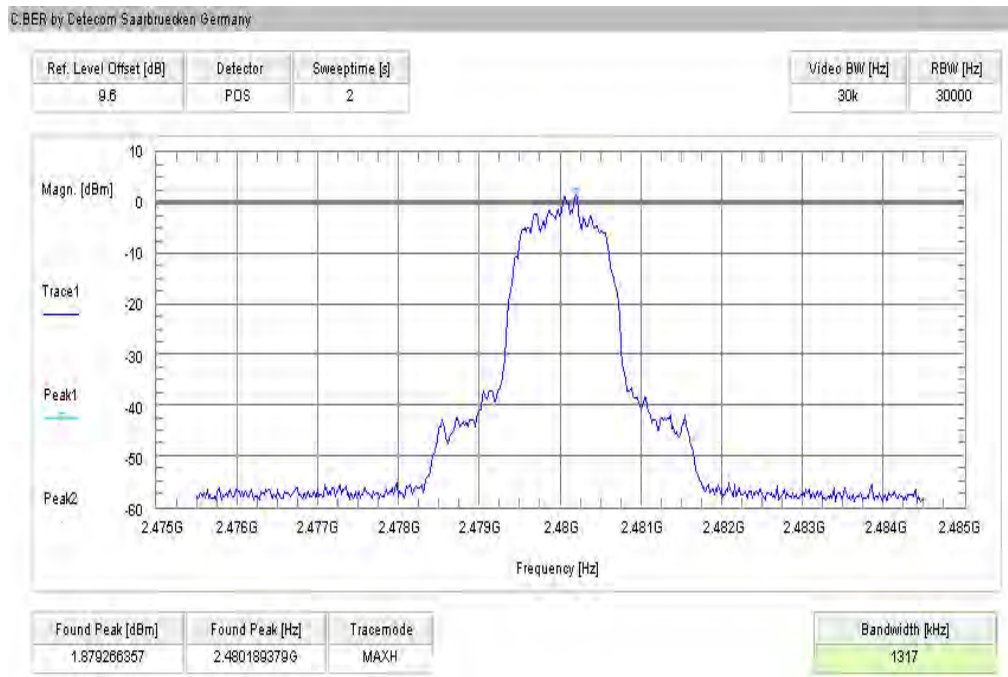

**Plot 7:** lowest channel – 2402 MHz, 8 DPSK modulation

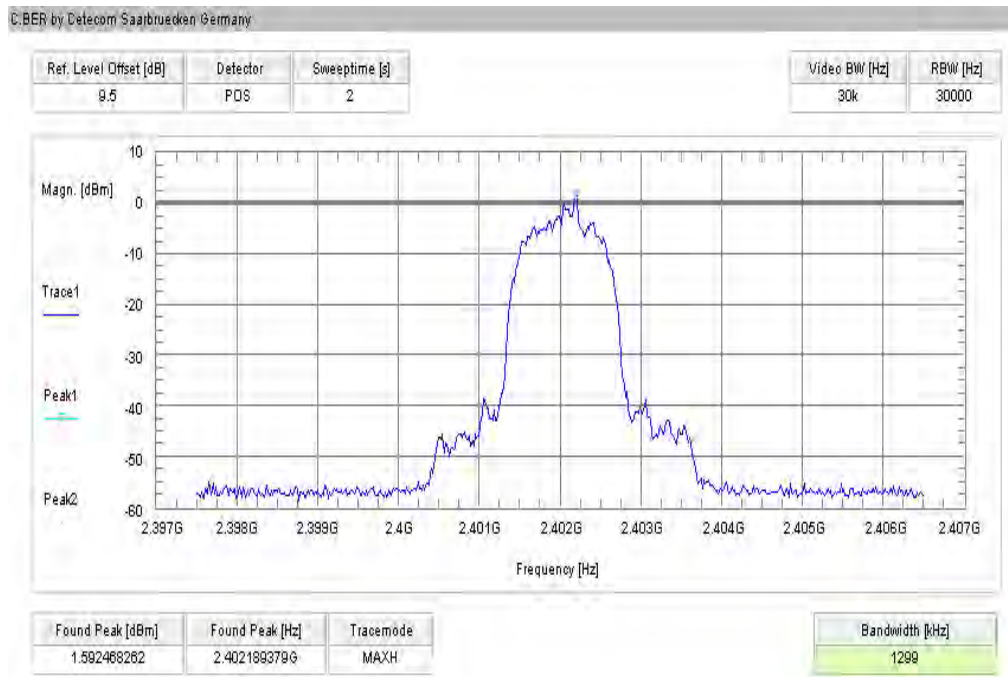

**Plot 8:** middle channel – 2441 MHz, 8 DPSK modulation

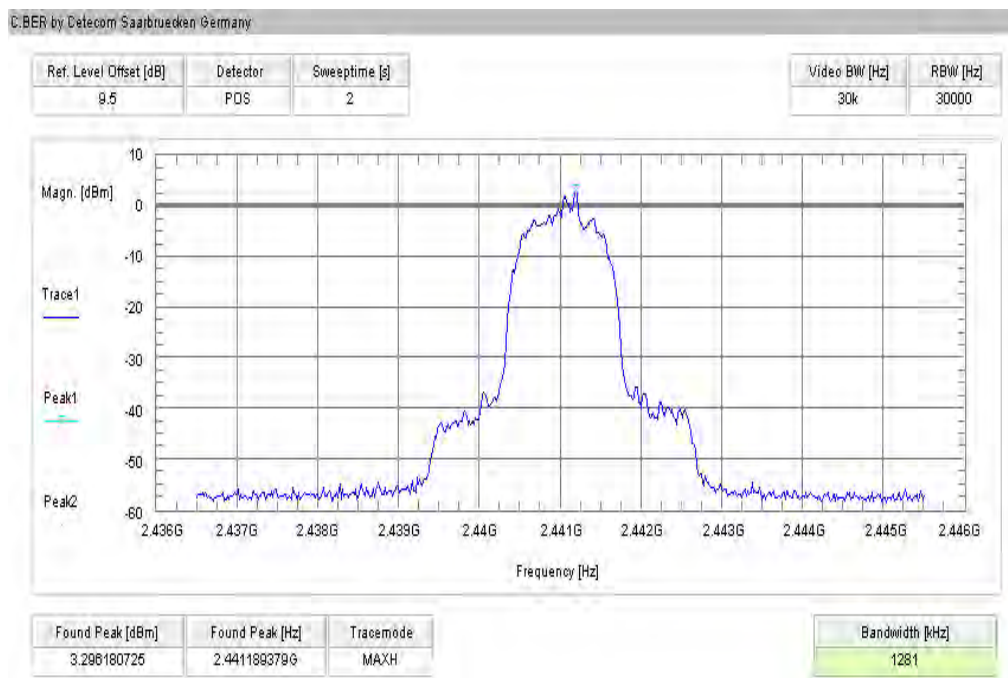



**Plot 9:** highest channel – 2480 MHz, 8 DPSK modulation

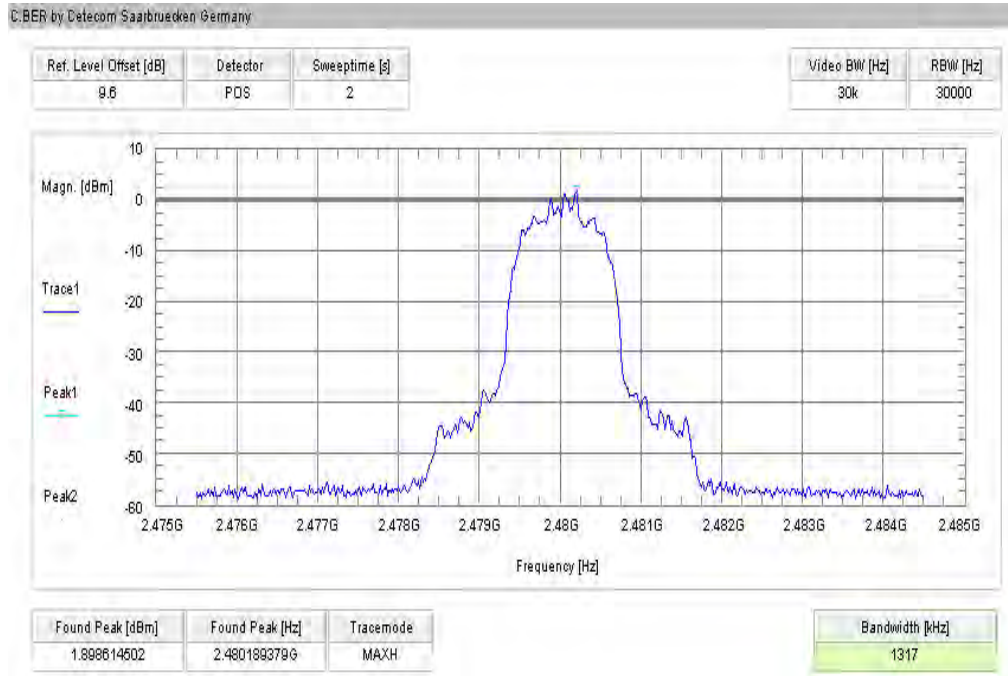

## 9.7 Maximum output power

**Description:**

Measurement of the maximum output power conducted and radiated. EUT in single channel mode.

**Measurement:**

Measurement parameter	
Detector:	Peak
Sweep time:	Auto
Video bandwidth:	3 MHz
Resolution bandwidth:	3 MHz
Span:	6 MHz
Trace-Mode:	Max Hold

**Limits:**

FCC	IC
Maximum output power	
[Conducted: 0.125 W – antenna gain max. 6 dBi] Systems using more than 75 hopping channels: Conducted: 1.0 W – antenna gain max. 6 dBi	

**Results:**

Modulation Frequency	Maximum output power conducted [dBm]		
	2402 MHz	2441 MHz	2480 MHz
GFSK	5.9	7.4	6.8
Pi/4 DQPSK	6.8	8.2	7.7
8DPSK	7.0	8.4	8.0
Measurement uncertainty	± 1 dB		

**Result:** Passed**Results:**

Modulation Frequency	Maximum output power radiated - EIRP [dBm]		
	2402 MHz	2441 MHz	2480 MHz
GFSK	6.4	5.0	3.2
Pi/4 DQPSK *)	7.3	5.8	4.1
8DPSK *)	7.5	6.0	4.4
Measurement uncertainty	± 3 dB		

\*) - Values calculated with antenna gain

**Result:** Passed

**Plots:**

**Plot 1:** lowest channel – 2402 MHz, GFSK modulation

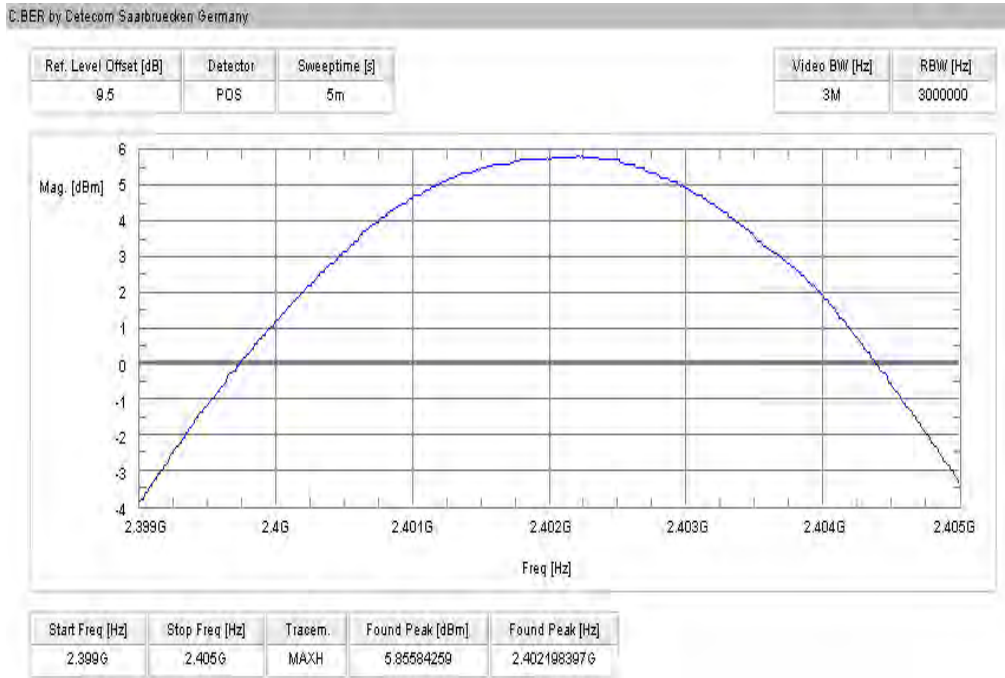

**Plot 2:** middle channel – 2441 MHz, GFSK modulation





**Plot 3:** highest channel – 2480 MHz, GFSK modulation

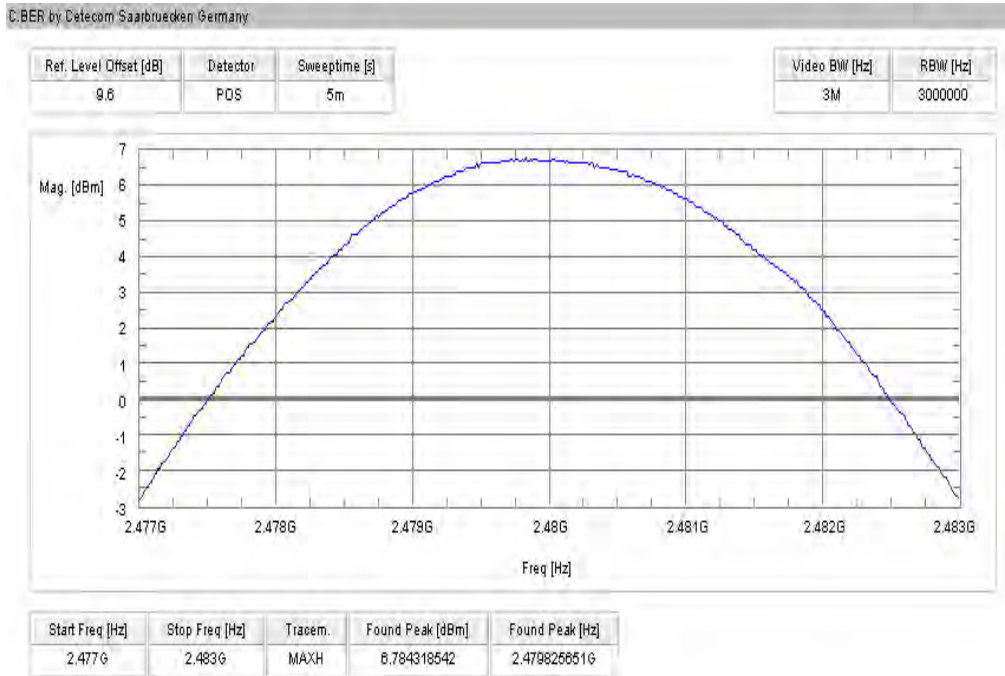

**Plot 4:** lowest channel – 2402 MHz, Pi / DQPSK modulation

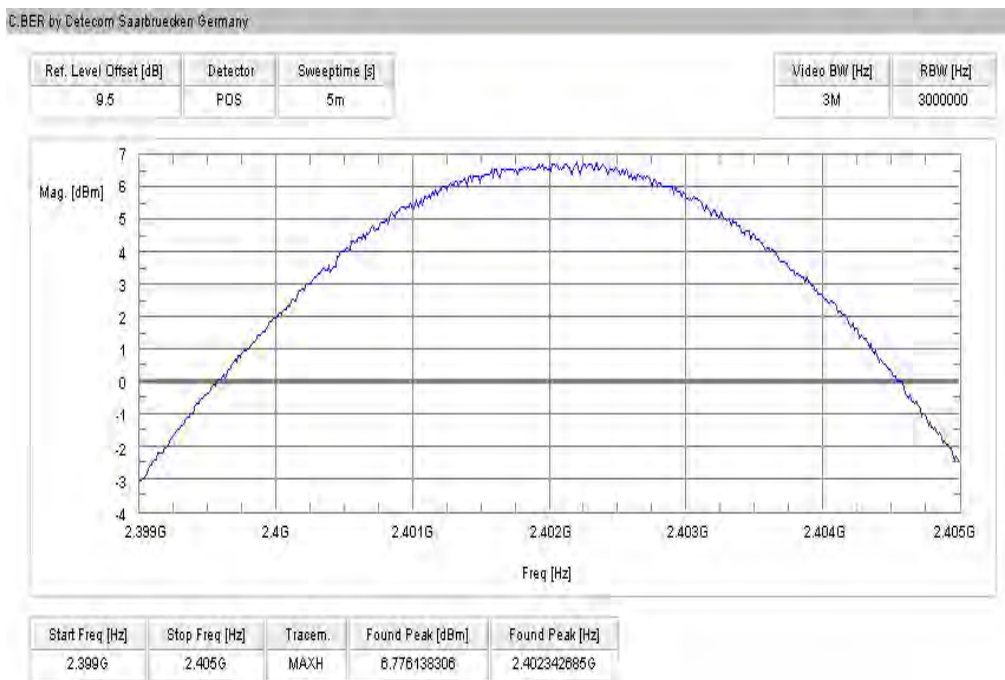

**Plot 5:** middle channel – 2441 MHz, Pi / DQPSK modulation

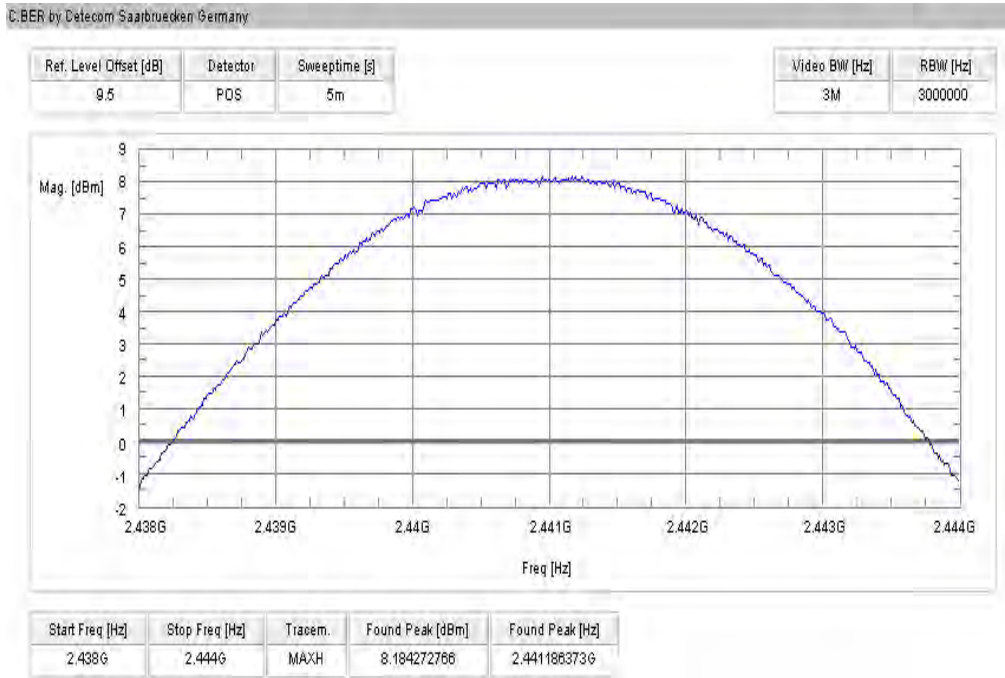

**Plot 6:** highest channel – 2480 MHz, Pi / DQPSK modulation

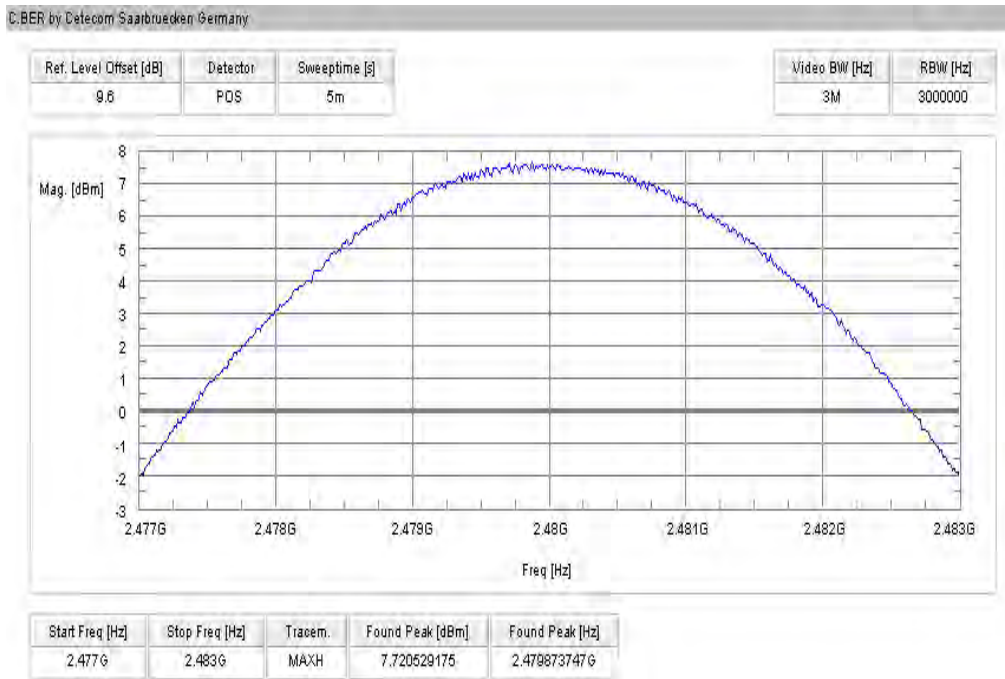

**Plot 7:** lowest channel – 2402 MHz, 8 DPSK modulation

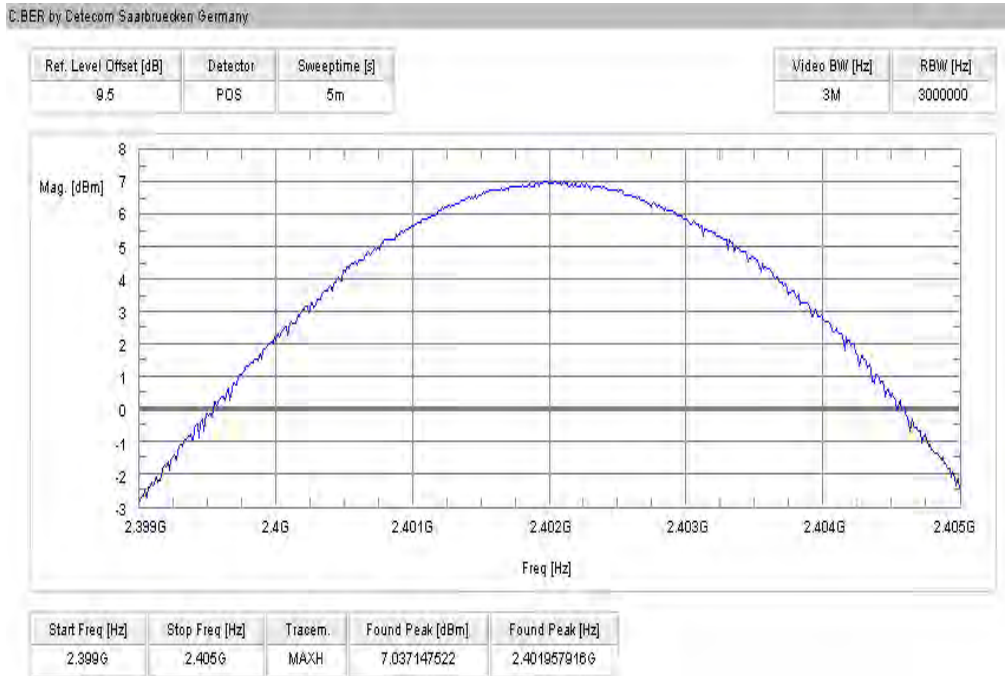

**Plot 8:** middle channel – 2441 MHz, 8 DPSK modulation

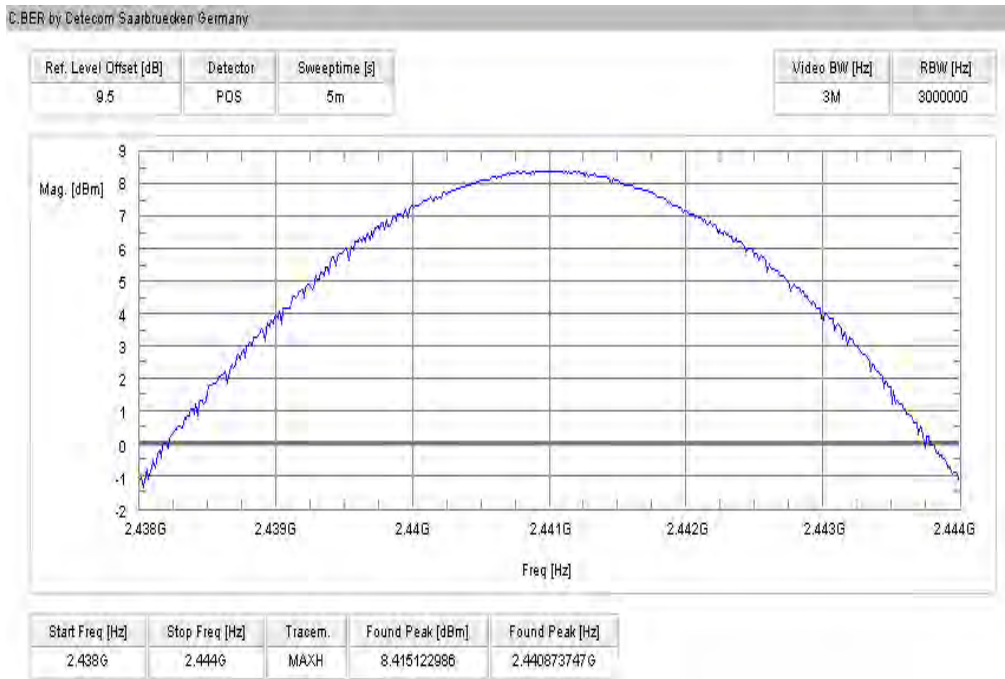

**Plot 9:** highest channel – 2480 MHz, 8 DPSK modulation

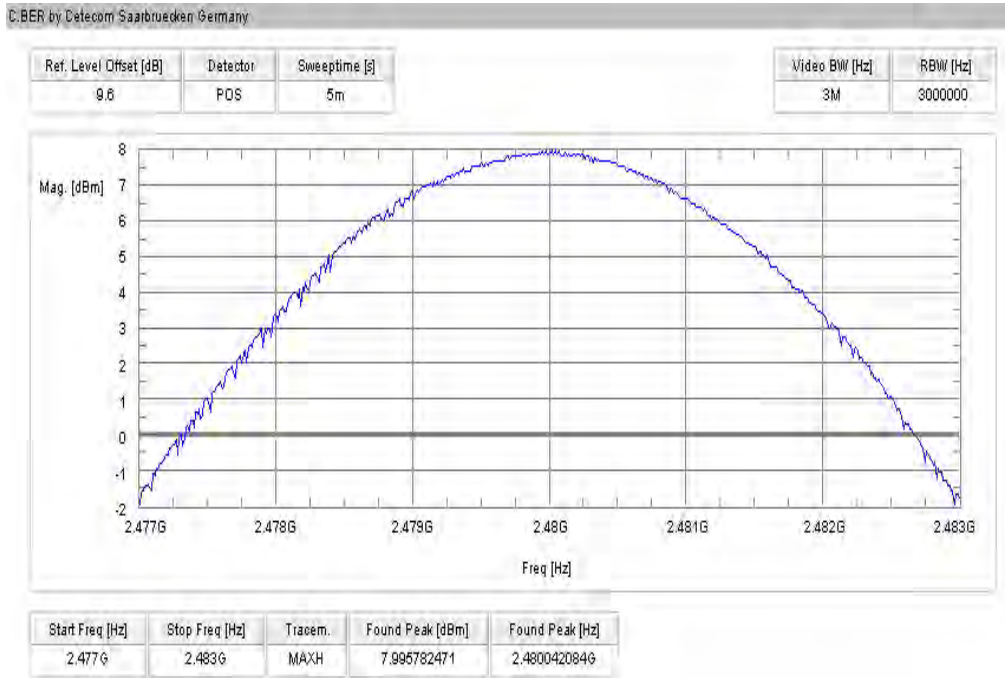

## 9.8 Band edge compliance conducted

### Description:

Measurement of the conducted band edge compliance. EUT is measured at the lower and upper band edge in single channel and hopping mode. The measurement is repeated for all modulations.

### Measurement:

Measurement parameter	
Detector:	Peak
Sweep time:	Auto
Video bandwidth:	100 kHz
Resolution bandwidth:	100 kHz
Span:	Lower Band Edge: 2395 – 2405 MHz Upper Band Edge: 2478 – 2489 MHz
Trace-Mode:	Max Hold

### Limits:

FCC	IC
Band edge compliance conducted	
<p>In any 100 kHz bandwidth outside the frequency band in which the spread spectrum or digitally modulated intentional radiator is operating, the radio frequency power that is produced by the intentional radiator shall be at least 20 dB below that in the 100 kHz bandwidth within the band that contains the highest level of the desired power, based on either an RF conducted or a radiated measurement. Attenuation below the general limits specified in Section 15.209(a) is not required.</p>	

### Results:

Scenario Modulation	Band edge compliance conducted [dB]		
	GFSK	Pi/4 DQPSK	8DPSK
Lower band edge – hopping off	> 20 dB	> 20 dB	> 20 dB
Lower band edge – hopping on	> 20 dB	> 20 dB	> 20 dB
Upper band edge – hopping off	> 20 dB	> 20 dB	> 20 dB
Upper band edge – hopping on	> 20 dB	> 20 dB	> 20 dB
Measurement uncertainty	± 1.5 dB		

**Result: Passed**



**Plots:**

**Plot 1: Lower band edge – hopping on, GFSK modulation**

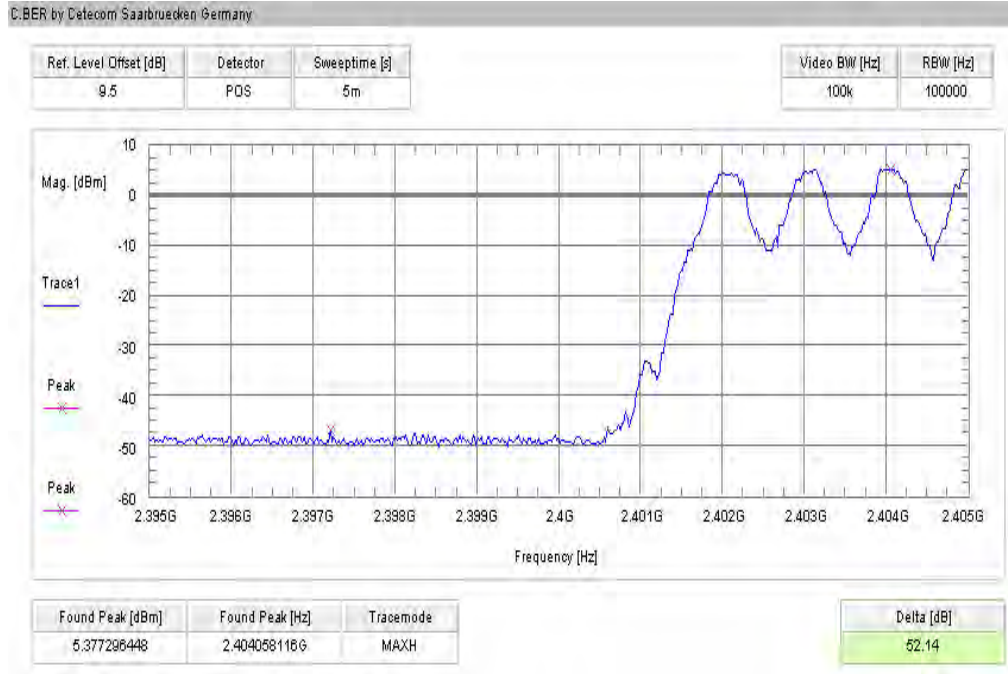

**Plot 2: Upper band edge – hopping on, GFSK modulation**

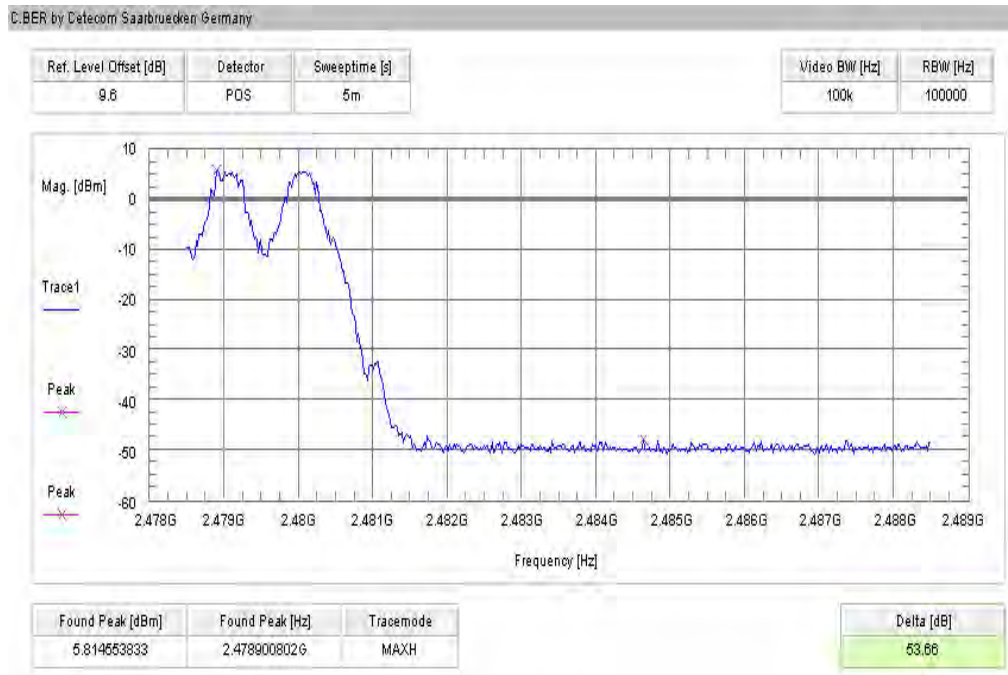

**Plot 3: Lower band edge – hopping off, GFSK modulation**

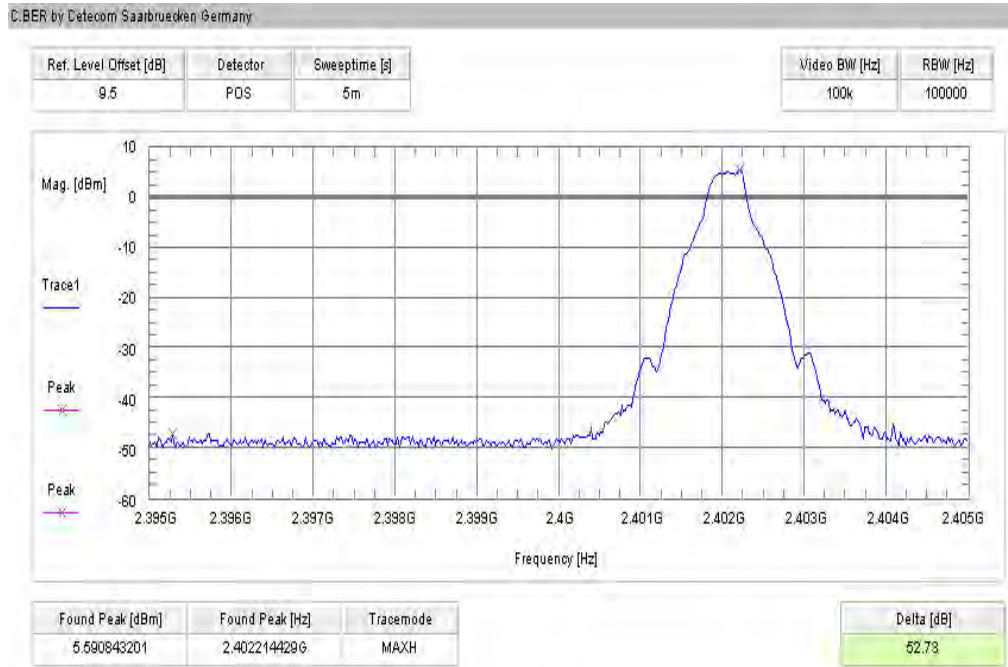

**Plot 4: Upper band edge – hopping off, GFSK modulation**

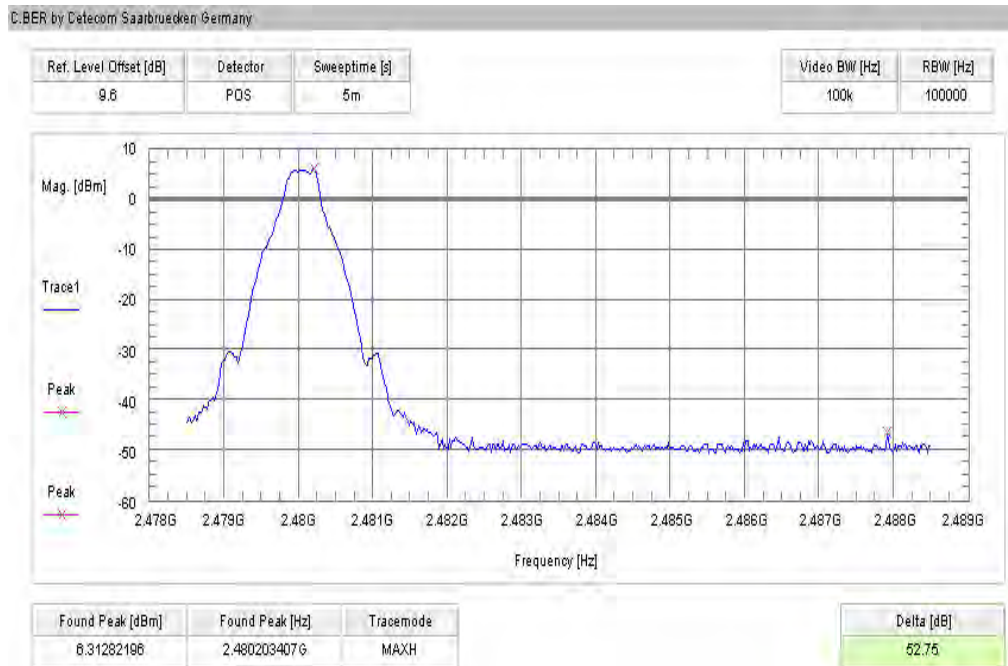

**Plot 5: Lower band edge – hopping on, Pi/4 DQPSK modulation**

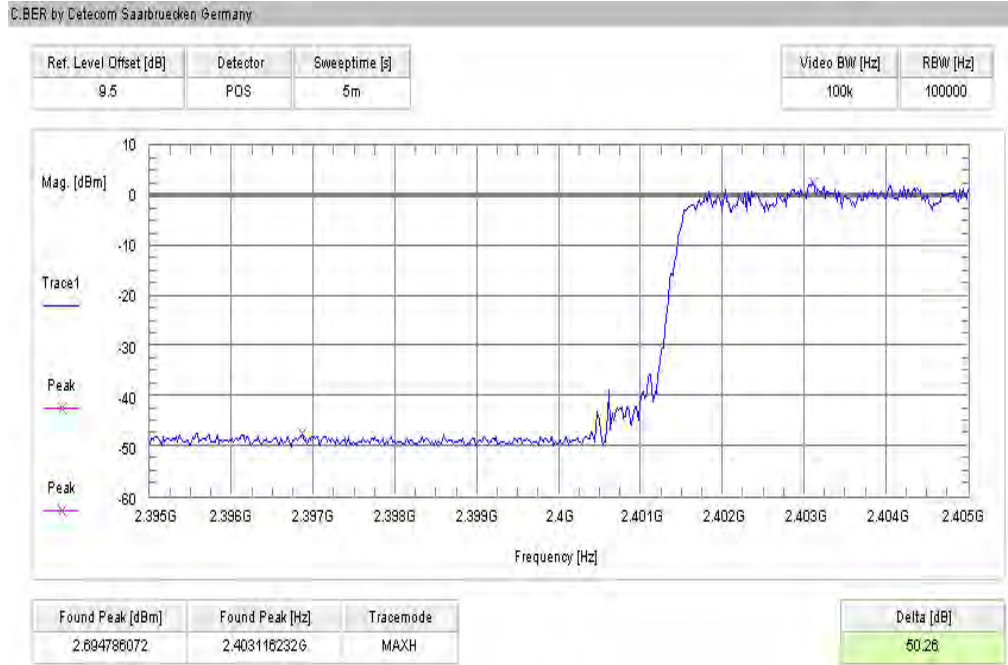

**Plot 6: Upper band edge – hopping on, Pi/4 DQPSK modulation**

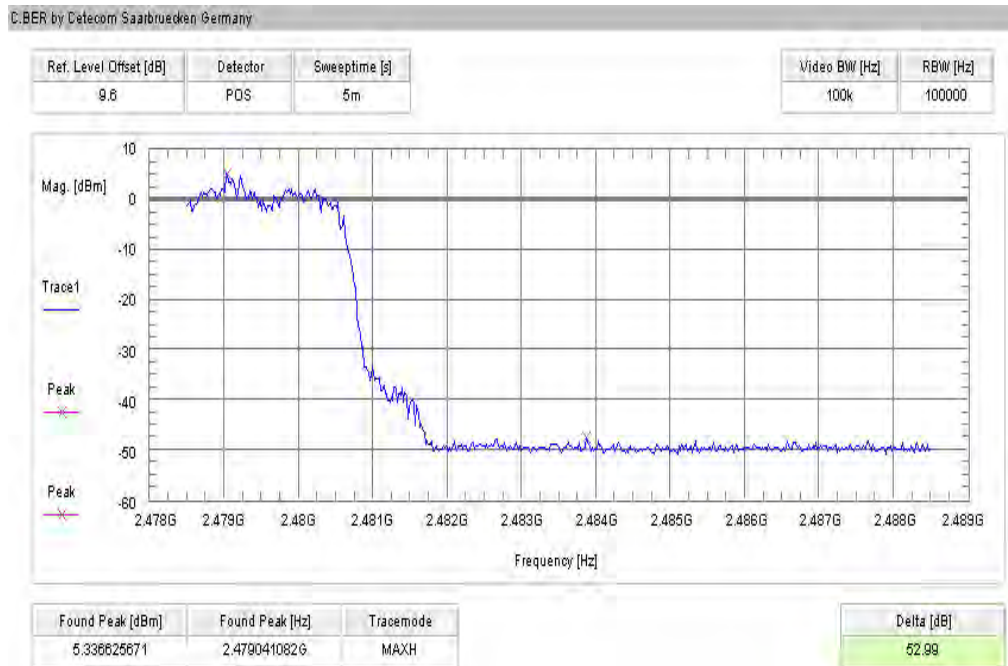

**Plot 7: Lower band edge – hopping off, Pi/4 DQPSK modulation**

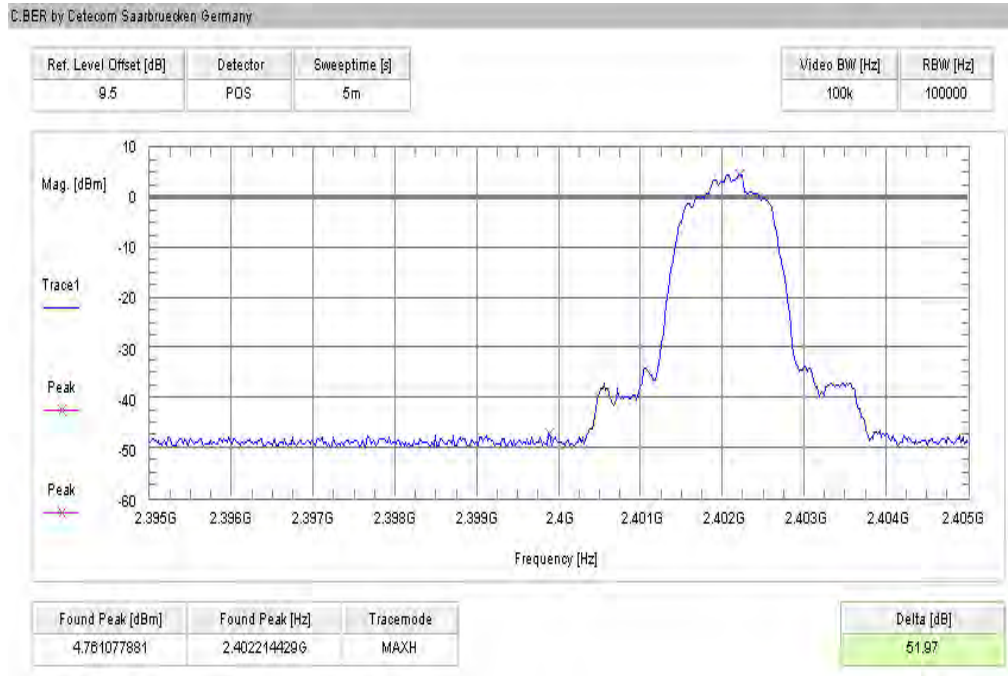

**Plot 8: Upper band edge – hopping off, Pi/4 DQPSK modulation**

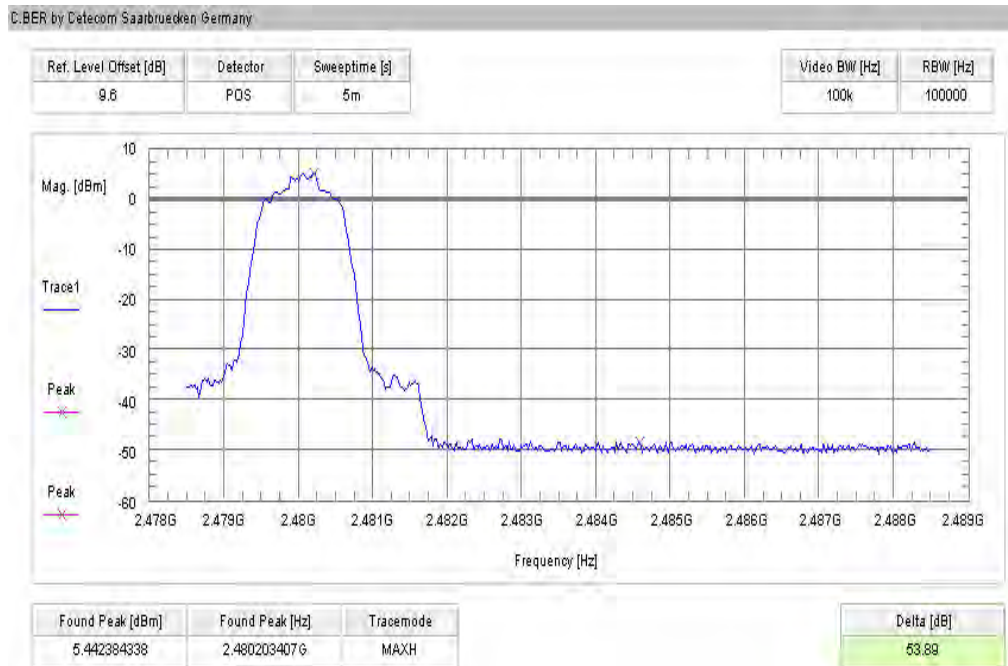



**Plot 9: Lower band edge – hopping on, 8DPSK modulation**

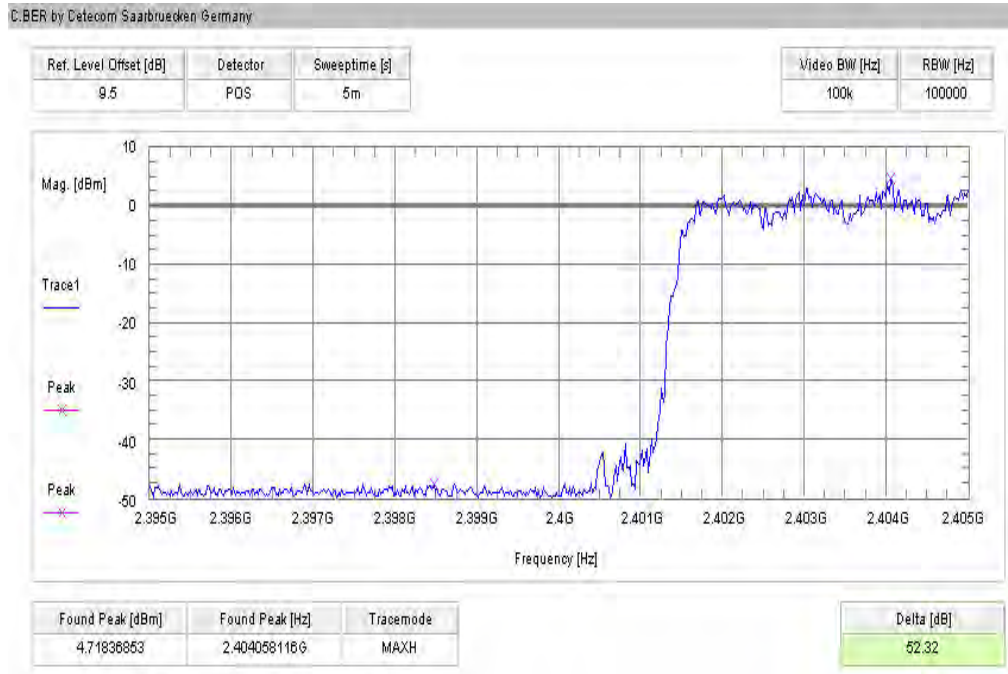

**Plot 10: Upper band edge – hopping on, 8DPSK modulation**

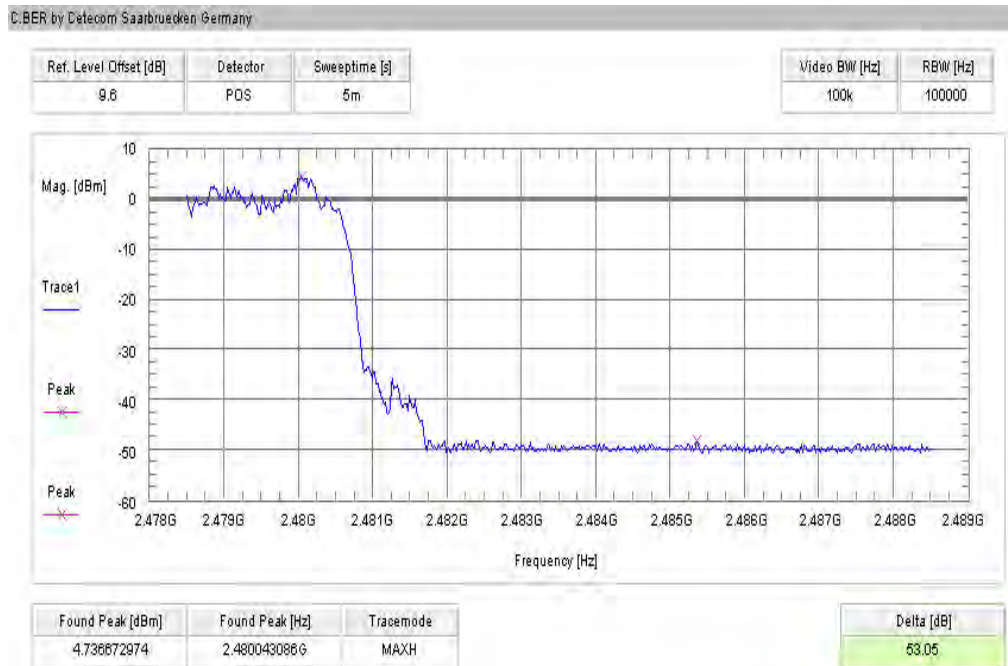

**Plot 11: Lower band edge – hopping off, 8DPSK modulation**

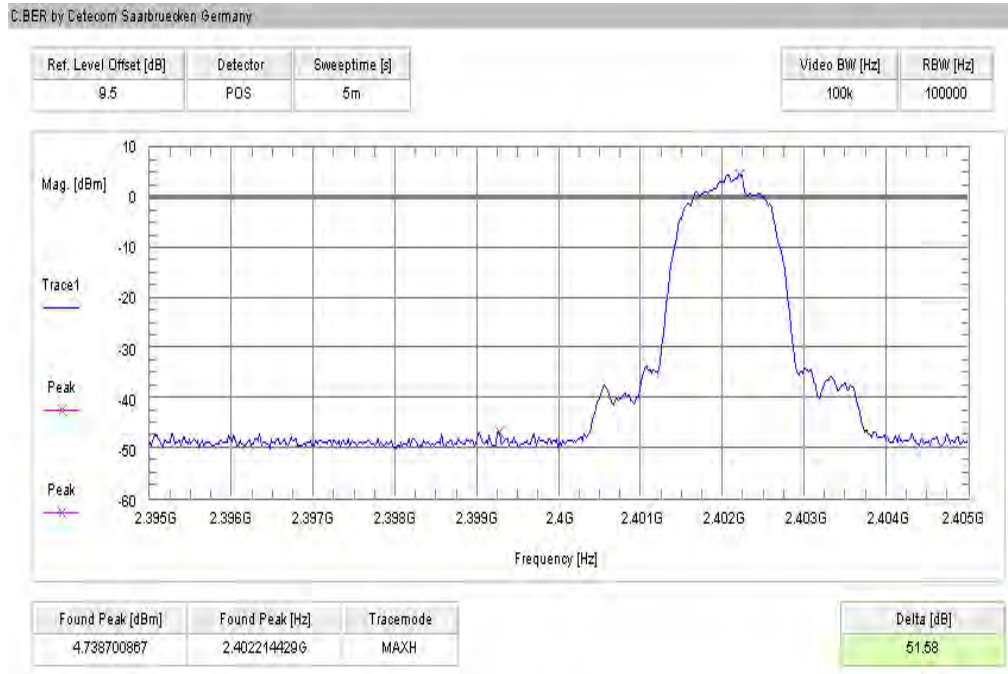

**Plot 12: Upper band edge – hopping off, 8DPSK modulation**

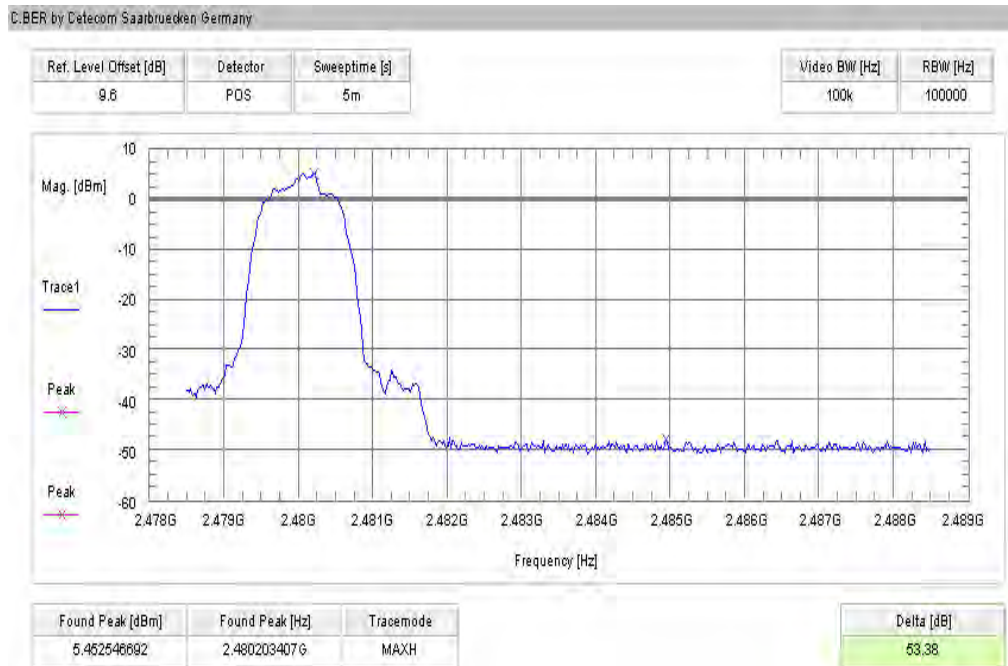



## 9.9 Band edge compliance radiated

### Description:

Measurement of the radiated band edge compliance. The EUT is turned in the position that results in the maximum level at the band edge. Then a sweep over the corresponding restricted band is performed. The EUT is set to single channel mode and the transmit channel is channel 00 for the lower restricted band and channel 78 for the upper restricted band. The measurement is repeated for all modulations. Measurement distance is 3m.

### Measurement:

Measurement parameter	
Detector:	Peak
Sweep time:	Auto
Video bandwidth:	1 MHz (Peak) / 10 Hz (AVG)
Resolution bandwidth:	1 MHz
Span:	Lower Band: 2370 – 2402 MHz Upper Band: 2480 – 2503.5 MHz
Trace-Mode:	Max Hold

### Limits:

FCC	IC
Band edge compliance radiated	
<p>In any 100 kHz bandwidth outside the frequency band in which the spread spectrum or digitally modulated intentional radiator is operating, the radio frequency power that is produced by the intentional radiator shall be at least 20 dB below that in the 100 kHz bandwidth within the band that contains the highest level of the desired power, based on either an RF conducted or a radiated measurement. Attenuation below the general limits specified in Section 15.209(a) is not required. In addition, radiated emissions which fall in the restricted bands, as defined in Section 15.205(a), must also comply with the radiated emission limits specified in Section 15.209(a) (see Section 5.205(c)).</p>	
54 dBµV/m AVG / 74 dBµV/m Peak	

### Results:

Scenario Modulation	Band edge compliance radiated [dBµV/m]		
	GFSK	Pi/4 DQPSK	8DPSK
Lower restricted band	< 54 / < 74	< 54 / < 74	< 54 / < 74
Upper restricted band	< 54 / < 74	< 54 / < 74	< 54 / < 74
Measurement uncertainty	± 3 dB		

**Result:** Passed

**Plots:**

**Plot 1:** Lower band edge, GFSK modulation, vertical & horizontal polarization

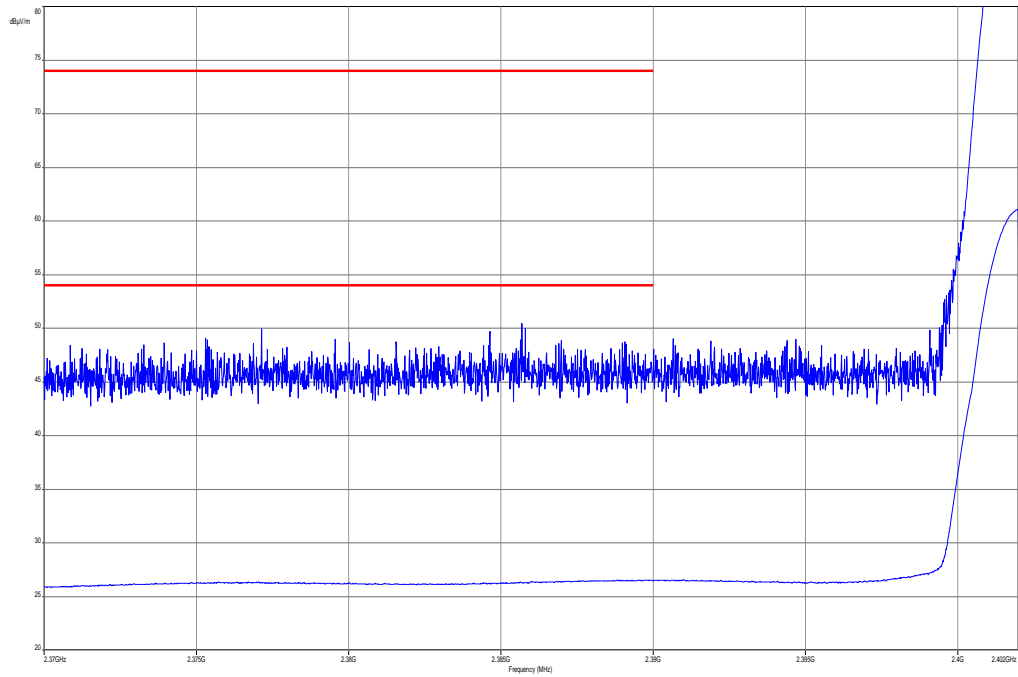

**Plot 2:** Upper band edge, GFSK modulation, vertical & horizontal polarization

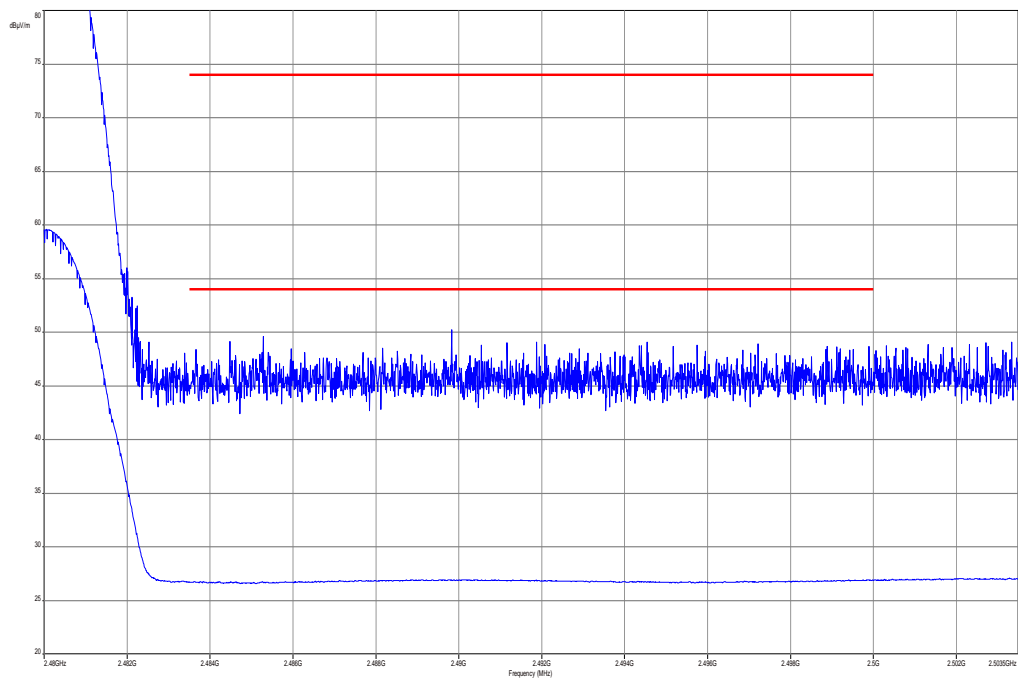

**Plot 3:** Lower band edge, Pi/4 DQPSK modulation, vertical & horizontal polarization

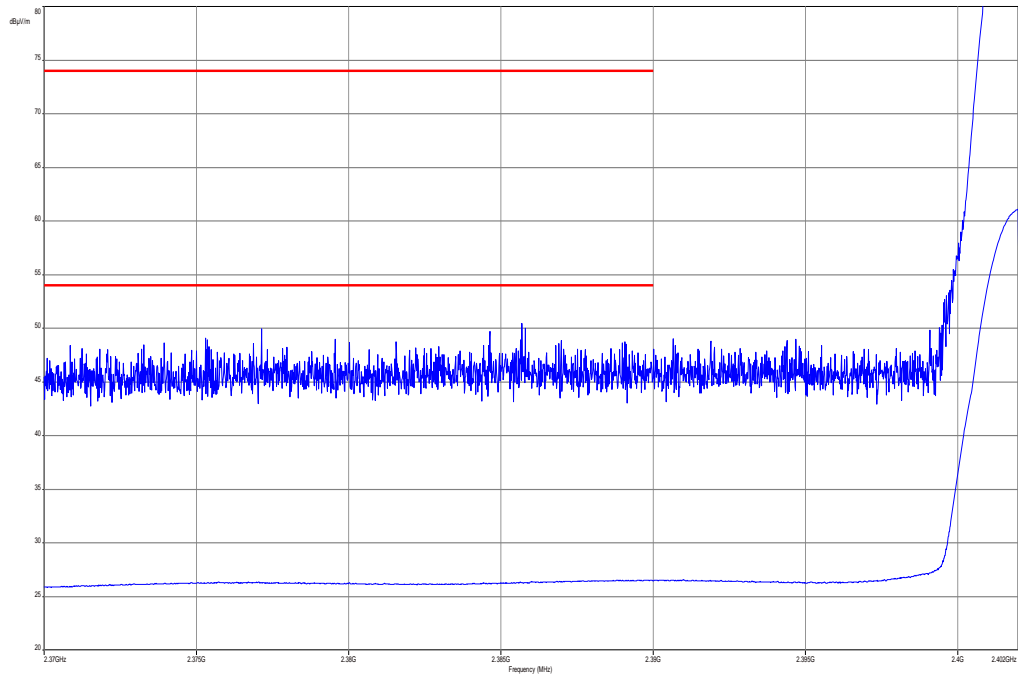

**Plot 4:** Upper band edge, Pi/4 DQPSK modulation, vertical & horizontal polarization

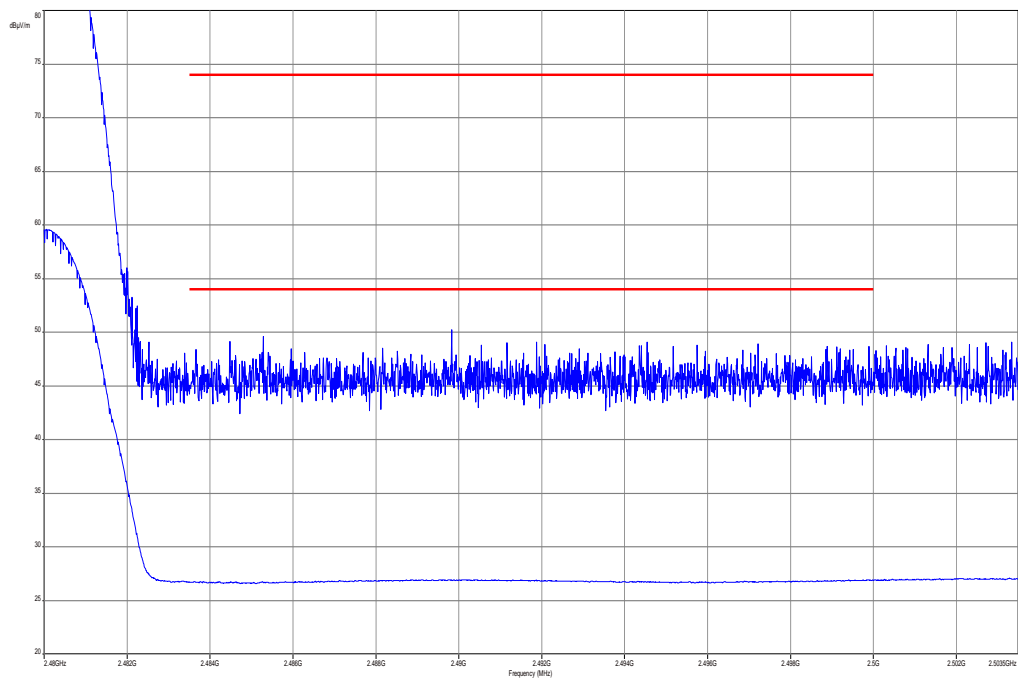

**Plot 5:** Lower band edge, 8 DPSK modulation, vertical & horizontal polarization

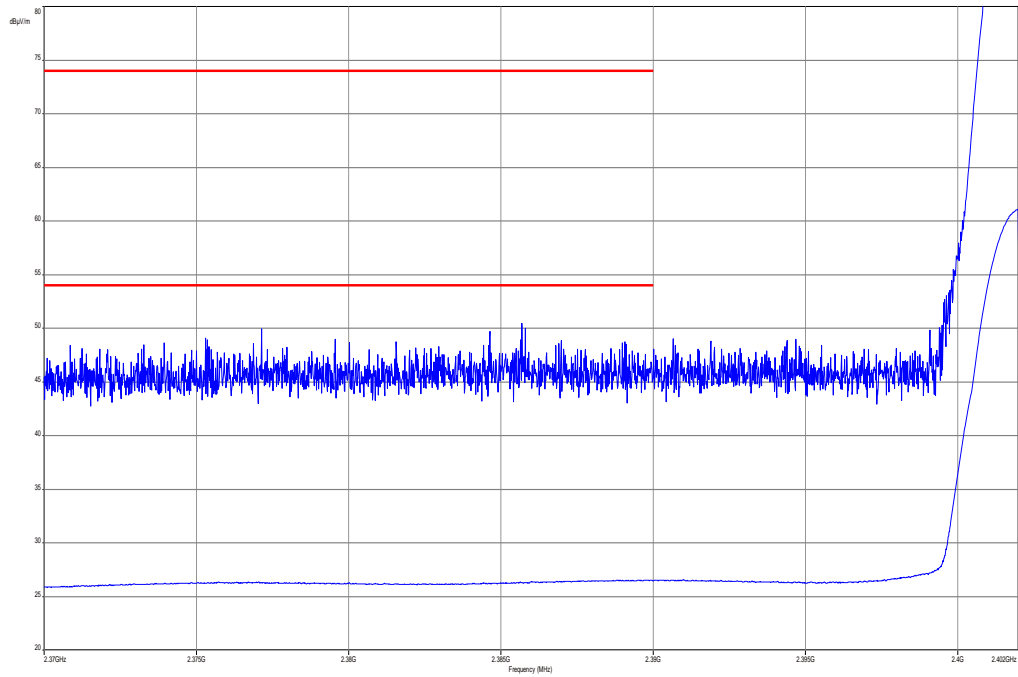

**Plot 6:** Upper band edge, 8 DPSK modulation, vertical & horizontal polarization

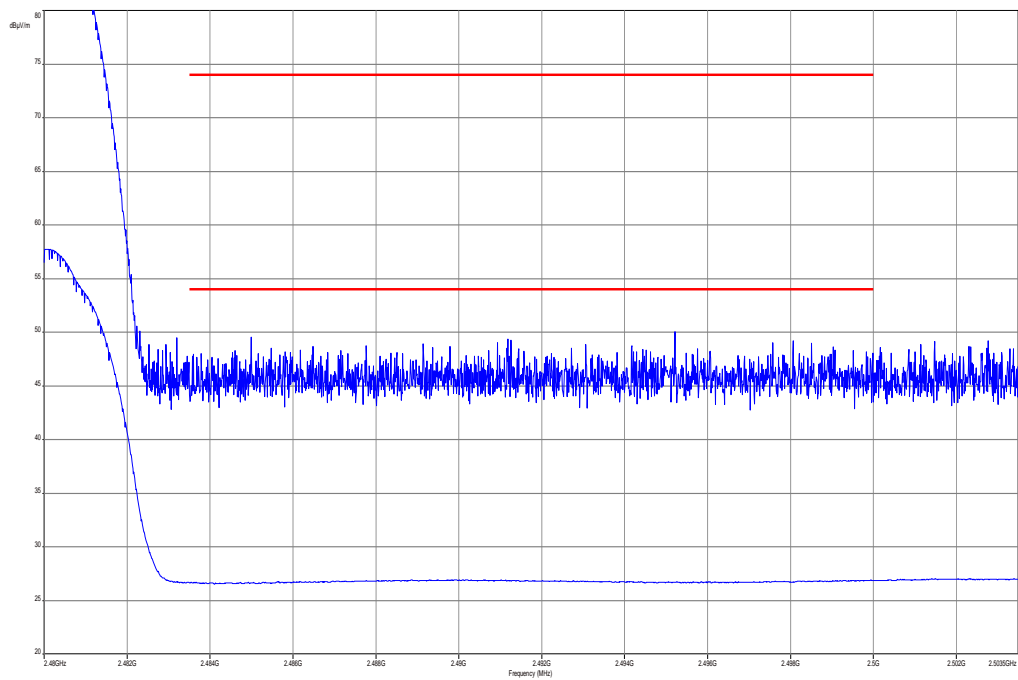

### 9.10 TX spurious emissions conducted

**Description:**

Measurement of the conducted spurious emissions in transmit mode. The EUT is set to single channel mode and the transmit channel is channel 00, channel 39 and channel 78. The measurement is repeated for all modulations.

**Measurement:**

Measurement parameter	
Detector:	Peak
Sweep time:	Auto
Video bandwidth:	F < 1 GHz: 100 kHz F > 1 GHz: 300 kHz
Resolution bandwidth:	F < 1 GHz: 100 kHz F > 1 GHz: 100 kHz
Span:	9 kHz to 25 GHz
Trace-Mode:	Max Hold

**Limits:**

FCC	IC
TX spurious emissions conducted	
In any 100 kHz bandwidth outside the frequency band in which the spread spectrum or digitally modulated intentional radiator is operating, the radio frequency power that is produced by the intentional radiator shall be at least 20 dB below that in the 100 kHz bandwidth within the band that contains the highest level of the desired power, based on either an RF conducted or a radiated measurement. Attenuation below the general limits specified in Section 15.209(a) is not required	

**Results:**

TX spurious emissions conducted					
GFSK - mode					
f [MHz]		amplitude of emission [dBm]	limit max. allowed emission power	actual attenuation below frequency of operation [dB]	results
2402		5.71	30 dBm		Operating frequency
<i>No critical peaks detected. All detected emissions are below the -20 dBc criteria.</i>			-20 dBc		complies
2441		7.21	30 dBm		Operating frequency
<i>No critical peaks detected. All detected emissions are below the -20 dBc criteria.</i>			-20 dBc		complies
2480		6.62	30 dBm		Operating frequency
<i>No critical peaks detected. All detected emissions are below the -20 dBc criteria.</i>			-20 dBc		complies
Measurement uncertainty		± 3 dB			

**Result: Passed**

**Results:**

TX spurious emissions conducted					
Pi/4-DQPSK - mode					
f [MHz]		amplitude of emission [dBm]	limit max. allowed emission power	actual attenuation below frequency of operation [dB]	results
2402		6.12	30 dBm		Operating frequency
<i>No critical peaks detected. All detected emissions are below the -20 dBc criteria.</i>			-20 dBc		complies
2441		7.54	30 dBm		Operating frequency
<i>No critical peaks detected. All detected emissions are below the -20 dBc criteria.</i>			-20 dBc		complies
2480		6.96	30 dBm		Operating frequency
<i>No critical peaks detected. All detected emissions are below the -20 dBc criteria.</i>			-20 dBc		complies
Measurement uncertainty		± 3dB			

**Result: Passed**



**Results:**

TX spurious emissions conducted					
8 DPSK - mode					
f [MHz]		amplitude of emission [dBm]	limit max. allowed emission power	actual attenuation below frequency of operation [dB]	results
2402		6.33	30 dBm		Operating frequency
<i>No critical peaks detected. All detected emissions are below the -20 dBc criteria.</i>			-20 dBc		complies
2441		7.70	30 dBm		Operating frequency
<i>No critical peaks detected. All detected emissions are below the -20 dBc criteria.</i>			-20 dBc		complies
2480		7.06	30 dBm		Operating frequency
<i>No critical peaks detected. All detected emissions are below the -20 dBc criteria.</i>			-20 dBc		complies
Measurement uncertainty		± 3dB			

**Result: Passed**

**Plots:**

**Plot 1:** lowest channel – 2402 MHz, GFSK modulation

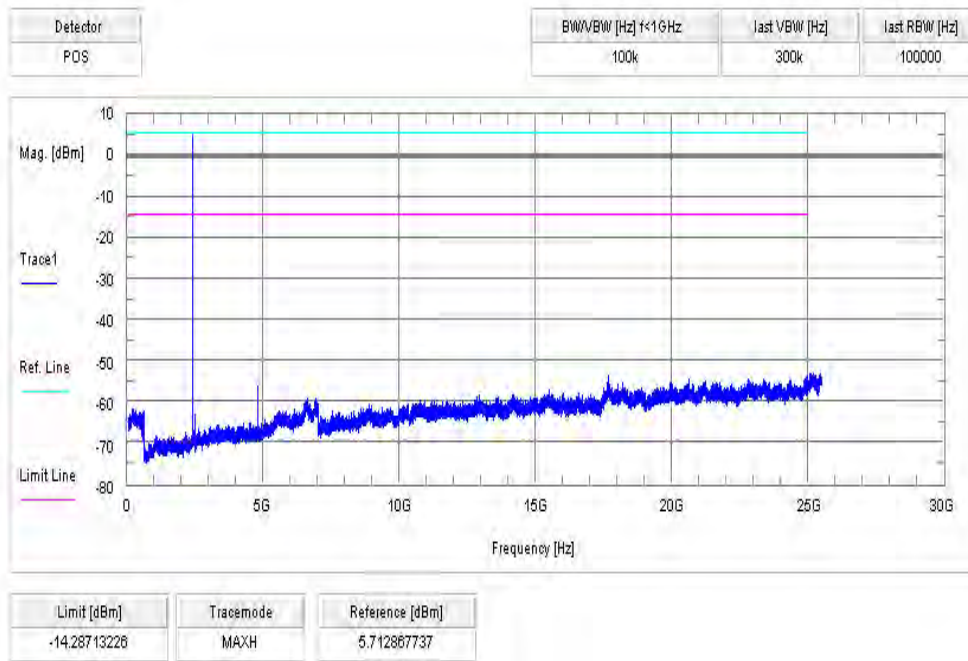

**Plot 2:** middle channel – 2441 MHz, GFSK modulation

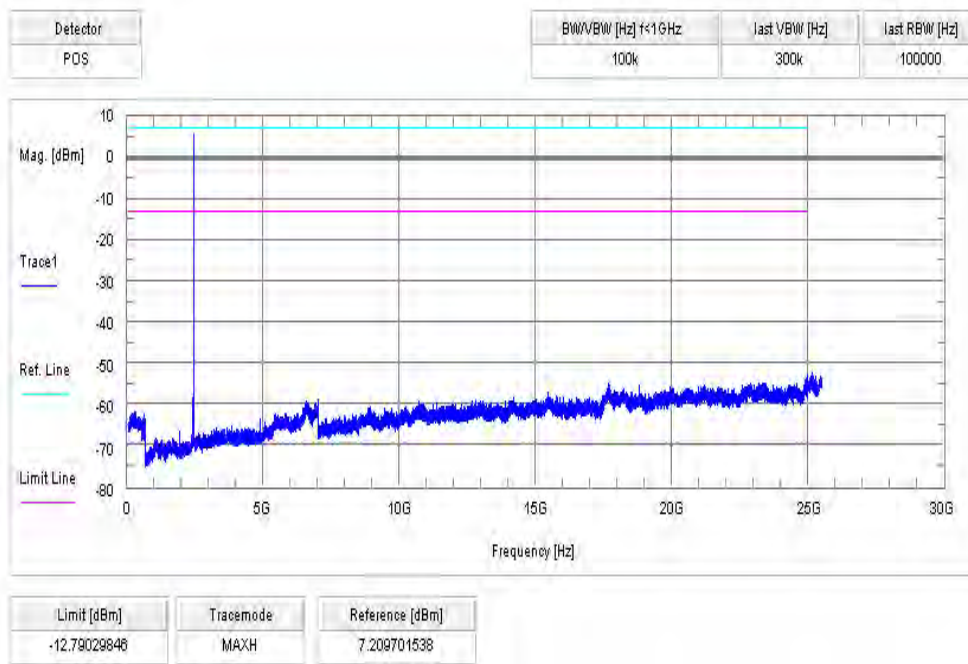

**Plot 3:** highest channel – 2480 MHz, GFSK modulation

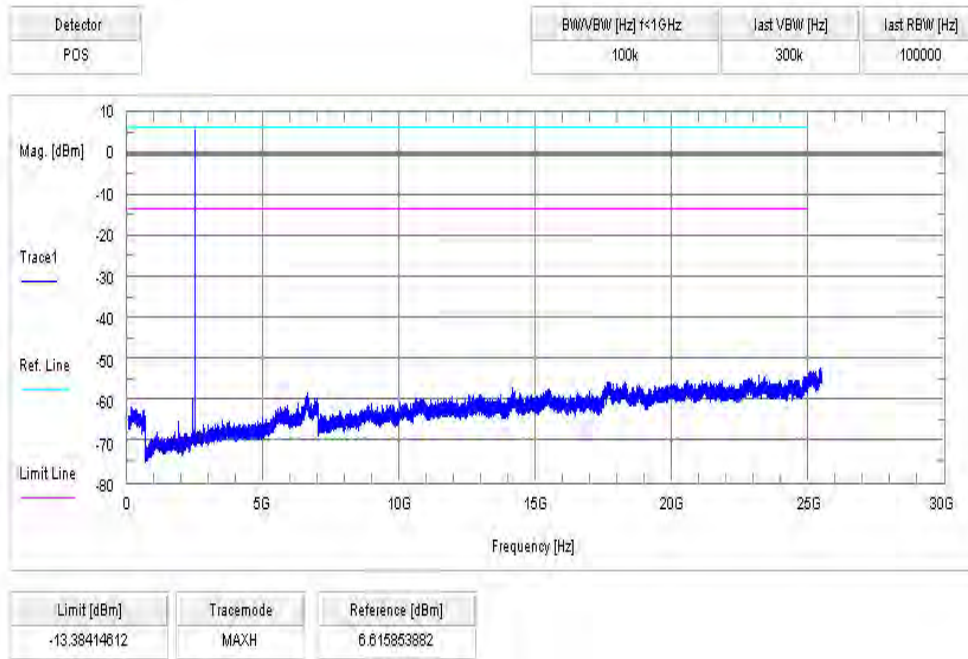

**Plot 4:** lowest channel – 2402 MHz, Pi / DQPSK modulation

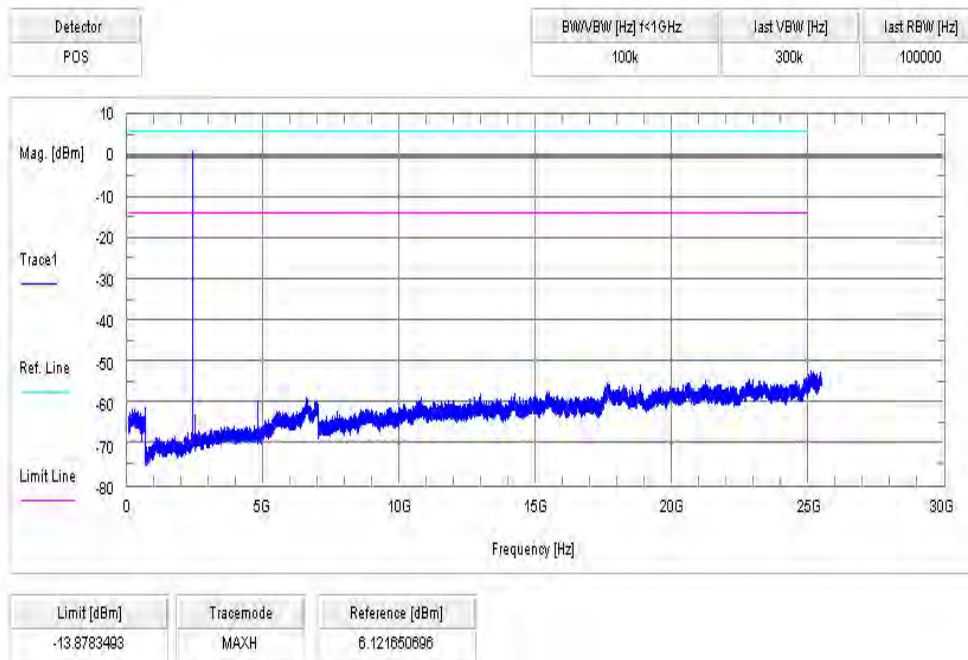

**Plot 5:** middle channel – 2441 MHz, Pi / DQPSK modulation

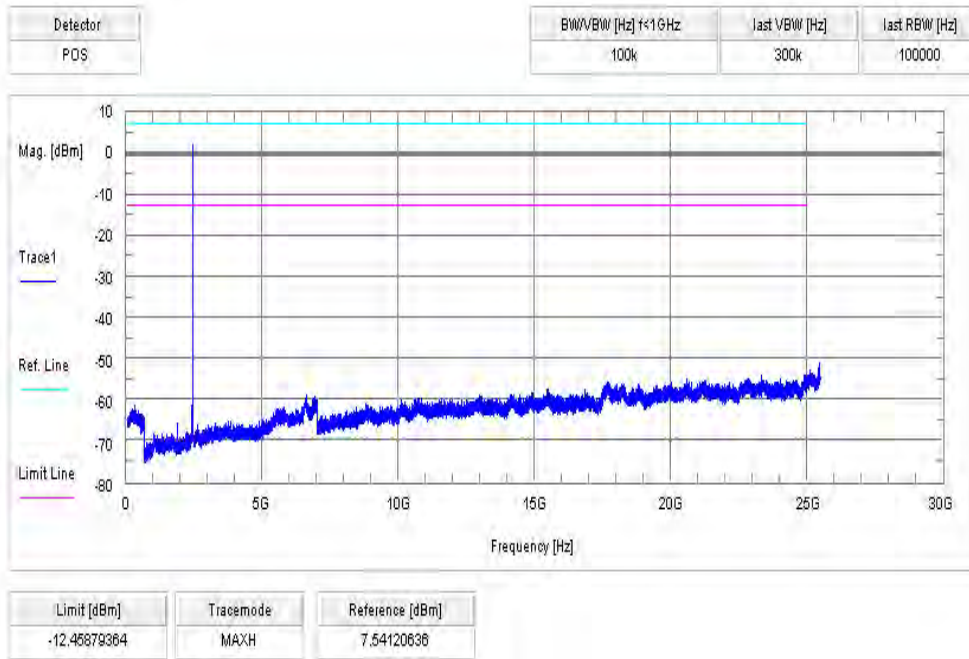

**Plot 6:** highest channel – 2480 MHz, Pi / DQPSK modulation

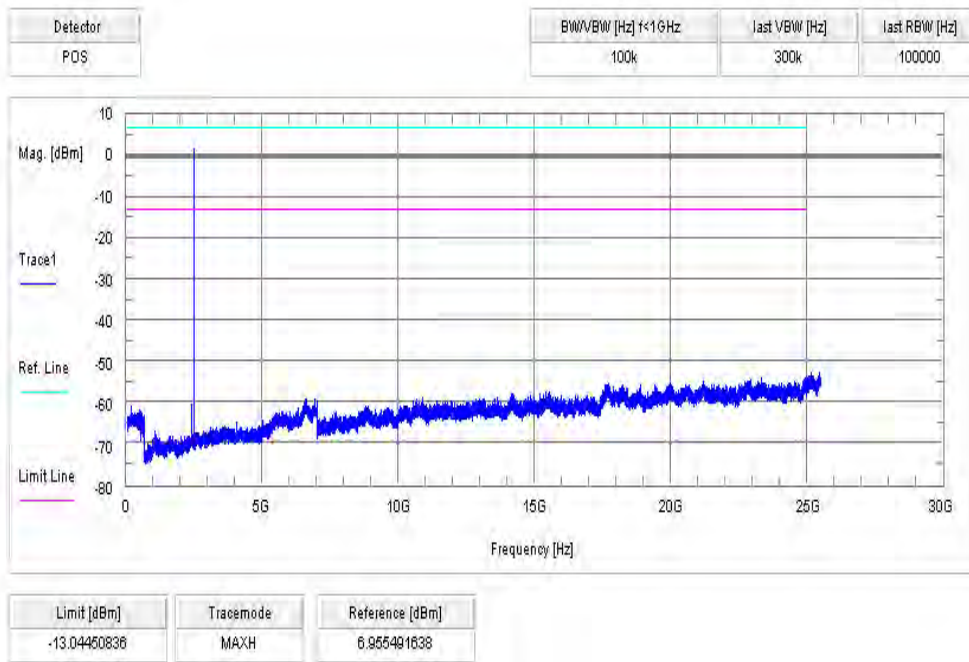

**Plot 7:** lowest channel – 2402 MHz, 8 DPSK modulation

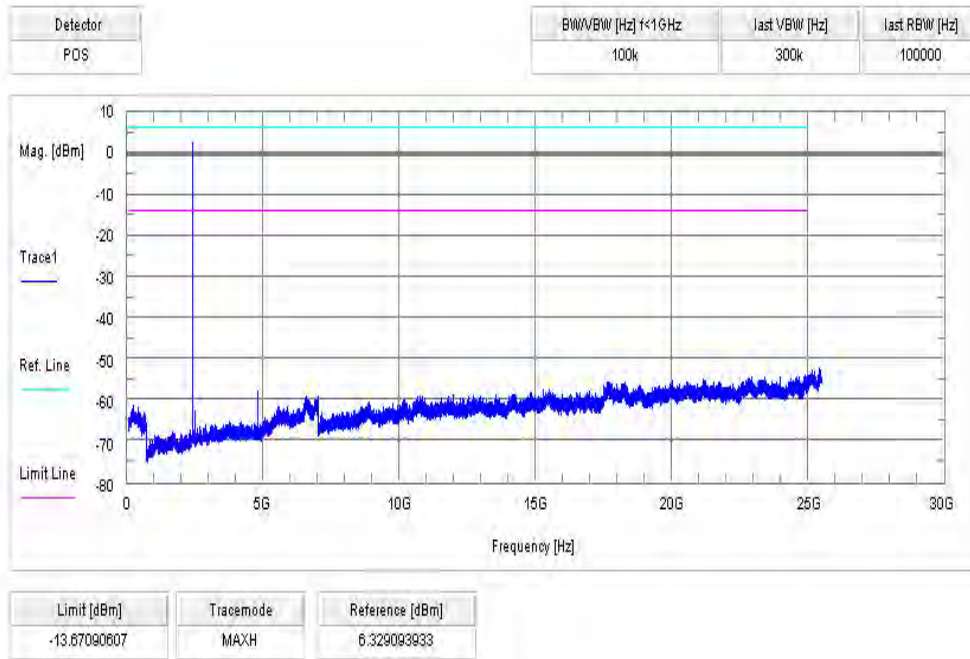

**Plot 8:** middle channel – 2441 MHz, 8 DPSK modulation

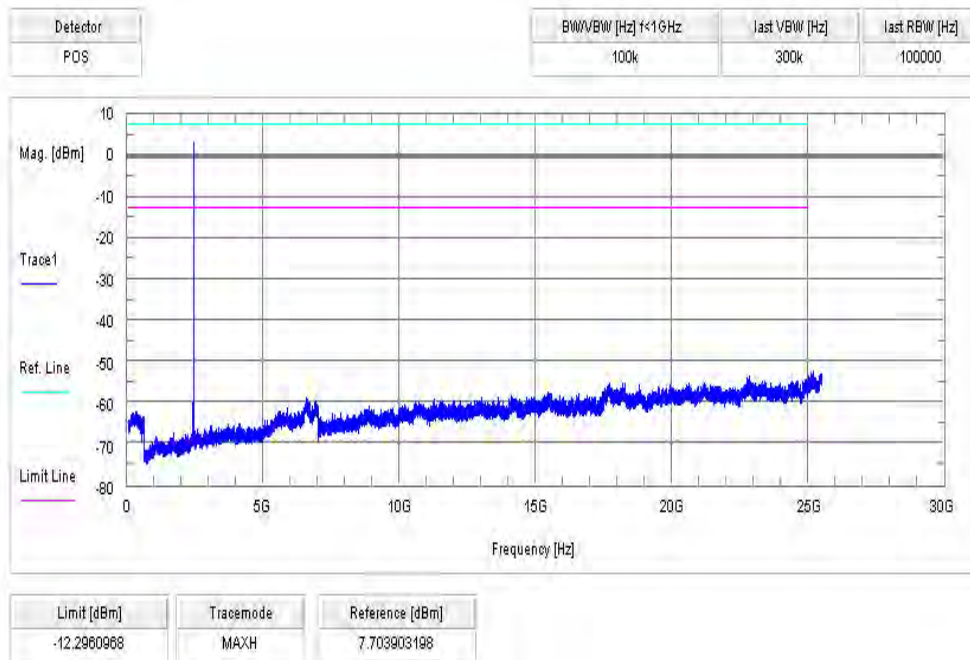



**Plot 9:** highest channel – 2480 MHz, 8 DPSK modulation

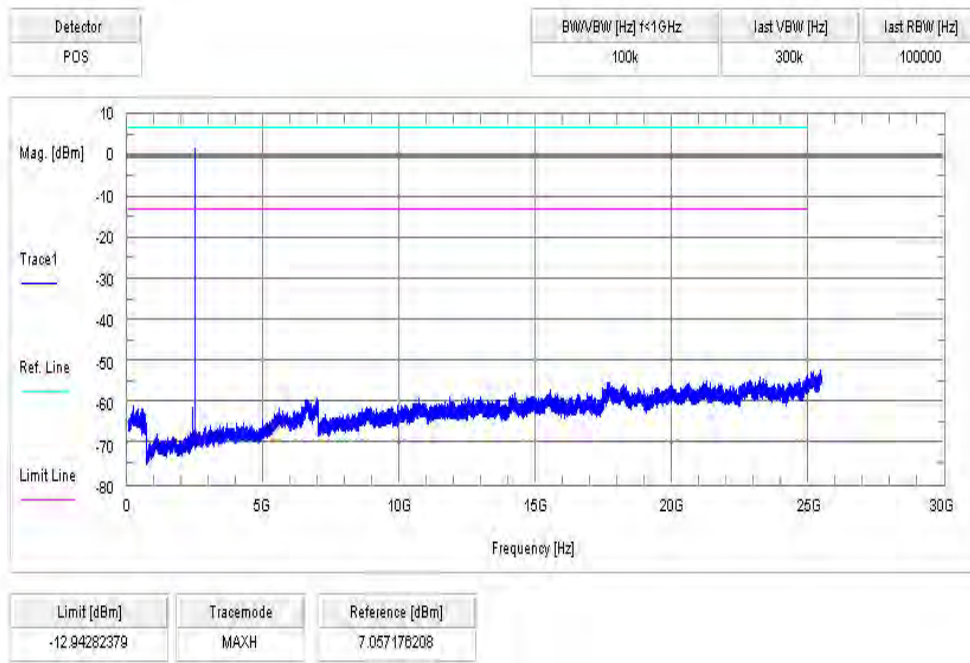



### 9.11 TX spurious emissions radiated

**Description:**

Measurement of the radiated spurious emissions in transmit mode. The EUT is set to single channel mode and the transmit channel is channel 00, channel 39 and channel 78. The measurement is performed in the mode with the highest output power.

**Measurement:**

Measurement parameter	
Detector:	Peak / Quasi Peak
Sweep time:	Auto
Video bandwidth:	Sweep: F < 1 GHz: 100 kHz F > 1 GHz: 1 MHz Remeasurement: 10 Hz
Resolution bandwidth:	F < 1 GHz: 100 kHz F > 1 GHz: 1 MHz
Span:	30 MHz to 25 GHz
Trace-Mode:	Max Hold
Measured Modulation:	<input type="checkbox"/> GFSK <input type="checkbox"/> Pi/4 DQPSK <input checked="" type="checkbox"/> 8DPSK

The modulation with the highest output power was used to perform the transmitter spurious emissions. If spurious were detected a re-measurement was performed on the detected frequency with each modulation.

**Limits:**

FCC		IC	
TX spurious emissions radiated			
In any 100 kHz bandwidth outside the frequency band in which the spread spectrum or digitally modulated intentional radiator is operating, the radio frequency power that is produced by the intentional radiator shall be at least 20 dB below that in the 100 kHz bandwidth within the band that contains the highest level of the desired power, based on either an RF conducted or a radiated measurement. Attenuation below the general limits specified in Section 15.209(a) is not required. In addition, radiated emissions which fall in the restricted bands, as defined in §15.205(a), must also comply with the radiated emission limits specified in §15.209(a) (see §15.205(c)).			
§15.209			
Frequency (MHz)	Field strength (dBµV/m)	Measurement distance	
30 - 88	30.0	10	
88 – 216	33.5	10	
216 – 960	36.0	10	
Above 960	54.0	3	

**Results:**

TX spurious emissions radiated [dB $\mu$ V/m]								
2402 MHz			2441 MHz			2480 MHz		
F [MHz]	Detector	Level [dB $\mu$ V/m]	F [MHz]	Detector	Level [dB $\mu$ V/m]	F [MHz]	Detector	Level [dB $\mu$ V/m]
For emissions below 1 GHz, please take a look at the table below the 1 GHz.			For emissions below 1 GHz, please take a look at the table below the 1 GHz.			For emissions below 1 GHz, please take a look at the table below the 1 GHz.		
For emissions above 1 GHz, please take a look at the plots.			For emissions above 1 GHz, please take a look at the plots.			For emissions above 1 GHz, please take a look at the plots.		
Measurement uncertainty			$\pm 3$ dB					

**Result:** Passed

**Plots:**

**Plot 1:** 30 MHz to 1 GHz, TX mode, channel 00, vertical & horizontal polarization

**Common Information**

EUT: PM-0240-BV  
 Serial Number: CB5121SWDK  
 Test Description: FCC part 15 class B @ 10 m  
 Operating Conditions: BT (EDR) TX Ch. 0 + charging  
 Operator Name: Medrow  
 Comment: AC: 115 V / 60 Hz

**Scan Setup: STAN\_Fin [EMI radiated]**

Hardware Setup: Electric Field (NOS)  
 Receiver: [ESCI 3]  
 Level Unit: dBµV/m

Subrange	Step Size	Detectors	IF BW	Meas. Time	Preamp
30 MHz - 2 GHz	60 kHz	QPK	120 kHz	1 s	20 dB

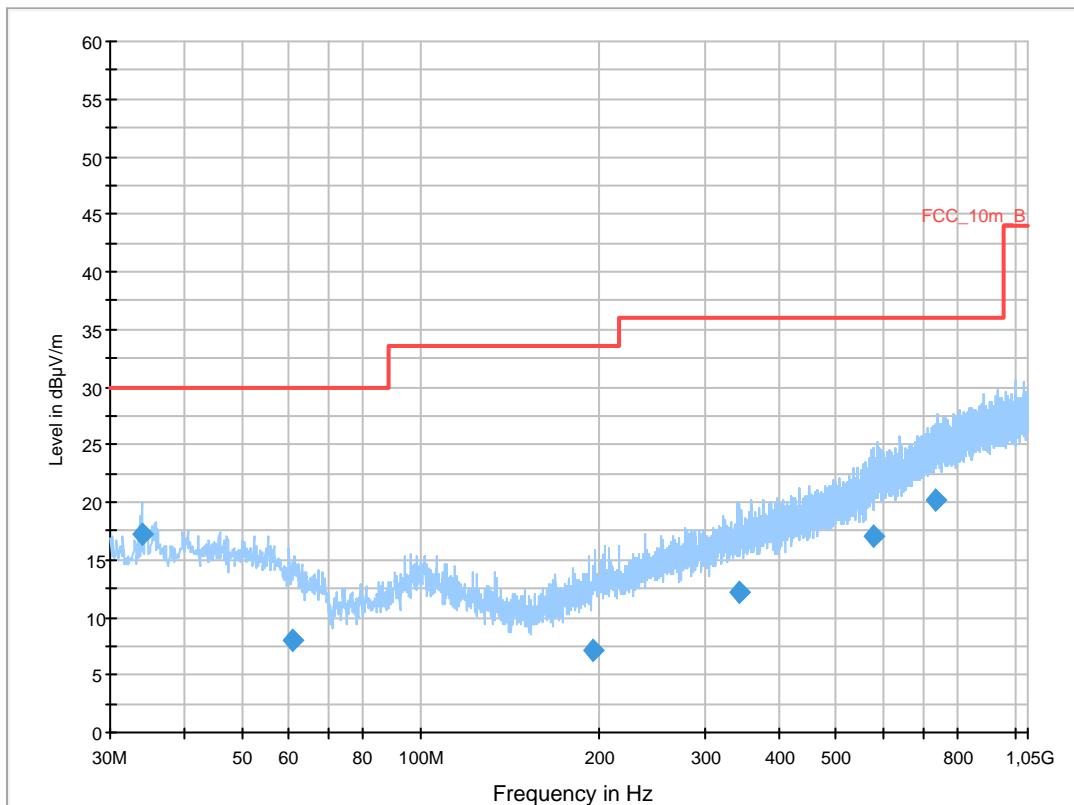

**Final Result 1**

Frequency (MHz)	QuasiPeak (dBµV/m)	Meas. Time (ms)	Bandwidth (kHz)	Height (cm)	Polarization	Azimuth (deg)	Corr. (dB)	Margin (dB)	Limit (dBµV/m)	Comment
34.037100	17.2	1000.0	120.000	114.0	V	10.0	12.9	12.8	30.0	
60.656250	7.9	1000.0	120.000	170.0	H	274.0	11.5	22.1	30.0	
195.490200	7.2	1000.0	120.000	161.0	V	178.0	11.4	26.3	33.5	
342.628650	12.1	1000.0	120.000	170.0	V	280.0	15.8	23.9	36.0	
578.728200	17.1	1000.0	120.000	170.0	V	10.0	20.2	18.9	36.0	
733.249500	20.3	1000.0	120.000	120.0	V	81.0	23.3	15.7	36.0	

**Plot 2:** 1 GHz to 12.75 GHz, TX mode, channel 00, vertical & horizontal polarization

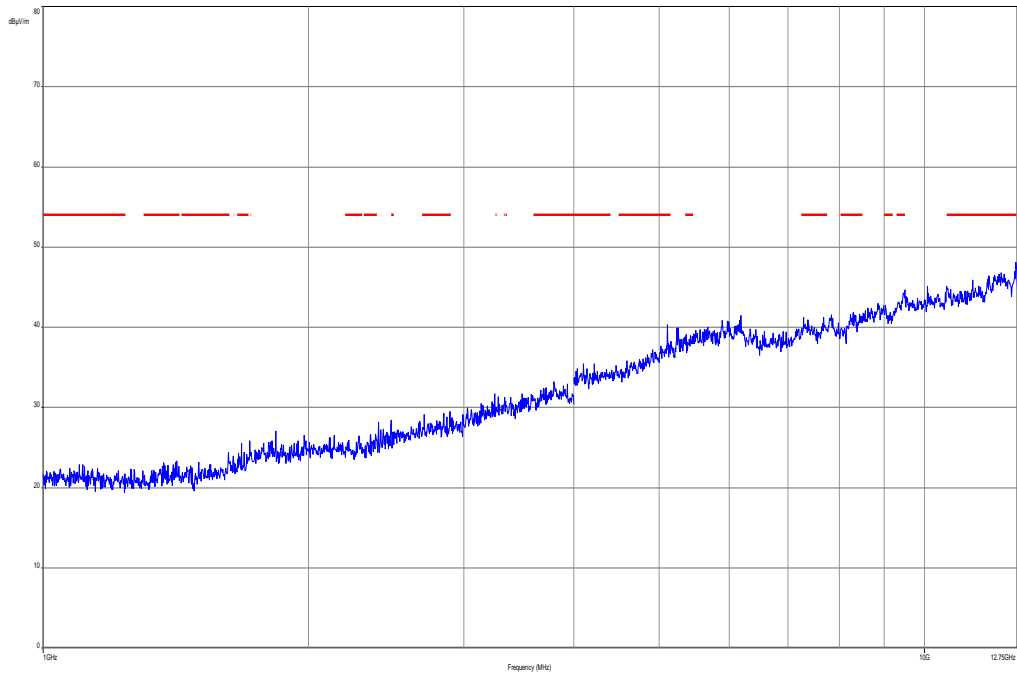

The carrier signal is notched with a 2.4 GHz band rejection filter.

**Plot 3:** 12.75 GHz to 18 GHz, TX mode, channel 00, vertical & horizontal polarization

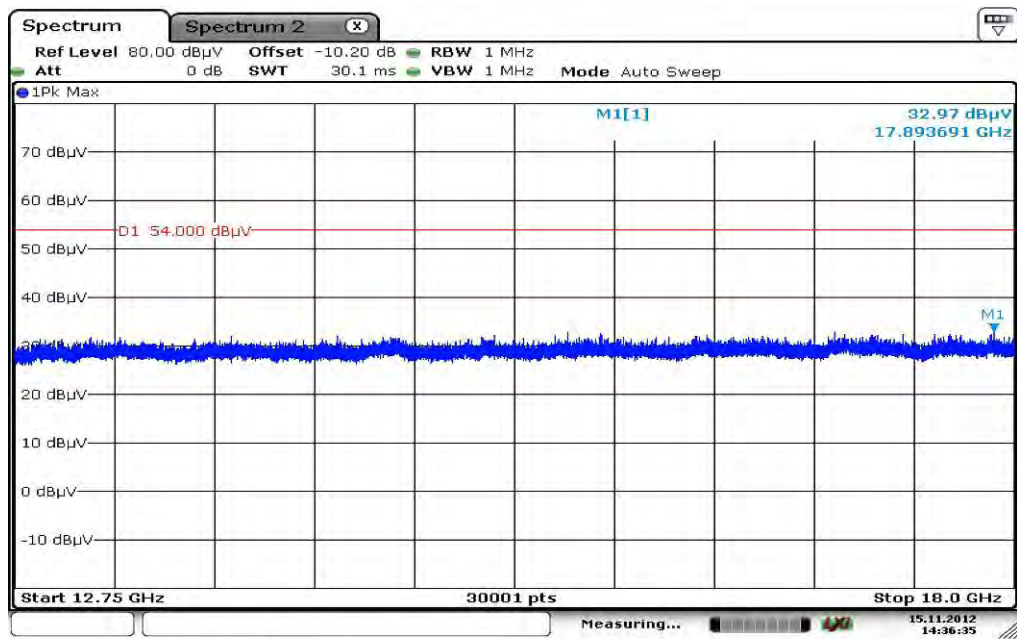

Date: 15.NOV.2012 14:36:36

Plot 4: 18 GHz to 26 GHz, TX mode, channel 00, vertical & horizontal polarization

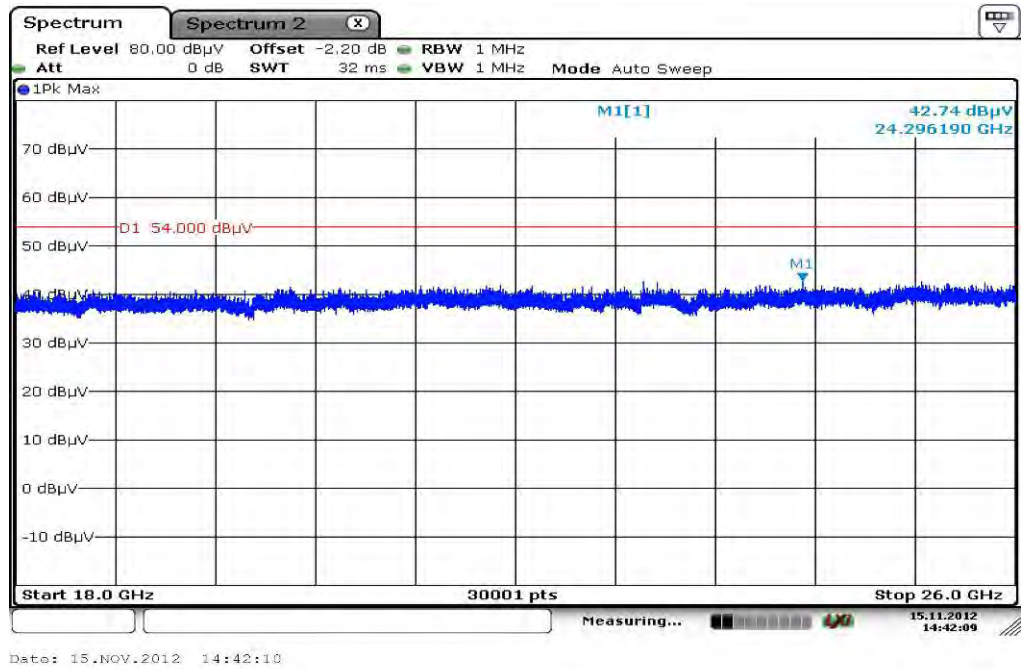

Plot 5: 30 MHz to 1 GHz, TX mode, channel 39, vertical & horizontal polarization

### Common Information

EUT: PM-0240-BV  
 Serial Number: CB5121SWDK  
 Test Description: FCC part 15 class B @ 10 m  
 Operating Conditions: BT CH39 + charging  
 Operator Name: Medrow  
 Comment: AC: 115 V / 60 Hz

### Scan Setup: STAN\_Fin [EMI radiated]

Hardware Setup: Electric Field (NOS)  
 Receiver: [ESCI 3]  
 Level Unit: dBµV/m

Subrange	Step Size	Detectors	IF BW	Meas. Time	Preamp
30 MHz - 2 GHz	60 kHz	QPK	120 kHz	1 s	20 dB

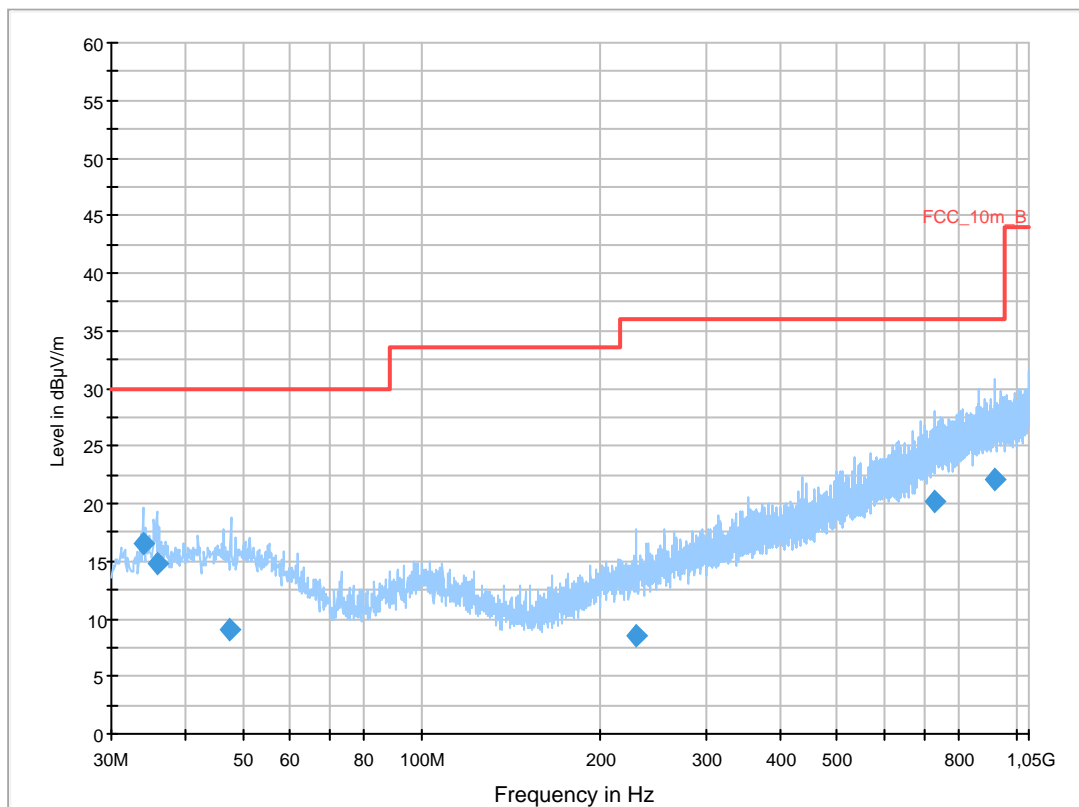

### Final Result 1

Frequency (MHz)	QuasiPeak (dBµV/m)	Meas. Time (ms)	Bandwidth (kHz)	Height (cm)	Polarization	Azimuth (deg)	Corr. (dB)	Margin (dB)	Limit (dBµV/m)	Comment
34.055550	16.6	1000.0	120.000	120.0	V	260.0	12.9	13.4	30.0	
35.786100	14.8	1000.0	120.000	130.0	V	81.0	13.1	15.2	30.0	
47.420850	9.1	1000.0	120.000	98.0	H	90.0	13.3	20.9	30.0	
229.886850	8.5	1000.0	120.000	98.0	V	-9.0	12.7	27.5	36.0	
730.034400	20.1	1000.0	120.000	170.0	V	268.0	23.2	15.9	36.0	
917.773800	22.1	1000.0	120.000	170.0	H	81.0	25.3	13.9	36.0	



**Plot 6:** 1 GHz to 12.75 GHz, TX mode, channel 39, vertical & horizontal polarization

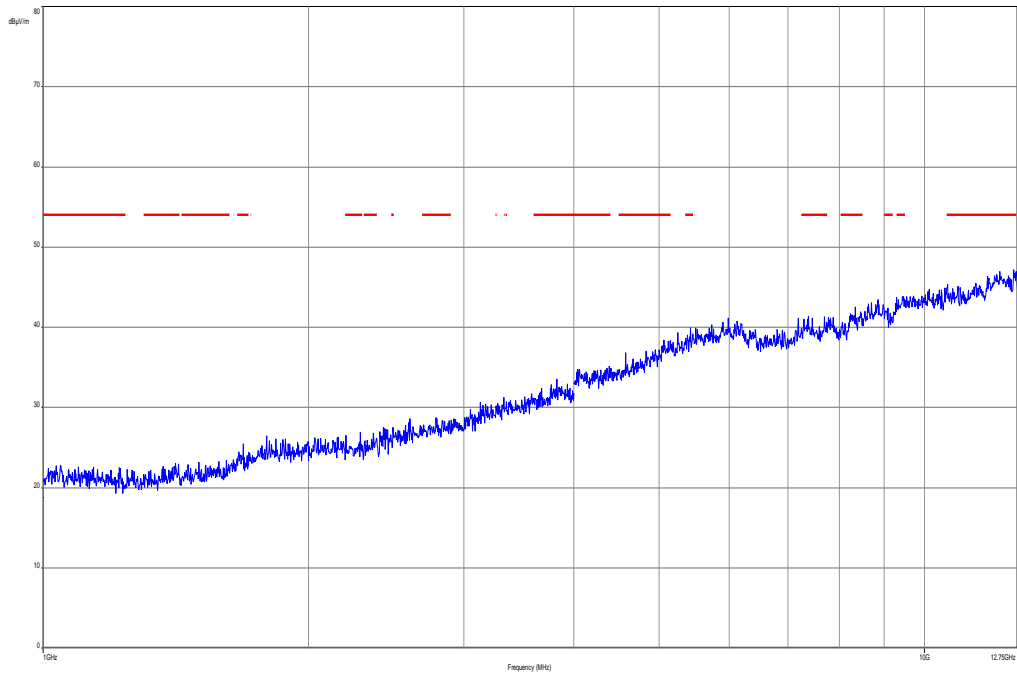

The carrier signal is notched with a 2.4 GHz band rejection filter.

**Plot 7:** 12.75 GHz to 18 GHz, TX mode, channel 39, vertical & horizontal polarization

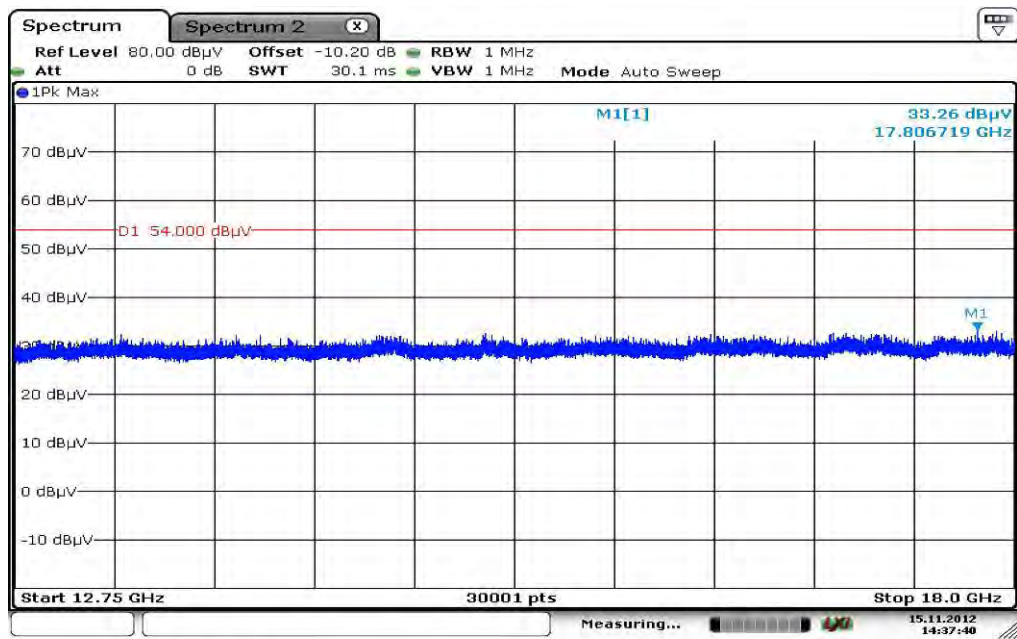

Date: 15.NOV.2012 14:37:39

Plot 8: 18 GHz to 26 GHz, TX mode, channel 39, vertical & horizontal polarization

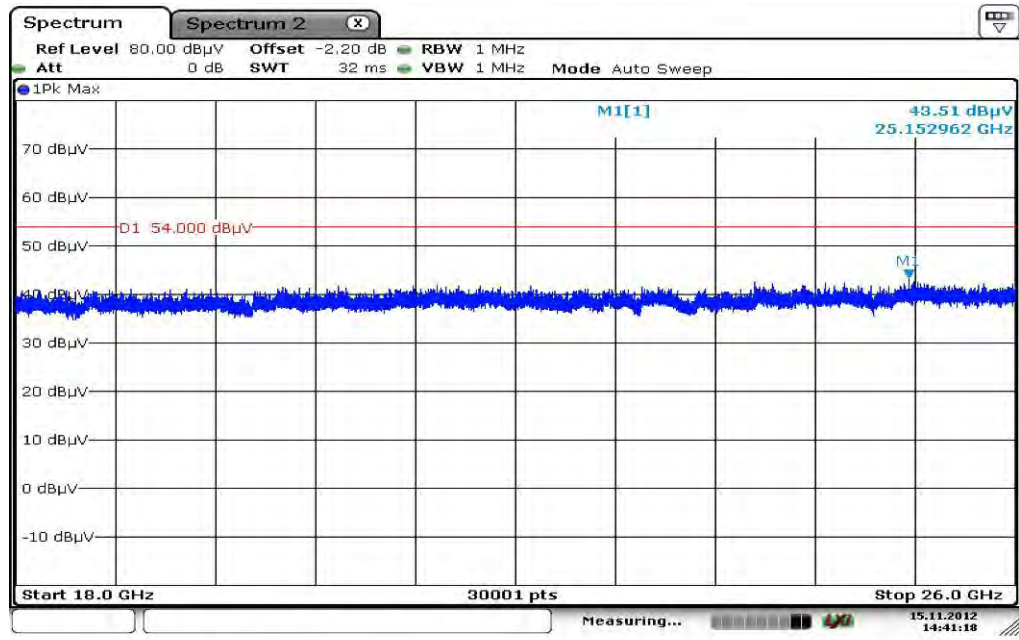

Date: 15.NOV.2012 14:41:19

Plot 9: 30 MHz to 1 GHz, TX mode, channel 78, vertical & horizontal polarization

### Common Information

EUT: PM-0240-BV  
 Serial Number: CB5121SWDK  
 Test Description: FCC part 15 class B @ 10 m  
 Operating Conditions: BT CH78 + charging  
 Operator Name: Medrow  
 Comment: AC: 115 V / 60 Hz

### Scan Setup: STAN\_Fin [EMI radiated]

Hardware Setup: Electric Field (NOS)  
 Receiver: [ESCI 3]  
 Level Unit: dBµV/m

Subrange	Step Size	Detectors	IF BW	Meas. Time	Preamp
30 MHz - 2 GHz	60 kHz	QPK	120 kHz	1 s	20 dB

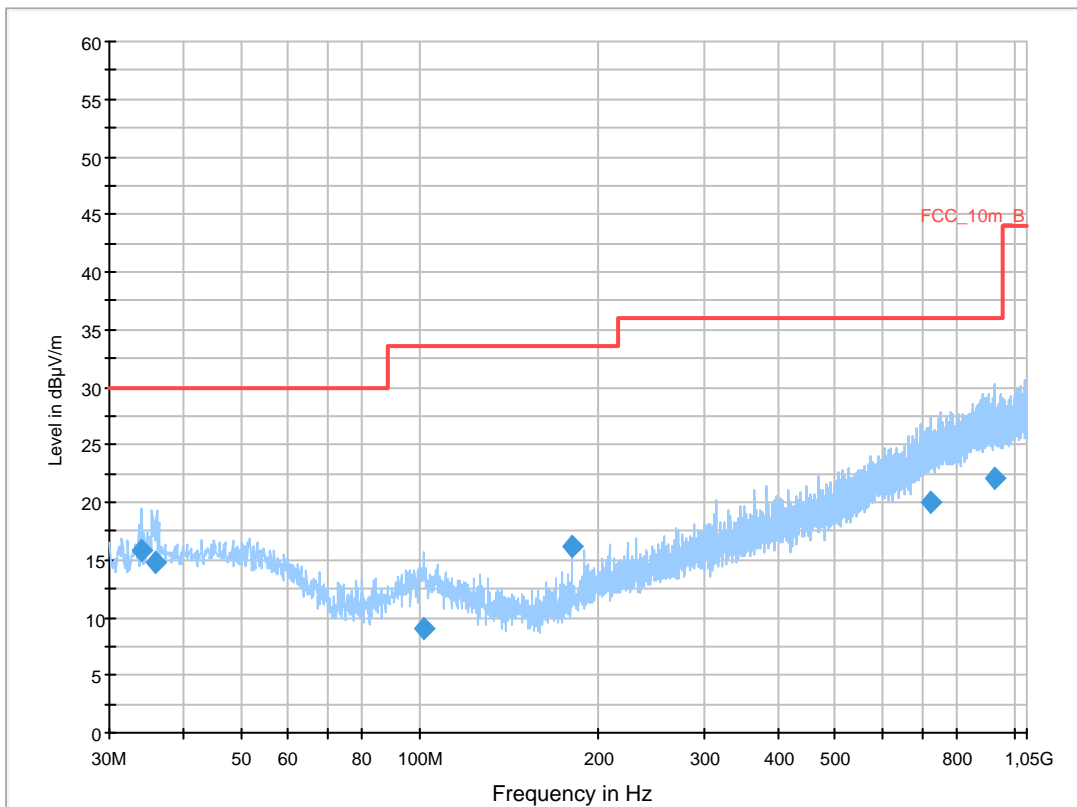

### Final Result 1

Frequency (MHz)	QuasiPeak (dBµV/m)	Meas. Time (ms)	Bandwidth (kHz)	Height (cm)	Polarization	Azimuth (deg)	Corr. (dB)	Margin (dB)	Limit (dBµV/m)	Comment
34.073700	15.8	1000.0	120.000	122.0	V	268.0	12.9	14.2	30.0	
35.787300	14.8	1000.0	120.000	170.0	V	-10.0	13.1	15.2	30.0	
101.718450	9.0	1000.0	120.000	170.0	V	100.0	11.7	24.5	33.5	
179.992800	16.1	1000.0	120.000	170.0	V	86.0	10.4	17.4	33.5	
724.552950	20.0	1000.0	120.000	170.0	H	81.0	23.1	16.0	36.0	
926.870250	22.0	1000.0	120.000	170.0	V	190.0	25.3	14.0	36.0	

**Plot 10:** 1 GHz to 12.75 GHz, TX mode, channel 78, vertical & horizontal polarization

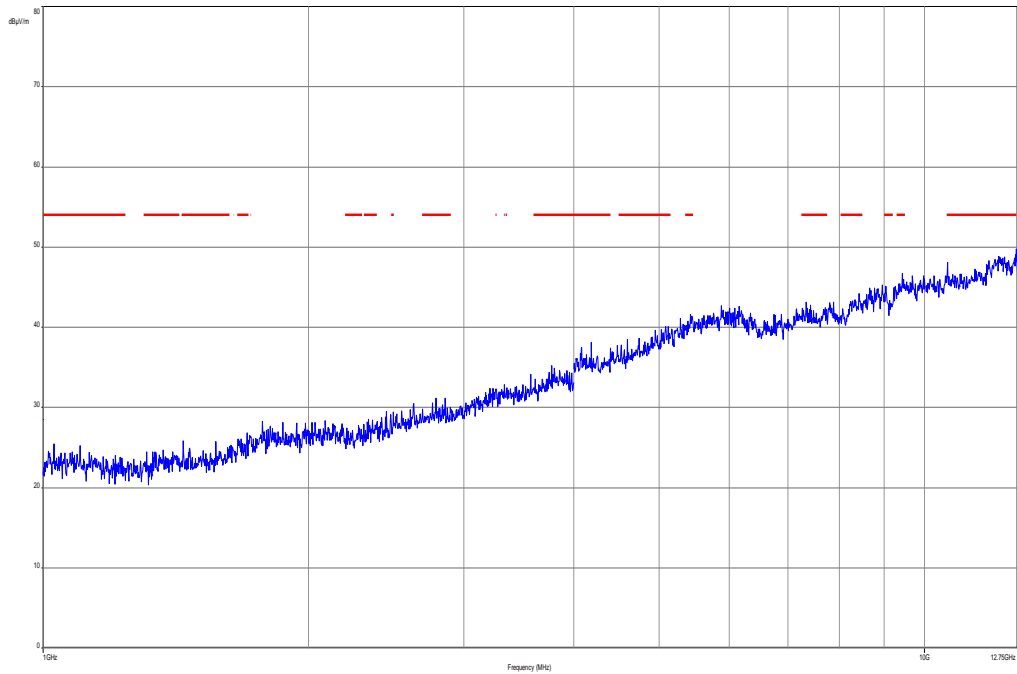

The carrier signal is notched with a 2.4 GHz band rejection filter.

**Plot 11:** 12.75 GHz to 18 GHz, TX mode, channel 78, vertical & horizontal polarization

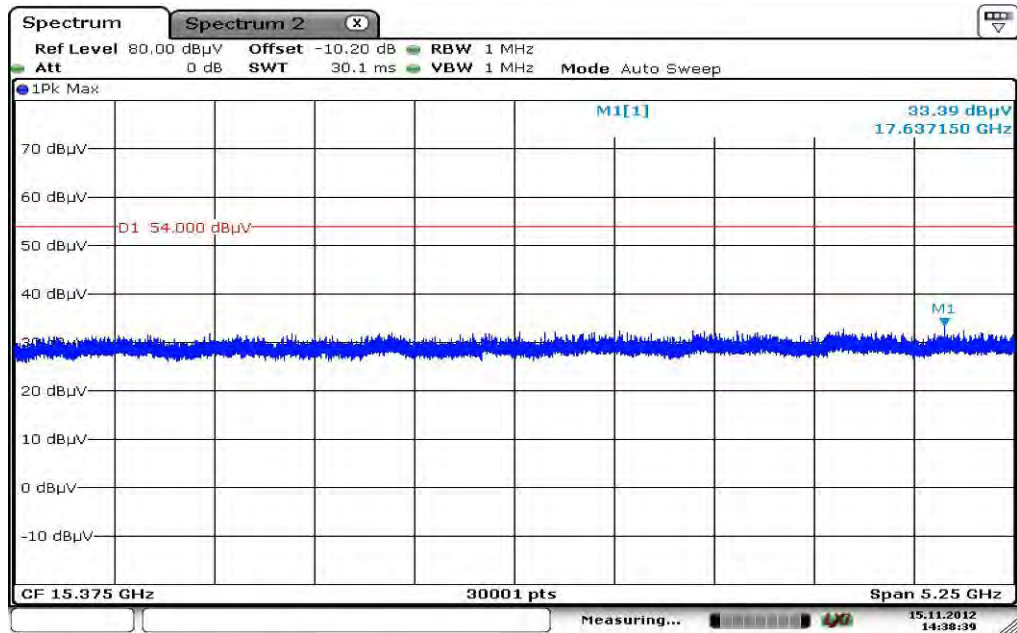

Plot 12: 18 GHz to 26 GHz, TX mode, channel 78, vertical & horizontal polarization

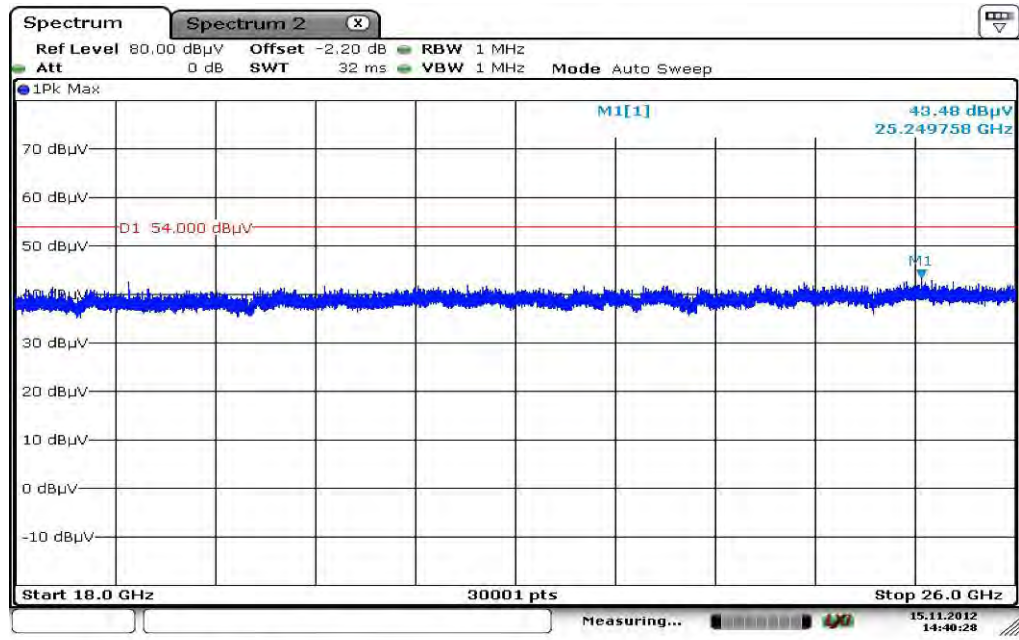

Date: 15.NOV.2012 14:40:28

## 9.12 RX spurious emissions radiated

### Description:

Measurement of the radiated spurious emissions in idle/receive mode. The EUT is detached so all oscillators are active.

### Measurement:

Measurement parameter	
Detector:	Peak / Quasi peak
Sweep time:	Auto
Video bandwidth:	Sweep: F < 1 GHz: 100 kHz F > 1 GHz: 1 MHz Remeasurement: 10 Hz
Resolution bandwidth:	F < 1 GHz: 100 kHz F > 1 GHz: 1 MHz
Span:	30 MHz to 25 GHz
Trace-Mode:	Max Hold

### Limits:

FCC		IC
RX Spurious Emissions Radiated		
Frequency (MHz)	Field strength (dB $\mu$ V/m)	Measurement distance
30 - 88	30.0	10
88 - 216	33.5	10
216 - 960	36.0	10
Above 960	54.0	3

### Results:

RX spurious emissions radiated [dB $\mu$ V/m]		
F [MHz]	Detector	Level [dB $\mu$ V/m]
For emissions below 1 GHz, please take a look at the table below the 1 GHz.		
For emissions above 1 GHz, please take a look at the plots.		
Measurement uncertainty	±3 dB	

**Result: Passed**

**Plots:**

**Plot 1:** 30 MHz to 1 GHz, RX mode, vertical & horizontal polarization

**Common Information**

EUT: PM-0240-BV  
 Serial Number: CB5121SWDK  
 Test Description: FCC part 15 class B @ 10 m  
 Operating Conditions: BT (LE) RX + charging  
 Operator Name: Medrow  
 Comment: AC: 115 V / 60 Hz

**Scan Setup: STAN\_Fin [EMI radiated]**

Hardware Setup: Electric Field (NOS)  
 Receiver: [ESCI 3]  
 Level Unit: dBµV/m

Subrange	Step Size	Detectors	IF BW	Meas. Time	Preamp
30 MHz - 2 GHz	60 kHz	QPK	120 kHz	1 s	20 dB

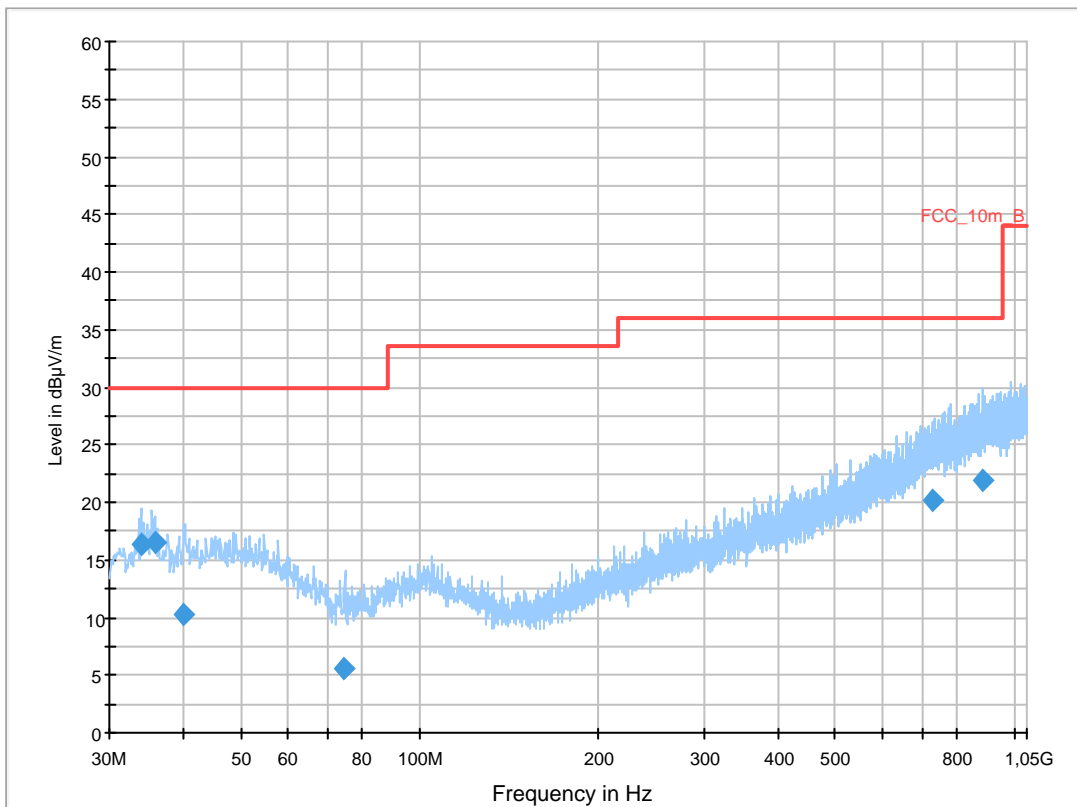

**Final Result 1**

Frequency (MHz)	QuasiPeak (dBµV/m)	Meas. Time (ms)	Bandwidth (kHz)	Height (cm)	Polarization	Azimuth (deg)	Corr. (dB)	Margin (dB)	Limit (dBµV/m)	Comment
34.024650	16.4	1000.0	120.000	98.0	V	261.0	12.9	13.6	30.0	
35.757300	16.6	1000.0	120.000	111.0	V	266.0	13.1	13.4	30.0	
40.021800	10.3	1000.0	120.000	156.0	V	88.0	13.4	19.7	30.0	
74.548650	5.5	1000.0	120.000	170.0	V	280.0	9.2	24.5	30.0	
731.576100	20.2	1000.0	120.000	143.0	H	80.0	23.2	15.8	36.0	
886.037700	22.0	1000.0	120.000	98.0	H	280.0	25.0	14.0	36.0	



**Plot 2:** 1 GHz to 12.75 GHz, RX mode, vertical & horizontal polarization

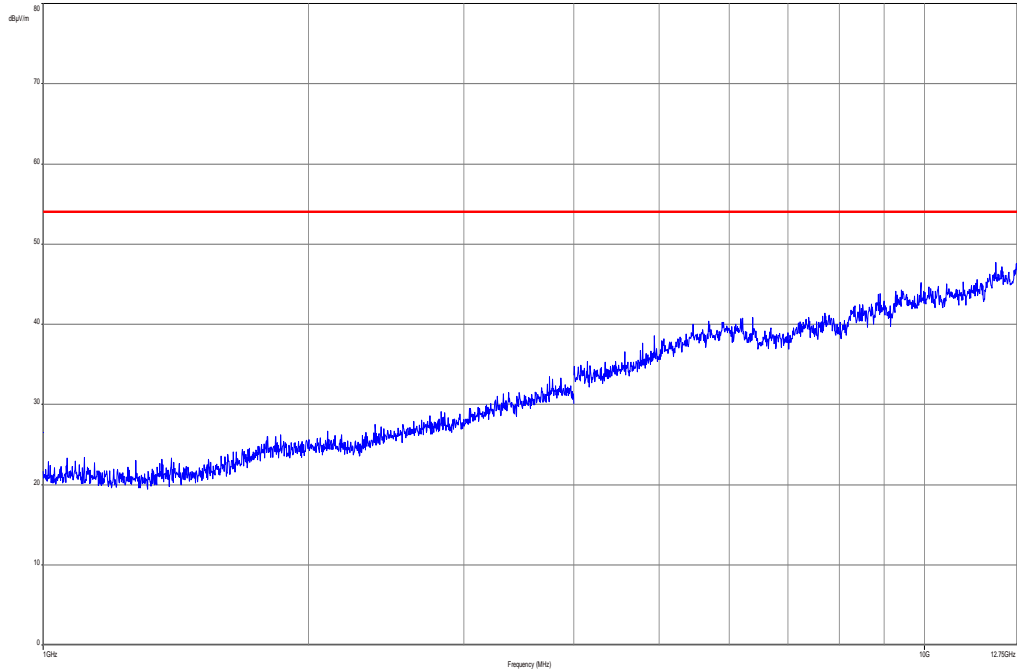

**Plot 3:** 12.75 GHz to 18 GHz, RX mode, vertical & horizontal polarization

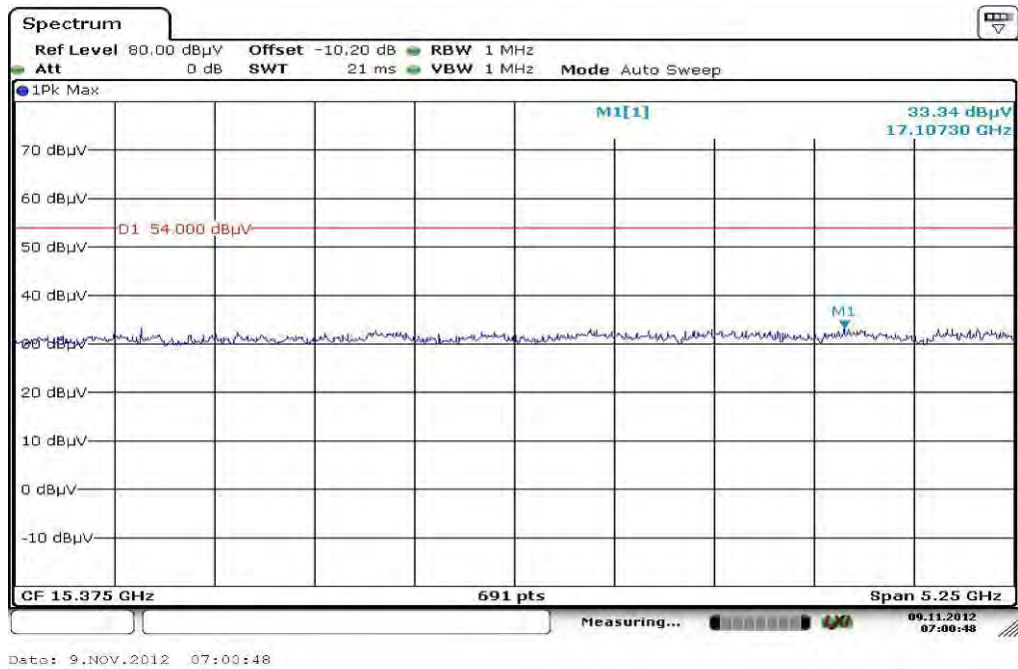

Plot 4: 18 GHz to 26 GHz, RX mode, vertical & horizontal polarization

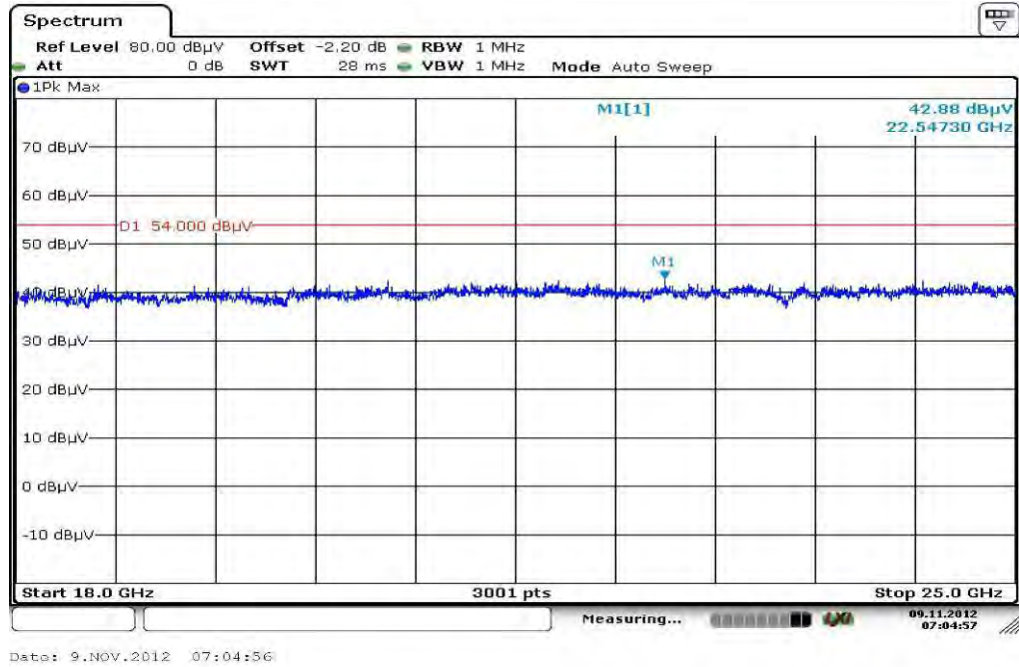

### 9.13 Spurious emissions radiated < 30 MHz

**Description:**

Measurement of the radiated spurious emissions in transmit mode below 30 MHz. The EUT is set to single channel mode and the transmit channel is channel 39. This measurement is representative for all channels and modes. If critical peaks are found channel 00 and channel 78 will be measured too. The measurement is performed in the mode with the highest output power. The limits are recalculated to a measurement distance of 3 m with 40 dB/decade according CFR Part 2.

**Measurement:**

Measurement parameter	
Detector:	Peak / Quasi peak
Sweep time:	Auto
Video bandwidth:	F < 150 kHz: 200 Hz F > 150 kHz: 9 kHz
Resolution bandwidth:	F < 150 kHz: 1 kHz F > 150 kHz: 100 kHz
Span:	9 kHz to 30 MHz
Trace-Mode:	Max Hold

**Limits:**

FCC		IC
TX spurious emissions radiated < 30 MHz		
Frequency (MHz)	Field strength (dBµV/m)	Measurement distance
0.009 – 0.490	2400/F(kHz)	300
0.490 – 1.705	24000/F(kHz)	30
1.705 – 30.0	30	30

**Results:**

TX spurious emissions radiated < 30 MHz [dBµV/m]		
F [MHz]	Detector	Level [dBµV/m]
No critical peaks detected		
Measurement uncertainty	± 3 dB	

**Result: Passed**

**Plots:**

**Plot 1:** 9 kHz to 30 MHz, TX mode, channel 39

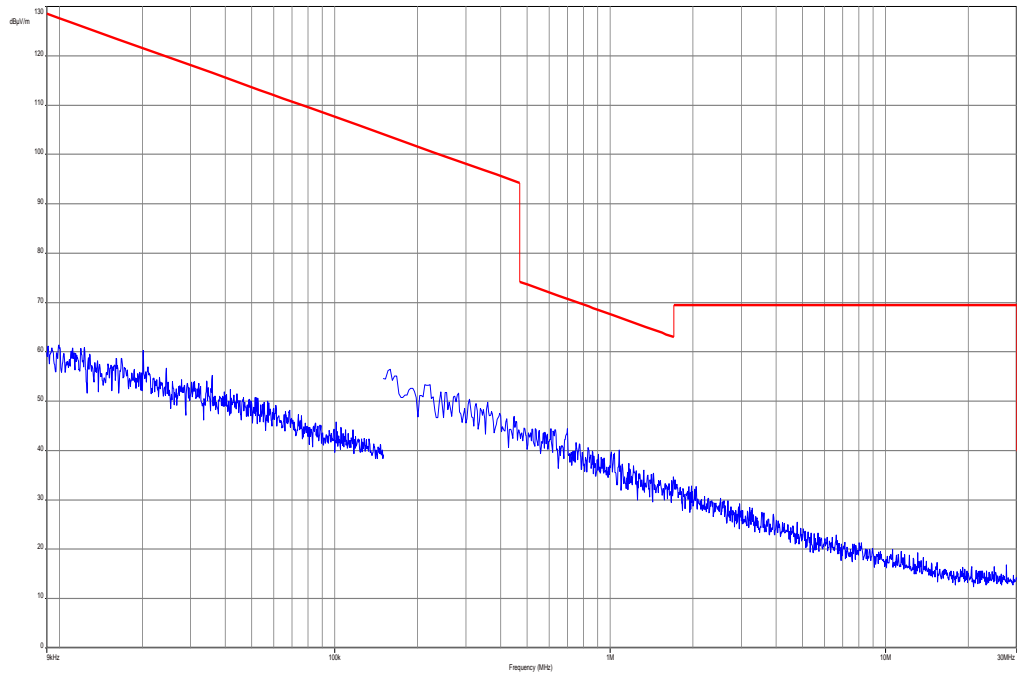

**Plot 4:** 9 kHz to 30 MHz, RX mode

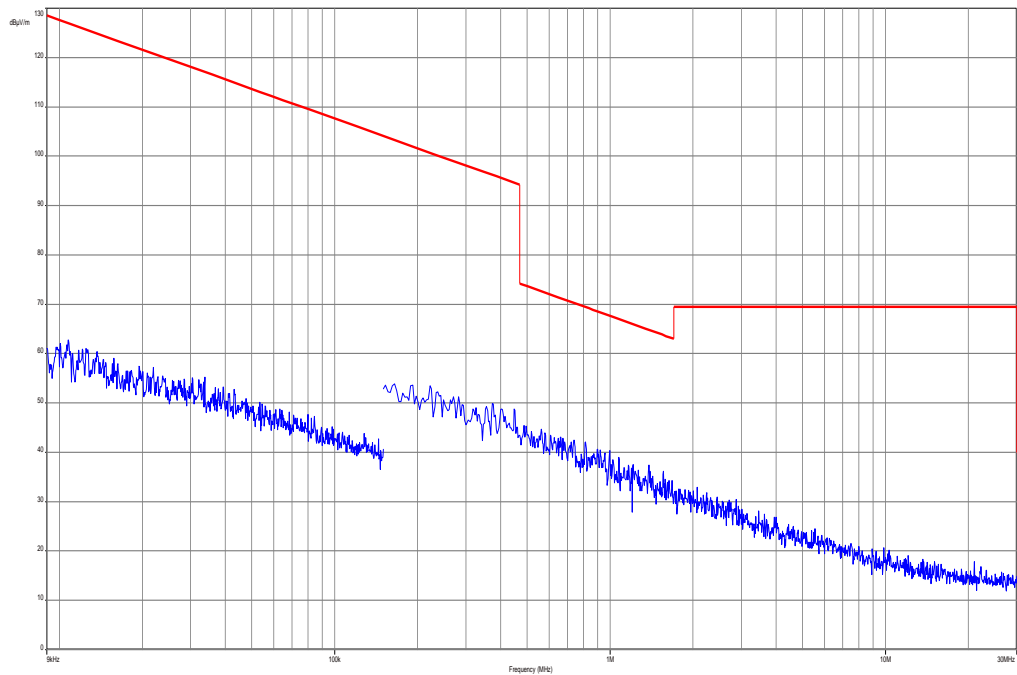

**9.14 Spurious emissions conducted < 30 MHz**

**Description:**

Measurement of the conducted spurious emissions in transmit mode below 30 MHz. The EUT is set to single channel mode and the transmit channel is channel 39. This measurement is representative for all channels and modes. If critical peaks are found channel 00 and channel 78 will be measured too. The measurement is performed in the mode with the highest output power. Both power lines, phase and neutral line, are measured. Found peaks are remeasured with average and quasi peak detection to show compliance to the limits.

**Measurement:**

Measurement parameter	
Detector:	Peak - Quasi peak / average
Sweep time:	Auto
Video bandwidth:	F < 150 kHz: 200 Hz F > 150 kHz: 9 kHz
Resolution bandwidth:	F < 150 kHz: 1 kHz F > 150 kHz: 100 kHz
Span:	9 kHz to 30 MHz
Trace-Mode:	Max Hold

**Limits:**

FCC		IC
TX spurious emissions conducted < 30 MHz		
Frequency (MHz)	Quasi-peak (dBµV/m)	Average (dBµV/m)
0.15 – 0.5	66 to 56*	56 to 46*
0.5 – 5	56	46
5 – 30.0	60	50

\*Decreases with the logarithm of the frequency

**Results:**

TX spurious emissions conducted < 30 MHz [dBµV/m]		
F [MHz]	Detector	Level [dBµV/m]
No critical peaks detected		
Measurement uncertainty	± 3 dB	

**Result: Passed**

**Plots:**

**Plot 1: 9 kHz to 30 MHz, TX mode, phase line**

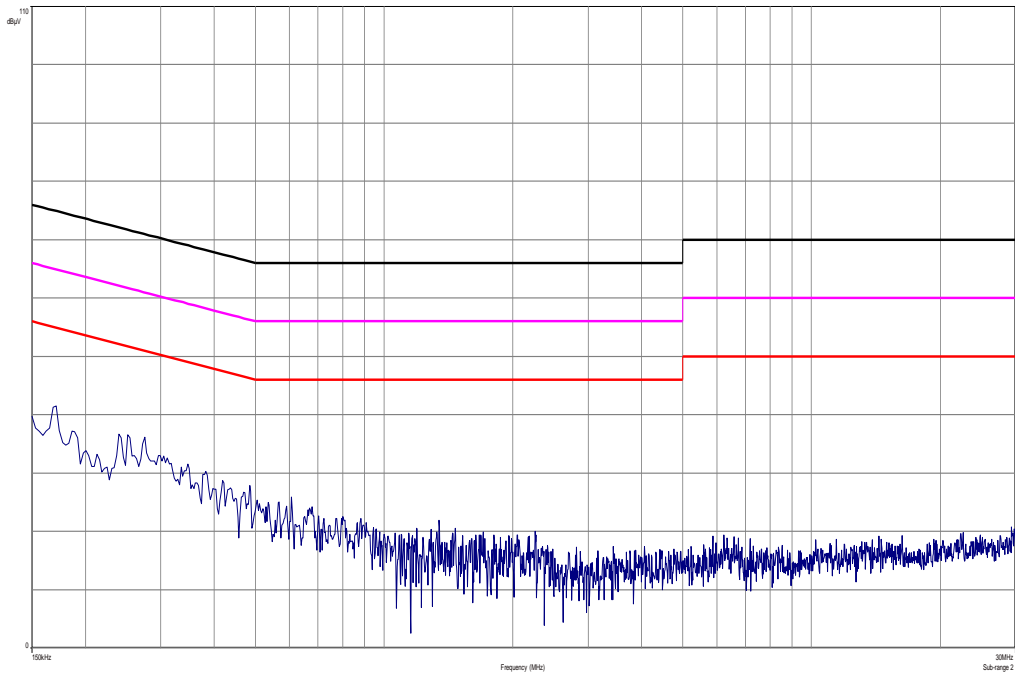

**Plot 2: 9 kHz to 30 MHz, TX mode, neutral line**

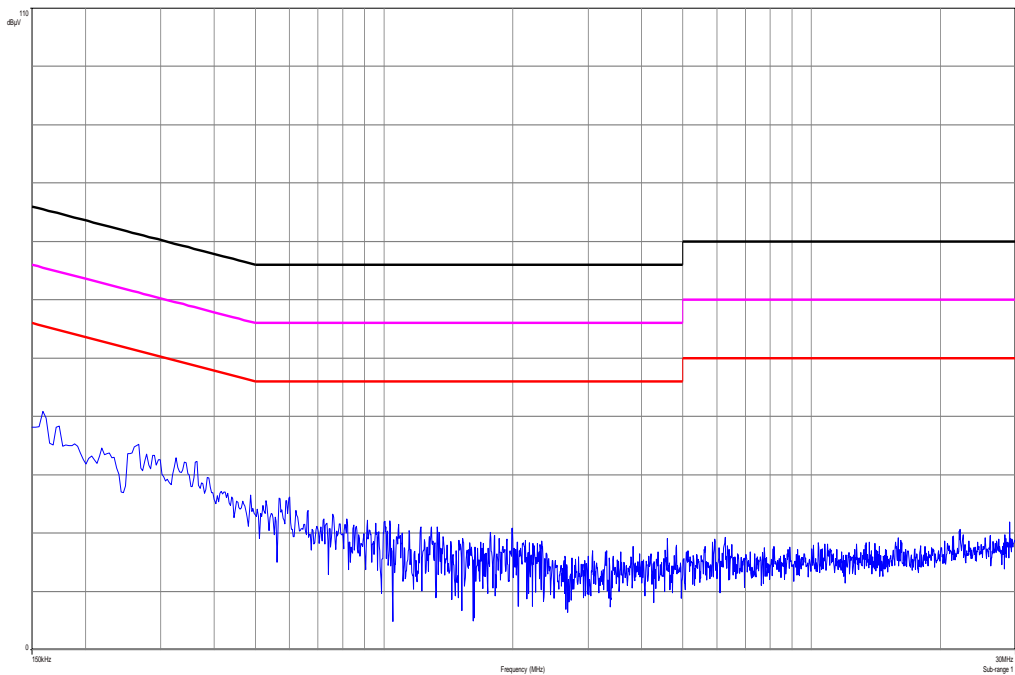



Plot 3: 9 kHz to 30 MHz, RX mode, phase line

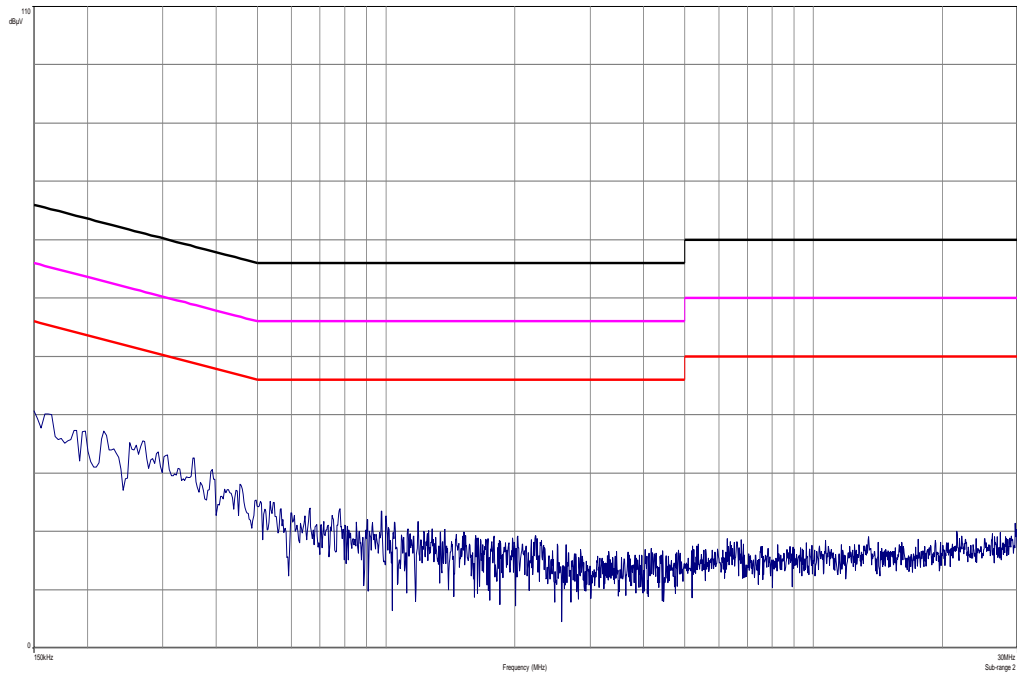

Plot 4: 9 kHz to 30 MHz, RX mode, neutral line

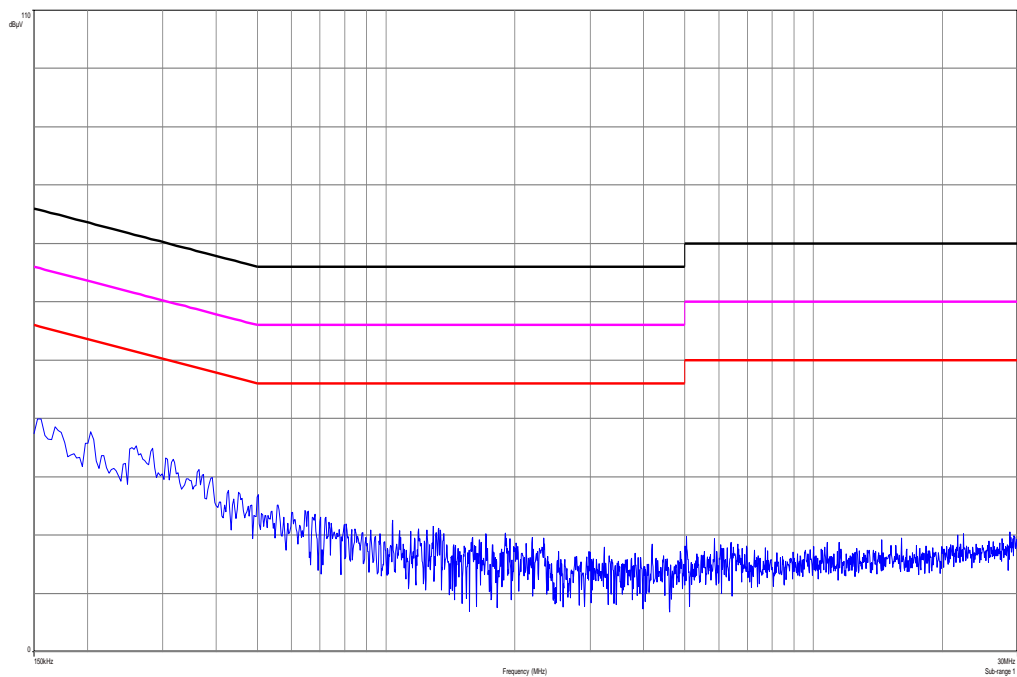

## 10 Test equipment and ancillaries used for tests

Typically, the calibrations of the test apparatus are commissioned to and performed by an accredited calibration laboratory. The calibration intervals are determined in accordance with the DIN EN ISO/IEC 17025. In addition to the external calibrations, the laboratory executes comparison measurements with other calibrated test systems or effective verifications. Weekly chamber inspections and range calibrations are performed. Where possible, rf-generating and signalling equipment as well as measuring receivers and analyzers are connected to an external high-precision 10 MHz reference (GPS-based or rubidium frequency standard).

In order to simplify the identification of the equipment used at some special tests, some items of test equipment and ancillaries can be provided with an identifier or number in the equipment list below (Labor/Item).

No.	Lab / Item	Equipment	Type	Manufact.	Serial No.	INV. No Cetecom	Kind of Calibration	Last Calibration	Next Calibration
1	n. a.	Switch / Control Unit	3488A	HP Meßtechnik		300001691	ne		
2	n. a.	Power Supply DC	NGPE 40/40	R&S	388	400000078	vIKI!	21.08.2012	21.08.2014
3	n. a.	Power Sensor 50 Ohms, 10 MHz - 18 GHz, 1 nW - 20 mW	NRV-Z1	R&S	833894/011	300002681-0010	k	22.08.2012	22.08.2014
4	n. a.	Hygro-Thermometer	-/, 5-45°C, 20-100%rF	Thies Clima	-/	400000080	k	24.09.2012	24.09.2013
5	n. a.	Vector Signal Generator, 300 kHz to 2.2 GHz	SMIQ03B	R&S	835541/055	300002681-0001	k	18.08.2011	18.08.2014
6	n. a.	Signal Generator 0.01/2 - 20 GHz, Frequ. Resol. 0.1Hz	SMP02	R&S	835133/011	300002681-0003	k	12.08.2011	12.08.2014
7	n. a.	Dual Channel Power Meter	NRVD	R&S	835430/044	300002681-0004	k	22.08.2012	22.08.2014
8	n. a.	Signal Analyzer 20Hz-26,5GHz-150 to + 30 DBM	FSIQ26	R&S	835540/018	300002681-0005	k	01.02.2012	01.02.2014
9	n. a.	Frequency Standard (Rubidium Frequency Standard)	MFS (Rubidium)	R&S (Datum)	002	300002681-0009	Ve	21.08.2012	21.08.2014
10	n. a.	Directional Coupler	101020010	Krytar	70215	300002840	ev		
11	n. a.	DC-Blocker	8143	Inmet Corp.	none	300002842	ne		
12	n. a.	Powersplitter	6005-3	Inmet Corp.		300002841	ev		
13	n. a.	Temperature Test Chamber	VT 4002	Heraeus Voetsch	58566046820 010	300003019	Ve	20.09.2011	20.09.2013
14	n. a.	CBT (Bluetooth Tester + EDR Signalling)	CBT 1153.9000 K35	R&S	100185	300003416	vIKI!	21.08.2012	21.08.2014
15	n. a.	Spectrum Analyzer 9kHz to 30GHz - 140..+30dBm	FSP30	R&S	100886	300003575	k	22.08.2012	22.08.2014
16	n. a.	CBT-K57 Software-Option for CBT/CBT32	CBT-K57	R&S	101051	300003910	ne		
17	n. a.	Isolating Transformer	RT5A	Grundig	8041	300001626	g		
18	n. a.	DC power supply, 60Vdc, 50A, 1200 W	6032A	HP Meßtechnik	2818A03450	300001040	Ve	12.01.2012	12.01.2015
19	n. a.	Double-Ridged Waveguide Horn Antenna 1-18.0GHz	3115	EMCO	8812-3088	300001032	vIKI!	11.05.2011	11.05.2013
20	n. a.	Active Loop Antenna	6502	EMCO	2210	300001015	ne		
21	n. a.	Anechoic chamber	FAC 3/5m	MWB / TDK	87400/02	300000996	ev		
22	9	Artificial Mains 9 kHz to 30 MHz	ESH3-Z5	R&S	828576/020	300001210	Ve	06.01.2012	06.01.2014
23	n. a.	Relais Matrix	3488A	HP Meßtechnik	2719A15013	300001156	ne		

24	n. a.	Relais Matrix	PSU	R&S	890167/024	300001168	ne		
25	n. a.	Three-Way Power Splitter, 50 Ohm	11850C	HP Meßtechnik		300000997	ne		
26	n. a.	Switch / Control Unit	3488A	HP	2605e08770	300001443	ne		
27	n. a.	Amplifier	js42-00502650-28-5a	Parzich GMBH	928979	300003143	ne		
28	n. a.	Band Reject filter	WRCG2400/2483-2375/2505-50/10SS	Wainwright	11	300003351	ev		
29	n. a.	TRILOG Broadband Test-Antenna 30 MHz - 3 GHz	VULB9163	Schwarzbeck	371	300003854	vKI!	14.10.2011	14.10.2014
30	n. a.	MXE EMI Receiver 20 Hz bis 26.5 GHz	N9038A	Agilent Technologies	MY51210197	300004405	k	19.12.2011	19.12.2012
31	11b	Microwave System Amplifier, 0.5-26.5 GHz	83017A	HP Meßtechnik	00419	300002268	ev		
32	A026	Std. Gain Horn Antenna 12.4 to 18.0 GHz	639	Narda		300000787	ne		
33	A029	Std. Gain Horn Antenna 18.0 to 26.5 GHz	638	Narda		300002442	ne		
34	n. a.	Spectrum Analyzer 20 Hz - 50 GHz	FSU50	R&S	200012	300003443	Ve	09.10.2012	09.10.2014
35	45	Switch-Unit	3488A	HP Meßtechnik	2719A14505	300000368	g		
36	50	DC power supply, 60Vdc, 50A, 1200 W	6032A	HP Meßtechnik	2920A04466	300000580	ne		
37	n. a.	software	SPS_PHE 1.4f	Spitzberger & Spieß	B5981; 5D1081; B5979	300000210	ne		
38	n. a.	EMI Test Receiver	ESCI 1166.5950.03	R&S	100083	300003312	k	04.01.2012	04.01.2013
39	n. a.	Analyzer-Reference-System (Harmonics and Flicker)	ARS 16/1	SPS	A3509 07/0 0205	300003314	k	14.07.2011	14.07.2013
40	n. a.	Amplifier	JS42-00502650-28-5A	MITEQ	1084532	300003379	ev		
41	n. a.	Antenna Tower	Model 2175	ETS-LINDGREN	64762	300003745	izw		
42	n. a.	Positioning Controller	Model 2090	ETS-LINDGREN	64672	300003746	izw		
43	n. a.	Turntable Interface-Box	Model 105637	ETS-LINDGREN	44583	300003747	izw		
44	n. a.	TRILOG Broadband Test-Antenna 30 MHz - 3 GHz	VULB9163	Schwarzbeck	295	300003787	k	12.04.2012	12.04.2014
45	n. a.	Spectrum-Analyzer	FSU26	R&S	200809	300003874	k	06.01.2012	06.01.2014

**Agenda:** Kind of Calibration

- |      |  |     |  |
|------|--|-----|--|
| k    | calibration / calibrated                   | EK  | limited calibration                                  |
| ne   | not required (k, ev, izw, zw not required) | zw  | cyclical maintenance (external cyclical maintenance) |
| ev   | periodic self verification                 | izw | internal cyclical maintenance                        |
| Ve   | long-term stability recognized             | g   | blocked for accredited testing                       |
| vKI! | Attention: extended calibration interval   | *   | next calibration ordered / currently in progress     |
| NK!  | Attention: not calibrated                  |     |  |

**11 Observations**

No observations exceeding those reported with the single test cases have been made.