



TEST REPORT

Test report no.: 1-4254/12-61-12-A



Deutsche
Akkreditierungsstelle
D-PL-12076-01-01

Testing laboratory

CETECOM ICT Services GmbH
Untertuerkheimer Strasse 6 – 10
66117 Saarbruecken / Germany
Phone: + 49 681 5 98 - 0
Fax: + 49 681 5 98 - 9075
Internet: <http://www.cetecom.com>
e-mail: ict@cetecom.com

Accredited Testing Laboratory:

The testing laboratory (area of testing) is accredited according to DIN EN ISO/IEC 17025 (2005) by the Deutsche Akkreditierungsstelle GmbH (DAkkS). The accreditation is valid for the scope of testing procedures as stated in the accreditation certificate with the registration number: D-PL-12076-01-01
Area of Testing: Radio/Satellite Communications

Applicant

Sony Mobile Communications AB
Nya Vattentornet
22188 Lund / SWEDEN
Phone: +46 46 19 30 00
Fax: +46 46 19 32 95
Contact: Håkan Sjöberg
e-mail: hakan.sjoberg@sonymobile.com
Phone: +46 46 19 35 59

Manufacturer

Sony Mobile Communications AB
Nya Vattentornet
22188 Lund / SWEDEN

Test standard/s

47 CFR Part 15 Title 47 of the Code of Federal Regulations; Chapter I
Part 15 - Radio frequency devices
RSS - 210 Issue 8 Spectrum Management and Telecommunications - Radio Standards Specification
Low-power Licence-exempt Radiocommunication Devices (All Frequency Bands):
Category I Equipment

For further applied test standards please refer to section 3 of this test report.

Test Item

Kind of test item: GSM Mobile Phone GPRS/EGPRS 850/900/1800/1900; UMTS HSPA FDDI/V/VIII; LTE FDD 1/3/5/7/8/20; WLAN a/b/g/n; BT 3.1; BT LE; RFID; FM Rx; A-GPS
Model name: PM-0240-BV
FCC ID: PY7PM-0240
IC: 4170B-PM0240
Frequency: 5250 MHz – 5350 MHz ISM band 2
(lowest channel 5260; highest channel 5320 MHz)
5470 MHz – 5725 MHz ISM band 3
(lowest channel 5500; highest channel 5700 MHz)
Technology tested: WLAN (DFS-client)
Antenna: Integrated antenna
Power Supply: 3.7 V DC by Li - polymer battery
Temperature Range: -20°C to +55 °C

Test report authorised:

P.O. Gordly Kruster
2013-01-30 Stefan Bös
Senior Testing Manager

Test performed:

P.O. Marco Bertolino
2013-01-30 Marco Bertolino
Testing Manager

1 Table of contents

1 Table of contents2

2 General information3

2.1 Notes and disclaimer3

2.2 Application details.....3

3 Test standard/s3

4 Test environment.....4

5 Test item.....4

6 Test laboratories sub-contracted4

7 Summary of measurement results5

8 RF measurements6

8.1 Description of test setup6

 8.1.1 Conducted measurements.....6

 8.1.2 Parameters of DFS test signals.....7

8.2 DFS test results8

 8.2.1 Channel move time / channel closing transmission time.....8

 8.2.2 Non-Occupancy Period.....10

9 Test equipment and ancillaries used for tests13

10 Observations13

Annex A Photographs of the test setup.....14

Annex B External photographs of the EUT.....15

Annex C Internal photographs of the EUT.....19

Annex D Document history25

Annex E Further information.....25

Annex F Accreditation Certificate26

2 General information

2.1 Notes and disclaimer

The test results of this test report relate exclusively to the test item specified in this test report. CETECOM ICT Services GmbH does not assume responsibility for any conclusions and generalizations drawn from the test results with regard to other specimens or samples of the type of the equipment represented by the test item.

The test report may only be reproduced or published in full. Reproduction or publication of extracts from the report requires the prior written approval of CETECOM ICT Services GmbH.

The testing service provided by CETECOM ICT Services GmbH has been rendered under the current "General Terms and Conditions for CETECOM ICT Services GmbH".

CETECOM ICT Services GmbH will not be liable for any loss or damage resulting from false, inaccurate, inappropriate or incomplete product information provided by the customer.

Under no circumstances does the CETECOM ICT Services GmbH test report include any endorsement or warranty regarding the functionality, quality or performance of any other product or service provided.

Under no circumstances does the CETECOM ICT Services GmbH test report include or imply any product or service warranties from CETECOM ICT Services GmbH, including, without limitation, any implied warranties of merchantability, fitness for purpose, or non-infringement, all of which are expressly disclaimed by CETECOM ICT Services GmbH.

All rights and remedies regarding vendor's products and services for which CETECOM ICT Services GmbH has prepared this test report shall be provided by the party offering such products or services and not by CETECOM ICT Services GmbH.

In no case this test report can be considered as a Letter of Approval.

2.2 Application details

Date of receipt of order:	2012-11-02
Date of receipt of test item:	2012-11-05
Start of test:	2012-11-22
End of test:	2012-11-22
Person(s) present during the test:	-/-

3 Test standard/s

Test standard	Date	Test standard description
47 CFR Part 15	2010-10	Title 47 of the Code of Federal Regulations; Chapter I Part 15 - Radio frequency devices
RSS - 210 Issue 8	2010-12	Spectrum Management and Telecommunications - Radio Standards Specification Low-power Licence-exempt Radiocommunication Devices (All Frequency Bands): Category I Equipment

4 Test environment

Temperature:	T_{nom}	+22 °C during room temperature tests
	T_{max}	+55 °C during high temperature tests
	T_{min}	-20 °C during low temperature tests
Relative humidity content:		46 %
Barometric pressure:		not relevant for this kind of testing
Power supply:	V_{nom}	3.7 V DC by Li - polymer battery
	V_{max}	4.1 V
	V_{min}	3.3 V

5 Test item

Kind of test item	:	GSM Mobile Phone GPRS/EGPRS 850/900/1800/1900; UMTS HSPA FDDI/V/VIII; LTE FDD 1/3/5/7/8/20; WLAN a/b/g/n; BT 3.1; BT LE; RFID; FM Rx; A-GPS
Type identification	:	PM-0240-BV
S/N serial number	:	Cond. CB5121TUBU
HW hardware status	:	SP1.2
SW software status	:	10.1.A.0.194, 10.1.A.1.17
Frequency band [MHz]	:	5250 MHz – 5350 MHz ISM band 2 (lowest channel 5260; highest channel 5320 MHz) 5470 MHz – 5725 MHz ISM band 3 (lowest channel 5500; highest channel 5700 MHz)
Type of radio transmission	:	OFDM
Use of frequency spectrum	:	
Channel access method	:	FDMA
Type of modulation	:	QPSK, 16 – & 64 – QAM
Number of channels	:	ISM band 2: 4 ISM band 3: 11
Antenna	:	Integrated antenna
Power supply	:	3.7 V DC by Li - polymer battery
Temperature range	:	-20°C to +55 °C

6 Test laboratories sub-contracted

None

7 Summary of measurement results

- No deviations from the technical specifications were ascertained
- There were deviations from the technical specifications ascertained

TC Identifier	Description	Verdict	Date	Remark
DFS-Testing	CFR Part 15 RSS 210, Issue 8, Annex 8	Pass	2013-01-30	only DFS

Test Report Clause	Test Case	Temperature / Voltage	Pass	Fail	NA	NP	Remark
§15.407 (h)(2) (iii)	Channel move time and channel closing transmission time	nominal / nominal	<input checked="" type="checkbox"/>	<input type="checkbox"/>	<input type="checkbox"/>	<input type="checkbox"/>	complies
§15.407 (h)(2) (iv)	Non-Occupancy Period	nominal / nominal	<input checked="" type="checkbox"/>	<input type="checkbox"/>	<input type="checkbox"/>	<input type="checkbox"/>	complies

Note: NA = Not Applicable; NP = Not Performed

8 RF measurements

8.1 Description of test setup

8.1.1 Conducted measurements

Setup

Figure 1 shows a setup whereby the UUT is a RLAN device operating in slave mode, without Radar Interference Detection function. This setup also contains a RLAN device operating in master mode. The radar test signals are injected into the master device. The UUT (slave device) is associated with the master device.

Figure 1 shows an example

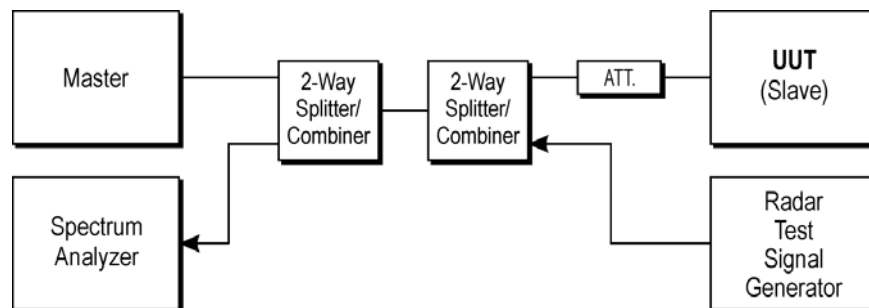

Figure 1: Setup

As master a Proxim AP-800 Access Point is used:

Certification Certification Number: FCC PPD-AR5BMB82
IC 4104A-AR5BMB82

8.1.2 Parameters of DFS test signals

1. Interference Threshold values, Master or Client incorporating In-Service Monitoring

Maximum Transmit Power	Value (see note)
≥ 200 mW	-64 dBm
< 200 mW	-62 dBm
<p>Note 1: This is the level at the input of the receiver assuming a 0 dBi receive antenna Note 2: Throughout these test procedures an additional 1 dB has been added to the amplitude of the test transmission waveforms to account for variations in measurement equipment. This will ensure that the test signal is at or above the detection threshold level to trigger a DFS response.</p>	

2. DFS Response requirement values

Parameter	Value
Non-occupancy period	minimum 30 minutes
Channel Availability Check Time	60 seconds
Channel Move Time	10 seconds See Note 1.
Channel Closing Transmission Time	200 milliseconds + an aggregate of 60 milliseconds over remaining 10 second period. See Notes 1 and 2.
U-NII Detection Bandwidth	Minimum 80% of the 99% transmission power bandwidth See Note 3.
<p>Note 1: The instant that the Channel Move Time and the Channel Closing Transmission Time begins is as follows:</p> <ul style="list-style-type: none"> • For the Short pulse radar Test Signals this instant is the end of the Burst. • For the Frequency Hopping radar Test Signal, this instant is the end of the last radar Burst generated. • For the Long Pulse radar Test Signal this instant is the end of the 12 second period defining the radar transmission. <p>Note 2: The Channel Closing Transmission Time is comprised of 200 milliseconds starting at the beginning of the Channel Move Time plus any additional intermittent control signals required to facilitate Channel changes (an aggregate of 60 milliseconds) during the remainder of the 10 second period. The aggregate duration of control signals will not count quiet periods in between transmissions.</p> <p>Note 3: During the U-NII Detection Bandwidth detection test, radar type 1 is used and for each frequency step the minimum percentage of detection is 90%. Measurements are performed with no data traffic.</p>	

8.2 DFS test results

8.2.1 Channel move time / channel closing transmission time

Description:

Channel Move Time. After a radar's presence is detected, all transmissions shall cease on the operating channel within 10 seconds. Transmissions during this period shall consist of normal traffic for a maximum of 200 ms after detection of the radar signal. In addition, intermittent management and control signals can be sent during the remaining time to facilitate vacating the operating channel.

Test Procedure:

Perform the test with one of the type 1 to type 4 short pulse radar waveforms.

Result: Channel 60

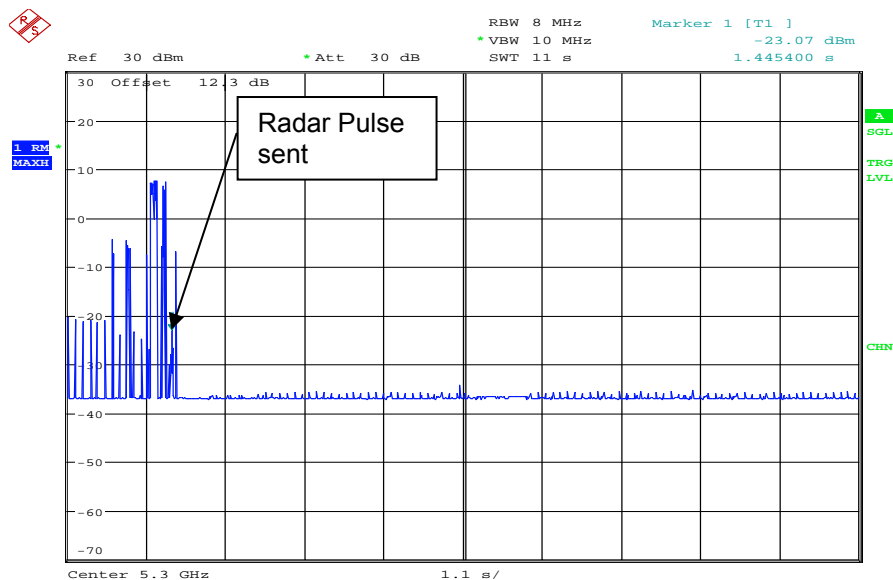

Date: 22.NOV.2012 12:59:38

The arrow shows the time of the radar pulse. On the plot you can see that no transmissions occur from the AP after sending the radar burst. The time difference between the recognition of the radar burst by the AP and its last transmission is called as Channel Move Time (Limit: 10 s). The accumulated transmission time of the AP and for the slave device after detection of a radar signal is called channel closing transmission time (Limit: in total 200 ms + 60 ms).

The accumulated channel closing transmission time after 200ms of the slave device is less than 60 ms.

Result: Channel 116

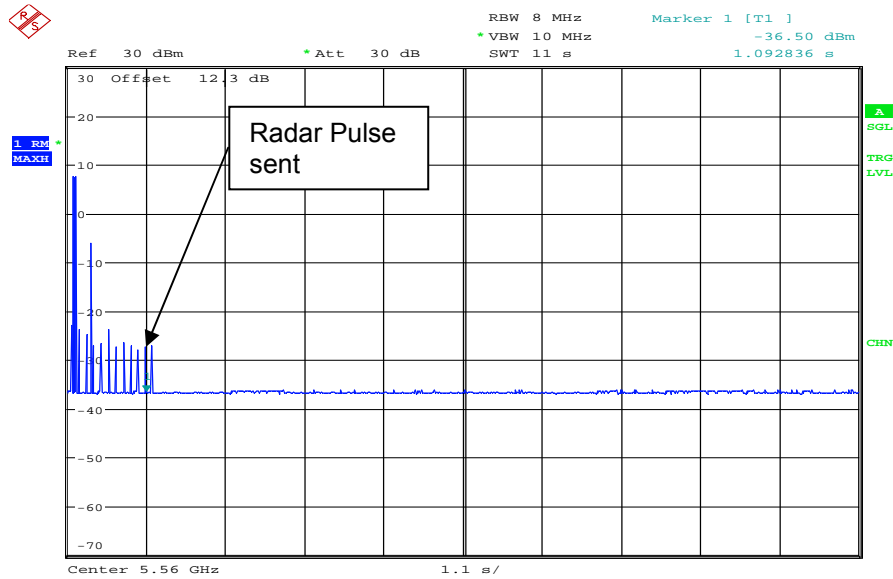

Date: 22.NOV.2012 14:45:21

The arrow shows the time of the radar pulse. On the plot you can see that no transmissions occur from the AP after sending the radar burst. The time difference between the recognition of the radar burst by the AP and its last transmission is called as Channel Move Time (Limit: 10 s). The accumulated transmission time of the AP and for the slave device after detection of a radar signal is called channel closing transmission time (Limit: in total 200 ms + 60 ms).

The accumulated channel closing transmission time after 200 ms of the slave device is less than 60 ms.

Final verdict: Pass

8.2.2 Non-Occupancy Period

Description:

Non-occupancy Period. A channel that has been flagged as containing a radar system, either by a channel availability check or in-service monitoring, is subject to a non-occupancy period of at least 30 minutes. The non occupancy period starts at the time when the radar system is detected.

Test Procedure:

Client device is not permitted to transmit beacons on DFS frequencies.

- 1) Non-associated test:
The master has been off, monitor the analyzer on the test mode frequency that have been selected for testing, power up the client for 30 minutes to make sure no beacons have been transmitted.
- 2) Associated test:
Associate the master and client and stream the movie as specified for non- occupancy test. Transmit Radar type 1; monitor the test frequency to make sure no beacons have been transmitted for 30 minutes.

Mode	Results
Non-Associated	No Beacons transmit
Associated	No transmissions

Please refer to the following plots.

1) Non-associated:

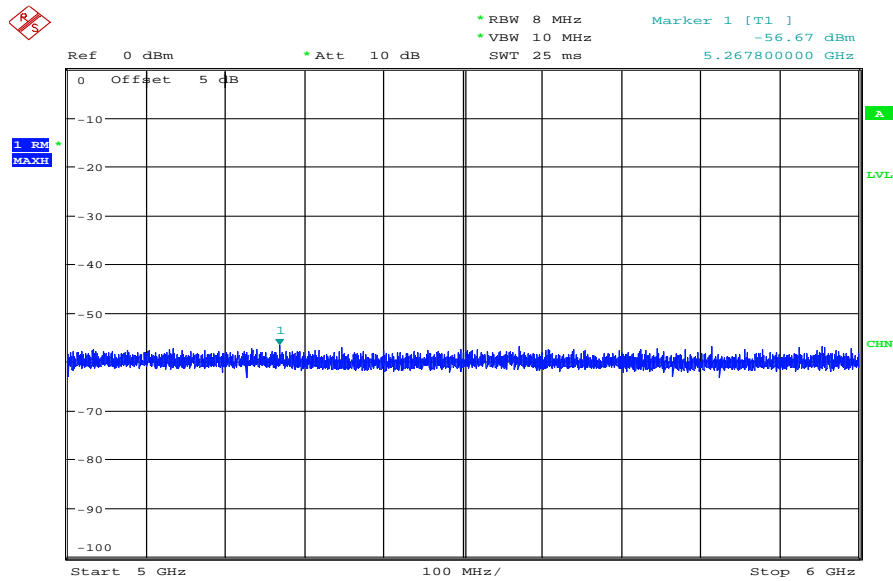

Date: 22.NOV.2012 14:47:49

The plot shows no transmissions over a 30 minutes period over the whole frequency band 5 GHz - 6 GHz.

2) Associated:

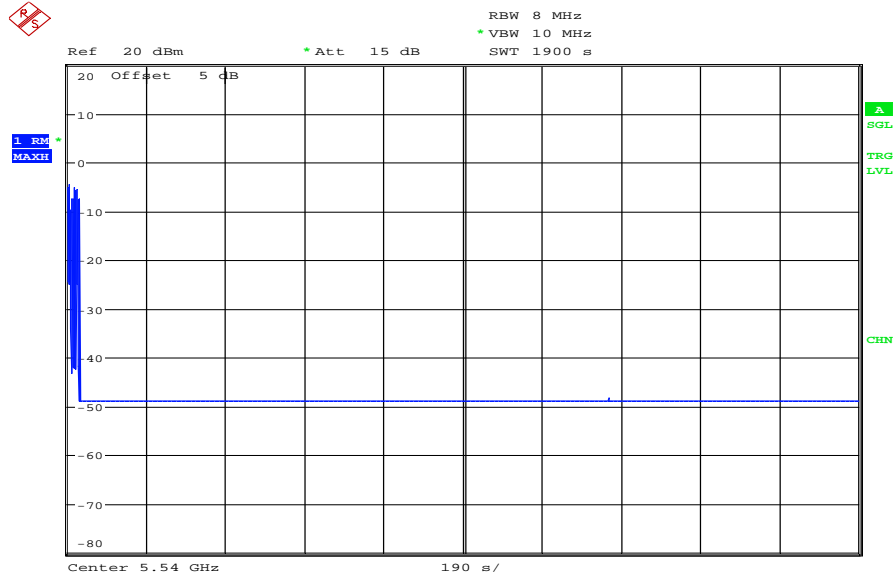

Date: 22.NOV.2012 16:25:46

In the plot above you can see, that the client does not transmit any emission within 30 minutes after having received the "stop transmit" order from the Access Point (DFS-Master).

Final verdict: Pass

9 Test equipment and ancillaries used for tests

Typically, the calibrations of the test apparatus are commissioned to and performed by an accredited calibration laboratory. The calibration intervals are determined in accordance with the DIN EN ISO/IEC 17025. In addition to the external calibrations, the laboratory executes comparison measurements with other calibrated test systems or effective verifications. Weekly chamber inspections and range calibrations are performed. Where possible, rf-generating and signalling equipment as well as measuring receivers and analyzers are connected to an external high-precision 10 MHz reference (GPS-based or rubidium frequency standard).

In order to simplify the identification of the equipment used at some special tests, some items of test equipment and ancillaries can be provided with an identifier or number in the equipment list below (Labor/Item).

No.	Lab / Item	Equipment	Type	Manufact.	Serial No.	INV. No Cetecom	Kind of Calibration	Last Calibration	Next Calibration
1	20	Directional Coupler	RBC90-10- SP	CMT	900687-008	300002117	ev		
2	21	Directional Coupler	RBC90-40- SP	CMT	900687-009	300002430	ne		
3	22	Directional Coupler	RBC90N F-10	CMT	900687-020	300002432	ne		
4	23	Directional Coupler	RBC90N F-40	CMT	900687-021	300002434	ne		
5	213	Attenuator SMA	K/SMA 20	Inmet Corp.		300002426	ev		
6	213	Attenuator SMA	K/SMA 30	Inmet Corp.		300002428	ev		
7	219	HF-Cable	KPS1533- 390-KPS	Insulated Wire		300002288	ev		
8	218	HF-Cable	KPS1533- 390-KPS	Insulated Wire		300002289	ev		
9	217	HF-Cable	KPS1533- 590-KPS	Insulated Wire		300002290	ev		
10	C005	HF-Cable 1.5 m 50 *	104PA	Suhner	1312/4PA	300002024	ev		
11	C009	HF-Cable 1.5 m 50 *	104PA	Suhner	1316/4PA	300002025	g		
12	C010	HF-Cable 1.5 m 50 *	104PA	Suhner	1298/4PA	300002026	g		
13	C004	HF-Cable 1.5 m 50 *	104PA	Suhner	1186/4PA	300002027	ev		
14	n. a.	Spectrum Analyzer 20 Hz - 50 GHz	FSU50	R&S	200012	300003443	Ve	09.10.2012	09.10.2014
15	n. a.	Vektor Signal Generator	SMU200A	R&S	101633	300003496	k	19.08.2011	19.08.2014

Agenda: Kind of Calibration

k	calibration / calibrated	EK	limited calibration
ne	not required (k, ev, izw, zw not required)	zw	cyclical maintenance (external cyclical maintenance)
ev	periodic self verification	izw	internal cyclical maintenance
Ve	long-term stability recognized	g	blocked for accredited testing
vlk!	Attention: extended calibration interval		
NK!	Attention: not calibrated	*)	next calibration ordered / currently in progress

10 Observations

No observations exceeding those reported with the single test cases have been made.

Annex A Photographs of the test setup

Photo documentation:

Photo 1:

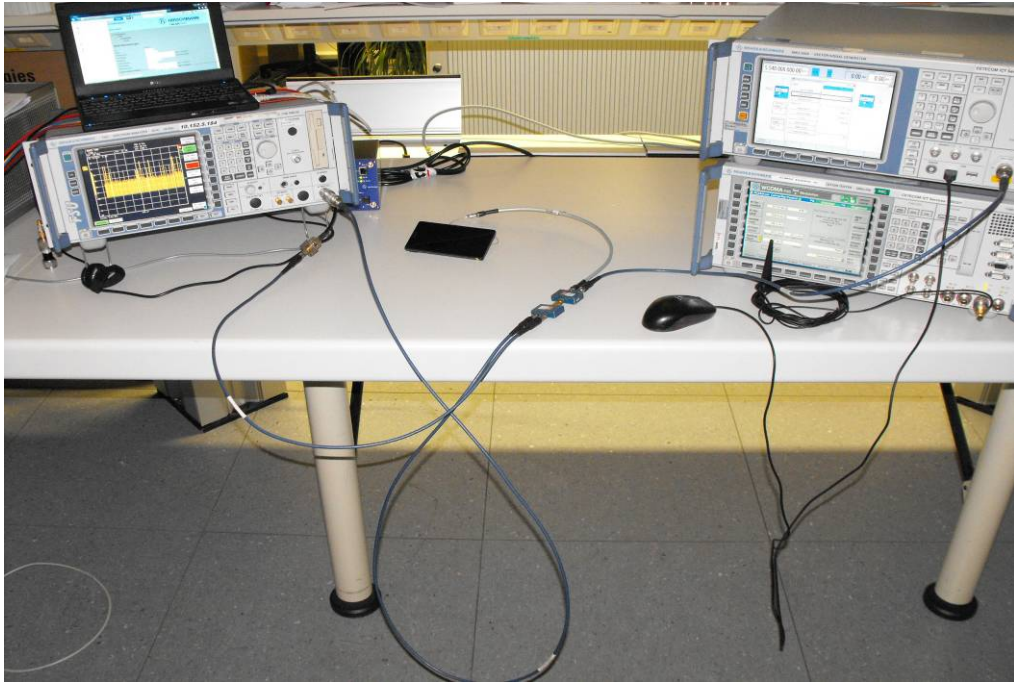

Annex B External photographs of the EUT

Photo documentation:

Photo 1:



Photo 2:



Photo 3:



Photo 4:



Photo 5:



Photo 6:



Photo 7:



Annex C Internal photographs of the EUT

Photo documentation:

Photo 1:



Photo 2:

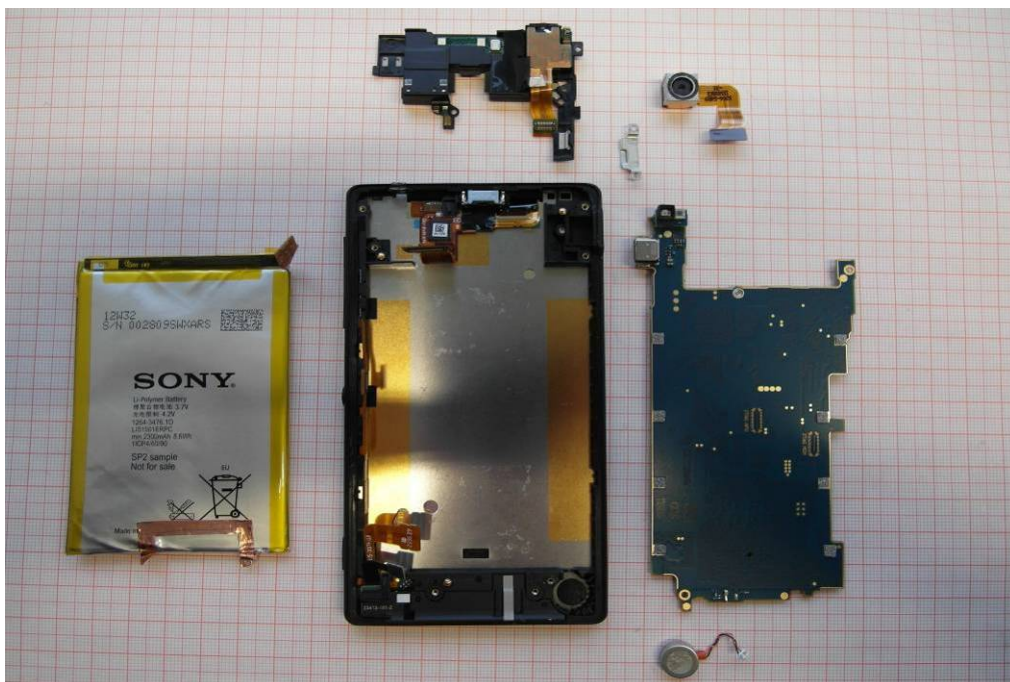

Photo 3:

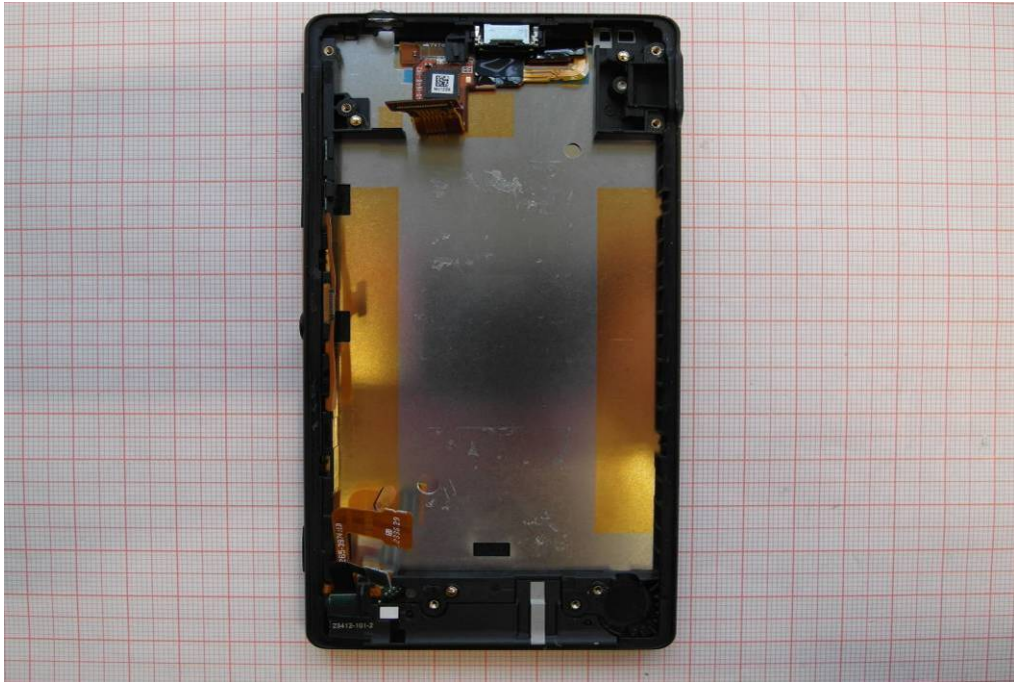

Photo 4:



Photo 5:

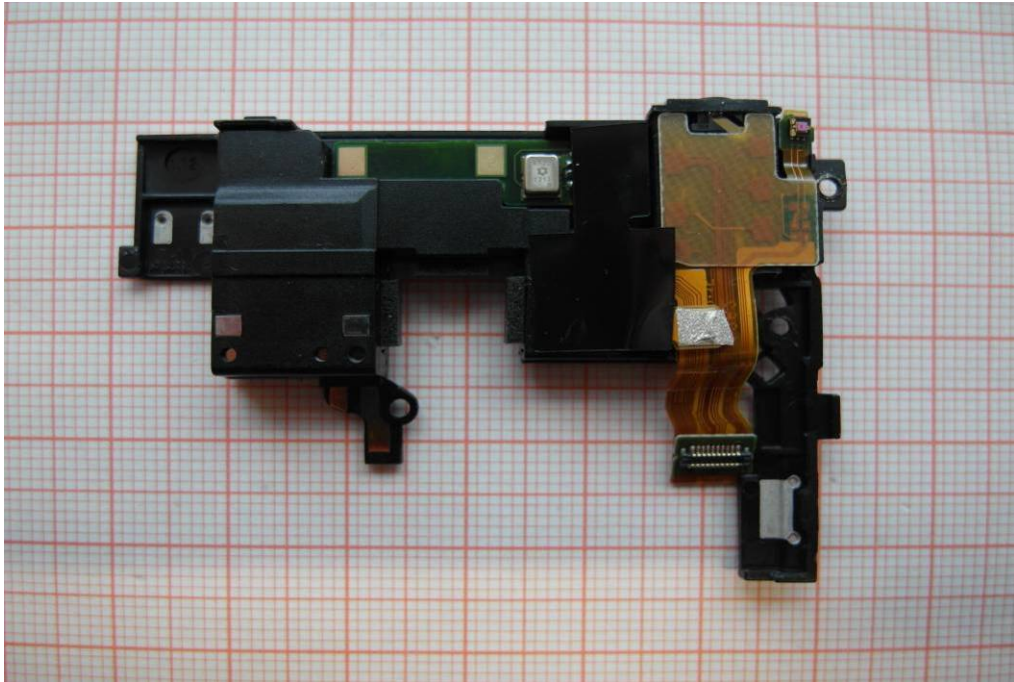

Photo 6:

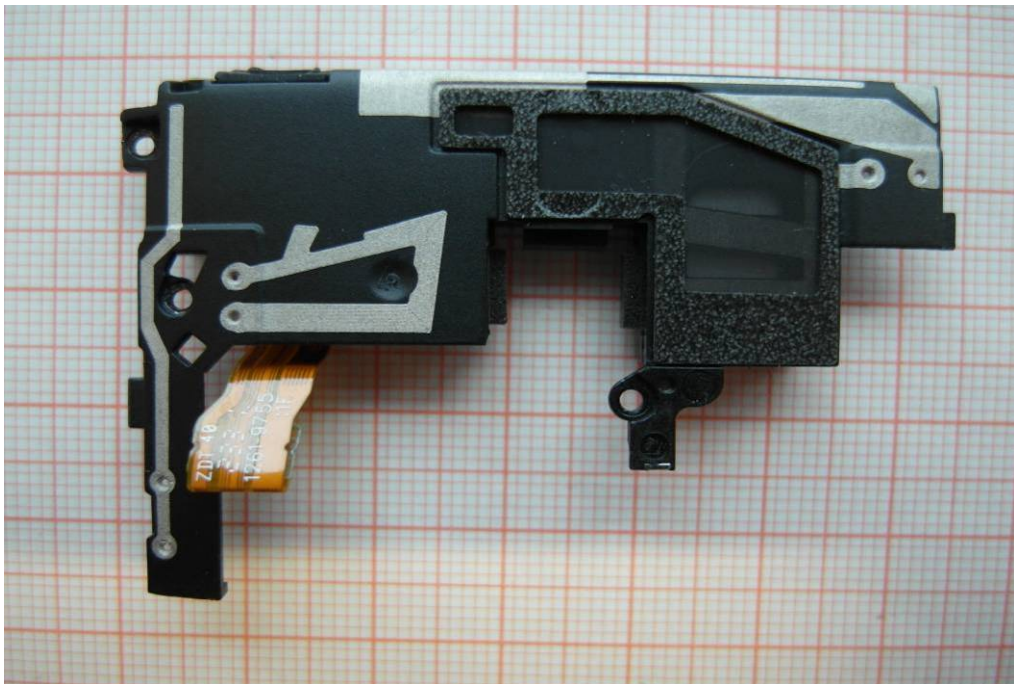

Photo 7:

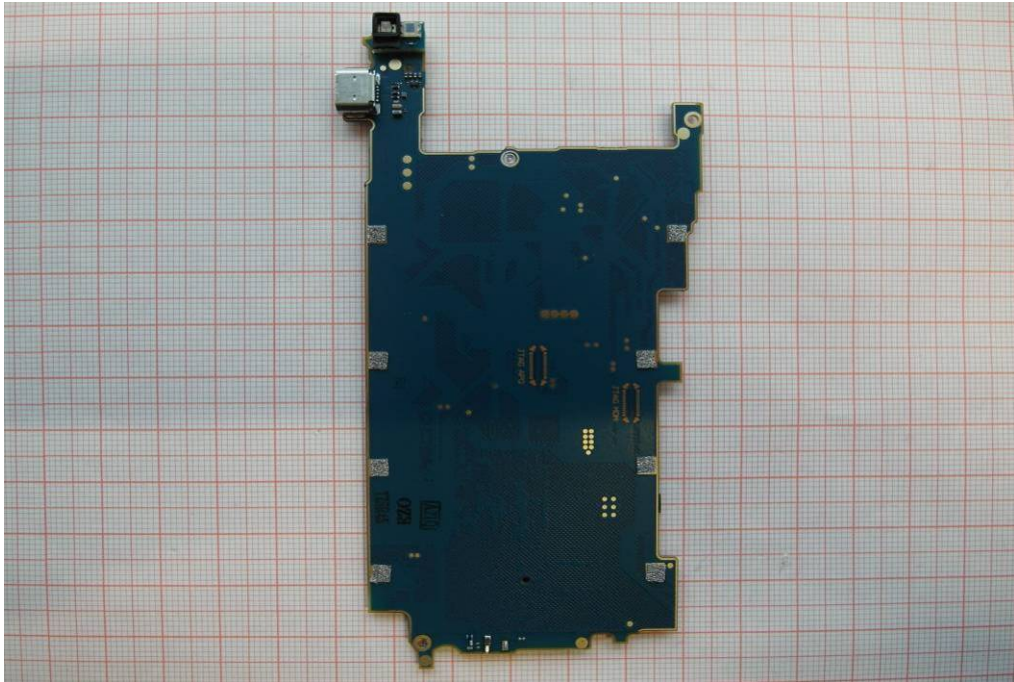

Photo 8:



Photo 9:

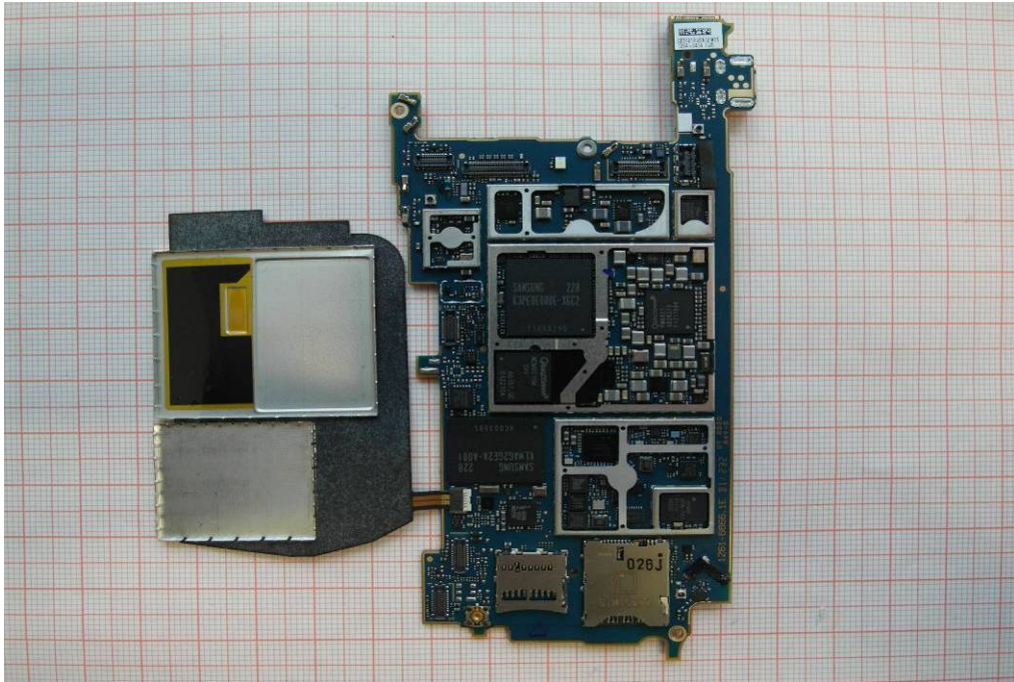

Photo 10:

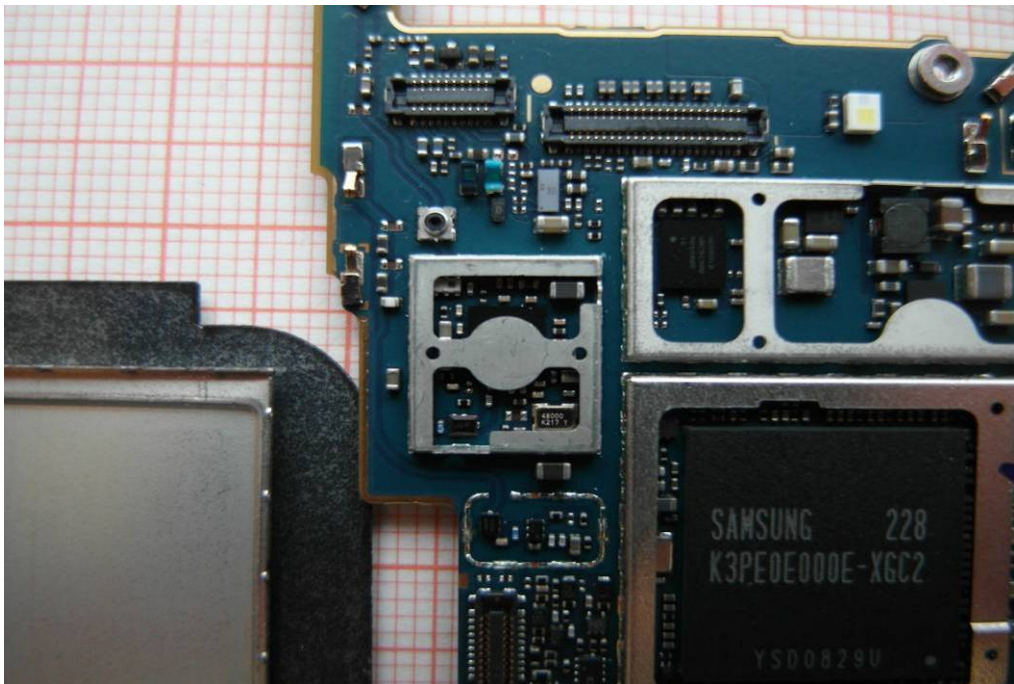

Photo 11:

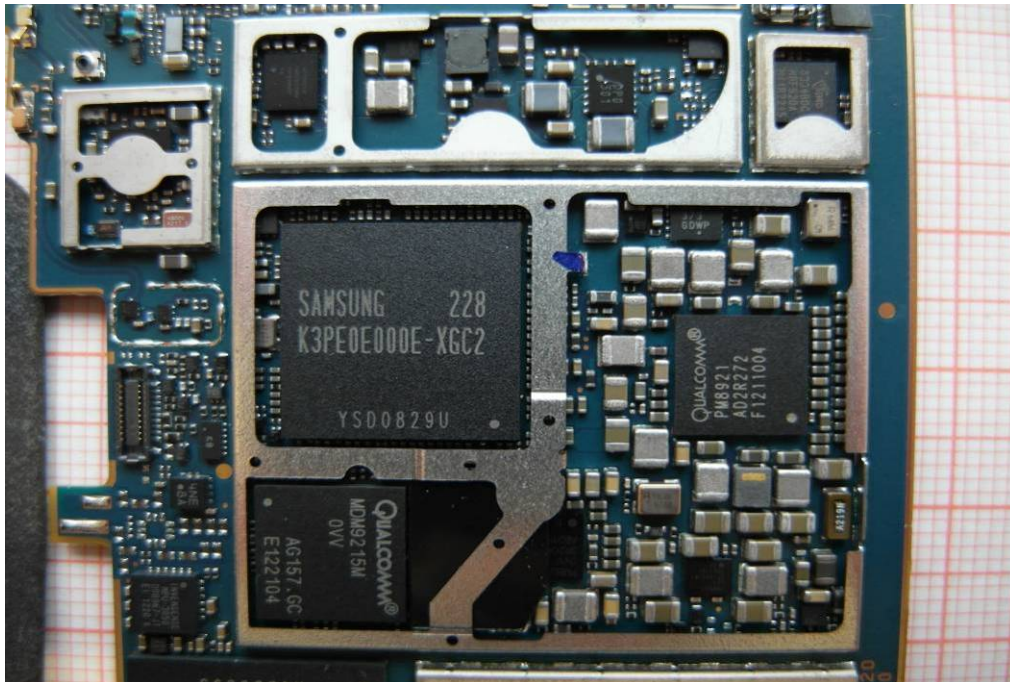
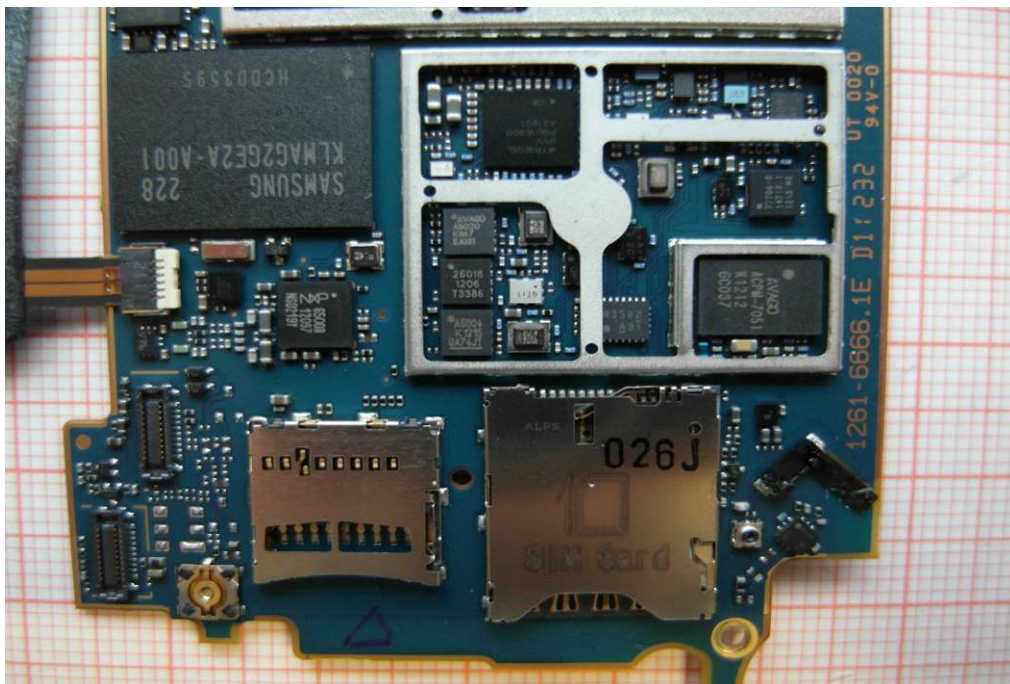

Photo 12:



Annex D Document history

Version	Applied changes	Date of release
1.0	Initial release	2012-11-26
-A	Additional information provided	2013-01-30

Annex E Further information**Glossary**

AVG	-	Average
DUT	-	Device under test
EMC	-	Electromagnetic Compatibility
EN	-	European Standard
EUT	-	Equipment under test
ETSI	-	European Telecommunications Standard Institute
FCC	-	Federal Communication Commission
FCC ID	-	Company Identifier at FCC
HW	-	Hardware
IC	-	Industry Canada
Inv. No.	-	Inventory number
N/A	-	Not applicable
PP	-	Positive peak
QP	-	Quasi peak
S/N	-	Serial number
SW	-	Software

Annex F Accreditation Certificate



Front side of certificate



Back side of certificate

Note:

The current certificate including annex is published on our website (see link below) or may be received from CETECOM ICT Services on request.

http://www.cetecom.com/fileadmin/de/CETECOM_D_Saarbruecken/accreditations_Jan_2010/DAKKS_Akkredi_Urk_EN17025-En_incl_Annex.pdf