

TEST REPORT

Test report no.: 1-4254/12-62-05



Testing laboratory

CETECOM ICT Services GmbH
 Untertuerkheimer Strasse 6 – 10
 66117 Saarbruecken / Germany
 Phone: + 49 681 5 98 - 0
 Fax: + 49 681 5 98 - 9075
 Internet: <http://www.cetecom.com>
 e-mail: ict@cetecom.com

Accredited Testing Laboratory:

The testing laboratory (area of testing) is accredited according to DIN EN ISO/IEC 17025 (2005) by the Deutsche Akkreditierungsstelle GmbH (DAkkS)
 The accreditation is valid for the scope of testing procedures as stated in the accreditation certificate with the registration number: D-PL-12076-01-01
 Area of Testing: Radio/Satellite Communications

Applicant

Sony Mobile Communications AB
 Nya Vattentorget
 22188 Lund / SWEDEN
 Phone: +46 46 19 30 00
 Fax: +46 46 19 32 95
 Contact: Håkan Sjöberg
 e-mail: hakan.sjoberg@sonymobile.com
 Phone: +46 46 19 35 59

Manufacturer

Sony Mobile Communications AB
 Nya Vattentorget
 22188 Lund / SWEDEN

Test standard/s

47 CFR Part 15	Title 47 of the Code of Federal Regulations; Chapter I Part 15 - Radio frequency devices
RSS - 210 Issue 8	Spectrum Management and Telecommunications - Radio Standards Specification Low-power Licence-exempt Radiocommunication Devices (All Frequency Bands): Category I Equipment

For further applied test standards please refer to section 3 of this test report.

Test Item

Kind of test item:	GSM Mobile Phone GPRS/EGPRS 850/900/1800/1900; UMTS HSPA FDDI/III/IV/V/VIII; LTE FDD 1/2/4/5/17; WLAN a/b/g/n; BT 3.1; BT LE; RFID; FM Rx; A-GPS
Model name:	PM-0230-BV
FCC ID:	PY7PM-0230
IC:	4170B-PM0230
Frequency:	ISM band 2400 MHz to 2483.5 MHz (lowest channel 00 – 2402 MHz, highest channel 39 – 2480 MHz)
Technology tested:	Bluetooth® LE
Antenna:	Integrated antenna
Power Supply:	3.7 V DC by Li - polymer battery
Temperature Range:	-20°C to +55 °C

Test report authorised:

 2012-11-21 Stefan Bös
 Senior Testing Manager

Test performed:

 2012-11-21 Marco Bertolino
 Testing Manager

1 Table of contents

1 Table of contents2

2 General information3

 2.1 Notes and disclaimer3

 2.2 Application details.....3

3 Test standard/s3

4 Test environment.....4

5 Test item4

6 Test laboratories sub-contracted4

7 Summary of measurement results5

8 RF measurements6

 8.1 Description of test setup6

 8.1.1 Radiated measurements.....6

 8.1.2 Conducted measurements.....7

 8.2 Additional comments7

 8.3 RSP100 test report cover sheet / performance test data8

9 Measurement results.....9

 9.1 Antenna gain9

 9.2 Power spectral density10

 9.3 Carrier frequency separation13

 9.4 Number of hopping channels15

 9.5 Time of occupancy (dwell time)17

 9.6 Spectrum bandwidth of a FHSS system – 6 dB bandwidth18

 9.7 Spectrum bandwidth of a FHSS system – 20 dB bandwidth21

 9.8 Maximum output power24

 9.9 Band edge compliance conducted27

 9.10 Band edge compliance radiated.....30

 9.11 TX spurious emissions conducted32

 9.12 TX spurious emissions radiated.....35

 9.13 RX spurious emissions radiated46

 9.14 Spurious emissions radiated < 30 MHz50

 9.15 Spurious emissions conducted < 30 MHz52

10 Test equipment and ancillaries used for tests55

11 Observations56

Annex A Photographs of the test setup57

Annex B External photographs of the EUT61

Annex C Internal photographs of the EUT65

Annex D Document history72

Annex E Further information.....72

Annex F Accreditation Certificate73

2 General information

2.1 Notes and disclaimer

The test results of this test report relate exclusively to the test item specified in this test report. CETECOM ICT Services GmbH does not assume responsibility for any conclusions and generalizations drawn from the test results with regard to other specimens or samples of the type of the equipment represented by the test item.

The test report may only be reproduced or published in full. Reproduction or publication of extracts from the report requires the prior written approval of CETECOM ICT Services GmbH.

The testing service provided by CETECOM ICT Services GmbH has been rendered under the current "General Terms and Conditions for CETECOM ICT Services GmbH".

CETECOM ICT Services GmbH will not be liable for any loss or damage resulting from false, inaccurate, inappropriate or incomplete product information provided by the customer.

Under no circumstances does the CETECOM ICT Services GmbH test report include any endorsement or warranty regarding the functionality, quality or performance of any other product or service provided.

Under no circumstances does the CETECOM ICT Services GmbH test report include or imply any product or service warranties from CETECOM ICT Services GmbH, including, without limitation, any implied warranties of merchantability, fitness for purpose, or non-infringement, all of which are expressly disclaimed by CETECOM ICT Services GmbH.

All rights and remedies regarding vendor's products and services for which CETECOM ICT Services GmbH has prepared this test report shall be provided by the party offering such products or services and not by CETECOM ICT Services GmbH.

In no case this test report can be considered as a Letter of Approval.

2.2 Application details

Date of receipt of order:	2012-11-06
Date of receipt of test item:	2012-11-12
Start of test:	2012-11-15
End of test:	2012-11-19
Person(s) present during the test:	-/-

3 Test standard/s

Test standard	Date	Test standard description
47 CFR Part 15	2010-10	Title 47 of the Code of Federal Regulations; Chapter I Part 15 - Radio frequency devices
RSS - 210 Issue 8	2010-12	Spectrum Management and Telecommunications - Radio Standards Specification Low-power Licence-exempt Radiocommunication Devices (All Frequency Bands): Category I Equipment

4 Test environment

Temperature:	T_{nom}	+22 °C during room temperature tests
	T_{max}	+55 °C during high temperature tests
	T_{min}	-20 °C during low temperature tests
Relative humidity content:		48 %
Barometric pressure:		not relevant for this kind of testing
Power supply:	V_{nom}	3.7 V DC by Li - polymer battery
	V_{max}	4.1 V
	V_{min}	3.3 V

5 Test item

Kind of test item	:	GSM Mobile Phone GPRS/EGPRS 850/900/1800/1900; UMTS HSPA FDD/III/IV/V/VIII; LTE FDD 1/2/4/5/17; WLAN a/b/g/n; BT 3.1; BT LE; RFID; FM Rx; A-GPS
Type identification	:	PM-0230-BV
S/N serial number	:	Radiated units: CB5121Z4EJ, CB5121Z4DC Conducted units: CB5121Z4GS, CB5121Z4CU
HW hardware status	:	SP1.2
SW software status	:	10.1.A.0.194 and 10.1.A.1.17
Frequency band [MHz]	:	ISM band 2400 MHz to 2483.5 MHz (lowest channel 00 – 2402 MHz, highest channel 39 – 2480 MHz)
Type of radio transmission	:	DSSS, FHSS
Use of frequency spectrum	:	
Channel access method	:	FDMA
Type of modulation	:	GFSK
Number of channels	:	40
Antenna	:	Integrated antenna
Power supply	:	3.7 V DC by Li - polymer battery
Temperature range	:	-20°C to +55 °C

6 Test laboratories sub-contracted

None

7 Summary of measurement results



No deviations from the technical specifications were ascertained



There were deviations from the technical specifications ascertained

TC Identifier	Description	Verdict	Date	Remark
RF-Testing	CFR Part 15 RSS 210, Issue 8, Annex 8	Passed	2012-11-21	-/-

Test specification clause	Test case	Temperature conditions	Power source voltages	Mode	Pass	Fail	NA	NP	Remark
§15.247(b)(4) RSS 210 / A8.4(2)	Antenna gain	Nominal	Nominal	GFSK	<input checked="" type="checkbox"/>	<input type="checkbox"/>	<input type="checkbox"/>	<input type="checkbox"/>	complies
§15.247(e) RSS 210 / A8.2(b)	Power spectral density	Nominal	Nominal	GFSK	<input checked="" type="checkbox"/>	<input type="checkbox"/>	<input type="checkbox"/>	<input type="checkbox"/>	complies
§15.247(a)(1) RSS 210 / A8.1(b)	Carrier frequency separation	Nominal	Nominal	GFSK	<input checked="" type="checkbox"/>	<input type="checkbox"/>	<input type="checkbox"/>	<input type="checkbox"/>	complies
§15.247(a)(1) RSS 210 / A8.1(d)	Number of hopping channels	Nominal	Nominal	GFSK	<input checked="" type="checkbox"/>	<input type="checkbox"/>	<input type="checkbox"/>	<input type="checkbox"/>	complies
§15.247(a)(1) (iii) RSS 210 / A8.3(1)	Time of occupancy (dwell time)	Nominal	Nominal	GFSK	<input checked="" type="checkbox"/>	<input type="checkbox"/>	<input type="checkbox"/>	<input type="checkbox"/>	complies
§15.247(a)(2) RSS 210 / A8.2(a)	Spectrum bandwidth of a FHSS system 6 dB bandwidth	Nominal	Nominal	GFSK	<input checked="" type="checkbox"/>	<input type="checkbox"/>	<input type="checkbox"/>	<input type="checkbox"/>	complies
§15.247(a)(1) RSS 210	Spectrum bandwidth of a FHSS system 20 dB bandwidth	Nominal	Nominal	GFSK	<input checked="" type="checkbox"/>	<input type="checkbox"/>	<input type="checkbox"/>	<input type="checkbox"/>	complies
§15.247(b)(1) RSS-210 / A8.4(2)	Maximum output power	Nominal	Nominal	GFSK	<input checked="" type="checkbox"/>	<input type="checkbox"/>	<input type="checkbox"/>	<input type="checkbox"/>	complies
§15.247(d) RSS-210 / A8.5	Band edge compliance conducted	Nominal	Nominal	GFSK	<input checked="" type="checkbox"/>	<input type="checkbox"/>	<input type="checkbox"/>	<input type="checkbox"/>	complies
§15.205 RSS-210 / A8.5	Band edge compliance radiated	Nominal	Nominal	GFSK	<input checked="" type="checkbox"/>	<input type="checkbox"/>	<input type="checkbox"/>	<input type="checkbox"/>	complies
§15.247(d) RSS-210 / A8.5	TX spurious emissions conducted	Nominal	Nominal	GFSK	<input checked="" type="checkbox"/>	<input type="checkbox"/>	<input type="checkbox"/>	<input type="checkbox"/>	complies
§15.247(d) RSS-210 / A8.5	TX spurious emissions radiated	Nominal	Nominal	GFSK	<input checked="" type="checkbox"/>	<input type="checkbox"/>	<input type="checkbox"/>	<input type="checkbox"/>	complies
§15.109 RSS-Gen.	RX spurious emissions radiated	Nominal	Nominal	-/-	<input checked="" type="checkbox"/>	<input type="checkbox"/>	<input type="checkbox"/>	<input type="checkbox"/>	complies
§15.209(a) RSS-Gen	TX spurious emissions radiated < 30 MHz	Nominal	Nominal	GFSK	<input checked="" type="checkbox"/>	<input type="checkbox"/>	<input type="checkbox"/>	<input type="checkbox"/>	complies
§15.107(a)	Conducted emissions < 30 MHz	Nominal	Nominal	GFSK	<input checked="" type="checkbox"/>	<input type="checkbox"/>	<input type="checkbox"/>	<input type="checkbox"/>	complies

Note: NA = Not Applicable; NP = Not Performed

8 RF measurements

8.1 Description of test setup

8.1.1 Radiated measurements

The radiated measurements are performed in vertical and horizontal plane in the frequency range from 9 kHz to 25 GHz in semi-anechoic chambers. The EUT is positioned on a non-conductive support with a height of 0.80 m above a conductive ground plane that covers the whole chamber. The receiving antennas are confirmed with specifications ANSI C63.2-1996 clause 15 and ANSI C63.4-2009 clause 4.1.5. These antennas can be moved over the height range between 1.0 m and 4.0 m in order to search for maximum field strength emitted from EUT. The measurement distances between EUT and receiving antennas are indicated in the test setups for the various frequency ranges. For each measurement, the EUT is rotated in all three axes until the maximum field strength is received. The wanted and unwanted emissions are received by spectrum analysers where the detector modes and resolution bandwidths over various frequency ranges are set according to requirement ANSI C63-4-2009 clause 4.2.

Antennas are confirmed with ANSI C63.2-1996 item 15.

Semi anechoic chamber

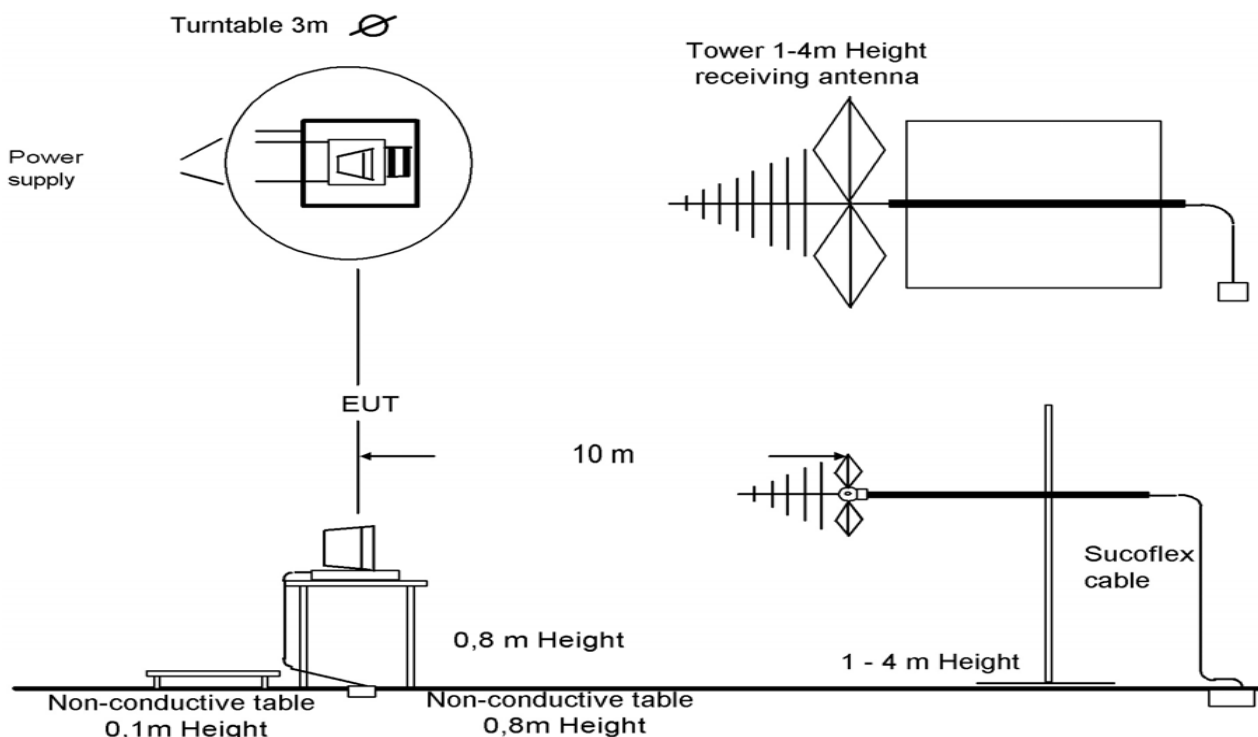

Picture 1: Diagram radiated measurements

9 kHz - 30 MHz:	active loop antenna
30 MHz – 1 GHz:	tri-log antenna
> 1 GHz:	horn antenna

All measurements are done in accordance with the Filing and Measurement Guidelines for Frequency Hopping Spread Spectrum Systems DA 00-705 and Appendix A “BLUETOOTH® APPROVALS”

The EUT is powered by an external power supply with nominal voltage. The signalling is performed from outside the chamber with a signalling unit (CMU200 or other) by air link using signalling antenna.

8.1.2 Conducted measurements

The EUT's RF signal is coupled out by the antenna connector which is supplied by the manufacturer. The signal is first 10dB attenuated before it is power divided (~6dB loss per branch). One of the signal paths is connected to the communication base Station (CMU200 or other), the other one is connected to the spectrum analyzer. The specific losses for both signal paths are first checked within a calibration. The measurement readings on the signalling unit/spectrum analyzer are corrected by the specific test set-up loss. The attenuator, power divider, signalling unit and the spectrum analyzer are impedance matched on 50 Ohm.

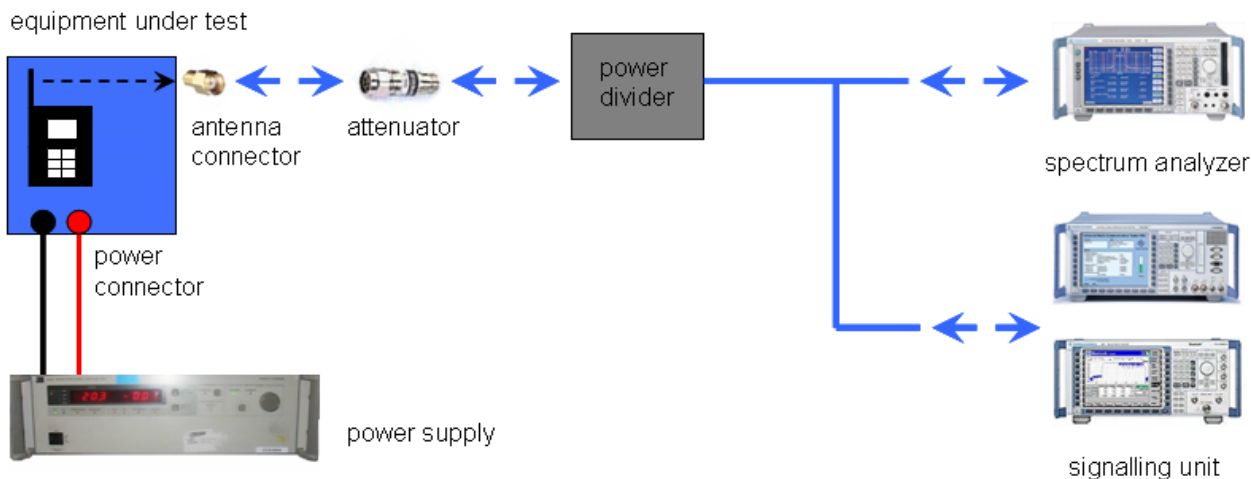

Picture 2: Diagram conducted measurements

8.2 Additional comments

The Bluetooth® word mark and logos are owned by the Bluetooth SIG Inc. and any use of such marks by Cetecom ICT Services GmbH is under license.

- Reference documents: None

- Special test descriptions: None

- Configuration descriptions: TX tests: were performed with LE packets (37 byte payload) and static PRBS pattern.
 RX/Standby tests: BT enabled, TX Idle

- Test mode: Bluetooth LE Test mode enabled (EUT is controlled over CBT)
- Special software is used.
 EUT is transmitting pseudo random data by itself

8.3 RSP100 test report cover sheet / performance test data

Test report number	:	1-4254/12-62-05
Equipment model number	:	PM-0230-BV
Certification number	:	4170B-PM0230
Manufacturer (complete address)	:	Sony Mobile Communications AB Nya Vattentornet 22188 Lund / SWEDEN
Tested to radio standards specification no.	:	RSS 210, Issue 8, Annex 8
Open area test site IC No.	:	IC 3462C-1
Frequency range	:	Lowest channel 2402 MHz, highest channel 2480 MHz
RF-power [mW] (max.)	:	Cond.: 0.48 mW (GFSK) EIRP: 0.24 mW (GFSK)
Occupied bandwidth (99%-BW) [kHz]	:	1130 (GFSK)
Type of modulation	:	GFSK
Emission designator (TRC-43)	:	1M13FXD (GFSK)
Antenna information	:	Integrated antenna
Transmitter spurious (worst case)	:	48 @ 12.5 GHz (noise floor / peak)
Receiver spurious (worst case)	:	48 @ 12.5 GHz (noise floor / peak)

ATTESTATION:

DECLARATION OF COMPLIANCE:

I attest that the testing was performed or supervised by me; that the test measurements were made in accordance with the above-mentioned Industry Canada standard(s); and that the equipment identified in this application has been subjected to all the applicable test conditions specified in the Industry Canada standards and all of the requirements of the standard have been met.

Laboratory manager:

2012-11-21

Date

Marco Bertolino

Name



Signature

9 Measurement results

9.1 Antenna gain

Measurement:

The antenna gain of the complete system is calculated by the difference of radiated power in EIRP and the conducted power of the module. For normal Bluetooth® devices, the GFSK modulation is used.

Measurement parameters:

Measurement parameter	
Detector:	Peak
Sweep time:	Auto
Resolution bandwidth:	3 MHz
Video bandwidth:	3 MHz
Span:	5 MHz
Trace-Mode:	Max hold

Limits:

FCC	IC
Antenna Gain	
6 dBi	

Results:

T_{nom}	V_{nom}	lowest channel 2402 MHz	middle channel 2440 MHz	highest channel 2480 MHz
Conducted power [dBm] Measured with GFSK modulation		-3.4	-3.2	-3.5
Radiated power [dBm] Measured with GFSK modulation		-6.2	-6.7	-7.3
Gain [dBi] Calculated		-2.8	-3.5	-3.8

Result: **Passed**

9.2 Power spectral density

Description:

Measurement of the power spectral density of a digital modulated system.

Measurement:

Measurement parameter	
Detector:	Peak
Sweep time:	Auto
Resolution bandwidth:	100 kHz
Video bandwidth:	300 kHz
Span:	≥ EBW
Trace-Mode:	Max Hold
Bandwidth correction factor:	-15.2 dB

Limits:

FCC	IC
Power Spectral Density	
For digitally modulated systems the transmitter power spectral density conducted from the transmitter to the antenna shall not be greater than 8 dBm in any 3 kHz band during any time interval of continuous transmission or over 1.0 second if the transmission exceeds 1.0-second duration.	

Results:

Modulation Frequency	Power spectral density		
	2402 MHz	2440 MHz	2480 MHz
[dBm / 100kHz]	-4.01	-3.77	-4.06
[dBm / 3kHz]	-19.21	-18.97	-19.26
Measurement uncertainty	± 1.5 dB		

Plots:

Plot 1: lowest channel

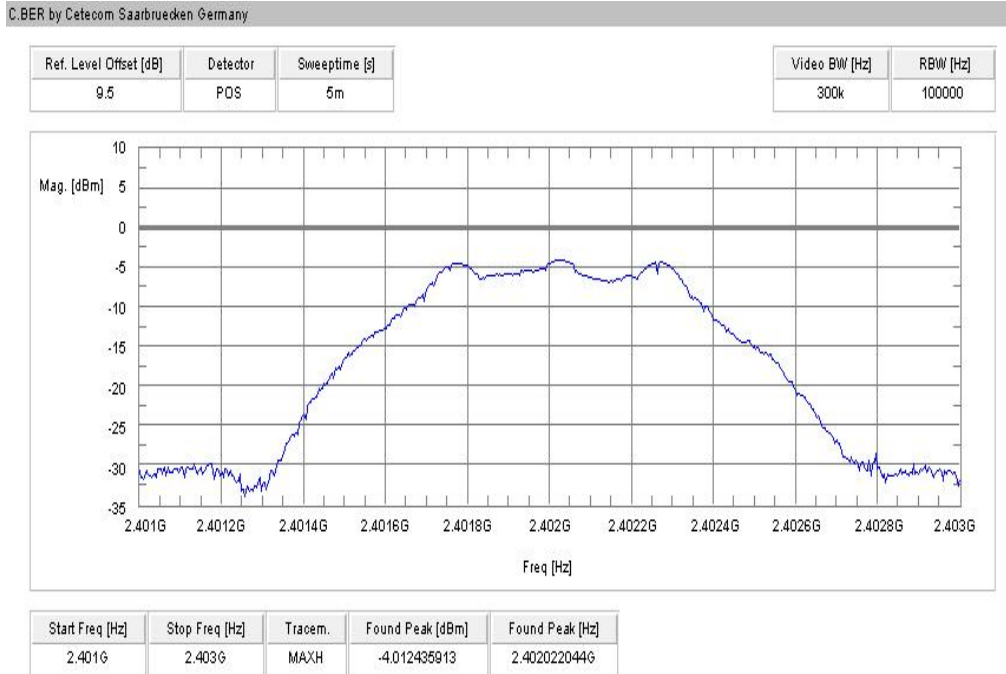

Plot 2: mid channel

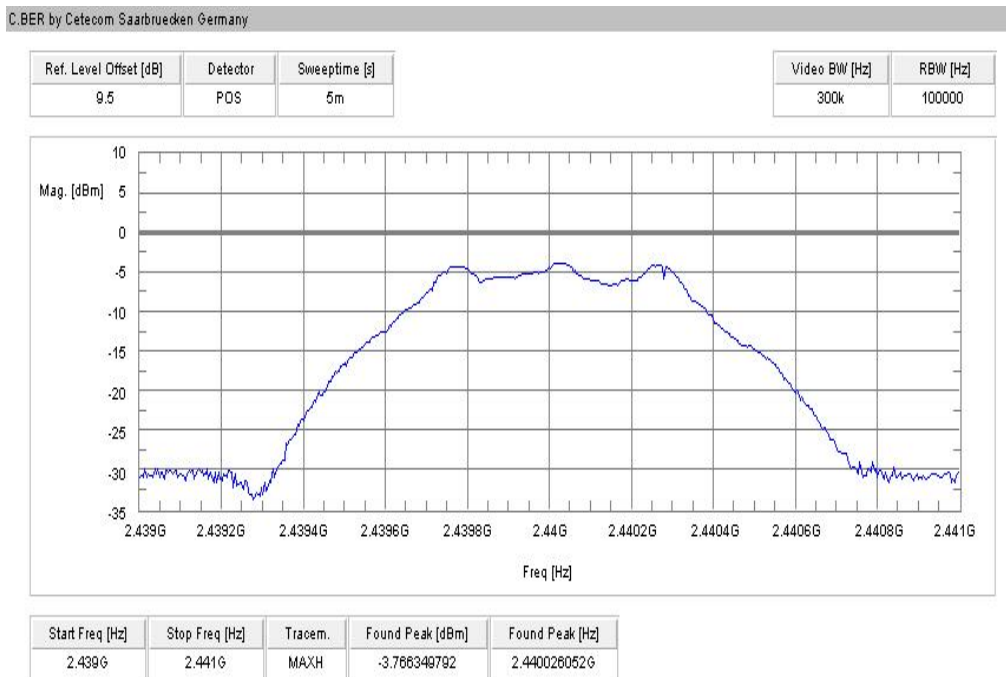

Plot 3: highest channel

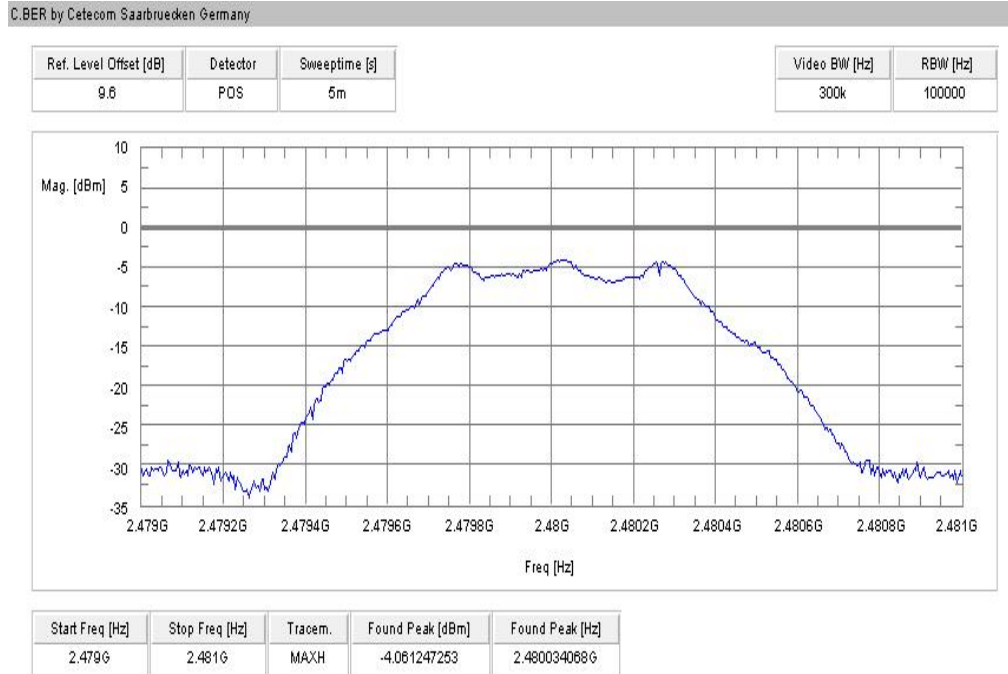

9.3 Carrier frequency separation

Description:

Measurement of the carrier frequency separation of a hopping system. We use GFSK modulation to show compliance. EUT in hopping mode.

Measurement:

Measurement parameter	
Detector:	Peak
Sweep time:	Auto
Resolution bandwidth:	100 kHz
Video bandwidth:	100 kHz
Span:	4 MHz
Trace-Mode:	Max Hold

Limits:

FCC	IC
Carrier Frequency Separation	
Minimum 25 kHz or two-thirds of the 20 dB bandwidth of the hopping system whichever is greater.	

Result:

Carrier frequency separation	~ 2 MHz
------------------------------	---------

Result: Passed

Plot:

Plot 1: Carrier Frequency Separation

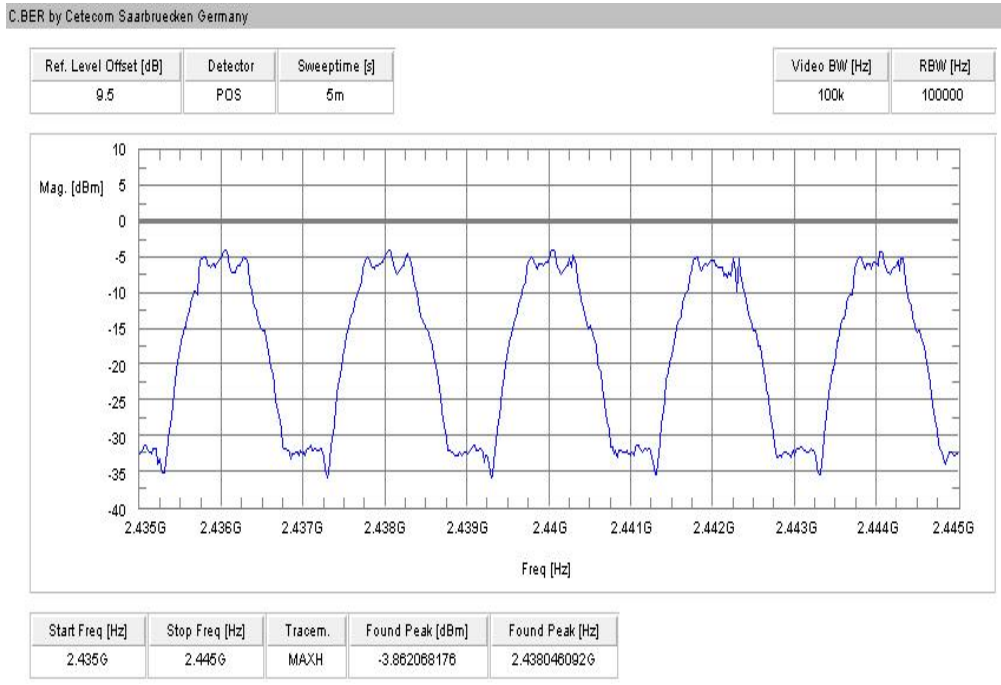

9.4 Number of hopping channels

Description:

Measurement of the total number of used hopping channels. The number of hopping channels is constant for all modulation-modes. We use GFSK modulation to show compliance. EUT in hopping mode.

Measurement:

Measurement parameter	
Detector:	Peak
Sweep time:	Auto
Resolution bandwidth:	500 kHz
Video bandwidth:	500 kHz
Span:	Plot 1: 2400 – 2445 MHz Plot 2: 2445 – 2485 MHz
Trace-Mode:	Max Hold

Limits:

FCC	IC
Number of hopping channels	
At least 15 non overlapping hopping channels	

Result:

Number of hopping channels	40
----------------------------	----

Result: Passed

Plots:

Plot 1: Number of hopping channels

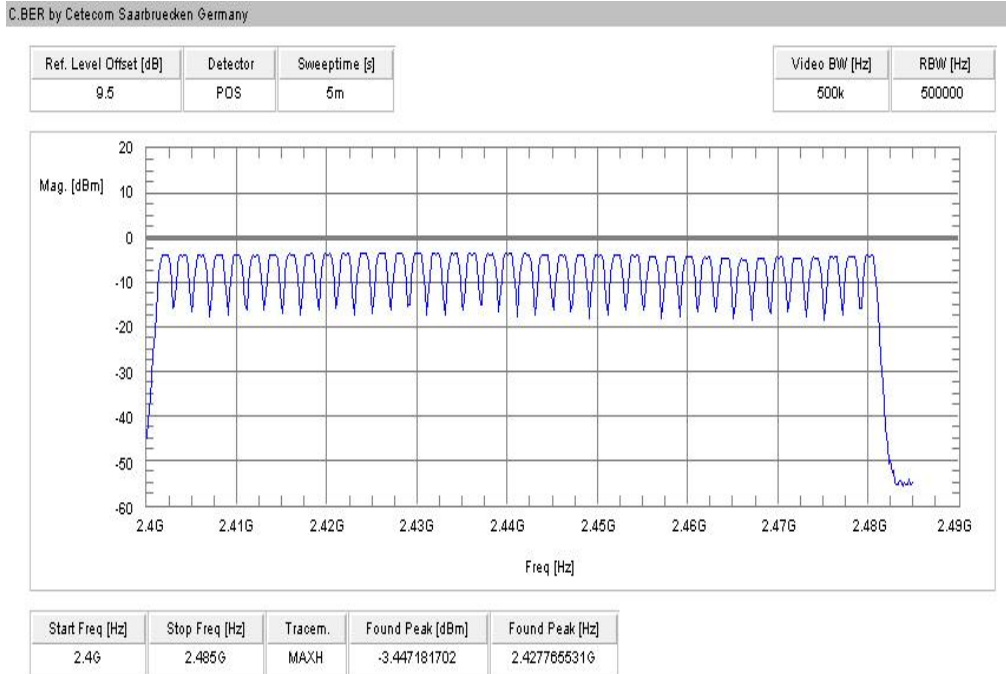

9.5 Time of occupancy (dwell time)

Measurement:

Measuring/calculation of the pulse width in data transmit mode on one hopping channel for a Bluetooth® LE device.

Measurement parameters:

Detector: Peak
 Video bandwidth: 1 MHz
 Resolution bandwidth: 1 MHz
 Span: Zero Span
 Trace: Video triggered

For Bluetooth® LE devices:

Time slot length: 625us
 Number of channels: 40
 Number of time slots per second: 1600/s
 Max. number of transmissions per channel in 1 s: $1600/s / 40 = 40$
 Max. number of transmissions per channel in 16 s: $40 \times 16 = 640$
 Period: Number of channels \times 0.4s = 16s

Under normal test conditions only	400 ms within in a period
-----------------------------------	---------------------------

Results:

Dwell time = standard test packet pulse width*) \times number of transmission per channel in 15.6 seconds

Packet type	standard test packet pulse width [ms]	number of hops in 16 sec	calculated dwell time[ms]
Data Transmit mode	0.376	640	241

*) For Bluetooth® LE devices no measurements are mandatory due to the fixed requirements of the Bluetooth® Core Specification. The standard test packet is defined as:

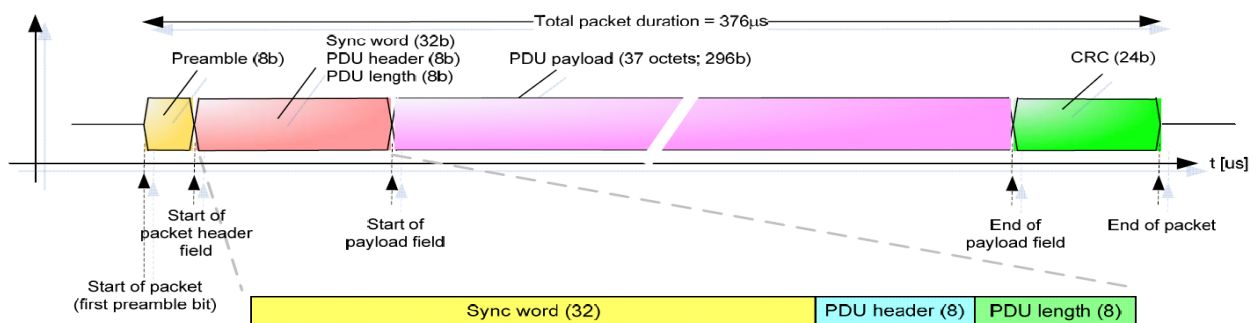

Result: Passed

9.6 Spectrum bandwidth of a FHSS system – 6 dB bandwidth

Description:

Measurement of the 6 dB bandwidth of the modulated signal.

Measurement:

Measurement parameter	
Detector:	Peak
Sweep time:	2 s
Resolution bandwidth:	20 kHz
Video bandwidth:	20 kHz
Span:	3 MHz
Trace-Mode:	Max Hold

Limits:

FCC	IC
Spectrum bandwidth of a FHSS system – 6 dB bandwidth	
> 500 kHz	

Results:

Modulation Frequency	6 dB BANDWIDTH [kHz]		
	2402 MHz	2440 MHz	2480 MHz
GFSK	655	649	649
Measurement uncertainty	± 20 kHz		

Result: Passed

Plots:

Plot 1: lowest channel

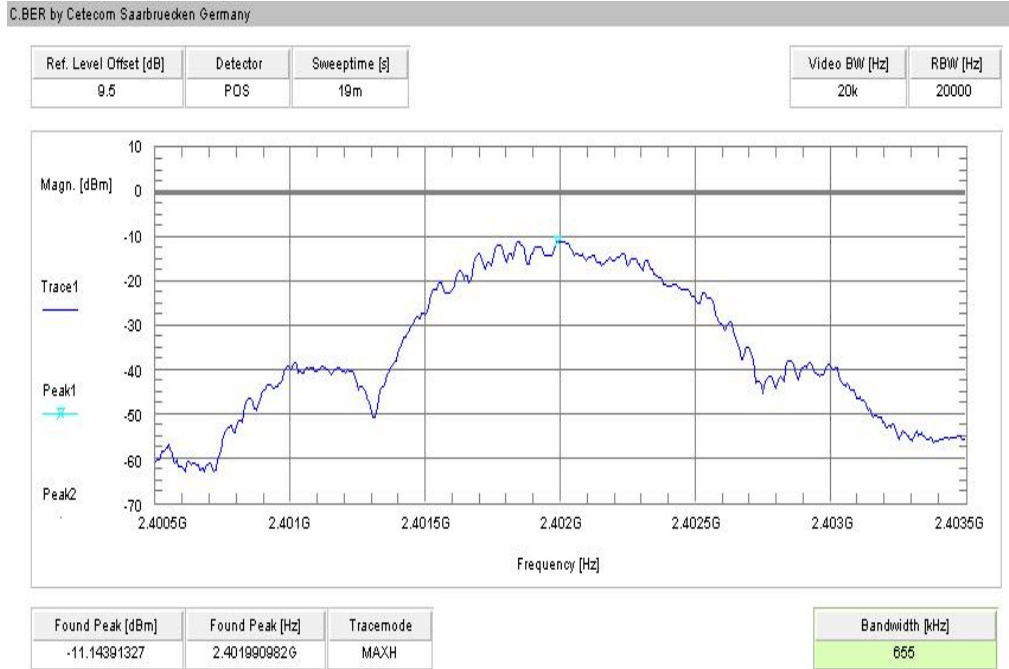

Plot 2: mid channel

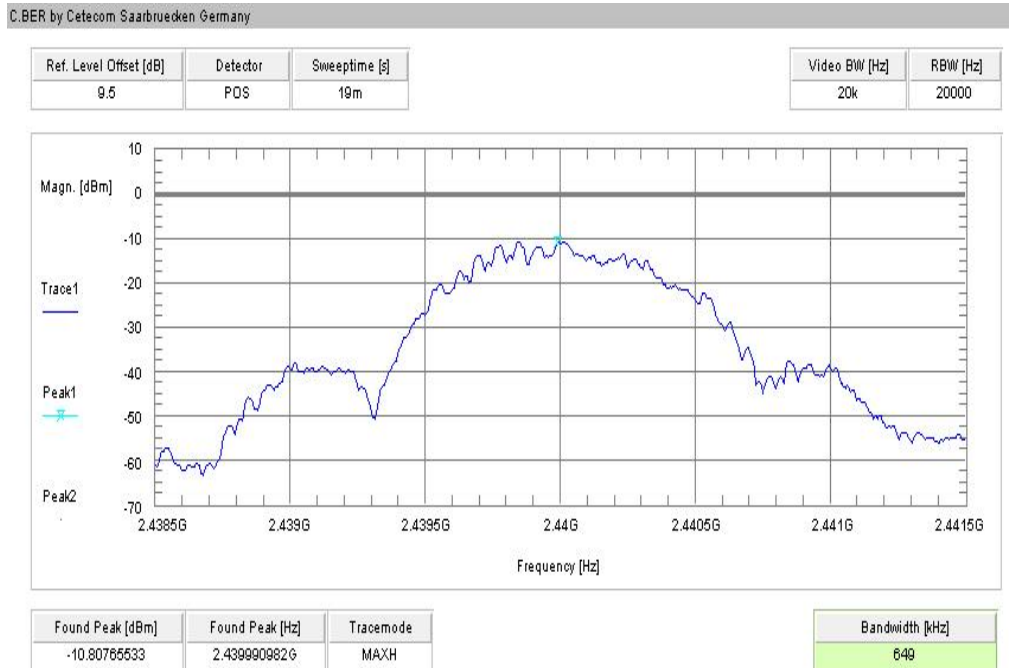

Plot 3: highest channel



9.7 Spectrum bandwidth of a FHSS system – 20 dB bandwidth

Description:

Measurement of the 20 dB bandwidth of the modulated signal. The measurement is performed according to the “Measurement Guidelines” (DA 00-705, March 30, 2000). EUT in single channel mode.

Measurement:

Measurement parameter	
Detector:	Peak
Sweep time:	2 s
Resolution bandwidth:	30 kHz
Video bandwidth:	30 kHz
Span:	3 MHz
Trace-Mode:	Max Hold

Limits:

FCC	IC
Spectrum bandwidth of a FHSS system – 20 dB bandwidth	
Bandwidth < 3/2 * Channel spacing	

Results:

Modulation Frequency	20 dB BANDWIDTH [kHz]		
	2402 MHz	2440 MHz	2480 MHz
GFSK	1130	1130	1130
Measurement uncertainty	± 30 kHz		

Result: Passed

Plots:

Plot 1: lowest channel



Plot 2: mid channel



Plot 3: highest channel



9.8 Maximum output power

Description:

Measurement of the maximum output power conducted and radiated. EUT in single channel mode.

Measurement:

Measurement parameter	
Detector:	Peak
Sweep time:	Auto
Resolution bandwidth:	3 MHz
Video bandwidth:	3 MHz
Span:	3 MHz
Trace-Mode:	Max Hold

Limits:

FCC	IC
Maximum output power	
[Conducted: 0.125 W – antenna gain max. 6 dBi] Systems using more than 75 hopping channels: Conducted: 1.0 W – antenna gain max. 6 dBi	

Results:

Modulation	Maximum output power conducted [dBm]		
	2402 MHz	2440 MHz	2480 MHz
Frequency			
GFSK	-3.45	-3.18	-3.46
Measurement uncertainty	± 1.5 dB		

Modulation	Maximum output power radiated - EIRP [dBm]		
	2402 MHz	2440 MHz	2480 MHz
Frequency			
GFSK	-6.2	-6.7	-7.3
Measurement uncertainty	± 3 dB		

*) - Values calculated with antenna gain

Result: Passed

Plots:

Plot 1: lowest channel

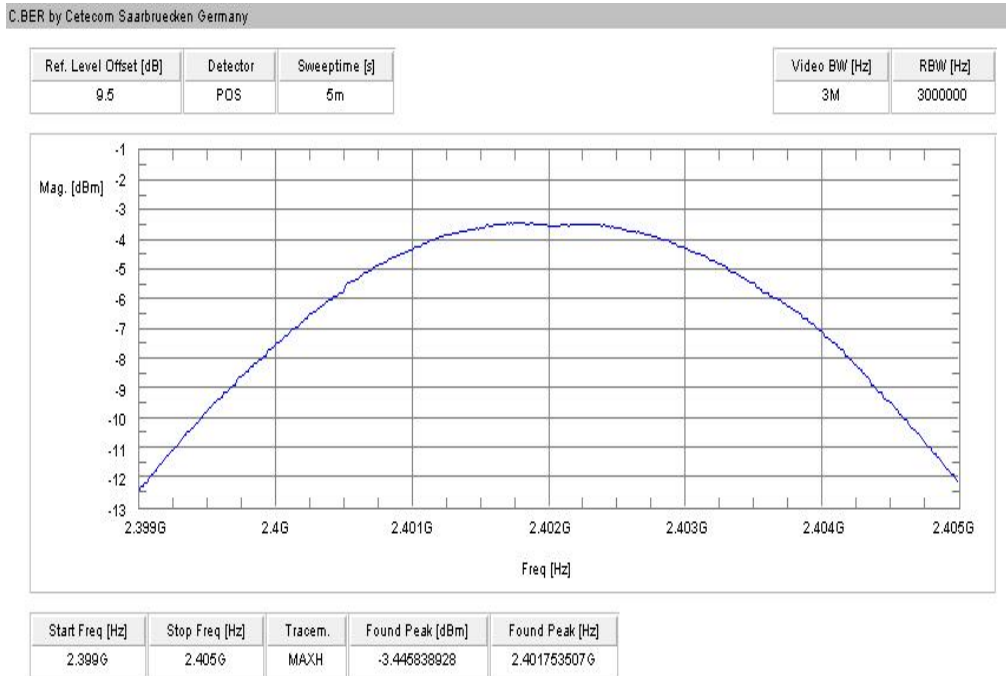

Plot 2: mid channel

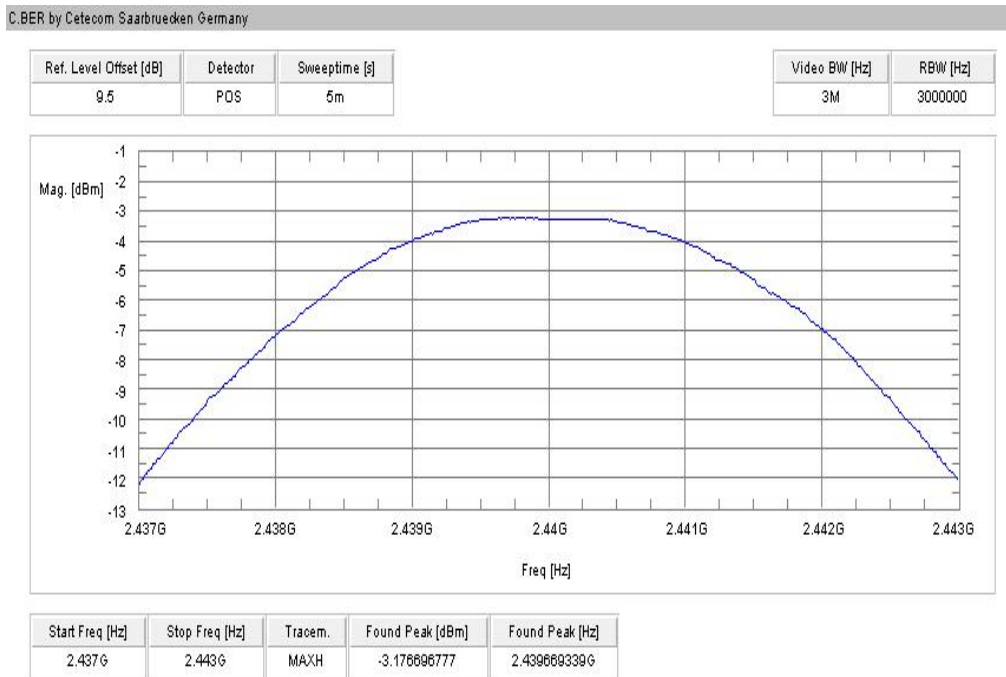

Plot 3: highest channel

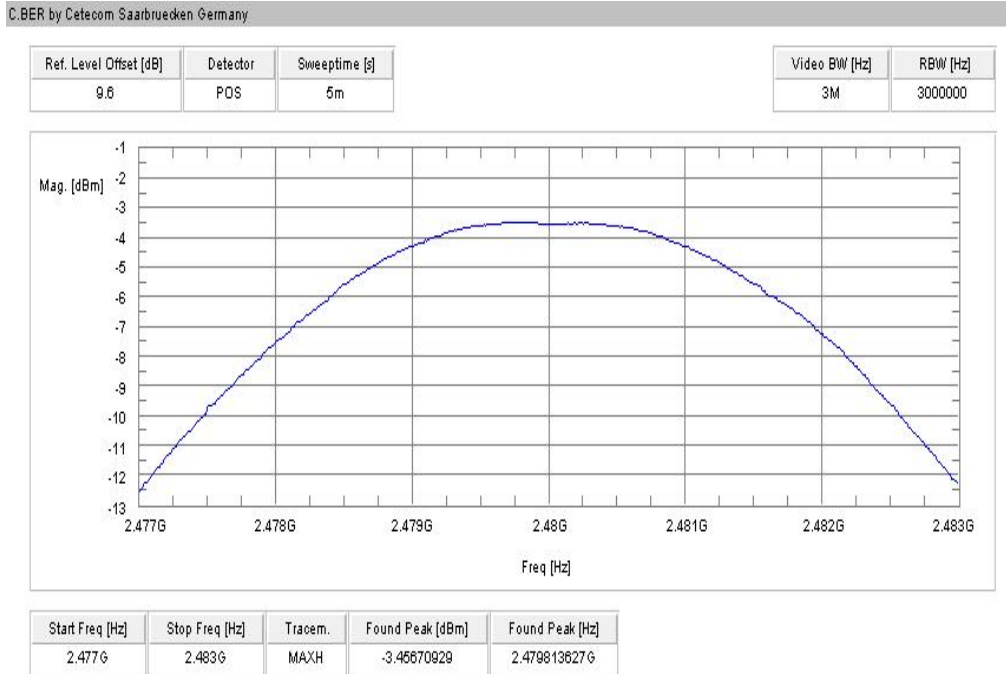

9.9 Band edge compliance conducted

Description:

Measurement of the conducted band edge compliance. EUT is measured at the lower and upper band edge in single channel and hopping mode. The measurement is repeated for all modulations.

Measurement:

Measurement parameter	
Detector:	Peak
Sweep time:	Auto
Resolution bandwidth:	100 kHz
Video bandwidth:	100 kHz
Span:	Lower Band Edge: 2395 – 2405 MHz Upper Band Edge: 2478 – 2489 MHz
Trace-Mode:	Max Hold

Limits:

FCC	IC
Band edge compliance conducted	
<p>In any 100 kHz bandwidth outside the frequency band in which the spread spectrum or digitally modulated intentional radiator is operating, the radio frequency power that is produced by the intentional radiator shall be at least 20 dB below that in the 100 kHz bandwidth within the band that contains the highest level of the desired power, based on either an RF conducted or a radiated measurement. Attenuation below the general limits specified in Section 15.209(a) is not required.</p>	

Result:

Scenario Modulation	Band edge compliance conducted [dB]
	GFSK
Lower band edge – hopping off	> 20 dB
Lower band edge – hopping on	> 20 dB
Upper band edge – hopping off	> 20 dB
Upper band edge – hopping on	> 20 dB
Measurement uncertainty	± 1.5 dB

Result: **Passed**

Plots:

Plot 1: Lower band edge – hopping on

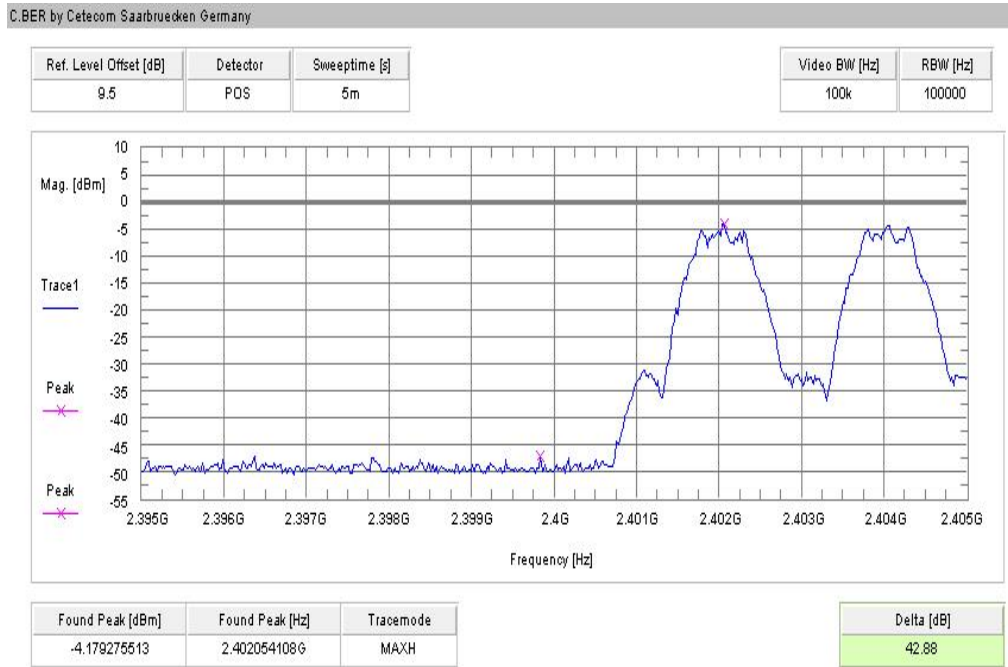

Plot 2: Upper band edge – hopping on

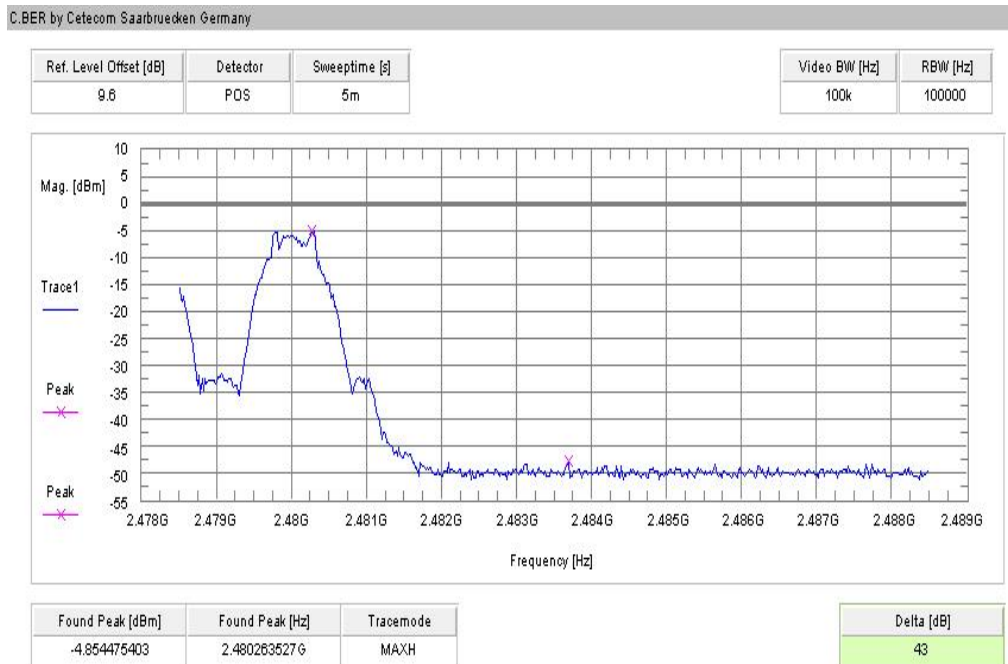

Plot 3: Lower band edge – hopping off

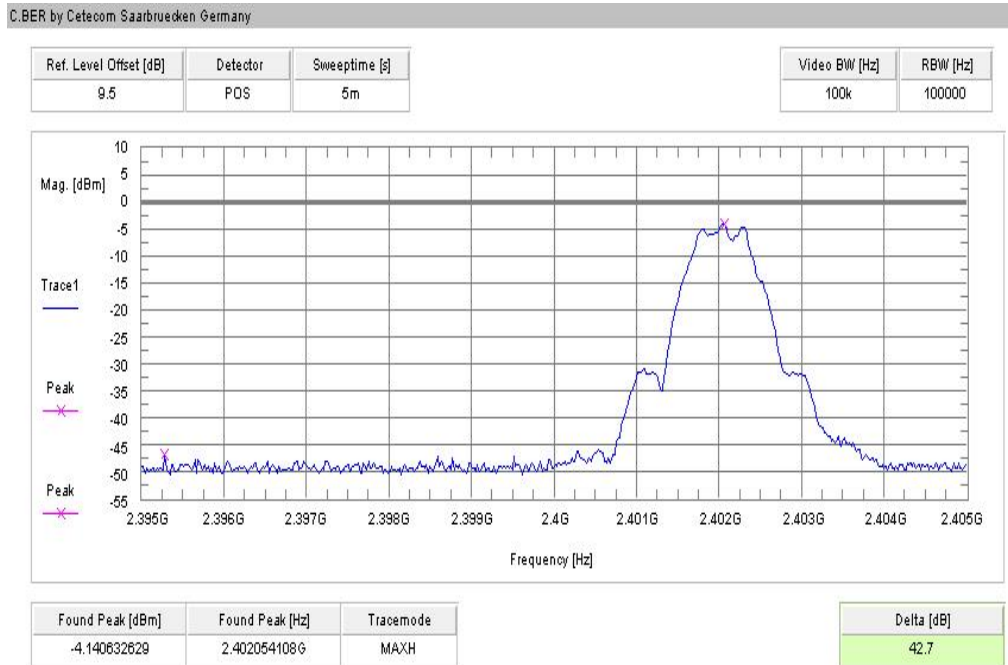

Plot 4: Upper band edge – hopping off

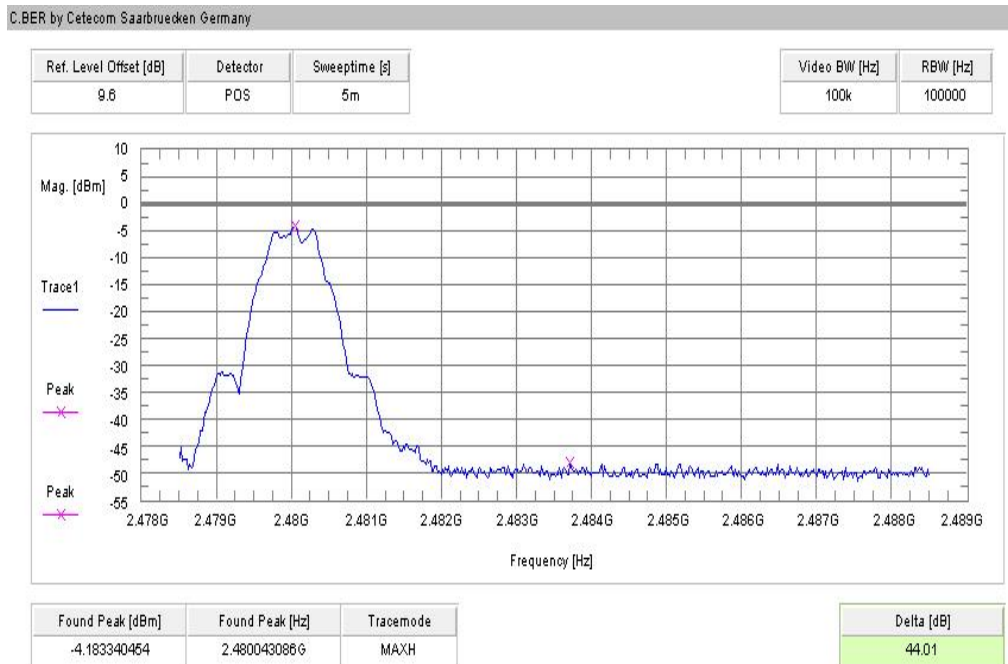

9.10 Band edge compliance radiated

Description:

Measurement of the radiated band edge compliance. The EUT is turned in the position that results in the maximum level at the band edge. Then a sweep over the corresponding restricted band is performed. The EUT is set to single channel mode and the transmit channel is channel 00 for the lower restricted band and channel 39 for the upper restricted band. The measurement is repeated for all modulations. Measurement distance is 3m.

Measurement:

Measurement parameter	
Detector:	Peak
Sweep time:	Auto
Resolution bandwidth:	1 MHz
Video bandwidth:	10 Hz
Span:	Lower Band: 2300 – 2400 MHz Upper Band: 2480 – 2500 MHz
Trace-Mode:	Max Hold

Limits:

FCC	IC
Band edge compliance radiated	
<p>In any 100 kHz bandwidth outside the frequency band in which the spread spectrum or digitally modulated intentional radiator is operating, the radio frequency power that is produced by the intentional radiator shall be at least 20 dB below that in the 100 kHz bandwidth within the band that contains the highest level of the desired power, based on either an RF conducted or a radiated measurement. Attenuation below the general limits specified in Section 15.209(a) is not required. In addition, radiated emissions which fall in the restricted bands, as defined in Section 15.205(a), must also comply with the radiated emission limits specified in Section 15.209(a) (see Section 5.205(c)).</p>	
54 dB μ V/m AVG	

Result:

Scenario	Band edge compliance radiated [dB μ V/m]
Modulation	GFSK
Lower restricted band	< 54 (see plot 1)
Upper restricted band	< 54 (see plot 2)
Measurement uncertainty	\pm 3 dB

Result: Passed

Plots:

Plot 1: Lower restricted band

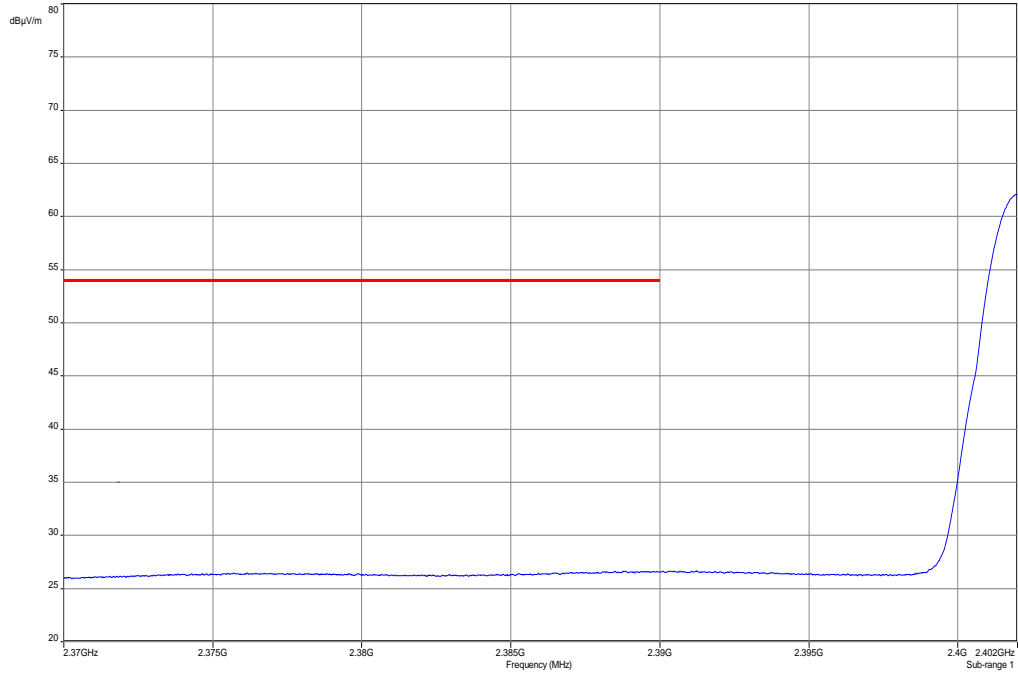

Plot 2: Upper restricted band

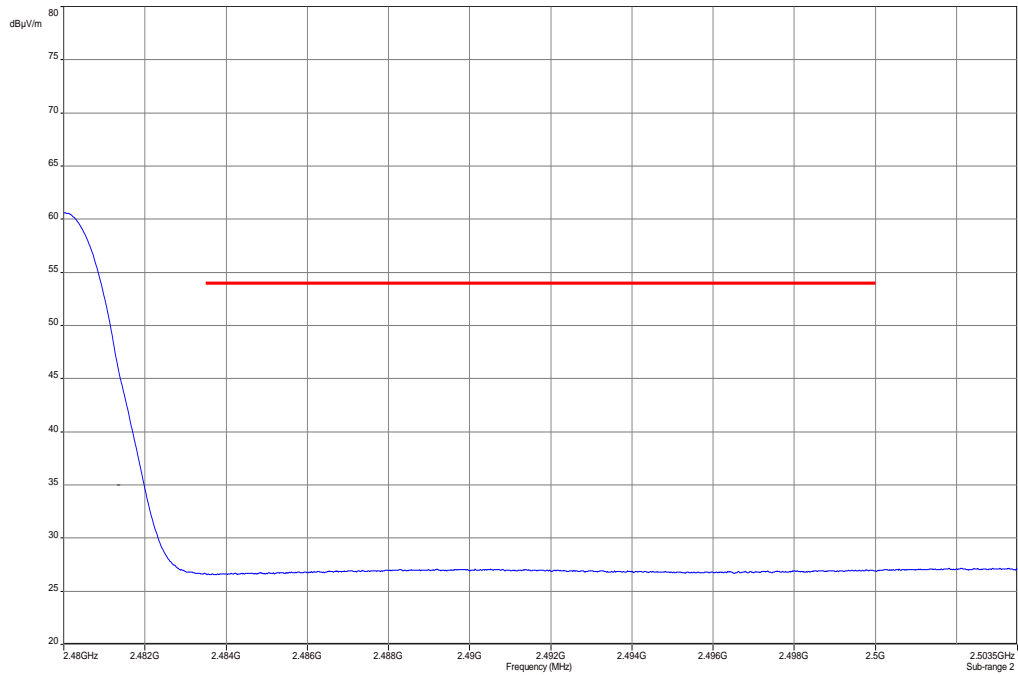

9.11 TX spurious emissions conducted

Description:

Measurement of the conducted spurious emissions in transmit mode. The EUT is set to single channel mode and the transmit channel is channel 00, channel 19 and channel 39. The measurement is repeated for all modulations.

Measurement:

Measurement parameter	
Detector:	Peak
Sweep time:	Auto
Resolution bandwidth:	100 kHz
Video bandwidth:	300 kHz or 500 kHz
Span:	9 kHz to 25 GHz
Trace-Mode:	Max Hold

Limits:

FCC	IC
TX spurious emissions conducted	
<p>In any 100 kHz bandwidth outside the frequency band in which the spread spectrum or digitally modulated intentional radiator is operating, the radio frequency power that is produced by the intentional radiator shall be at least 20 dB below that in the 100 kHz bandwidth within the band that contains the highest level of the desired power, based on either an RF conducted or a radiated measurement. Attenuation below the general limits specified in Section 15.209(a) is not required</p>	

Results:

TX spurious emissions conducted					
f [MHz]		amplitude of emission [dBm]	limit max. allowed emission power	actual attenuation below frequency of operation [dB]	results
2402		-3.63	30 dBm		Operating frequency
No critical peaks found! All detected emissions are more than 6 dB below the limit!			-20 dBc		complies
2440		-3.40	30 dBm		Operating frequency
No critical peaks found! All detected emissions are more than 6 dB below the limit!			-20 dBc		complies
2480		-3.71	30 dBm		Operating frequency
No critical peaks found! All detected emissions are more than 6 dB below the limit!			-20 dBc		complies
Measurement uncertainty		± 3 dB			

Result: Passed

Plots:

Plot 1: lowest channel

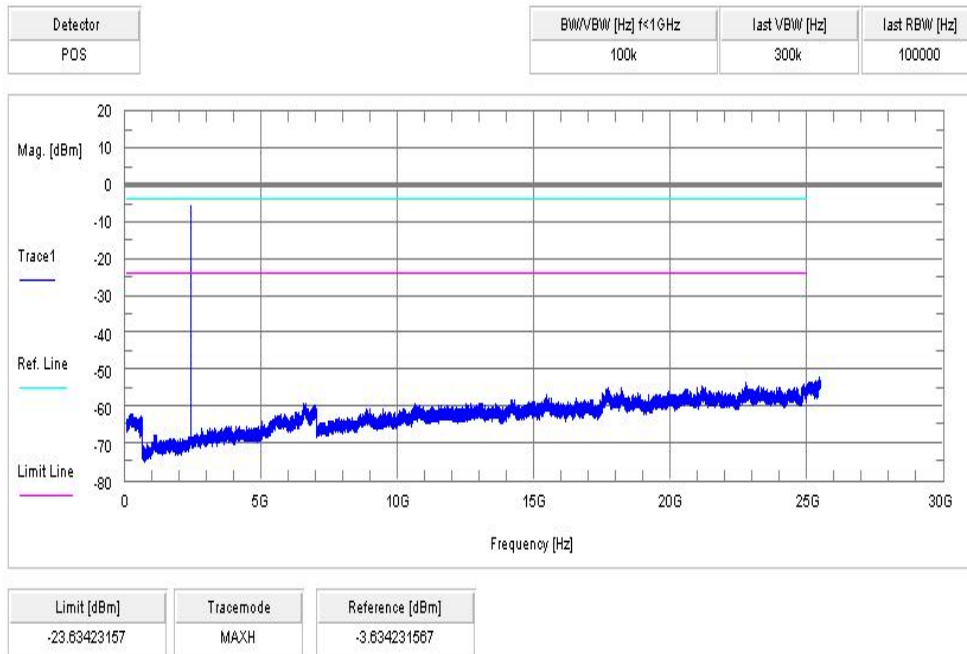

Plot 2: mid channel

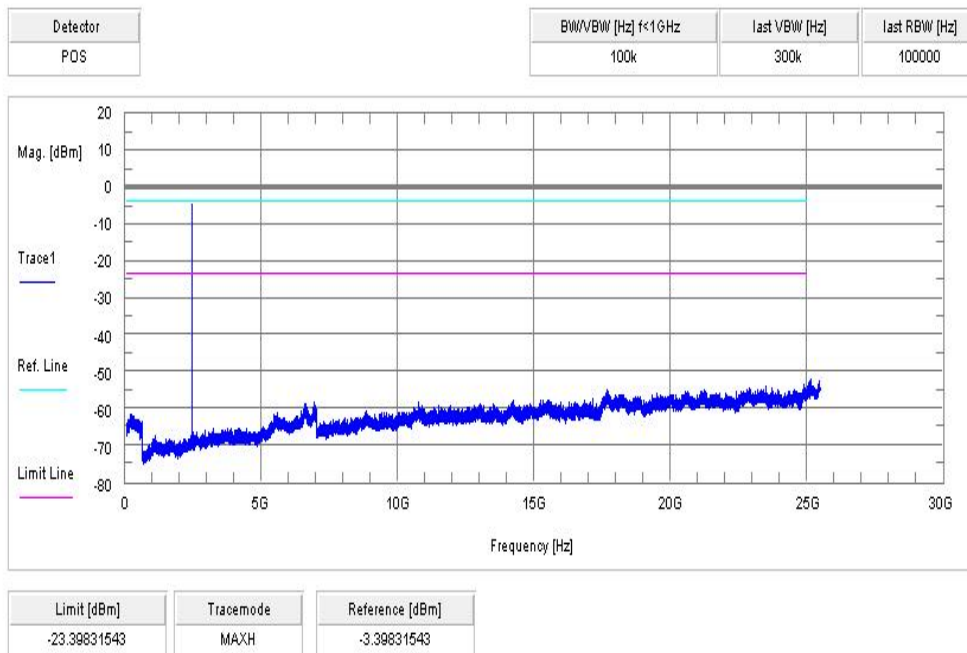

Plot 3: highest channel

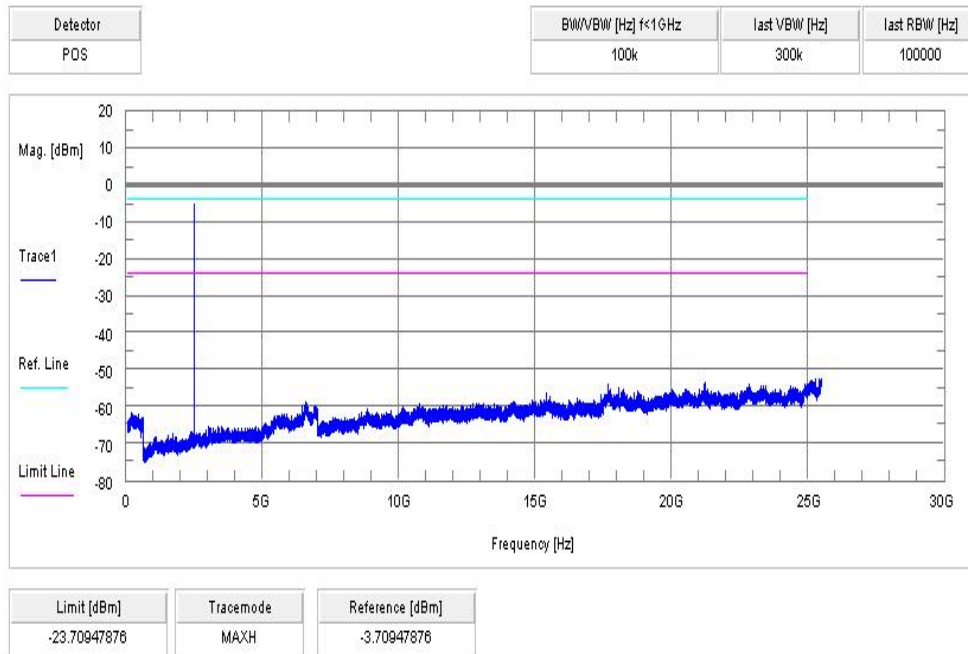

9.12 TX spurious emissions radiated

Description:

Measurement of the radiated spurious emissions in transmit mode. The EUT is set to single channel mode and the transmit channel is channel 00, channel 19 and channel 39. The measurement is performed in the mode with the highest output power.

Measurement:

Measurement parameter	
Detector:	Peak / Quasi Peak
Sweep time:	Auto
Resolution bandwidth:	F < 1 GHz: 100 kHz F > 1 GHz: 1 MHz
Video bandwidth:	Sweep: 100 kHz Remeasurement: 10 Hz
Span:	30 MHz to 25 GHz
Trace-Mode:	Max Hold
Measured Modulation:	GFSK

The modulation with the highest output power was used to perform the transmitter spurious emissions. If spurious were detected a re-measurement was performed on the detected frequency with each modulation.

Limits:

FCC		IC	
TX spurious emissions radiated			
<p>In any 100 kHz bandwidth outside the frequency band in which the spread spectrum or digitally modulated intentional radiator is operating, the radio frequency power that is produced by the intentional radiator shall be at least 20 dB below that in the 100 kHz bandwidth within the band that contains the highest level of the desired power, based on either an RF conducted or a radiated measurement. Attenuation below the general limits specified in Section 15.209(a) is not required. In addition, radiated emissions which fall in the restricted bands, as defined in §15.205(a), must also comply with the radiated emission limits specified in §15.209(a) (see §15.205(c)).</p>			
§15.209			
Frequency (MHz)	Field strength (dBµV/m)	Measurement distance	
30 - 88	30.0	10	
88 – 216	33.5	10	
216 – 960	36.0	10	
Above 960	54.0	3	

Results:

TX spurious emissions radiated [dBµV/m]								
2402 MHz			2440 MHz			2480 MHz		
F [MHz]	Detector	Level [dBµV/m]	F [MHz]	Detector	Level [dBµV/m]	F [MHz]	Detector	Level [dBµV/m]
For emissions below 1 GHz, please take a look at the table below the 1 GHz.			For emissions below 1 GHz, please take a look at the table below the 1 GHz.			For emissions below 1 GHz, please take a look at the table below the 1 GHz.		
For emissions above 1 GHz, please take a look at the plots.			For emissions above 1 GHz, please take a look at the plots.			For emissions above 1 GHz, please take a look at the plots.		
Measurement uncertainty			± 3 dB					

Result: Passed

Plots:

Plot 1: 30 MHz to 1 GHz, lowest channel, vertical & horizontal polarization

Common Information

EUT: PM-0230-BV
 Serial Number: CB5121Z4EJ
 Test Description: FCC part 15 class B @ 10 m
 Operating Conditions: BT LE CH0 + charging
 Operator Name: Medrow
 Comment: AC: 115 V / 60 Hz

Scan Setup: STAN_Fin [EMI radiated]

Hardware Setup: Electric Field (NOS)
 Receiver: [ESCI 3]
 Level Unit: dBµV/m

Subrange	Step Size	Detectors	IF BW	Meas. Time	Preamp
30 MHz - 2 GHz	60 kHz	QPK	120 kHz	1 s	20 dB

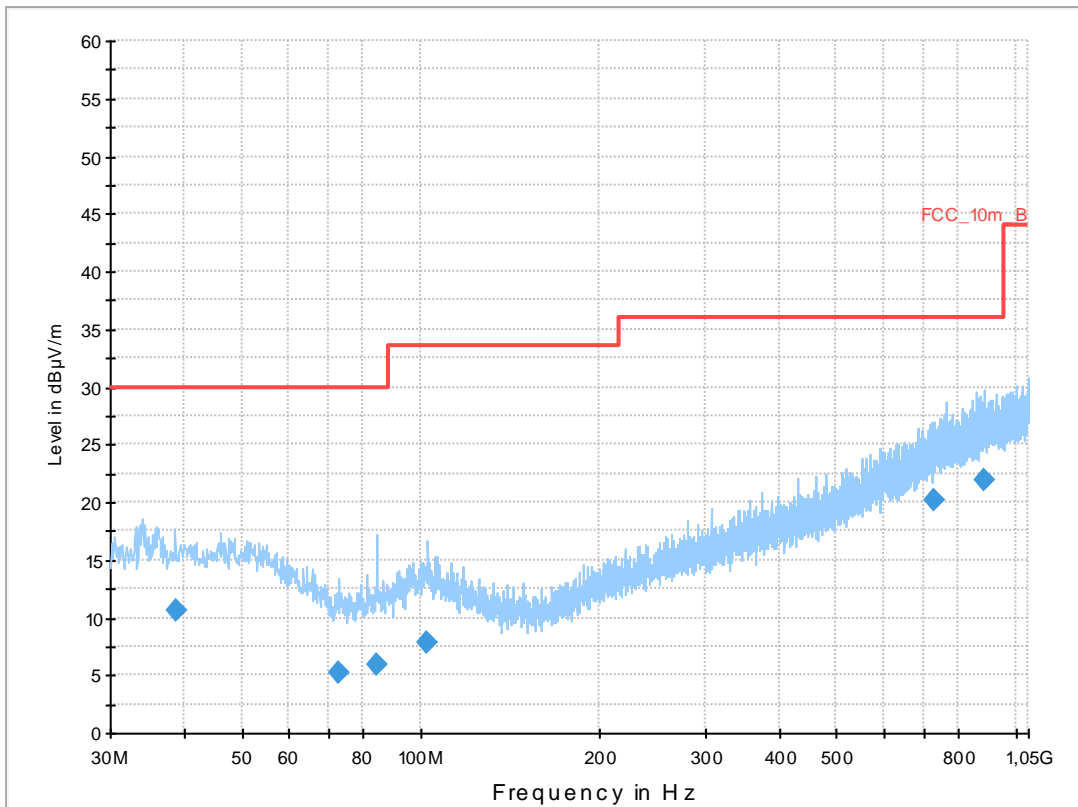

Final Result 1

Frequency (MHz)	QuasiPeak (dBµV/m)	Meas. Time (ms)	Bandwidth (kHz)	Height (cm)	Polarization	Azimuth (deg)	Corr. (dB)	Margin - QPK (dB)	Limit - QPK (dBµV/m)	Comment
38.721750	10.6	1000.0	120.000	98.0	V	170.0	13.3	19.4	30.0	
72.598200	5.3	1000.0	120.000	98.0	H	180.0	9.2	24.7	30.0	
84.533250	6.0	1000.0	120.000	154.0	H	0.0	9.8	24.0	30.0	
102.266550	7.9	1000.0	120.000	170.0	H	268.0	11.7	25.6	33.5	
731.003550	20.1	1000.0	120.000	170.0	V	268.0	23.2	15.9	36.0	
887.668350	21.9	1000.0	120.000	170.0	H	88.0	25.0	14.1	36.0	

Plot 2: 1 GHz to 12.75 GHz, lowest channel, vertical & horizontal polarization

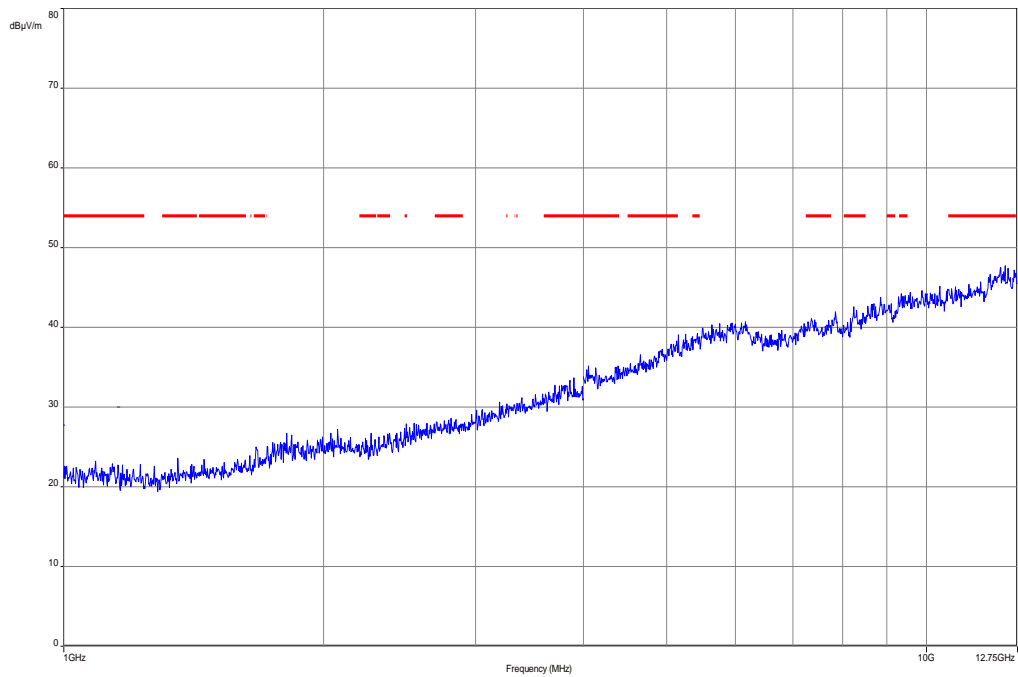

Carrier suppressed with a 2.4 GHz-band rejection filter.

Plot 3: 12.75 GHz to 18 GHz, lowest channel, vertical & horizontal polarization

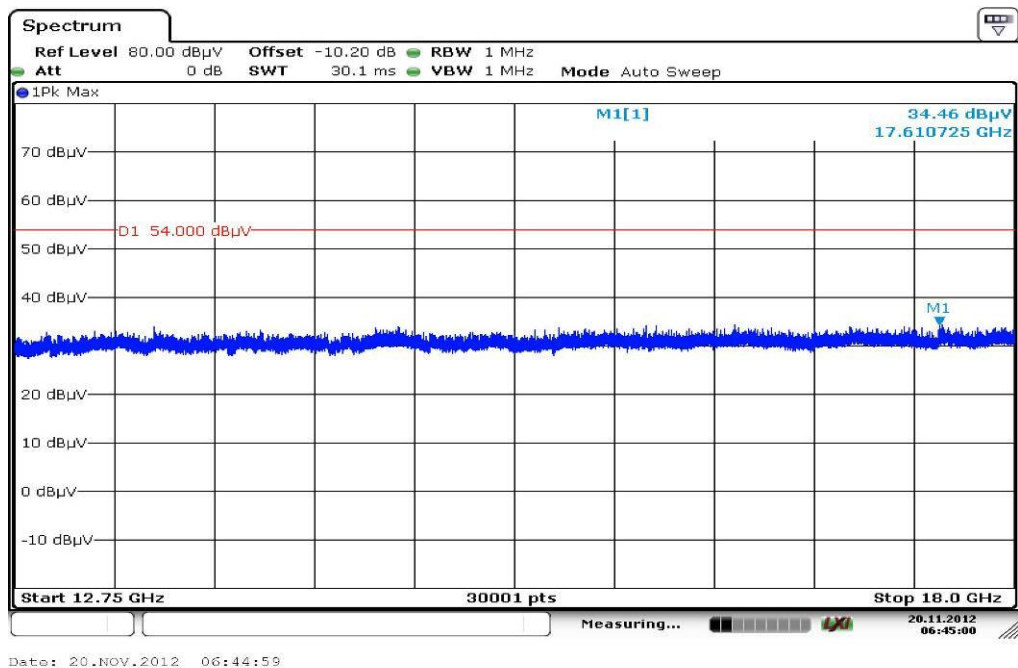

Plot 4: 18 GHz to 26 GHz, lowest channel, vertical & horizontal polarization

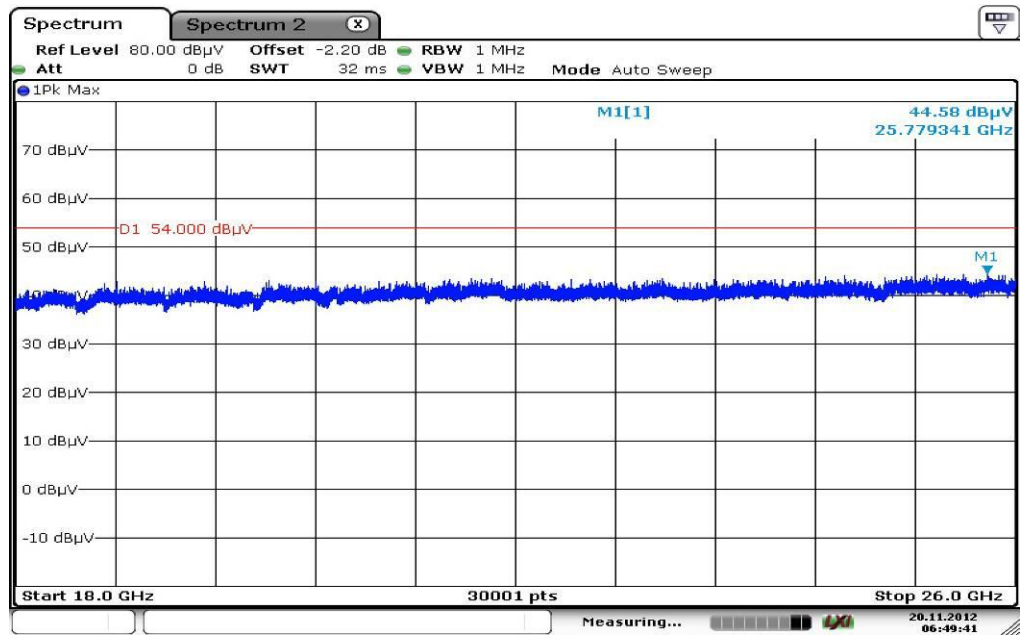

Date: 20.NOV.2012 06:49:41

Plot 5: 30 MHz to 1 GHz, mid channel, vertical & horizontal polarization

Common Information

EUT: PM-0230-BV
 Serial Number: CB5121Z4EJ
 Test Description: FCC part 15 class B @ 10 m
 Operating Conditions: BT LE CH19 + charging
 Operator Name: Medrow
 Comment: AC: 115 V / 60 Hz

Scan Setup: STAN_Fin [EMI radiated]

Hardware Setup: Electric Field (NOS)
 Receiver: [ESCI 3]
 Level Unit: dBµV/m

Subrange	Step Size	Detectors	IF BW	Meas. Time	Preamp
30 MHz - 2 GHz	60 kHz	QPK	120 kHz	1 s	20 dB

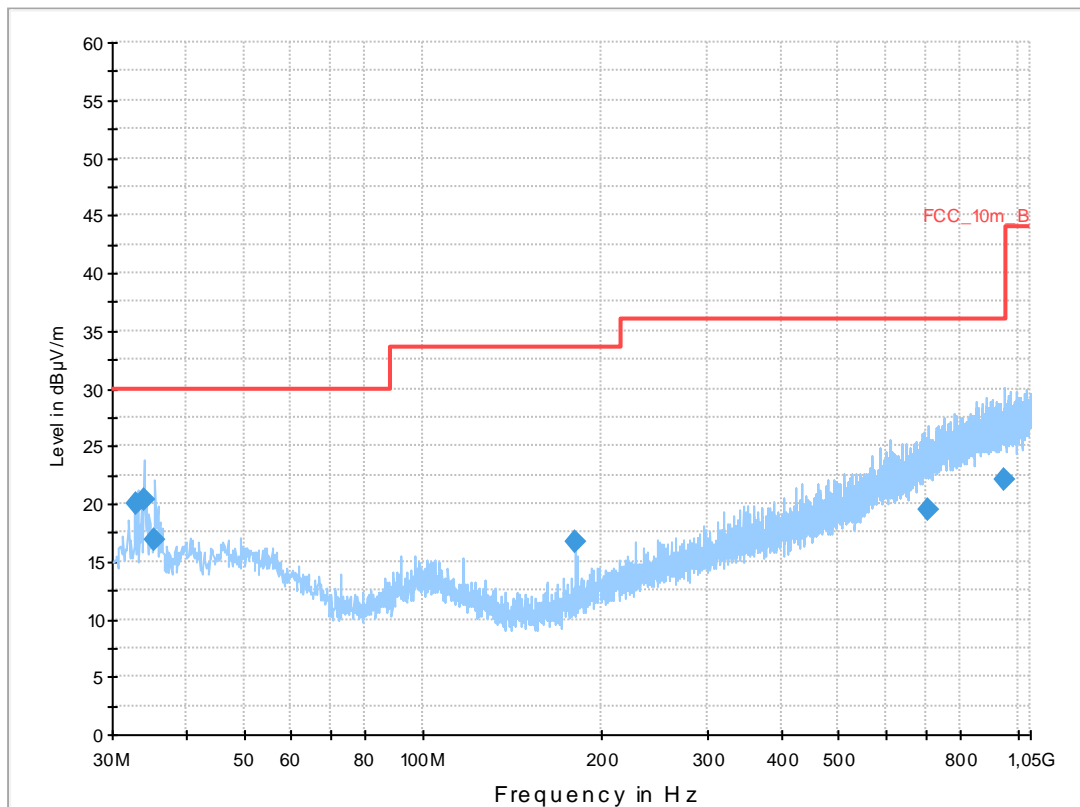

Final Result 1

Frequency (MHz)	QuasiPeak (dBµV/m)	Meas. Time (ms)	Bandwidth (kHz)	Height (cm)	Polarization	Azimuth (deg)	Corr. (dB)	Margin - QPK (dB)	Limit - QPK (dBµV/m)	Comment
33.016650	20.0	1000.0	120.000	105.0	V	-10.0	12.8	10.0	30.0	
34.037550	20.4	1000.0	120.000	111.0	V	80.0	12.9	9.6	30.0	
35.413200	16.9	1000.0	120.000	170.0	V	270.0	13.1	13.1	30.0	
179.987700	16.7	1000.0	120.000	98.0	V	260.0	10.4	16.8	33.5	
704.723400	19.6	1000.0	120.000	170.0	H	267.0	22.6	16.4	36.0	
950.052450	22.1	1000.0	120.000	170.0	H	260.0	25.4	13.9	36.0	

Plot 6: 1 GHz to 12.75 GHz, mid channel, vertical & horizontal polarization

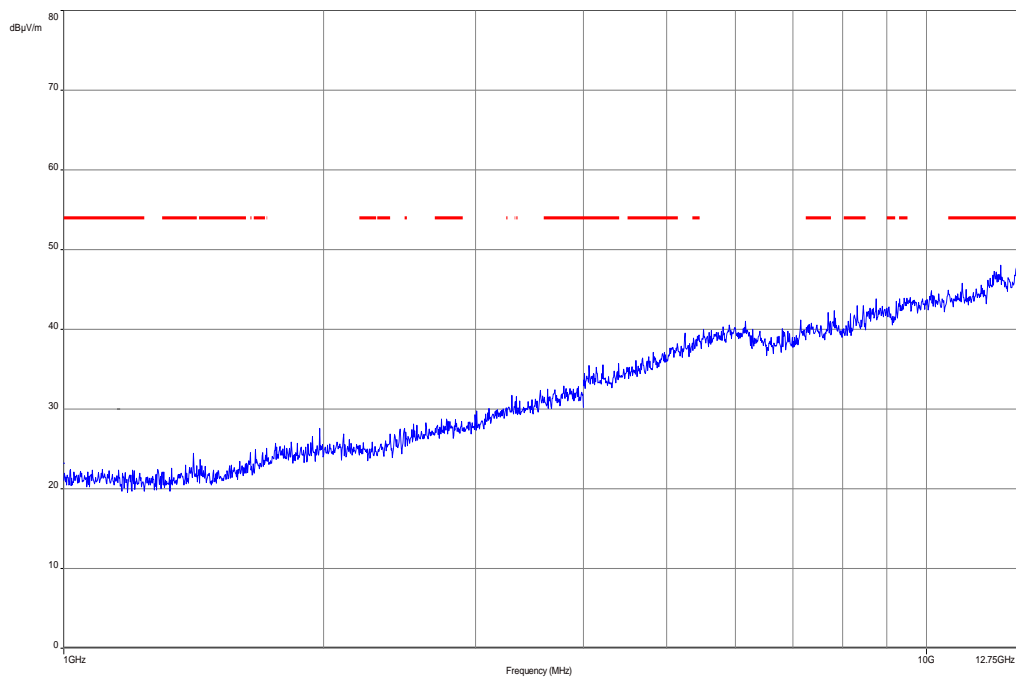

Carrier suppressed with a 2.4 GHz-band rejection filter.

Plot 7: 12.75 GHz to 18 GHz, mid channel, vertical & horizontal polarization

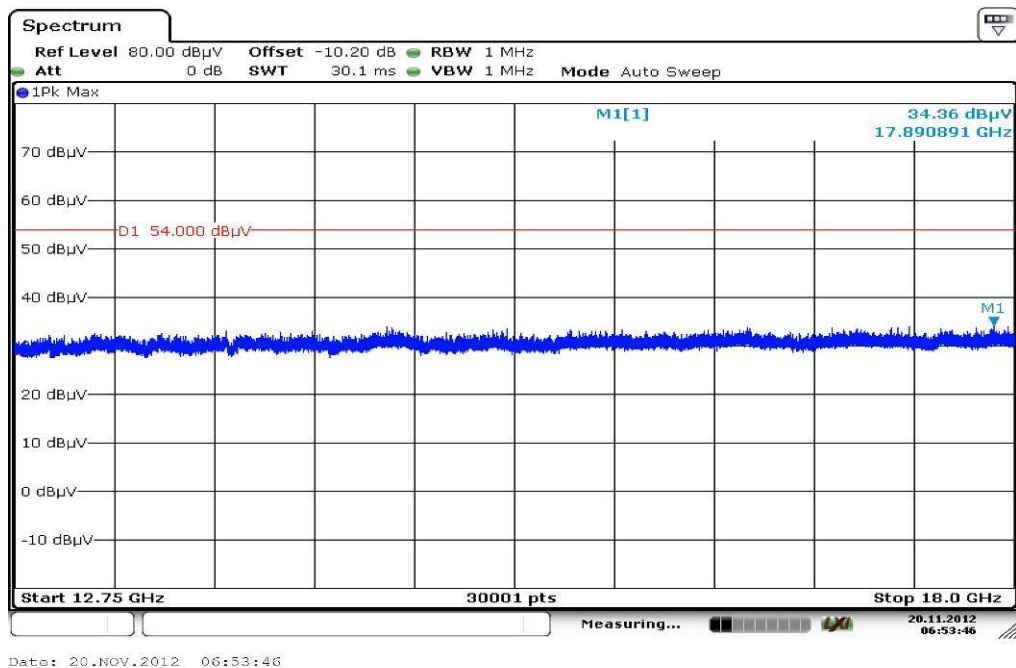

Plot 8: 18 GHz to 26 GHz, mid channel, vertical & horizontal polarization

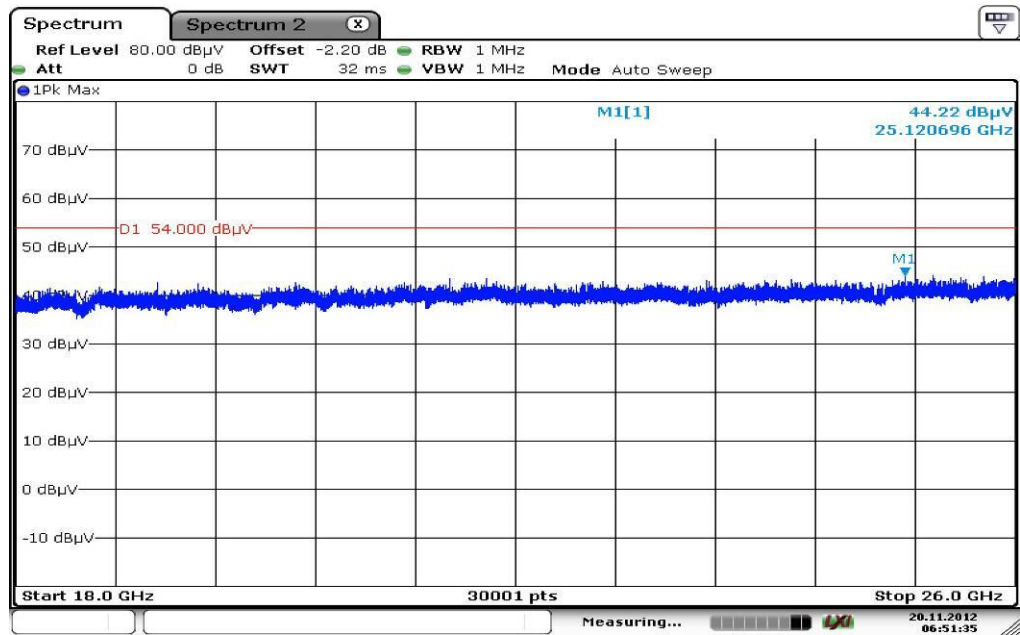

Date: 20.NOV.2012 06:51:35

Plot 9: 30 MHz to 1 GHz, highest channel, vertical & horizontal polarization

Common Information

EUT: PM-0230-BV
 Serial Number: CB5121Z4EJ
 Test Description: FCC part 15 class B @ 10 m
 Operating Conditions: BT LE CH39 + charging
 Operator Name: Medrow
 Comment: AC: 115 V / 60 Hz

Scan Setup: STAN_Fin [EMI radiated]

Hardware Setup: Electric Field (NOS)
 Receiver: [ESCI 3]
 Level Unit: dBµV/m

Subrange	Step Size	Detectors	IF BW	Meas. Time	Preamp
30 MHz - 2 GHz	60 kHz	QPK	120 kHz	1 s	20 dB

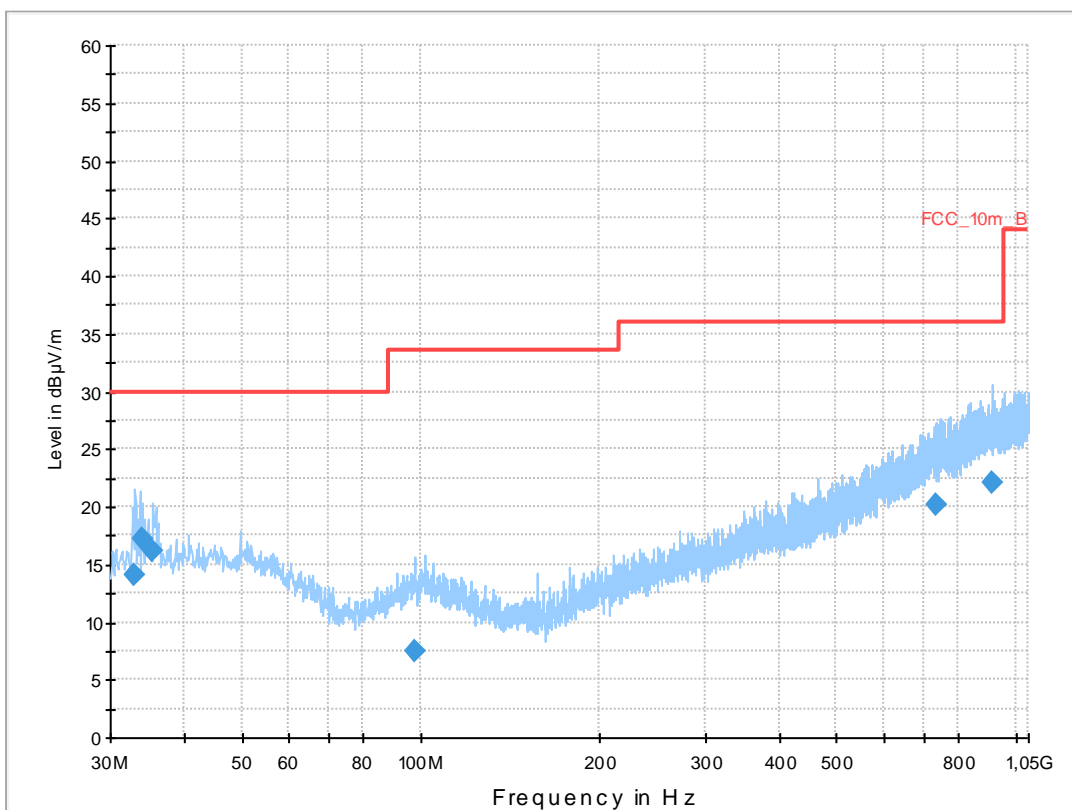

Final Result 1

Frequency (MHz)	QuasiPeak (dBµV/m)	Meas. Time (ms)	Bandwidth (kHz)	Height (cm)	Polarization	Azimuth (deg)	Corr. (dB)	Margin - QPK (dB)	Limit - QPK (dBµV/m)	Comment
33.010350	14.1	1000.0	120.000	170.0	V	-10.0	12.8	15.9	30.0	
34.038900	17.2	1000.0	120.000	121.0	V	0.0	12.9	12.8	30.0	
35.404950	16.1	1000.0	120.000	111.0	V	-5.0	13.1	13.9	30.0	
97.687800	7.5	1000.0	120.000	111.0	V	270.0	11.6	26.0	33.5	
732.714000	20.2	1000.0	120.000	121.0	H	272.0	23.3	15.8	36.0	
912.678300	22.0	1000.0	120.000	123.0	V	190.0	25.2	14.0	36.0	

Plot 10: 1 GHz to 12.75 GHz, highest channel, vertical & horizontal polarization

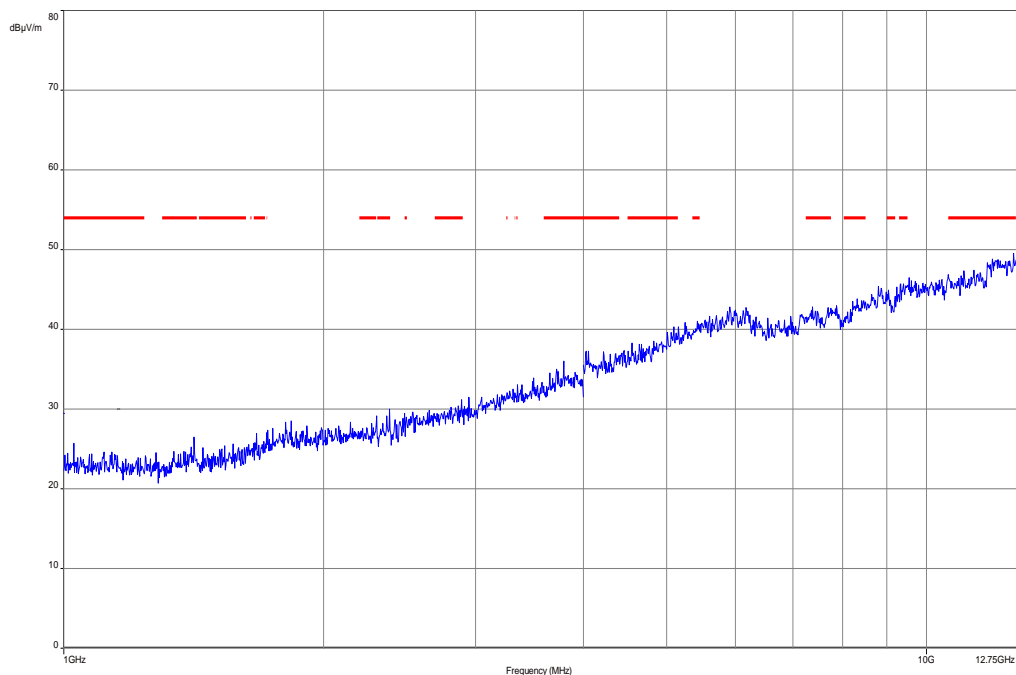

Carrier suppressed with a 2.4 GHz-band rejection filter.

Plot 11: 12.75 GHz to 18 GHz, highest channel, vertical & horizontal polarization

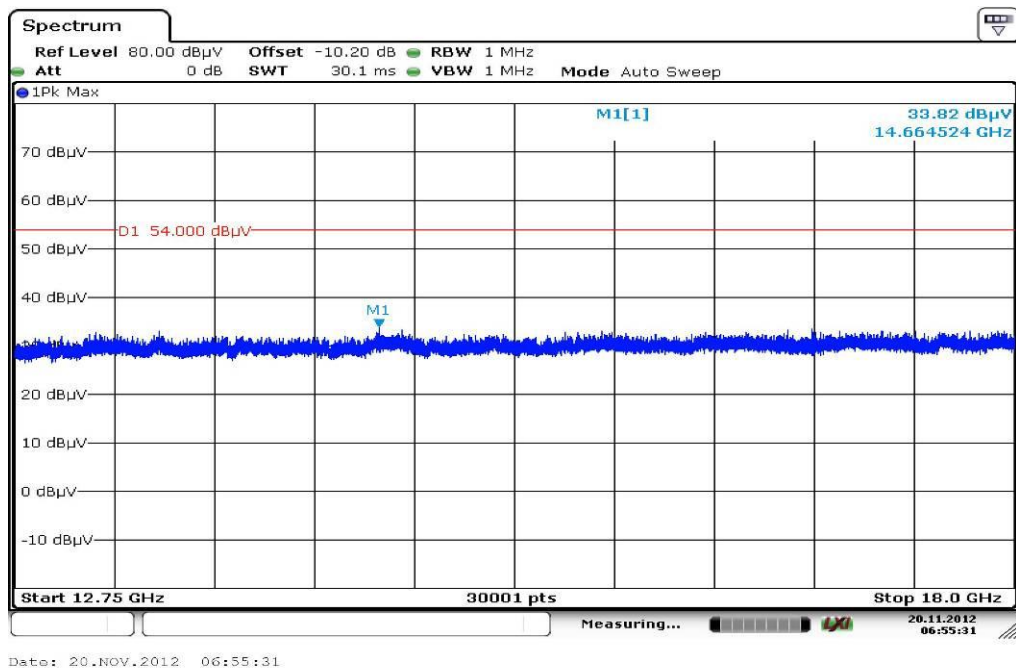

Plot 12: 18 GHz to 26 GHz, highest channel, vertical & horizontal polarization

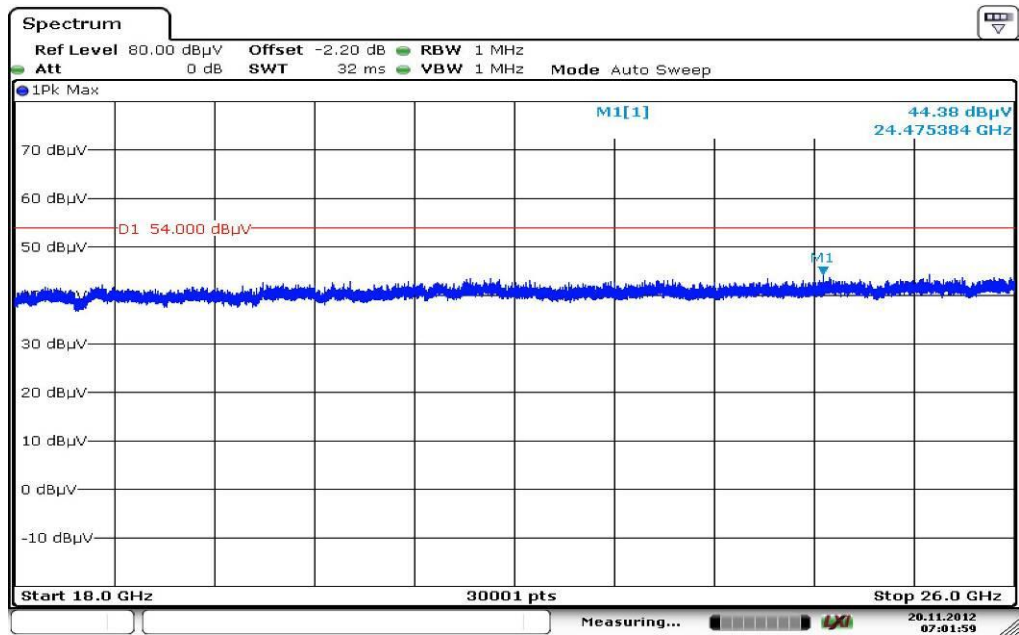

Date: 20.NOV.2012 07:01:59

9.13 RX spurious emissions radiated

Description:

Measurement of the radiated spurious emissions in idle/receive mode. The EUT is detached so all oscillators are active.

Measurement:

Measurement parameter	
Detector:	Peak / Quasi peak
Sweep time:	Auto
Resolution bandwidth:	F < 1 GHz: 100 kHz F > 1 GHz: 1 MHz
Video bandwidth:	Sweep: 100 kHz Remeasurement: 10 Hz
Span:	30 MHz to 25 GHz
Trace-Mode:	Max Hold

Limits:

FCC		IC	
RX Spurious Emissions Radiated			
Frequency (MHz)	Field strength (dBµV/m)	Measurement distance	
30 - 88	30.0	10	
88 – 216	33.5	10	
216 – 960	36.0	10	
Above 960	54.0	3	

Results:

RX spurious emissions radiated [dBµV/m]		
F [MHz]	Detector	Level [dBµV/m]
For emissions below 1 GHz, please take a look at the table below the 1 GHz.		
For emissions above 1 GHz, please take a look at the plots.		
Measurement uncertainty	±3 dB	

Result: Passed

Plots:

Plot 1: 30 MHz to 1 GHz, RX / idle – mode, vertical & horizontal polarization

Common Information

EUT: PM-0230-BV
 Serial Number: CB5121Z4EJ
 Test Description: FCC part 15 class B @ 10 m
 Operating Conditions: BT IDLE
 Operator Name: Medrow
 Comment: AC: 115 V / 60 Hz

Scan Setup: STAN_Fin [EMI radiated]

Hardware Setup: Electric Field (NOS)
 Receiver: [ESCI 3]
 Level Unit: dBµV/m

Subrange	Step Size	Detectors	IF BW	Meas. Time	Preamp
30 MHz - 2 GHz	60 kHz	QPK	120 kHz	1 s	20 dB

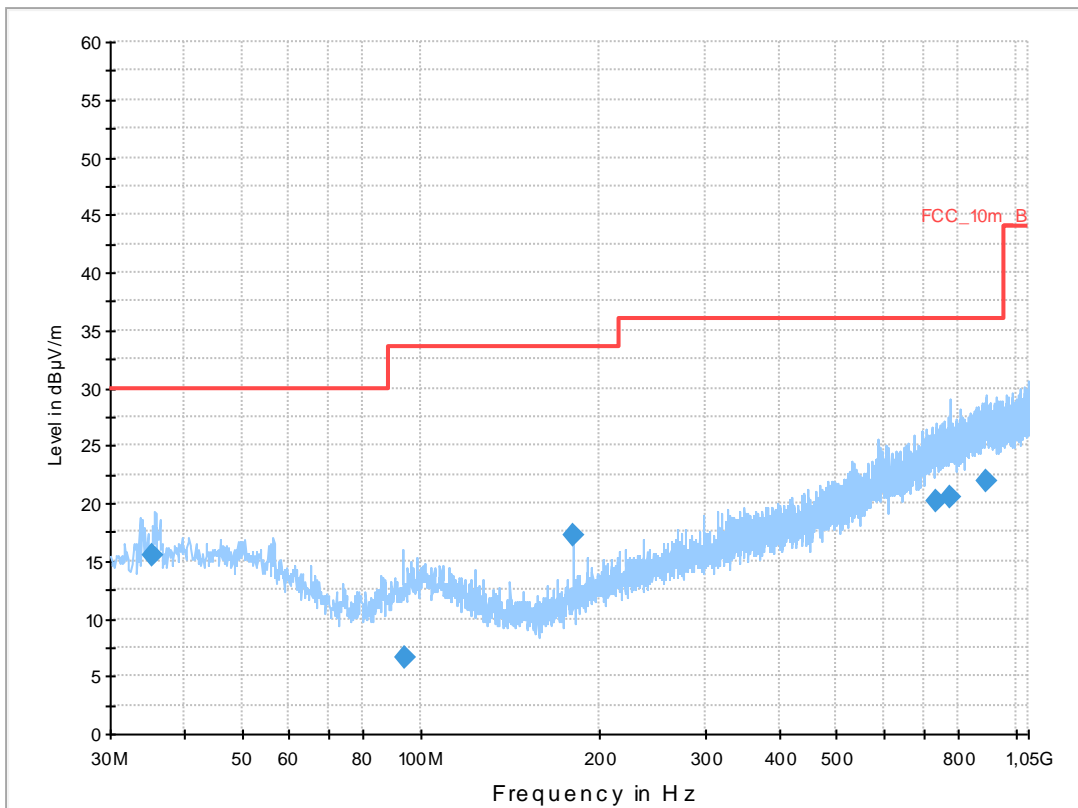

Final Result 1

Frequency (MHz)	QuasiPeak (dBµV/m)	Meas. Time (ms)	Bandwidth (kHz)	Height (cm)	Polarization	Azimuth (deg)	Corr. (dB)	Margin - QPK (dB)	Limit - QPK (dBµV/m)	Comment
35.388600	15.5	1000.0	120.000	103.0	V	10.0	13.1	14.5	30.0	
93.871800	6.6	1000.0	120.000	142.0	H	90.0	11.1	26.9	33.5	
179.999400	17.2	1000.0	120.000	98.0	V	265.0	10.4	16.3	33.5	
732.029250	20.2	1000.0	120.000	170.0	H	-10.0	23.2	15.8	36.0	
774.161550	20.5	1000.0	120.000	170.0	V	10.0	23.7	15.5	36.0	
892.702650	21.9	1000.0	120.000	170.0	H	171.0	25.1	14.1	36.0	

Plot 2: 1 GHz to 12.75 GHz, RX / idle – mode, vertical & horizontal polarization

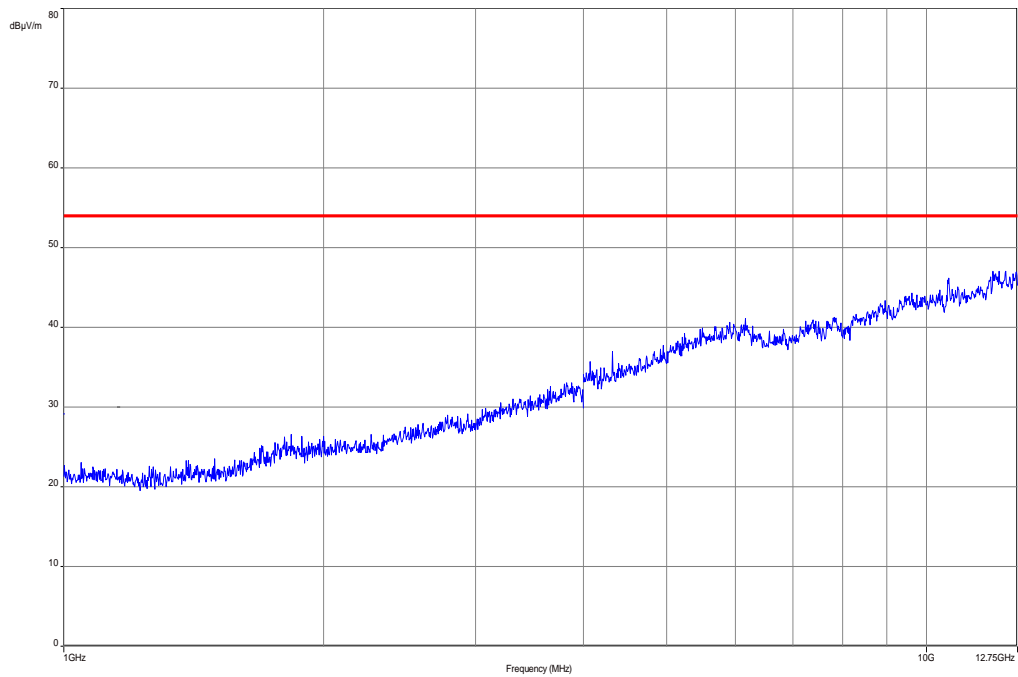

Plot 3: 12.75 GHz to 18 GHz, RX / idle – mode, vertical & horizontal polarization

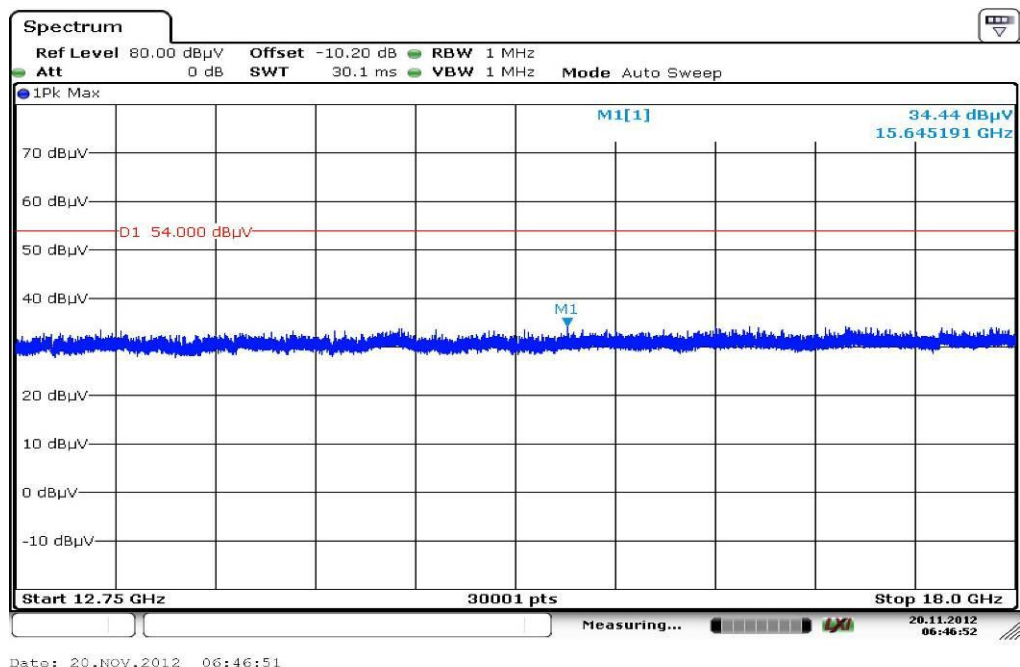

Plot 4: 18 GHz to 26 GHz, RX / idle – mode, vertical & horizontal polarization

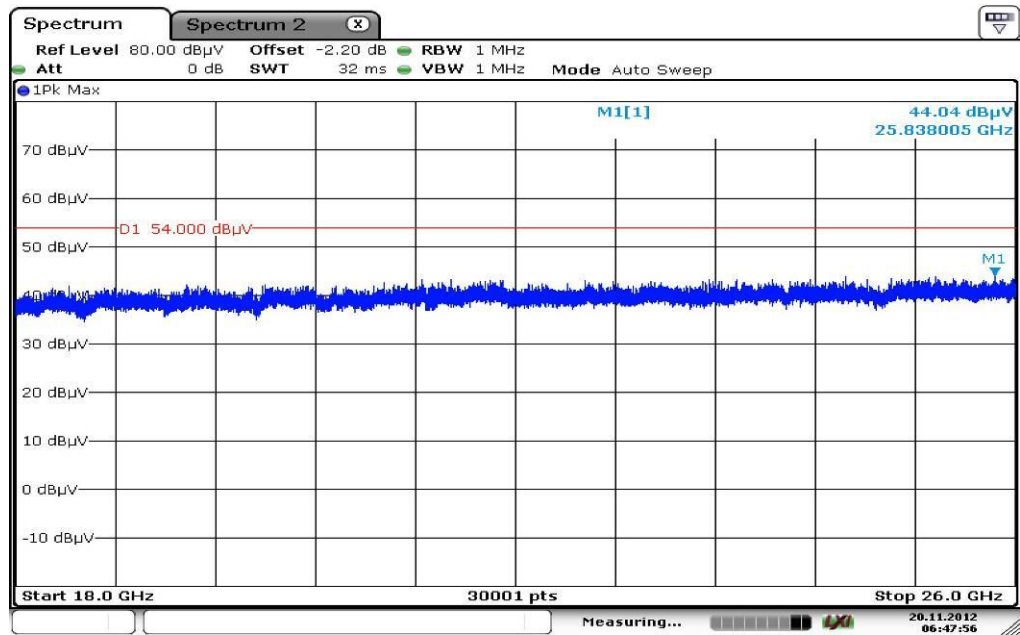

Date: 20.NOV.2012 06:47:56

9.14 Spurious emissions radiated < 30 MHz

Description:

Measurement of the radiated spurious emissions in transmit mode below 30 MHz. The EUT is set to single channel mode and the transmit channel is channel 19. This measurement is representative for all channels and modes. If critical peaks are found channel 00 and channel 39 will be measured too. The measurement is performed in the mode with the highest output power. The limits are recalculated to a measurement distance of 3 m with 40 dB/decade according CFR Part 2.

Measurement:

Measurement parameter	
Detector:	Peak / Quasi peak
Sweep time:	Auto
Resolution bandwidth:	F < 150 kHz: 1 kHz F > 150 kHz: 100 kHz
Video bandwidth:	F < 150 kHz: 200 Hz F > 150 kHz: 9 kHz
Span:	9 kHz to 30 MHz
Trace-Mode:	Max Hold

Limits:

FCC		IC
TX spurious emissions radiated < 30 MHz		
Frequency (MHz)	Field strength (dBµV/m)	Measurement distance
0.009 – 0.490	2400/F(kHz)	300
0.490 – 1.705	24000/F(kHz)	30
1.705 – 30.0	30	30

Results:

TX spurious emissions radiated < 30 MHz [dBµV/m]		
F [MHz]	Detector	Level [dBµV/m]
No critical peaks found!		
Measurement uncertainty	± 3 dB	

Result: Passed

Plot:

Plot 1: 9 kHz to 30 MHz, TX mode

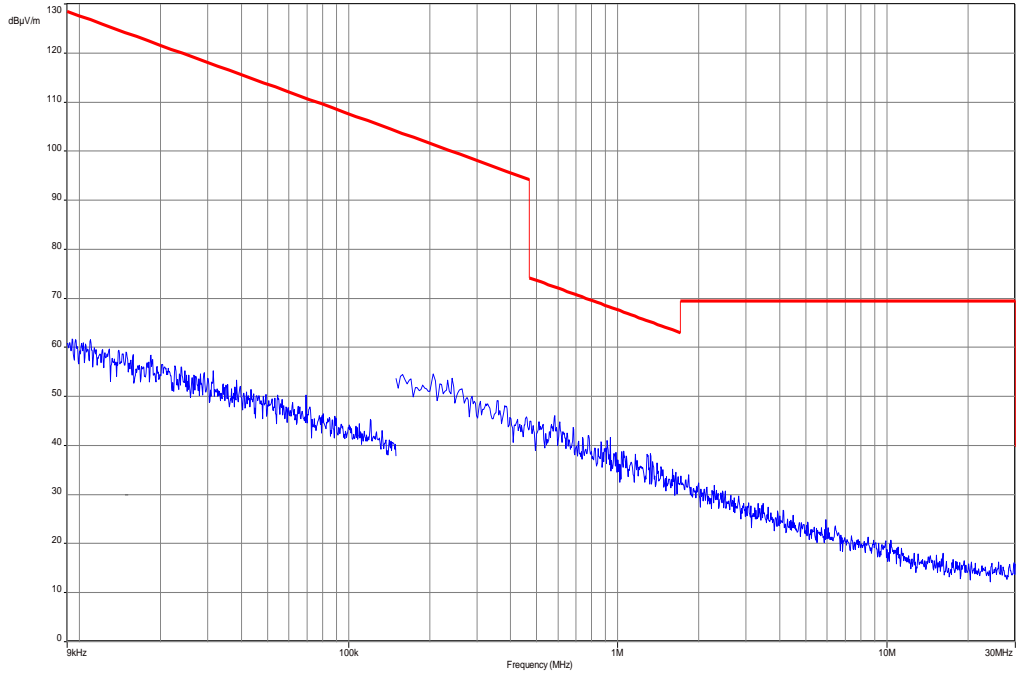

Plot 2: 9 kHz to 30 MHz, RX mode

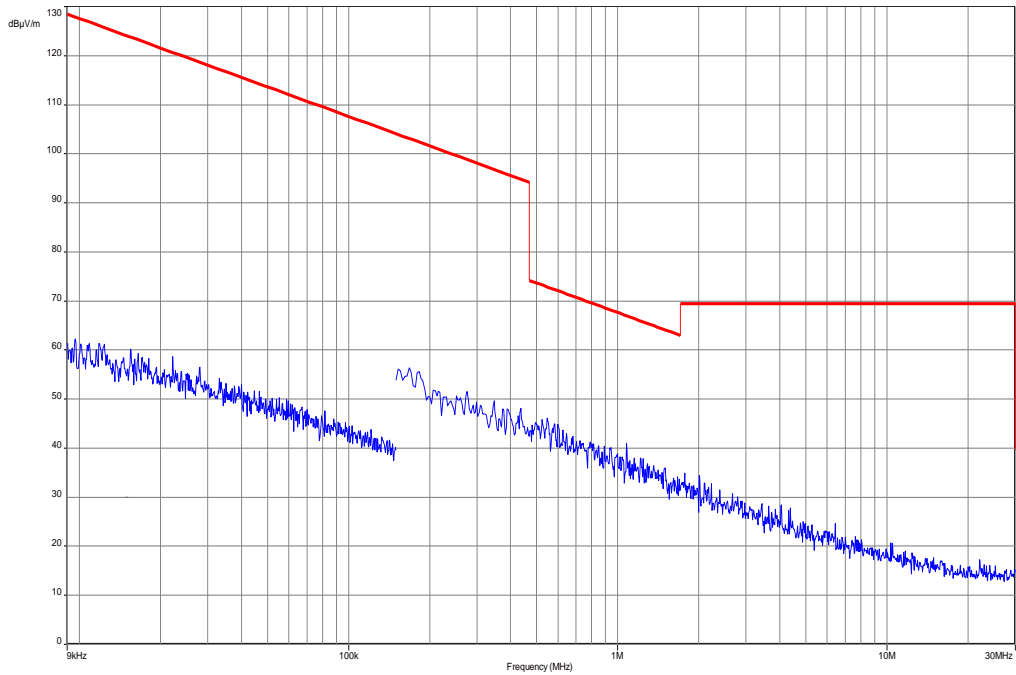

9.15 Spurious emissions conducted < 30 MHz

Description:

Measurement of the conducted spurious emissions in transmit mode below 30 MHz. The EUT is set to single channel mode and the transmit channel is channel 19. This measurement is representative for all channels and modes. If critical peaks are found channel 00 and channel 39 will be measured too. The measurement is performed in the mode with the highest output power. Both power lines, phase and neutral line, are measured. Found peaks are remeasured with average and quasi peak detection to show compliance to the limits.

Measurement:

Measurement parameter	
Detector:	Peak / Quasi peak / average
Sweep time:	Auto
Resolution bandwidth:	F < 150 kHz: 1 kHz F > 150 kHz: 100 kHz
Video bandwidth:	F < 150 kHz: 200 Hz F > 150 kHz: 9 kHz
Span:	9 kHz to 30 MHz
Trace-Mode:	Max Hold

Limits:

FCC	IC	
TX spurious emissions conducted < 30 MHz		
Frequency (MHz)	Quasi-peak (dBµV/m)	Average (dBµV/m)
0.15 – 0.5	66 to 56*	56 to 46*
0.5 – 5	56	46
5 – 30.0	60	50

*Decreases with the logarithm of the frequency

Results:

TX spurious emissions conducted < 30 MHz [dBµV/m]		
F [MHz]	Detector	Level [dBµV/m]
No critical peaks found!		
Measurement uncertainty	± 3 dB	

Result: Passed

Plots:

Plot 1: 9 kHz to 30 MHz, TX mode, phase line

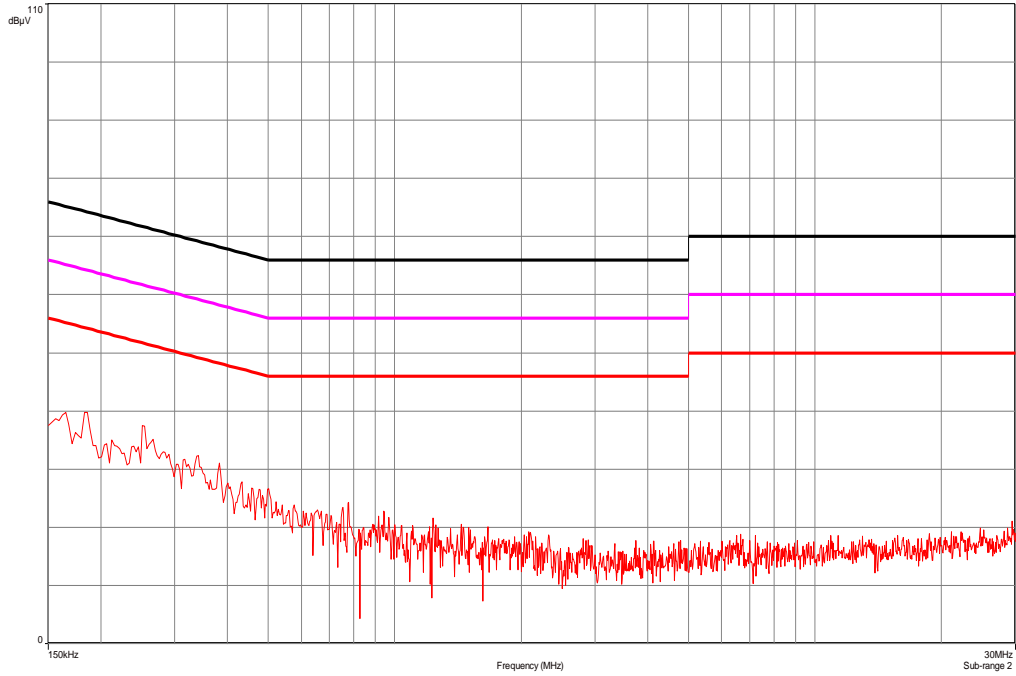

Plot 2: 9 kHz to 30 MHz, TX mode, neutral line

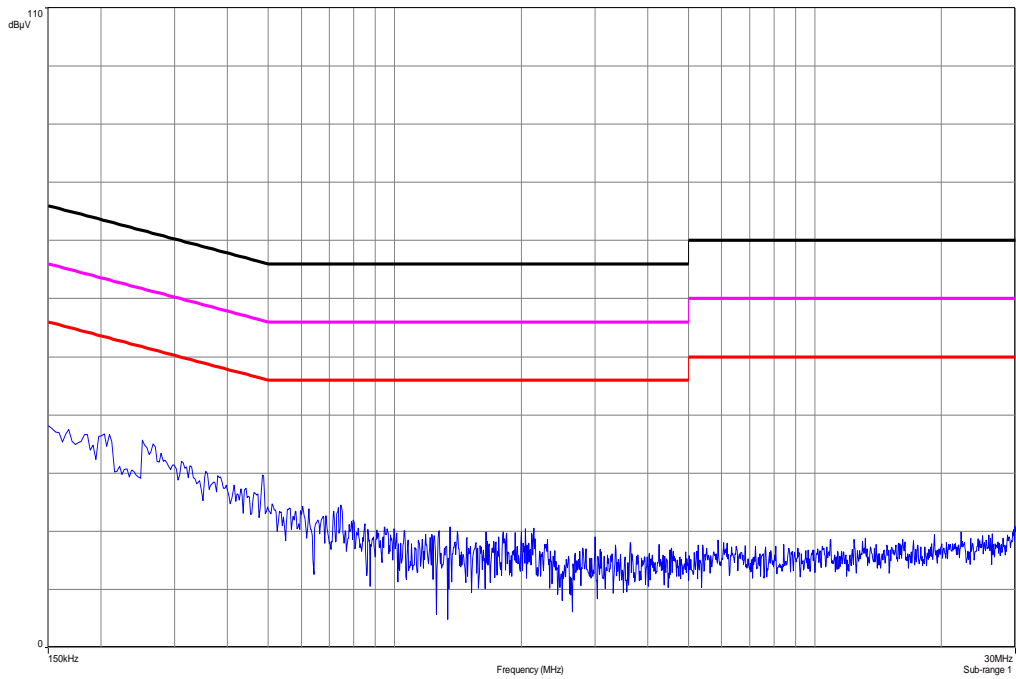

Plot 3: 9 kHz to 30 MHz, RX mode, phase line

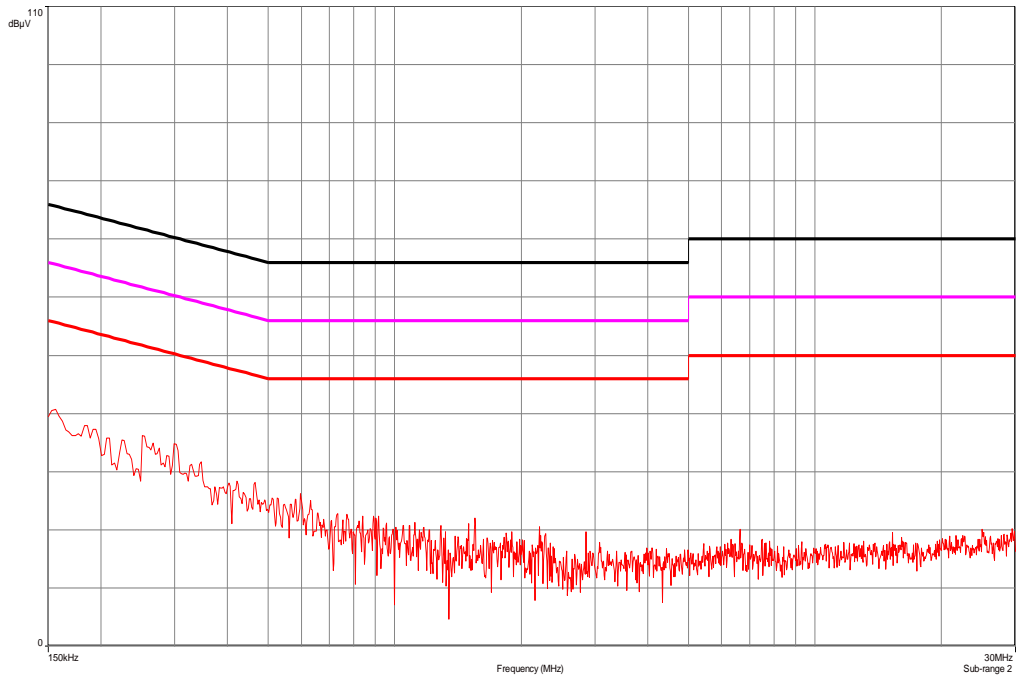

Plot 4: 9 kHz to 30 MHz, RX mode, neutral line

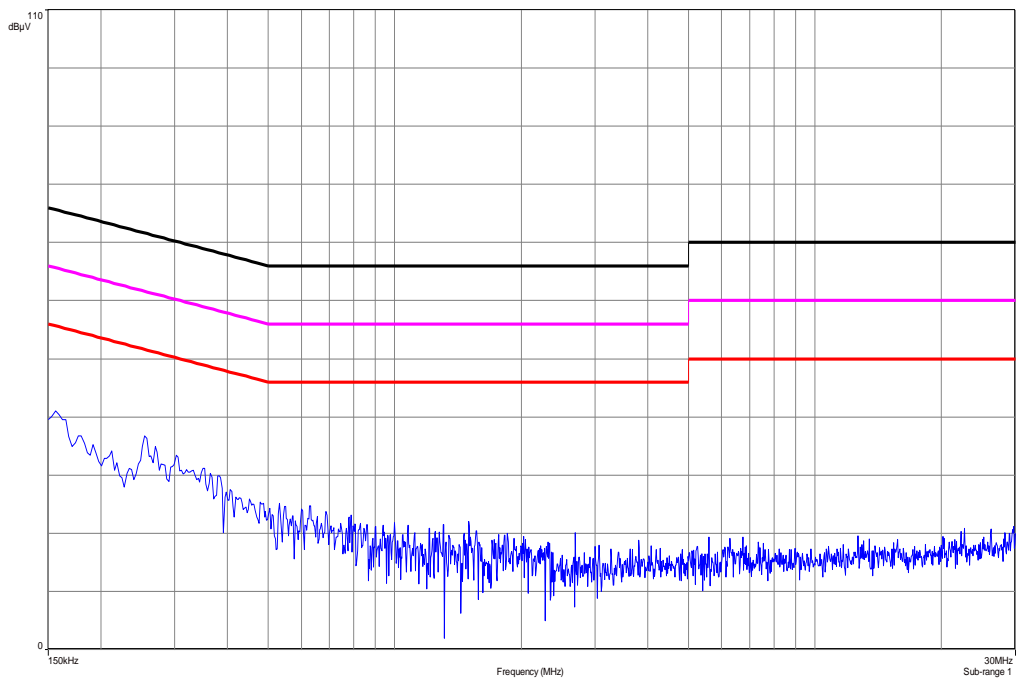

10 Test equipment and ancillaries used for tests

Typically, the calibrations of the test apparatus are commissioned to and performed by an accredited calibration laboratory. The calibration intervals are determined in accordance with the DIN EN ISO/IEC 17025. In addition to the external calibrations, the laboratory executes comparison measurements with other calibrated test systems or effective verifications. Weekly chamber inspections and range calibrations are performed. Where possible, rf-generating and signalling equipment as well as measuring receivers and analyzers are connected to an external high-precision 10 MHz reference (GPS-based or rubidium frequency standard).

In order to simplify the identification of the equipment used at some special tests, some items of test equipment and ancillaries can be provided with an identifier or number in the equipment list below (Labor/Item).

No.	Lab / Item	Equipment	Type	Manufact.	Serial No.	INV. No Cetecom	Kind of Calibration	Last Calibration	Next Calibration
1	45	Switch-Unit	3488A	HP Meßtechnik	2719A14505	300000368	g		
2	50	DC power supply, 60Vdc, 50A, 1200 W	6032A	HP Meßtechnik	2920A04466	300000580	ne		
3	n. a.	software	SPS_PHE 1.4f	Spitzberger & Spieß	B5981; 5D1081;B597 9	300000210	ne		
4	n. a.	EMI Test Receiver	ESCI 1166.5950. 03	R&S	100083	300003312	k	04.01.2012	04.01.2013
5	n. a.	Analyzer- Reference- System (Harmonics and Flicker)	ARS 16/1	SPS	A3509 07/0 0205	300003314	k	14.07.2011	14.07.2013
6	n. a.	Amplifier	JS42- 00502650- 28-5A	MITEQ	1084532	300003379	ev		
7	n. a.	Antenna Tower	Model 2175	ETS- LINDGREN	64762	300003745	izw		
8	n. a.	Positioning Controller	Model 2090	ETS- LINDGREN	64672	300003746	izw		
9	n. a.	Turntable Interface-Box	Model 105637	ETS- LINDGREN	44583	300003747	izw		
10	n. a.	TRILOG Broadband Test-Antenna 30 MHz - 3 GHz	VULB9163	Schwarzbe ck	295	300003787	k	12.04.2012	12.04.2014
11	n. a.	Spectrum- Analyzer	FSU26	R&S	200809	300003874	k	06.01.2012	06.01.2014
12	n. a.	DC power supply, 60Vdc, 50A, 1200 W	6032A	HP Meßtechnik	2818A03450	300001040	Ve	12.01.2012	12.01.2015
13	n. a.	Double-Ridged Waveguide Horn Antenna 1-18.0GHz	3115	EMCO	8812-3088	300001032	vIKI!	11.05.2011	11.05.2013
14	n. a.	Active Loop Antenna	6502	EMCO	2210	300001015	ne		
15	n. a.	Anechoic chamber	FAC 3/5m	MWB / TDK	87400/02	300000996	ev		
16	n. a.	Switch / Control Unit	3488A	HP Meßtechnik	*	300000199	ne		
17	n. a.	Switch / Control Unit	3488A	HP Meßtechnik	2719A15013	300001156	ne		
18	9	Isolating Transformer	MPL IEC625 Bus Regeltrennt ravo	Erfi	91350	300001155	ne		
19	n. a.	Three-Way Power Splitter, 50 Ohm	11850C	HP Meßtechnik		300000997	ne		
20	n. a.	Amplifier	js42- 00502650- 28-5a	Parzich GMBH	928979	300003143	ne		
21	n. a.	Band Reject filter	WRCG240 0/2483- 2375/2505- 50/10SS	Wainwright	11	300003351	ev		
22	n. a.	Highpass Filter	WHKX7.0/1 8G-8SS	Wainwright	18	300003789	ne		

23	n. a.	TRILOG Broadband Test-Antenna 30 MHz - 3 GHz	VULB9163	Schwarzbeck	371	300003854	vIKI!	14.10.2011	14.10.2014
24	n. a.	MXE EMI Receiver 20 Hz bis 26,5 GHz	N9038A	Agilent Technologies	MY51210197	300004405	k	19.12.2011	19.12.2012
25	n. a.	Switch / Control Unit	3488A	HP Meßtechnik		300001691	ne		
26	n. a.	Power Supply DC	NGPE 40/40	R&S	388	400000078	vIKI!	21.08.2012	21.08.2014
27	n. a.	Signal Analyzer 20Hz-26,5GHz-150 to + 30 DBM	FSIQ26	R&S	835540/018	300002681-0005	k	01.02.2012	01.02.2014
28	n. a.	Frequency Standard (Rubidium Frequency Standard)	MFS (Rubidium)	R&S (Datum)	002	300002681-0009	Ve	21.08.2012	21.08.2014
29	n. a.	Directional Coupler	101020010	Krytar	70215	300002840	ev		
30	n. a.	DC-Blocker	8143	Inmet Corp.	none	300002842	ne		
31	n. a.	Powersplitter	6005-3	Inmet Corp.		300002841	ev		
32	n. a.	Spectrum Analyzer 9kHz to 30GHz - 140...+30dBm	FSP30	R&S	100886	300003575	k	22.08.2012	22.08.2014
33	11b	Microwave System Amplifier, 0.5-26.5 GHz	83017A	HP Meßtechnik	00419	300002268	ev		
34	A025	Std. Gain Horn Antenna 12.4 to 18.0 GHz	639	Narda		300000786	ne		
35	A027	Std. Gain Horn Antenna 18.0 to 26.5 GHz	638	Narda		300000486	ne		
36	n. a.	Signal Analyzer 40 GHz	FSV40	R&S	101042	300004xxx	k	22.10.2012	22.10.2013

Agenda: Kind of Calibration

k	calibration / calibrated	EK	limited calibration
ne	not required (k, ev, izw, zw not required)	zw	cyclical maintenance (external cyclical maintenance)
ev	periodic self verification	izw	internal cyclical maintenance
Ve	long-term stability recognized	g	blocked for accredited testing
vIKI!	Attention: extended calibration interval		
NK!	Attention: not calibrated	*)	next calibration ordered / currently in progress

11 Observations

No observations exceeding those reported with the single test cases have been made.

Annex A Photographs of the test setup

Photo documentation:

Photo 1:

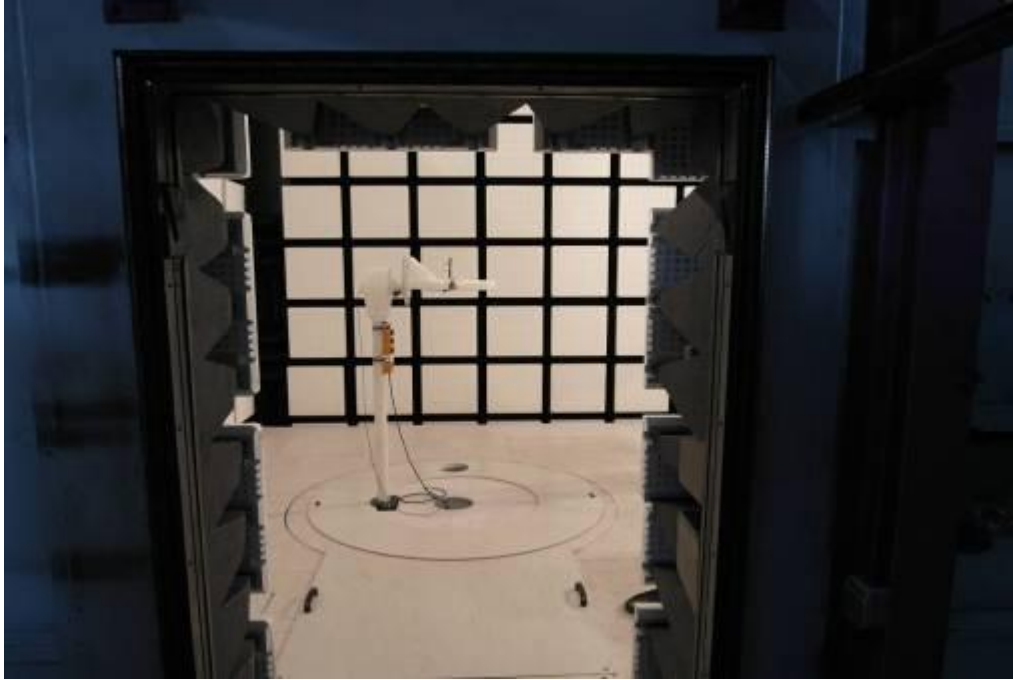

Photo 2:



Photo 3:



Photo 4:

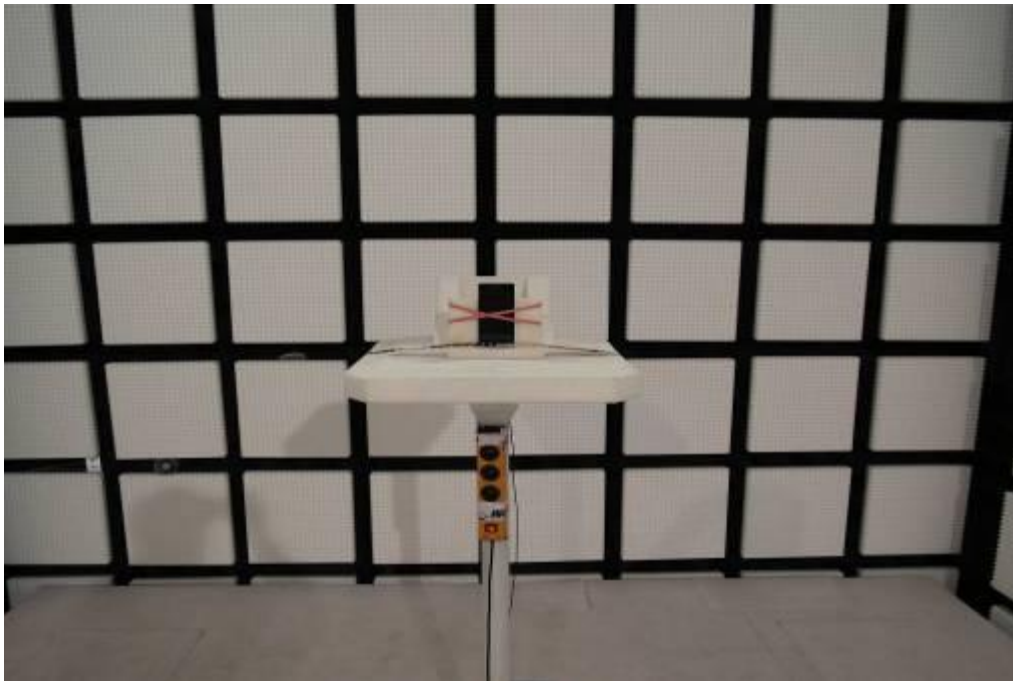

Photo 5:

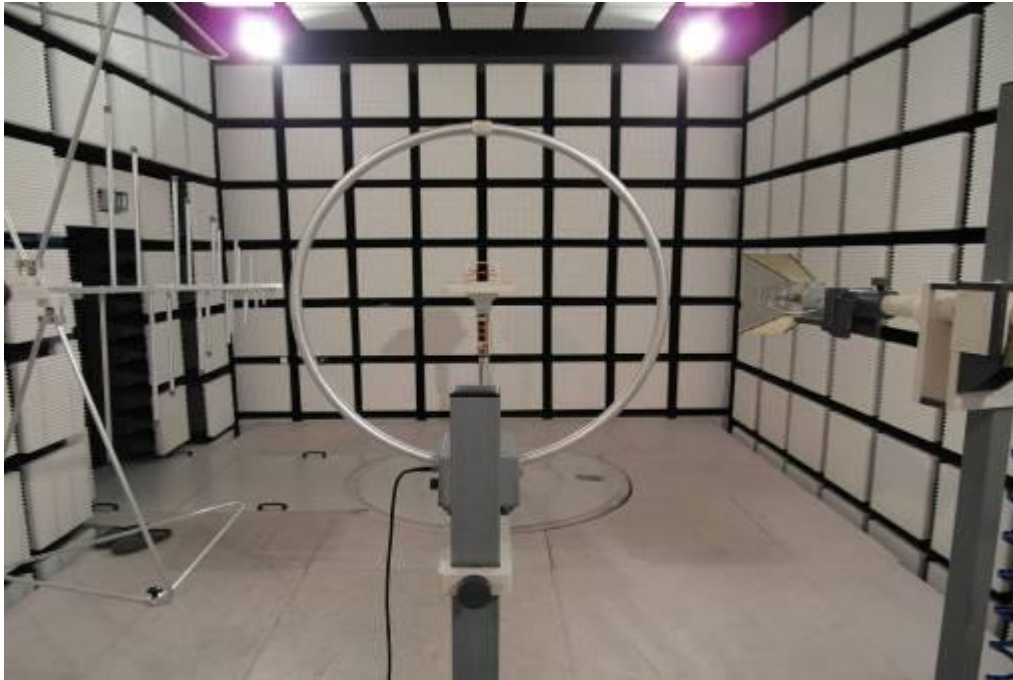

Photo 6:



Photo 7:



Annex B External photographs of the EUT

Photo documentation:

Photo 1:



Photo 2:

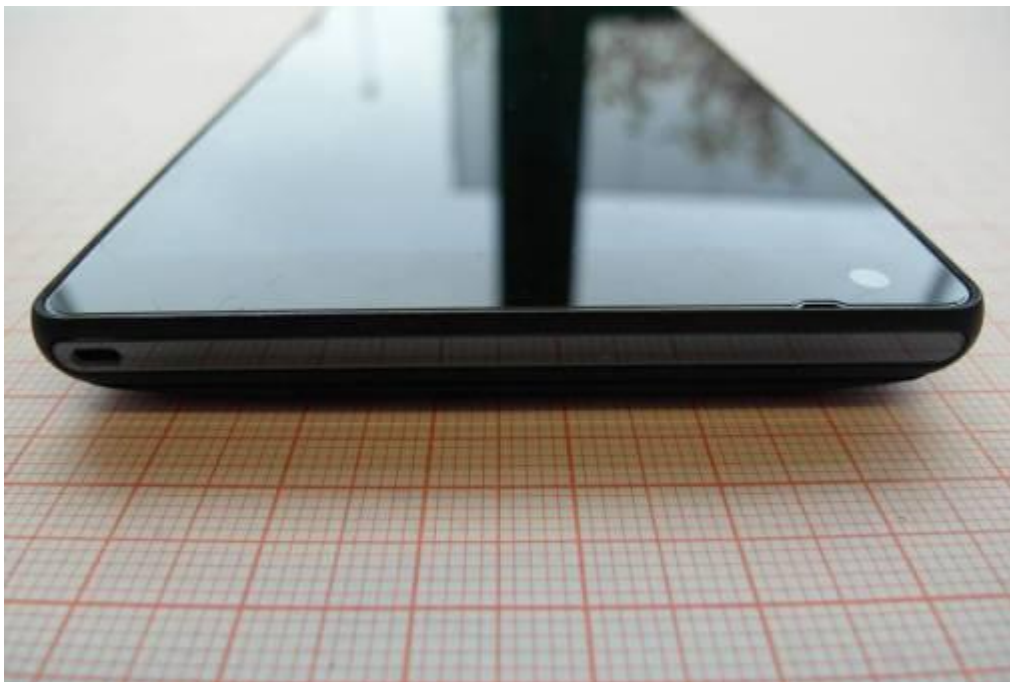

Photo 3:



Photo 4:



Photo 5:



Photo 6:



Photo 7:



Annex C Internal photographs of the EUT

Photo documentation:

Photo 1:



Photo 2:



Photo 3:

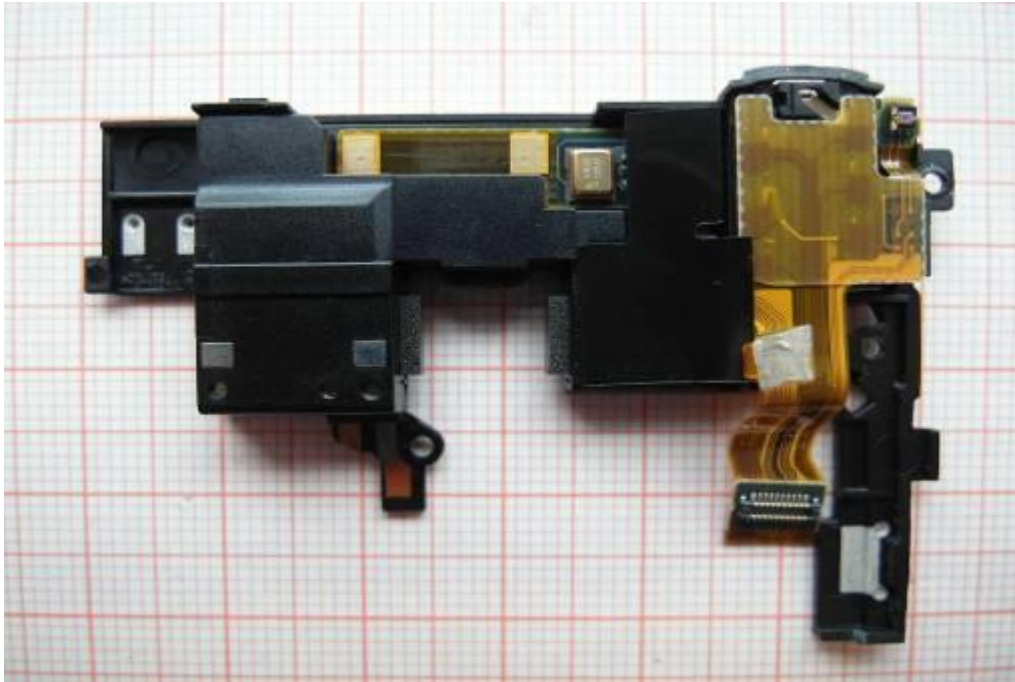

Photo 4:

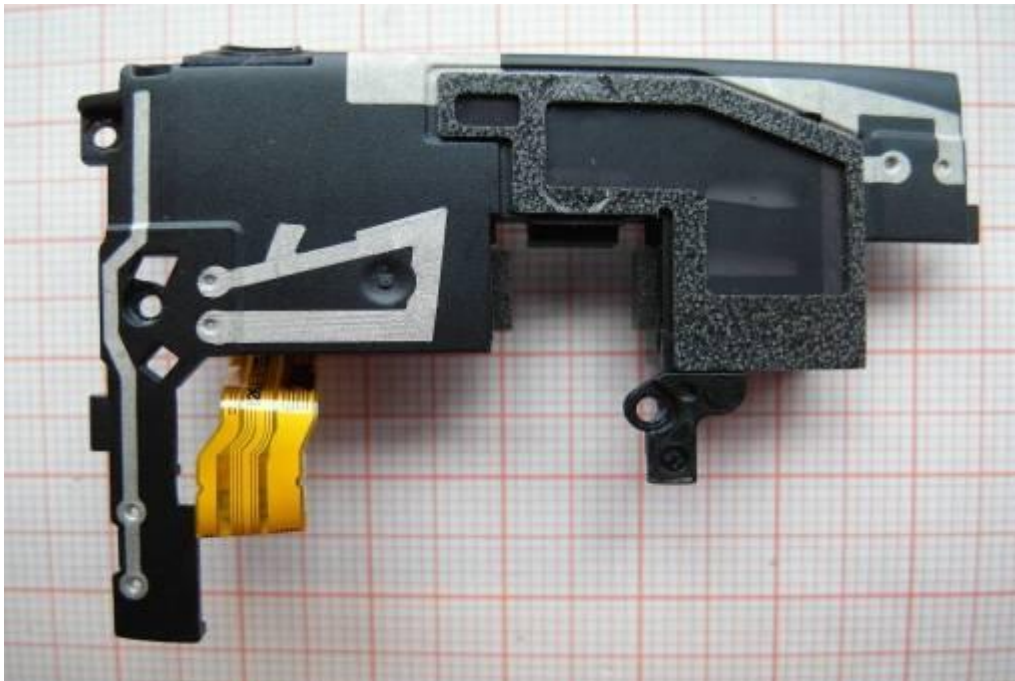

Photo 5:



Photo 6:



Photo 7:

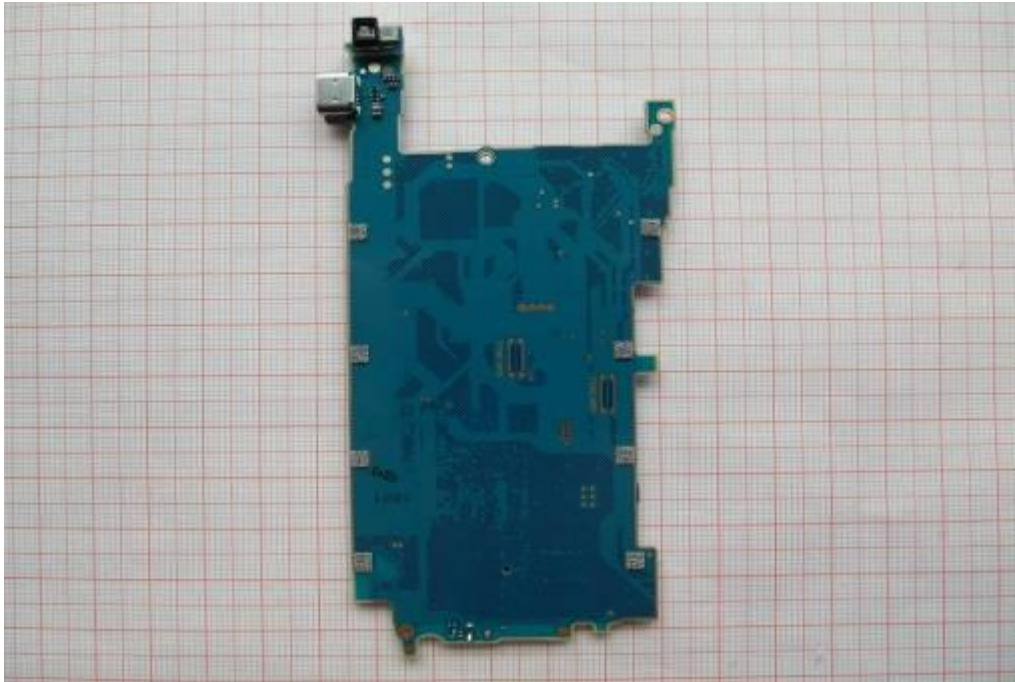

Photo 8:



Photo 9:



Photo 10:

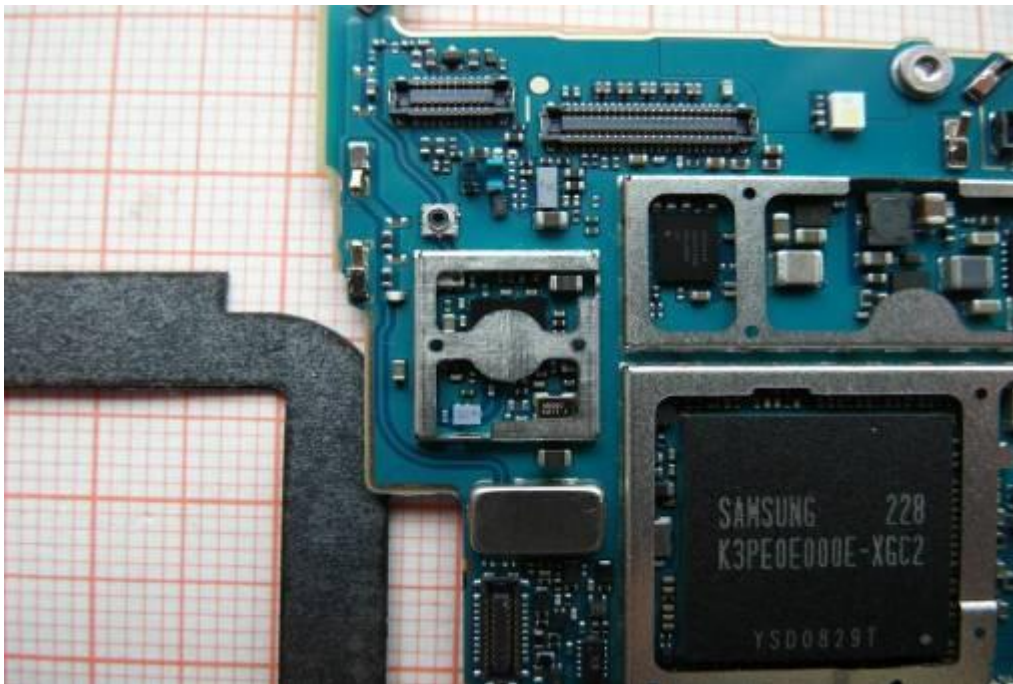

Photo 11:

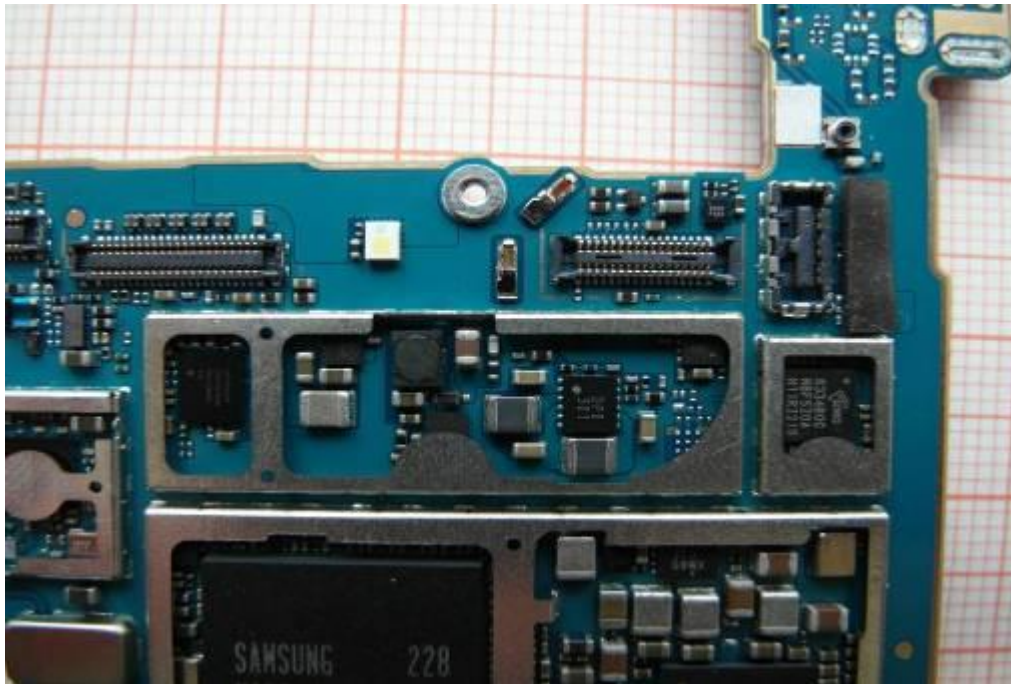
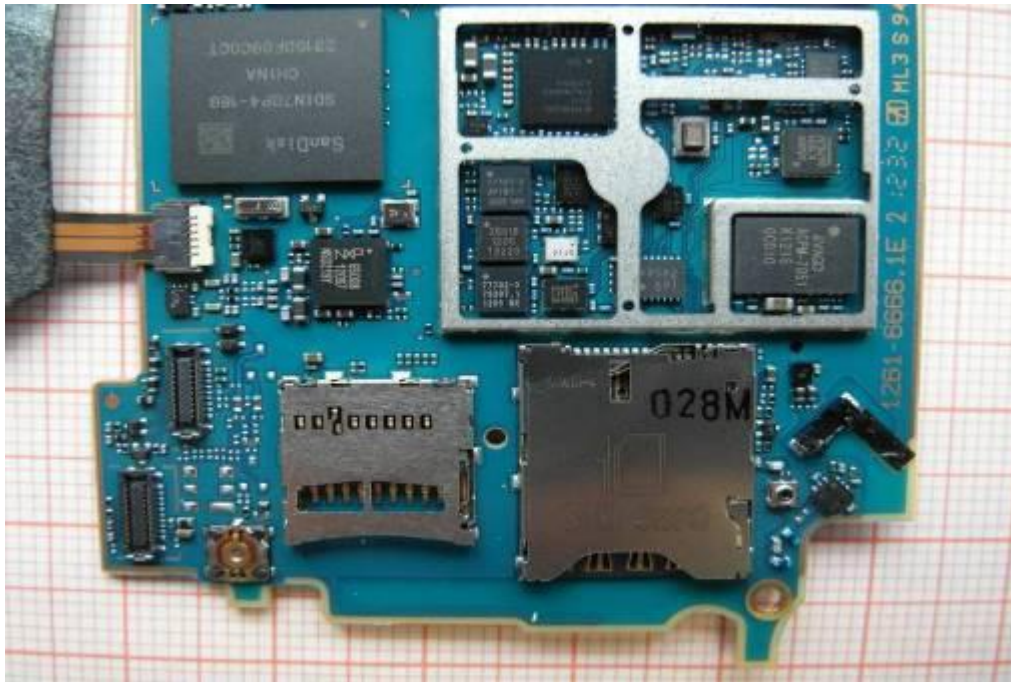

Photo 12:



Photo 13:



Annex D Document history

Version	Applied changes	Date of release
1.0	Initial release	2012-11-21

Annex E Further information**Glossary**

AVG	-	Average
DUT	-	Device under test
EMC	-	Electromagnetic Compatibility
EN	-	European Standard
EUT	-	Equipment under test
ETSI	-	European Telecommunications Standard Institute
FCC	-	Federal Communication Commission
FCC ID	-	Company Identifier at FCC
HW	-	Hardware
IC	-	Industry Canada
Inv. No.	-	Inventory number
N/A	-	Not applicable
PP	-	Positive peak
QP	-	Quasi peak
S/N	-	Serial number
SW	-	Software

Annex F Accreditation Certificate



Deutsche Akkreditierungsstelle GmbH
German Accreditation Body

Entrusted according to Section 8 subsection 1 AkkStelleG in connection with Section 1 subsection 1 AkkStelleGBV
Signatory to the Multilateral Agreements of EA, ILAC and IAF for Mutual Recognition

Accreditation



The Deutsche Akkreditierungsstelle GmbH (German Accreditation Body) attests that the testing laboratory

CETECOM ICT Services GmbH
Untertürkheimer Straße 6-10
66117 Saarbrücken

is competent under the terms of DIN EN ISO/IEC 17025:2005 to carry out tests in the following fields:

Wired communications and DECT
Acoustic
Radio
Shurt Range Devices (SRD)
RFID
WiMax and Richtfunk
Mobile radio (GSM / DCS), Over the Air (OTA) Performance
Electromagnetic Compatibility (EMC) incl. Automotive
Product safety
SAR and Hearing Aid Compatibility (HAC)
Environmental simulation
Smart Card Terminals
Bluetooth
Wi-Fi-Services

The accreditation certificate shall only apply in connection with the notice of accreditation of 13.04.2011 with the accreditation number D-PL-12076-01 and is valid until 03.09.2014. It comprises the cover sheet, the reverse side of the cover sheet and the following annex with a total of 82 pages.

Registration number of the certificate: **D-PL-12076-01-01**

Frankfurt am Main, 13.04.2011

Dipl.-Ing. (FH) Eberhard Egner
Head of Division 2

This document is a translation. The definitive version is the original German accreditation certificate.
See annex overleaf.

Front side of certificate

Deutsche Akkreditierungsstelle GmbH

Office Berlin
Spittelmarkt 10
10117 Berlin

Office Frankfurt am Main
Gartenstraße 6
60594 Frankfurt am Main

Office Braunschweig
Bundesallee 100
38116 Braunschweig

The publication of extracts of the accreditation certificate is subject to the prior written approval by Deutsche Akkreditierungsstelle GmbH (DAKKS). Exempted is the unchanged form of separate disseminations of the cover sheet by the conformity assessment body mentioned overleaf.

No impression shall be made that the accreditation also extends to fields beyond the scope of accreditation attested by DAKKS.

The accreditation was granted pursuant to the Act on the Accreditation Body (AkkStelleG) of 31 July 2009 (Federal Law Gazette I p. 2625) and the Regulation (EC) No 765/2008 of the European Parliament and of the Council of 9 July 2008 setting out the requirements for accreditation and market surveillance relating to the marketing of products (Official Journal of the European Union L 218 of 9 July 2008, p. 30). DAKKS is a signatory to the Multilateral Agreements for Mutual Recognition of the European co-operation for Accreditation (EA), International Accreditation Forum (IAF) and International Laboratory Accreditation Cooperation (ILAC). The signatories to these agreements recognise each other's accreditations.

The up-to-date state of membership can be retrieved from the following websites:

EA: www.european-accreditation.org
ILAC: www.ilac.org
IAF: www.iaf.nu

Back side of certificate

Note:

The current certificate including annex is published on our website (see link below) or may be received from CETECOM ICT Services on request.

http://www.cetecom.com/fileadmin/de/CETECOM_D_Saarbruecken/accreditations_Jan_2010/DAKKS_Akkredi_Urk_EN17025-En_incl_Annex.pdf