



TEST REPORT

Test report no.: 1-4254/12-62-17-A



Deutsche
Akkreditierungsstelle
D-PL-12076-01-01

Testing laboratory

CETECOM ICT Services GmbH
Untertuerkheimer Strasse 6 – 10
66117 Saarbruecken / Germany
Phone: + 49 681 5 98 - 0
Fax: + 49 681 5 98 - 9075
Internet: <http://www.cetecom.com>
e-mail: ict@cetecom.com

Accredited Testing Laboratory:

The testing laboratory (area of testing) is accredited according to DIN EN ISO/IEC 17025 (2005) by the Deutsche Akkreditierungsstelle GmbH (DAkkS). The accreditation is valid for the scope of testing procedures as stated in the accreditation certificate with the registration number: D-PL-12076-01-01
Area of Testing: Radio/Satellite Communications

Applicant

Sony Mobile Communications AB
Nya Vattentornet
22188 Lund / SWEDEN
Phone: +46 46 19 30 00
Fax: +46 46 19 32 95
Contact: Håkan Sjöberg
e-mail: hakan.sjoberg@sonymobile.com
Phone: +46 46 19 35 59

Manufacturer

Sony Mobile Communications AB
Nya Vattentornet
22188 Lund / SWEDEN

Test standard/s

47 CFR Part 27 Title 47 of the Code of Federal Regulations; Chapter I
Part 27 - Miscellaneous Wireless Communications Service
RSS - 139 Issue 2 Advanced Wireless Services Equipment Operating in the Bands 1710-1755 MHz
and 2110-2155 MHz

For further applied test standards please refer to section 3 of this test report.

Test Item

Kind of test item: GSM Mobile Phone GPRS/EGPRS 850/900/1800/1900; UMTS HSPA FDDI/II/IV/V/VIII; LTE FDD 1/2/4/5/17; WLAN a/b/g/n; BT 3.1; BT LE; RFID; FM Rx; A-GPS
Model name: PM-0230-BV
FCC ID: PY7PM-0230
IC: 4170B-PM0230
Frequency: LTE band IV: 1710.70 MHz – 1754.30 MHz
Technology tested: LTE
Antenna: Integrated antenna
Power Supply: 3.7 V DC by Li - polymer battery
Temperature Range: -30°C to +60 °C

Test report authorised:

2013-02-12 Andreas Luckenbill
Expert

Test performed:

2013-02-12 Marco Bertolino
Testing Manager

1 Table of contents

1 Table of contents2

2 General information3

 2.1 Notes and disclaimer3

 2.2 Application details.....3

3 Test standard/s3

4 Test environment.....4

5 Test item4

 5.1 Additional information4

6 Test laboratories sub-contracted4

7 Summary of measurement results5

 7.1 LTE – Band 45

8 RF measurements6

 8.1 Description of test setup6

 8.1.1 Radiated measurements.....6

 8.1.2 Conducted measurements.....7

 8.2 RSP100 test report cover sheet / performance test data8

 8.3 LTE technologies supported by EUT10

 8.4 Results LTE – Band 4.....11

 8.4.1 Antenna gain.....11

 8.4.2 RF output power12

 8.4.3 Frequency stability.....16

 8.4.4 Spurious emissions radiated19

 8.4.5 Spurious emissions conducted.....26

 8.4.6 Block edge compliance.....42

 8.4.7 Occupied bandwidth51

9 Test equipment and ancillaries used for tests59

10 Observations60

Annex A Document history61

Annex B Further information.....61

Annex C Accreditation Certificate62

2 General information

2.1 Notes and disclaimer

The test results of this test report relate exclusively to the test item specified in this test report. CETECOM ICT Services GmbH does not assume responsibility for any conclusions and generalizations drawn from the test results with regard to other specimens or samples of the type of the equipment represented by the test item.

The test report may only be reproduced or published in full. Reproduction or publication of extracts from the report requires the prior written approval of CETECOM ICT Services GmbH.

The testing service provided by CETECOM ICT Services GmbH has been rendered under the current "General Terms and Conditions for CETECOM ICT Services GmbH".

CETECOM ICT Services GmbH will not be liable for any loss or damage resulting from false, inaccurate, inappropriate or incomplete product information provided by the customer.

Under no circumstances does the CETECOM ICT Services GmbH test report include any endorsement or warranty regarding the functionality, quality or performance of any other product or service provided.

Under no circumstances does the CETECOM ICT Services GmbH test report include or imply any product or service warranties from CETECOM ICT Services GmbH, including, without limitation, any implied warranties of merchantability, fitness for purpose, or non-infringement, all of which are expressly disclaimed by CETECOM ICT Services GmbH.

All rights and remedies regarding vendor's products and services for which CETECOM ICT Services GmbH has prepared this test report shall be provided by the party offering such products or services and not by CETECOM ICT Services GmbH.

In no case this test report can be considered as a Letter of Approval.

2.2 Application details

| | |
|------------------------------------|------------|
| Date of receipt of order: | 2012-11-06 |
| Date of receipt of test item: | 2012-12-03 |
| Start of test: | 2012-12-04 |
| End of test: | 2013-02-08 |
| Person(s) present during the test: | -/- |

3 Test standard/s

| Test standard | Date | Test standard description |
|-------------------|---------|---|
| 47 CFR Part 27 | 2010-10 | Title 47 of the Code of Federal Regulations; Chapter I Part 27 - Miscellaneous Wireless Communications Service |
| RSS - 139 Issue 2 | 2009-02 | Advanced Wireless Services Equipment Operating in the Bands 1710-1755 MHz and 2110-2155 MHz |

4 Test environment

| | | |
|----------------------------|-----------|---------------------------------------|
| Temperature: | T_{nom} | +22 °C during room temperature tests |
| | T_{max} | +60 °C during high temperature tests |
| | T_{min} | -30 °C during low temperature tests |
| Relative humidity content: | | 42 % |
| Barometric pressure: | | not relevant for this kind of testing |
| Power supply: | V_{nom} | 3.7 V DC by Li - polymer battery |
| | V_{max} | 4.4 V |
| | V_{min} | 3.3 V |

5 Test item

| | | |
|----------------------|---|---|
| Kind of test item | : | GSM Mobile Phone GPRS/EGPRS 850/900/1800/1900; UMTS HSPA FDD/III/IV/V/VIII; LTE FDD 1/2/4/5/17; WLAN a/b/g/n; BT 3.1; BT LE; RFID; FM Rx; A-GPS |
| Type identification | : | PM-0230-BV |
| S/N serial number | : | Radiated units: CB5121Z4G3, CB5121Z4E1 Conducted unit: CB5121Z4FH, CB512322PD |
| HW hardware status | : | SP1.2, 1B/63 |
| SW software status | : | 10.1.A.0.194, and 10.1.A.1.17 |
| Frequency band [MHz] | : | LTE band IV: 1710.70 MHz – 1754.30 MHz |
| Type of modulation | : | QPSK, 16-QAM |
| Antenna | : | Integrated antenna |
| Power supply | : | 3.7 V DC by Li - polymer battery |
| Temperature range | : | -30°C to +60 °C |

5.1 Additional information

Test setup- and EUT-photos are included in test report 1-4254/12-62-03.

6 Test laboratories sub-contracted

None

7 Summary of measurement results

- No deviations from the technical specifications were ascertained
- There were deviations from the technical specifications ascertained

| TC identifier | Description | verdict | date | Remark |
|---------------|------------------------|---------|------------|--------|
| RF-Testing | CFR Part 27 RSS 139 | passed | 2013-02-12 | -/- |

7.1 LTE – Band 4

| Test Case | temperature conditions | power source voltages | Pass | Fail | NA | NP | Remark |
|------------------------------|------------------------|-----------------------|-------------------------------------|--------------------------|--------------------------|--------------------------|--------|
| RF Output Power | Nominal | Nominal | <input checked="" type="checkbox"/> | <input type="checkbox"/> | <input type="checkbox"/> | <input type="checkbox"/> | -/- |
| Frequency Stability | Nominal | Nominal | <input checked="" type="checkbox"/> | <input type="checkbox"/> | <input type="checkbox"/> | <input type="checkbox"/> | -/- |
| Spurious Emissions Radiated | Nominal | Nominal | <input checked="" type="checkbox"/> | <input type="checkbox"/> | <input type="checkbox"/> | <input type="checkbox"/> | -/- |
| Spurious Emissions Conducted | Nominal | Nominal | <input checked="" type="checkbox"/> | <input type="checkbox"/> | <input type="checkbox"/> | <input type="checkbox"/> | -/- |
| Block Edge Compliance | Nominal | Nominal | <input checked="" type="checkbox"/> | <input type="checkbox"/> | <input type="checkbox"/> | <input type="checkbox"/> | -/- |
| Occupied Bandwidth | Nominal | Nominal | <input checked="" type="checkbox"/> | <input type="checkbox"/> | <input type="checkbox"/> | <input type="checkbox"/> | -/- |

Note: NA = Not applicable; NP = Not performed

8 RF measurements

8.1 Description of test setup

For the spurious measurements we use the substitution method according TIA/EIA 603.

8.1.1 Radiated measurements

The radiated emissions from the EUT are performed in a semi anechoic chamber. The EUT is placed on a conductive turntable and powered with nominal voltage. The signalling is performed either from outside the chamber with a signalling unit (AP or other) by air link using a signalling antenna or directly by special test software from the customer.

Semi anechoic chamber

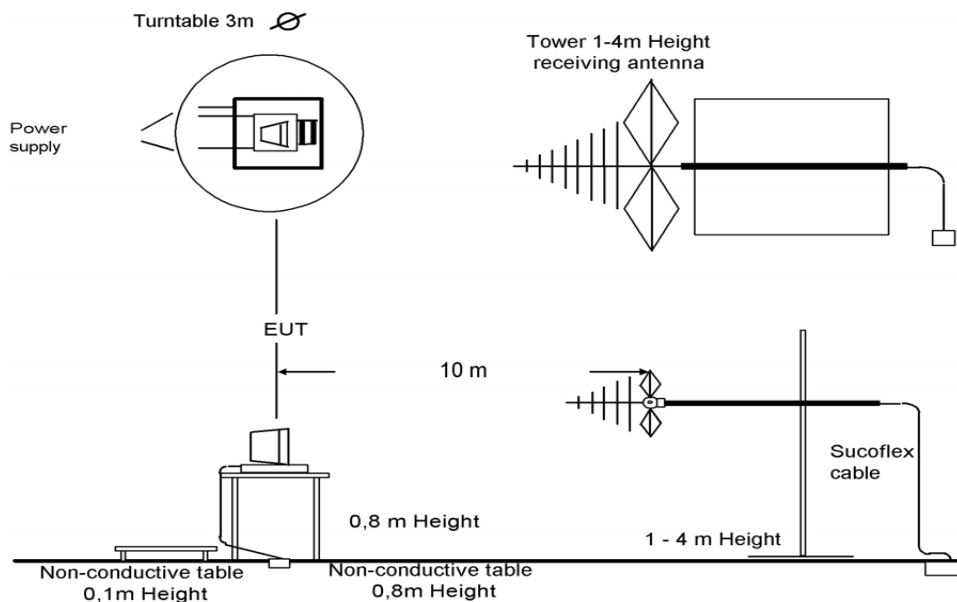

Picture 1: Diagram radiated measurements

| | |
|-----------------|---------------------|
| 9 kHz - 30 MHz: | active loop antenna |
| 30 MHz – 1 GHz: | tri-log antenna |
| > 1 GHz: | horn antenna |

8.1.2 Conducted measurements

The EUT's RF signal is coupled out by the antenna connector which is supplied by the manufacturer. The signal is first 10dB attenuated before it is power divided (~6dB loss per branch). One of the signal paths is connected to the signalling unit (AP or other), the other one is connected to the spectrum analyzer. The specific losses for both signal paths are first checked within a calibration. The measurement readings on the signalling unit/spectrum analyzer are corrected by the specific test set-up loss. The attenuator, power divider, signalling unit and the spectrum analyzer are impedance matched on 50 Ohm. If special software is used, there is no power divider necessary.

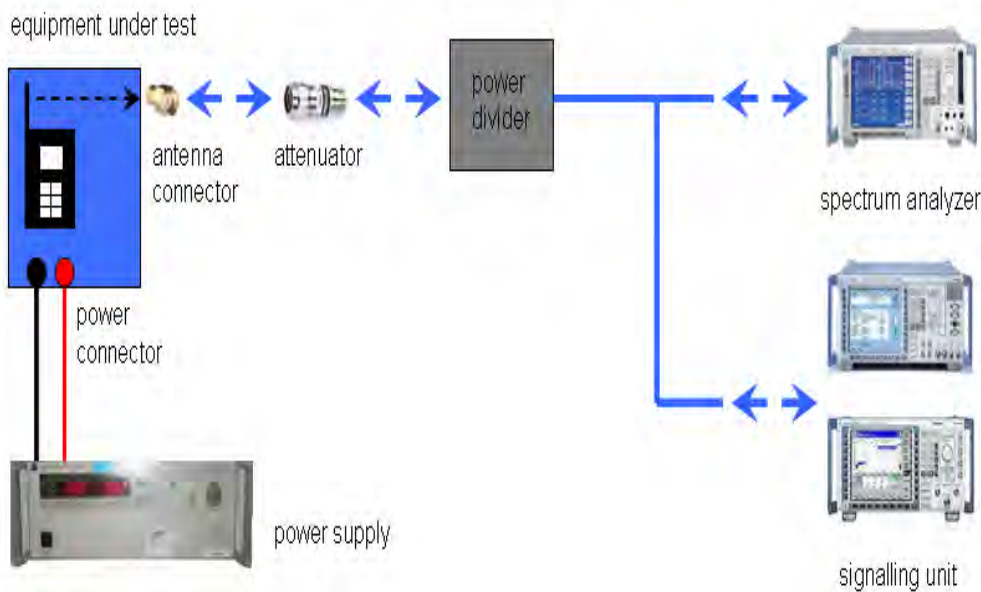

Picture 2: Diagram conducted measurements

The term measuring receiver refers to either a selective voltmeter or a spectrum analyser.

| Frequency being measured f | Measuring receiver bandwidth 6 dB | Spectrum analyser bandwidth 3dB |
|---|--------------------------------------|------------------------------------|
| $f < 150 \text{ kHz}$ | 200 Hz or | 300 Hz |
| $150 \text{ kHz} \leq f < 25 \text{ MHz}$ | 9 kHz or | 10 kHz |
| $25 \text{ MHz} \leq f < 1000 \text{ MHz}$ | 120 kHz or | 100 kHz |
| $1000 \text{ MHz} \leq f$ | | 1 MHz |
| NOTE: Specific requirements in CEPT/ERC/Recommendation 70-03 [2] shall be applied where applicable. | | |

8.2 RSP100 test report cover sheet / performance test data

| | | | | | | | | |
|---|--------|--|---|-----------------|----------------------------------|------|--------|------|
| Test Report Number | : | 1-4254/12-62-17-A | | | | | | |
| Equipment Model Number | : | PM-0230-BV | | | | | | |
| Certification Number | : | 4170B-PM0230 | | | | | | |
| Manufacturer (complete Address) | : | Sony Mobile Communications AB Nya Vattentornet 22188 Lund / SWEDEN | | | | | | |
| Tested to radio standards specification no. | : | RSS - 139 Issue 2 | | | | | | |
| Open Area Test Site IC No. | : | IC 3462C-1 | | | | | | |
| Frequency Range | : | LTE: 1710.70 MHz – 1754.30 MHz | | | | | | |
| GPS receiver turned | : | On | | | | | | |
| RF-power [dBm] (max.) | : | Band | Channel bandwidth | Conducted [dBm] | ERP / EIRP [dBm] | Mode | | |
| | | LTE – Band 4 | 1.4 | | 23.8 | 27.0 | QPSK | |
| | | | | | 23.1 | 26.2 | 16-QAM | |
| | | | 3 | | 24.0 | 26.9 | QPSK | |
| | | | | | 22.6 | 26.1 | 16-QAM | |
| | | | 5 | | 24.0 | 26.8 | QPSK | |
| | | | | | 22.7 | 25.8 | 16-QAM | |
| | | | 10 | | 23.9 | 26.6 | QPSK | |
| | | | | | 22.5 | 25.7 | 16-QAM | |
| | | | 15 | | 23.8 | 26.6 | QPSK | |
| | | | | | 22.5 | 25.6 | 16-QAM | |
| | | | 20 | | 23.7 | 26.6 | QPSK | |
| | | | | | 22.7 | 25.6 | 16-QAM | |
| | | | Occupied bandwidth (99%-BW) [kHz] | : | LTE – Band 4 | 1.4 | 1090 | QPSK |
| 1093 | 16-QAM | | | | | | | |
| 3 | 2729 | QPSK | | | | | | |
| | 2730 | 16-QAM | | | | | | |
| 5 | 4495 | QPSK | | | | | | |
| | 4498 | 16-QAM | | | | | | |
| 10 | 9016 | QPSK | | | | | | |
| | 9022 | 16-QAM | | | | | | |
| 15 | 13436 | QPSK | | | | | | |
| | 13435 | 16-QAM | | | | | | |
| 20 | 17953 | QPSK | | | | | | |
| | 17961 | 16-QAM | | | | | | |
| Type of modulation | : | QPSK; 16-QAM | | | | | | |
| Emission Designator (TRC-43) | : | LTE – Band 4 | 1.4 | 1M09G7D | QPSK | | | |
| | | | | 1M09W7D | 16-QAM | | | |
| | | | 3 | 2M73G7D | QPSK | | | |
| | | | | 2M73W7D | 16-QAM | | | |
| | | | 5 | 4M50G7D | QPSK | | | |
| | | | | 4M50W7D | 16-QAM | | | |
| | | | 10 | 9M02G7D | QPSK | | | |
| | | | | 9M02W7D | 16-QAM | | | |
| | | | 15 | 13M4G7D | QPSK | | | |
| | | | | 13M4W7D | 16-QAM | | | |
| | | | 20 | 18M0G7D | QPSK | | | |
| | | | | 18M0W7D | 16-QAM | | | |
| | | | Antenna Information | : | Integrated antenna | | | |
| | | | Transmitter Spurious (worst case) [dBm] | : | -45 @ 4 GHz (noise floor / peak) | | | |

ATTESTATION:
DECLARATION OF COMPLIANCE:

I attest that the testing was performed or supervised by me; that the test measurements were made in accordance with the above-mentioned Industry Canada standard(s); and that the equipment identified in this application has been subjected to all the applicable test conditions specified in the Industry Canada standards and all of the requirements of the standard have been met.

Laboratory Manager:

2013-02-12
Date

Marco Bertolino
Name

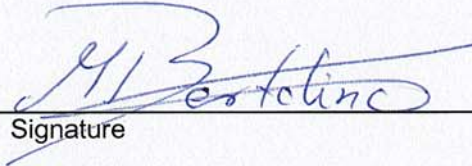
A handwritten signature in black ink, appearing to read 'M Bertolino', written over a horizontal line. The signature is stylized and cursive.

Signature

8.3 LTE technologies supported by EUT

Channel bandwidth

| | Band 4 |
|-------|-------------------------------------|
| [MHz] | Provided / not provided |
| 1.4 | <input checked="" type="checkbox"/> |
| 3 | <input checked="" type="checkbox"/> |
| 5 | <input checked="" type="checkbox"/> |
| 10 | <input checked="" type="checkbox"/> |
| 15 | <input checked="" type="checkbox"/> |
| 20 | <input checked="" type="checkbox"/> |

Antenna

| | |
|-------------|-------------------------------------|
| SISO | <input type="checkbox"/> |
| SIMO | <input type="checkbox"/> |
| MISO | <input checked="" type="checkbox"/> |
| MIMO | <input type="checkbox"/> |

8.4 Results LTE – Band 4

The EUT was set to transmit the maximum power.

8.4.1 Antenna gain

Description:

The antenna gain of the complete system is calculated by the difference of radiated power in EIRP and the conducted power of the module

Results:

| T_{nom} | V_{nom} | lowest channel | middle channel | highest channel |
|--------------------------|-----------|----------------|----------------|-----------------|
| Conducted power [dBm] | | 22.6 | 22.7 | 22.8 |
| Radiated power [dBm] | | 25.7 | 25.4 | 27.0 |
| Gain [dBi] Calculated | | 3.1 | 2.7 | 4.2 |

8.4.2 RF output power

Description:

This paragraph contains average power, peak output power and EIRP measurements for the mobile station. In all cases, the peak output power is within the required mask (this mask is specified in the JTC standards, TIA PN3389 Vol. 1 Chap 7, and is no FCC requirement).

Measurement:

The mobile was set up for the maximum output power with pseudo random data modulation.

To determine the Peak-To-Average Power Ratio (PAPR) the measurement was performed with the Power Complementary Cumulative Distribution Function (CCDF).

| Measurement parameters | |
|------------------------|-------------------------------|
| Detector: | Peak and RMS (Power in Burst) |
| Sweep time: | Auto |
| Video bandwidth: | Depends on Channel Bandwidth |
| Resolution bandwidth: | Depends on Channel Bandwidth |
| Span: | Zero Span |
| Trace-Mode: | Max Hold |

Limits:

| FCC | IC |
|---|---------|
| CFR Part 27.1101 CFR Part 2.1046 | RSS 139 |
| Nominal Peak Output Power | |
| +30.00 dBm In measuring transmissions in this band using an average power technique, the peak-to-average ratio (PAR) of the transmission may not exceed 13 dB. | |

Results:

| Output Power (conducted) | | | | | | |
|--------------------------|-----------------|---------------------------|---------------------------------|----------------------------|-----------------------------------|----------------------------|
| Bandwidth (MHz) | Frequency (MHz) | Resource block allocation | Average Output Power (dBm) QPSK | Peak to Average Ratio (dB) | Average Output Power (dBm) 16-QAM | Peak to Average Ratio (dB) |
| 1.4 | 1710.7 | 1 RB low | 23.6 | 4.1 | 22.9 | 5.2 |
| | | 1 RB high | 23.6 | 4.2 | 22.9 | 5.2 |
| | | 50% RB mid | 23.6 | 4.4 | 22.5 | 5.5 |
| | | 100% RB | 22.6 | 5.6 | 21.5 | 6.9 |
| | 1732.5 | 1 RB low | 23.6 | 4.4 | 22.7 | 5.7 |
| | | 1 RB high | 23.5 | 4.4 | 22.7 | 5.6 |
| | | 50% RB mid | 23.5 | 4.8 | 22.6 | 5.7 |
| | | 100% RB | 22.7 | 5.8 | 21.7 | 7.0 |
| | 1754.3 | 1 RB low | 23.8 | 4.6 | 23.1 | 5.1 |
| | | 1 RB high | 23.7 | 4.7 | 23.1 | 5.1 |
| | | 50% RB mid | 23.8 | 4.8 | 22.9 | 5.5 |
| | | 100% RB | 22.8 | 5.6 | 22.0 | 5.9 |
| 3 | 1711.5 | 1 RB low | 23.7 | 4.4 | 22.4 | 5.4 |
| | | 1 RB high | 23.8 | 4.4 | 22.4 | 5.4 |
| | | 50% RB mid | 22.6 | 5.2 | 21.8 | 6.2 |
| | | 100% RB | 22.6 | 5.5 | 21.6 | 6.7 |
| | 1732.5 | 1 RB low | 23.8 | 4.6 | 22.5 | 5.5 |
| | | 1 RB high | 23.7 | 4.7 | 22.5 | 5.5 |
| | | 50% RB mid | 22.6 | 5.3 | 21.7 | 6.3 |
| | | 100% RB | 22.6 | 5.7 | 21.6 | 6.8 |
| | 1753.5 | 1 RB low | 23.9 | 4.8 | 22.6 | 5.7 |
| | | 1 RB high | 24.0 | 4.7 | 22.6 | 5.7 |
| | | 50% RB mid | 22.8 | 5.4 | 21.9 | 6.5 |
| | | 100% RB | 22.7 | 5.8 | 21.9 | 7.1 |
| 5 | 1712.5 | 1 RB low | 23.7 | 4.3 | 22.5 | 5.2 |
| | | 1 RB high | 23.6 | 4.5 | 22.4 | 5.4 |
| | | 50% RB mid | 22.6 | 5.1 | 21.6 | 6.4 |
| | | 100% RB | 22.5 | 5.9 | 21.4 | 7.1 |
| | 1732.5 | 1 RB low | 23.7 | 4.6 | 22.5 | 5.5 |
| | | 1 RB high | 23.6 | 4.7 | 22.4 | 5.5 |
| | | 50% RB mid | 22.6 | 5.3 | 21.6 | 6.5 |
| | | 100% RB | 22.5 | 5.9 | 21.4 | 7.2 |
| | 1752.5 | 1 RB low | 24.0 | 4.5 | 22.7 | 5.5 |
| | | 1 RB high | 23.8 | 4.6 | 22.6 | 5.5 |
| | | 50% RB mid | 22.8 | 5.3 | 21.6 | 6.7 |
| | | 100% RB | 22.6 | 5.8 | 21.6 | 7.2 |

| | | | | | | |
|-------------------------|--------|------------|----------|-----|------|-----|
| 10 | 1715.0 | 1 RB low | 23.8 | 4.4 | 22.3 | 5.4 |
| | | 1 RB high | 23.8 | 4.5 | 22.4 | 5.5 |
| | | 50% RB mid | 22.4 | 5.4 | 21.4 | 6.5 |
| | | 100% RB | 22.4 | 6.1 | 21.3 | 6.8 |
| | 1732.5 | 1 RB low | 23.8 | 4.6 | 22.3 | 5.6 |
| | | 1 RB high | 23.7 | 4.7 | 22.4 | 5.6 |
| | | 50% RB mid | 22.4 | 5.5 | 21.5 | 6.5 |
| | | 100% RB | 22.3 | 6.1 | 21.4 | 6.8 |
| | 1750.0 | 1 RB low | 23.9 | 4.6 | 22.5 | 5.6 |
| | | 1 RB high | 23.8 | 4.6 | 22.4 | 5.6 |
| | | 50% RB mid | 22.5 | 5.5 | 21.6 | 6.6 |
| | | 100% RB | 22.4 | 6.2 | 21.5 | 6.8 |
| 15 | 1717.5 | 1 RB low | 23.7 | 4.3 | 22.4 | 5.3 |
| | | 1 RB high | 23.7 | 4.5 | 22.4 | 5.5 |
| | | 50% RB mid | 22.3 | 5.6 | 21.4 | 6.5 |
| | | 100% RB | 22.4 | 6.2 | 21.2 | 7.0 |
| | 1732.5 | 1 RB low | 23.6 | 4.7 | 22.4 | 5.5 |
| | | 1 RB high | 23.7 | 4.6 | 22.5 | 5.5 |
| | | 50% RB mid | 22.3 | 5.6 | 21.3 | 6.6 |
| | | 100% RB | 22.3 | 6.2 | 21.2 | 7.1 |
| | 1747.5 | 1 RB low | 23.7 | 4.6 | 22.5 | 5.5 |
| | | 1 RB high | 23.8 | 4.6 | 22.5 | 5.6 |
| | | 50% RB mid | 22.5 | 5.7 | 21.5 | 6.6 |
| | | 100% RB | 22.4 | 6.3 | 21.4 | 7.3 |
| 20 | 1720.0 | 1 RB low | 23.6 | 4.2 | 22.6 | 5.5 |
| | | 1 RB high | 23.6 | 4.5 | 22.6 | 5.7 |
| | | 50% RB mid | 22.3 | 5.8 | 21.3 | 6.8 |
| | | 100% RB | 22.4 | 6.1 | 21.4 | 7.2 |
| | 1732.5 | 1 RB low | 23.6 | 4.5 | 22.7 | 5.6 |
| | | 1 RB high | 23.6 | 4.5 | 22.7 | 5.7 |
| | | 50% RB mid | 22.3 | 5.8 | 21.3 | 6.8 |
| | | 100% RB | 22.3 | 6.2 | 21.4 | 7.0 |
| | 1745.0 | 1 RB low | 23.7 | 4.4 | 22.7 | 5.7 |
| | | 1 RB high | 23.7 | 4.5 | 22.7 | 5.7 |
| | | 50% RB mid | 22.5 | 5.8 | 21.5 | 6.8 |
| | | 100% RB | 22.4 | 6.1 | 21.4 | 7.3 |
| Measurement uncertainty | | | ± 0.5 dB | | | |

The output power was measured with the lowest supported channel bandwidth and with the number of resource blocks where the highest output power conducted was found.

All other bandwidths were calculated with the corresponding antenna gain (with full resource blocks).

| Output Power (radiated) | | | |
|-------------------------|-----------------|---------------------------------|-----------------------------------|
| Bandwidth (MHz) | Frequency (MHz) | Average Output Power (dBm) QPSK | Average Output Power (dBm) 16-QAM |
| 1.4 | 1710.7 | 25.7 | 24.6 |
| | 1732.5 | 25.4 | 24.4 |
| | 1754.3 | 27.0 | 26.2 |
| 3 | 1711.5 | 25.7 | 24.7 |
| | 1732.5 | 25.3 | 24.3 |
| | 1753.5 | 26.9 | 26.1 |
| 5 | 1712.5 | 25.6 | 24.5 |
| | 1732.5 | 25.2 | 24.1 |
| | 1752.5 | 26.8 | 25.8 |
| 10 | 1715.0 | 25.5 | 24.4 |
| | 1732.5 | 25.0 | 24.1 |
| | 1750.0 | 26.6 | 25.7 |
| 15 | 1717.5 | 25.5 | 24.3 |
| | 1732.5 | 25.0 | 23.9 |
| | 1747.5 | 26.6 | 25.6 |
| 20 | 1720.0 | 25.5 | 24.5 |
| | 1732.5 | 25.0 | 24.1 |
| | 1745.0 | 26.6 | 25.6 |
| Measurement uncertainty | | ± 3.0 dB | |

Result: Passed

8.4.3 Frequency stability

Description:

In order to measure the carrier frequency under the condition of AFC lock, it is necessary to make measurements with the mobile station in a “call mode”. This is accomplished with the use of a R&S CMW500 DIGITAL RADIOCOMMUNICATION TESTER.

1. Measure the carrier frequency at room temperature.
2. Subject the mobile station to overnight soak at -30 C.
3. With the mobile station, powered with V_{nom} , connected to the CMW500 and in a simulated call on channel 1412 (centre channel), measure the carrier frequency. These measurements should be made within two minutes of powering up the mobile station, to prevent significant self warming.
4. Repeat the above measurements at 10°C increments from -30°C to +60°C. Allow at least 1.5 hours at each temperature, unpowered, before making measurements.
5. Remeasure carrier frequency at room temperature with V_{nom} . Vary supply voltage from V_{min} to V_{max} , in 0.1 Volt steps remeasuring carrier frequency at each voltage. Pause at V_{nom} for 1.5 hours unpowered, to allow any self heating to stabilize, before continuing.
6. At all temperature levels hold the temperature to +/- 0.5°C during the measurement procedure.

This measurement was performed with the highest channel bandwidth supported from the EUT on the middle channel

Measurement:

| Measurement parameters | |
|------------------------|----------------------|
| Detector: | Measured with CMW500 |
| Sweep time: | |
| Video bandwidth: | |
| Resolution bandwidth: | |
| Span: | |
| Trace-Mode: | |

Limits:

| FCC | IC |
|-----------------------------------|---------|
| CFR Part 27.54 CFR Part 2.1055 | RSS 139 |
| Frequency Stability | |
| < 2.5 ppm | |

Results:**FREQ ERROR versus VOLTAGE**

| Voltage (V) | Frequency Error (Hz) | Frequency Error (%) | Frequency Error (ppm) |
|-------------|----------------------|---------------------|-----------------------|
| 3.3 | 19 | 0.00000110 | 0.0110 |
| 3.4 | 7 | 0.00000040 | 0.0040 |
| 3.5 | -5 | -0.00000029 | -0.0029 |
| 3.6 | -11 | -0.00000063 | -0.0063 |
| 3.7 | 14 | 0.00000081 | 0.0081 |
| 3.8 | 13 | 0.00000075 | 0.0075 |
| 3.9 | -9 | -0.00000052 | -0.0052 |
| 4.0 | 10 | 0.00000058 | 0.0058 |
| 4.1 | -17 | -0.00000098 | -0.0098 |
| 4.2 | 12 | 0.00000069 | 0.0069 |
| 4.3 | 12 | 0.00000069 | 0.0069 |
| 4.4 | -14 | -0.00000081 | -0.0081 |

FREQ ERROR versus TEMPERATURE

| Temperature (°C) | Frequency Error (Hz) | Frequency Error (%) | Frequency Error (ppm) |
|------------------|----------------------|---------------------|-----------------------|
| -30 | 11 | 0.00000063 | 0.0063 |
| -20 | 14 | 0.00000081 | 0.0081 |
| -10 | -9 | -0.00000052 | -0.0052 |
| ± 0 | -13 | -0.00000075 | -0.0075 |
| 10 | 2 | 0.00000012 | 0.0012 |
| 20 | 8 | 0.00000046 | 0.0046 |
| 30 | -12 | -0.00000069 | -0.0069 |
| 40 | 4 | 0.00000023 | 0.0023 |
| 50 | -3 | -0.00000017 | -0.0017 |
| 60 | 13 | 0.00000075 | 0.0075 |

Frequency Error vs. Voltage

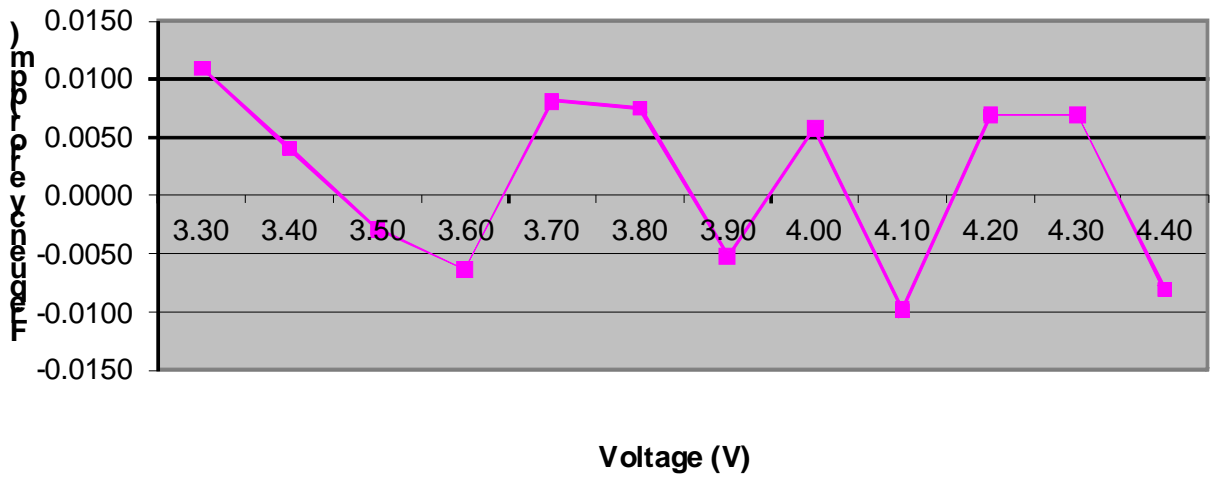

Frequency Error vs. Temperature

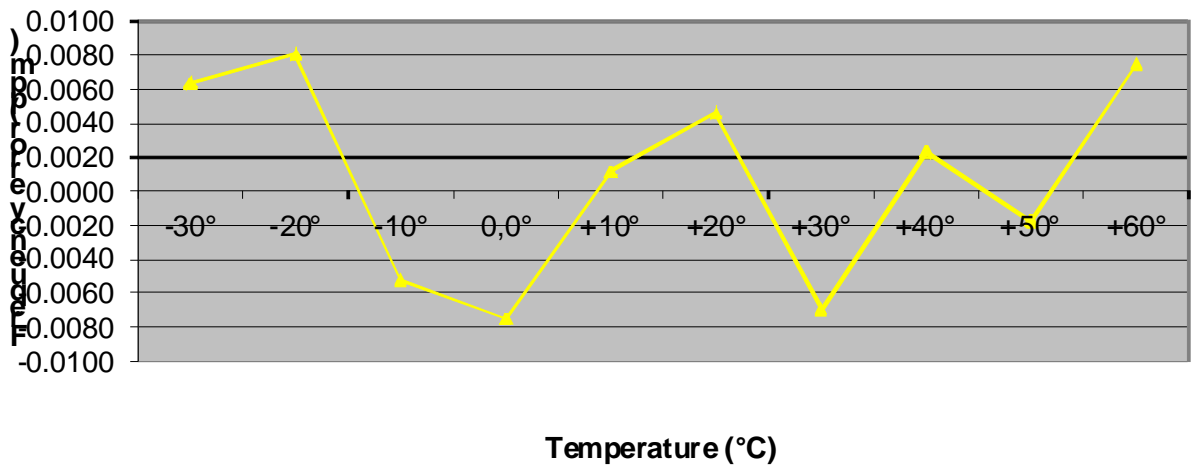

Result: Passed

8.4.4 Spurious emissions radiated

Description:

The following steps outline the procedure used to measure the radiated emissions from the mobile station. The site is constructed in accordance with ANSI C63.4:2009 requirements and is recognized by the FCC to be in compliance for a 3 and a 10 meter site. The spectrum was scanned from 30 MHz to the 10th harmonic of the highest frequency generated within the equipment, which is the transmitted carrier that can be as high as 1755 MHz. This was rounded up to 20 GHz. The resolution bandwidth is set as outlined in Part 27.53. The spectrum was scanned with the mobile station transmitting at carrier frequencies that pertain to low, mid and high channels of the LTE band 4.

The final open field emission (here 10m semi-anechoic chamber listed by FCC) test procedure is as follows:

- a) The test item was placed on a 0.8 meter high non-conductive stand at a 3 meter test distance from the receive antenna.
- b) The antenna output was terminated in a 50 ohm load (if possible).
- c) A double ridged wave guide antenna was placed on an adjustable height antenna mast 3 meters from the test item for emission measurements.
- d) Detected emissions were maximized at each frequency by rotating the test item and adjusting the receive antenna height and polarization. The maximum meter reading was recorded. The radiated emission measurements of the harmonics of the transmit frequency through the 10th harmonic were measured with peak detector and 1 MHz bandwidth. If the harmonic could not be detected above the noise floor, the ambient level was recorded. The equivalent power into a dipole antenna was calculated from the field intensity levels measured at 3 meters.
- e) Now each detected emissions were substituted by the substitution method, in accordance with the TIA/EIA 603.

Measurement:

| Measurement parameters | |
|------------------------|---|
| Detector: | Peak |
| Sweep time: | 2 sec. |
| Video bandwidth: | Below 1 GHz: 100 kHz Above 1 GHz: 1 MHz / 3MHz |
| Resolution bandwidth: | Below 1 GHz: 100 kHz Above 1 GHz: 1 MHz |
| Span: | 100 MHz Steps |
| Trace-Mode: | Max Hold |

Limits:

| FCC | IC |
|--|---------|
| CFR Part 27.53(g) CFR Part 2.1053 | RSS 139 |
| Spurious Emissions Radiated | |
| Attenuation $\geq 43 + 10\log(P)$ (P, Power in Watts) | |
| -13 dBm | |

Results:

Radiated emissions measurements were made only at the upper, center, and lower carrier frequencies of the LTE band 4 (1712.5 MHz, 1732.5 MHz and 1752.5 MHz). It was decided that measurements at these three carrier frequencies would be sufficient to demonstrate compliance with emissions limits because it was seen that all the significant spurs occur well outside the band and no radiation was seen from a carrier in one block of the LTE band 4 into any of the other blocks. The equipment must still, however, meet emissions requirements with the carrier at all frequencies over which it is capable of operating and it is the manufacturer's responsibility to verify this.

The final open field radiated levels are presented on the next pages.

All measurements were done in horizontal and vertical polarization; the plots show the worst case.

The plots show only the middle channel at the channel bandwidth and resource blocks with the highest output power. If spurious were detected, the lowest and highest channel and all supported channel bandwidths were checked, too.

As can be seen from this data, the emissions from the test item were within the specification limit.

QPSK

| SPURIOUS EMISSION LEVEL (dBm) | | | | | | | | |
|-------------------------------|----------------------------|------------------------|----------|----------------------------|------------------------|----------|-----------------------------|------------------------|
| Harmonic | Lowest channel Freq. (MHz) | Level [dBm] | Harmonic | Middle channel Freq. (MHz) | Level [dBm] | Harmonic | Highest channel Freq. (MHz) | Level [dBm] |
| 2 | 3425.0 | No emissions detected. | 2 | 3465.0 | No emissions detected. | 2 | 3505.0 | No emissions detected. |
| 3 | 5137.5 | | 3 | 5197.5 | | 3 | 5257.5 | |
| 4 | 6850.0 | | 4 | 6930.0 | | 4 | 7010.0 | |
| 5 | 8562.5 | | 5 | 8662.5 | | 5 | 8762.5 | |
| 6 | 10275.0 | | 6 | 10395.0 | | 6 | 10515.0 | |
| 7 | 11987.5 | | 7 | 12127.5 | | 7 | 12267.5 | |
| 8 | 13700.0 | | 8 | 13860.0 | | 8 | 14020.0 | |
| 9 | 15412.5 | | 9 | 15592.5 | | 9 | 15772.5 | |
| 10 | 17125.0 | | 10 | 17325.0 | | 10 | 17525.0 | |
| Measurement uncertainty | | | | | | ± 3dB | | |

16-QAM

| SPURIOUS EMISSION LEVEL (dBm) | | | | | | | | |
|-------------------------------|----------------------------|------------------------|----------|----------------------------|------------------------|----------|-----------------------------|------------------------|
| Harmonic | Lowest channel Freq. (MHz) | Level [dBm] | Harmonic | Middle channel Freq. (MHz) | Level [dBm] | Harmonic | Highest channel Freq. (MHz) | Level [dBm] |
| 2 | 3425.0 | No emissions detected. | 2 | 3465.0 | No emissions detected. | 2 | 3505.0 | No emissions detected. |
| 3 | 5137.5 | | 3 | 5197.5 | | 3 | 5257.5 | |
| 4 | 6850.0 | | 4 | 6930.0 | | 4 | 7010.0 | |
| 5 | 8562.5 | | 5 | 8662.5 | | 5 | 8762.5 | |
| 6 | 10275.0 | | 6 | 10395.0 | | 6 | 10515.0 | |
| 7 | 11987.5 | | 7 | 12127.5 | | 7 | 12267.5 | |
| 8 | 13700.0 | | 8 | 13860.0 | | 8 | 14020.0 | |
| 9 | 15412.5 | | 9 | 15592.5 | | 9 | 15772.5 | |
| 10 | 17125.0 | | 10 | 17325.0 | | 10 | 17525.0 | |
| Measurement uncertainty | | | | | | ± 3dB | | |

Result: Passed

QPSK with 10 MHz channel bandwidth

Plot 1: Channel 20175 (Traffic mode up to 30 MHz)

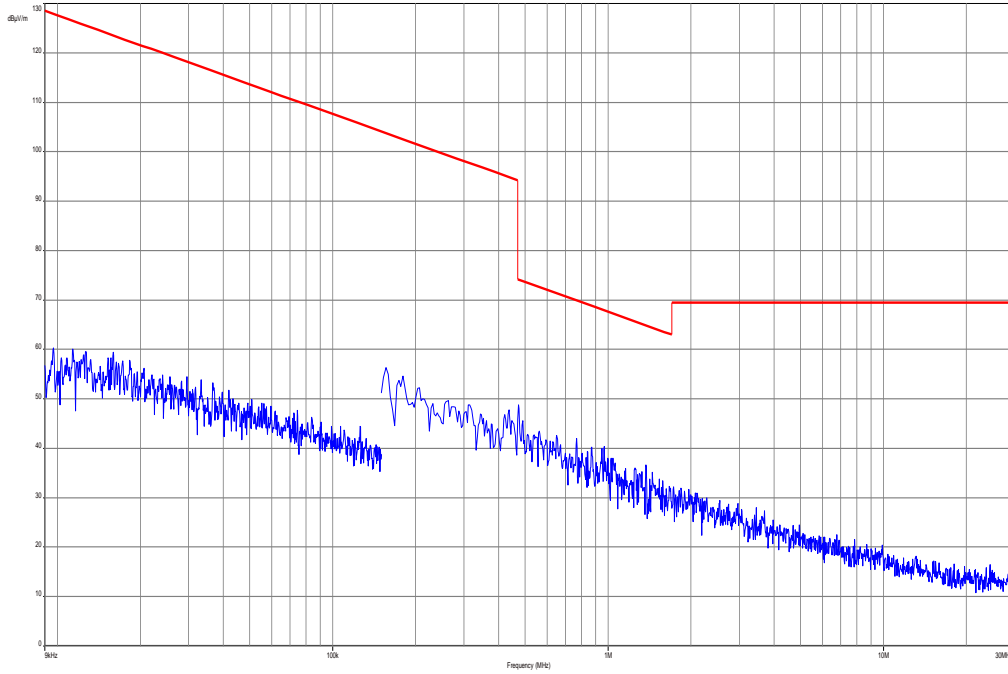

Plot 2: Channel 20175 (30 MHz – 12.75 GHz)

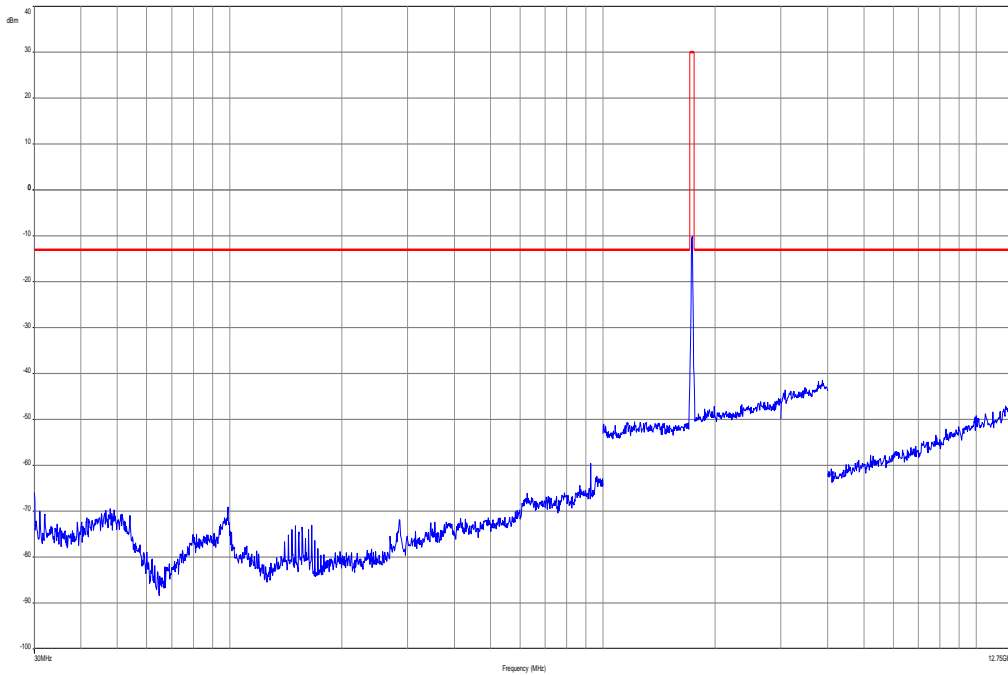

Plot 3: Channel 20175 (12.75 GHz – 25 GHz)

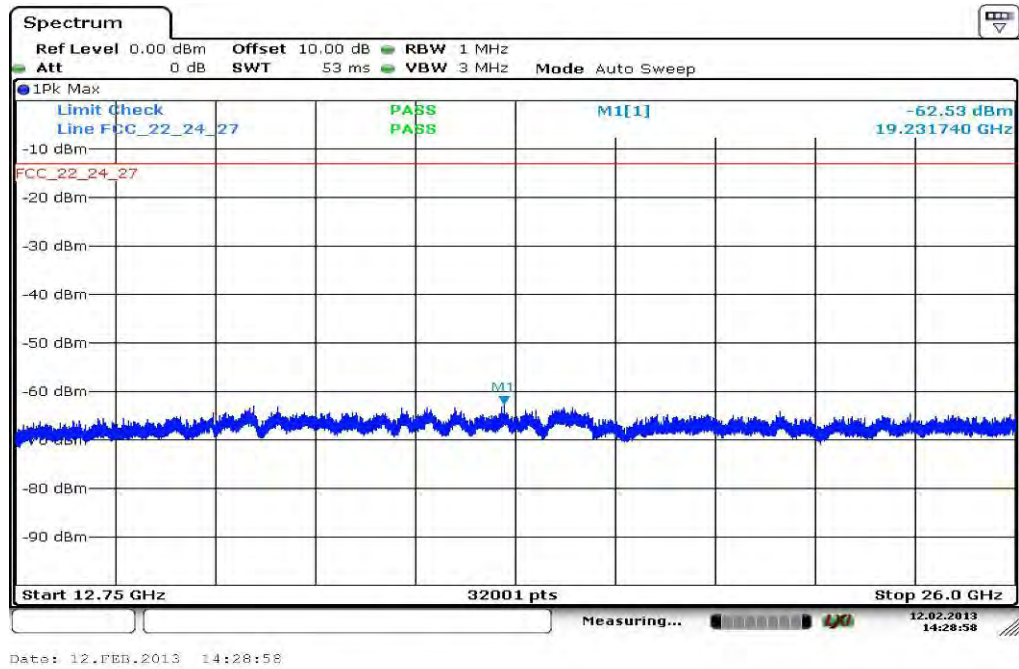

16-QAM with 10 MHz channel bandwidth

Plot 4: Channel 20175 (Traffic mode up to 30 MHz)

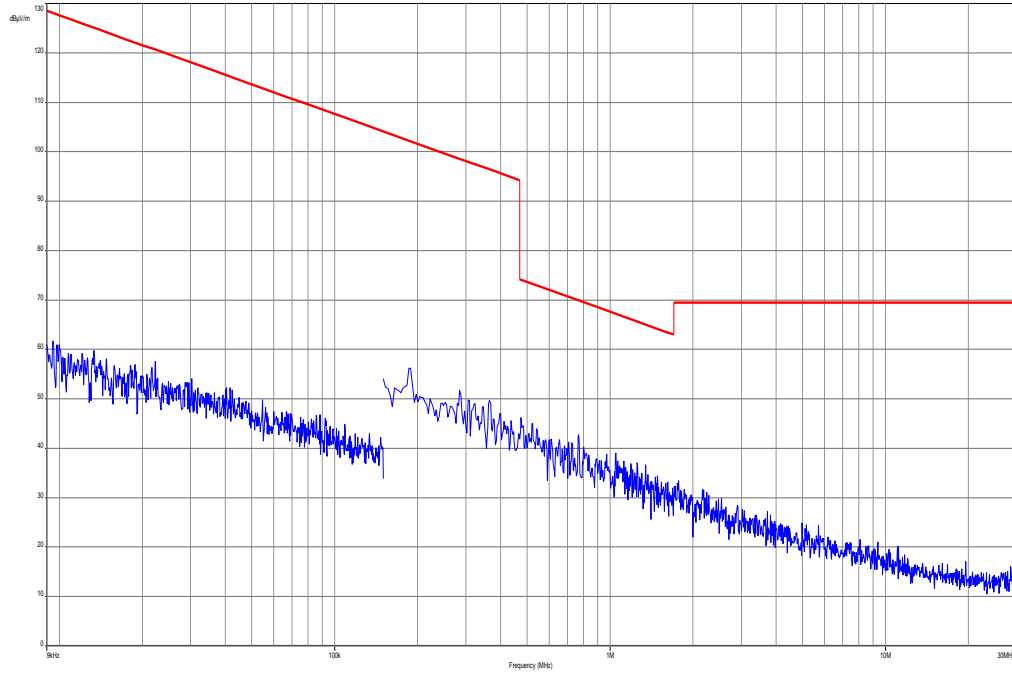

Plot 5: Channel 20175 (30 MHz – 12.75 GHz)

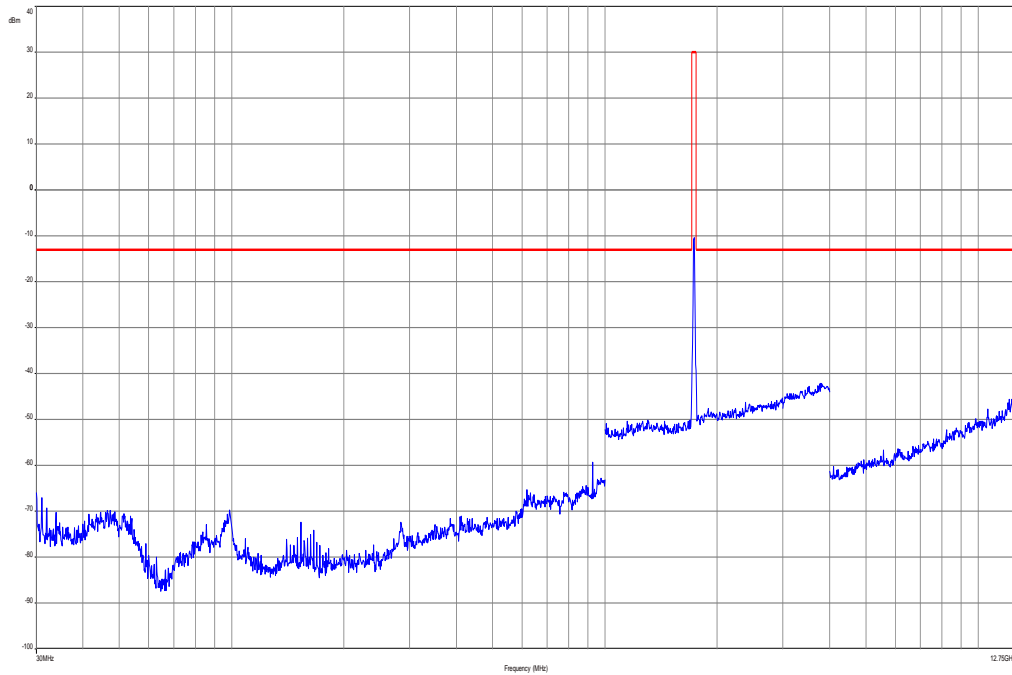

Plot 6: Channel 20175 (12.75 GHz – 25 GHz)

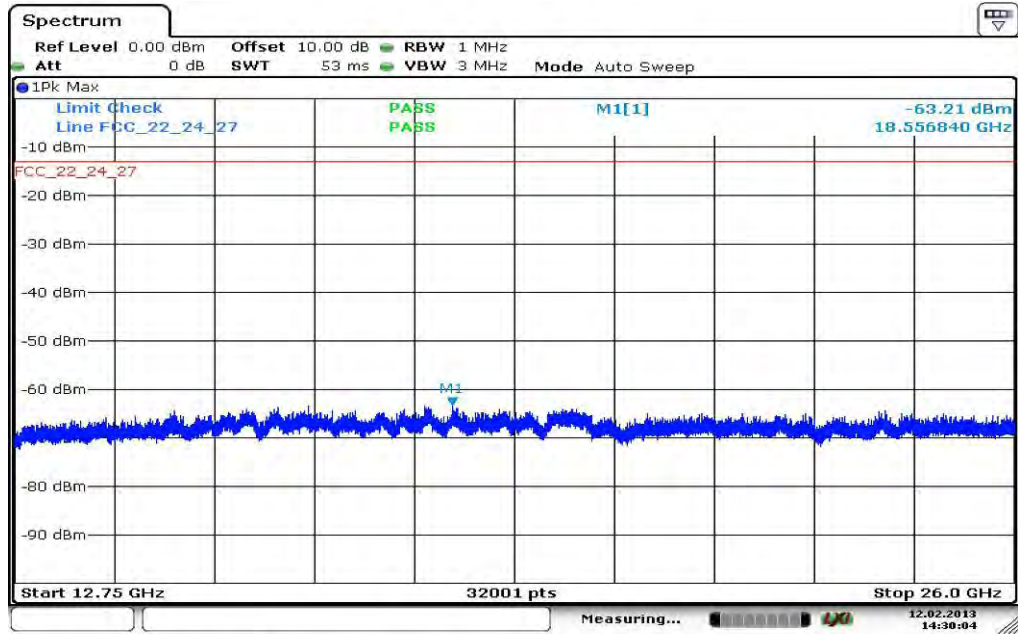

Date: 12.FEB.2013 14:30:04

8.4.5 Spurious emissions conducted

Description:

The following steps outline the procedure used to measure the conducted emissions from the mobile station.

1. Determine frequency range for measurements: From CFR 2.1057 the spectrum should be investigated from the lowest radio frequency generated in the equipment up to at least the 10th harmonic of the carrier frequency. For the mobile station equipment tested, this equates to a frequency range of 13 MHz to 17.6 GHz, data taken from 10 MHz to 25 GHz.
2. Determine mobile station transmits frequencies: below outlines the band edge frequencies pertinent to conducted emissions testing.

For the measurement the lowest, middle and highest channel bandwidth was used. If spurious were found the other bandwidths were measured, too.

Measurement:

| Measurement parameters | |
|------------------------|---|
| Detector: | Peak |
| Sweep time: | Auto |
| Video bandwidth: | Pre-measurement with 1 MHz On spurious detection re-measurement below 1 GHz with 100 kHz Above 1 GHz with 1 MHz |
| Resolution bandwidth: | Pre-measurement with 1 MHz On spurious detection re-measurement below 1 GHz with 100 kHz Above 1 GHz with 1 MHz |
| Span: | 10 MHz – 25 GHz |
| Trace-Mode: | Max Hold |

Limits:

| FCC | IC |
|--|---------|
| CFR Part 27.53(g) CFR Part 2.1053 | RSS 139 |
| Spurious Emissions Conducted | |
| Attenuation $\geq 43 + 10\log(P)$ (P, Power in Watts) | |
| -13 dBm | |

Results: for 1.4 MHz channel bandwidth

QPSK

| SPURIOUS EMISSION LEVEL (dBm) | | | | | | | | |
|-------------------------------|----------------------------|--------------------|----------|----------------------------|--------------------|----------|-----------------------------|--------------------|
| Harmonic | Lowest channel Freq. (MHz) | Level [dBm] | Harmonic | Middle channel Freq. (MHz) | Level [dBm] | Harmonic | Highest channel Freq. (MHz) | Level [dBm] |
| 2 | 3421.4 | No peaks detected. | 2 | 3465.0 | No peaks detected. | 2 | 3508.6 | No peaks detected. |
| 3 | 5132.1 | | 3 | 5197.5 | | 3 | 5262.9 | |
| 4 | 6842.8 | | 4 | 6930.0 | | 4 | 7017.2 | |
| 5 | 8553.5 | | 5 | 8662.5 | | 5 | 8771.5 | |
| 6 | 10264.2 | | 6 | 10395.0 | | 6 | 10525.8 | |
| 7 | 11974.9 | | 7 | 12127.5 | | 7 | 12280.1 | |
| 8 | 13685.6 | | 8 | 13860.0 | | 8 | 14034.4 | |
| 9 | 15396.3 | | 9 | 15592.5 | | 9 | 15788.7 | |
| 10 | 17107.0 | | 10 | 17325.0 | | 10 | 17543.0 | |
| Measurement uncertainty | | | | | | ± 0.5dB | | |

16-QAM

| SPURIOUS EMISSION LEVEL (dBm) | | | | | | | | |
|-------------------------------|----------------------------|--------------------|----------|----------------------------|--------------------|----------|-----------------------------|--------------------|
| Harmonic | Lowest channel Freq. (MHz) | Level [dBm] | Harmonic | Middle channel Freq. (MHz) | Level [dBm] | Harmonic | Highest channel Freq. (MHz) | Level [dBm] |
| 2 | 3421.4 | No peaks detected. | 2 | 3465.0 | No peaks detected. | 2 | 3508.6 | No peaks detected. |
| 3 | 5132.1 | | 3 | 5197.5 | | 3 | 5262.9 | |
| 4 | 6842.8 | | 4 | 6930.0 | | 4 | 7017.2 | |
| 5 | 8553.5 | | 5 | 8662.5 | | 5 | 8771.5 | |
| 6 | 10264.2 | | 6 | 10395.0 | | 6 | 10525.8 | |
| 7 | 11974.9 | | 7 | 12127.5 | | 7 | 12280.1 | |
| 8 | 13685.6 | | 8 | 13860.0 | | 8 | 14034.4 | |
| 9 | 15396.3 | | 9 | 15592.5 | | 9 | 15788.7 | |
| 10 | 17107.0 | | 10 | 17325.0 | | 10 | 17543.0 | |
| Measurement uncertainty | | | | | | ± 0.5dB | | |

Results: for 5 MHz channel bandwidth

QPSK

| SPURIOUS EMISSION LEVEL (dBm) | | | | | | | | |
|-------------------------------|----------------------------|--------------------|----------|----------------------------|--------------------|----------|-----------------------------|--------------------|
| Harmonic | Lowest channel Freq. (MHz) | Level [dBm] | Harmonic | Middle channel Freq. (MHz) | Level [dBm] | Harmonic | Highest channel Freq. (MHz) | Level [dBm] |
| 2 | 3425.0 | No peaks detected. | 2 | 3465.0 | No peaks detected. | 2 | 3505.0 | No peaks detected. |
| 3 | 5137.5 | | 3 | 5197.5 | | 3 | 5257.5 | |
| 4 | 6850.0 | | 4 | 6930.0 | | 4 | 7010.0 | |
| 5 | 8562.5 | | 5 | 8662.5 | | 5 | 8762.5 | |
| 6 | 10275.0 | | 6 | 10395.0 | | 6 | 10515.0 | |
| 7 | 11987.5 | | 7 | 12127.5 | | 7 | 12267.5 | |
| 8 | 13700.0 | | 8 | 13860.0 | | 8 | 14020.0 | |
| 9 | 15412.5 | | 9 | 15592.5 | | 9 | 15772.5 | |
| 10 | 17125.0 | | 10 | 17325.0 | | 10 | 17525.0 | |
| Measurement uncertainty | | | | | | ± 0.5dB | | |

16-QAM

| SPURIOUS EMISSION LEVEL (dBm) | | | | | | | | |
|-------------------------------|----------------------------|--------------------|----------|----------------------------|--------------------|----------|-----------------------------|--------------------|
| Harmonic | Lowest channel Freq. (MHz) | Level [dBm] | Harmonic | Middle channel Freq. (MHz) | Level [dBm] | Harmonic | Highest channel Freq. (MHz) | Level [dBm] |
| 2 | 3425.0 | No peaks detected. | 2 | 3465.0 | No peaks detected. | 2 | 3505.0 | No peaks detected. |
| 3 | 5137.5 | | 3 | 5197.5 | | 3 | 5257.5 | |
| 4 | 6850.0 | | 4 | 6930.0 | | 4 | 7010.0 | |
| 5 | 8562.5 | | 5 | 8662.5 | | 5 | 8762.5 | |
| 6 | 10275.0 | | 6 | 10395.0 | | 6 | 10515.0 | |
| 7 | 11987.5 | | 7 | 12127.5 | | 7 | 12267.5 | |
| 8 | 13700.0 | | 8 | 13860.0 | | 8 | 14020.0 | |
| 9 | 15412.5 | | 9 | 15592.5 | | 9 | 15772.5 | |
| 10 | 17125.0 | | 10 | 17325.0 | | 10 | 17525.0 | |
| Measurement uncertainty | | | | | | ± 0.5dB | | |

Results: for 20 MHz channel bandwidth

QPSK

| SPURIOUS EMISSION LEVEL (dBm) | | | | | | | | |
|-------------------------------|----------------------------|--------------------|----------|----------------------------|--------------------|----------|-----------------------------|--------------------|
| Harmonic | Lowest channel Freq. (MHz) | Level [dBm] | Harmonic | Middle channel Freq. (MHz) | Level [dBm] | Harmonic | Highest channel Freq. (MHz) | Level [dBm] |
| 2 | 3440.0 | No peaks detected. | 2 | 3465.0 | No peaks detected. | 2 | 3490.0 | No peaks detected. |
| 3 | 5160.0 | | 3 | 5197.5 | | 3 | 5235.0 | |
| 4 | 6880.0 | | 4 | 6930.0 | | 4 | 6980.0 | |
| 5 | 8600.0 | | 5 | 8662.5 | | 5 | 8725.0 | |
| 6 | 10320.0 | | 6 | 10395.0 | | 6 | 10470.0 | |
| 7 | 12040.0 | | 7 | 12127.5 | | 7 | 12215.0 | |
| 8 | 13760.0 | | 8 | 13860.0 | | 8 | 13960.0 | |
| 9 | 15480.0 | | 9 | 15592.5 | | 9 | 15705.0 | |
| 10 | 17200.0 | | 10 | 17325.0 | | 10 | 17450.0 | |
| Measurement uncertainty | | | | | | ± 0.5dB | | |

16-QAM

| SPURIOUS EMISSION LEVEL (dBm) | | | | | | | | |
|-------------------------------|----------------------------|--------------------|----------|----------------------------|--------------------|----------|-----------------------------|--------------------|
| Harmonic | Lowest channel Freq. (MHz) | Level [dBm] | Harmonic | Middle channel Freq. (MHz) | Level [dBm] | Harmonic | Highest channel Freq. (MHz) | Level [dBm] |
| 2 | 3440.0 | No peaks detected. | 2 | 3465.0 | No peaks detected. | 2 | 3490.0 | No peaks detected. |
| 3 | 5160.0 | | 3 | 5197.5 | | 3 | 5235.0 | |
| 4 | 6880.0 | | 4 | 6930.0 | | 4 | 6980.0 | |
| 5 | 8600.0 | | 5 | 8662.5 | | 5 | 8725.0 | |
| 6 | 10320.0 | | 6 | 10395.0 | | 6 | 10470.0 | |
| 7 | 12040.0 | | 7 | 12127.5 | | 7 | 12215.0 | |
| 8 | 13760.0 | | 8 | 13860.0 | | 8 | 13960.0 | |
| 9 | 15480.0 | | 9 | 15592.5 | | 9 | 15705.0 | |
| 10 | 17200.0 | | 10 | 17325.0 | | 10 | 17450.0 | |
| Measurement uncertainty | | | | | | ± 0.5dB | | |

Result: Passed

Results: for 1.4 MHz channel bandwidth, QPSK

Plot 1: Lowest Channel (10 MHz - 25 GHz)

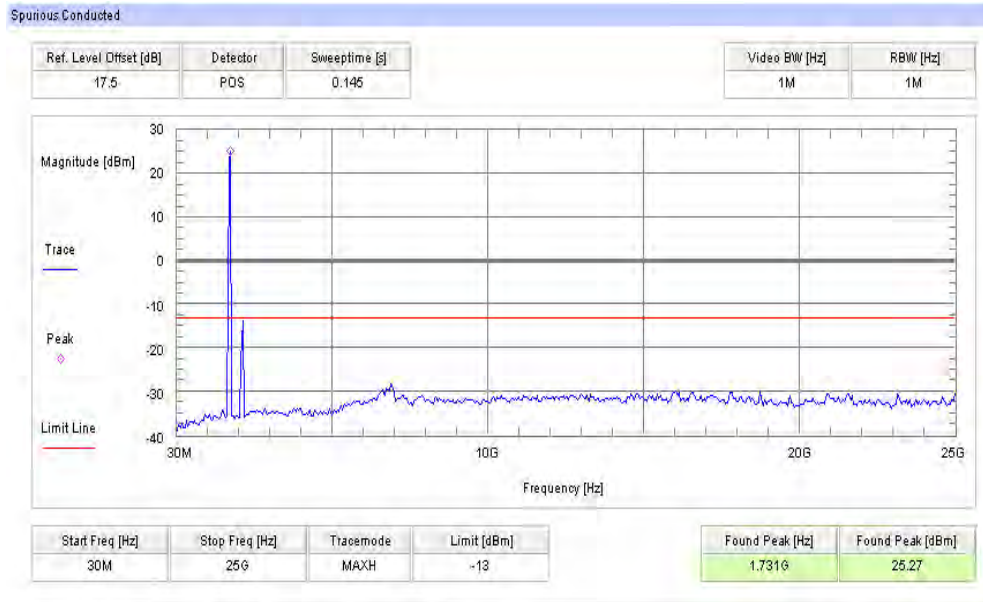

The peak on 2.1 GHz is generated by the signaling unit, NOT from EUT.

Plot 2: Middle Channel (10 MHz - 25 GHz)

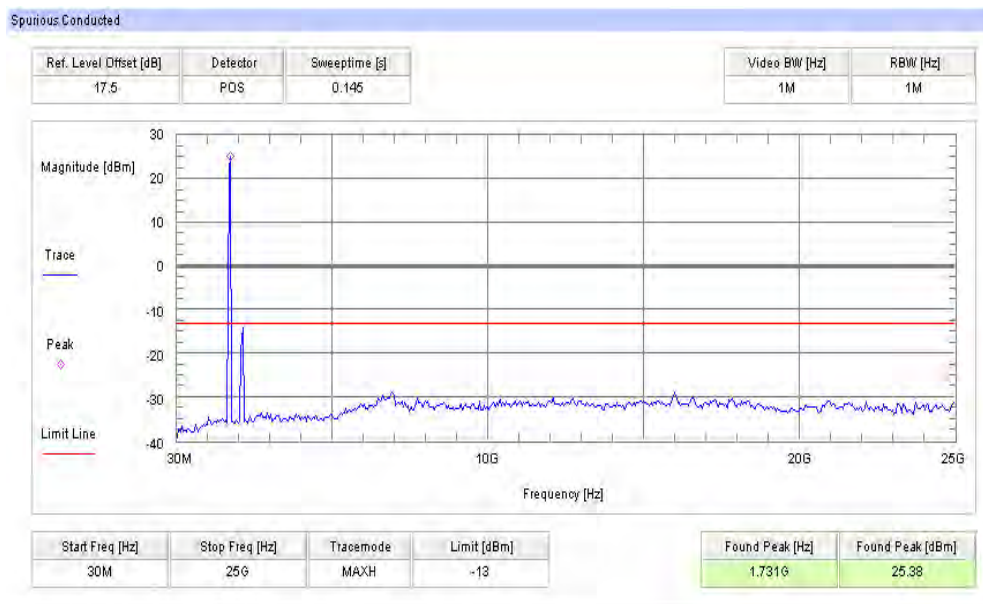

The peak on 2.1 GHz is generated by the signaling unit, NOT from EUT.

Plot 3: Highest Channel (10 MHz - 25 GHz)

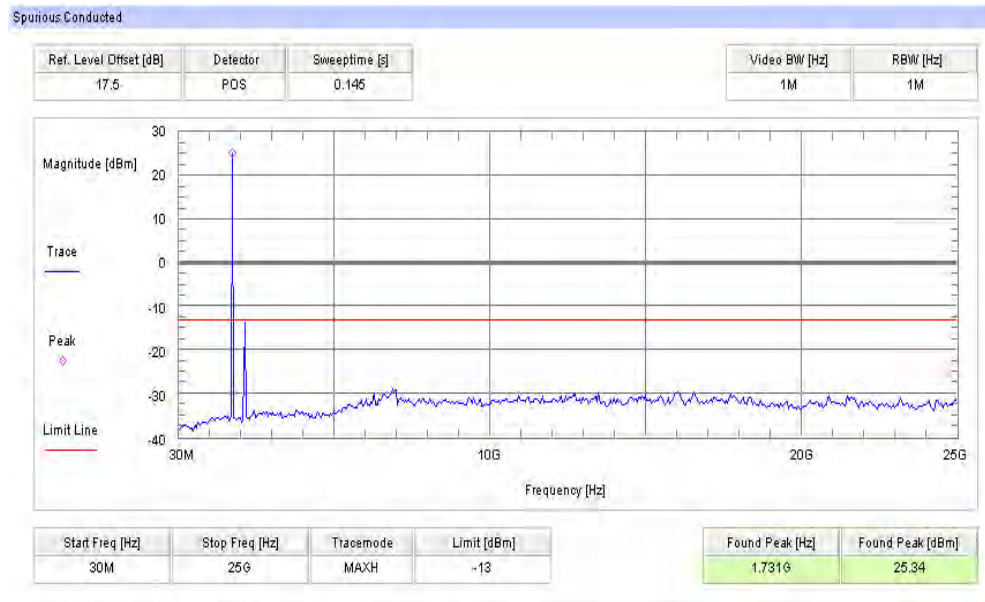

The peak on 2.1 GHz is generated by the signaling unit, NOT from EUT.

Results: for 1.4 MHz channel bandwidth, 16-QAM

Plot 4: Lowest Channel (10 MHz - 25 GHz)

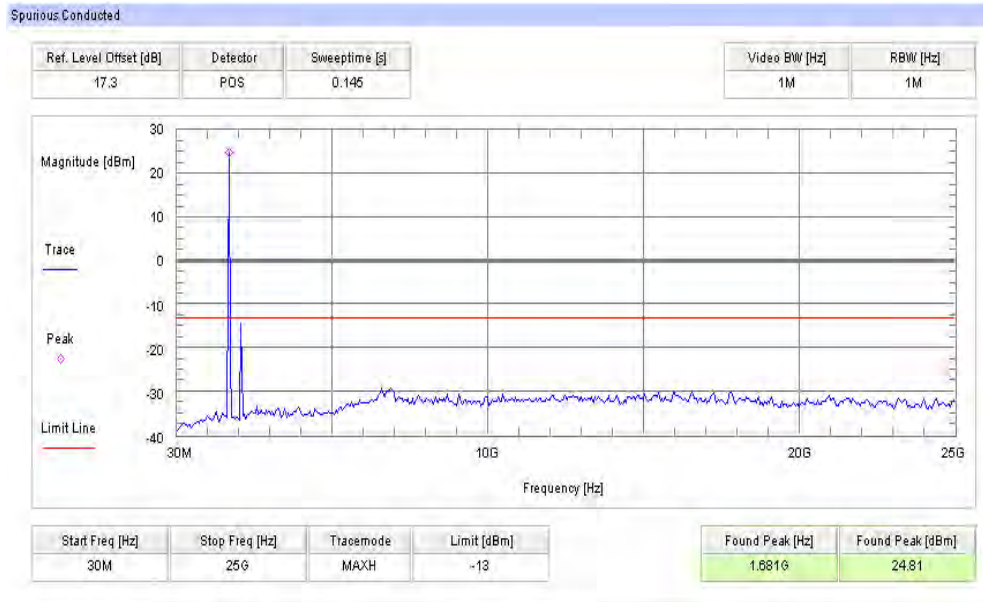

The peak on 2.1 GHz is generated by the signaling unit, NOT from EUT.

Plot 5: Middle Channel (10 MHz - 25 GHz)

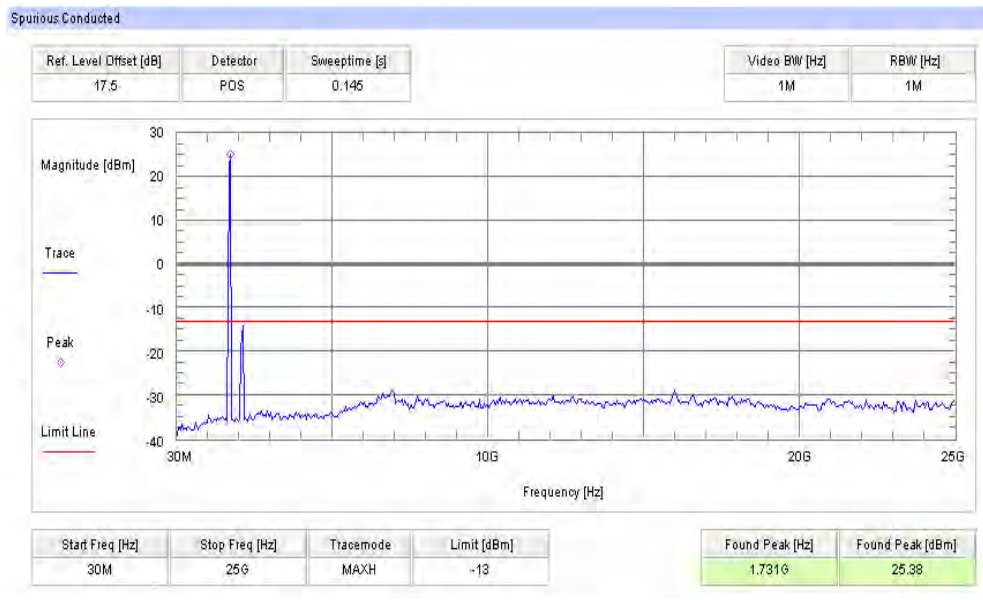

The peak on 2.1 GHz is generated by the signaling unit, NOT from EUT.

Plot 6: Highest Channel (10 MHz - 25 GHz)

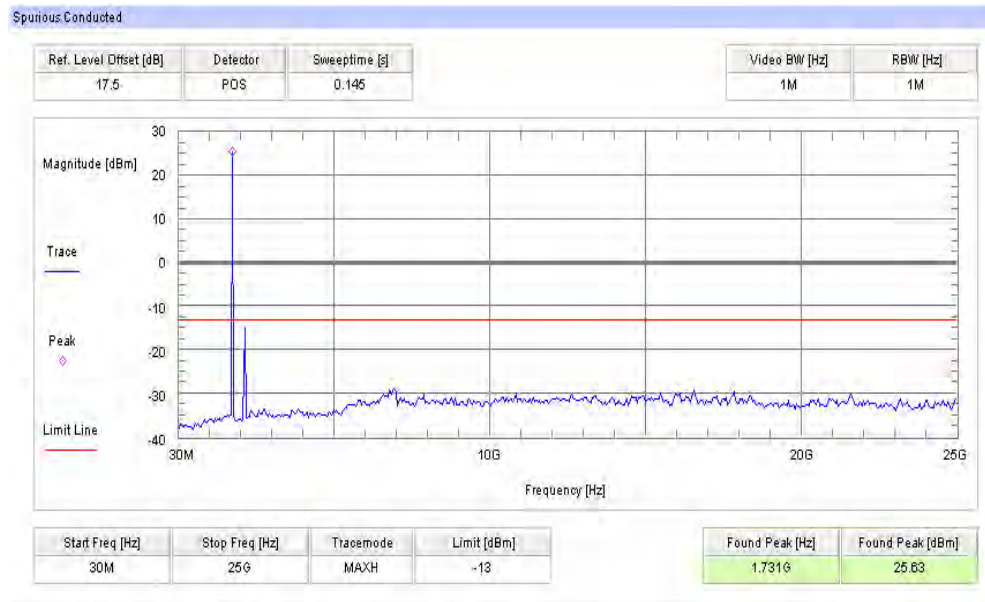

The peak on 2.1 GHz is generated by the signaling unit, NOT from EUT.

Results: for 5 MHz channel bandwidth, QPSK

Plot 1: Lowest Channel (10 MHz - 25 GHz)

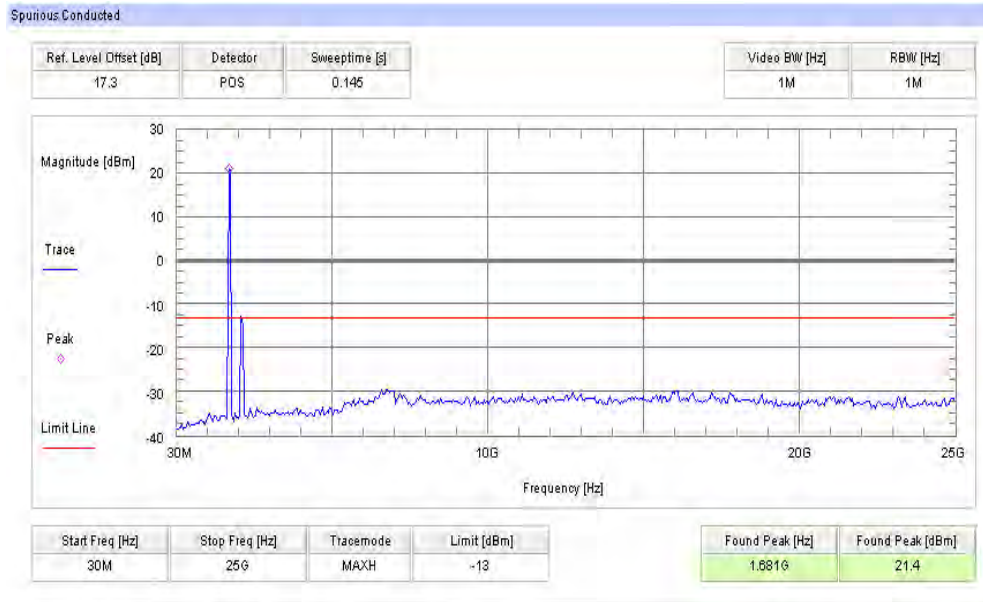

The peak on 2.1 GHz is generated by the signaling unit, NOT from EUT.

Plot 2: Middle Channel (10 MHz - 25 GHz)

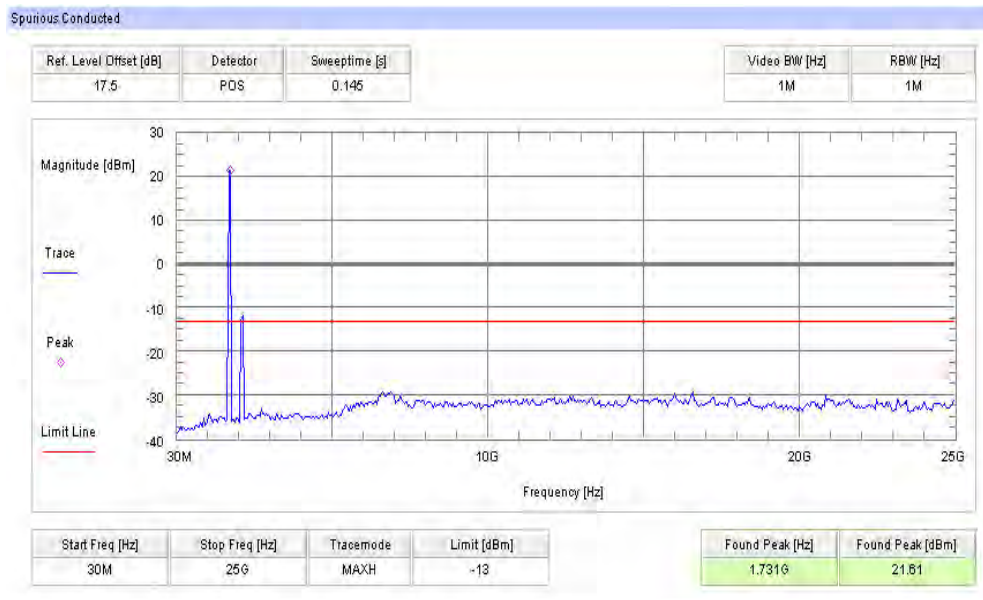

The peak on 2.1 GHz is generated by the signaling unit, NOT from EUT.

Plot 3: Highest Channel (10 MHz - 25 GHz)

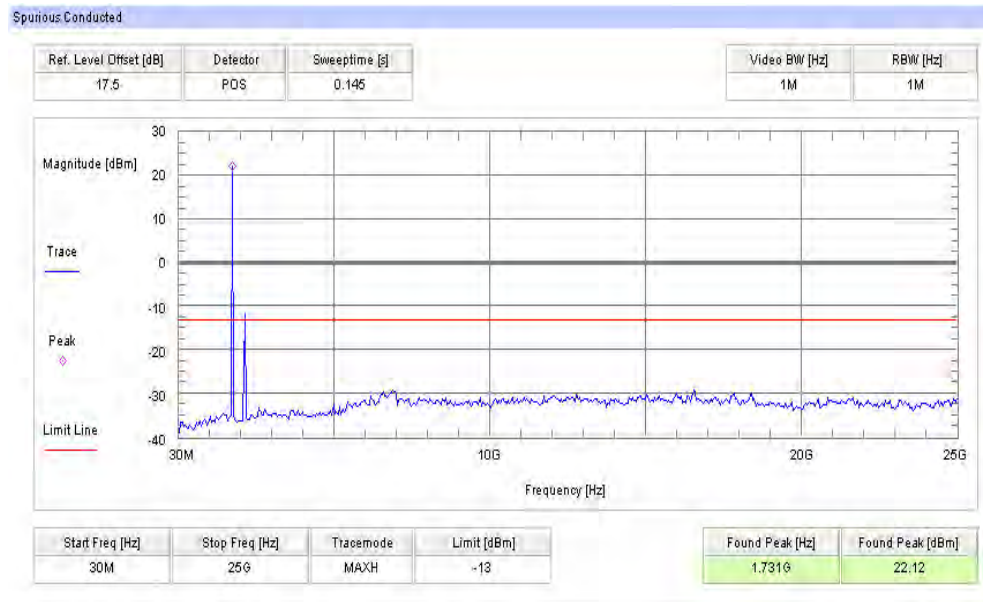

The peak on 2.1 GHz is generated by the signaling unit, NOT from EUT.

Results: for 5 MHz channel bandwidth, 16-QAM

Plot 4: Lowest Channel (10 MHz - 25 GHz)

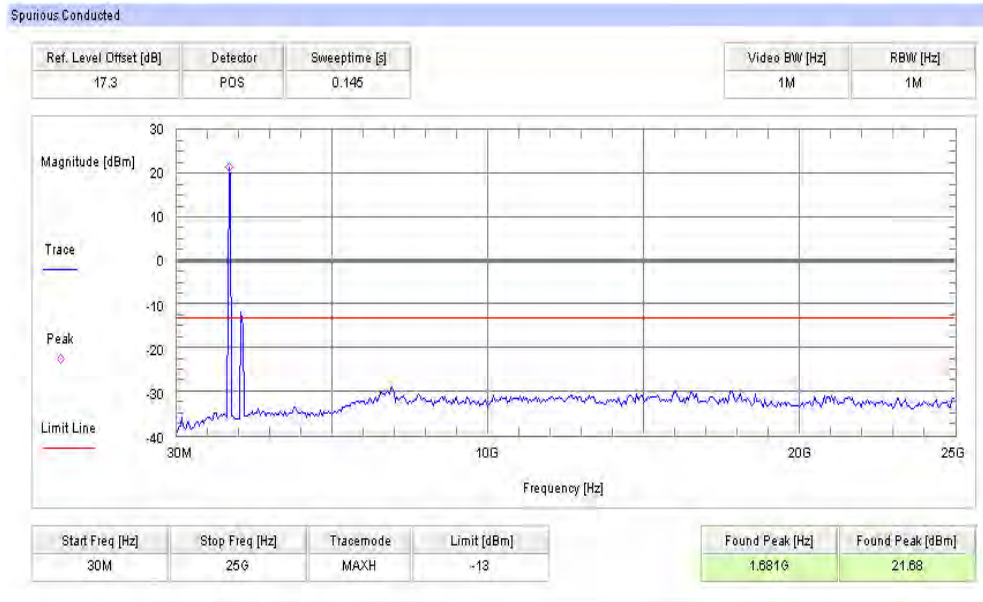

The peak on 2.1 GHz is generated by the signaling unit, NOT from EUT.

Plot 5: Middle Channel (10 MHz - 25 GHz)

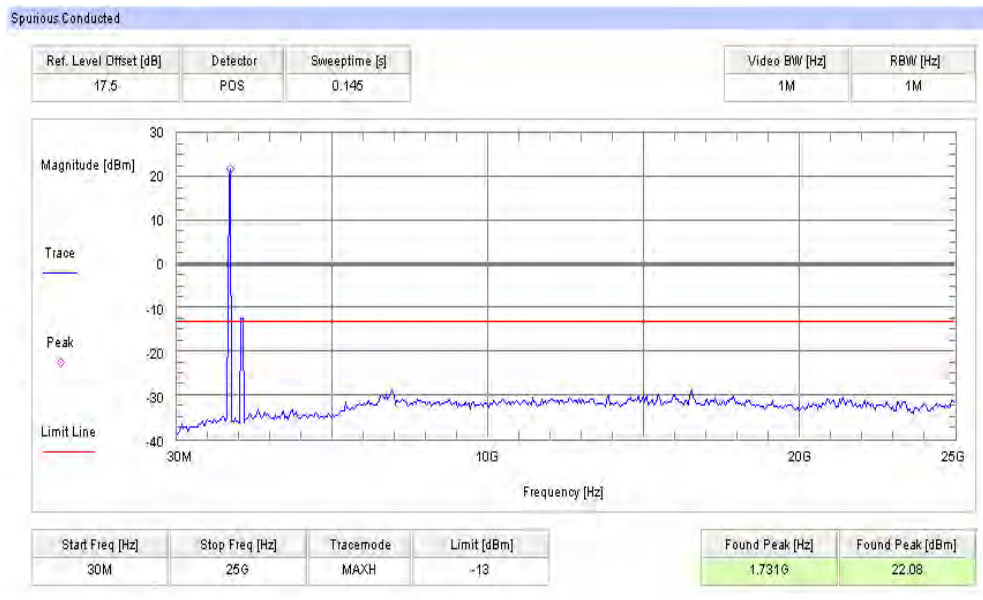

The peak on 2.1 GHz is generated by the signaling unit, NOT from EUT.

Plot 6: Highest Channel (10 MHz - 25 GHz)

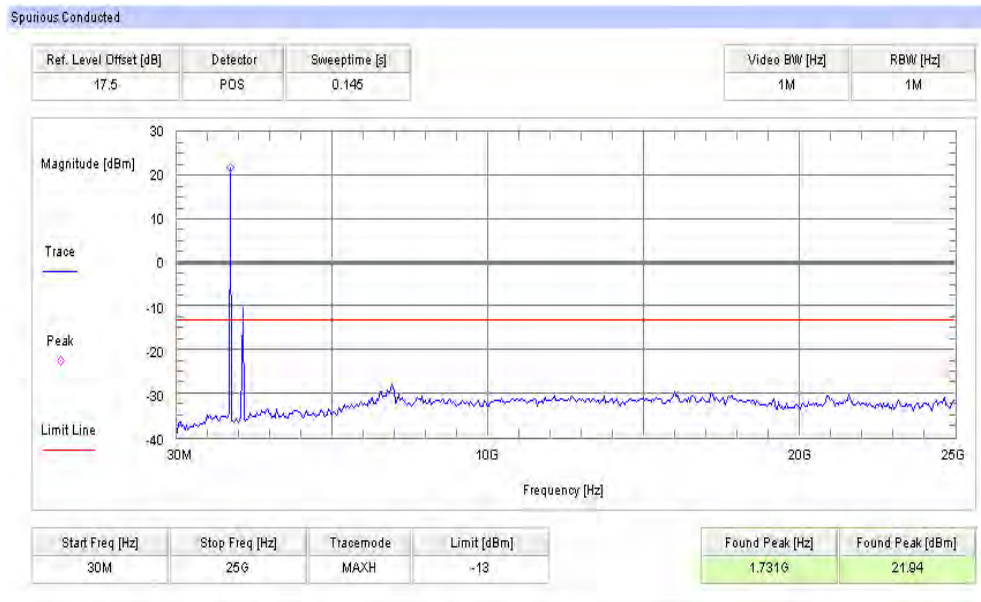

The peak on 2.1 GHz is generated by the signaling unit, NOT from EUT.

Results: for 20 MHz channel bandwidth, QPSK

Plot 1: Lowest Channel (10 MHz - 25 GHz)

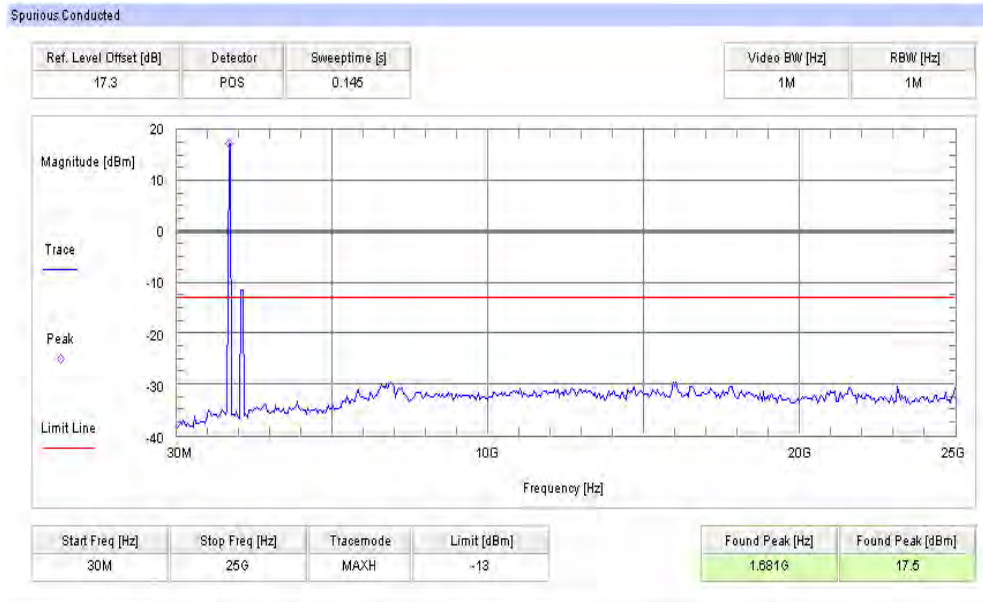

The peak on 2.1 GHz is generated by the signaling unit, NOT from EUT.

Plot 2: Middle Channel (10 MHz - 25 GHz)

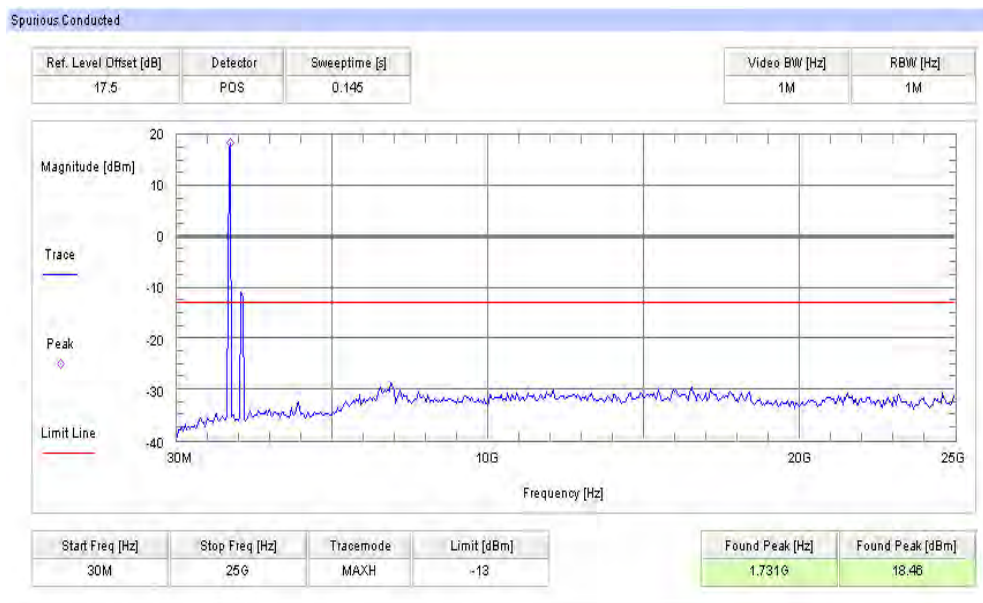

The peak on 2.1 GHz is generated by the signaling unit, NOT from EUT.

Plot 3: Highest Channel (10 MHz - 25 GHz)

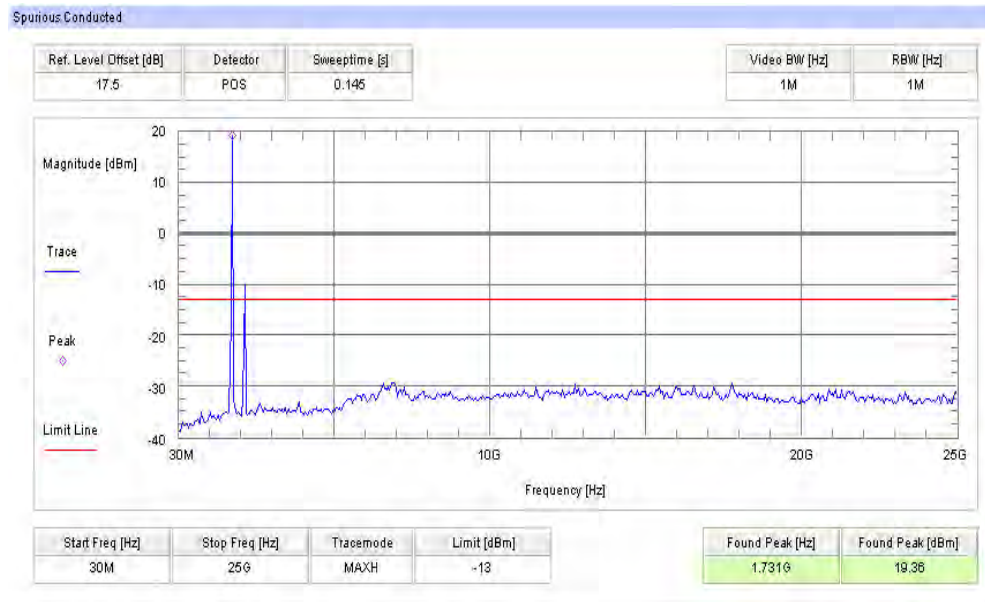

The peak on 2.1 GHz is generated by the signaling unit, NOT from EUT.

Results: for 20 MHz channel bandwidth, 16-QAM

Plot 4: Lowest Channel (10 MHz - 25 GHz)

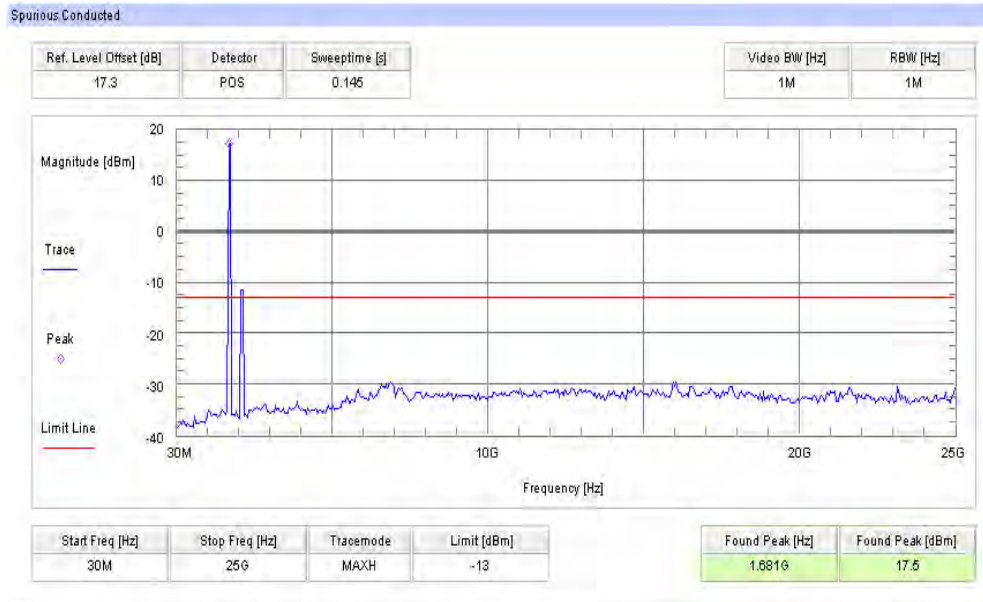

The peak on 2.1 GHz is generated by the signaling unit, NOT from EUT.

Plot 5: Middle Channel (10 MHz - 25 GHz)

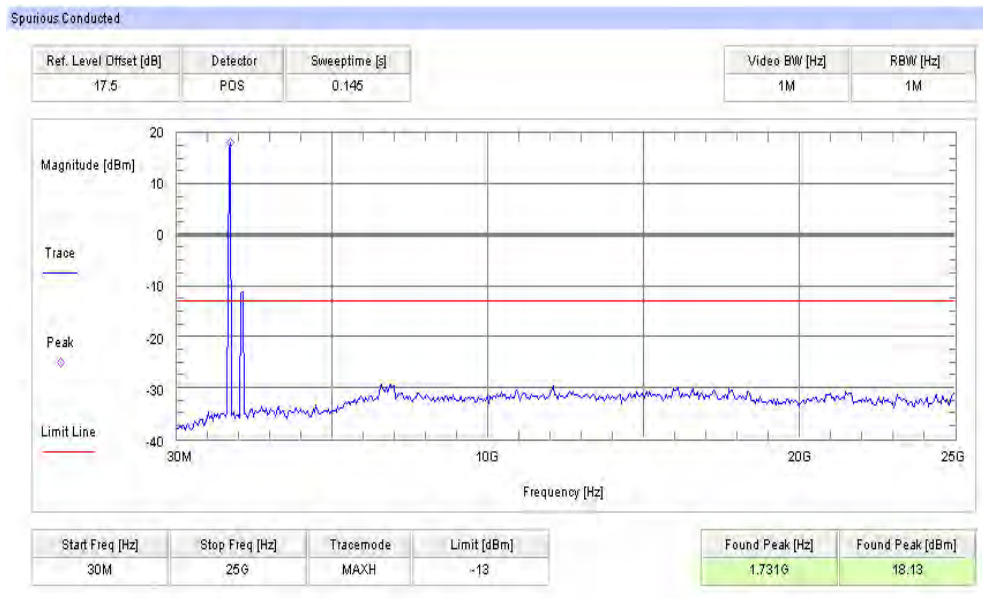

The peak on 2.1 GHz is generated by the signaling unit, NOT from EUT.

Plot 6: Highest Channel (10 MHz - 25 GHz)

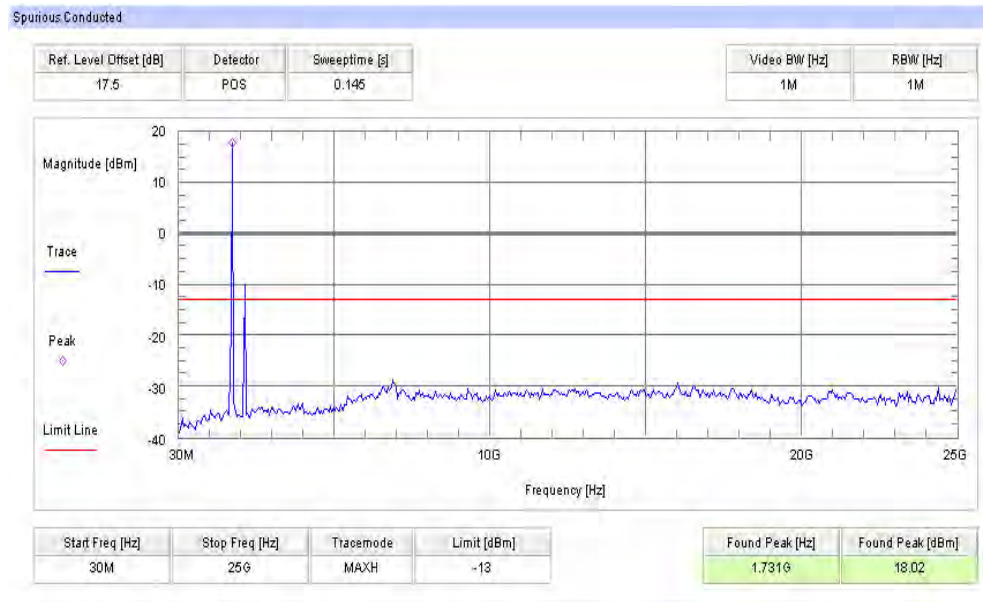

The peak on 2.1 GHz is generated by the signaling unit, NOT from EUT.

8.4.6 Block edge compliance

Description:

The spectrum at the band edges must comply with the spurious emissions limits.

For the measurement the lowest, middle and highest channel bandwidth was used. If spurious were found the other bandwidths were measured, too.

Measurement:

| Measurement parameters | |
|------------------------|----------|
| Detector: | RMS |
| Sweep time: | 20 sec. |
| Video bandwidth: | 30 kHz |
| Resolution bandwidth: | 30 kHz |
| Span: | 1 MHz |
| Trace-Mode: | Max Hold |

Limits:

| FCC | IC |
|--|---------|
| CFR Part 27.53(h) CFR Part 2.1053 | RSS 139 |
| Block Edge Compliance | |
| <p>Part 27.53 specifies that “the power of any emission outside of the authorized operating frequency ranges must be attenuated below the transmitting power (P) by a factor of at least 43 + 10 log(P) dB.”</p> <p>However, in publication number 890810, The FCC Office of Engineering and Technology specified the following correction to the limits when a resolution bandwidth smaller than 1% of the emission bandwidth is used:</p> <p>“An alternative is to add an additional correction factor of 10 Log (RBW1/ RBW2) to the 43 +10 log(P) limit. RBW1 is the narrower measurement resolution bandwidth and RBW2 is either the 1% emissions bandwidth or 1 MHz.”</p> <p>When using a 30 kHz bandwidth, this yields a -8.24 adjustment to the limit [10 log(30kHz/200kHz) = -8.24]. When this adjustment is applied to the limit, the limit becomes -21.24 dBm.</p> | |
| worst case: -21.24 dBm | |

Results: 1.4 MHz channel bandwidth

Plot 1: Lowest channel – QPSK

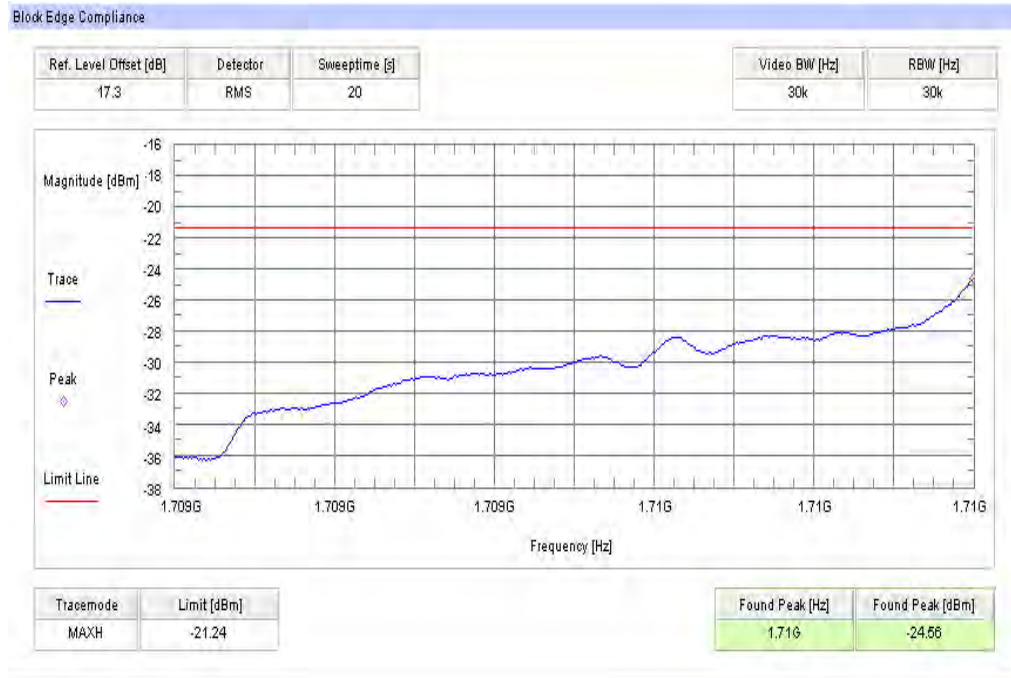

Plot 2: Highest channel – QPSK

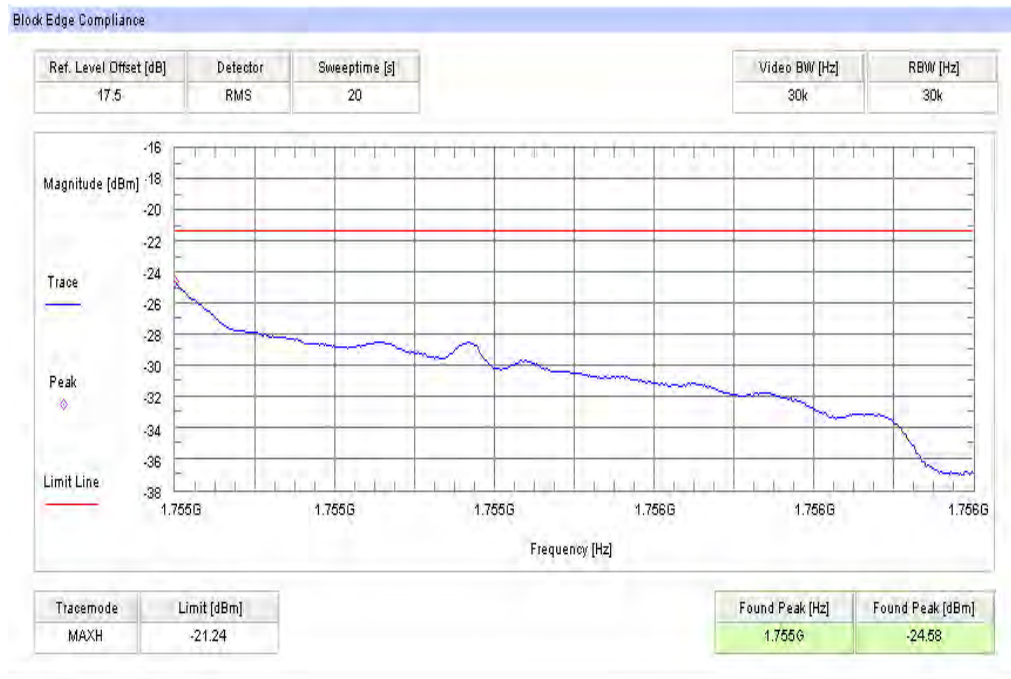

Plot 3: Lowest channel – 16-QAM

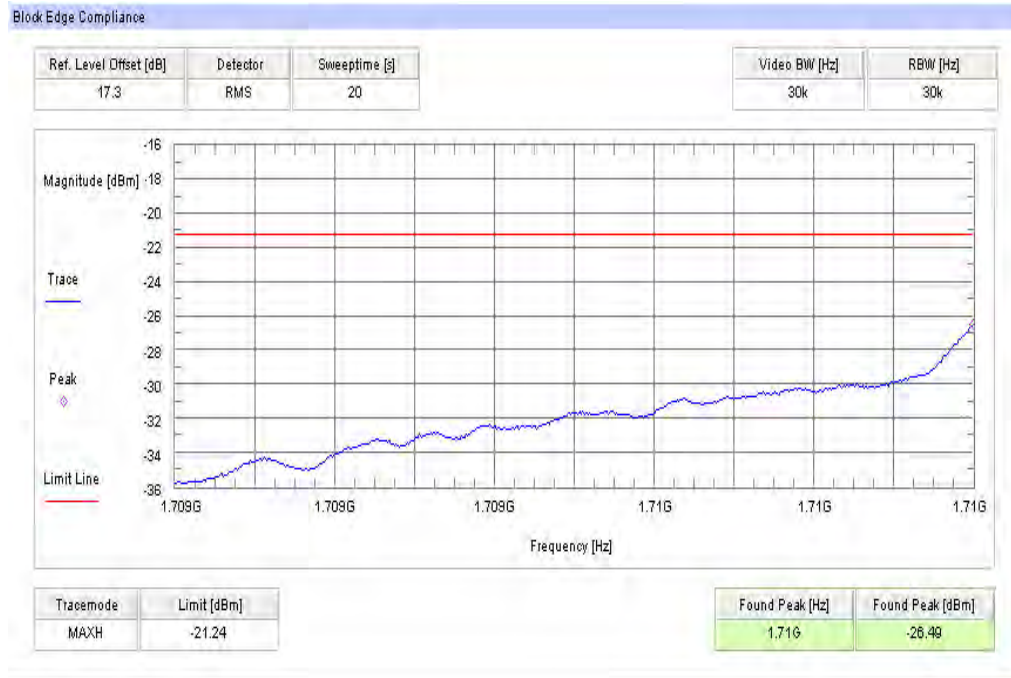

Plot 4: Highest channel – 16-QAM

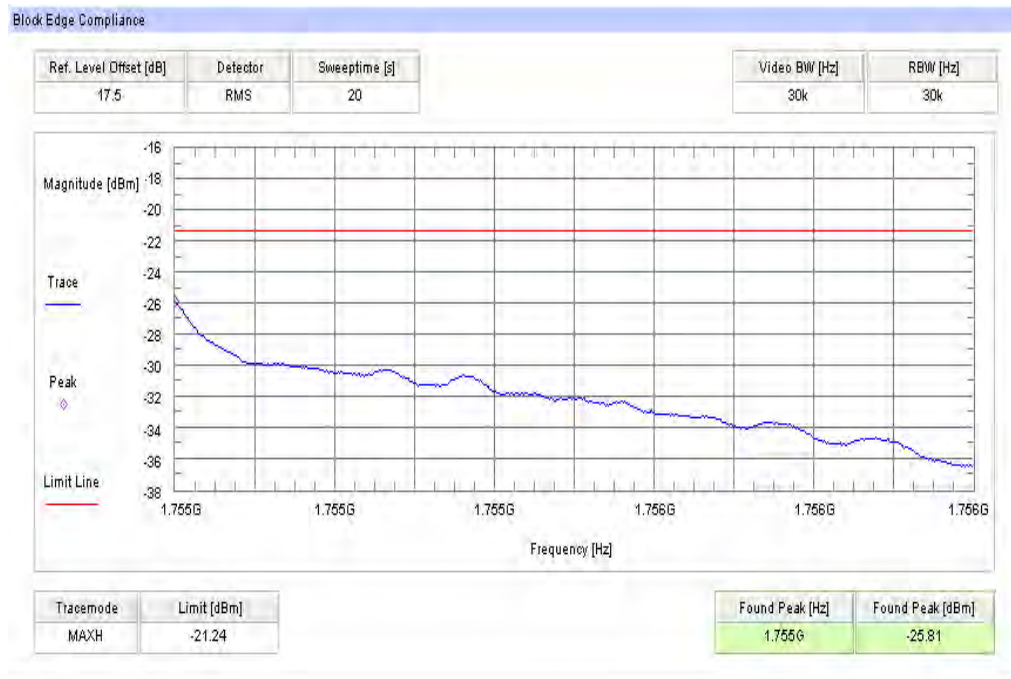

Results: 5 MHz channel bandwidth

Plot 1: Lowest channel – QPSK

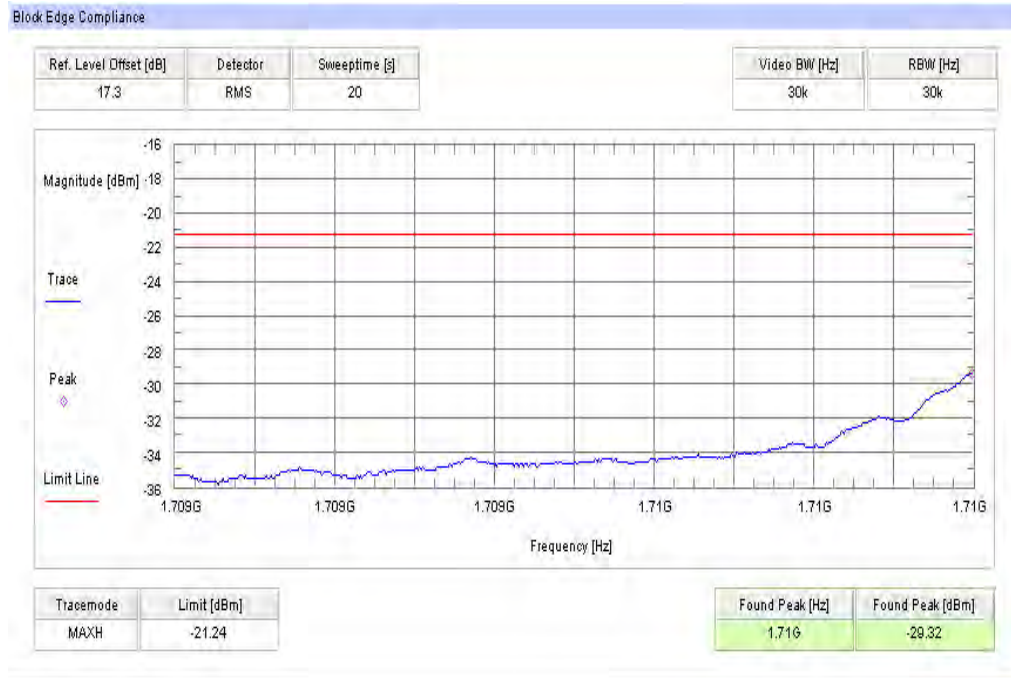

Plot 2: Highest channel – QPSK

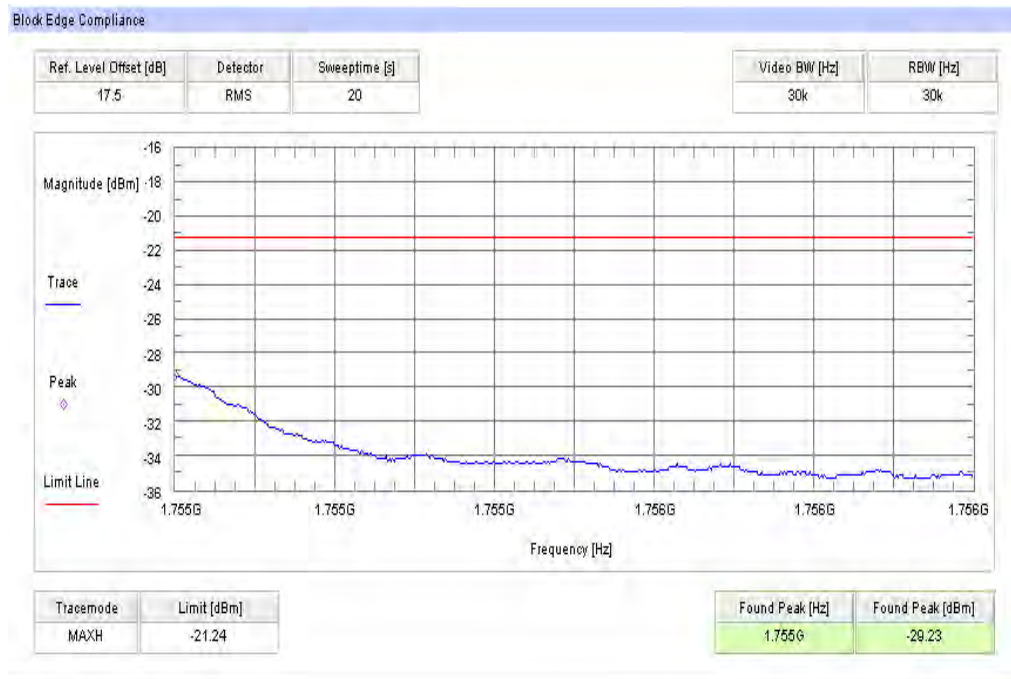

Plot 3: Lowest channel – 16-QAM

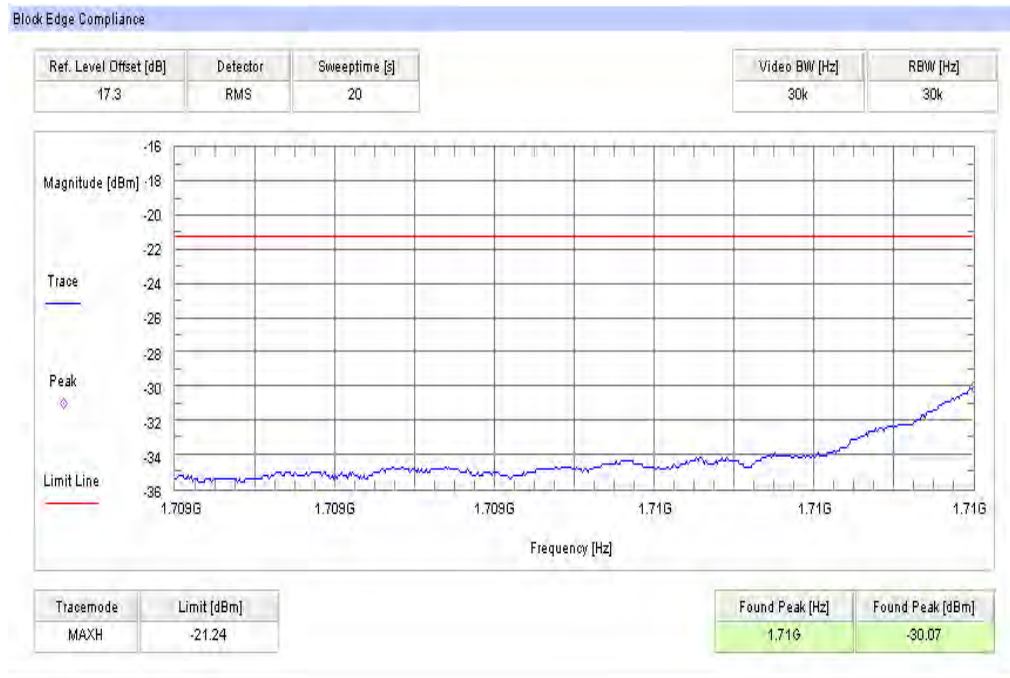

Plot 4: Highest channel – 16-QAM

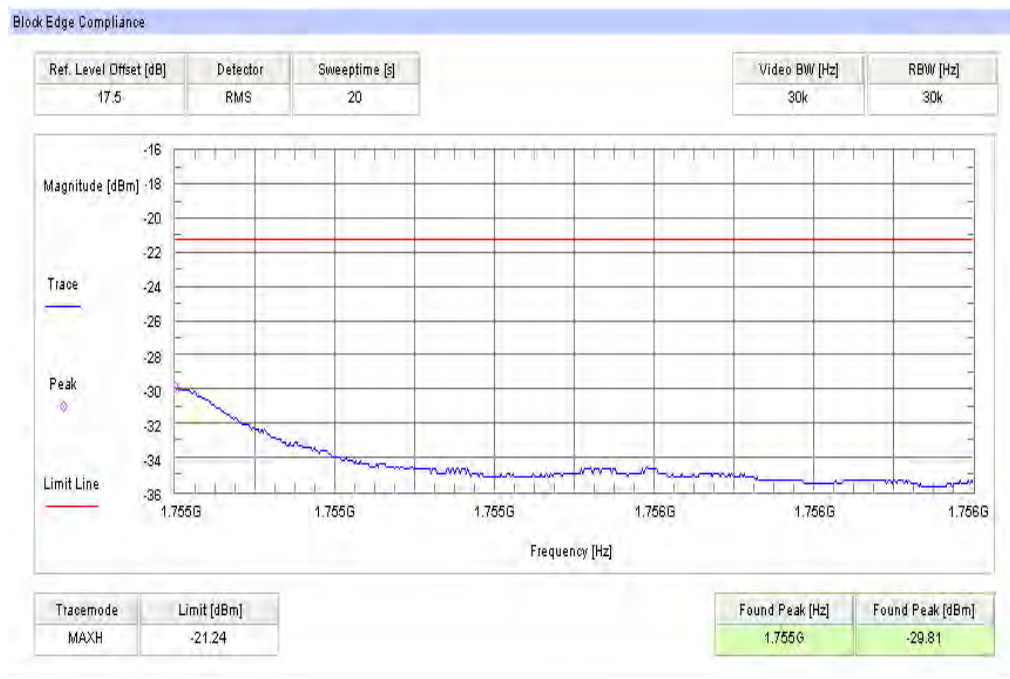

Results: 10 MHz channel bandwidth

Plot 1: Lowest channel – QPSK

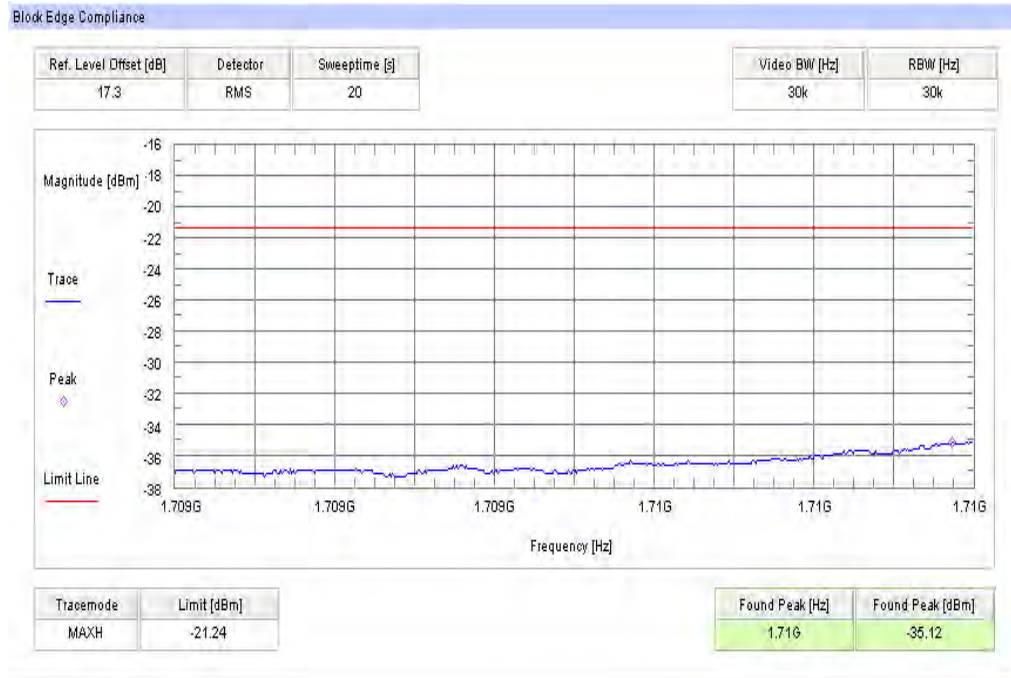

Plot 2: Highest channel – QPSK

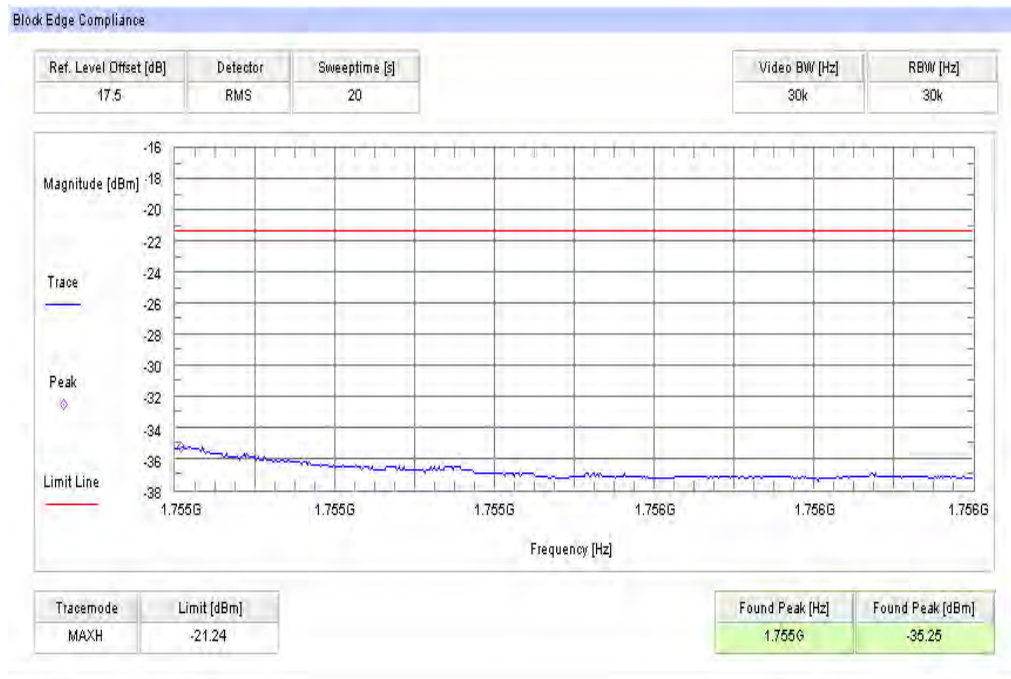

Plot 3: Lowest channel – 16-QAM

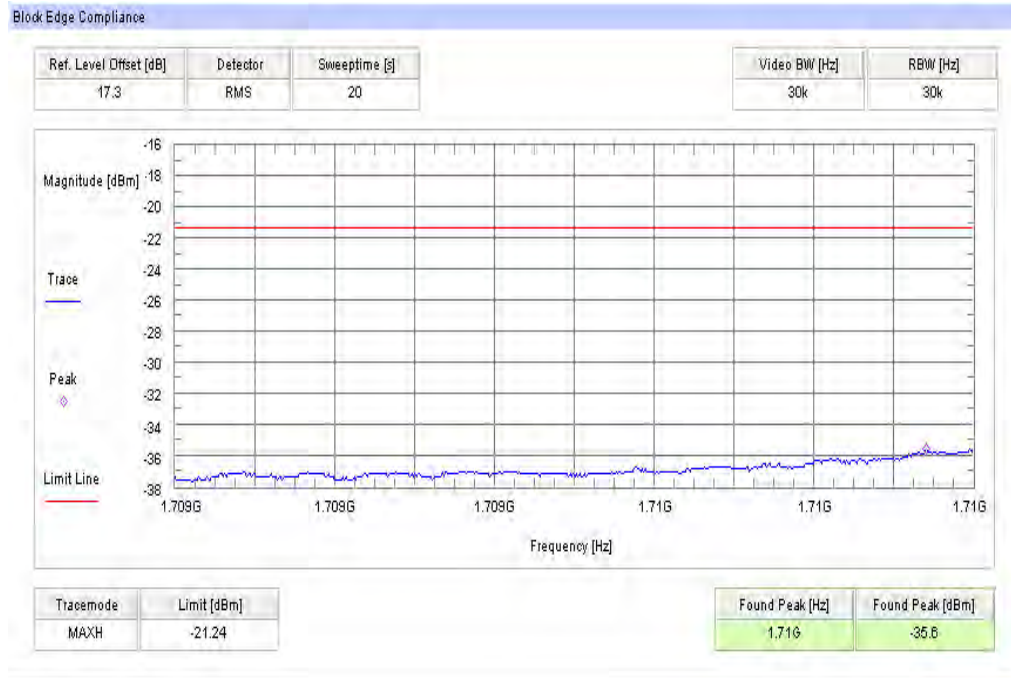

Plot 4: Highest channel – 16-QAM

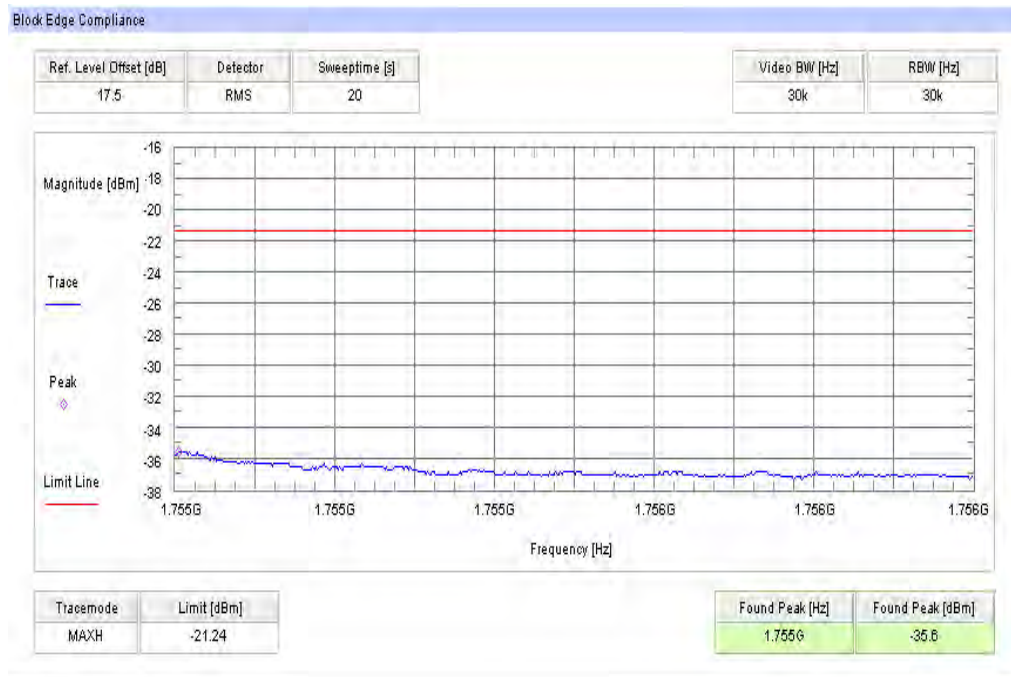

Results: 20 MHz channel bandwidth

Plot 1: Lowest channel – QPSK

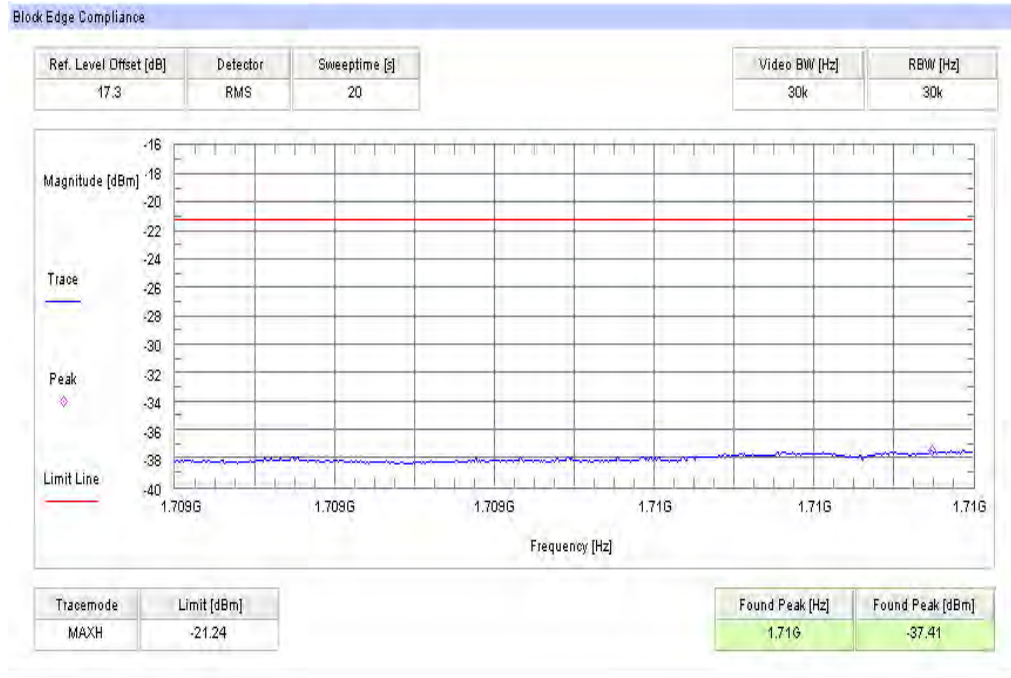

Plot 2: Highest channel – QPSK

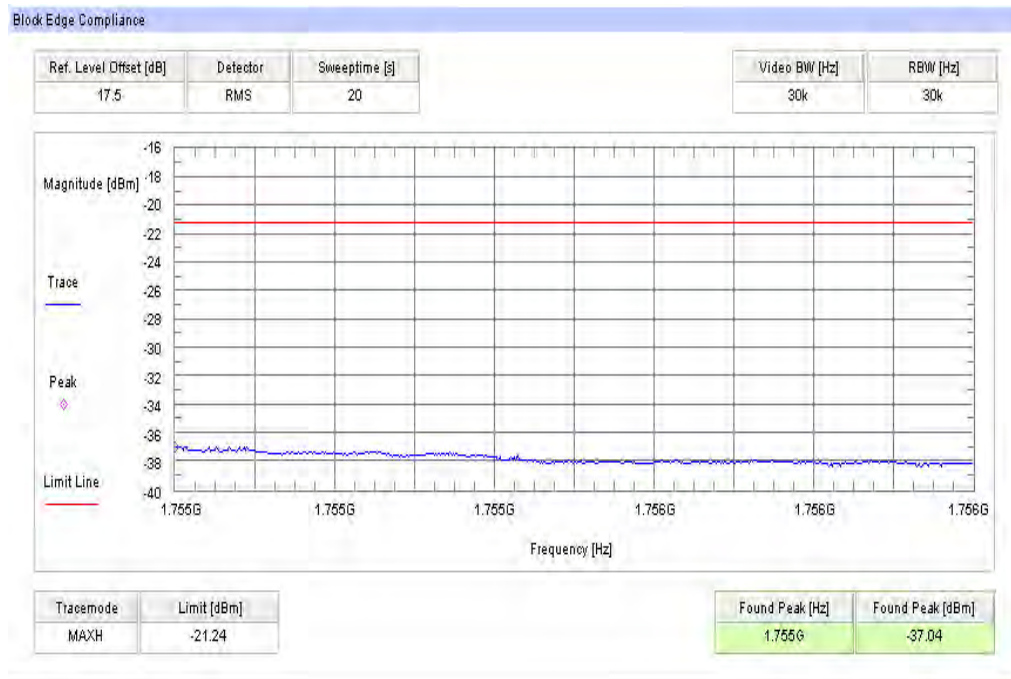

Plot 3: Lowest channel – 16-QAM

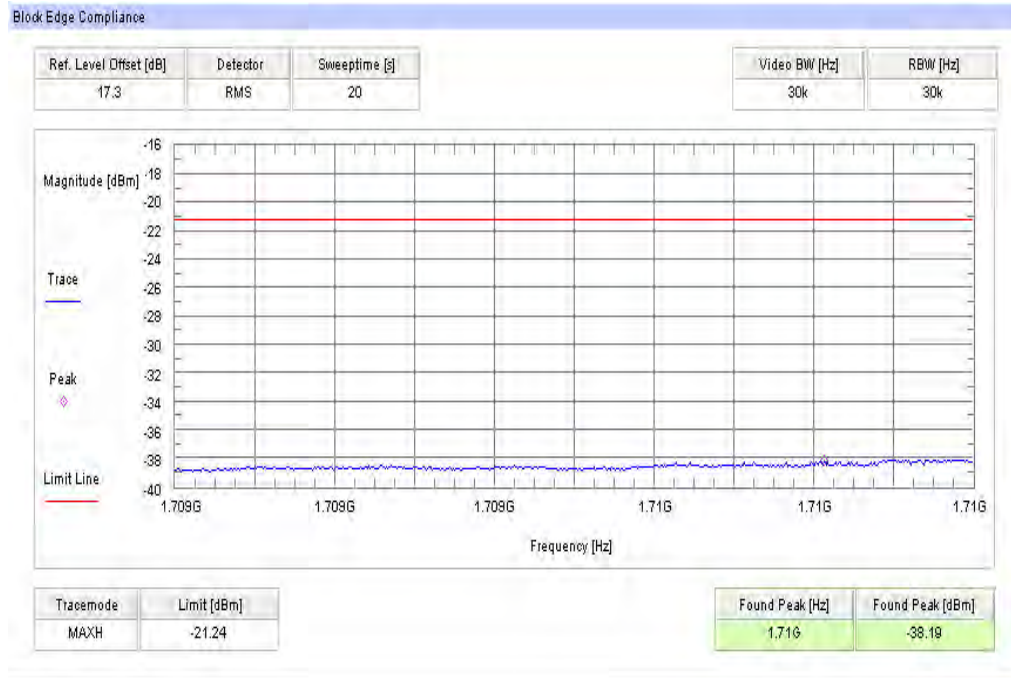

Plot 4: Highest channel – 16-QAM

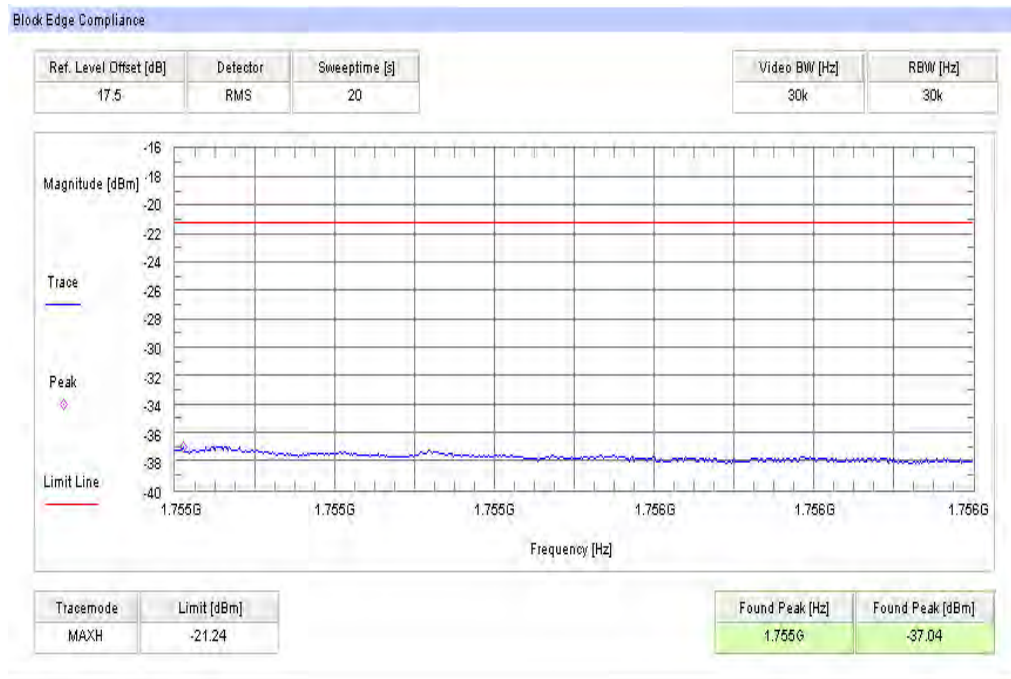

Result: Passed

8.4.7 Occupied bandwidth

Description:

Measurement of the occupied bandwidth of the transmitted signal.

Measurement:

Similar to conducted emissions, occupied bandwidth measurements are only provided for selected frequencies in order to reduce the amount of submitted data. Data were taken at the mid frequencies of the LTE band 4 frequency band. The table below lists the measured 99% power and -26dBc occupied bandwidths. Spectrum analyzer plots are included on the following pages.

Part 27.53 requires a measurement bandwidth of at least 1% of the occupied bandwidth.

| Measurement parameters | |
|------------------------|------------------------------|
| Detector: | Peak |
| Sweep time: | Auto |
| Video bandwidth: | Depends on Channel Bandwidth |
| Resolution bandwidth: | Depends on Channel Bandwidth |
| Span: | Depends on Channel Bandwidth |
| Trace-Mode: | Max Hold |

Limits:

| FCC | IC |
|---|---------|
| CFR Part 27.53(h) CFR Part 2.1049 | RSS 139 |
| Occupied Bandwidth | |
| Spectrum must fall completely in the specified band | |

Results:

| Occupied Bandwidth - QPSK | |
|---------------------------|--------------------------|
| Bandwidth [MHz] | 99% OBW (kHz) |
| 1.4 | 1090 |
| 3 | 2729 |
| 5 | 4495 |
| 10 | 9016 |
| 15 | 13436 |
| 20 | 17953 |
| Measurement uncertainty | max ± 300 kHz, see plots |

| Occupied Bandwidth – 16-QAM | |
|-----------------------------|--------------------------|
| Bandwidth [MHz] | 99% OBW (kHz) |
| 1.4 | 1093 |
| 3 | 2730 |
| 5 | 4498 |
| 10 | 9022 |
| 15 | 13435 |
| 20 | 17961 |
| Measurement uncertainty | max ± 300 kHz, see plots |

Result: **Passed**

Plots: QPSK

Plot 1: 1.4 MHz (99% - OBW)

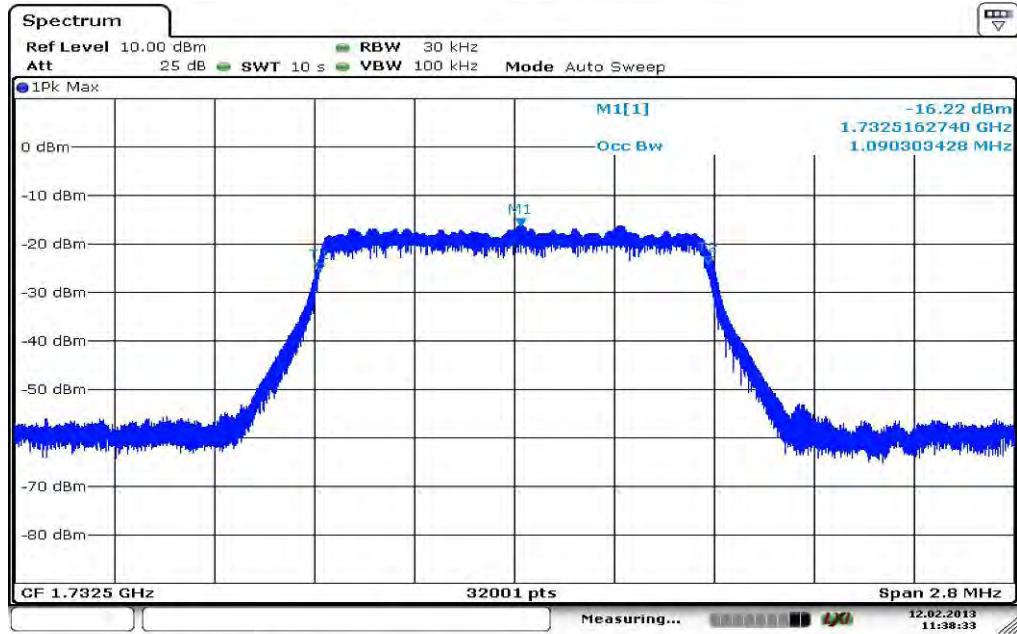

Date: 12.FEB.2013 11:38:33

Plot 2: 3 MHz (99% - OBW)

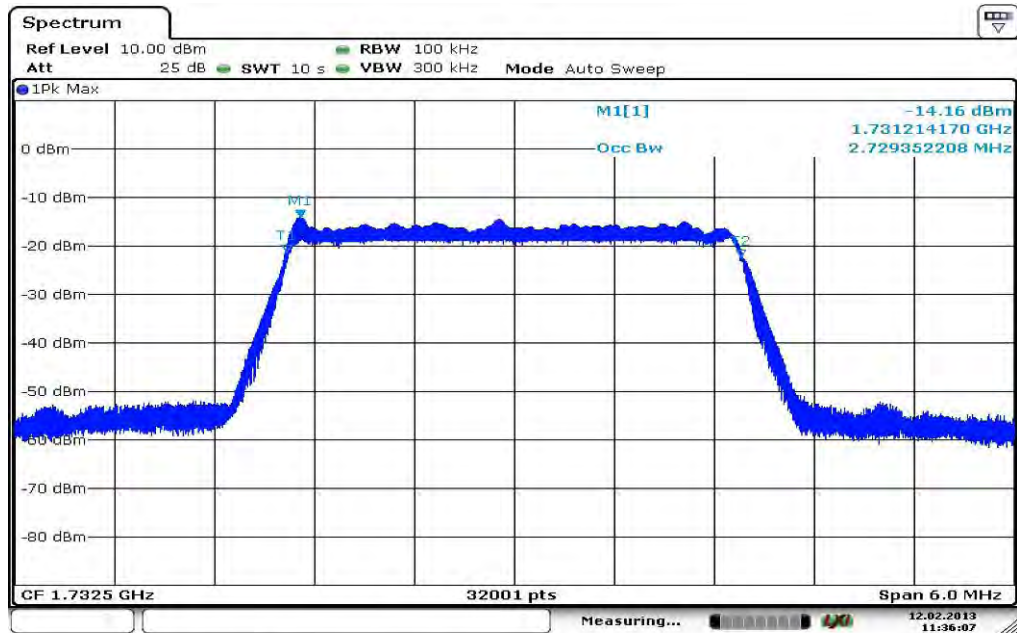

Date: 12.FEB.2013 11:36:07

Plot 3: 5 MHz (99% - OBW)

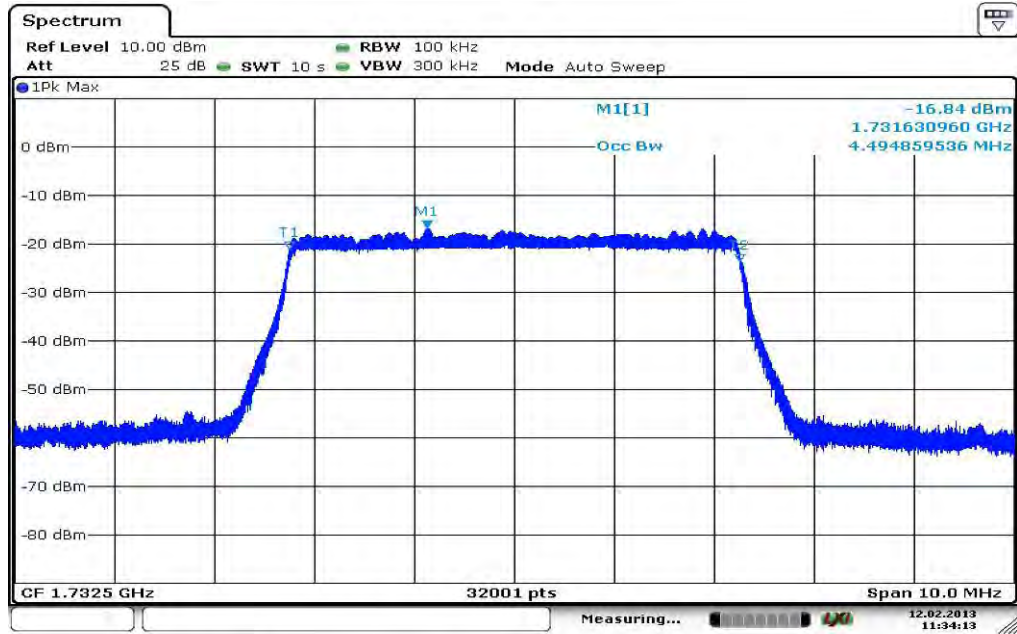

Plot 4: 10 MHz (99% - OBW)

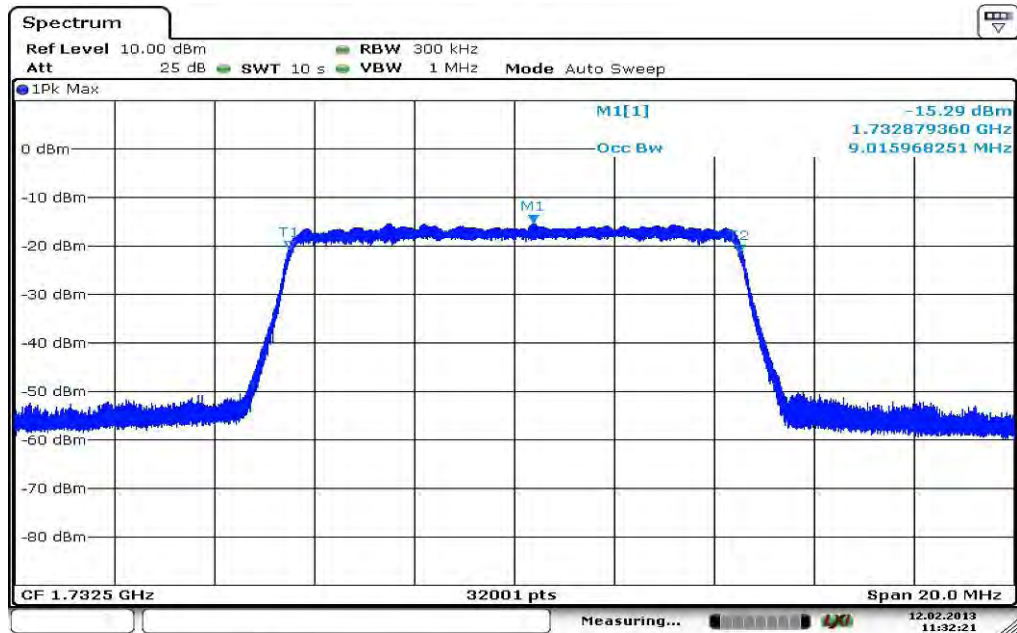

Plot 5: 15 MHz (99% - OBW)

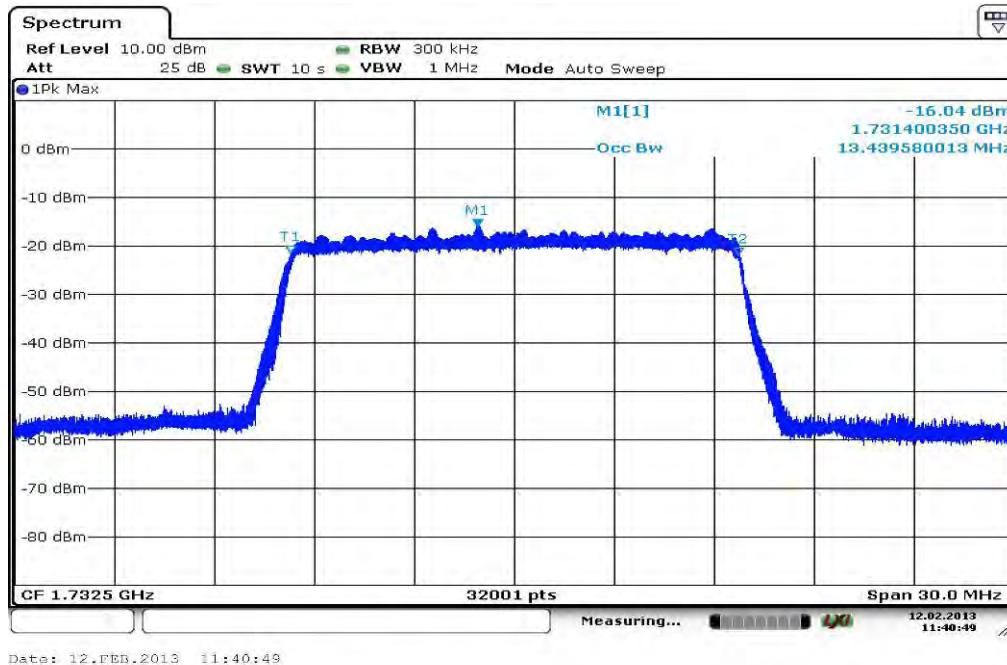

Plot 6: 20 MHz (99% - OBW)

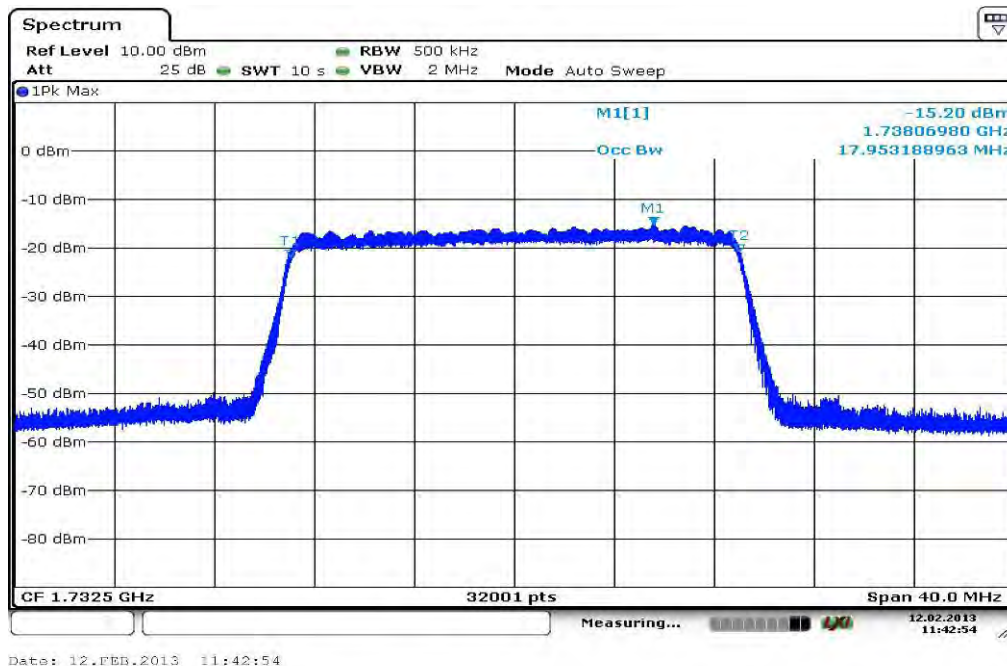

Plots: 16-QAM

Plot 1: 1.4 MHz (99% - OBW)

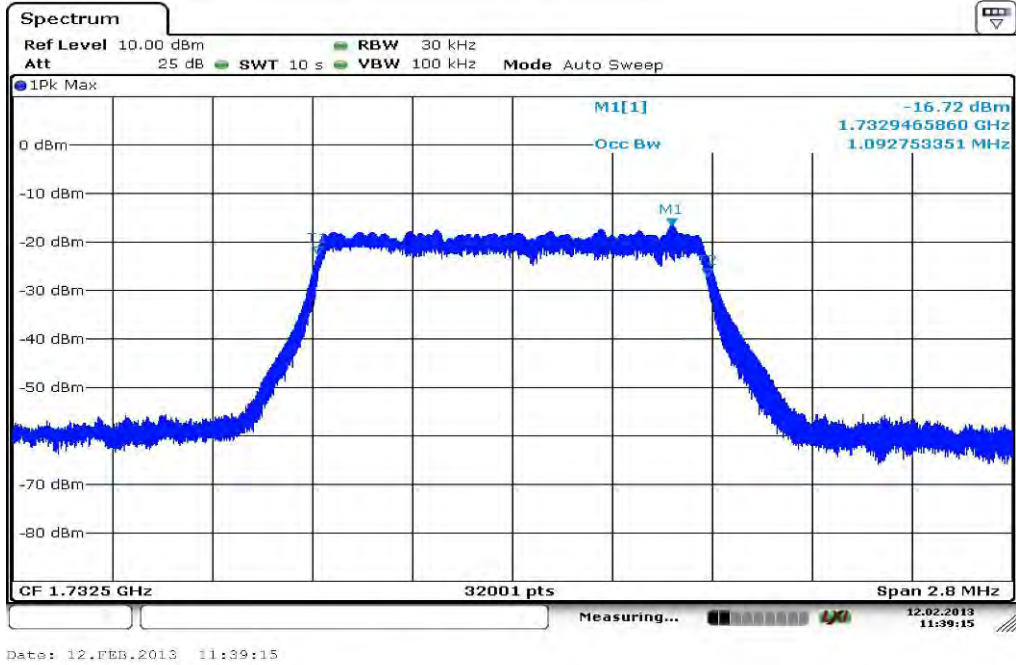

Plot 2: 3 MHz (99% - OBW)

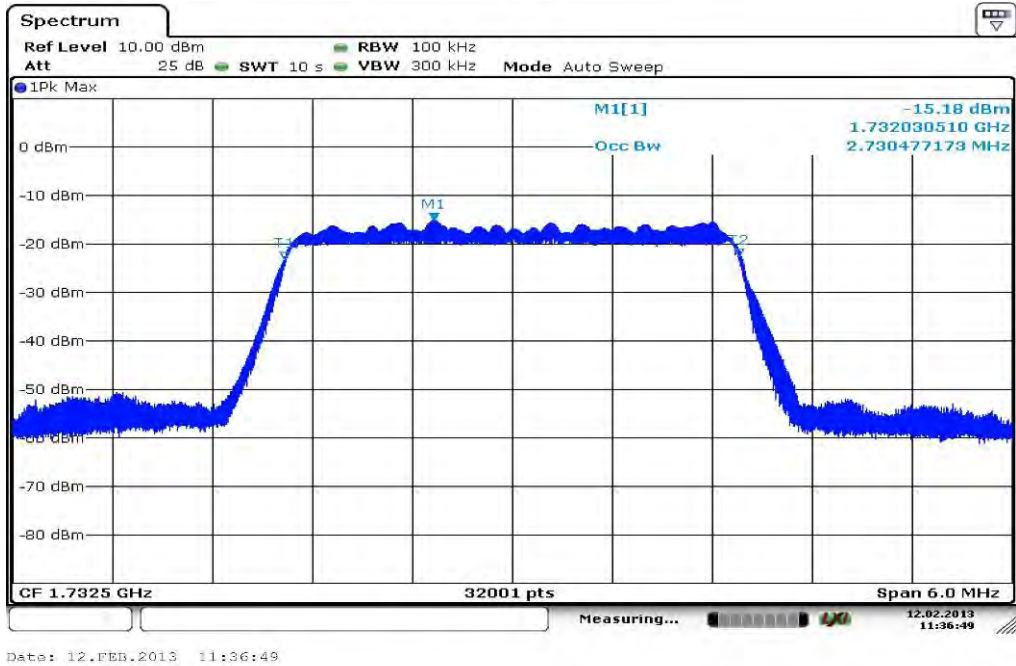

Plot 3: 5 MHz (99% - OBW)

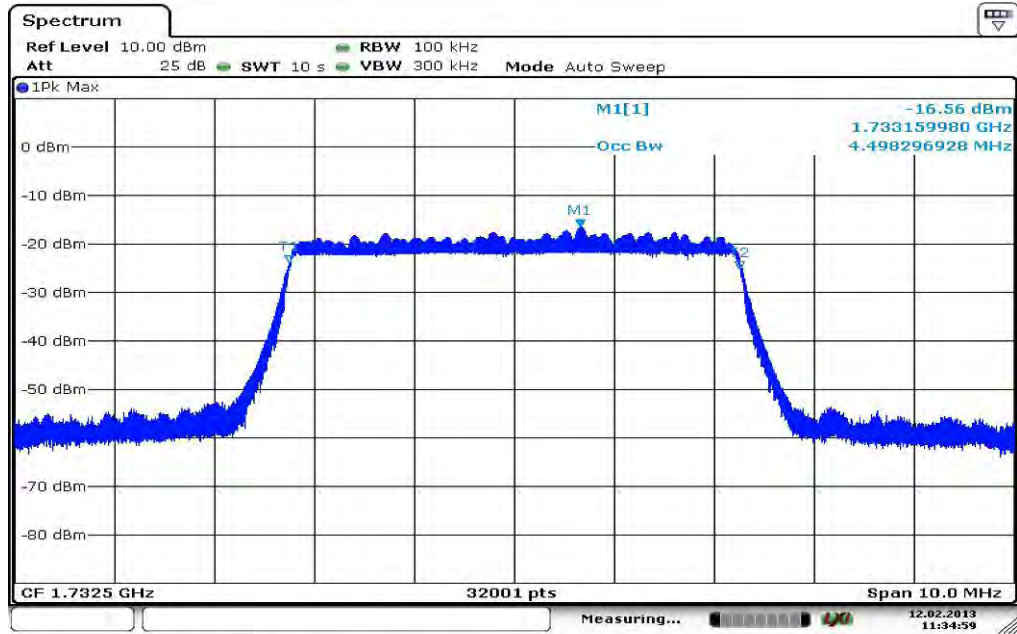

Date: 12.FEB.2013 11:34:59

Plot 4: 10 MHz (99% - OBW)

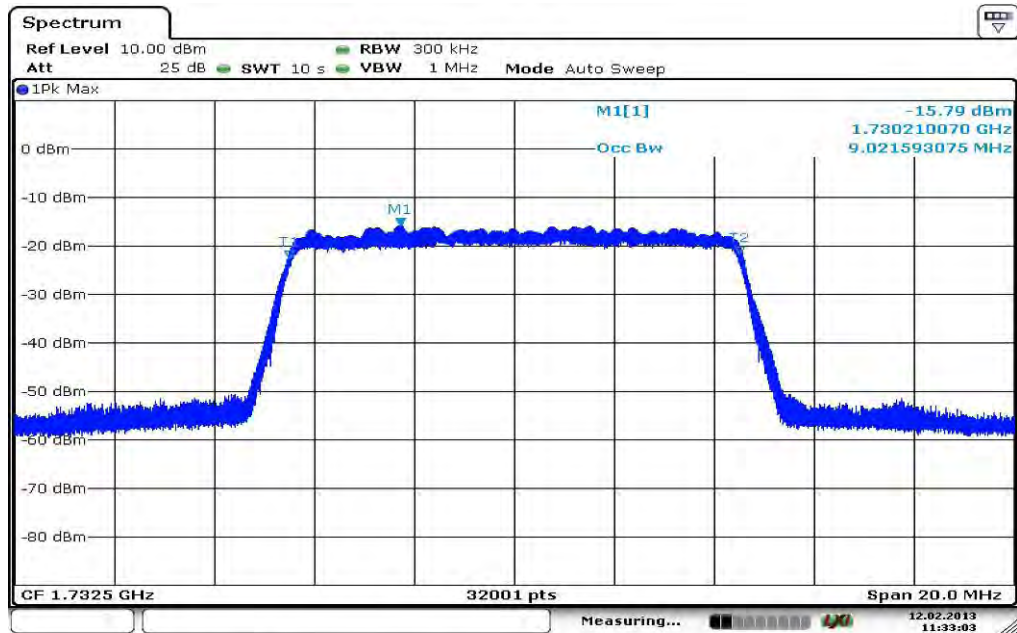

Date: 12.FEB.2013 11:33:03

Plot 5: 15 MHz (99% - OBW)

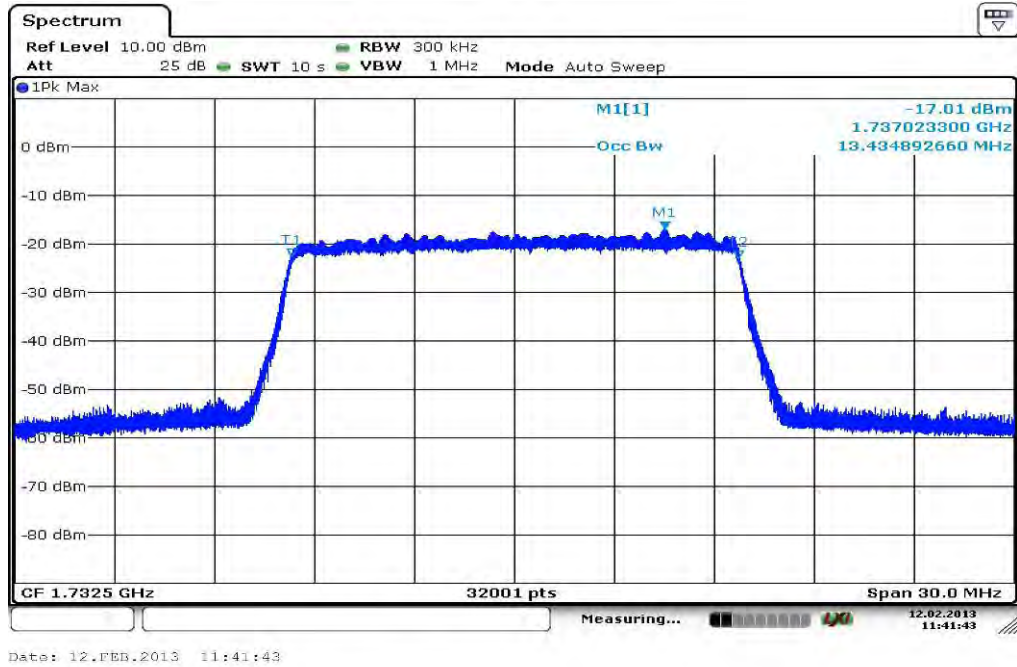

Plot 6: 20 MHz (99% - OBW)

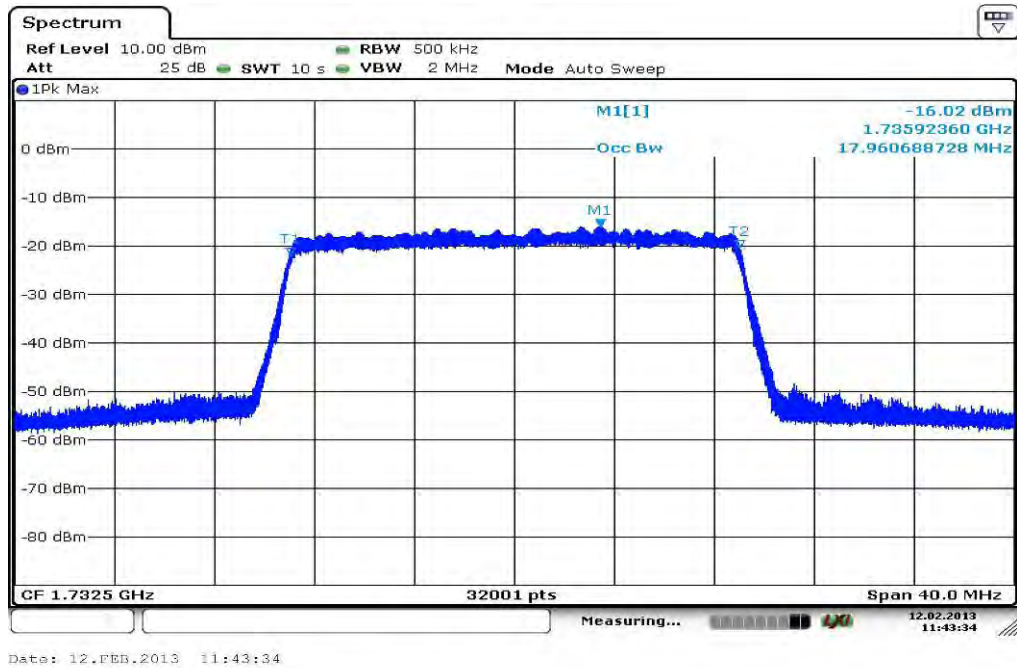

9 Test equipment and ancillaries used for tests

Typically, the calibrations of the test apparatus are commissioned to and performed by an accredited calibration laboratory. The calibration intervals are determined in accordance with the DIN EN ISO/IEC 17025. In addition to the external calibrations, the laboratory executes comparison measurements with other calibrated test systems or effective verifications. Weekly chamber inspections and range calibrations are performed. Where possible, rf-generating and signalling equipment as well as measuring receivers and analyzers are connected to an external high-precision 10 MHz reference (GPS-based or rubidium frequency standard).

In order to simplify the identification of the equipment used at some special tests, some items of test equipment and ancillaries can be provided with an identifier or number in the equipment list below (Labor/Item).

| No. | Lab / Item | Equipment | Type | Manufact. | Serial No. | INV. No Cetecom | Kind of Calibration | Last Calibration | Next Calibration |
|-----|------------|--|---------------------------------|----------------------|-------------|--------------------|------------------------|---------------------|---------------------|
| 1 | n. a. | DC power supply, 60Vdc, 50A, 1200 W | 6032A | HP Meßtechnik | 2818A03450 | 300001040 | Ve | 12.01.2012 | 12.01.2015 |
| 2 | n. a. | Double-Ridged Waveguide Horn Antenna 1-18.0GHz | 3115 | EMCO | 8812-3088 | 300001032 | vIKI! | 11.05.2011 | 11.05.2013 |
| 3 | n. a. | Active Loop Antenna | 6502 | EMCO | 2210 | 300001015 | ne | | |
| 4 | n. a. | Anechoic chamber | FAC 3/5m | MWB / TDK | 87400/02 | 300000996 | ev | | |
| 5 | n. a. | Switch / Control Unit | 3488A | HP Meßtechnik | * | 300000199 | ne | | |
| 6 | n. a. | Switch / Control Unit | 3488A | HP Meßtechnik | 2719A15013 | 300001156 | ne | | |
| 7 | 9 | Isolating Transformer | MPL IEC625 Bus Regeltrennt ravo | Erfi | 91350 | 300001155 | ne | | |
| 8 | n. a. | Three-Way Power Splitter, 50 Ohm | 11850C | HP Meßtechnik | | 300000997 | ne | | |
| 9 | n. a. | Amplifier | js42-00502650-28-5a | Parzich GMBH | 928979 | 300003143 | ne | | |
| 10 | n. a. | TRILOG Broadband Test-Antenna 30 MHz - 3 GHz | VULB9163 | Schwarzbeck | 371 | 300003854 | vIKI! | 14.10.2011 | 14.10.2014 |
| 11 | n. a. | MXE EMI Receiver 20 Hz bis 26,5 GHz | N9038A | Agilent Technologies | MY51210197 | 300004405 | k | 19.12.2011 | 19.12.2012 |
| 12 | 11b | Microwave System Amplifier, 0.5-26.5 GHz | 83017A | HP Meßtechnik | 00419 | 300002268 | ev | | |
| 13 | A025 | Std. Gain Horn Antenna 12.4 to 18.0 GHz | 639 | Narda | | 300000786 | ne | | |
| 14 | A027 | Std. Gain Horn Antenna 18.0 to 26.5 GHz | 638 | Narda | | 300000486 | ne | | |
| 15 | n. a. | Wideband Radio Communication Tester | CMW500 | R&S | 102375 | 300004187_0 | | | |
| 16 | n. a. | Switch / Control Unit | 3488A | HP Meßtechnik | 2605e08770 | 300001443 | ne | | |
| 17 | n. a. | Signal Analyzer 20Hz-26,5GHz-150 to + 30 DBM | FSiQ26 | R&S | 835111/0004 | 300002678 | Ve | | |
| 18 | n. a. | Power Supply 0-20V; 0-5A | 6632B | HP | US37478366 | 400000117 | vIKI! | 20.08.2012 | 20.08.2014 |

Agenda: Kind of Calibration

| | | | |
|------|--|-----|--|
| k | calibration / calibrated | EK | limited calibration |
| ne | not required (k, ev, izw, zw not required) | zw | cyclical maintenance (external cyclical maintenance) |
| ev | periodic self verification | izw | internal cyclical maintenance |
| Ve | long-term stability recognized | g | blocked for accredited testing |
| vkI! | Attention: extended calibration interval | | |
| NK! | Attention: not calibrated | *) | next calibration ordered / currently in progress |

10 Observations

No observations exceeding those reported with the single test cases have been made.

Annex A Document history

| Version | Applied changes | Date of release |
|---------|-------------------|-----------------|
| 1.0 | Initial release | 2012-12-11 |
| -A | Editorial changes | 2013-02-12 |

Annex B Further information**Glossary**

| | | |
|----------|---|--|
| AVG | - | Average |
| DUT | - | Device under test |
| EMC | - | Electromagnetic Compatibility |
| EN | - | European Standard |
| EUT | - | Equipment under test |
| ETSI | - | European Telecommunications Standard Institute |
| FCC | - | Federal Communication Commission |
| FCC ID | - | Company Identifier at FCC |
| HW | - | Hardware |
| IC | - | Industry Canada |
| Inv. No. | - | Inventory number |
| N/A | - | Not applicable |
| PP | - | Positive peak |
| QP | - | Quasi peak |
| S/N | - | Serial number |
| SW | - | Software |

Annex C Accreditation Certificate



Front side of certificate



Back side of certificate

Note:

The current certificate including annex is published on our website (see link below) or may be received from CETECOM ICT Services on request.

http://www.cetecom.com/fileadmin/de/CETECOM_D_Saarbruecken/accreditations_Jan_2010/DAKKS_Akkredi_Urk_EN17025-En_incl_Annex.pdf