

# FCC CERTIFICATION REPORT

Test Report No. : EI/2012/60012

Applicant : Sony Mobile Communications AB

Address of Applicant : Nya Vattentornet 22188 Lund/SWEDEN

**Equipment Under Test (EUT) :**

Name : PDA Phone

Brand Name : Sony

Marketing Name : ST26i

Model No. : PM-0160-BV

Added Model(s) : N/A

FCC ID : PY7PM-0160

Standards : FCC Part 15:2010, Subpart B, Class B

Date of Receipt : Jun. 22, 2012

Date of Test : Jun. 26 ~ Jul. 15, 2012

Date of Issue : Aug. 23, 2012

<b>Test Result :</b>	<b>PASS</b>
----------------------	-------------

In the configuration tested, the EUT complied with the standards specified above.

**Remarks :**

This report details the results of the testing carried out on one sample, the results contained in this test report do not relate to other samples of the same product. The manufacturer should ensure that all products in series production are in conformity with the product sample detailed in this report.

This report shall not be reproduced except in full, without the written approval of the laboratory. If the product in this report is used in any configuration other than that detailed in the report, the manufacturer must ensure the new system complies with all relevant standards.

<b>Test By:</b>	<i>Marcus Tseng</i> _____	<b>Date</b>	Aug. 23, 2012 _____
	<i>Marcus Tseng / Engineer</i>		
<b>Prepared By:</b>	<i>Jessie Li</i> _____	<b>Date</b>	Aug. 23, 2012 _____
	<i>Jessie Li(Clerk)</i>		
<b>Approved By</b>	<i>Jim Chang</i> _____	<b>Date</b>	Aug. 23, 2012 _____
	<i>Jim Chang / Supervisor</i>		

Unless otherwise stated the results shown in this test report refer only to the sample(s) tested and such sample(s) are retained for 90 days only.

除非另有說明，此報告結果僅對測試之樣品負責，同時此樣品僅保留90天。本報告未經本公司書面許可，不可部份複製。

This document is issued by the Company subject to its General Conditions of Service printed overleaf, available on request or accessible at [www.sgs.com/terms\\_and\\_conditions.htm](http://www.sgs.com/terms_and_conditions.htm) and, for electronic format documents, subject to Terms and Conditions for Electronic Documents at [www.sgs.com/terms\\_e-document.htm](http://www.sgs.com/terms_e-document.htm). Attention is drawn to the limitation of liability, indemnification and jurisdiction issues defined therein. Any holder of this document is advised that information contained hereon reflects the Company's findings at the time of its intervention only and within the limits of Client's instructions, if any. The Company's sole responsibility is to its Client and this document does not exonerate parties to a transaction from exercising all their rights and obligations under the transaction documents. This document cannot be reproduced except in full, without prior written approval of the Company. Any unauthorized alteration, forgery or falsification of the content or appearance of this document is unlawful and offenders may be prosecuted to the fullest extent of the law.

**Version**

Version No.	Description	Date
00	Original report	Aug. 08, 2012
01	Revised the Hardware Version	Aug. 23, 2012

Unless otherwise stated the results shown in this test report refer only to the sample(s) tested and such sample(s) are retained for 90 days only.

除非另有說明，此報告結果僅對測試之樣品負責，同時此樣品僅保留90天。本報告未經本公司書面許可，不可部份複製。

This document is issued by the Company subject to its General Conditions of Service printed overleaf, available on request or accessible at [www.sgs.com/terms\\_and\\_conditions.htm](http://www.sgs.com/terms_and_conditions.htm) and, for electronic format documents, subject to Terms and Conditions for Electronic Documents at [www.sgs.com/terms\\_e-document.htm](http://www.sgs.com/terms_e-document.htm). Attention is drawn to the limitation of liability, indemnification and jurisdiction issues defined therein. Any holder of this document is advised that information contained hereon reflects the Company's findings at the time of its intervention only and within the limits of Client's instructions, if any. The Company's sole responsibility is to its Client and this document does not exonerate parties to a transaction from exercising all their rights and obligations under the transaction documents. This document cannot be reproduced except in full, without prior written approval of the Company. Any unauthorized alteration, forgery or falsification of the content or appearance of this document is unlawful and offenders may be prosecuted to the fullest extent of the law.

# Contents

<b>1. GENERAL INFORMATION .....</b>	<b>5</b>
1.1 APPLICANT & MANUFACTURER INFORMATION .....	5
1.2 GENERAL DESCRIPTION OF EUT.....	5
1.3 DETAILS OF EUT.....	5
1.4 EUT DESCRIPTION.....	6
1.5 OPERATION PROCEDURE .....	6
1.6 DESCRIPTION OF SUPPORT UNITS .....	7
1.7 MODIFICATION LIST.....	7
1.8 CABLE LIST.....	7
1.9 TEST SET-UP CONFIGURATION .....	8
1.10 MEASUREMENT PROCEDURE.....	10
1.11 STANDARDS APPLICABLE FOR TESTING.....	10
1.12 SUMMARY OF RESULTS.....	10
<b>2. RADIO DISTURBANCE .....</b>	<b>11</b>
2.1 TEST RESULTS.....	11
2.2 FREQUENCY RANGE .....	11
2.3 LIMITS OF CONDUCTED AND RADIATED EMISSION.....	11
2.3.1 LIMIT OF CONDUCTED EMISSION OF FCC PART 15, SUBPART B/CISPR 22.....	11
2.3.2 LIMIT OF RADIATED EMISSIONS OF FCC PART 15, SUBPART B/CISPR 22.....	12
2.4. TEST OF CONDUCTED EMISSION .....	13
2.4.1 TEST EQUIPMENTS.....	13
2.4.2 TEST SITE .....	13
2.4.3 OPERATING ENVIRONMENT .....	13
2.4.4 UNCERTAINTY OF CONDUCTED EMISSION .....	13
2.4.5 MEASUREMENT LEVEL AND FACTOR CALCULATE METHOD .....	13
2.4.6 MEASUREMENT DATA .....	14
2.5 TEST OF RADIATED EMISSION .....	28
2.5.1 TEST INSTRUMENTS .....	28
2.5.2 TEST SITE .....	29
2.5.3 OPERATING ENVIRONMENT .....	30
2.5.4 UNCERTAINTY OF RADIATED EMISSION .....	30
2.5.5 MEASUREMENT LEVEL AND FACTOR CALCULATE METHOD .....	30

Unless otherwise stated the results shown in this test report refer only to the sample(s) tested and such sample(s) are retained for 90 days only.

除非另有說明，此報告結果僅對測試之樣品負責，同時此樣品僅保留90天。本報告未經本公司書面許可，不可部份複製。

This document is issued by the Company subject to its General Conditions of Service printed overleaf, available on request or accessible at [www.sgs.com/terms\\_and\\_conditions.htm](http://www.sgs.com/terms_and_conditions.htm) and, for electronic format documents, subject to Terms and Conditions for Electronic Documents at [www.sgs.com/terms\\_e-document.htm](http://www.sgs.com/terms_e-document.htm). Attention is drawn to the limitation of liability, indemnification and jurisdiction issues defined therein. Any holder of this document is advised that information contained hereon reflects the Company's findings at the time of its intervention only and within the limits of Client's instructions, if any. The Company's sole responsibility is to its Client and this document does not exonerate parties to a transaction from exercising all their rights and obligations under the transaction documents. This document cannot be reproduced except in full, without prior written approval of the Company. Any unauthorized alteration, forgery or falsification of the content or appearance of this document is unlawful and offenders may be prosecuted to the fullest extent of the law.

## Contents

2.5.6 MEASUREMENT DATA .....	31
<b>3. PHOTOGRAPHS OF TEST .....</b>	<b>49</b>
<b>4. PHOTOGRAPHS OF PRODUCT.....</b>	<b>57</b>

Unless otherwise stated the results shown in this test report refer only to the sample(s) tested and such sample(s) are retained for 90 days only.

除非另有說明，此報告結果僅對測試之樣品負責，同時此樣品僅保留90天。本報告未經本公司書面許可，不可部份複製。

This document is issued by the Company subject to its General Conditions of Service printed overleaf, available on request or accessible at [www.sgs.com/terms\\_and\\_conditions.htm](http://www.sgs.com/terms_and_conditions.htm) and, for electronic format documents, subject to Terms and Conditions for Electronic Documents at [www.sgs.com/terms\\_e-document.htm](http://www.sgs.com/terms_e-document.htm). Attention is drawn to the limitation of liability, indemnification and jurisdiction issues defined therein. Any holder of this document is advised that information contained hereon reflects the Company's findings at the time of its intervention only and within the limits of Client's instructions, if any. The Company's sole responsibility is to its Client and this document does not exonerate parties to a transaction from exercising all their rights and obligations under the transaction documents. This document cannot be reproduced except in full, without prior written approval of the Company. Any unauthorized alteration, forgery or falsification of the content or appearance of this document is unlawful and offenders may be prosecuted to the fullest extent of the law.

## 1. General Information

### 1.1 Applicant & Manufacturer Information

Applicant : Sony Mobile Communications AB

Address of Applicant : Nya Vattentornet 22188 Lund/SWEDEN

### 1.2 General Description of EUT

Name : PDA Phone

Brand Name : Sony

Marketing Name : ST26i

Model No. : PM-0160-BV

Added Model(s) : N/A

FCC ID : PY7PM-0160

Model Difference : N/A

Filing Type : Certification

### 1.3 Details of EUT

Data Cable (USB):	Model No.: EC450, Supplier: K-one, Part No.: 1262-3995	
Simple Hands-free (SHF):	Model No.: MH410C, Supplier: Foster Electric Type No.: CCA-0004017	
Car Charger:	Model No.: AN400, Supplier: Salcomp, Type No.: CAA-0003013	
Hardware Version:	A	
Software Version:	11.0.A.1.0	
Power Supply:	3.7Vdc from Li-Ion battery or 5Vdc from adapter.	
	Battery:	1. Model No.: BA900, Supplier: SONY Type No.: AB-0500
	Adapter:	1. Model No.: EP800, Supplier: Salcomp Type No.: CAA-0002016-US

Unless otherwise stated the results shown in this test report refer only to the sample(s) tested and such sample(s) are retained for 90 days only.

除非另有說明，此報告結果僅對測試之樣品負責，同時此樣品僅保留90天。本報告未經本公司書面許可，不可部份複製。

This document is issued by the Company subject to its General Conditions of Service printed overleaf, available on request or accessible at [www.sgs.com/terms\\_and\\_conditions.htm](http://www.sgs.com/terms_and_conditions.htm) and, for electronic format documents, subject to Terms and Conditions for Electronic Documents at [www.sgs.com/terms\\_e-document.htm](http://www.sgs.com/terms_e-document.htm). Attention is drawn to the limitation of liability, indemnification and jurisdiction issues defined therein. Any holder of this document is advised that information contained hereon reflects the Company's findings at the time of its intervention only and within the limits of Client's instructions, if any. The Company's sole responsibility is to its Client and this document does not exonerate parties to a transaction from exercising all their rights and obligations under the transaction documents. This document cannot be reproduced except in full, without prior written approval of the Company. Any unauthorized alteration, forgery or falsification of the content or appearance of this document is unlawful and offenders may be prosecuted to the fullest extent of the law.

### 1.4 EUT description

The equipment under test (EUT) is the GSM/GPRS 850,1900, FM, BT, WiFi and GPS. The test data contained in this report pertains only to the emissions due to digital circuitry of the EUT.

<b>ST26i</b>	<b>Operation :</b>		<b>Unintentional radiation mode</b>	
	<b>Config 1</b>	<b>Config 2</b>	<b>Config 3</b>	
Applicable standard (FCC)	FCC 15B			
Accessories	UE + Battery +USB Cable + SHF	UE + Battery + AC Adaptor +USB Cable + SHF	UE + Battery + AC Adaptor +USB Cable + SHF	
Main Function	<b>Data link</b>	<b>Camera</b>	<b>FM Mode</b>	
Additional Function	Data link	FULL SYSTEM	FM Mode	
<b>Description</b>				
radiated emission	Data link	Recording&Play Recording&MP3	FM Mode (FM87.6 & FM98 & FM107.9 )	
conducted emission (DC Power)	N/A	N/A	N/A	
conducted emission (AC Power)	Data link	Recording&Play Recording&MP3	FM Mode (FM87.6 & FM98 & FM107.9 )	

### 1.5 Operation Procedure

1. Set down EUT with support units and turn on the power of all equipment.
2. Pre-test the EUT in all modes by each model, then figure the worst case out.
3. Tests under the normal operation due to unintentional radiation mode.

Unless otherwise stated the results shown in this test report refer only to the sample(s) tested and such sample(s) are retained for 90 days only. 除非另有說明，此報告結果僅對測試之樣品負責，同時此樣品僅保留90天。本報告未經本公司書面許可，不可部份複製。

This document is issued by the Company subject to its General Conditions of Service printed overleaf, available on request or accessible at [www.sgs.com/terms\\_and\\_conditions.htm](http://www.sgs.com/terms_and_conditions.htm) and, for electronic format documents, subject to Terms and Conditions for Electronic Documents at [www.sgs.com/terms\\_e-document.htm](http://www.sgs.com/terms_e-document.htm). Attention is drawn to the limitation of liability, indemnification and jurisdiction issues defined therein. Any holder of this document is advised that information contained hereon reflects the Company's findings at the time of its intervention only and within the limits of Client's instructions, if any. The Company's sole responsibility is to its Client and this document does not exonerate parties to a transaction from exercising all their rights and obligations under the transaction documents. This document cannot be reproduced except in full, without prior written approval of the Company. Any unauthorized alteration, forgery or falsification of the content or appearance of this document is unlawful and offenders may be prosecuted to the fullest extent of the law.



**1.6 Description of Support Units**

PRODUCT	MANUFACTURER	MODEL NO.	SERIAL NO.
NOTEBOOK	IBM	L412	LR-ZYMYD
Mouse	HP	M-UAE96	390938-001
Printer	HP	DJ3820	CN34L181B1
Signal Generator	Levear	VP-8194D	N/A

**1.7 Modification List**

No modification by SGS Taiwan Electronics & Communication Laboratory.

**1.8 Cable List**

Cable Type	Length	Shield
N/A	N/A	N/A

Unless otherwise stated the results shown in this test report refer only to the sample(s) tested and such sample(s) are retained for 90 days only.

除非另有說明，此報告結果僅對測試之樣品負責，同時此樣品僅保留90天。本報告未經本公司書面許可，不可部份複製。

This document is issued by the Company subject to its General Conditions of Service printed overleaf, available on request or accessible at [www.sgs.com/terms\\_and\\_conditions.htm](http://www.sgs.com/terms_and_conditions.htm) and, for electronic format documents, subject to Terms and Conditions for Electronic Documents at [www.sgs.com/terms\\_e-document.htm](http://www.sgs.com/terms_e-document.htm). Attention is drawn to the limitation of liability, indemnification and jurisdiction issues defined therein. Any holder of this document is advised that information contained hereon reflects the Company's findings at the time of its intervention only and within the limits of Client's instructions, if any. The Company's sole responsibility is to its Client and this document does not exonerate parties to a transaction from exercising all their rights and obligations under the transaction documents. This document cannot be reproduced except in full, without prior written approval of the Company. Any unauthorized alteration, forgery or falsification of the content or appearance of this document is unlawful and offenders may be prosecuted to the fullest extent of the law.

## 1.9 Test Set-Up Configuration

Config1

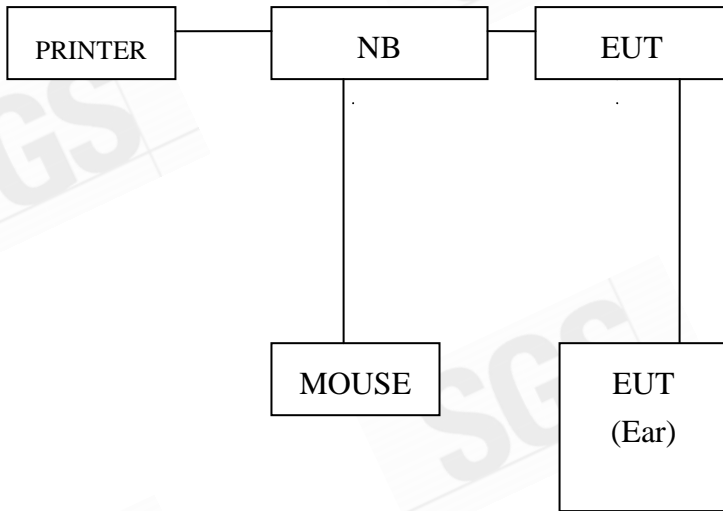

Config2

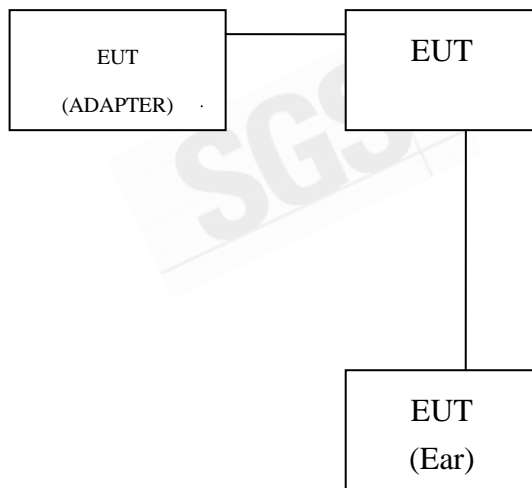

Unless otherwise stated the results shown in this test report refer only to the sample(s) tested and such sample(s) are retained for 90 days only.

除非另有說明，此報告結果僅對測試之樣品負責，同時此樣品僅保留90天。本報告未經本公司書面許可，不可部份複製。

This document is issued by the Company subject to its General Conditions of Service printed overleaf, available on request or accessible at [www.sgs.com/terms\\_and\\_conditions.htm](http://www.sgs.com/terms_and_conditions.htm) and, for electronic format documents, subject to Terms and Conditions for Electronic Documents at [www.sgs.com/terms\\_e-document.htm](http://www.sgs.com/terms_e-document.htm). Attention is drawn to the limitation of liability, indemnification and jurisdiction issues defined therein. Any holder of this document is advised that information contained hereon reflects the Company's findings at the time of its intervention only and within the limits of Client's instructions, if any. The Company's sole responsibility is to its Client and this document does not exonerate parties to a transaction from exercising all their rights and obligations under the transaction documents. This document cannot be reproduced except in full, without prior written approval of the Company. Any unauthorized alteration, forgery or falsification of the content or appearance of this document is unlawful and offenders may be prosecuted to the fullest extent of the law.



### Config3

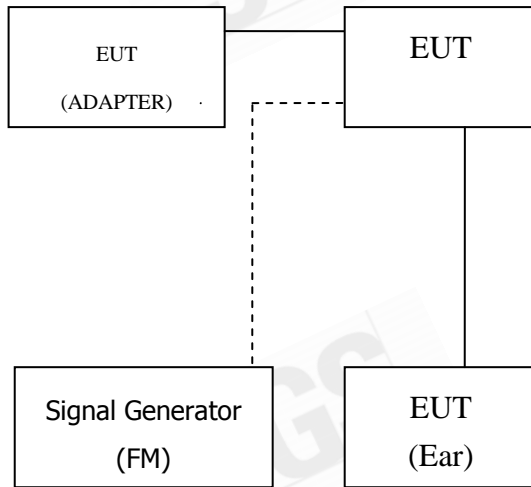

Unless otherwise stated the results shown in this test report refer only to the sample(s) tested and such sample(s) are retained for 90 days only.

除非另有說明，此報告結果僅對測試之樣品負責，同時此樣品僅保留90天。本報告未經本公司書面許可，不可部份複製。

This document is issued by the Company subject to its General Conditions of Service printed overleaf, available on request or accessible at [www.sgs.com/terms\\_and\\_conditions.htm](http://www.sgs.com/terms_and_conditions.htm) and, for electronic format documents, subject to Terms and Conditions for Electronic Documents at [www.sgs.com/terms\\_e-document.htm](http://www.sgs.com/terms_e-document.htm). Attention is drawn to the limitation of liability, indemnification and jurisdiction issues defined therein. Any holder of this document is advised that information contained hereon reflects the Company's findings at the time of its intervention only and within the limits of Client's instructions, if any. The Company's sole responsibility is to its Client and this document does not exonerate parties to a transaction from exercising all their rights and obligations under the transaction documents. This document cannot be reproduced except in full, without prior written approval of the Company. Any unauthorized alteration, forgery or falsification of the content or appearance of this document is unlawful and offenders may be prosecuted to the fullest extent of the law.

### 1.10 Measurement Procedure

Conducted Emission Testing was performed according ANSI C63.4:2003 in a shielded room with peripherals placed on a table, 0.8m high over a metal floor. It was located more than required distance away from the shielded room wall.

Radiated Emission Testing was performed according to ANSI C63.4:2003 at the open field test site. The EUT was placed in a 0.8m high table along with the peripherals. The turn table was separated from the antenna distance 10meters. Cables were placed in a position to produce maximum emissions as determined by experimentation, and operation mode was selected for maximum.

The frequencies and amplitudes of maximum emission were measured at varying azimuths, antenna heights and antenna polarities. Reported are maximized emission levels.

### 1.11 Standards Applicable for Testing

Table of tests to be carried out under FCC Part 15, Subpart B

Test Standards	Status
FCC Part 15, Subpart B	Applicable
Deviation from Standard	No Deviation

### 1.12 Summary of Results

Highest Emission					
Standard	Test Type	Result	Phase/Polar.	Frequency (MHz)	Margin(dB)
FCC Part 15 Subpart B Class B/CISPR 22	Conducted Emission	PASS	Line	0.2008	-11.37(QP)
			Neutral	3.0571	-9.96(AVG)
	Radiated Emission	PASS	Ver.	32.6400	-10.56(QP)

Unless otherwise stated the results shown in this test report refer only to the sample(s) tested and such sample(s) are retained for 90 days only.  
除非另有說明，此報告結果僅對測試之樣品負責，同時此樣品僅保留90天。本報告未經本公司書面許可，不可部份複製。

This document is issued by the Company subject to its General Conditions of Service printed overleaf, available on request or accessible at [www.sgs.com/terms\\_and\\_conditions.htm](http://www.sgs.com/terms_and_conditions.htm) and, for electronic format documents, subject to Terms and Conditions for Electronic Documents at [www.sgs.com/terms\\_e-document.htm](http://www.sgs.com/terms_e-document.htm). Attention is drawn to the limitation of liability, indemnification and jurisdiction issues defined therein. Any holder of this document is advised that information contained hereon reflects the Company's findings at the time of its intervention only and within the limits of Client's instructions, if any. The Company's sole responsibility is to its Client and this document does not exonerate parties to a transaction from exercising all their rights and obligations under the transaction documents. This document cannot be reproduced except in full, without prior written approval of the Company. Any unauthorized alteration, forgery or falsification of the content or appearance of this document is unlawful and offenders may be prosecuted to the fullest extent of the law.

## 2. Radio Disturbance

### 2.1 Test Results

	Results
Conducted Emission	<b>Pass</b>
Radiated Emission	<b>Pass</b>

### 2.2 Frequency Range

Conducted Emission : 150 kHz - 30 MHz

Radiated Emission : 30 MHz - 1000 MHz

### 2.3 Limits Of Conducted And Radiated Emission

#### 2.3.1 Limit Of Conducted Emission Of FCC Part 15, Subpart B/CISPR 22

FREQUENCY (MHz)	Class A (dBuV)		Class B (dBuV)	
	Quasi - peak	Average	Quasi - peak	Average
0.15 - 0.5	79	66	66 - 56	56 - 46
0.50 - 5.0	73	60	56	46
5.0 - 30.0	73	60	60	50

Note : (1) The lower limit shall apply at the transition frequencies.

(2) The limit decreases linearly with the logarithm of the frequency in the range 0.15 to 0.50 MHz.

(3) All emanation from a class A/B digital device or system, including any network of conductors and apparatus connected there to, shall not exceed the level of field strengths specified above.

Unless otherwise stated the results shown in this test report refer only to the sample(s) tested and such sample(s) are retained for 90 days only.

除非另有說明，此報告結果僅對測試之樣品負責，同時此樣品僅保留90天。本報告未經本公司書面許可，不可部份複製。

This document is issued by the Company subject to its General Conditions of Service printed overleaf, available on request or accessible at [www.sgs.com/terms\\_and\\_conditions.htm](http://www.sgs.com/terms_and_conditions.htm) and, for electronic format documents, subject to Terms and Conditions for Electronic Documents at [www.sgs.com/terms\\_e-document.htm](http://www.sgs.com/terms_e-document.htm). Attention is drawn to the limitation of liability, indemnification and jurisdiction issues defined therein. Any holder of this document is advised that information contained hereon reflects the Company's findings at the time of its intervention only and within the limits of Client's instructions, if any. The Company's sole responsibility is to its Client and this document does not exonerate parties to a transaction from exercising all their rights and obligations under the transaction documents. This document cannot be reproduced except in full, without prior written approval of the Company. Any unauthorized alteration, forgery or falsification of the content or appearance of this document is unlawful and offenders may be prosecuted to the fullest extent of the law.

**2.3.2 Limit Of Radiated Emissions Of FCC Part 15, Subpart B/CISPR 22**

**FCC Limit:**

- Detector Function : Quasi – Peak

FREQUENCY (MHz)	Class A (at 10m)	Class B (at 3m)
	dBuV/m	dBuV/m
30~88	39	40
88~216	43.5	43.5
216~960	46.44	46
Above 960	49.54	54

- Detector Function : Peak , Average

FREQUENCY (MHz)	Class A (dBuV) (at 3m)		Class B (dBuV) (at 3m)	
	Peak	Average	Peak	Average
Above 1000	79.3	59.3	73.9	53.9

**CISPR Limit:**

- Detector Function : Quasi – Peak

FREQUENCY (MHz)	Class A (at 10m)	Class B (at 10m)
	dBuV/m	dBuV/m
30-230	40	30
230-1000	47	37

- Detector Function : Peak , Average – Class A

Frequency range GHz	Average Limit dB(µV/m)	Peak Limit dB(µV/m)
1 to 3	56	76
3 to 6	60	80

- Detector Function : Peak , Average – Class B

Frequency range GHz	Average Limit dB(µV/m)	Peak Limit dB(µV/m)
1 to 3	50	70
3 to 6	54	74

Note : The lower limit applies at the transition frequency.

Unless otherwise stated the results shown in this test report refer only to the sample(s) tested and such sample(s) are retained for 90 days only.

除非另有說明，此報告結果僅對測試之樣品負責，同時此樣品僅保留90天。本報告未經本公司書面許可，不可部份複製。

This document is issued by the Company subject to its General Conditions of Service printed overleaf, available on request or accessible at [www.sgs.com/terms\\_and\\_conditions.htm](http://www.sgs.com/terms_and_conditions.htm) and, for electronic format documents, subject to Terms and Conditions for Electronic Documents at [www.sgs.com/terms\\_e-document.htm](http://www.sgs.com/terms_e-document.htm). Attention is drawn to the limitation of liability, indemnification and jurisdiction issues defined therein. Any holder of this document is advised that information contained hereon reflects the Company's findings at the time of its intervention only and within the limits of Client's instructions, if any. The Company's sole responsibility is to its Client and this document does not exonerate parties to a transaction from exercising all their rights and obligations under the transaction documents. This document cannot be reproduced except in full, without prior written approval of the Company. Any unauthorized alteration, forgery or falsification of the content or appearance of this document is unlawful and offenders may be prosecuted to the fullest extent of the law.





## 2.4.6 Measurement Data

### Config 1 : Data Link L

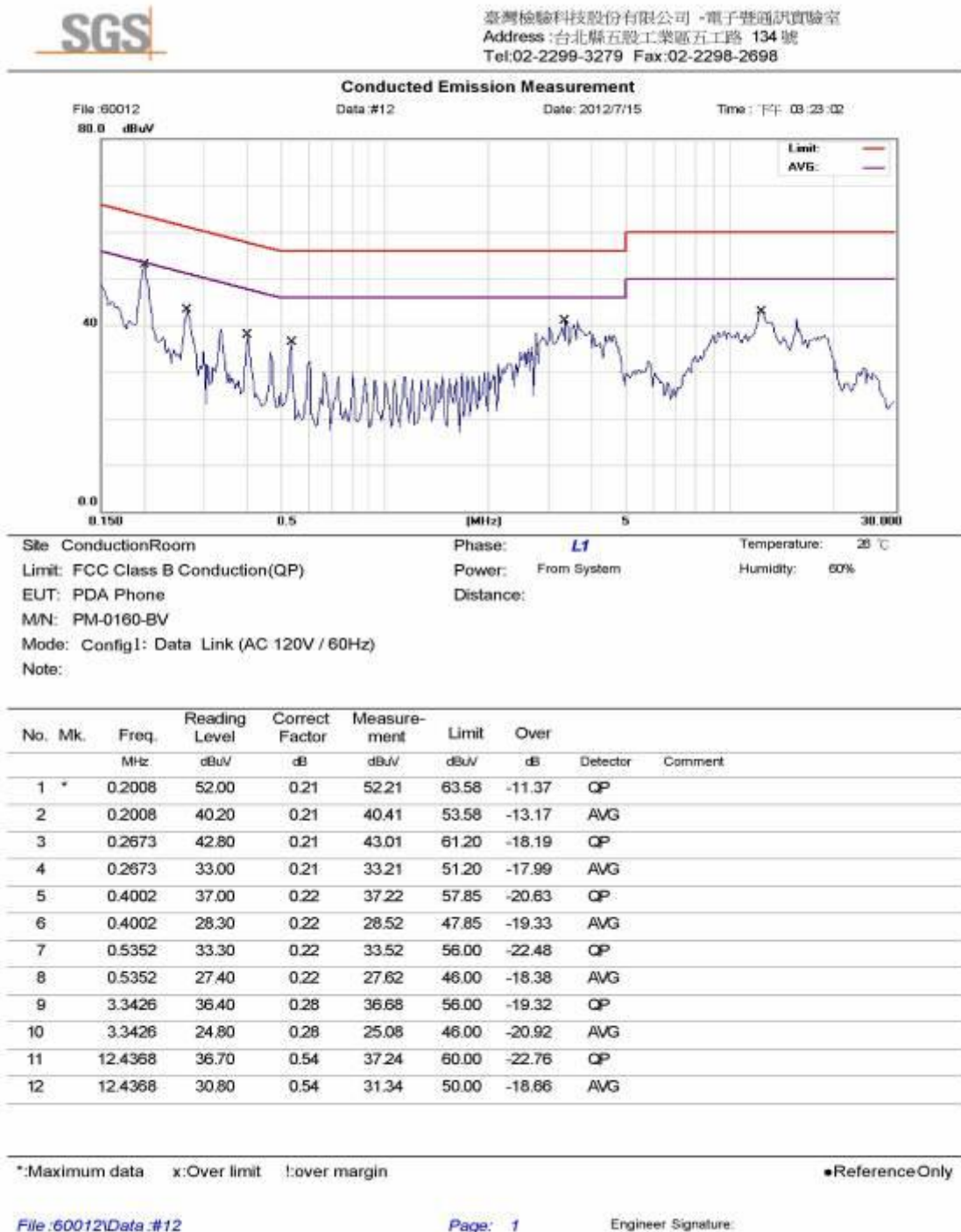

Unless otherwise stated the results shown in this test report refer only to the sample(s) tested and such sample(s) are retained for 90 days only.

除非另有說明，此報告結果僅對測試之樣品負責，同時此樣品僅保留90天。本報告未經本公司書面許可，不可部份複製。

This document is issued by the Company subject to its General Conditions of Service printed overleaf, available on request or accessible at [www.sgs.com/terms\\_and\\_conditions.htm](http://www.sgs.com/terms_and_conditions.htm) and, for electronic format documents, subject to Terms and Conditions for Electronic Documents at [www.sgs.com/terms\\_e-document.htm](http://www.sgs.com/terms_e-document.htm). Attention is drawn to the limitation of liability, indemnification and jurisdiction issues defined therein. Any holder of this document is advised that information contained hereon reflects the Company's findings at the time of its intervention only and within the limits of Client's instructions, if any. The Company's sole responsibility is to its Client and this document does not exonerate parties to a transaction from exercising all their rights and obligations under the transaction documents. This document cannot be reproduced except in full, without prior written approval of the Company. Any unauthorized alteration, forgery or falsification of the content or appearance of this document is unlawful and offenders may be prosecuted to the fullest extent of the law.

N



臺灣檢驗科技股份有限公司 - 電子暨通訊實驗室  
 Address : 台北縣五股工業區五工路 134 號  
 Tel:02-2299-3279 Fax:02-2298-2698

**Conducted Emission Measurement**

File :60012 Data #11 Date: 2012/7/15 Time: 下午 03:13:51



Site: ConductionRoom Phase: **N** Temperature: 25 °C  
 Limit: FCC Class B Conduction(QP) Power: From System Humidity: 60%  
 EUT: PDA Phone Distance:  
 MN: PM-0160-BV  
 Mode: Config1: Data Link (AC 120V / 60Hz)  
 Note:

No.	Mk.	Freq.	Reading Level	Correct Factor	Measurement	Limit	Over	Detector	Comment
		MHz	dBuV	dB	dBuV	dBuV	dB		
1	*	0.2008	52.60	0.31	52.91	63.58	-10.67	QP	
2		0.2008	42.10	0.31	42.41	53.58	-11.17	AVG	
3		0.2673	43.50	0.32	43.82	61.20	-17.38	QP	
4		0.2673	34.10	0.32	34.42	51.20	-16.78	AVG	
5		0.4002	38.30	0.34	38.64	57.85	-19.21	QP	
6		0.4002	32.10	0.34	32.44	47.85	-15.41	AVG	
7		3.2018	39.00	0.34	39.34	56.00	-16.66	QP	
8		3.2018	30.10	0.34	30.44	46.00	-15.56	AVG	
9		3.5381	40.00	0.35	40.35	56.00	-15.65	QP	
10		3.5381	29.80	0.35	30.15	46.00	-15.85	AVG	
11		14.0360	43.30	0.58	43.88	60.00	-16.12	QP	
12		14.0360	38.70	0.58	39.28	50.00	-10.72	AVG	

\*:Maximum data x:Over limit !:over margin #Reference Only

File :60012\Data :#11

Page: 1

Engineer Signature:

Unless otherwise stated the results shown in this test report refer only to the sample(s) tested and such sample(s) are retained for 90 days only.

除非另有說明，此報告結果僅對測試之樣品負責，同時此樣品僅保留90天。本報告未經本公司書面許可，不可部份複製。

This document is issued by the Company subject to its General Conditions of Service printed overleaf, available on request or accessible at [www.sgs.com/terms\\_and\\_conditions.htm](http://www.sgs.com/terms_and_conditions.htm) and, for electronic format documents, subject to Terms and Conditions for Electronic Documents at [www.sgs.com/terms\\_e-document.htm](http://www.sgs.com/terms_e-document.htm). Attention is drawn to the limitation of liability, indemnification and jurisdiction issues defined therein. Any holder of this document is advised that information contained hereon reflects the Company's findings at the time of its intervention only and within the limits of Client's instructions, if any. The Company's sole responsibility is to its Client and this document does not exonerate parties to a transaction from exercising all their rights and obligations under the transaction documents. This document cannot be reproduced except in full, without prior written approval of the Company. Any unauthorized alteration, forgery or falsification of the content or appearance of this document is unlawful and offenders may be prosecuted to the fullest extent of the law.



Config 2 : Recording  
L

SGS  
 臺灣檢驗科技股份有限公司 - 電子暨通訊實驗室  
 Address : 台北縣五股工業區五工路 134 號  
 Tel:02-2299-3279 Fax:02-2298-2698

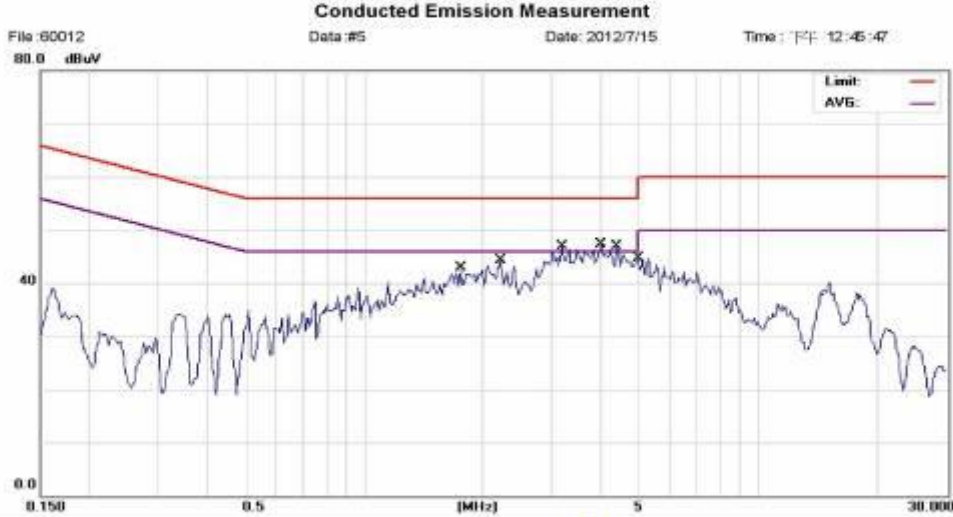

File: 60012 Data: #5 Date: 2012/7/15 Time: 下午 12:45:47  
 Site: ConductionRoom Phase: L1 Temperature: 25 °C  
 Limit: FCC Class B Conduction(QP) Power: AC 120V/60Hz Humidity: 60%  
 EUT: PDA Phone Distance:  
 MN: PM-0160-BV  
 Mode: Config 2:Recording  
 Note:

No.	Mk.	Freq. MHz	Reading Level dBuV	Correct Factor dB	Measurement dBuV	Limit dBuV	Over dB	Detector	Comment
1		1.7590	37.10	0.25	37.35	56.00	-18.65	QP	
2		1.7590	26.80	0.25	27.05	46.00	-18.95	AVG	
3		2.2165	36.50	0.25	36.75	56.00	-19.25	QP	
4		2.2165	27.00	0.25	27.25	46.00	-18.75	AVG	
5		3.1744	39.10	0.28	39.38	56.00	-16.62	QP	
6 *		3.1744	30.70	0.28	30.98	46.00	-15.02	AVG	
7		4.0034	38.90	0.30	39.20	56.00	-16.80	QP	
8		4.0034	30.30	0.30	30.60	46.00	-15.40	AVG	
9		4.3826	38.40	0.31	38.71	56.00	-17.29	QP	
10		4.3826	29.80	0.31	30.11	46.00	-15.89	AVG	
11		4.9691	37.00	0.33	37.33	56.00	-18.67	QP	
12		4.9691	28.40	0.33	28.73	46.00	-17.27	AVG	

\*:Maximum data x:Over limit !:over margin ●Reference Only

File: 60012\Data: #5

Page: 1

Engineer Signature:

Unless otherwise stated the results shown in this test report refer only to the sample(s) tested and such sample(s) are retained for 90 days only.

除非另有說明，此報告結果僅對測試之樣品負責，同時此樣品僅保留90天。本報告未經本公司書面許可，不可部份複製。

This document is issued by the Company subject to its General Conditions of Service printed overleaf, available on request or accessible at [www.sgs.com/terms\\_and\\_conditions.htm](http://www.sgs.com/terms_and_conditions.htm) and, for electronic format documents, subject to Terms and Conditions for Electronic Documents at [www.sgs.com/terms\\_e-document.htm](http://www.sgs.com/terms_e-document.htm). Attention is drawn to the limitation of liability, indemnification and jurisdiction issues defined therein. Any holder of this document is advised that information contained hereon reflects the Company's findings at the time of its intervention only and within the limits of Client's instructions, if any. The Company's sole responsibility is to its Client and this document does not exonerate parties to a transaction from exercising all their rights and obligations under the transaction documents. This document cannot be reproduced except in full, without prior written approval of the Company. Any unauthorized alteration, forgery or falsification of the content or appearance of this document is unlawful and offenders may be prosecuted to the fullest extent of the law.

N



臺灣檢驗科技股份有限公司 - 電子暨通訊實驗室  
 Address : 台北縣五股工業區五工路 134 號  
 Tel:02-2299-3279 Fax:02-2298-2698

**Conducted Emission Measurement**

File :60012  
 80.0 dBuV

Data :#6

Date: 2012/7/15

Time: 下午 12:54:03

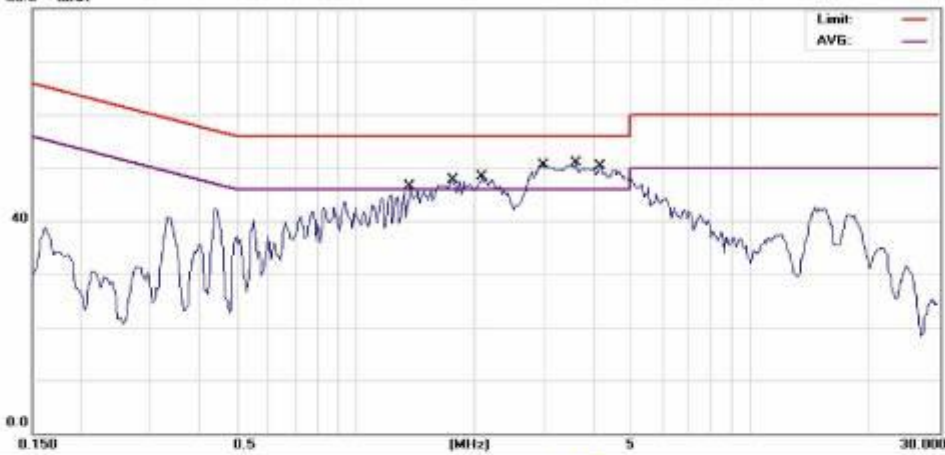

Site: ConductionRoom Phase: **N** Temperature: 25 °C  
 Limit: FCC Class B Conduction(QP) Power: AC 120V/60Hz Humidity: 60%  
 EUT: PDA Phone Distance:  
 MN: PM-0160-BV  
 Mode: Config2:Recording  
 Note:

No.	Mk.	Freq. MHz	Reading Level dBuV	Correct Factor dB	Measurement dBuV	Limit dBuV	Over dB	Detector	Comment
1		1.3719	41.90	0.31	42.21	56.00	-13.79	QP	
2		1.3719	30.00	0.31	30.31	46.00	-15.69	AVG	
3		1.7551	42.10	0.33	42.43	56.00	-13.57	QP	
4		1.7551	31.30	0.33	31.63	46.00	-14.37	AVG	
5		2.0914	42.00	0.33	42.33	56.00	-13.67	QP	
6		2.0914	31.00	0.33	31.33	46.00	-14.67	AVG	
7		2.9907	44.30	0.34	44.64	56.00	-11.36	QP	
8		2.9907	34.20	0.34	34.54	46.00	-11.46	AVG	
9		3.6045	44.20	0.35	44.55	56.00	-11.45	QP	
10	*	3.6045	34.70	0.35	35.05	46.00	-10.95	AVG	
11		4.1793	43.80	0.35	44.15	56.00	-11.85	QP	
12		4.1793	33.80	0.35	34.15	46.00	-11.85	AVG	

\*:Maximum data x:Over limit !:over margin

●Reference Only

File :60012\Data :#6

Page: 1

Engineer Signature:

Unless otherwise stated the results shown in this test report refer only to the sample(s) tested and such sample(s) are retained for 90 days only.

除非另有說明，此報告結果僅對測試之樣品負責，同時此樣品僅保留90天。本報告未經本公司書面許可，不可部份複製。

This document is issued by the Company subject to its General Conditions of Service printed overleaf, available on request or accessible at [www.sgs.com/terms\\_and\\_conditions.htm](http://www.sgs.com/terms_and_conditions.htm) and, for electronic format documents, subject to Terms and Conditions for Electronic Documents at [www.sgs.com/terms\\_e-document.htm](http://www.sgs.com/terms_e-document.htm). Attention is drawn to the limitation of liability, indemnification and jurisdiction issues defined therein. Any holder of this document is advised that information contained hereon reflects the Company's findings at the time of its intervention only and within the limits of Client's instructions, if any. The Company's sole responsibility is to its Client and this document does not exonerate parties to a transaction from exercising all their rights and obligations under the transaction documents. This document cannot be reproduced except in full, without prior written approval of the Company. Any unauthorized alteration, forgery or falsification of the content or appearance of this document is unlawful and offenders may be prosecuted to the fullest extent of the law.

## Config 2 : Play Recording L

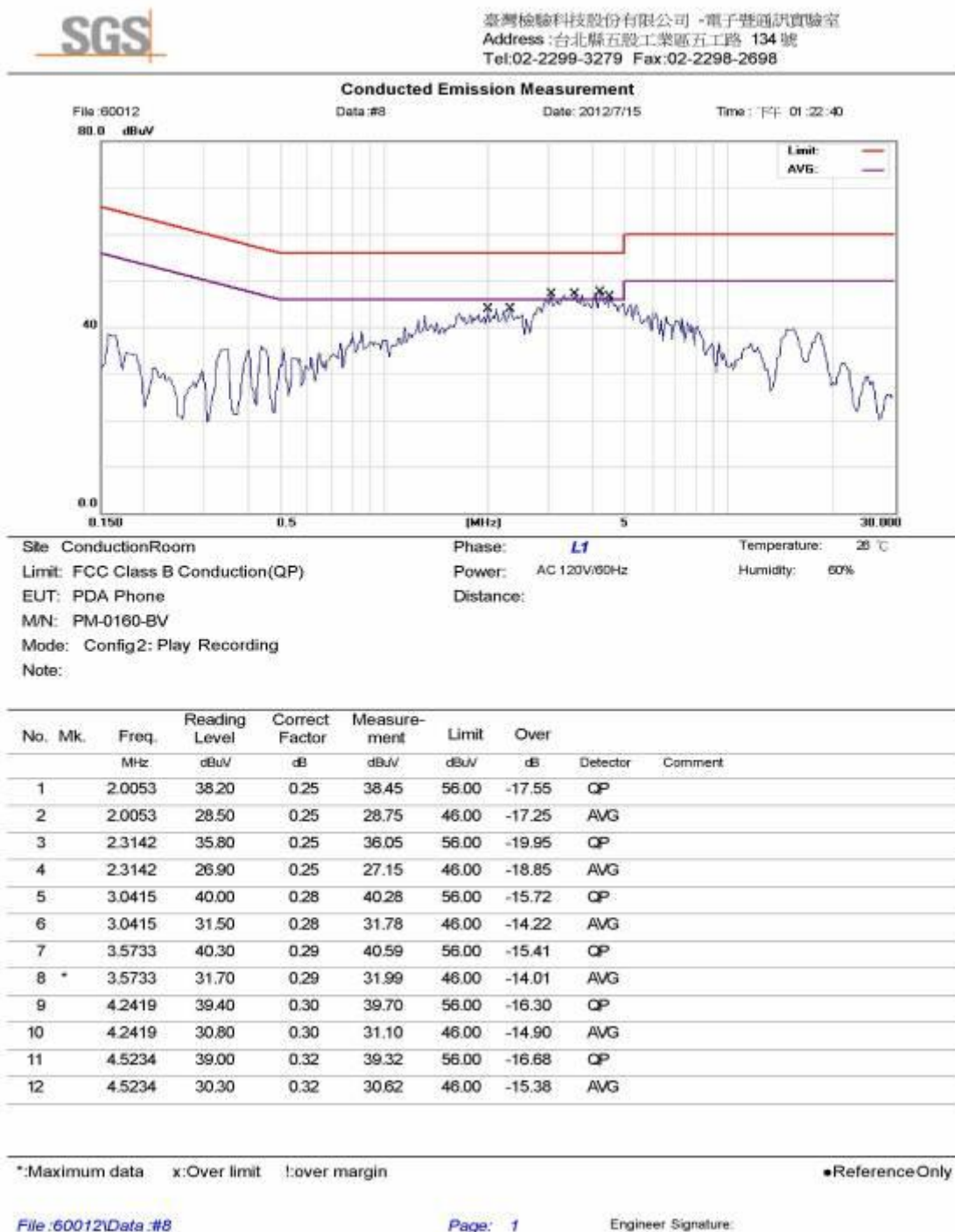

Unless otherwise stated the results shown in this test report refer only to the sample(s) tested and such sample(s) are retained for 90 days only.

除非另有說明，此報告結果僅對測試之樣品負責，同時此樣品僅保留90天。本報告未經本公司書面許可，不可部份複製。

This document is issued by the Company subject to its General Conditions of Service printed overleaf, available on request or accessible at [www.sgs.com/terms\\_and\\_conditions.htm](http://www.sgs.com/terms_and_conditions.htm) and, for electronic format documents, subject to Terms and Conditions for Electronic Documents at [www.sgs.com/terms\\_e-document.htm](http://www.sgs.com/terms_e-document.htm). Attention is drawn to the limitation of liability, indemnification and jurisdiction issues defined therein. Any holder of this document is advised that information contained hereon reflects the Company's findings at the time of its intervention only and within the limits of Client's instructions, if any. The Company's sole responsibility is to its Client and this document does not exonerate parties to a transaction from exercising all their rights and obligations under the transaction documents. This document cannot be reproduced except in full, without prior written approval of the Company. Any unauthorized alteration, forgery or falsification of the content or appearance of this document is unlawful and offenders may be prosecuted to the fullest extent of the law.

N



臺灣檢驗科技股份有限公司 - 電子電訊實驗室  
 Address : 台北縣五股工業區五工路 134 號  
 Tel:02-2299-3279 Fax:02-2298-2698

**Conducted Emission Measurement**

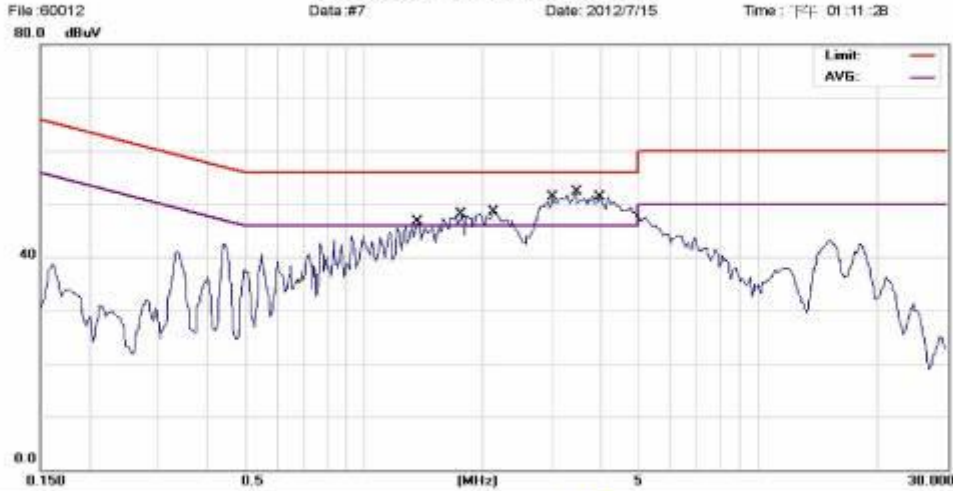

File :60012 Data :#7 Date: 2012/7/15 Time: 下午 01:11:28

Site: ConductionRoom Phase: **N** Temperature: 25 °C  
 Limit: FCC Class B Conduction(QP) Power: AC 120V/60Hz Humidity: 60%  
 EUT: PDA Phone Distance:  
 MN: PM-0160-BV  
 Mode: Config2: Play Recording  
 Note:

No.	Mk.	Freq. MHz	Reading Level dBuV	Correct Factor dB	Measure- ment dBuV	Limit dBuV	Over dB	Detector	Comment
1		1.3641	42.30	0.31	42.61	56.00	-13.39	QP	
2		1.3641	30.30	0.31	30.61	46.00	-15.39	AVG	
3		1.7668	43.00	0.33	43.33	56.00	-12.67	QP	
4		1.7668	32.60	0.33	32.93	46.00	-13.07	AVG	
5		2.1305	40.90	0.33	41.23	56.00	-14.77	QP	
6		2.1305	30.20	0.33	30.53	46.00	-15.47	AVG	
7		3.0141	44.40	0.34	44.74	56.00	-11.26	QP	
8	*	3.0141	35.40	0.34	35.74	46.00	-10.26	AVG	
9		3.4599	44.60	0.34	44.94	56.00	-11.06	QP	
10		3.4599	35.30	0.34	35.64	46.00	-10.36	AVG	
11		3.9721	44.20	0.35	44.55	56.00	-11.45	QP	
12		3.9721	34.70	0.35	35.05	46.00	-10.95	AVG	

\*:Maximum data x:Over limit !:over margin ●Reference Only

File :60012\Data :#7

Page: 1

Engineer Signature:

Unless otherwise stated the results shown in this test report refer only to the sample(s) tested and such sample(s) are retained for 90 days only.

除非另有說明，此報告結果僅對測試之樣品負責，同時此樣品僅保留90天。本報告未經本公司書面許可，不可部份複製。

This document is issued by the Company subject to its General Conditions of Service printed overleaf, available on request or accessible at [www.sgs.com/terms\\_and\\_conditions.htm](http://www.sgs.com/terms_and_conditions.htm) and, for electronic format documents, subject to Terms and Conditions for Electronic Documents at [www.sgs.com/terms\\_e-document.htm](http://www.sgs.com/terms_e-document.htm). Attention is drawn to the limitation of liability, indemnification and jurisdiction issues defined therein. Any holder of this document is advised that information contained hereon reflects the Company's findings at the time of its intervention only and within the limits of Client's instructions, if any. The Company's sole responsibility is to its Client and this document does not exonerate parties to a transaction from exercising all their rights and obligations under the transaction documents. This document cannot be reproduced except in full, without prior written approval of the Company. Any unauthorized alteration, forgery or falsification of the content or appearance of this document is unlawful and offenders may be prosecuted to the fullest extent of the law.



Config 2 : MP3  
L

SGS  
 臺灣檢驗科技股份有限公司 - 電子暨通訊實驗室  
 Address : 台北縣五股工業區五工路 134 號  
 Tel:02-2299-3279 Fax:02-2298-2698

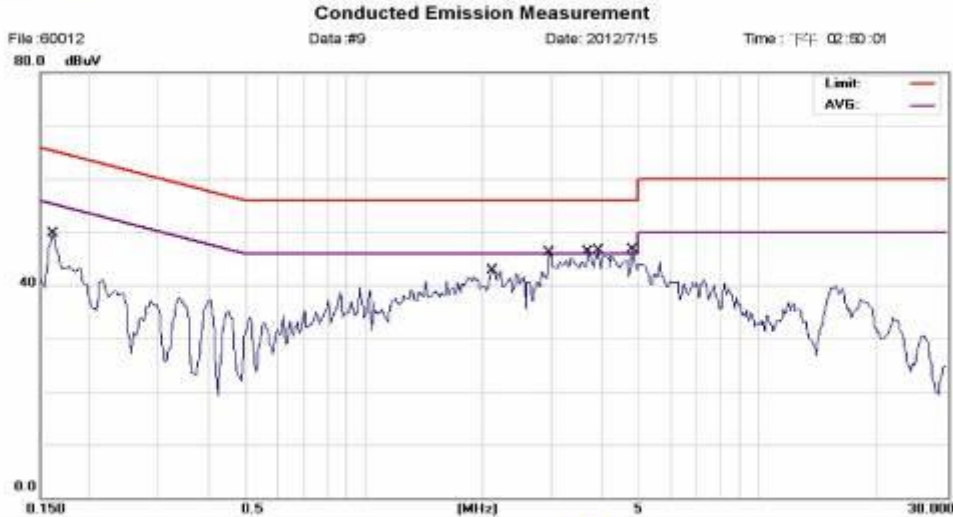

File: 60012 Data: #9 Date: 2012/7/15 Time: 下午 02:50:01  
 Site: ConductionRoom Phase: L1 Temperature: 25 °C  
 Limit: FCC Class B Conduction(QP) Power: AC 120V/60Hz Humidity: 60%  
 EUT: PDA Phone Distance:  
 MN: PM-0160-BV  
 Mode: Config 2:MP3  
 Note:

No.	Mk.	Freq. MHz	Reading Level dBuV	Correct Factor dB	Measurement dBuV	Limit dBuV	Over dB	Detector	Comment
1		0.1617	44.20	0.23	44.43	65.38	-20.95	QP	
2		0.1617	32.70	0.23	32.93	55.38	-22.45	AVG	
3		2.1148	36.60	0.25	36.85	56.00	-19.15	QP	
4		2.1148	27.50	0.25	27.75	46.00	-18.25	AVG	
5		2.9516	39.30	0.27	39.57	56.00	-16.43	QP	
6		2.9516	30.70	0.27	30.97	46.00	-15.03	AVG	
7		3.7179	39.40	0.30	39.70	56.00	-16.30	QP	
8	*	3.7179	31.00	0.30	31.30	46.00	-14.70	AVG	
9		3.9291	39.50	0.30	39.80	56.00	-16.20	QP	
10		3.9291	30.90	0.30	31.20	46.00	-14.80	AVG	
11		4.8088	37.60	0.32	37.92	56.00	-18.08	QP	
12		4.8088	29.10	0.32	29.42	46.00	-16.58	AVG	

\*:Maximum data x:Over limit !:over margin •Reference Only

File: 60012\Data: #9

Page: 1

Engineer Signature:

Unless otherwise stated the results shown in this test report refer only to the sample(s) tested and such sample(s) are retained for 90 days only.

除非另有說明，此報告結果僅對測試之樣品負責，同時此樣品僅保留90天。本報告未經本公司書面許可，不可部份複製。

This document is issued by the Company subject to its General Conditions of Service printed overleaf, available on request or accessible at [www.sgs.com/terms\\_and\\_conditions.htm](http://www.sgs.com/terms_and_conditions.htm) and, for electronic format documents, subject to Terms and Conditions for Electronic Documents at [www.sgs.com/terms\\_e-document.htm](http://www.sgs.com/terms_e-document.htm). Attention is drawn to the limitation of liability, indemnification and jurisdiction issues defined therein. Any holder of this document is advised that information contained hereon reflects the Company's findings at the time of its intervention only and within the limits of Client's instructions, if any. The Company's sole responsibility is to its Client and this document does not exonerate parties to a transaction from exercising all their rights and obligations under the transaction documents. This document cannot be reproduced except in full, without prior written approval of the Company. Any unauthorized alteration, forgery or falsification of the content or appearance of this document is unlawful and offenders may be prosecuted to the fullest extent of the law.

N



臺灣檢驗科技股份有限公司 - 電子電訊實驗室  
 Address : 台北縣五股工業區五工路 134 號  
 Tel:02-2299-3279 Fax:02-2298-2698

### Conducted Emission Measurement

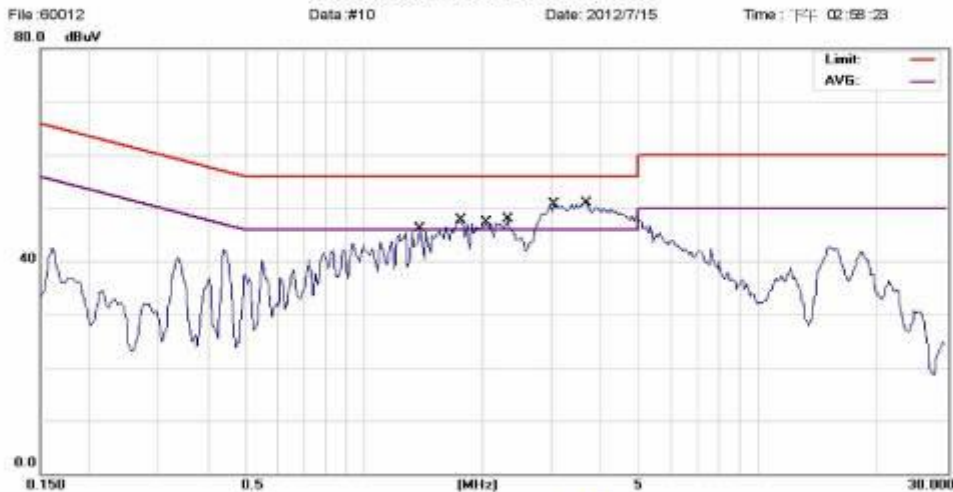

File :60012 Data #10 Date: 2012/7/15 Time: 下午 02:58:23

Site: ConductionRoom Phase: **N** Temperature: 25 °C  
 Limit: FCC Class B Conduction(QP) Power: AC 120V/60Hz Humidity: 60%  
 EUT: PDA Phone Distance:  
 MN: PM-0160-BV  
 Mode: Config 2:MP3  
 Note:

No.	Mk.	Freq.	Reading Level	Correct Factor	Measurement	Limit	Over	Detector	Comment
		MHz	dBuV	dB	dBuV	dBuV	dB		
1		1.3837	41.90	0.31	42.21	56.00	-13.79	QP	
2		1.3837	29.80	0.31	30.11	46.00	-15.89	AVG	
3		1.7590	42.80	0.33	43.13	56.00	-12.87	QP	
4		1.7590	32.10	0.33	32.43	46.00	-13.57	AVG	
5		2.0405	42.10	0.33	42.43	56.00	-13.57	QP	
6		2.0405	31.30	0.33	31.63	46.00	-14.37	AVG	
7		2.3182	41.30	0.33	41.63	56.00	-14.37	QP	
8		2.3182	30.40	0.33	30.73	46.00	-15.27	AVG	
9		3.0337	44.80	0.34	45.14	56.00	-10.86	QP	
10	*	3.0337	35.30	0.34	35.64	46.00	-10.36	AVG	
11		3.6632	44.30	0.35	44.65	56.00	-11.35	QP	
12		3.6632	35.00	0.35	35.35	46.00	-10.65	AVG	

\*:Maximum data x:Over limit !:over margin ●Reference Only

File :60012\Data :#10

Page: 1

Engineer Signature:

Unless otherwise stated the results shown in this test report refer only to the sample(s) tested and such sample(s) are retained for 90 days only.

除非另有說明，此報告結果僅對測試之樣品負責，同時此樣品僅保留90天。本報告未經本公司書面許可，不可部份複製。

This document is issued by the Company subject to its General Conditions of Service printed overleaf, available on request or accessible at [www.sgs.com/terms\\_and\\_conditions.htm](http://www.sgs.com/terms_and_conditions.htm) and, for electronic format documents, subject to Terms and Conditions for Electronic Documents at [www.sgs.com/terms\\_e-document.htm](http://www.sgs.com/terms_e-document.htm). Attention is drawn to the limitation of liability, indemnification and jurisdiction issues defined therein. Any holder of this document is advised that information contained hereon reflects the Company's findings at the time of its intervention only and within the limits of Client's instructions, if any. The Company's sole responsibility is to its Client and this document does not exonerate parties to a transaction from exercising all their rights and obligations under the transaction documents. This document cannot be reproduced except in full, without prior written approval of the Company. Any unauthorized alteration, forgery or falsification of the content or appearance of this document is unlawful and offenders may be prosecuted to the fullest extent of the law.

Config 3 : FM 87.6

L

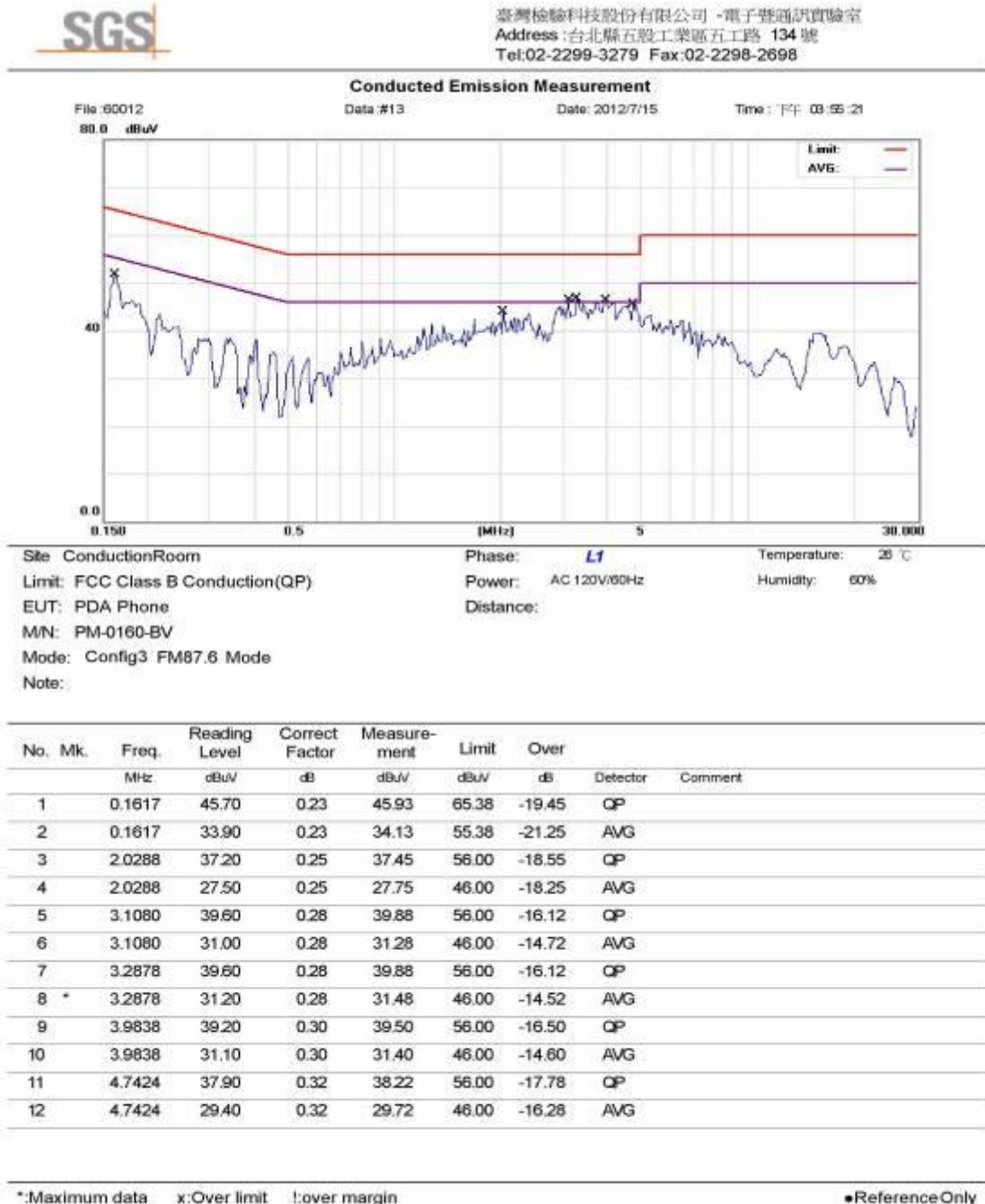

File: 60012\Data: #13

Page: 1

Engineer Signature:

Unless otherwise stated the results shown in this test report refer only to the sample(s) tested and such sample(s) are retained for 90 days only.

除非另有說明，此報告結果僅對測試之樣品負責，同時此樣品僅保留90天。本報告未經本公司書面許可，不可部份複製。

This document is issued by the Company subject to its General Conditions of Service printed overleaf, available on request or accessible at [www.sgs.com/terms\\_and\\_conditions.htm](http://www.sgs.com/terms_and_conditions.htm) and, for electronic format documents, subject to Terms and Conditions for Electronic Documents at [www.sgs.com/terms\\_e-document.htm](http://www.sgs.com/terms_e-document.htm). Attention is drawn to the limitation of liability, indemnification and jurisdiction issues defined therein. Any holder of this document is advised that information contained hereon reflects the Company's findings at the time of its intervention only and within the limits of Client's instructions, if any. The Company's sole responsibility is to its Client and this document does not exonerate parties to a transaction from exercising all their rights and obligations under the transaction documents. This document cannot be reproduced except in full, without prior written approval of the Company. Any unauthorized alteration, forgery or falsification of the content or appearance of this document is unlawful and offenders may be prosecuted to the fullest extent of the law.



N



臺灣檢驗科技股份有限公司 - 電子電訊實驗室  
 Address : 台北縣五股工業區五工路 134 號  
 Tel:02-2299-3279 Fax:02-2298-2698

**Conducted Emission Measurement**

File :60012  
 80.0 dBuV

Data #14

Date: 2012/7/15

Time: 下午 04:04:46

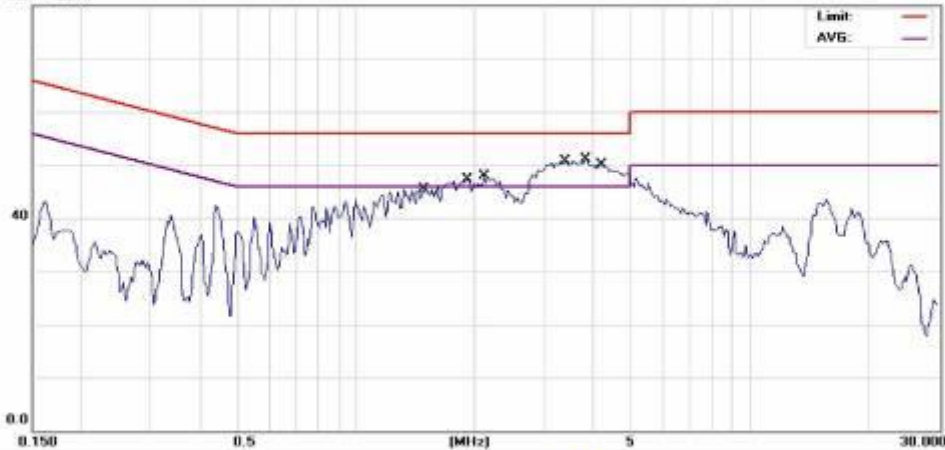

Site: ConductionRoom Phase: **N** Temperature: 25 °C  
 Limit: FCC Class B Conduction(QP) Power: AC 120V/60Hz Humidity: 60%  
 EUT: PDA Phone Distance:  
 MN: PM-0160-BV  
 Mode: Config3 FM87.6 Mode  
 Note:

No.	Mk.	Freq. MHz	Reading Level dBuV	Correct Factor dB	Measure- ment dBuV	Limit dBuV	Over dB	Detector	Comment
1		1.4892	40.70	0.31	41.01	56.00	-14.99	QP	
2		1.4892	30.10	0.31	30.41	46.00	-15.59	AVG	
3		1.9232	40.70	0.33	41.03	56.00	-14.97	QP	
4		1.9232	30.70	0.33	31.03	46.00	-14.97	AVG	
5		2.1187	41.80	0.33	42.13	56.00	-13.87	QP	
6		2.1187	31.90	0.33	32.23	46.00	-13.77	AVG	
7		3.4051	44.50	0.34	44.84	56.00	-11.16	QP	
8	*	3.4051	34.90	0.34	35.24	46.00	-10.76	AVG	
9		3.8391	44.20	0.35	44.55	56.00	-11.45	QP	
10		3.8391	34.70	0.35	35.05	46.00	-10.95	AVG	
11		4.1832	43.60	0.35	43.95	56.00	-12.05	QP	
12		4.1832	34.20	0.35	34.55	46.00	-11.45	AVG	

\*:Maximum data x:Over limit !:over margin #Reference Only

File :60012\Data :#14

Page: 1

Engineer Signature:

Unless otherwise stated the results shown in this test report refer only to the sample(s) tested and such sample(s) are retained for 90 days only.

除非另有說明，此報告結果僅對測試之樣品負責，同時此樣品僅保留90天。本報告未經本公司書面許可，不可部份複製。

This document is issued by the Company subject to its General Conditions of Service printed overleaf, available on request or accessible at [www.sgs.com/terms\\_and\\_conditions.htm](http://www.sgs.com/terms_and_conditions.htm) and, for electronic format documents, subject to Terms and Conditions for Electronic Documents at [www.sgs.com/terms\\_e-document.htm](http://www.sgs.com/terms_e-document.htm). Attention is drawn to the limitation of liability, indemnification and jurisdiction issues defined therein. Any holder of this document is advised that information contained hereon reflects the Company's findings at the time of its intervention only and within the limits of Client's instructions, if any. The Company's sole responsibility is to its Client and this document does not exonerate parties to a transaction from exercising all their rights and obligations under the transaction documents. This document cannot be reproduced except in full, without prior written approval of the Company. Any unauthorized alteration, forgery or falsification of the content or appearance of this document is unlawful and offenders may be prosecuted to the fullest extent of the law.

Config 3 : FM 98

L

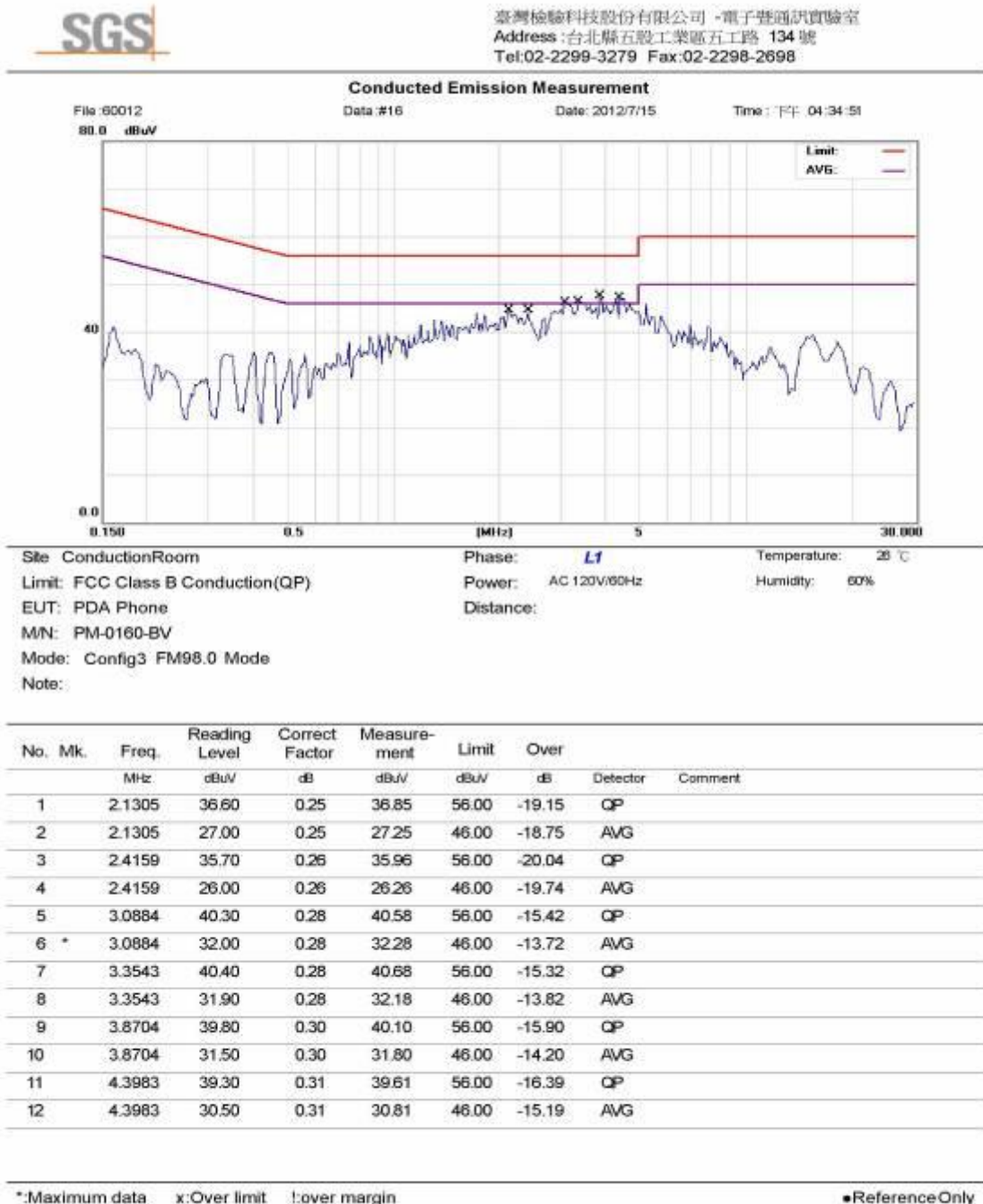

File: 60012\Data: #16

Page: 1

Engineer Signature:

Unless otherwise stated the results shown in this test report refer only to the sample(s) tested and such sample(s) are retained for 90 days only.

除非另有說明，此報告結果僅對測試之樣品負責，同時此樣品僅保留90天。本報告未經本公司書面許可，不可部份複製。

This document is issued by the Company subject to its General Conditions of Service printed overleaf, available on request or accessible at [www.sgs.com/terms\\_and\\_conditions.htm](http://www.sgs.com/terms_and_conditions.htm) and, for electronic format documents, subject to Terms and Conditions for Electronic Documents at [www.sgs.com/terms\\_e-document.htm](http://www.sgs.com/terms_e-document.htm). Attention is drawn to the limitation of liability, indemnification and jurisdiction issues defined therein. Any holder of this document is advised that information contained hereon reflects the Company's findings at the time of its intervention only and within the limits of Client's instructions, if any. The Company's sole responsibility is to its Client and this document does not exonerate parties to a transaction from exercising all their rights and obligations under the transaction documents. This document cannot be reproduced except in full, without prior written approval of the Company. Any unauthorized alteration, forgery or falsification of the content or appearance of this document is unlawful and offenders may be prosecuted to the fullest extent of the law.

N



臺灣檢驗科技股份有限公司 - 電子暨通訊實驗室  
 Address : 台北縣五股工業區五工路 134 號  
 Tel:02-2299-3279 Fax:02-2298-2698

**Conducted Emission Measurement**

File :60012 Data #15 Date: 2012/7/15 Time : 下午 04:25:54

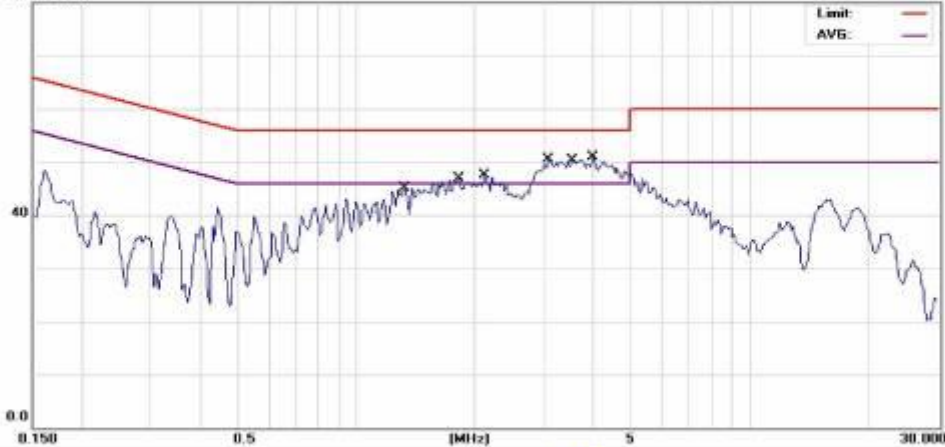

Site: ConductionRoom Phase: **N** Temperature: 25 °C  
 Limit: FCC Class B Conduction(QP) Power: AC 120V/60Hz Humidity: 60%  
 EUT: PDA Phone Distance:  
 MN: PM-0160-BV  
 Mode: Config3 FM98.0 Mode  
 Note:

No.	Mk.	Freq. MHz	Reading Level dBuV	Correct Factor dB	Measure- ment dBuV	Limit dBuV	Over dB	Detector	Comment
1		1.3289	41.90	0.31	42.21	56.00	-13.79	QP	
2		1.3289	29.10	0.31	29.41	46.00	-16.59	AVG	
3		1.8216	42.10	0.33	42.43	56.00	-13.57	QP	
4		1.8216	31.80	0.33	32.13	46.00	-13.87	AVG	
5		2.1187	41.50	0.33	41.83	56.00	-14.17	QP	
6		2.1187	31.40	0.33	31.73	46.00	-14.27	AVG	
7		3.0845	44.30	0.34	44.64	56.00	-11.36	QP	
8		3.0845	34.70	0.34	35.04	46.00	-10.96	AVG	
9		3.5381	44.50	0.35	44.85	56.00	-11.15	QP	
10	*	3.5381	34.90	0.35	35.25	46.00	-10.75	AVG	
11		4.0034	43.60	0.35	43.95	56.00	-12.05	QP	
12		4.0034	34.30	0.35	34.65	46.00	-11.35	AVG	

\*:Maximum data x:Over limit !:over margin #Reference Only

File :60012>Data :#15

Page: 1

Engineer Signature:

Unless otherwise stated the results shown in this test report refer only to the sample(s) tested and such sample(s) are retained for 90 days only.

除非另有說明，此報告結果僅對測試之樣品負責，同時此樣品僅保留90天。本報告未經本公司書面許可，不可部份複製。

This document is issued by the Company subject to its General Conditions of Service printed overleaf, available on request or accessible at [www.sgs.com/terms\\_and\\_conditions.htm](http://www.sgs.com/terms_and_conditions.htm) and, for electronic format documents, subject to Terms and Conditions for Electronic Documents at [www.sgs.com/terms\\_e-document.htm](http://www.sgs.com/terms_e-document.htm). Attention is drawn to the limitation of liability, indemnification and jurisdiction issues defined therein. Any holder of this document is advised that information contained hereon reflects the Company's findings at the time of its intervention only and within the limits of Client's instructions, if any. The Company's sole responsibility is to its Client and this document does not exonerate parties to a transaction from exercising all their rights and obligations under the transaction documents. This document cannot be reproduced except in full, without prior written approval of the Company. Any unauthorized alteration, forgery or falsification of the content or appearance of this document is unlawful and offenders may be prosecuted to the fullest extent of the law.

Config 3 : FM 107.9

L

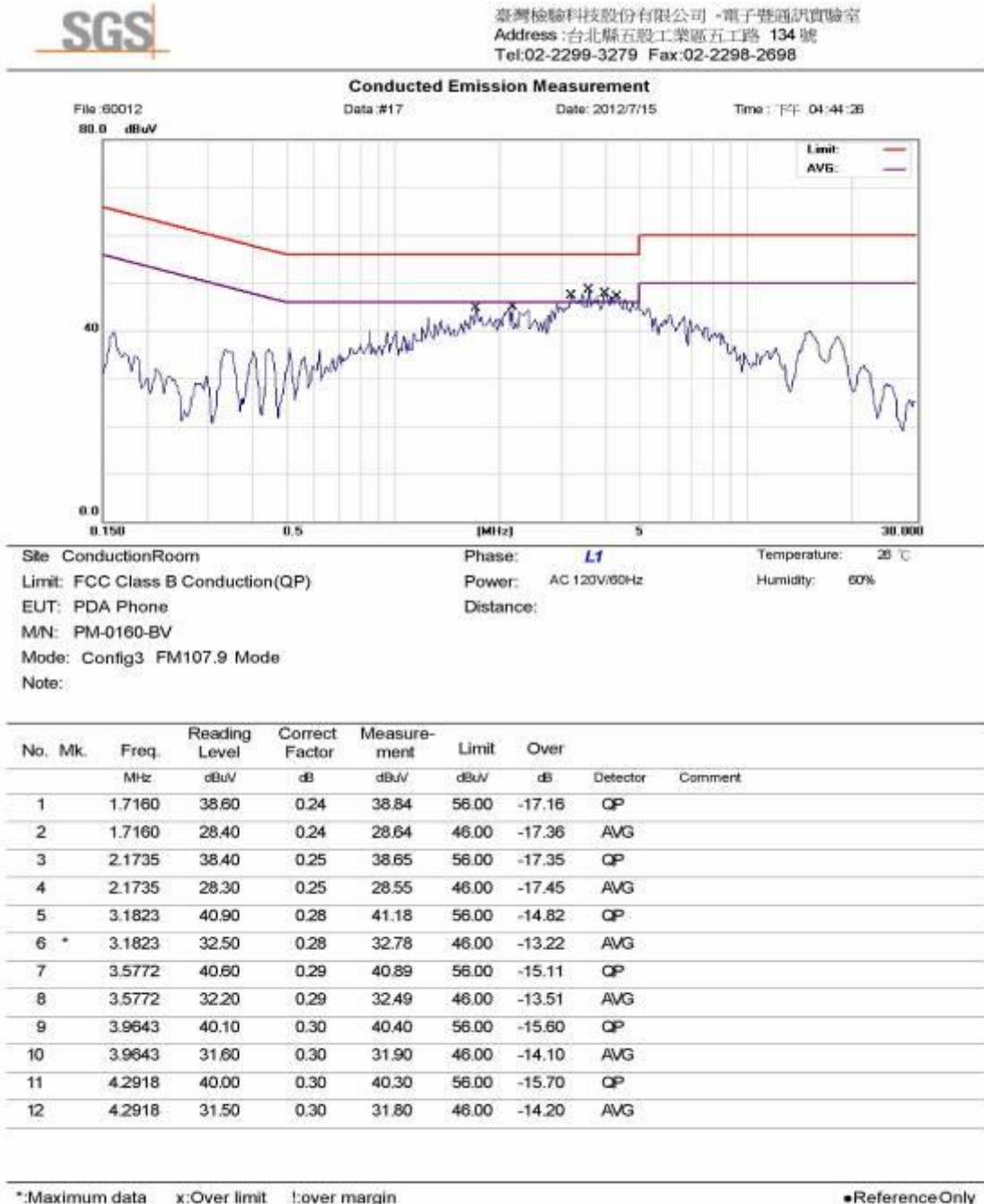

File: 60012\Data: #17

Page: 1

Engineer Signature:

Unless otherwise stated the results shown in this test report refer only to the sample(s) tested and such sample(s) are retained for 90 days only.

除非另有說明，此報告結果僅對測試之樣品負責，同時此樣品僅保留90天。本報告未經本公司書面許可，不可部份複製。

This document is issued by the Company subject to its General Conditions of Service printed overleaf, available on request or accessible at [www.sgs.com/terms\\_and\\_conditions.htm](http://www.sgs.com/terms_and_conditions.htm) and, for electronic format documents, subject to Terms and Conditions for Electronic Documents at [www.sgs.com/terms\\_e-document.htm](http://www.sgs.com/terms_e-document.htm). Attention is drawn to the limitation of liability, indemnification and jurisdiction issues defined therein. Any holder of this document is advised that information contained hereon reflects the Company's findings at the time of its intervention only and within the limits of Client's instructions, if any. The Company's sole responsibility is to its Client and this document does not exonerate parties to a transaction from exercising all their rights and obligations under the transaction documents. This document cannot be reproduced except in full, without prior written approval of the Company. Any unauthorized alteration, forgery or falsification of the content or appearance of this document is unlawful and offenders may be prosecuted to the fullest extent of the law.



N



臺灣檢驗科技股份有限公司 - 電子暨通訊實驗室  
 Address : 台北縣五股工業區五工路 134 號  
 Tel:02-2299-3279 Fax:02-2298-2698

**Conducted Emission Measurement**

File :60012 Data #18 Date: 2012/7/15 Time : 下午 05:00:55

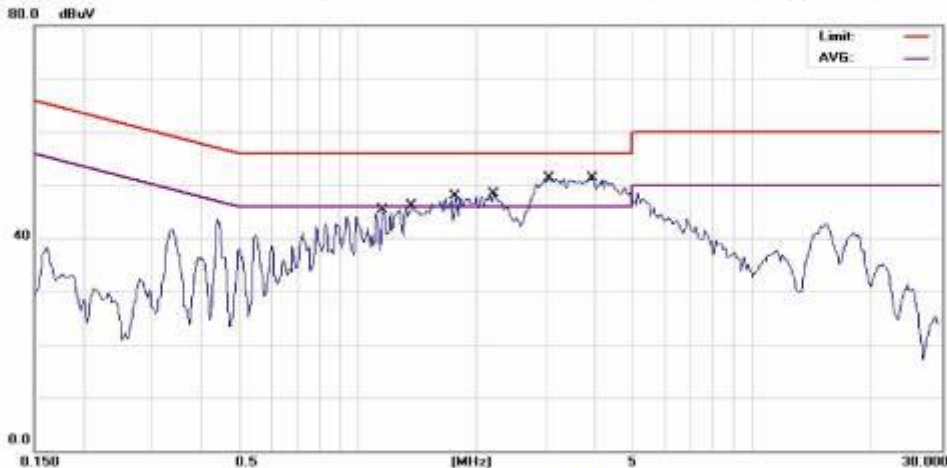

Site: ConductionRoom Phase: **N** Temperature: 25 °C  
 Limit: FCC Class B Conduction(QP) Power: AC 120V/60Hz Humidity: 60%  
 EUT: PDA Phone Distance:  
 MN: PM-0160-BV  
 Mode: Config3 FM107.9 Mode  
 Note:

No.	Mk.	Freq. MHz	Reading Level dBuV	Correct Factor dB	Measure- ment dBuV	Limit dBuV	Over dB	Detector	Comment
1		1.1589	41.20	0.31	41.51	56.00	-14.49	QP	
2		1.1589	28.90	0.31	29.21	46.00	-16.79	AVG	
3		1.3719	42.50	0.31	42.81	56.00	-13.19	QP	
4		1.3719	29.60	0.31	29.91	46.00	-16.09	AVG	
5		1.7668	42.60	0.33	42.93	56.00	-13.07	QP	
6		1.7668	31.30	0.33	31.63	46.00	-14.37	AVG	
7		2.2126	42.40	0.33	42.73	56.00	-13.27	QP	
8		2.2126	31.90	0.33	32.23	46.00	-13.77	AVG	
9		3.0571	45.00	0.34	45.34	56.00	-10.66	QP	
10	*	3.0571	35.70	0.34	36.04	46.00	-9.96	AVG	
11		3.9252	44.30	0.35	44.65	56.00	-11.35	QP	
12		3.9252	34.70	0.35	35.05	46.00	-10.95	AVG	

\*:Maximum data x:Over limit !:over margin #Reference Only

File :60012>Data :#18

Page: 1

Engineer Signature:

Unless otherwise stated the results shown in this test report refer only to the sample(s) tested and such sample(s) are retained for 90 days only.

除非另有說明，此報告結果僅對測試之樣品負責，同時此樣品僅保留90天。本報告未經本公司書面許可，不可部份複製。

This document is issued by the Company subject to its General Conditions of Service printed overleaf, available on request or accessible at [www.sgs.com/terms\\_and\\_conditions.htm](http://www.sgs.com/terms_and_conditions.htm) and, for electronic format documents, subject to Terms and Conditions for Electronic Documents at [www.sgs.com/terms\\_e-document.htm](http://www.sgs.com/terms_e-document.htm). Attention is drawn to the limitation of liability, indemnification and jurisdiction issues defined therein. Any holder of this document is advised that information contained hereon reflects the Company's findings at the time of its intervention only and within the limits of Client's instructions, if any. The Company's sole responsibility is to its Client and this document does not exonerate parties to a transaction from exercising all their rights and obligations under the transaction documents. This document cannot be reproduced except in full, without prior written approval of the Company. Any unauthorized alteration, forgery or falsification of the content or appearance of this document is unlawful and offenders may be prosecuted to the fullest extent of the law.

## 2.5 Test of Radiated Emission

### 2.5.1 Test Instruments

Below 1G

Description	Manufacturer	Model No.	Serial No.	Last Calibration Date	Next Calibration Date
Site NSA	TDK	966 Chamber	N/A	Nov. 06, 2011	Nov. 05, 2012
EMI Test Receiver	ROHDE&SCHWARZ	ESCI 7	1166.5950K07-100760-GK	May 25, 2012	May 24, 2013
Spectrum Analyzer	Agilent	E4440A	MY45304525	Mar. 17, 2012	Mar. 16, 2014
Broadband Antenna	SCHWAZBECK	VULB9160	9160-3136	Dec. 28, 2011	Dec. 27, 2012
RF-Amplifier	HP	8447D	2944A09469	Nov. 26, 2011	Nov. 25, 2012
Antenna Master	HD GmbH	MA240-N	240/657	N/A	N/A
Turn Table	HD GmbH	DS420	420/542	N/A	N/A
Controller	HD GmbH	HD 100	100/803	N/A	N/A
CCD Video Camera System	N/A	VCS-04	N/A	N/A	N/A
Color Monitor	Lenovo	16dcpw5-1	N/A	N/A	N/A
Software	Farad	EZ-EMC-VER2A1.1(USB)	N/A	N/A	N/A

Unless otherwise stated the results shown in this test report refer only to the sample(s) tested and such sample(s) are retained for 90 days only.

除非另有說明，此報告結果僅對測試之樣品負責，同時此樣品僅保留90天。本報告未經本公司書面許可，不可部份複製。

This document is issued by the Company subject to its General Conditions of Service printed overleaf, available on request or accessible at [www.sgs.com/terms\\_and\\_conditions.htm](http://www.sgs.com/terms_and_conditions.htm) and, for electronic format documents, subject to Terms and Conditions for Electronic Documents at [www.sgs.com/terms\\_e-document.htm](http://www.sgs.com/terms_e-document.htm). Attention is drawn to the limitation of liability, indemnification and jurisdiction issues defined therein. Any holder of this document is advised that information contained hereon reflects the Company's findings at the time of its intervention only and within the limits of Client's instructions, if any. The Company's sole responsibility is to its Client and this document does not exonerate parties to a transaction from exercising all their rights and obligations under the transaction documents. This document cannot be reproduced except in full, without prior written approval of the Company. Any unauthorized alteration, forgery or falsification of the content or appearance of this document is unlawful and offenders may be prosecuted to the fullest extent of the law.

Above 1G

Description	Manufacturer	Model No.	Serial No.	Last Calibration Date	Next Calibration Date
Site NSA	Chamost	966II Chamber	N/A	Dec. 30, 2011	Dec. 29, 2012
Site VSWR	Chamost	966II Chamber	N/A	Dec. 30, 2011	Dec. 29, 2012
EMI Test Receiver	ROHDE&SCHWARZ	ESCI 7	1166.5950K07 -100760-GK	May 25, 2012	May 24, 2013
Spectrum Analyzer	Agilent	E4440A	MY45304525	Mar. 17, 2012	Mar. 16, 2014
RF-Amplifier (0.1-1300MHz)	HP	8447D	1937A02774	Nov. 26, 2011	Nov. 25, 2012
RF-Amplifier (1-26.5GHz)	HP	8449B	3008A00578	Dec. 27, 2011	Dec. 26, 2012
RF-Amplifier (26-40GHz)	EM Electronics Corp.	EM26400	N/A	Dec. 28, 2011	Dec. 27, 2012
Coaxial Cables (For 9kHz~26.5GHz)	SUCOFLEX	104PEA	N/A	Dec. 28, 2011	Dec. 27, 2012
Re Cables (966II) (For 1~40GHz)	HUBER SUHNER	SUCCOFLEX 102	22962/2	Dec. 28, 2011	Dec. 27, 2012
Re Cables (966II) (For 1~40GHz)	HUBER SUHNER	SUCCOFLEX 102	23051/2	Dec. 28, 2011	Dec. 27, 2012
Antenna Master	MF.	N/A	N/A	N/A	N/A
Turn Table	MF.	N/A	N/A	N/A	N/A
Controller	MF.	3000	MF780208153	N/A	N/A
Antenna	SCHWAZBECK	VULB9160	3068	Nov. 01, 2011	Oct. 31, 2012
Horn Antenna (For 1~18G )	ETS-Lindgren	3117	00135200	Oct. 06, 2011	Oct. 05, 2012
Horn Antenna (For 18~40G )	SCHWAZBECK	BBHA 9170	BBHA9170185	Jul. 11, 2011	Jul. 10, 2013
Software	Farad	EZ-EMC-VER2A1.1(USB)	N/A	N/A	N/A

2.5.2 Test Site

SGS Taiwan LTD. Electronics & Communication Laboratory  
 No.134, Wu Kung Road. Wuku Industrial Zone, Taipei County 248, Taiwan (R.O.C.)

Unless otherwise stated the results shown in this test report refer only to the sample(s) tested and such sample(s) are retained for 90 days only.

除非另有說明，此報告結果僅對測試之樣品負責，同時此樣品僅保留90天。本報告未經本公司書面許可，不可部份複製。

This document is issued by the Company subject to its General Conditions of Service printed overleaf, available on request or accessible at [www.sgs.com/terms\\_and\\_conditions.htm](http://www.sgs.com/terms_and_conditions.htm) and, for electronic format documents, subject to Terms and Conditions for Electronic Documents at [www.sgs.com/terms\\_e-document.htm](http://www.sgs.com/terms_e-document.htm). Attention is drawn to the limitation of liability, indemnification and jurisdiction issues defined therein. Any holder of this document is advised that information contained hereon reflects the Company's findings at the time of its intervention only and within the limits of Client's instructions, if any. The Company's sole responsibility is to its Client and this document does not exonerate parties to a transaction from exercising all their rights and obligations under the transaction documents. This document cannot be reproduced except in full, without prior written approval of the Company. Any unauthorized alteration, forgery or falsification of the content or appearance of this document is unlawful and offenders may be prosecuted to the fullest extent of the law.



### 2.5.3 Operating Environment

Temperature : 25 degree C      Humidity : 60 %RH  
Atmospheric Pressure : 996 mBar

### 2.5.4 Uncertainty of Radiated Emission

Expanded uncertainty (k=2) of radiated emission measurement is 3.70dB.(Below 1G)  
Expanded uncertainty (k=2) of radiated emission measurement is 5.63dB.(Above 1G)

### 2.5.5 Measurement level and Factor calculate method

Factor = Antenna loss + Cable loss + Amplifier Compensate  
Measurement Level = Reading Level + Factor

Unless otherwise stated the results shown in this test report refer only to the sample(s) tested and such sample(s) are retained for 90 days only.

除非另有說明，此報告結果僅對測試之樣品負責，同時此樣品僅保留90天。本報告未經本公司書面許可，不可部份複製。

This document is issued by the Company subject to its General Conditions of Service printed overleaf, available on request or accessible at [www.sgs.com/terms\\_and\\_conditions.htm](http://www.sgs.com/terms_and_conditions.htm) and, for electronic format documents, subject to Terms and Conditions for Electronic Documents at [www.sgs.com/terms\\_e-document.htm](http://www.sgs.com/terms_e-document.htm). Attention is drawn to the limitation of liability, indemnification and jurisdiction issues defined therein. Any holder of this document is advised that information contained hereon reflects the Company's findings at the time of its intervention only and within the limits of Client's instructions, if any. The Company's sole responsibility is to its Client and this document does not exonerate parties to a transaction from exercising all their rights and obligations under the transaction documents. This document cannot be reproduced except in full, without prior written approval of the Company. Any unauthorized alteration, forgery or falsification of the content or appearance of this document is unlawful and offenders may be prosecuted to the fullest extent of the law.

## 2.5.6 Measurement Data

Below 1G

Config 1 : Data Link  
H

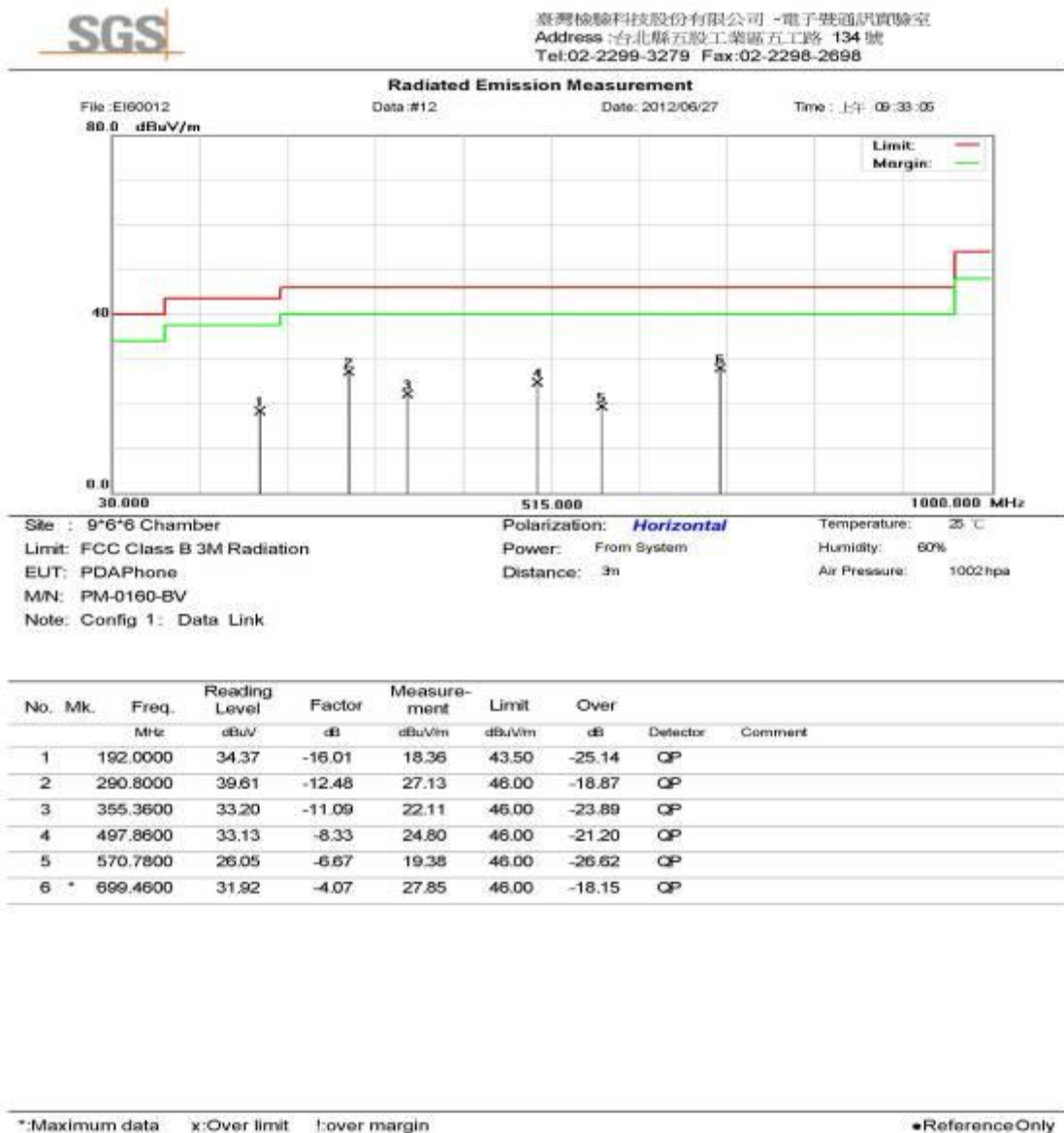

File: EI60012>Data: #12

Page: 1

Engineer Signature:

Unless otherwise stated the results shown in this test report refer only to the sample(s) tested and such sample(s) are retained for 90 days only.

除非另有說明，此報告結果僅對測試之樣品負責，同時此樣品僅保留90天。本報告未經本公司書面許可，不可部份複製。

This document is issued by the Company subject to its General Conditions of Service printed overleaf, available on request or accessible at [www.sgs.com/terms\\_and\\_conditions.htm](http://www.sgs.com/terms_and_conditions.htm) and, for electronic format documents, subject to Terms and Conditions for Electronic Documents at [www.sgs.com/terms\\_e-document.htm](http://www.sgs.com/terms_e-document.htm). Attention is drawn to the limitation of liability, indemnification and jurisdiction issues defined therein. Any holder of this document is advised that information contained hereon reflects the Company's findings at the time of its intervention only and within the limits of Client's instructions, if any. The Company's sole responsibility is to its Client and this document does not exonerate parties to a transaction from exercising all their rights and obligations under the transaction documents. This document cannot be reproduced except in full, without prior written approval of the Company. Any unauthorized alteration, forgery or falsification of the content or appearance of this document is unlawful and offenders may be prosecuted to the fullest extent of the law.

V



臺灣檢驗科技股份有限公司 - 電子電訊實驗室  
 Address : 台北縣五股工業區五工路 134 號  
 Tel:02-2299-3279 Fax:02-2298-2698

**Radiated Emission Measurement**

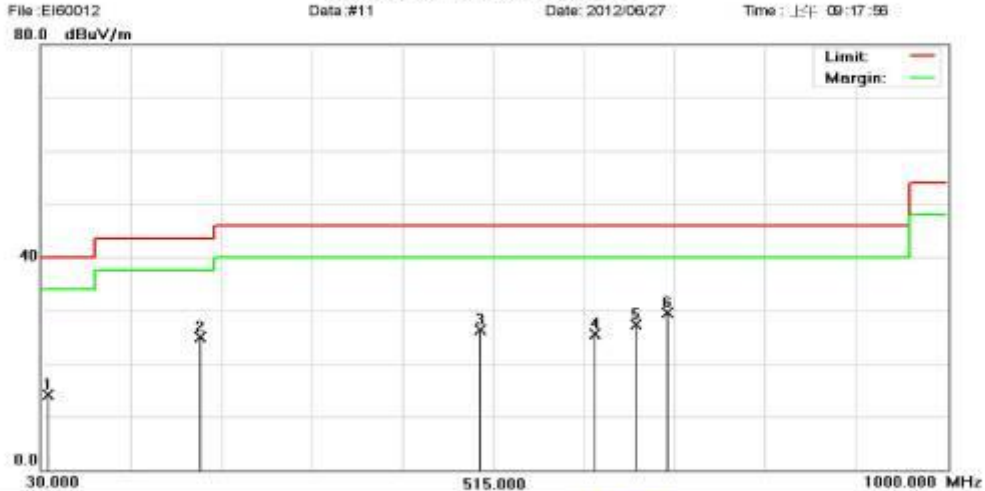

File: EI60012 Data: #11 Date: 2012/06/27 Time: 上午 09:17:56  
 Site : 9\*6\*6 Chamber Polarization: **Vertical** Temperature: 25 °C  
 Limit: FCC Class B 3M Radiation Power: From System Humidity: 60%  
 EUT: PDAPhone Distance: 3m Air Pressure: 1002 hpa  
 MN: PM-0160-BV  
 Note: Config 1: Data Link

No.	Mk.	Freq. MHz	Reading Level dBuV	Factor dB	Measurement dBuV/m	Limit dBuV/m	Over dB	Detector	Comment
1		35.9400	30.98	-16.89	14.09	40.00	-25.91	QP	
2		199.8400	41.19	-16.35	24.84	43.50	-18.66	QP	
3		499.6400	34.70	-8.32	26.38	46.00	-19.62	QP	
4		622.1000	31.45	-5.85	25.60	46.00	-20.40	QP	
5		666.6000	31.58	-4.21	27.37	46.00	-18.63	QP	
6	*	699.6000	33.56	-4.07	29.49	46.00	-16.51	QP	

\*:Maximum data x:Over limit !:over margin

●Reference Only

File: EI60012>Data: #11

Page: 1

Engineer Signature:

Unless otherwise stated the results shown in this test report refer only to the sample(s) tested and such sample(s) are retained for 90 days only.

除非另有說明，此報告結果僅對測試之樣品負責，同時此樣品僅保留90天。本報告未經本公司書面許可，不可部份複製。

This document is issued by the Company subject to its General Conditions of Service printed overleaf, available on request or accessible at [www.sgs.com/terms\\_and\\_conditions.htm](http://www.sgs.com/terms_and_conditions.htm) and, for electronic format documents, subject to Terms and Conditions for Electronic Documents at [www.sgs.com/terms\\_e-document.htm](http://www.sgs.com/terms_e-document.htm). Attention is drawn to the limitation of liability, indemnification and jurisdiction issues defined therein. Any holder of this document is advised that information contained hereon reflects the Company's findings at the time of its intervention only and within the limits of Client's instructions, if any. The Company's sole responsibility is to its Client and this document does not exonerate parties to a transaction from exercising all their rights and obligations under the transaction documents. This document cannot be reproduced except in full, without prior written approval of the Company. Any unauthorized alteration, forgery or falsification of the content or appearance of this document is unlawful and offenders may be prosecuted to the fullest extent of the law.

**Config 2 : Recording  
H**

SGS  
 臺灣檢驗科技股份有限公司 - 電子電訊實驗室  
 Address : 台北縣五股工業區五工路 134 號  
 Tel:02-2299-3279 Fax:02-2298-2698

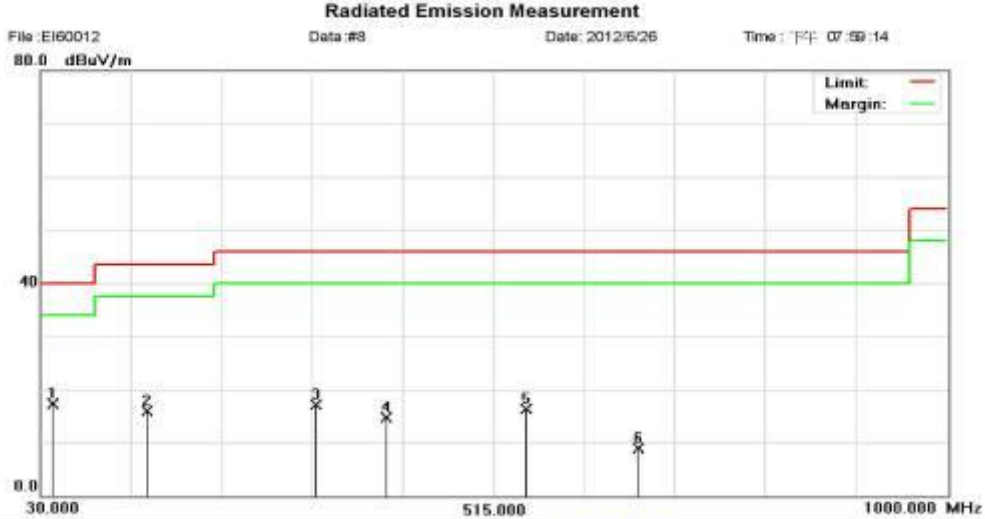

File : EI60012 Data : #8 Date : 2012/5/26 Time : 下午 07:59:14  
 Site : 9'6"X6 Chamber Polarization: **Horizontal** Temperature: 25 °C  
 Limit: FCC Class B 3M Radiation Power: AC 120V/60Hz Humidity: 60%  
 EUT: PDAPhone Distance: 3m Air Pressure: 1002 hpa  
 MN: PM-0160-BV  
 Note: Config 2: Recording

No.	Mk.	Freq. MHz	Reading Level dBuV	Factor dB	Measure- ment dBuV/m	Limit dBuV/m	Over dB	Detector	Comment
1	*	42.8800	33.33	-16.11	17.22	40.00	-22.78	OP	
2		144.2200	30.36	-14.53	15.83	43.50	-27.67	OP	
3		324.0200	29.05	-11.96	17.09	46.00	-28.91	OP	
4		400.2600	24.84	-10.05	14.79	46.00	-31.21	OP	
5		548.3400	23.63	-7.25	16.38	46.00	-29.62	OP	
6		668.7400	13.22	-4.25	8.97	46.00	-37.03	OP	

\*:Maximum data x:Over limit !:over margin ●Reference Only

File : EI60012\Data : #8

Page : 1

Engineer Signature:

Unless otherwise stated the results shown in this test report refer only to the sample(s) tested and such sample(s) are retained for 90 days only.

除非另有說明，此報告結果僅對測試之樣品負責，同時此樣品僅保留90天。本報告未經本公司書面許可，不可部份複製。

This document is issued by the Company subject to its General Conditions of Service printed overleaf, available on request or accessible at [www.sgs.com/terms\\_and\\_conditions.htm](http://www.sgs.com/terms_and_conditions.htm) and, for electronic format documents, subject to Terms and Conditions for Electronic Documents at [www.sgs.com/terms\\_e-document.htm](http://www.sgs.com/terms_e-document.htm). Attention is drawn to the limitation of liability, indemnification and jurisdiction issues defined therein. Any holder of this document is advised that information contained hereon reflects the Company's findings at the time of its intervention only and within the limits of Client's instructions, if any. The Company's sole responsibility is to its Client and this document does not exonerate parties to a transaction from exercising all their rights and obligations under the transaction documents. This document cannot be reproduced except in full, without prior written approval of the Company. Any unauthorized alteration, forgery or falsification of the content or appearance of this document is unlawful and offenders may be prosecuted to the fullest extent of the law.

V



臺灣檢驗科技股份有限公司 - 電子電訊實驗室  
 Address : 台北縣五股工業區五工路 134 號  
 Tel:02-2299-3279 Fax:02-2298-2698

**Radiated Emission Measurement**

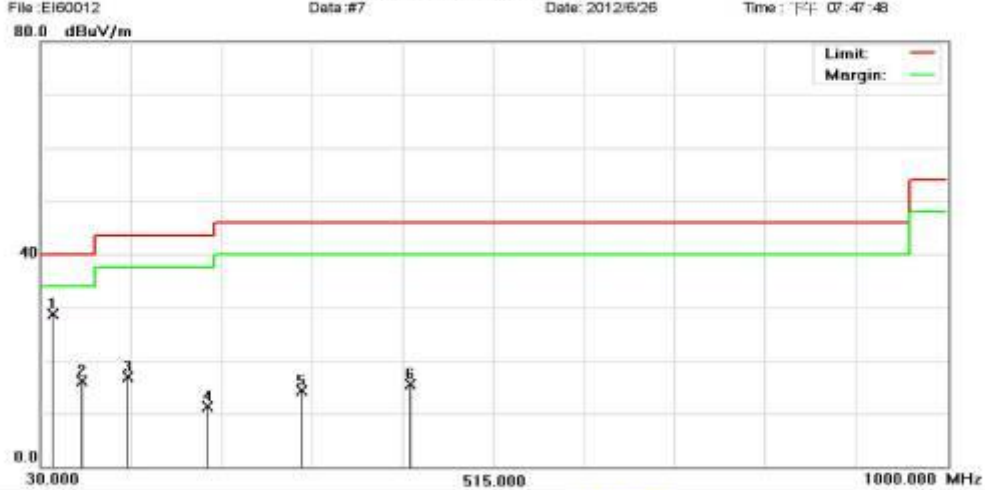

File: EI60012 Data: #7 Date: 2012/5/26 Time: 下午 07:47:48  
 Site : 9\*6\*6 Chamber Polarization: **Vertical** Temperature: 25 °C  
 Limit: FCC Class B 3M Radiation Power: AC 120V/60Hz Humidity: 60%  
 EUT: PDAPhone Distance: 3m Air Pressure: 1002 hpa  
 MN: PM-0160-BV  
 Note: Config 2: Recording

No.	Mk.	Freq.	Reading Level	Factor	Measurement	Limit	Over		
		MHz	dBuV	dB	dBuV/m	dBuV/m	dB	Detector	Comment
1	*	42.9600	44.73	-16.10	28.63	40.00	-11.37	QP	
2		74.3200	35.11	-18.99	16.12	40.00	-23.88	QP	
3		122.2600	33.09	-16.20	16.89	43.50	-26.61	QP	
4		207.7600	27.38	-16.04	11.34	43.50	-32.16	QP	
5		307.9800	26.18	-11.91	14.27	46.00	-31.73	QP	
6		424.6400	24.88	-9.39	15.49	46.00	-30.51	QP	

\*:Maximum data x:Over limit !:over margin ●Reference Only

File: EI60012>Data: #7

Page: 1

Engineer Signature:

Unless otherwise stated the results shown in this test report refer only to the sample(s) tested and such sample(s) are retained for 90 days only.

除非另有說明，此報告結果僅對測試之樣品負責，同時此樣品僅保留90天。本報告未經本公司書面許可，不可部份複製。

This document is issued by the Company subject to its General Conditions of Service printed overleaf, available on request or accessible at [www.sgs.com/terms\\_and\\_conditions.htm](http://www.sgs.com/terms_and_conditions.htm) and, for electronic format documents, subject to Terms and Conditions for Electronic Documents at [www.sgs.com/terms\\_e-document.htm](http://www.sgs.com/terms_e-document.htm). Attention is drawn to the limitation of liability, indemnification and jurisdiction issues defined therein. Any holder of this document is advised that information contained hereon reflects the Company's findings at the time of its intervention only and within the limits of Client's instructions, if any. The Company's sole responsibility is to its Client and this document does not exonerate parties to a transaction from exercising all their rights and obligations under the transaction documents. This document cannot be reproduced except in full, without prior written approval of the Company. Any unauthorized alteration, forgery or falsification of the content or appearance of this document is unlawful and offenders may be prosecuted to the fullest extent of the law.



Config 3 : FM 87.6

H

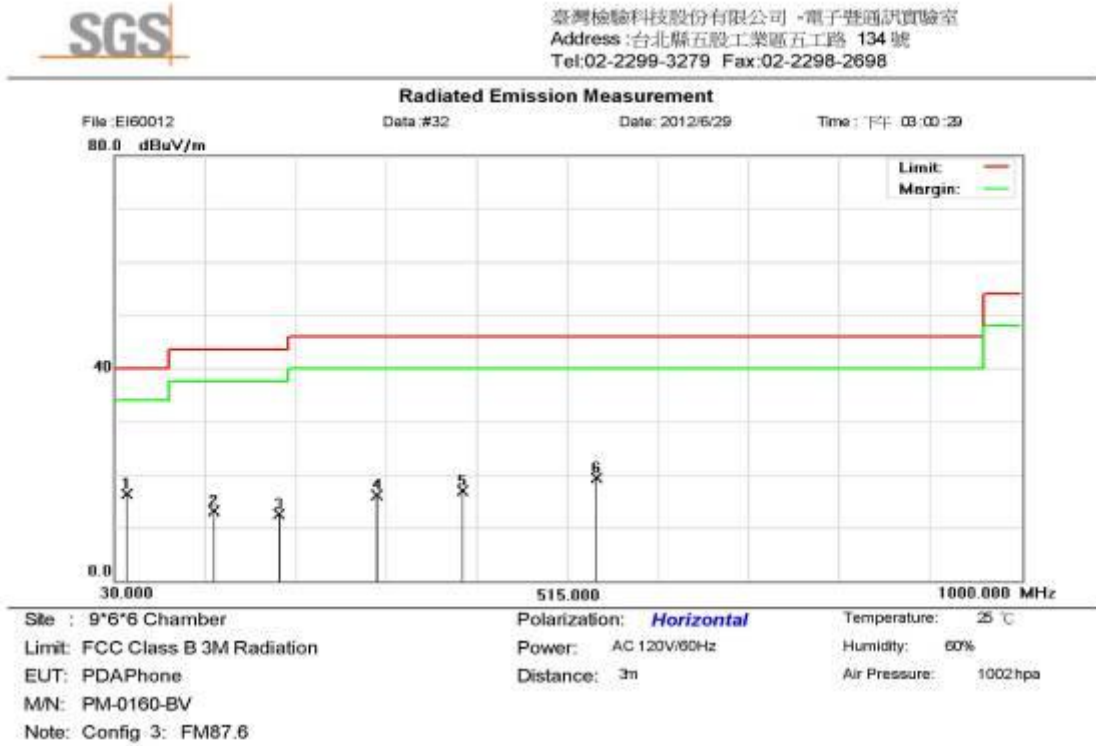

No.	Mk.	Freq. MHz	Reading Level dBuV	Factor dB	Measurement dBuV/m	Limit dBuV/m	Over dB	Detector	Comment
1	*	43.0400	32.36	-16.09	16.27	40.00	-23.73	OP	
2		135.9800	28.14	-15.10	13.04	43.50	-30.46	OP	
3		205.8800	28.65	-16.13	12.52	43.50	-30.98	OP	
4		310.6200	27.89	-11.85	16.04	46.00	-29.96	OP	
5		400.8200	26.91	-10.06	16.85	46.00	-29.15	OP	
6		544.3400	26.57	-7.18	19.39	46.00	-26.61	OP	

\*:Maximum data    x:Over limit    !:over margin      ●Reference Only

File: EI60012\Data: #32

Page: 1

Engineer Signature:

Unless otherwise stated the results shown in this test report refer only to the sample(s) tested and such sample(s) are retained for 90 days only.

除非另有說明，此報告結果僅對測試之樣品負責，同時此樣品僅保留90天。本報告未經本公司書面許可，不可部份複製。

This document is issued by the Company subject to its General Conditions of Service printed overleaf, available on request or accessible at [www.sgs.com/terms\\_and\\_conditions.htm](http://www.sgs.com/terms_and_conditions.htm) and, for electronic format documents, subject to Terms and Conditions for Electronic Documents at [www.sgs.com/terms\\_e-document.htm](http://www.sgs.com/terms_e-document.htm). Attention is drawn to the limitation of liability, indemnification and jurisdiction issues defined therein. Any holder of this document is advised that information contained hereon reflects the Company's findings at the time of its intervention only and within the limits of Client's instructions, if any. The Company's sole responsibility is to its Client and this document does not exonerate parties to a transaction from exercising all their rights and obligations under the transaction documents. This document cannot be reproduced except in full, without prior written approval of the Company. Any unauthorized alteration, forgery or falsification of the content or appearance of this document is unlawful and offenders may be prosecuted to the fullest extent of the law.

V



臺灣檢驗科技股份有限公司 - 電子暨通訊實驗室  
 Address : 台北縣五股工業區五工路 134 號  
 Tel:02-2299-3279 Fax:02-2298-2698

**Radiated Emission Measurement**

File: EI60012 Data: #31 Date: 2012/5/29 Time: 下午 02:47:40

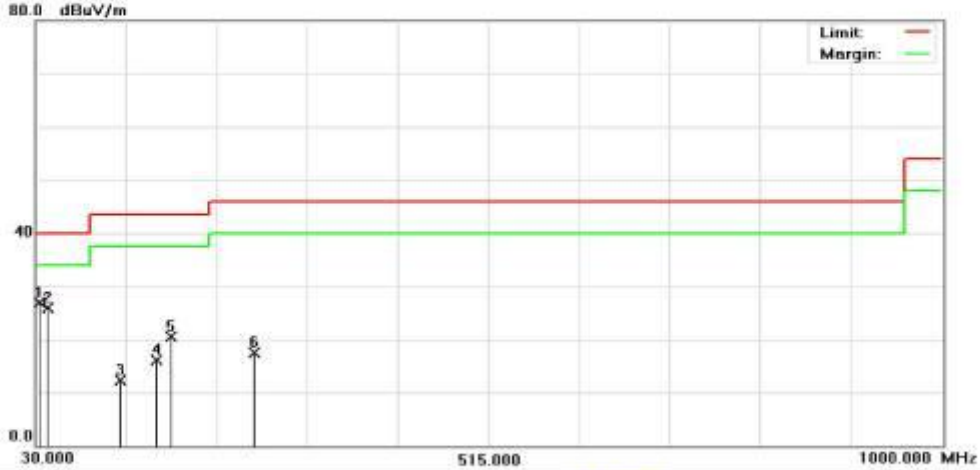

Site : 9\*6\*6 Chamber Polarization: **Vertical** Temperature: 25 °C  
 Limit: FCC Class B 3M Radiation Power: AC 120V/60Hz Humidity: 60%  
 EUT: PDAPhone Distance: 3m Air Pressure: 1002 hpa  
 MN: PM-0160-BV  
 Note: Config 3: FM87.6

No.	Mk.	Freq. MHz	Reading Level dBuV	Factor dB	Measure- ment dBuV/m	Limit dBuV/m	Over dB	Detector	Comment
1	*	32.6600	44.01	-17.13	26.88	40.00	-13.12	OP	
2		43.3400	41.90	-16.06	25.84	40.00	-14.16	OP	
3		120.6400	28.61	-16.33	12.28	43.50	-31.22	OP	
4		158.6400	30.24	-14.23	16.01	43.50	-27.49	OP	
5		175.2000	35.12	-14.57	20.55	43.50	-22.95	OP	
6		262.8400	31.03	-13.46	17.57	46.00	-28.43	OP	

\*:Maximum data x:Over limit !:over margin ●Reference Only

File: EI60012>Data :#31

Page: 1

Engineer Signature:

Unless otherwise stated the results shown in this test report refer only to the sample(s) tested and such sample(s) are retained for 90 days only.

除非另有說明，此報告結果僅對測試之樣品負責，同時此樣品僅保留90天。本報告未經本公司書面許可，不可部份複製。

This document is issued by the Company subject to its General Conditions of Service printed overleaf, available on request or accessible at [www.sgs.com/terms\\_and\\_conditions.htm](http://www.sgs.com/terms_and_conditions.htm) and, for electronic format documents, subject to Terms and Conditions for Electronic Documents at [www.sgs.com/terms\\_e-document.htm](http://www.sgs.com/terms_e-document.htm). Attention is drawn to the limitation of liability, indemnification and jurisdiction issues defined therein. Any holder of this document is advised that information contained hereon reflects the Company's findings at the time of its intervention only and within the limits of Client's instructions, if any. The Company's sole responsibility is to its Client and this document does not exonerate parties to a transaction from exercising all their rights and obligations under the transaction documents. This document cannot be reproduced except in full, without prior written approval of the Company. Any unauthorized alteration, forgery or falsification of the content or appearance of this document is unlawful and offenders may be prosecuted to the fullest extent of the law.



Config 3 : FM 98

H

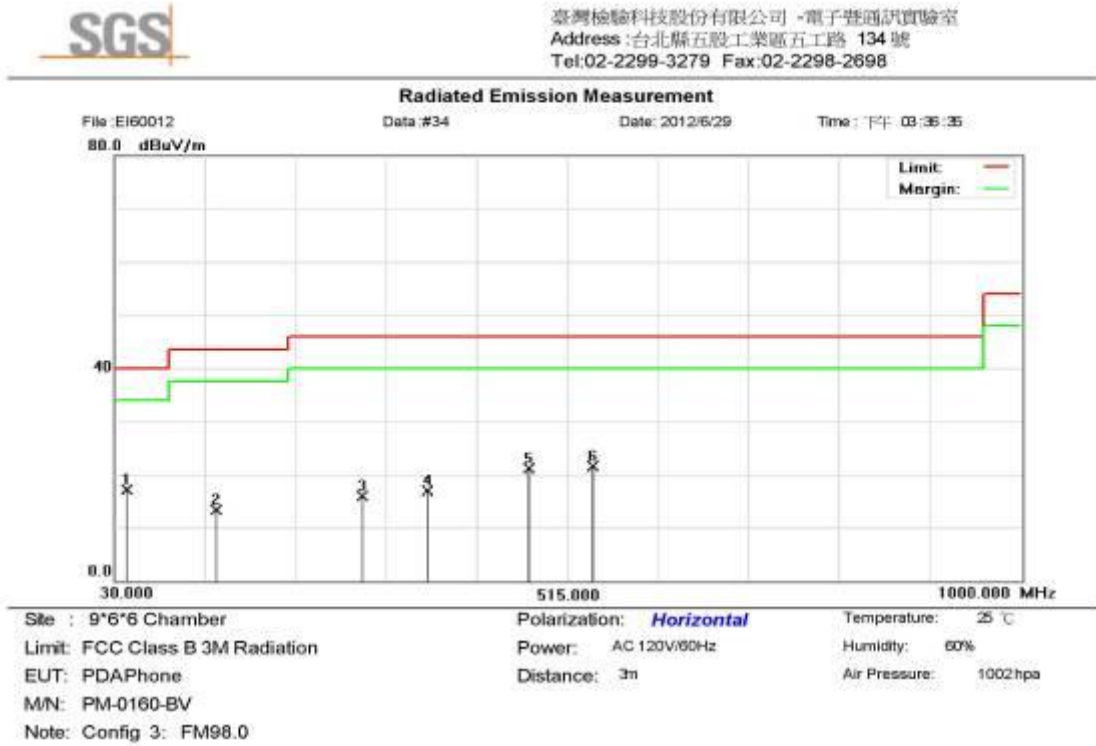

No.	Mk.	Freq. MHz	Reading Level dBuV	Factor dB	Measurement dBuV/m	Limit dBuV/m	Over dB	Detector	Comment
1	*	43.3400	33.15	-16.06	17.09	40.00	-22.91	OP	
2		137.5300	28.32	-14.97	13.35	43.50	-30.15	OP	
3		294.1200	28.33	-12.39	15.94	46.00	-30.06	OP	
4		365.5800	27.65	-10.82	16.83	46.00	-29.17	OP	
5		473.1900	29.90	-8.80	21.10	46.00	-24.90	OP	
6		541.3500	28.62	-7.14	21.48	46.00	-24.52	OP	

\*:Maximum data    x:Over limit    !:over margin      ●Reference Only

File: EI60012\Data: #34

Page: 1

Engineer Signature:

Unless otherwise stated the results shown in this test report refer only to the sample(s) tested and such sample(s) are retained for 90 days only.

除非另有說明，此報告結果僅對測試之樣品負責，同時此樣品僅保留90天。本報告未經本公司書面許可，不可部份複製。

This document is issued by the Company subject to its General Conditions of Service printed overleaf, available on request or accessible at [www.sgs.com/terms\\_and\\_conditions.htm](http://www.sgs.com/terms_and_conditions.htm) and, for electronic format documents, subject to Terms and Conditions for Electronic Documents at [www.sgs.com/terms\\_e-document.htm](http://www.sgs.com/terms_e-document.htm). Attention is drawn to the limitation of liability, indemnification and jurisdiction issues defined therein. Any holder of this document is advised that information contained hereon reflects the Company's findings at the time of its intervention only and within the limits of Client's instructions, if any. The Company's sole responsibility is to its Client and this document does not exonerate parties to a transaction from exercising all their rights and obligations under the transaction documents. This document cannot be reproduced except in full, without prior written approval of the Company. Any unauthorized alteration, forgery or falsification of the content or appearance of this document is unlawful and offenders may be prosecuted to the fullest extent of the law.

V



臺灣檢驗科技股份有限公司 - 電子電訊實驗室  
 Address : 台北縣五股工業區五工路 134 號  
 Tel:02-2299-3279 Fax:02-2298-2698

**Radiated Emission Measurement**

File: EI60012 Data #33 Date: 2012/6/29 Time: 下午 03:17:38

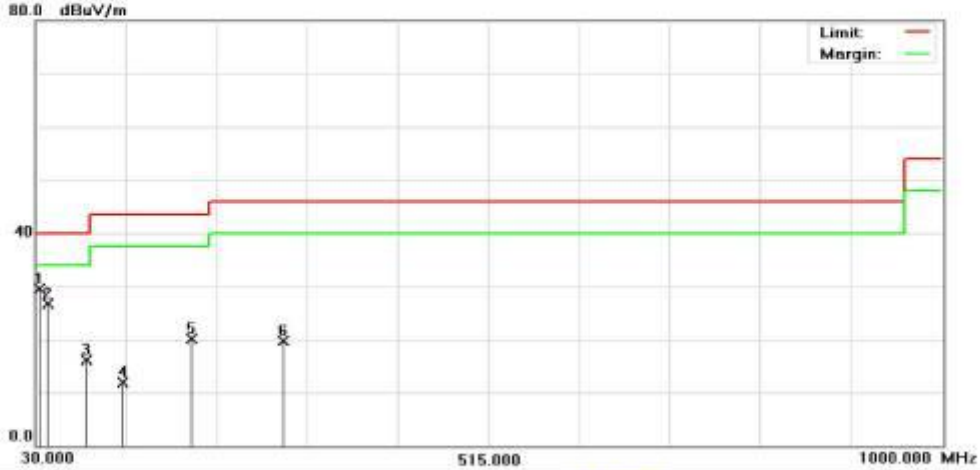

Site : 9\*6 Chamber Polarization: **Vertical** Temperature: 25 °C  
 Limit: FCC Class B 3M Radiation Power: AC 120V/60Hz Humidity: 60%  
 EUT: PDAPhone Distance: 3m Air Pressure: 1002 hpa  
 MN: PM-0160-BV  
 Note: Config 3: FM98.0

No.	Mk.	Freq. MHz	Reading Level dBuV	Factor dB	Measure- ment dBuV/m	Limit dBuV/m	Over dB	Detector	Comment
1	*	32.6400	46.57	-17.13	29.44	40.00	-10.56	QP	
2		43.1800	42.80	-16.08	26.72	40.00	-13.28	QP	
3		83.4000	36.51	-20.33	16.18	40.00	-23.82	QP	
4		121.9000	28.20	-16.23	11.97	43.50	-31.53	QP	
5		195.9000	36.23	-16.20	20.03	43.50	-23.47	QP	
6		294.1600	32.09	-12.39	19.70	46.00	-26.30	QP	

\*:Maximum data x:Over limit !:over margin ●Reference Only

File: EI60012\Data :#33

Page: 1

Engineer Signature:

Unless otherwise stated the results shown in this test report refer only to the sample(s) tested and such sample(s) are retained for 90 days only.

除非另有說明，此報告結果僅對測試之樣品負責，同時此樣品僅保留90天。本報告未經本公司書面許可，不可部份複製。

This document is issued by the Company subject to its General Conditions of Service printed overleaf, available on request or accessible at [www.sgs.com/terms\\_and\\_conditions.htm](http://www.sgs.com/terms_and_conditions.htm) and, for electronic format documents, subject to Terms and Conditions for Electronic Documents at [www.sgs.com/terms\\_e-document.htm](http://www.sgs.com/terms_e-document.htm). Attention is drawn to the limitation of liability, indemnification and jurisdiction issues defined therein. Any holder of this document is advised that information contained hereon reflects the Company's findings at the time of its intervention only and within the limits of Client's instructions, if any. The Company's sole responsibility is to its Client and this document does not exonerate parties to a transaction from exercising all their rights and obligations under the transaction documents. This document cannot be reproduced except in full, without prior written approval of the Company. Any unauthorized alteration, forgery or falsification of the content or appearance of this document is unlawful and offenders may be prosecuted to the fullest extent of the law.

Config 3 : FM 107.9

H



臺灣檢驗科技股份有限公司 - 電子暨通訊實驗室  
 Address : 台北縣五股工業區五工路 134 號  
 Tel:02-2299-3279 Fax:02-2298-2698

Radiated Emission Measurement

File: EI60012 Data #36 Date: 2012/5/29 Time: 下午 04:01:00

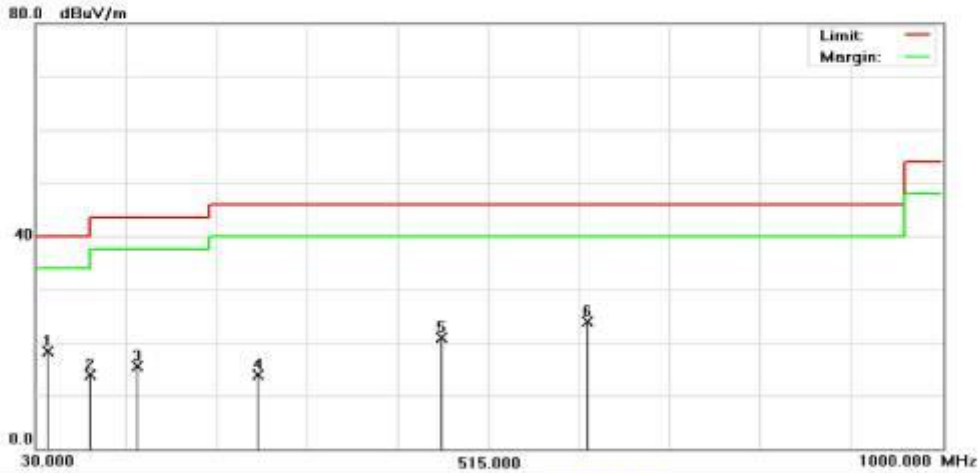

Site : 9\*6\*6 Chamber Polarization: **Horizontal** Temperature: 25 °C  
 Limit: FCC Class B 3M Radiation Power: AC 120V/60Hz Humidity: 60%  
 EUT: PDAPhone Distance: 3m Air Pressure: 1002 hpa  
 MN: PM-0160-BV  
 Note: Config 3: FM107.9

No.	Mk.	Freq. MHz	Reading Level dBuV	Factor dB	Measure- ment dBuV/m	Limit dBuV/m	Over dB	Detector	Comment
1	*	42.6500	34.40	-16.13	18.27	40.00	-21.73	OP	
2		86.6500	34.53	-20.53	14.00	40.00	-26.00	OP	
3		137.2300	30.52	-15.00	15.52	43.50	-27.98	OP	
4		267.6500	27.24	-13.25	13.99	46.00	-32.01	OP	
5		463.2500	29.56	-8.60	20.96	46.00	-25.04	OP	
6		620.4500	29.86	-5.93	23.93	46.00	-22.07	OP	

\*:Maximum data x:Over limit !:over margin ●Reference Only

File: EI60012\Data :#36

Page: 1

Engineer Signature:

Unless otherwise stated the results shown in this test report refer only to the sample(s) tested and such sample(s) are retained for 90 days only.

除非另有說明，此報告結果僅對測試之樣品負責，同時此樣品僅保留90天。本報告未經本公司書面許可，不可部份複製。

This document is issued by the Company subject to its General Conditions of Service printed overleaf, available on request or accessible at [www.sgs.com/terms\\_and\\_conditions.htm](http://www.sgs.com/terms_and_conditions.htm) and, for electronic format documents, subject to Terms and Conditions for Electronic Documents at [www.sgs.com/terms\\_e-document.htm](http://www.sgs.com/terms_e-document.htm). Attention is drawn to the limitation of liability, indemnification and jurisdiction issues defined therein. Any holder of this document is advised that information contained hereon reflects the Company's findings at the time of its intervention only and within the limits of Client's instructions, if any. The Company's sole responsibility is to its Client and this document does not exonerate parties to a transaction from exercising all their rights and obligations under the transaction documents. This document cannot be reproduced except in full, without prior written approval of the Company. Any unauthorized alteration, forgery or falsification of the content or appearance of this document is unlawful and offenders may be prosecuted to the fullest extent of the law.



臺灣檢驗科技股份有限公司 - 電子暨通訊實驗室  
 Address : 台北縣五股工業區五工路 134 號  
 Tel:02-2299-3279 Fax:02-2298-2698

**Radiated Emission Measurement**

File: EI60012 Data: #35 Date: 2012/5/29 Time: 下午 03:47:56

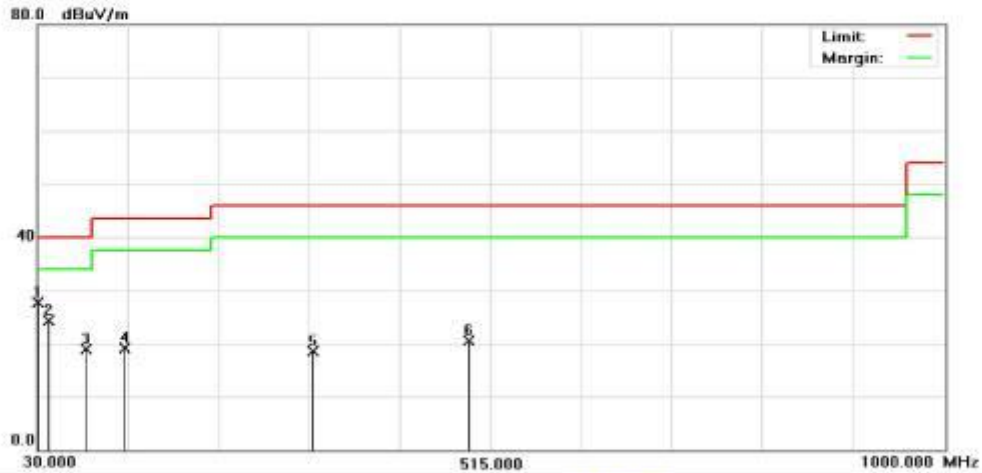

Site : 9'6"6 Chamber Polarization: **Vertical** Temperature: 25 °C  
 Limit: FCC Class B 3M Radiation Power: AC 120V/60Hz Humidity: 60%  
 EUT: PDAPhone Distance: 3m Air Pressure: 1002 hpa  
 MN: PM-0160-BV  
 Note: Config 3: FM107.9

No.	Mk.	Freq.	Reading Level	Factor	Measurement	Limit	Over		
		MHz	dBuV	dB	dBuV/m	dBuV/m	dB	Detector	Comment
1	*	30.0000	44.90	-17.25	27.65	40.00	-12.35	QP	
2		41.3500	40.50	-16.26	24.24	40.00	-15.76	QP	
3		81.3500	39.20	-20.21	18.99	40.00	-21.01	QP	
4		121.3500	35.43	-16.28	19.15	43.50	-24.35	QP	
5		323.2600	30.56	-11.98	18.58	46.00	-27.42	QP	
6		490.6200	28.80	-8.35	20.45	46.00	-25.55	QP	

\*:Maximum data x:Over limit !:over margin ●ReferenceOnly

File: EI60012\Data: #35

Page: 1

Engineer Signature:

Unless otherwise stated the results shown in this test report refer only to the sample(s) tested and such sample(s) are retained for 90 days only.

除非另有說明，此報告結果僅對測試之樣品負責，同時此樣品僅保留90天。本報告未經本公司書面許可，不可部份複製。

This document is issued by the Company subject to its General Conditions of Service printed overleaf, available on request or accessible at [www.sgs.com/terms\\_and\\_conditions.htm](http://www.sgs.com/terms_and_conditions.htm) and, for electronic format documents, subject to Terms and Conditions for Electronic Documents at [www.sgs.com/terms\\_e-document.htm](http://www.sgs.com/terms_e-document.htm). Attention is drawn to the limitation of liability, indemnification and jurisdiction issues defined therein. Any holder of this document is advised that information contained hereon reflects the Company's findings at the time of its intervention only and within the limits of Client's instructions, if any. The Company's sole responsibility is to its Client and this document does not exonerate parties to a transaction from exercising all their rights and obligations under the transaction documents. This document cannot be reproduced except in full, without prior written approval of the Company. Any unauthorized alteration, forgery or falsification of the content or appearance of this document is unlawful and offenders may be prosecuted to the fullest extent of the law.

Config 1 : Data Link  
H

臺灣檢驗科技股份有限公司 - 電子暨通訊實驗室  
Address : 台北縣五股工業區五工路 134 號  
Tel:02-2299-3279 Fax:02-2298-2698

Radiated Emission Measurement

File: EI60012 Data: #64 Date: 2012/7/2 Time: 上午 11:15:08

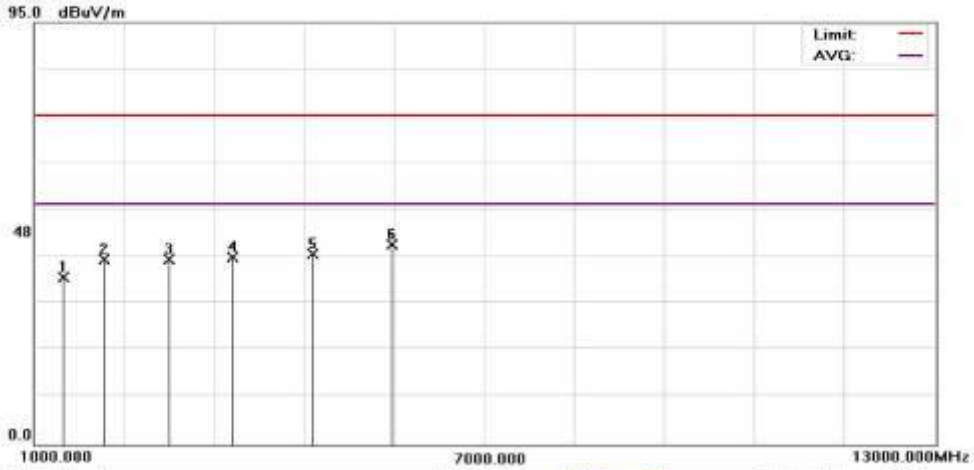

Site : 966-2 Chamber Polarization: **Horizontal** Temperature: 25 °C  
Limit: FCC Class B 3M Radiation(1G-40G)(Pea Power: From System Humidity: 80%  
EUT: PDAPhone Distance:  
MN: PM-0160-BV  
Mode: Config 1:Data Link ; 10% Battery Capacity  
Note:

No.	Mk.	Freq. MHz	Reading Level dBuV	Correct Factor dB	Measurement dBuV/m	Limit dBuV/m	Over dB	Detector	Comment
1		1384.000	40.28	-2.71	37.57	74.00	-36.43	peak	
2		1936.000	41.08	0.58	41.66	74.00	-32.34	peak	
3		2800.000	38.78	2.90	41.68	74.00	-32.32	peak	
4		3640.000	37.71	4.54	42.25	74.00	-31.75	peak	
5		4720.000	36.45	6.41	42.86	74.00	-31.14	peak	
6	*	5776.000	37.17	7.87	45.04	74.00	-28.96	peak	

\*:Maximum data x:Over limit !:over margin

●ReferenceOnly

File:EI60012\Data:#64

Page: 1

Engineer Signature:

Printed with FreePrint - purchase at www.FreePrint.com

Unless otherwise stated the results shown in this test report refer only to the sample(s) tested and such sample(s) are retained for 90 days only.

除非另有說明，此報告結果僅對測試之樣品負責，同時此樣品僅保留90天。本報告未經本公司書面許可，不可部份複製。

This document is issued by the Company subject to its General Conditions of Service printed overleaf, available on request or accessible at [www.sgs.com/terms\\_and\\_conditions.htm](http://www.sgs.com/terms_and_conditions.htm) and, for electronic format documents, subject to Terms and Conditions for Electronic Documents at [www.sgs.com/terms\\_e-document.htm](http://www.sgs.com/terms_e-document.htm). Attention is drawn to the limitation of liability, indemnification and jurisdiction issues defined therein. Any holder of this document is advised that information contained hereon reflects the Company's findings at the time of its intervention only and within the limits of Client's instructions, if any. The Company's sole responsibility is to its Client and this document does not exonerate parties to a transaction from exercising all their rights and obligations under the transaction documents. This document cannot be reproduced except in full, without prior written approval of the Company. Any unauthorized alteration, forgery or falsification of the content or appearance of this document is unlawful and offenders may be prosecuted to the fullest extent of the law.



V

臺灣檢驗科技股份有限公司 - 電子電訊實驗室  
 Address : 台北縣五股工業區五工路 134 號  
 Tel:02-2299-3279 Fax:02-2298-2698

**Radiated Emission Measurement**

File: EI60012 Data: #63 Date: 2012/7/2 Time: 上午 11:04:03  
 95.0 dBuV/m

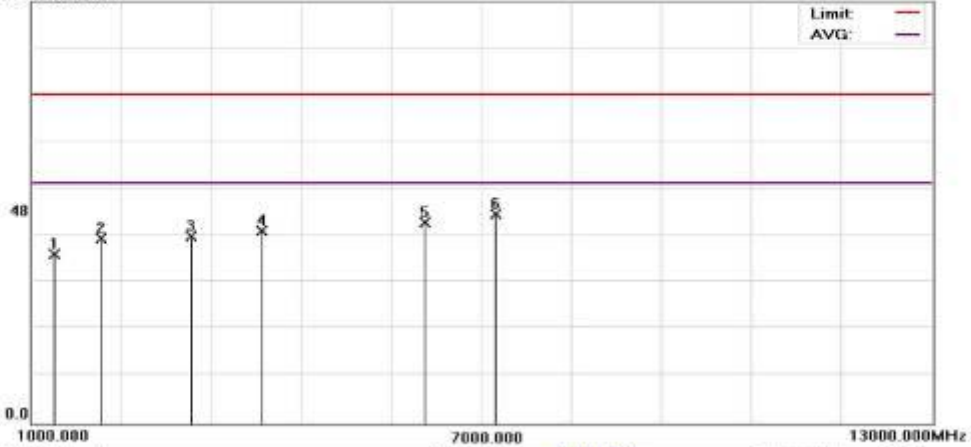

Site :966-2 Chamber Polarization: **Vertical** Temperature: 25 °C  
 Limit: FCC Class B 3M Radiation(1G-40G)(Pea Power: From System Humidity: 80%  
 EUT: PDAPhone Distance:  
 M/N: PM-0160-BV  
 Mode: Config 1:Data Link ; 10% Battery Capacity  
 Note:

No.	Mk	Freq. MHz	Reading Level dBuV	Correct Factor dB	Measurement dBuV/m	Limit dBuV/m	Over dB	Detector	Comment
1		1312.000	41.05	-2.84	38.21	74.00	-35.79	peak	
2		1936.000	41.07	0.58	41.65	74.00	-32.35	peak	
3		3136.000	38.51	3.56	42.07	74.00	-31.93	peak	
4		4072.000	38.10	5.21	43.31	74.00	-30.69	peak	
5		6256.000	36.44	8.80	45.24	74.00	-28.76	peak	
6	*	7192.000	37.76	9.40	47.16	74.00	-26.84	peak	

\*:Maximum data x:Over limit !:over margin ●ReferenceOnly

File:EI60012\Data:#63

Page: 1

Engineer Signature:

Printed with FreePrint - purchase at www.FreePrint.com

Unless otherwise stated the results shown in this test report refer only to the sample(s) tested and such sample(s) are retained for 90 days only.

除非另有說明，此報告結果僅對測試之樣品負責，同時此樣品僅保留90天。本報告未經本公司書面許可，不可部份複製。

This document is issued by the Company subject to its General Conditions of Service printed overleaf, available on request or accessible at [www.sgs.com/terms\\_and\\_conditions.htm](http://www.sgs.com/terms_and_conditions.htm) and, for electronic format documents, subject to Terms and Conditions for Electronic Documents at [www.sgs.com/terms\\_e-document.htm](http://www.sgs.com/terms_e-document.htm). Attention is drawn to the limitation of liability, indemnification and jurisdiction issues defined therein. Any holder of this document is advised that information contained hereon reflects the Company's findings at the time of its intervention only and within the limits of Client's instructions, if any. The Company's sole responsibility is to its Client and this document does not exonerate parties to a transaction from exercising all their rights and obligations under the transaction documents. This document cannot be reproduced except in full, without prior written approval of the Company. Any unauthorized alteration, forgery or falsification of the content or appearance of this document is unlawful and offenders may be prosecuted to the fullest extent of the law.

Config 2 : Recording  
H

臺灣檢驗科技股份有限公司 - 電子電訊實驗室  
Address : 台北縣五股工業區五工路 134 號  
Tel:02-2299-3279 Fax:02-2298-2698

Radiated Emission Measurement

File: EI60012 Data: #58 Date: 2012/7/2 Time: 上午 10:07:10

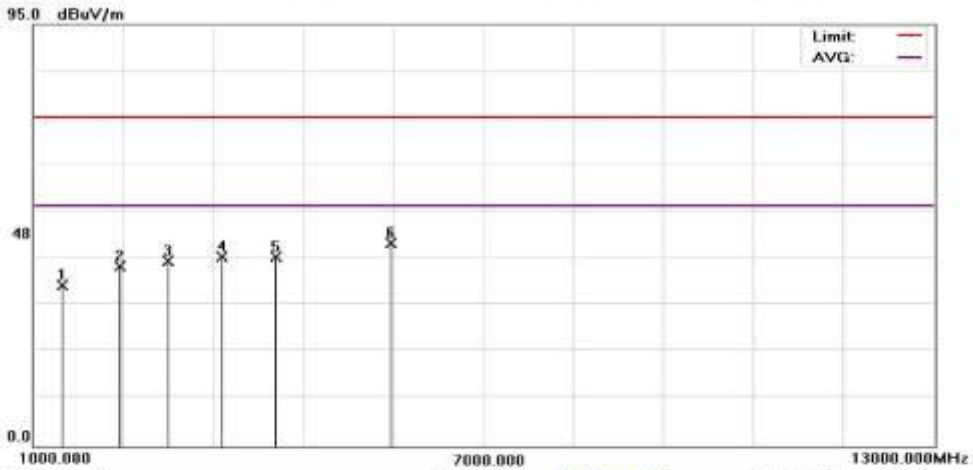

Site : 966-2 Chamber Polarization: **Horizontal** Temperature: 25 °C  
 Limit: FCC Class B 3M Radiation(1G-40G)(Pea Power: AC 120V/60Hz Humidity: 80%  
 EUT: PDAPhone Distance:  
 M/N: PM-0160-BV  
 Mode: Config 2:Recording ; 10% Battery Capacity  
 Note:

No.	Mk.	Freq. (MHz)	Reading Level (dBuV)	Correct Factor (dB)	Measurement (dBuV/m)	Limit (dBuV/m)	Over (dB)	Detector	Comment
1		1384.000	39.03	-2.71	36.32	74.00	-37.68	peak	
2		2152.000	38.96	1.51	40.47	74.00	-33.53	peak	
3		2800.000	38.72	2.90	41.62	74.00	-32.38	peak	
4		3520.000	38.46	4.27	42.73	74.00	-31.27	peak	
5		4240.000	37.35	5.40	42.75	74.00	-31.25	peak	
6 *		5776.000	37.80	7.87	45.67	74.00	-28.33	peak	

\*:Maximum data x:Over limit l:over margin ●ReferenceOnly

File:EI60012\Data:#58

Page: 1

Engineer Signature:

Printed with FinePrint - purchase at www.fineprint.com

Unless otherwise stated the results shown in this test report refer only to the sample(s) tested and such sample(s) are retained for 90 days only.

除非另有說明，此報告結果僅對測試之樣品負責，同時此樣品僅保留90天。本報告未經本公司書面許可，不可部份複製。

This document is issued by the Company subject to its General Conditions of Service printed overleaf, available on request or accessible at [www.sgs.com/terms\\_and\\_conditions.htm](http://www.sgs.com/terms_and_conditions.htm) and, for electronic format documents, subject to Terms and Conditions for Electronic Documents at [www.sgs.com/terms\\_e-document.htm](http://www.sgs.com/terms_e-document.htm). Attention is drawn to the limitation of liability, indemnification and jurisdiction issues defined therein. Any holder of this document is advised that information contained hereon reflects the Company's findings at the time of its intervention only and within the limits of Client's instructions, if any. The Company's sole responsibility is to its Client and this document does not exonerate parties to a transaction from exercising all their rights and obligations under the transaction documents. This document cannot be reproduced except in full, without prior written approval of the Company. Any unauthorized alteration, forgery or falsification of the content or appearance of this document is unlawful and offenders may be prosecuted to the fullest extent of the law.

V

臺灣檢驗科技股份有限公司 - 電子電訊實驗室  
 Address : 台北縣五股工業區五工路 134 號  
 Tel:02-2299-3279 Fax:02-2298-2698

**Radiated Emission Measurement**

File :EI60012 Data :#57 Date :2012/7/2 Time : 上午 09:58:07

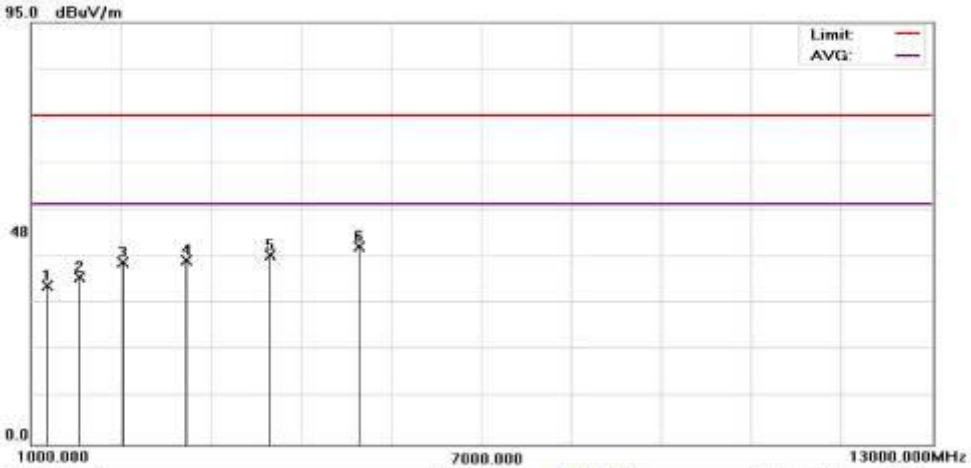

Site :966-2 Chamber Polarization: **Vertical** Temperature: 25 °C  
 Limit: FCC Class B 3M Radiation(1G-40G)(Pea Power: AC 120V/60Hz Humidity: 80%  
 EUT: PDAPhone Distance:  
 M/N: PM-0160-BV  
 Mode: Config2 :Recording ; 10% Battery Capacity  
 Note:

No.	Mk.	Freq.	Reading Level	Correct Factor	Measurement	Limit	Over	Detector	Comment
		MHz	dBuV	dB	dBuV/m	dBuV/m	dB		
1		1216.000	38.85	-3.11	35.74	74.00	-38.26	peak	
2		1648.000	39.30	-1.60	37.70	74.00	-36.30	peak	
3		2224.000	39.30	1.71	41.01	74.00	-32.99	peak	
4		3084.000	37.89	3.45	41.34	74.00	-32.66	peak	
5		4192.000	37.22	5.35	42.57	74.00	-31.43	peak	
6	*	5368.000	37.20	7.27	44.47	74.00	-29.53	peak	

\*:Maximum data x:Over limit !:over margin ●ReferenceOnly

File :EI60012\Data :#57

Page: 1

Engineer Signature:

Printed with FreePrint - purchase at www.FreePrint.com

Unless otherwise stated the results shown in this test report refer only to the sample(s) tested and such sample(s) are retained for 90 days only.

除非另有說明，此報告結果僅對測試之樣品負責，同時此樣品僅保留90天。本報告未經本公司書面許可，不可部份複製。

This document is issued by the Company subject to its General Conditions of Service printed overleaf, available on request or accessible at [www.sgs.com/terms\\_and\\_conditions.htm](http://www.sgs.com/terms_and_conditions.htm) and, for electronic format documents, subject to Terms and Conditions for Electronic Documents at [www.sgs.com/terms\\_e-document.htm](http://www.sgs.com/terms_e-document.htm). Attention is drawn to the limitation of liability, indemnification and jurisdiction issues defined therein. Any holder of this document is advised that information contained hereon reflects the Company's findings at the time of its intervention only and within the limits of Client's instructions, if any. The Company's sole responsibility is to its Client and this document does not exonerate parties to a transaction from exercising all their rights and obligations under the transaction documents. This document cannot be reproduced except in full, without prior written approval of the Company. Any unauthorized alteration, forgery or falsification of the content or appearance of this document is unlawful and offenders may be prosecuted to the fullest extent of the law.

## Config 2 : Play Recording H

臺灣檢驗科技股份有限公司 - 電子暨通訊實驗室  
Address : 台北縣五股工業區五工路 134 號  
Tel:02-2299-3279 Fax:02-2298-2698

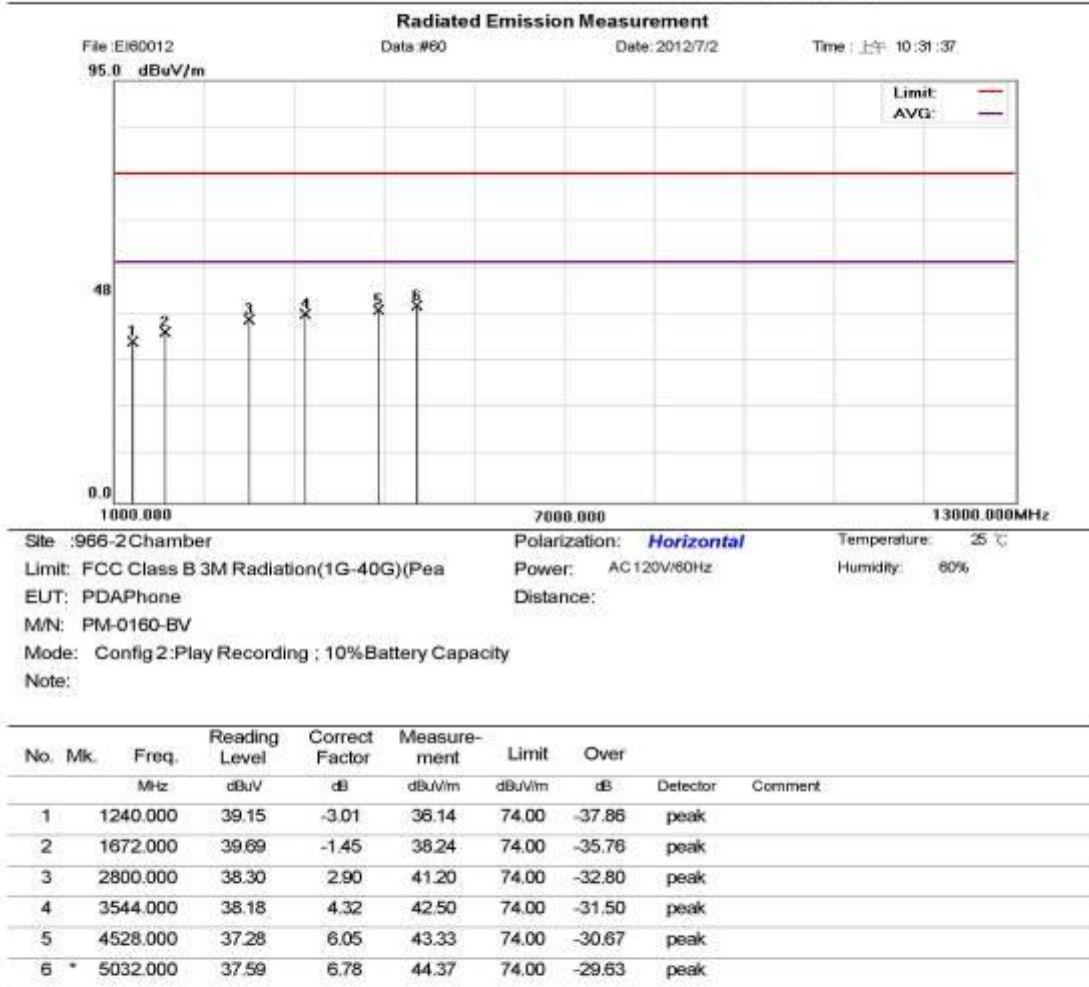

\*:Maximum data    x:Over limit    !:over margin

●ReferenceOnly

File:EI60012\Data:#60

Page: 1

Engineer Signature:

Printed with FreePrint - purchase at www.freeprint.com

Unless otherwise stated the results shown in this test report refer only to the sample(s) tested and such sample(s) are retained for 90 days only.

除非另有說明，此報告結果僅對測試之樣品負責，同時此樣品僅保留90天。本報告未經本公司書面許可，不可部份複製。

This document is issued by the Company subject to its General Conditions of Service printed overleaf, available on request or accessible at [www.sgs.com/terms\\_and\\_conditions.htm](http://www.sgs.com/terms_and_conditions.htm) and, for electronic format documents, subject to Terms and Conditions for Electronic Documents at [www.sgs.com/terms\\_e-document.htm](http://www.sgs.com/terms_e-document.htm). Attention is drawn to the limitation of liability, indemnification and jurisdiction issues defined therein. Any holder of this document is advised that information contained hereon reflects the Company's findings at the time of its intervention only and within the limits of Client's instructions, if any. The Company's sole responsibility is to its Client and this document does not exonerate parties to a transaction from exercising all their rights and obligations under the transaction documents. This document cannot be reproduced except in full, without prior written approval of the Company. Any unauthorized alteration, forgery or falsification of the content or appearance of this document is unlawful and offenders may be prosecuted to the fullest extent of the law.

V

臺灣檢驗科技股份有限公司 - 電子電訊實驗室  
 Address : 台北縣五股工業區五工路 134 號  
 Tel:02-2299-3279 Fax:02-2298-2698

**Radiated Emission Measurement**

File :EI60012 Data :#59 Date :2012/7/2 Time : 上午 10:19:34

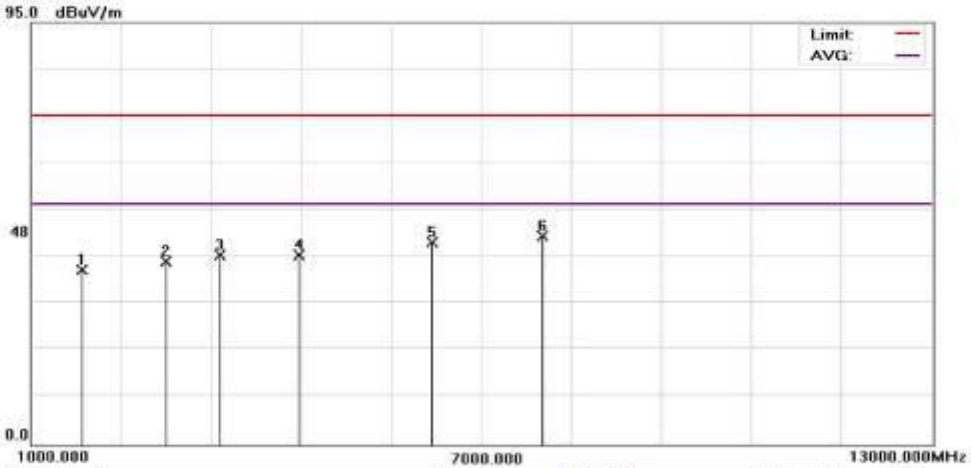

Site :966-2Chamber Polarization: **Vertical** Temperature: 25 °C  
 Limit: FCC Class B 3M Radiation(1G-40G)(Pea Power: AC120V/60Hz Humidity: 80%  
 EUT: PDAPhone Distance:  
 M/N: PM-0160-BV  
 Mode: Config 2 :Play Recording ; 10%Battery Capacity  
 Note:

No.	Mk.	Freq.	Reading Level	Correct Factor	Measurement	Limit	Over	Detector	Comment
		Mhz	dBuV	dB	dBuV/m	dBuV/m	dB		
1		1672.000	40.69	-1.45	39.24	74.00	-34.76	peak	
2		2800.000	38.27	2.90	41.17	74.00	-32.83	peak	
3		3520.000	38.47	4.27	42.74	74.00	-31.26	peak	
4		4576.000	36.50	6.14	42.64	74.00	-31.36	peak	
5		6352.000	36.59	8.86	45.45	74.00	-28.55	peak	
6	*	7816.000	36.84	10.06	46.90	74.00	-27.10	peak	

\*:Maximum data x:Over limit !:over margin ●ReferenceOnly

File :EI60012\Data :#59

Page: 1

Engineer Signature:

Printed with FreePrint - purchase at www.FreePrint.com

Unless otherwise stated the results shown in this test report refer only to the sample(s) tested and such sample(s) are retained for 90 days only.

除非另有說明，此報告結果僅對測試之樣品負責，同時此樣品僅保留90天。本報告未經本公司書面許可，不可部份複製。

This document is issued by the Company subject to its General Conditions of Service printed overleaf, available on request or accessible at [www.sgs.com/terms\\_and\\_conditions.htm](http://www.sgs.com/terms_and_conditions.htm) and, for electronic format documents, subject to Terms and Conditions for Electronic Documents at [www.sgs.com/terms\\_e-document.htm](http://www.sgs.com/terms_e-document.htm). Attention is drawn to the limitation of liability, indemnification and jurisdiction issues defined therein. Any holder of this document is advised that information contained hereon reflects the Company's findings at the time of its intervention only and within the limits of Client's instructions, if any. The Company's sole responsibility is to its Client and this document does not exonerate parties to a transaction from exercising all their rights and obligations under the transaction documents. This document cannot be reproduced except in full, without prior written approval of the Company. Any unauthorized alteration, forgery or falsification of the content or appearance of this document is unlawful and offenders may be prosecuted to the fullest extent of the law.



Config 2 : MP3  
H

臺灣檢驗科技股份有限公司 - 電子暨通訊實驗室  
Address : 台北縣五股工業區五工路 134 號  
Tel:02-2299-3279 Fax:02-2298-2698

**Radiated Emission Measurement**

File: EI60012 Data: #62 Date: 2012/7/2 Time: 上午 10:58:23

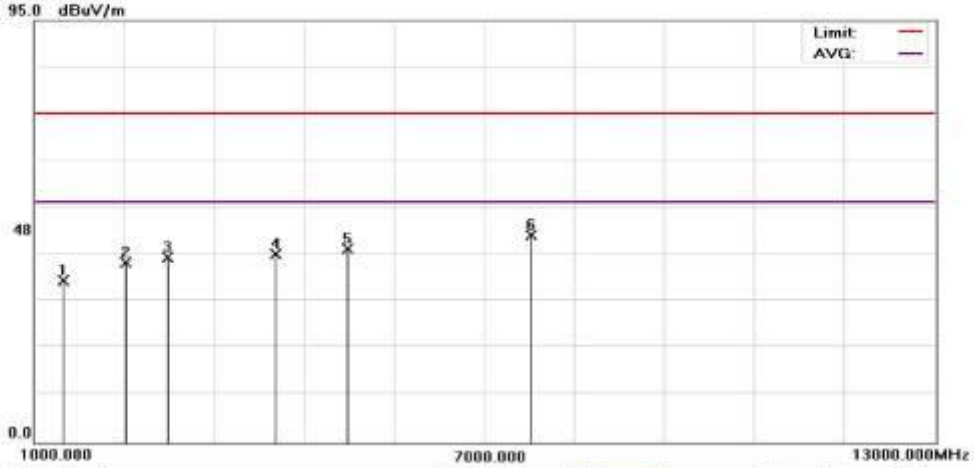

Site : 966-2 Chamber Polarization: **Horizontal** Temperature: 25 °C  
 Limit: FCC Class B 3M Radiation(1G-40G)(Pea Power: AC 120V/60Hz Humidity: 80%  
 EUT: PDAPhone Distance:  
 MN: PM-0160-BV  
 Mode: Config 2 :MP3 ; 10% Battery Capacity  
 Note:

No.	Mk.	Freq. MHz	Reading Level dBuV	Correct Factor dB	Measurement dBuV/m	Limit dBuV/m	Over dB	Detector	Comment
1		1384.000	39.14	-2.71	36.43	74.00	-37.57	peak	
2		2224.000	38.86	1.71	40.57	74.00	-33.43	peak	
3		2776.000	38.95	2.84	41.79	74.00	-32.21	peak	
4		4216.000	37.11	5.38	42.49	74.00	-31.51	peak	
5		5176.000	36.56	6.99	43.55	74.00	-30.45	peak	
6	*	7624.000	36.83	9.76	46.59	74.00	-27.41	peak	

\*:Maximum data x:Over limit !:over margin

●ReferenceOnly

File:EI60012\Data:#62

Page: 1

Engineer Signature:

Printed with FreePrint - purchase at www.freeprint.com

Unless otherwise stated the results shown in this test report refer only to the sample(s) tested and such sample(s) are retained for 90 days only.

除非另有說明，此報告結果僅對測試之樣品負責，同時此樣品僅保留90天。本報告未經本公司書面許可，不可部份複製。

This document is issued by the Company subject to its General Conditions of Service printed overleaf, available on request or accessible at [www.sgs.com/terms\\_and\\_conditions.htm](http://www.sgs.com/terms_and_conditions.htm) and, for electronic format documents, subject to Terms and Conditions for Electronic Documents at [www.sgs.com/terms\\_e-document.htm](http://www.sgs.com/terms_e-document.htm). Attention is drawn to the limitation of liability, indemnification and jurisdiction issues defined therein. Any holder of this document is advised that information contained hereon reflects the Company's findings at the time of its intervention only and within the limits of Client's instructions, if any. The Company's sole responsibility is to its Client and this document does not exonerate parties to a transaction from exercising all their rights and obligations under the transaction documents. This document cannot be reproduced except in full, without prior written approval of the Company. Any unauthorized alteration, forgery or falsification of the content or appearance of this document is unlawful and offenders may be prosecuted to the fullest extent of the law.

V

臺灣檢驗科技股份有限公司 - 電子電訊實驗室  
 Address : 台北縣五股工業區五工路 134 號  
 Tel:02-2299-3279 Fax:02-2298-2698

**Radiated Emission Measurement**

File: EI60012 Data: #61 Date: 2012/7/2 Time: 上午 10:43:20

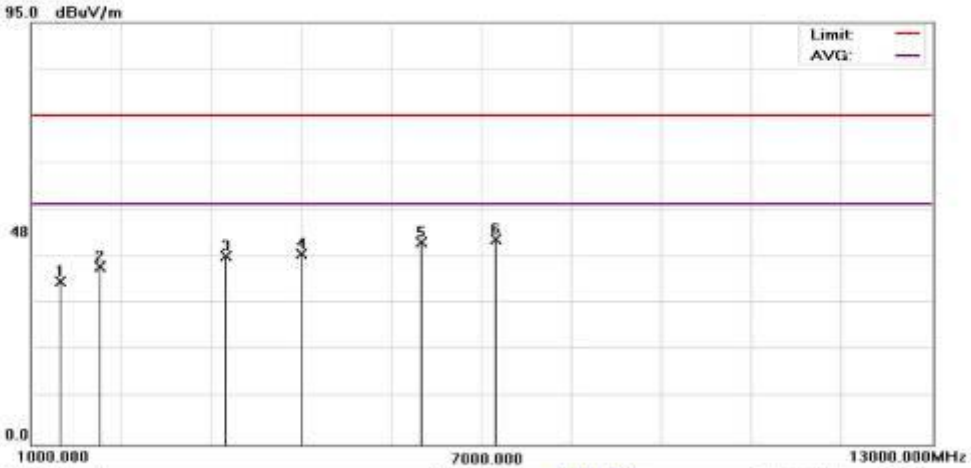

Site :966-2 Chamber Polarization: **Vertical** Temperature: 25 °C  
 Limit: FCC Class B 3M Radiation(1G-40G)(Pea Power: AC 120V/60Hz Humidity: 80%  
 EUT: PDAPhone Distance:  
 M/N: PM-0160-BV  
 Mode: Config2 :MP3 ; 10% Battery Capacity  
 Note:

No.	Mk.	Freq.	Reading Level	Correct Factor	Measurement	Limit	Over	Detector	Comment
		Mhz	dBuV	dB	dBuV/m	dBuV/m	dB		
1		1384.000	39.32	-2.71	36.61	74.00	-37.39	peak	
2		1912.000	39.74	0.37	40.11	74.00	-33.89	peak	
3		3592.000	37.99	4.43	42.42	74.00	-31.58	peak	
4		4600.000	36.78	6.18	42.96	74.00	-31.04	peak	
5		6208.000	36.70	8.73	45.43	74.00	-28.57	peak	
6	*	7192.000	36.83	9.40	46.23	74.00	-27.77	peak	

\*:Maximum data x:Over limit !:over margin ●ReferenceOnly

File:EI60012\Data:#61

Page: 1

Engineer Signature:

Printed with FreePrint - purchase at www.FreePrint.com

Unless otherwise stated the results shown in this test report refer only to the sample(s) tested and such sample(s) are retained for 90 days only.

除非另有說明，此報告結果僅對測試之樣品負責，同時此樣品僅保留90天。本報告未經本公司書面許可，不可部份複製。

This document is issued by the Company subject to its General Conditions of Service printed overleaf, available on request or accessible at [www.sgs.com/terms\\_and\\_conditions.htm](http://www.sgs.com/terms_and_conditions.htm) and, for electronic format documents, subject to Terms and Conditions for Electronic Documents at [www.sgs.com/terms\\_e-document.htm](http://www.sgs.com/terms_e-document.htm). Attention is drawn to the limitation of liability, indemnification and jurisdiction issues defined therein. Any holder of this document is advised that information contained hereon reflects the Company's findings at the time of its intervention only and within the limits of Client's instructions, if any. The Company's sole responsibility is to its Client and this document does not exonerate parties to a transaction from exercising all their rights and obligations under the transaction documents. This document cannot be reproduced except in full, without prior written approval of the Company. Any unauthorized alteration, forgery or falsification of the content or appearance of this document is unlawful and offenders may be prosecuted to the fullest extent of the law.

### 3. Photographs of Test

CE:

Config 1



Unless otherwise stated the results shown in this test report refer only to the sample(s) tested and such sample(s) are retained for 90 days only.

除非另有說明，此報告結果僅對測試之樣品負責，同時此樣品僅保留90天。本報告未經本公司書面許可，不可部份複製。

This document is issued by the Company subject to its General Conditions of Service printed overleaf, available on request or accessible at [www.sgs.com/terms\\_and\\_conditions.htm](http://www.sgs.com/terms_and_conditions.htm) and, for electronic format documents, subject to Terms and Conditions for Electronic Documents at [www.sgs.com/terms\\_e-document.htm](http://www.sgs.com/terms_e-document.htm). Attention is drawn to the limitation of liability, indemnification and jurisdiction issues defined therein. Any holder of this document is advised that information contained hereon reflects the Company's findings at the time of its intervention only and within the limits of Client's instructions, if any. The Company's sole responsibility is to its Client and this document does not exonerate parties to a transaction from exercising all their rights and obligations under the transaction documents. This document cannot be reproduced except in full, without prior written approval of the Company. Any unauthorized alteration, forgery or falsification of the content or appearance of this document is unlawful and offenders may be prosecuted to the fullest extent of the law.

Config 2



Unless otherwise stated the results shown in this test report refer only to the sample(s) tested and such sample(s) are retained for 90 days only.

除非另有說明，此報告結果僅對測試之樣品負責，同時此樣品僅保留90天。本報告未經本公司書面許可，不可部份複製。

This document is issued by the Company subject to its General Conditions of Service printed overleaf, available on request or accessible at [www.sgs.com/terms\\_and\\_conditions.htm](http://www.sgs.com/terms_and_conditions.htm) and, for electronic format documents, subject to Terms and Conditions for Electronic Documents at [www.sgs.com/terms\\_e-document.htm](http://www.sgs.com/terms_e-document.htm). Attention is drawn to the limitation of liability, indemnification and jurisdiction issues defined therein. Any holder of this document is advised that information contained hereon reflects the Company's findings at the time of its intervention only and within the limits of Client's instructions, if any. The Company's sole responsibility is to its Client and this document does not exonerate parties to a transaction from exercising all their rights and obligations under the transaction documents. This document cannot be reproduced except in full, without prior written approval of the Company. Any unauthorized alteration, forgery or falsification of the content or appearance of this document is unlawful and offenders may be prosecuted to the fullest extent of the law.



### Config 3



Unless otherwise stated the results shown in this test report refer only to the sample(s) tested and such sample(s) are retained for 90 days only.

除非另有說明，此報告結果僅對測試之樣品負責，同時此樣品僅保留90天。本報告未經本公司書面許可，不可部份複製。

This document is issued by the Company subject to its General Conditions of Service printed overleaf, available on request or accessible at [www.sgs.com/terms\\_and\\_conditions.htm](http://www.sgs.com/terms_and_conditions.htm) and, for electronic format documents, subject to Terms and Conditions for Electronic Documents at [www.sgs.com/terms\\_e-document.htm](http://www.sgs.com/terms_e-document.htm). Attention is drawn to the limitation of liability, indemnification and jurisdiction issues defined therein. Any holder of this document is advised that information contained hereon reflects the Company's findings at the time of its intervention only and within the limits of Client's instructions, if any. The Company's sole responsibility is to its Client and this document does not exonerate parties to a transaction from exercising all their rights and obligations under the transaction documents. This document cannot be reproduced except in full, without prior written approval of the Company. Any unauthorized alteration, forgery or falsification of the content or appearance of this document is unlawful and offenders may be prosecuted to the fullest extent of the law.



RE:  
Below 1G  
Config 1

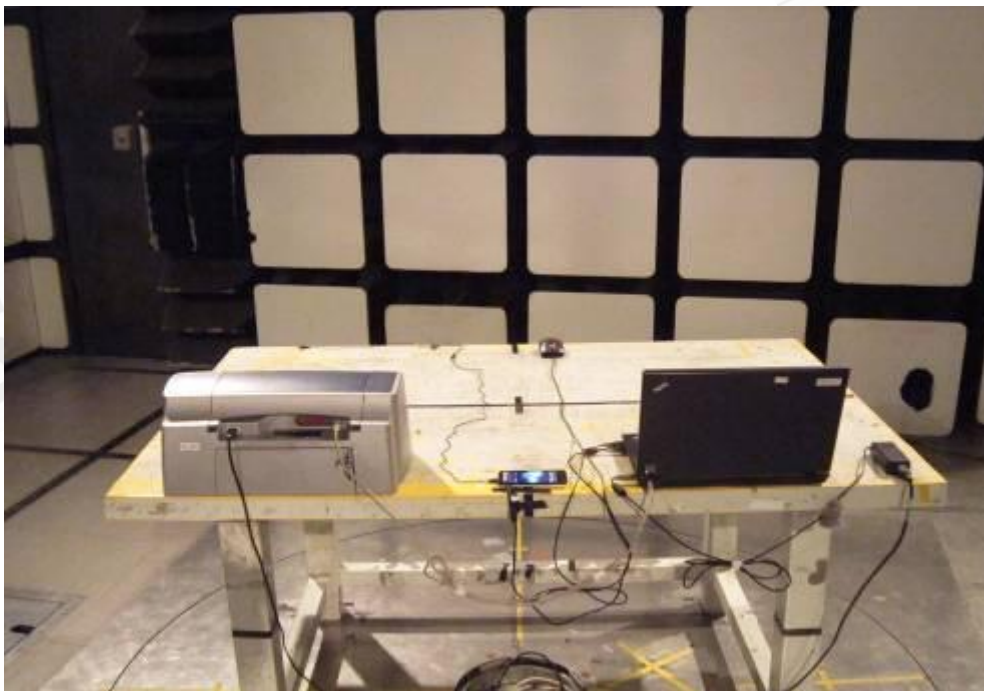
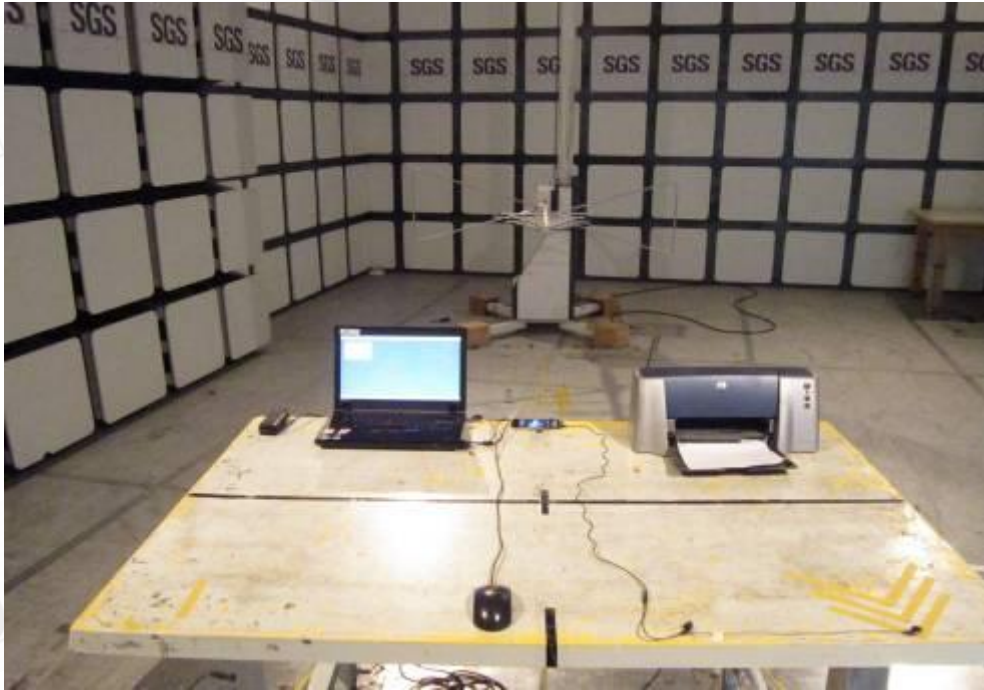

Unless otherwise stated the results shown in this test report refer only to the sample(s) tested and such sample(s) are retained for 90 days only.

除非另有說明，此報告結果僅對測試之樣品負責，同時此樣品僅保留90天。本報告未經本公司書面許可，不可部份複製。

This document is issued by the Company subject to its General Conditions of Service printed overleaf, available on request or accessible at [www.sgs.com/terms\\_and\\_conditions.htm](http://www.sgs.com/terms_and_conditions.htm) and, for electronic format documents, subject to Terms and Conditions for Electronic Documents at [www.sgs.com/terms\\_e-document.htm](http://www.sgs.com/terms_e-document.htm). Attention is drawn to the limitation of liability, indemnification and jurisdiction issues defined therein. Any holder of this document is advised that information contained hereon reflects the Company's findings at the time of its intervention only and within the limits of Client's instructions, if any. The Company's sole responsibility is to its Client and this document does not exonerate parties to a transaction from exercising all their rights and obligations under the transaction documents. This document cannot be reproduced except in full, without prior written approval of the Company. Any unauthorized alteration, forgery or falsification of the content or appearance of this document is unlawful and offenders may be prosecuted to the fullest extent of the law.

Config 2

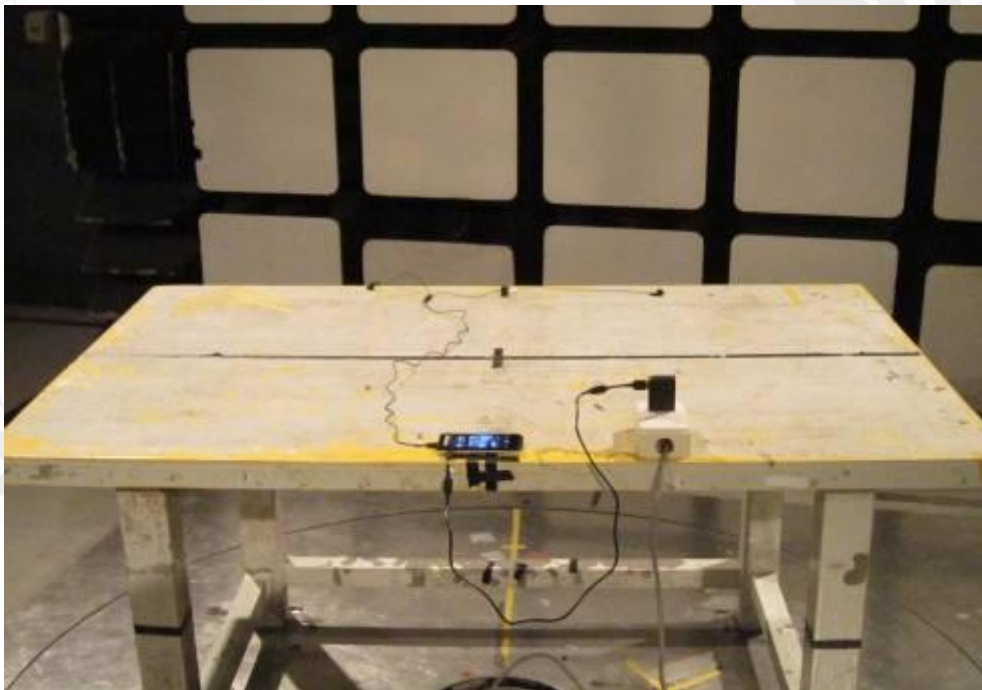
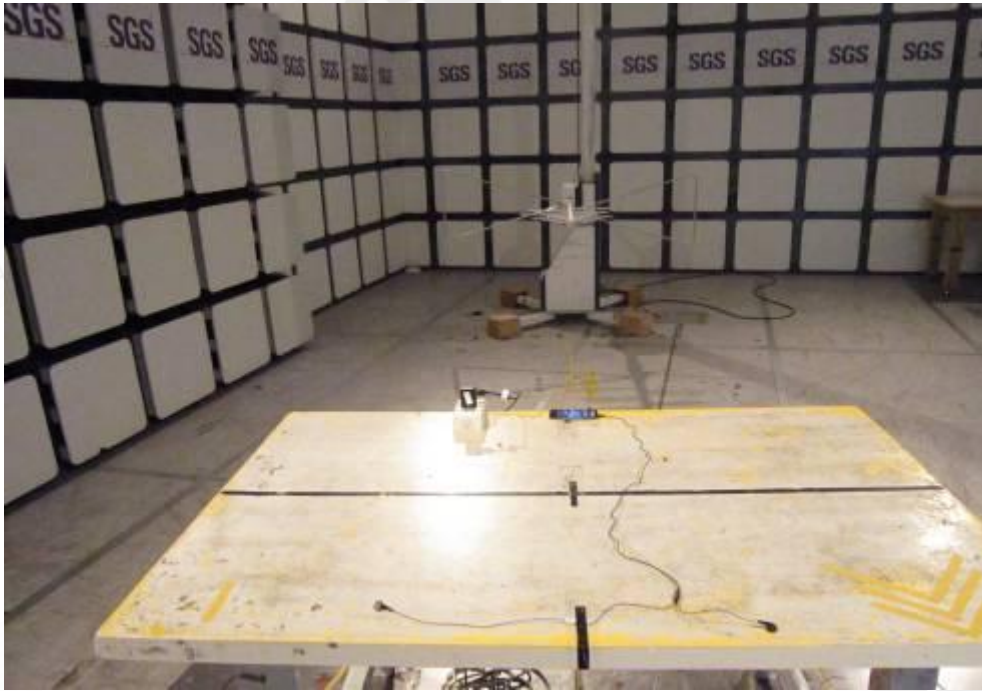

Unless otherwise stated the results shown in this test report refer only to the sample(s) tested and such sample(s) are retained for 90 days only.

除非另有說明，此報告結果僅對測試之樣品負責，同時此樣品僅保留90天。本報告未經本公司書面許可，不可部份複製。

This document is issued by the Company subject to its General Conditions of Service printed overleaf, available on request or accessible at [www.sgs.com/terms\\_and\\_conditions.htm](http://www.sgs.com/terms_and_conditions.htm) and, for electronic format documents, subject to Terms and Conditions for Electronic Documents at [www.sgs.com/terms\\_e-document.htm](http://www.sgs.com/terms_e-document.htm). Attention is drawn to the limitation of liability, indemnification and jurisdiction issues defined therein. Any holder of this document is advised that information contained hereon reflects the Company's findings at the time of its intervention only and within the limits of Client's instructions, if any. The Company's sole responsibility is to its Client and this document does not exonerate parties to a transaction from exercising all their rights and obligations under the transaction documents. This document cannot be reproduced except in full, without prior written approval of the Company. Any unauthorized alteration, forgery or falsification of the content or appearance of this document is unlawful and offenders may be prosecuted to the fullest extent of the law.



Config 3

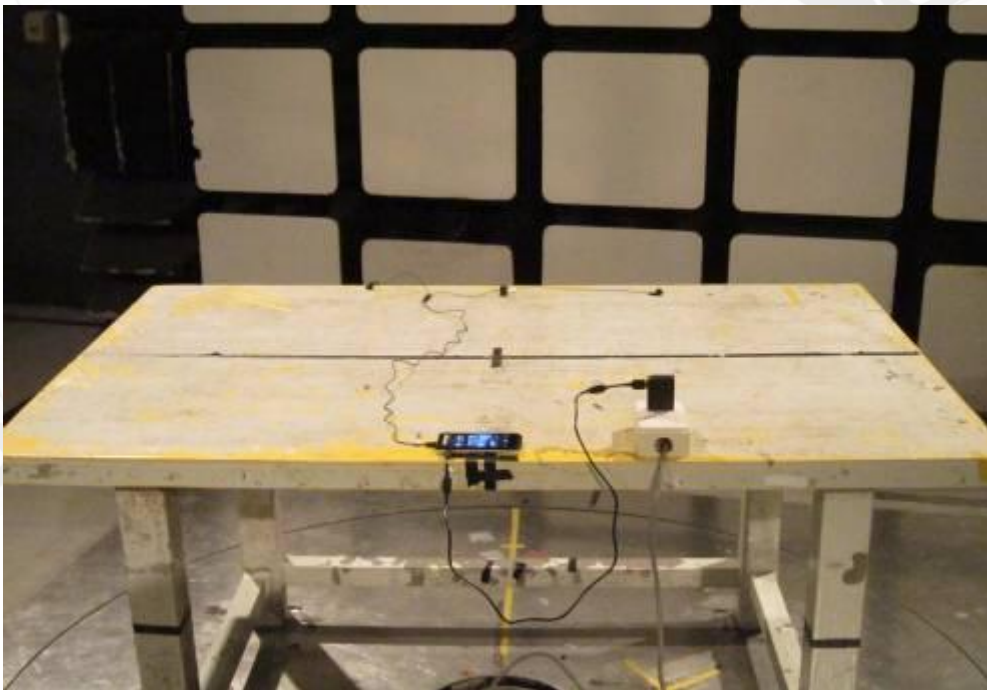
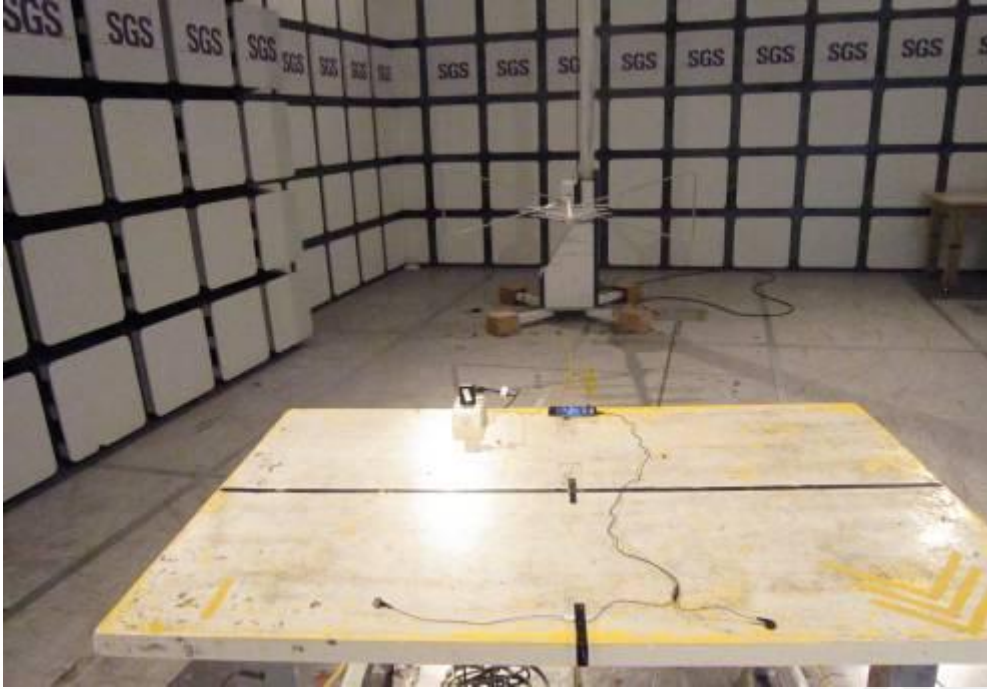

Unless otherwise stated the results shown in this test report refer only to the sample(s) tested and such sample(s) are retained for 90 days only.

除非另有說明，此報告結果僅對測試之樣品負責，同時此樣品僅保留90天。本報告未經本公司書面許可，不可部份複製。

This document is issued by the Company subject to its General Conditions of Service printed overleaf, available on request or accessible at [www.sgs.com/terms\\_and\\_conditions.htm](http://www.sgs.com/terms_and_conditions.htm) and, for electronic format documents, subject to Terms and Conditions for Electronic Documents at [www.sgs.com/terms\\_e-document.htm](http://www.sgs.com/terms_e-document.htm). Attention is drawn to the limitation of liability, indemnification and jurisdiction issues defined therein. Any holder of this document is advised that information contained hereon reflects the Company's findings at the time of its intervention only and within the limits of Client's instructions, if any. The Company's sole responsibility is to its Client and this document does not exonerate parties to a transaction from exercising all their rights and obligations under the transaction documents. This document cannot be reproduced except in full, without prior written approval of the Company. Any unauthorized alteration, forgery or falsification of the content or appearance of this document is unlawful and offenders may be prosecuted to the fullest extent of the law.

Above 1G

Config 1



Unless otherwise stated the results shown in this test report refer only to the sample(s) tested and such sample(s) are retained for 90 days only.

除非另有說明，此報告結果僅對測試之樣品負責，同時此樣品僅保留90天。本報告未經本公司書面許可，不可部份複製。

This document is issued by the Company subject to its General Conditions of Service printed overleaf, available on request or accessible at [www.sgs.com/terms\\_and\\_conditions.htm](http://www.sgs.com/terms_and_conditions.htm) and, for electronic format documents, subject to Terms and Conditions for Electronic Documents at [www.sgs.com/terms\\_e-document.htm](http://www.sgs.com/terms_e-document.htm). Attention is drawn to the limitation of liability, indemnification and jurisdiction issues defined therein. Any holder of this document is advised that information contained hereon reflects the Company's findings at the time of its intervention only and within the limits of Client's instructions, if any. The Company's sole responsibility is to its Client and this document does not exonerate parties to a transaction from exercising all their rights and obligations under the transaction documents. This document cannot be reproduced except in full, without prior written approval of the Company. Any unauthorized alteration, forgery or falsification of the content or appearance of this document is unlawful and offenders may be prosecuted to the fullest extent of the law.

Config 2

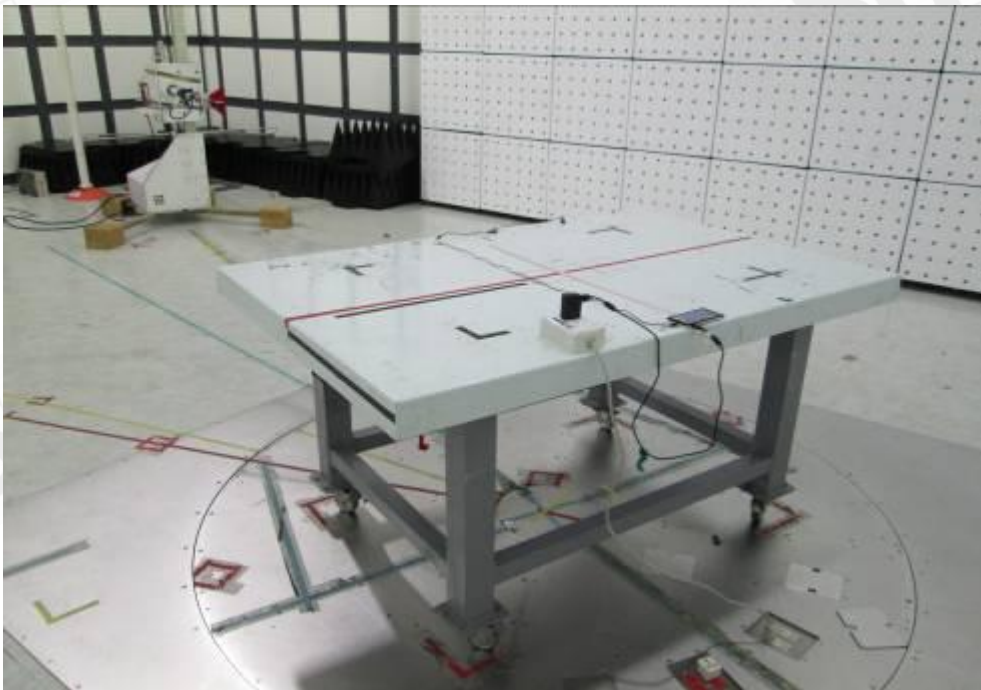
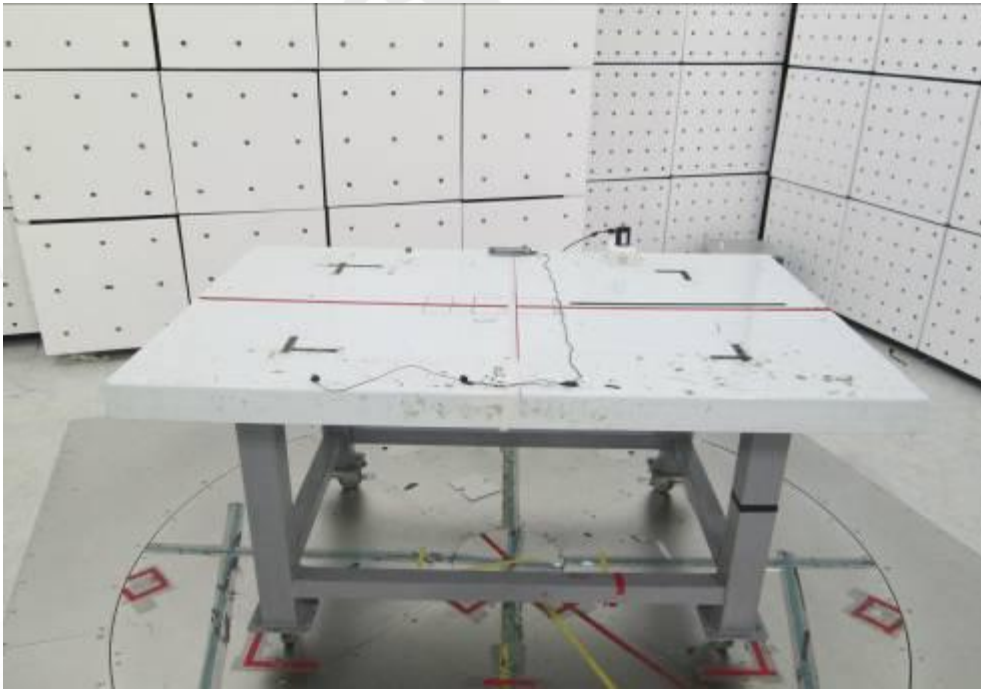

Unless otherwise stated the results shown in this test report refer only to the sample(s) tested and such sample(s) are retained for 90 days only.

除非另有說明，此報告結果僅對測試之樣品負責，同時此樣品僅保留90天。本報告未經本公司書面許可，不可部份複製。

This document is issued by the Company subject to its General Conditions of Service printed overleaf, available on request or accessible at [www.sgs.com/terms\\_and\\_conditions.htm](http://www.sgs.com/terms_and_conditions.htm) and, for electronic format documents, subject to Terms and Conditions for Electronic Documents at [www.sgs.com/terms\\_e-document.htm](http://www.sgs.com/terms_e-document.htm). Attention is drawn to the limitation of liability, indemnification and jurisdiction issues defined therein. Any holder of this document is advised that information contained hereon reflects the Company's findings at the time of its intervention only and within the limits of Client's instructions, if any. The Company's sole responsibility is to its Client and this document does not exonerate parties to a transaction from exercising all their rights and obligations under the transaction documents. This document cannot be reproduced except in full, without prior written approval of the Company. Any unauthorized alteration, forgery or falsification of the content or appearance of this document is unlawful and offenders may be prosecuted to the fullest extent of the law.



#### 4. Photographs of Product

##### Exterior



Unless otherwise stated the results shown in this test report refer only to the sample(s) tested and such sample(s) are retained for 90 days only.

除非另有說明，此報告結果僅對測試之樣品負責，同時此樣品僅保留90天。本報告未經本公司書面許可，不可部份複製。

This document is issued by the Company subject to its General Conditions of Service printed overleaf, available on request or accessible at [www.sgs.com/terms\\_and\\_conditions.htm](http://www.sgs.com/terms_and_conditions.htm) and, for electronic format documents, subject to Terms and Conditions for Electronic Documents at [www.sgs.com/terms\\_e-document.htm](http://www.sgs.com/terms_e-document.htm). Attention is drawn to the limitation of liability, indemnification and jurisdiction issues defined therein. Any holder of this document is advised that information contained hereon reflects the Company's findings at the time of its intervention only and within the limits of Client's instructions, if any. The Company's sole responsibility is to its Client and this document does not exonerate parties to a transaction from exercising all their rights and obligations under the transaction documents. This document cannot be reproduced except in full, without prior written approval of the Company. Any unauthorized alteration, forgery or falsification of the content or appearance of this document is unlawful and offenders may be prosecuted to the fullest extent of the law.



Unless otherwise stated the results shown in this test report refer only to the sample(s) tested and such sample(s) are retained for 90 days only.

除非另有說明，此報告結果僅對測試之樣品負責，同時此樣品僅保留90天。本報告未經本公司書面許可，不可部份複製。

This document is issued by the Company subject to its General Conditions of Service printed overleaf, available on request or accessible at [www.sgs.com/terms\\_and\\_conditions.htm](http://www.sgs.com/terms_and_conditions.htm) and, for electronic format documents, subject to Terms and Conditions for Electronic Documents at [www.sgs.com/terms\\_e-document.htm](http://www.sgs.com/terms_e-document.htm). Attention is drawn to the limitation of liability, indemnification and jurisdiction issues defined therein. Any holder of this document is advised that information contained hereon reflects the Company's findings at the time of its intervention only and within the limits of Client's instructions, if any. The Company's sole responsibility is to its Client and this document does not exonerate parties to a transaction from exercising all their rights and obligations under the transaction documents. This document cannot be reproduced except in full, without prior written approval of the Company. Any unauthorized alteration, forgery or falsification of the content or appearance of this document is unlawful and offenders may be prosecuted to the fullest extent of the law.



Unless otherwise stated the results shown in this test report refer only to the sample(s) tested and such sample(s) are retained for 90 days only.

除非另有說明，此報告結果僅對測試之樣品負責，同時此樣品僅保留90天。本報告未經本公司書面許可，不可部份複製。

This document is issued by the Company subject to its General Conditions of Service printed overleaf, available on request or accessible at [www.sgs.com/terms\\_and\\_conditions.htm](http://www.sgs.com/terms_and_conditions.htm) and, for electronic format documents, subject to Terms and Conditions for Electronic Documents at [www.sgs.com/terms\\_e-document.htm](http://www.sgs.com/terms_e-document.htm). Attention is drawn to the limitation of liability, indemnification and jurisdiction issues defined therein. Any holder of this document is advised that information contained hereon reflects the Company's findings at the time of its intervention only and within the limits of Client's instructions, if any. The Company's sole responsibility is to its Client and this document does not exonerate parties to a transaction from exercising all their rights and obligations under the transaction documents. This document cannot be reproduced except in full, without prior written approval of the Company. Any unauthorized alteration, forgery or falsification of the content or appearance of this document is unlawful and offenders may be prosecuted to the fullest extent of the law.



Unless otherwise stated the results shown in this test report refer only to the sample(s) tested and such sample(s) are retained for 90 days only.

除非另有說明，此報告結果僅對測試之樣品負責，同時此樣品僅保留90天。本報告未經本公司書面許可，不可部份複製。

This document is issued by the Company subject to its General Conditions of Service printed overleaf, available on request or accessible at [www.sgs.com/terms\\_and\\_conditions.htm](http://www.sgs.com/terms_and_conditions.htm) and, for electronic format documents, subject to Terms and Conditions for Electronic Documents at [www.sgs.com/terms\\_e-document.htm](http://www.sgs.com/terms_e-document.htm). Attention is drawn to the limitation of liability, indemnification and jurisdiction issues defined therein. Any holder of this document is advised that information contained hereon reflects the Company's findings at the time of its intervention only and within the limits of Client's instructions, if any. The Company's sole responsibility is to its Client and this document does not exonerate parties to a transaction from exercising all their rights and obligations under the transaction documents. This document cannot be reproduced except in full, without prior written approval of the Company. Any unauthorized alteration, forgery or falsification of the content or appearance of this document is unlawful and offenders may be prosecuted to the fullest extent of the law.



Unless otherwise stated the results shown in this test report refer only to the sample(s) tested and such sample(s) are retained for 90 days only.

除非另有說明，此報告結果僅對測試之樣品負責，同時此樣品僅保留90天。本報告未經本公司書面許可，不可部份複製。

This document is issued by the Company subject to its General Conditions of Service printed overleaf, available on request or accessible at [www.sgs.com/terms\\_and\\_conditions.htm](http://www.sgs.com/terms_and_conditions.htm) and, for electronic format documents, subject to Terms and Conditions for Electronic Documents at [www.sgs.com/terms\\_e-document.htm](http://www.sgs.com/terms_e-document.htm). Attention is drawn to the limitation of liability, indemnification and jurisdiction issues defined therein. Any holder of this document is advised that information contained hereon reflects the Company's findings at the time of its intervention only and within the limits of Client's instructions, if any. The Company's sole responsibility is to its Client and this document does not exonerate parties to a transaction from exercising all their rights and obligations under the transaction documents. This document cannot be reproduced except in full, without prior written approval of the Company. Any unauthorized alteration, forgery or falsification of the content or appearance of this document is unlawful and offenders may be prosecuted to the fullest extent of the law.





Unless otherwise stated the results shown in this test report refer only to the sample(s) tested and such sample(s) are retained for 90 days only.

除非另有說明，此報告結果僅對測試之樣品負責，同時此樣品僅保留90天。本報告未經本公司書面許可，不可部份複製。

This document is issued by the Company subject to its General Conditions of Service printed overleaf, available on request or accessible at [www.sgs.com/terms\\_and\\_conditions.htm](http://www.sgs.com/terms_and_conditions.htm) and, for electronic format documents, subject to Terms and Conditions for Electronic Documents at [www.sgs.com/terms\\_e-document.htm](http://www.sgs.com/terms_e-document.htm). Attention is drawn to the limitation of liability, indemnification and jurisdiction issues defined therein. Any holder of this document is advised that information contained hereon reflects the Company's findings at the time of its intervention only and within the limits of Client's instructions, if any. The Company's sole responsibility is to its Client and this document does not exonerate parties to a transaction from exercising all their rights and obligations under the transaction documents. This document cannot be reproduced except in full, without prior written approval of the Company. Any unauthorized alteration, forgery or falsification of the content or appearance of this document is unlawful and offenders may be prosecuted to the fullest extent of the law.



Unless otherwise stated the results shown in this test report refer only to the sample(s) tested and such sample(s) are retained for 90 days only.

除非另有說明，此報告結果僅對測試之樣品負責，同時此樣品僅保留90天。本報告未經本公司書面許可，不可部份複製。

This document is issued by the Company subject to its General Conditions of Service printed overleaf, available on request or accessible at [www.sgs.com/terms\\_and\\_conditions.htm](http://www.sgs.com/terms_and_conditions.htm) and, for electronic format documents, subject to Terms and Conditions for Electronic Documents at [www.sgs.com/terms\\_e-document.htm](http://www.sgs.com/terms_e-document.htm). Attention is drawn to the limitation of liability, indemnification and jurisdiction issues defined therein. Any holder of this document is advised that information contained hereon reflects the Company's findings at the time of its intervention only and within the limits of Client's instructions, if any. The Company's sole responsibility is to its Client and this document does not exonerate parties to a transaction from exercising all their rights and obligations under the transaction documents. This document cannot be reproduced except in full, without prior written approval of the Company. Any unauthorized alteration, forgery or falsification of the content or appearance of this document is unlawful and offenders may be prosecuted to the fullest extent of the law.



Unless otherwise stated the results shown in this test report refer only to the sample(s) tested and such sample(s) are retained for 90 days only.

除非另有說明，此報告結果僅對測試之樣品負責，同時此樣品僅保留90天。本報告未經本公司書面許可，不可部份複製。

This document is issued by the Company subject to its General Conditions of Service printed overleaf, available on request or accessible at [www.sgs.com/terms\\_and\\_conditions.htm](http://www.sgs.com/terms_and_conditions.htm) and, for electronic format documents, subject to Terms and Conditions for Electronic Documents at [www.sgs.com/terms\\_e-document.htm](http://www.sgs.com/terms_e-document.htm). Attention is drawn to the limitation of liability, indemnification and jurisdiction issues defined therein. Any holder of this document is advised that information contained hereon reflects the Company's findings at the time of its intervention only and within the limits of Client's instructions, if any. The Company's sole responsibility is to its Client and this document does not exonerate parties to a transaction from exercising all their rights and obligations under the transaction documents. This document cannot be reproduced except in full, without prior written approval of the Company. Any unauthorized alteration, forgery or falsification of the content or appearance of this document is unlawful and offenders may be prosecuted to the fullest extent of the law.

## Interior

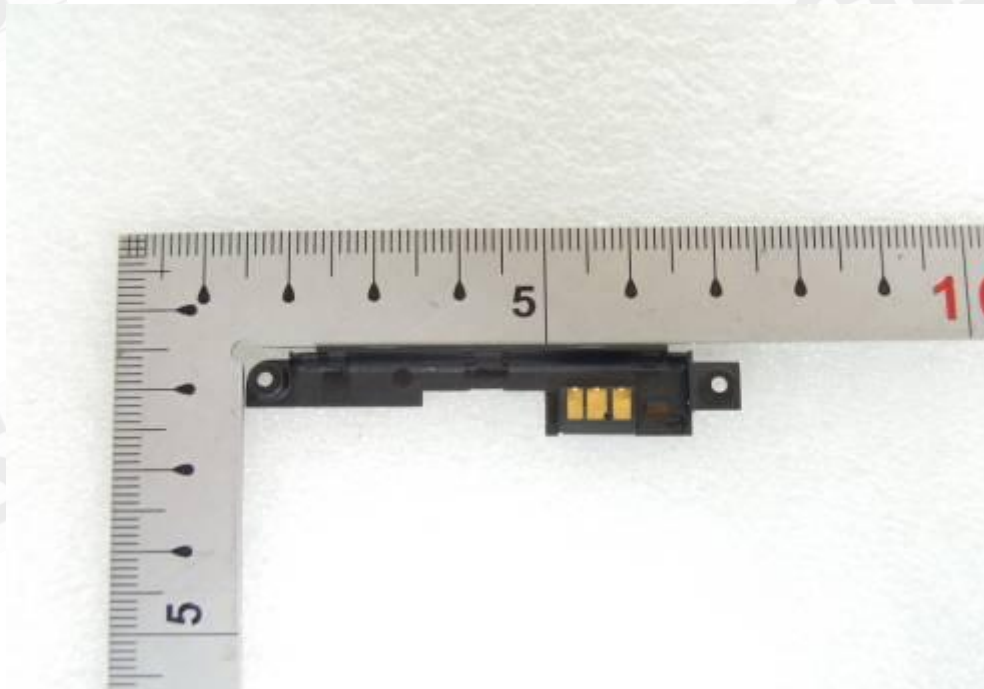
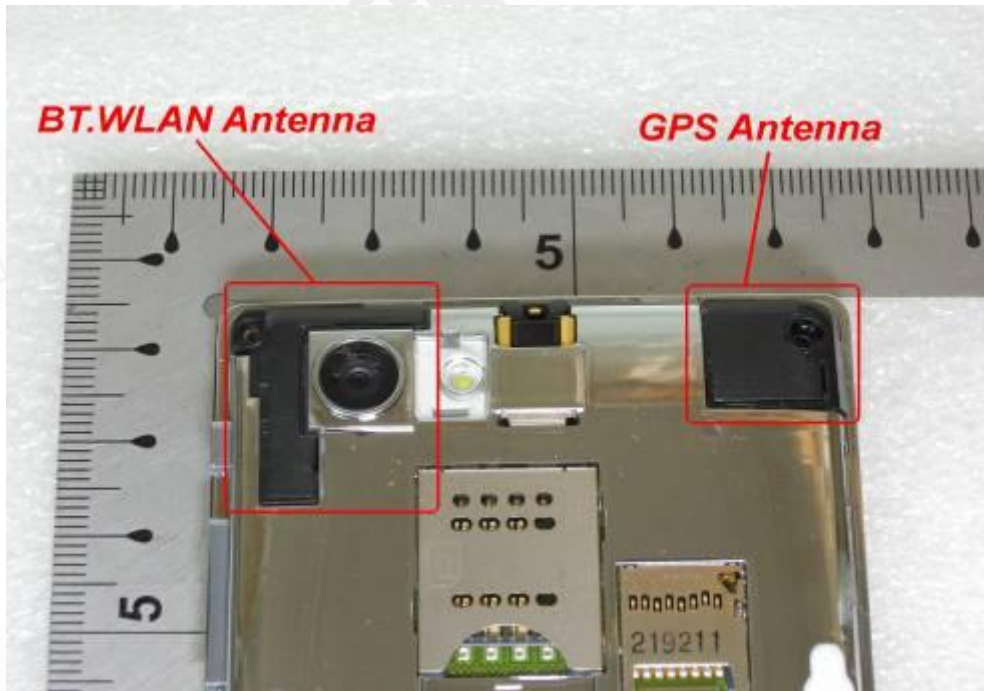

Unless otherwise stated the results shown in this test report refer only to the sample(s) tested and such sample(s) are retained for 90 days only.

除非另有說明，此報告結果僅對測試之樣品負責，同時此樣品僅保留90天。本報告未經本公司書面許可，不可部份複製。

This document is issued by the Company subject to its General Conditions of Service printed overleaf, available on request or accessible at [www.sgs.com/terms\\_and\\_conditions.htm](http://www.sgs.com/terms_and_conditions.htm) and, for electronic format documents, subject to Terms and Conditions for Electronic Documents at [www.sgs.com/terms\\_e-document.htm](http://www.sgs.com/terms_e-document.htm). Attention is drawn to the limitation of liability, indemnification and jurisdiction issues defined therein. Any holder of this document is advised that information contained hereon reflects the Company's findings at the time of its intervention only and within the limits of Client's instructions, if any. The Company's sole responsibility is to its Client and this document does not exonerate parties to a transaction from exercising all their rights and obligations under the transaction documents. This document cannot be reproduced except in full, without prior written approval of the Company. Any unauthorized alteration, forgery or falsification of the content or appearance of this document is unlawful and offenders may be prosecuted to the fullest extent of the law.

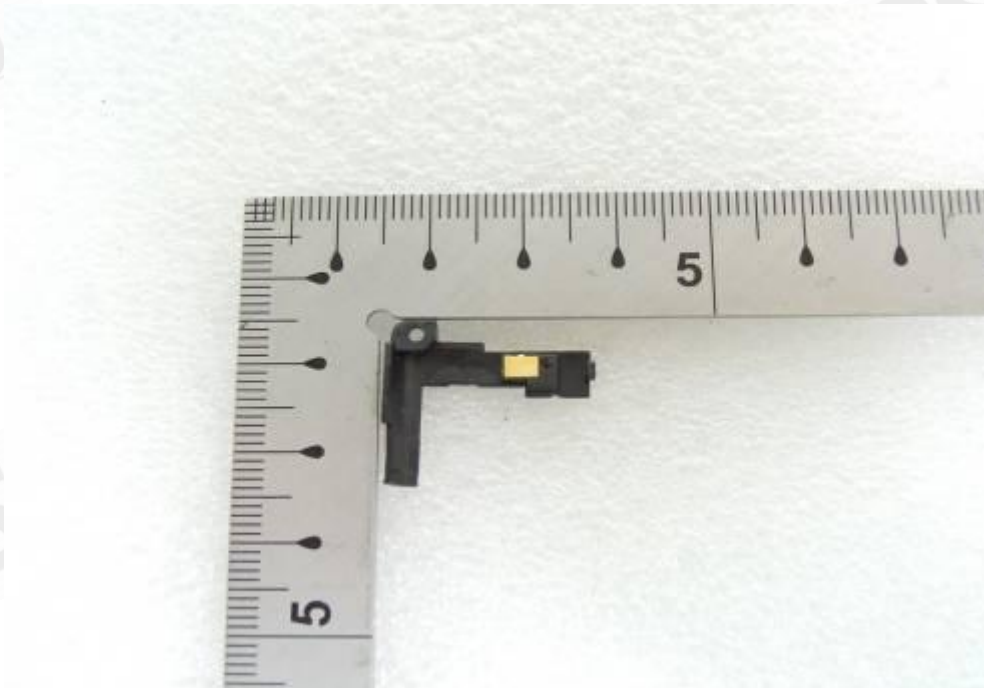
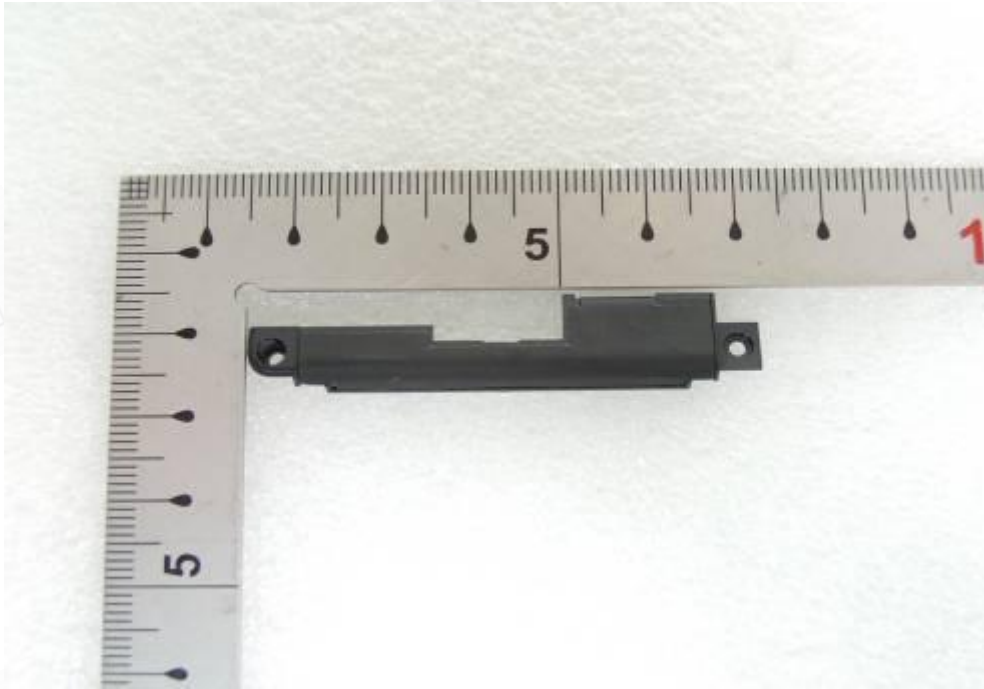

Unless otherwise stated the results shown in this test report refer only to the sample(s) tested and such sample(s) are retained for 90 days only.

除非另有說明，此報告結果僅對測試之樣品負責，同時此樣品僅保留90天。本報告未經本公司書面許可，不可部份複製。

This document is issued by the Company subject to its General Conditions of Service printed overleaf, available on request or accessible at [www.sgs.com/terms\\_and\\_conditions.htm](http://www.sgs.com/terms_and_conditions.htm) and, for electronic format documents, subject to Terms and Conditions for Electronic Documents at [www.sgs.com/terms\\_e-document.htm](http://www.sgs.com/terms_e-document.htm). Attention is drawn to the limitation of liability, indemnification and jurisdiction issues defined therein. Any holder of this document is advised that information contained hereon reflects the Company's findings at the time of its intervention only and within the limits of Client's instructions, if any. The Company's sole responsibility is to its Client and this document does not exonerate parties to a transaction from exercising all their rights and obligations under the transaction documents. This document cannot be reproduced except in full, without prior written approval of the Company. Any unauthorized alteration, forgery or falsification of the content or appearance of this document is unlawful and offenders may be prosecuted to the fullest extent of the law.



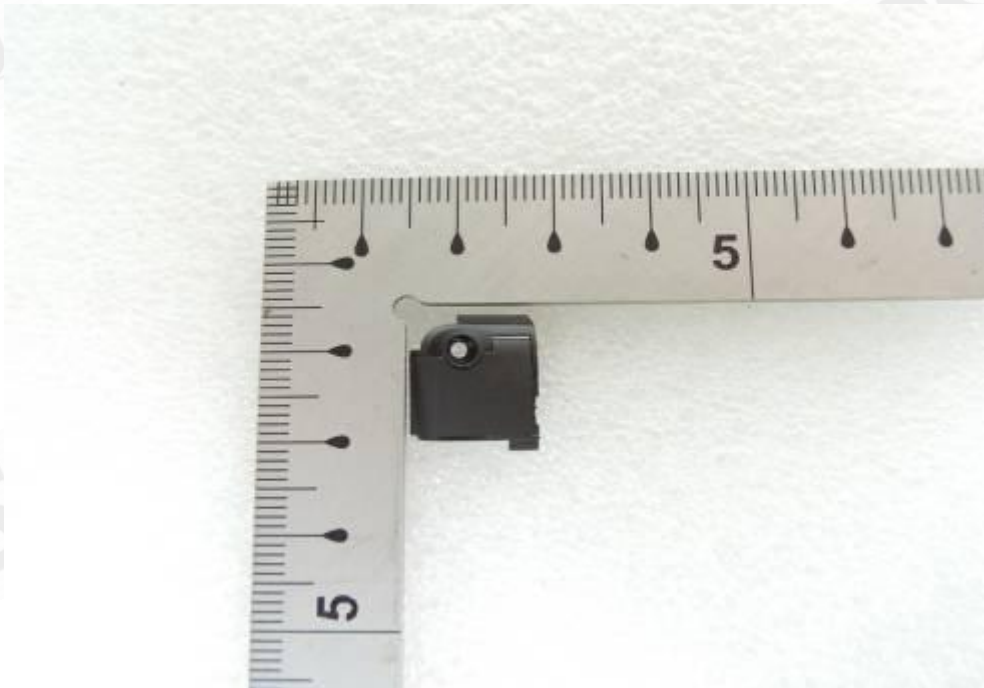
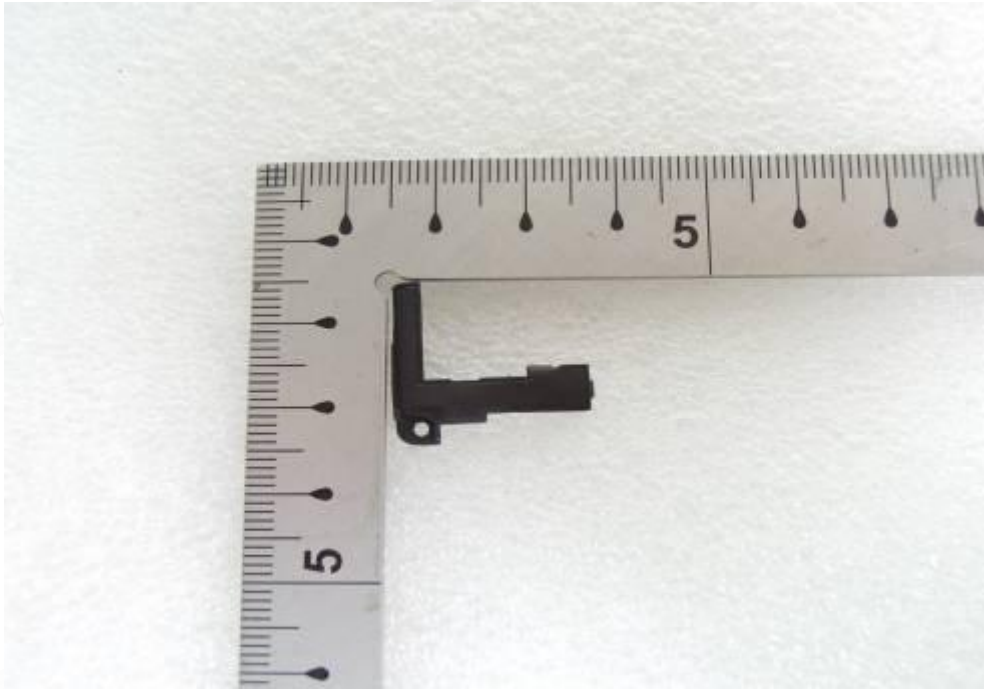

Unless otherwise stated the results shown in this test report refer only to the sample(s) tested and such sample(s) are retained for 90 days only.

除非另有說明，此報告結果僅對測試之樣品負責，同時此樣品僅保留90天。本報告未經本公司書面許可，不可部份複製。

This document is issued by the Company subject to its General Conditions of Service printed overleaf, available on request or accessible at [www.sgs.com/terms\\_and\\_conditions.htm](http://www.sgs.com/terms_and_conditions.htm) and, for electronic format documents, subject to Terms and Conditions for Electronic Documents at [www.sgs.com/terms\\_e-document.htm](http://www.sgs.com/terms_e-document.htm). Attention is drawn to the limitation of liability, indemnification and jurisdiction issues defined therein. Any holder of this document is advised that information contained hereon reflects the Company's findings at the time of its intervention only and within the limits of Client's instructions, if any. The Company's sole responsibility is to its Client and this document does not exonerate parties to a transaction from exercising all their rights and obligations under the transaction documents. This document cannot be reproduced except in full, without prior written approval of the Company. Any unauthorized alteration, forgery or falsification of the content or appearance of this document is unlawful and offenders may be prosecuted to the fullest extent of the law.

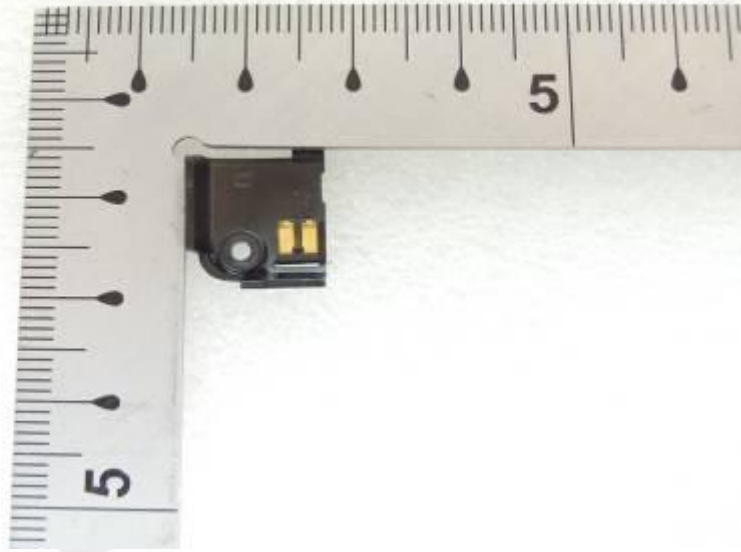

Unless otherwise stated the results shown in this test report refer only to the sample(s) tested and such sample(s) are retained for 90 days only.

除非另有說明，此報告結果僅對測試之樣品負責，同時此樣品僅保留90天。本報告未經本公司書面許可，不可部份複製。

This document is issued by the Company subject to its General Conditions of Service printed overleaf, available on request or accessible at [www.sgs.com/terms\\_and\\_conditions.htm](http://www.sgs.com/terms_and_conditions.htm) and, for electronic format documents, subject to Terms and Conditions for Electronic Documents at [www.sgs.com/terms\\_e-document.htm](http://www.sgs.com/terms_e-document.htm). Attention is drawn to the limitation of liability, indemnification and jurisdiction issues defined therein. Any holder of this document is advised that information contained hereon reflects the Company's findings at the time of its intervention only and within the limits of Client's instructions, if any. The Company's sole responsibility is to its Client and this document does not exonerate parties to a transaction from exercising all their rights and obligations under the transaction documents. This document cannot be reproduced except in full, without prior written approval of the Company. Any unauthorized alteration, forgery or falsification of the content or appearance of this document is unlawful and offenders may be prosecuted to the fullest extent of the law.

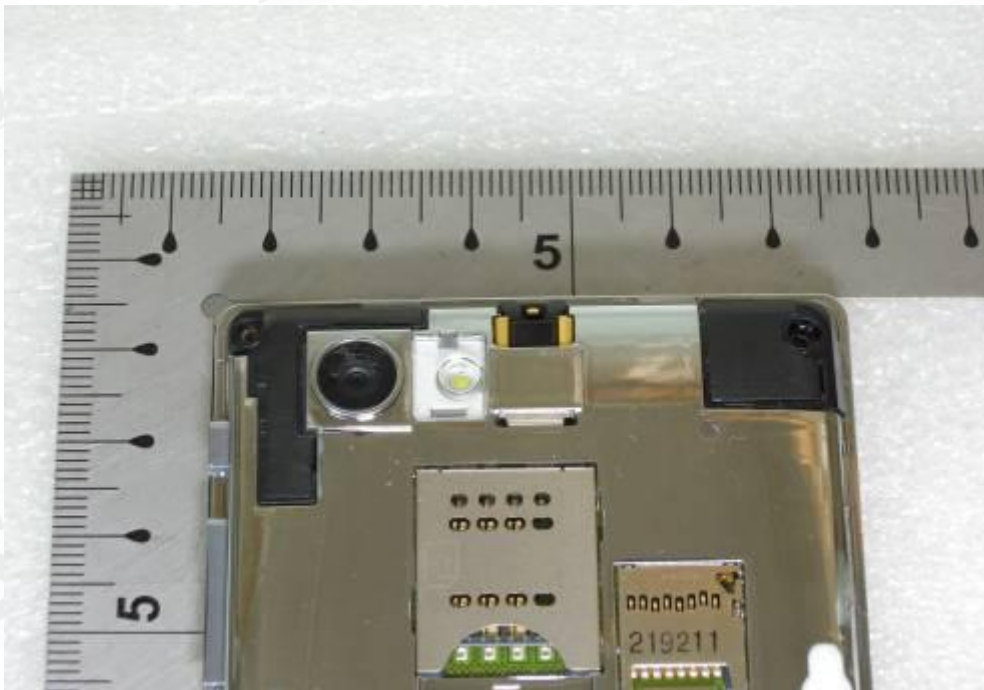

Unless otherwise stated the results shown in this test report refer only to the sample(s) tested and such sample(s) are retained for 90 days only.

除非另有說明，此報告結果僅對測試之樣品負責，同時此樣品僅保留90天。本報告未經本公司書面許可，不可部份複製。

This document is issued by the Company subject to its General Conditions of Service printed overleaf, available on request or accessible at [www.sgs.com/terms\\_and\\_conditions.htm](http://www.sgs.com/terms_and_conditions.htm) and, for electronic format documents, subject to Terms and Conditions for Electronic Documents at [www.sgs.com/terms\\_e-document.htm](http://www.sgs.com/terms_e-document.htm). Attention is drawn to the limitation of liability, indemnification and jurisdiction issues defined therein. Any holder of this document is advised that information contained hereon reflects the Company's findings at the time of its intervention only and within the limits of Client's instructions, if any. The Company's sole responsibility is to its Client and this document does not exonerate parties to a transaction from exercising all their rights and obligations under the transaction documents. This document cannot be reproduced except in full, without prior written approval of the Company. Any unauthorized alteration, forgery or falsification of the content or appearance of this document is unlawful and offenders may be prosecuted to the fullest extent of the law.



Unless otherwise stated the results shown in this test report refer only to the sample(s) tested and such sample(s) are retained for 90 days only.

除非另有說明，此報告結果僅對測試之樣品負責，同時此樣品僅保留90天。本報告未經本公司書面許可，不可部份複製。

This document is issued by the Company subject to its General Conditions of Service printed overleaf, available on request or accessible at [www.sgs.com/terms\\_and\\_conditions.htm](http://www.sgs.com/terms_and_conditions.htm) and, for electronic format documents, subject to Terms and Conditions for Electronic Documents at [www.sgs.com/terms\\_e-document.htm](http://www.sgs.com/terms_e-document.htm). Attention is drawn to the limitation of liability, indemnification and jurisdiction issues defined therein. Any holder of this document is advised that information contained hereon reflects the Company's findings at the time of its intervention only and within the limits of Client's instructions, if any. The Company's sole responsibility is to its Client and this document does not exonerate parties to a transaction from exercising all their rights and obligations under the transaction documents. This document cannot be reproduced except in full, without prior written approval of the Company. Any unauthorized alteration, forgery or falsification of the content or appearance of this document is unlawful and offenders may be prosecuted to the fullest extent of the law.





Unless otherwise stated the results shown in this test report refer only to the sample(s) tested and such sample(s) are retained for 90 days only.

除非另有說明，此報告結果僅對測試之樣品負責，同時此樣品僅保留90天。本報告未經本公司書面許可，不可部份複製。

This document is issued by the Company subject to its General Conditions of Service printed overleaf, available on request or accessible at [www.sgs.com/terms\\_and\\_conditions.htm](http://www.sgs.com/terms_and_conditions.htm) and, for electronic format documents, subject to Terms and Conditions for Electronic Documents at [www.sgs.com/terms\\_e-document.htm](http://www.sgs.com/terms_e-document.htm). Attention is drawn to the limitation of liability, indemnification and jurisdiction issues defined therein. Any holder of this document is advised that information contained hereon reflects the Company's findings at the time of its intervention only and within the limits of Client's instructions, if any. The Company's sole responsibility is to its Client and this document does not exonerate parties to a transaction from exercising all their rights and obligations under the transaction documents. This document cannot be reproduced except in full, without prior written approval of the Company. Any unauthorized alteration, forgery or falsification of the content or appearance of this document is unlawful and offenders may be prosecuted to the fullest extent of the law.





Unless otherwise stated the results shown in this test report refer only to the sample(s) tested and such sample(s) are retained for 90 days only.

除非另有說明，此報告結果僅對測試之樣品負責，同時此樣品僅保留90天。本報告未經本公司書面許可，不可部份複製。

This document is issued by the Company subject to its General Conditions of Service printed overleaf, available on request or accessible at [www.sgs.com/terms\\_and\\_conditions.htm](http://www.sgs.com/terms_and_conditions.htm) and, for electronic format documents, subject to Terms and Conditions for Electronic Documents at [www.sgs.com/terms\\_e-document.htm](http://www.sgs.com/terms_e-document.htm). Attention is drawn to the limitation of liability, indemnification and jurisdiction issues defined therein. Any holder of this document is advised that information contained hereon reflects the Company's findings at the time of its intervention only and within the limits of Client's instructions, if any. The Company's sole responsibility is to its Client and this document does not exonerate parties to a transaction from exercising all their rights and obligations under the transaction documents. This document cannot be reproduced except in full, without prior written approval of the Company. Any unauthorized alteration, forgery or falsification of the content or appearance of this document is unlawful and offenders may be prosecuted to the fullest extent of the law.

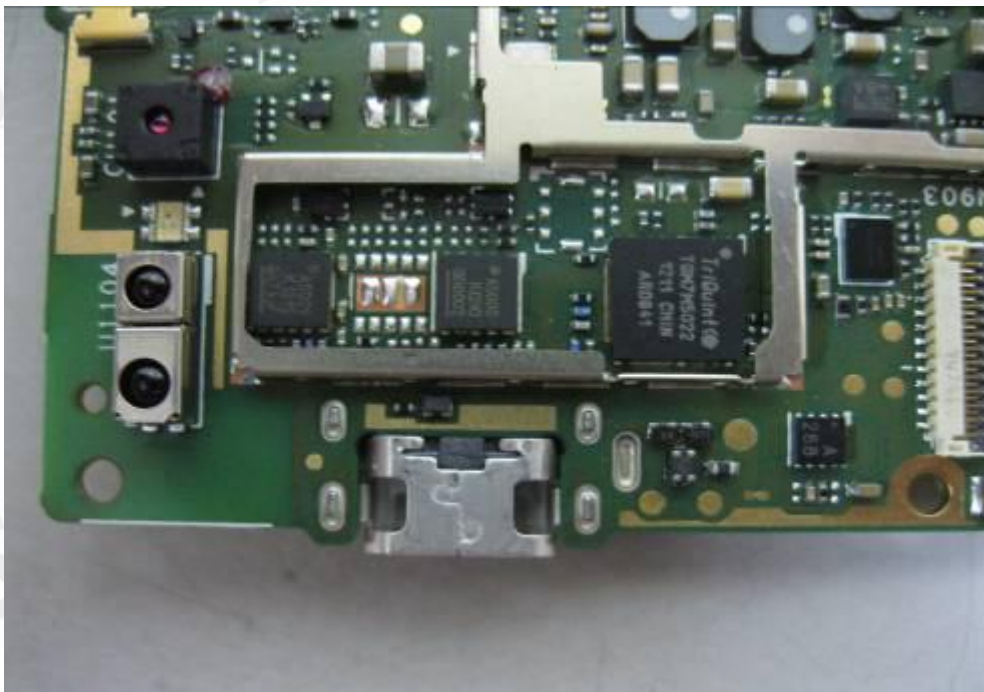
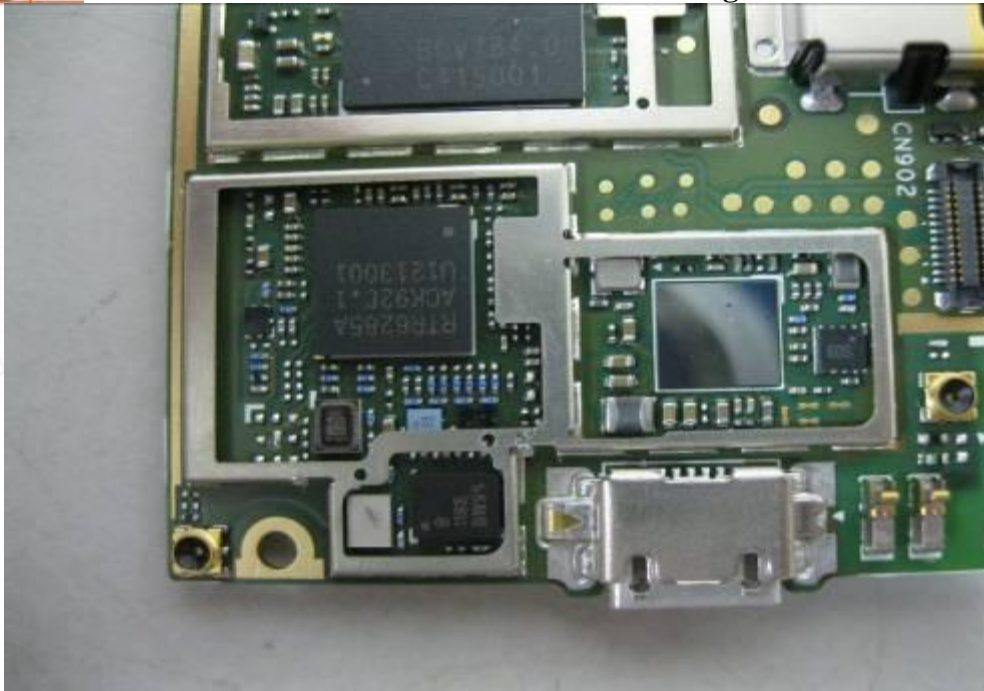

Unless otherwise stated the results shown in this test report refer only to the sample(s) tested and such sample(s) are retained for 90 days only.

除非另有說明，此報告結果僅對測試之樣品負責，同時此樣品僅保留90天。本報告未經本公司書面許可，不可部份複製。

This document is issued by the Company subject to its General Conditions of Service printed overleaf, available on request or accessible at [www.sgs.com/terms\\_and\\_conditions.htm](http://www.sgs.com/terms_and_conditions.htm) and, for electronic format documents, subject to Terms and Conditions for Electronic Documents at [www.sgs.com/terms\\_e-document.htm](http://www.sgs.com/terms_e-document.htm). Attention is drawn to the limitation of liability, indemnification and jurisdiction issues defined therein. Any holder of this document is advised that information contained hereon reflects the Company's findings at the time of its intervention only and within the limits of Client's instructions, if any. The Company's sole responsibility is to its Client and this document does not exonerate parties to a transaction from exercising all their rights and obligations under the transaction documents. This document cannot be reproduced except in full, without prior written approval of the Company. Any unauthorized alteration, forgery or falsification of the content or appearance of this document is unlawful and offenders may be prosecuted to the fullest extent of the law.

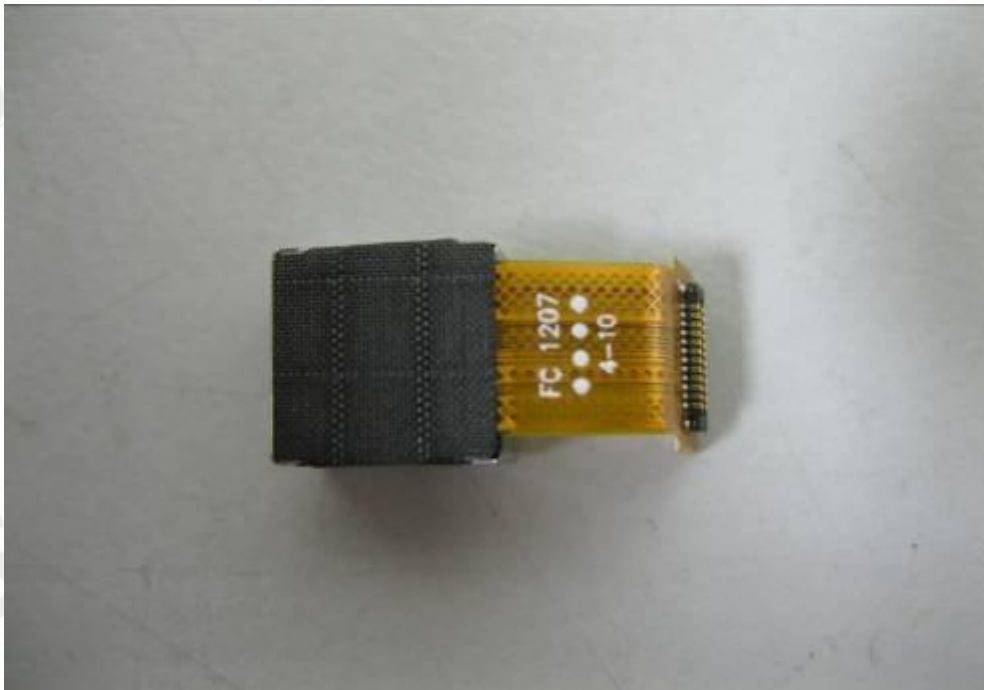

Unless otherwise stated the results shown in this test report refer only to the sample(s) tested and such sample(s) are retained for 90 days only.

除非另有說明，此報告結果僅對測試之樣品負責，同時此樣品僅保留90天。本報告未經本公司書面許可，不可部份複製。

This document is issued by the Company subject to its General Conditions of Service printed overleaf, available on request or accessible at [www.sgs.com/terms\\_and\\_conditions.htm](http://www.sgs.com/terms_and_conditions.htm) and, for electronic format documents, subject to Terms and Conditions for Electronic Documents at [www.sgs.com/terms\\_e-document.htm](http://www.sgs.com/terms_e-document.htm). Attention is drawn to the limitation of liability, indemnification and jurisdiction issues defined therein. Any holder of this document is advised that information contained hereon reflects the Company's findings at the time of its intervention only and within the limits of Client's instructions, if any. The Company's sole responsibility is to its Client and this document does not exonerate parties to a transaction from exercising all their rights and obligations under the transaction documents. This document cannot be reproduced except in full, without prior written approval of the Company. Any unauthorized alteration, forgery or falsification of the content or appearance of this document is unlawful and offenders may be prosecuted to the fullest extent of the law.

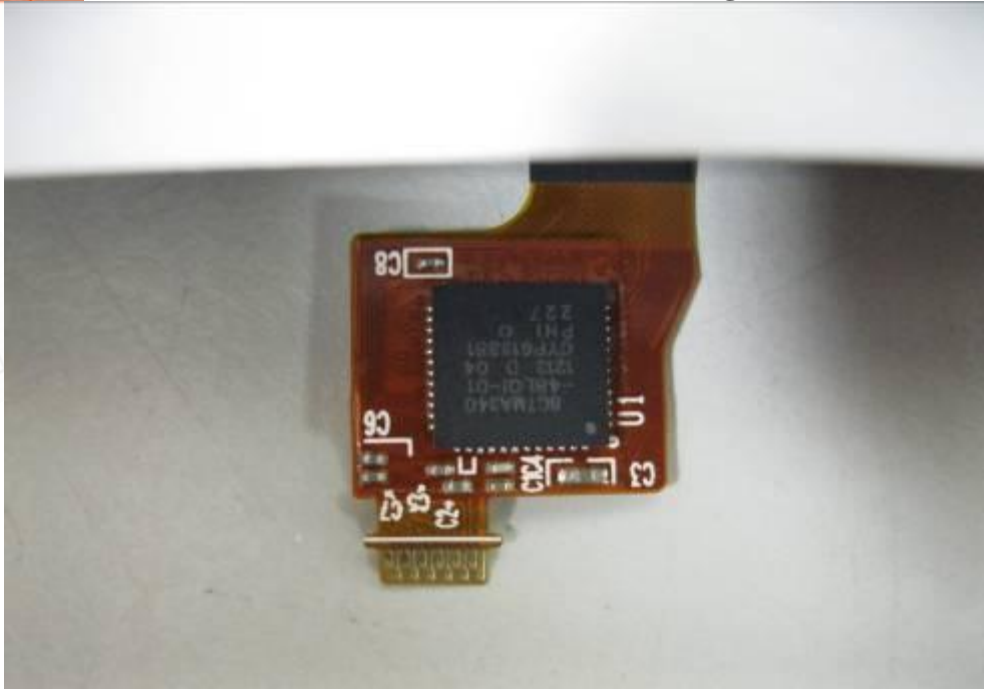

Unless otherwise stated the results shown in this test report refer only to the sample(s) tested and such sample(s) are retained for 90 days only.

除非另有說明，此報告結果僅對測試之樣品負責，同時此樣品僅保留90天。本報告未經本公司書面許可，不可部份複製。

This document is issued by the Company subject to its General Conditions of Service printed overleaf, available on request or accessible at [www.sgs.com/terms\\_and\\_conditions.htm](http://www.sgs.com/terms_and_conditions.htm) and, for electronic format documents, subject to Terms and Conditions for Electronic Documents at [www.sgs.com/terms\\_e-document.htm](http://www.sgs.com/terms_e-document.htm). Attention is drawn to the limitation of liability, indemnification and jurisdiction issues defined therein. Any holder of this document is advised that information contained hereon reflects the Company's findings at the time of its intervention only and within the limits of Client's instructions, if any. The Company's sole responsibility is to its Client and this document does not exonerate parties to a transaction from exercising all their rights and obligations under the transaction documents. This document cannot be reproduced except in full, without prior written approval of the Company. Any unauthorized alteration, forgery or falsification of the content or appearance of this document is unlawful and offenders may be prosecuted to the fullest extent of the law.



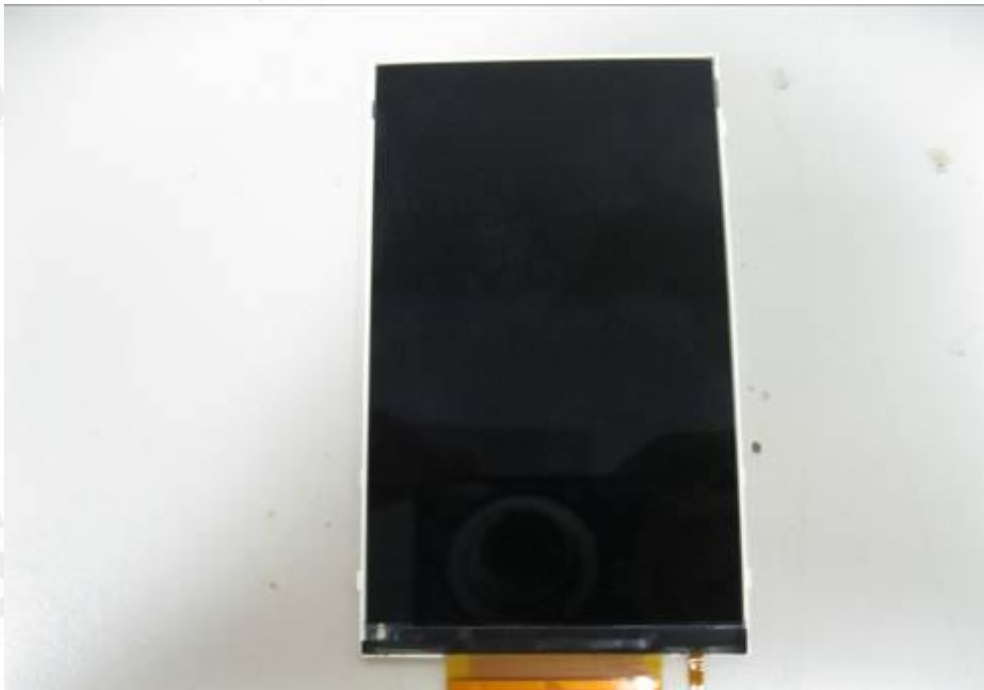

Unless otherwise stated the results shown in this test report refer only to the sample(s) tested and such sample(s) are retained for 90 days only.

除非另有說明，此報告結果僅對測試之樣品負責，同時此樣品僅保留90天。本報告未經本公司書面許可，不可部份複製。

This document is issued by the Company subject to its General Conditions of Service printed overleaf, available on request or accessible at [www.sgs.com/terms\\_and\\_conditions.htm](http://www.sgs.com/terms_and_conditions.htm) and, for electronic format documents, subject to Terms and Conditions for Electronic Documents at [www.sgs.com/terms\\_e-document.htm](http://www.sgs.com/terms_e-document.htm). Attention is drawn to the limitation of liability, indemnification and jurisdiction issues defined therein. Any holder of this document is advised that information contained hereon reflects the Company's findings at the time of its intervention only and within the limits of Client's instructions, if any. The Company's sole responsibility is to its Client and this document does not exonerate parties to a transaction from exercising all their rights and obligations under the transaction documents. This document cannot be reproduced except in full, without prior written approval of the Company. Any unauthorized alteration, forgery or falsification of the content or appearance of this document is unlawful and offenders may be prosecuted to the fullest extent of the law.





Unless otherwise stated the results shown in this test report refer only to the sample(s) tested and such sample(s) are retained for 90 days only.

除非另有說明，此報告結果僅對測試之樣品負責，同時此樣品僅保留90天。本報告未經本公司書面許可，不可部份複製。

This document is issued by the Company subject to its General Conditions of Service printed overleaf, available on request or accessible at [www.sgs.com/terms\\_and\\_conditions.htm](http://www.sgs.com/terms_and_conditions.htm) and, for electronic format documents, subject to Terms and Conditions for Electronic Documents at [www.sgs.com/terms\\_e-document.htm](http://www.sgs.com/terms_e-document.htm). Attention is drawn to the limitation of liability, indemnification and jurisdiction issues defined therein. Any holder of this document is advised that information contained hereon reflects the Company's findings at the time of its intervention only and within the limits of Client's instructions, if any. The Company's sole responsibility is to its Client and this document does not exonerate parties to a transaction from exercising all their rights and obligations under the transaction documents. This document cannot be reproduced except in full, without prior written approval of the Company. Any unauthorized alteration, forgery or falsification of the content or appearance of this document is unlawful and offenders may be prosecuted to the fullest extent of the law.



Unless otherwise stated the results shown in this test report refer only to the sample(s) tested and such sample(s) are retained for 90 days only.

除非另有說明，此報告結果僅對測試之樣品負責，同時此樣品僅保留90天。本報告未經本公司書面許可，不可部份複製。

This document is issued by the Company subject to its General Conditions of Service printed overleaf, available on request or accessible at [www.sgs.com/terms\\_and\\_conditions.htm](http://www.sgs.com/terms_and_conditions.htm) and, for electronic format documents, subject to Terms and Conditions for Electronic Documents at [www.sgs.com/terms\\_e-document.htm](http://www.sgs.com/terms_e-document.htm). Attention is drawn to the limitation of liability, indemnification and jurisdiction issues defined therein. Any holder of this document is advised that information contained hereon reflects the Company's findings at the time of its intervention only and within the limits of Client's instructions, if any. The Company's sole responsibility is to its Client and this document does not exonerate parties to a transaction from exercising all their rights and obligations under the transaction documents. This document cannot be reproduced except in full, without prior written approval of the Company. Any unauthorized alteration, forgery or falsification of the content or appearance of this document is unlawful and offenders may be prosecuted to the fullest extent of the law.

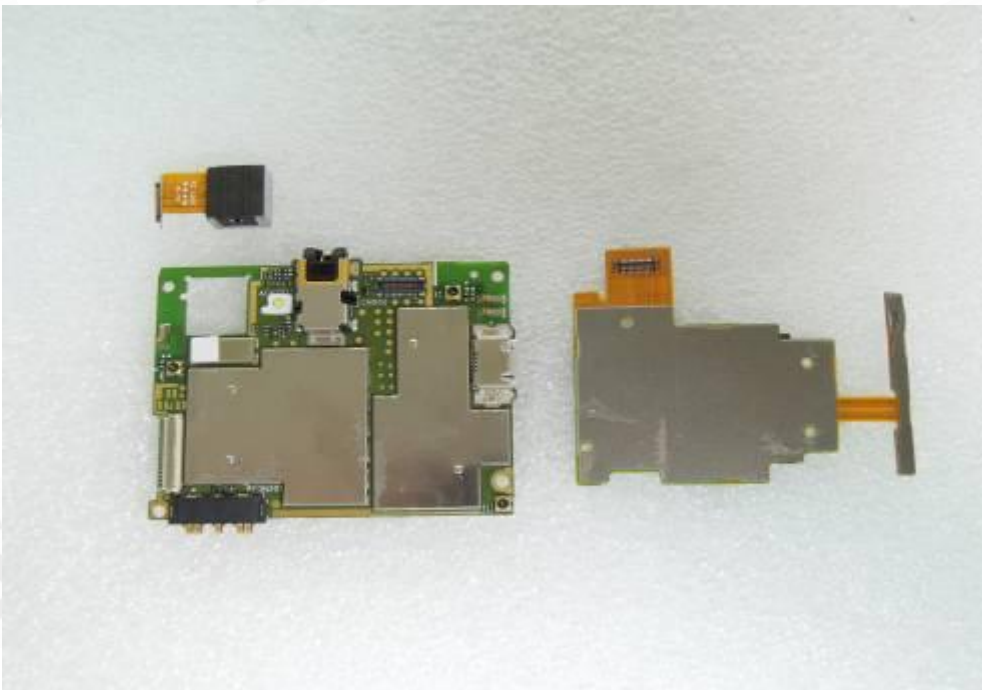

Unless otherwise stated the results shown in this test report refer only to the sample(s) tested and such sample(s) are retained for 90 days only.

除非另有說明，此報告結果僅對測試之樣品負責，同時此樣品僅保留90天。本報告未經本公司書面許可，不可部份複製。

This document is issued by the Company subject to its General Conditions of Service printed overleaf, available on request or accessible at [www.sgs.com/terms\\_and\\_conditions.htm](http://www.sgs.com/terms_and_conditions.htm) and, for electronic format documents, subject to Terms and Conditions for Electronic Documents at [www.sgs.com/terms\\_e-document.htm](http://www.sgs.com/terms_e-document.htm). Attention is drawn to the limitation of liability, indemnification and jurisdiction issues defined therein. Any holder of this document is advised that information contained hereon reflects the Company's findings at the time of its intervention only and within the limits of Client's instructions, if any. The Company's sole responsibility is to its Client and this document does not exonerate parties to a transaction from exercising all their rights and obligations under the transaction documents. This document cannot be reproduced except in full, without prior written approval of the Company. Any unauthorized alteration, forgery or falsification of the content or appearance of this document is unlawful and offenders may be prosecuted to the fullest extent of the law.

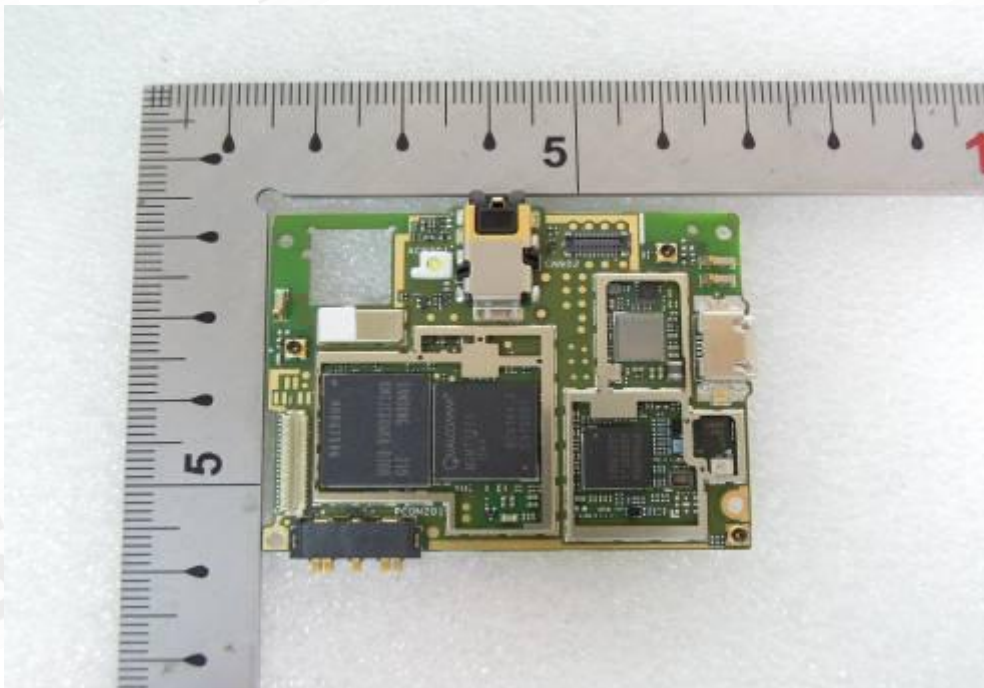
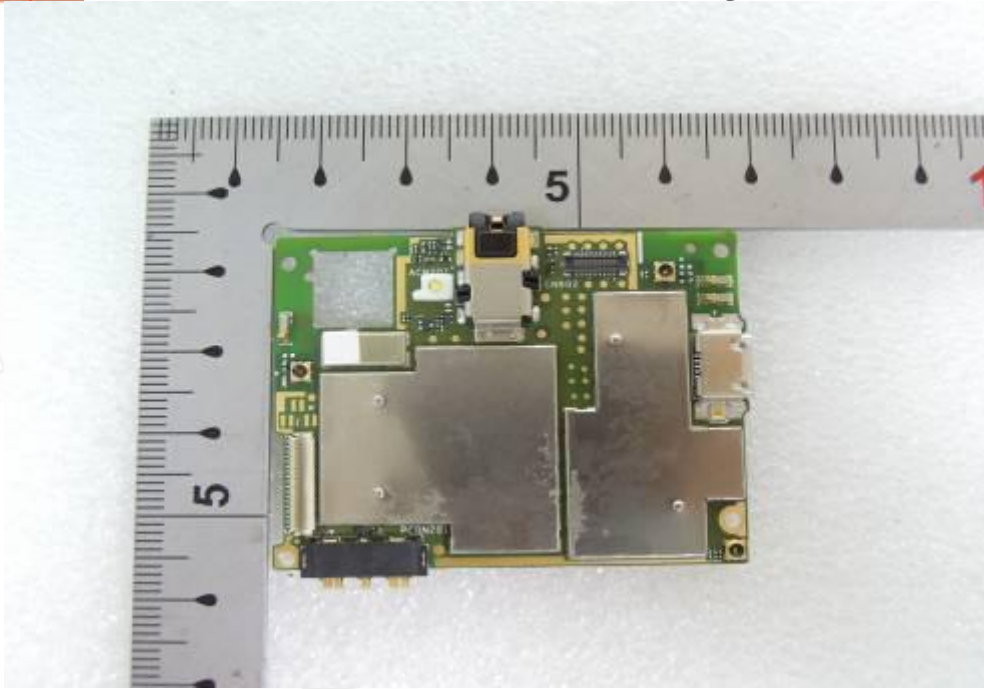

Unless otherwise stated the results shown in this test report refer only to the sample(s) tested and such sample(s) are retained for 90 days only.

除非另有說明，此報告結果僅對測試之樣品負責，同時此樣品僅保留90天。本報告未經本公司書面許可，不可部份複製。

This document is issued by the Company subject to its General Conditions of Service printed overleaf, available on request or accessible at [www.sgs.com/terms\\_and\\_conditions.htm](http://www.sgs.com/terms_and_conditions.htm) and, for electronic format documents, subject to Terms and Conditions for Electronic Documents at [www.sgs.com/terms\\_e-document.htm](http://www.sgs.com/terms_e-document.htm). Attention is drawn to the limitation of liability, indemnification and jurisdiction issues defined therein. Any holder of this document is advised that information contained hereon reflects the Company's findings at the time of its intervention only and within the limits of Client's instructions, if any. The Company's sole responsibility is to its Client and this document does not exonerate parties to a transaction from exercising all their rights and obligations under the transaction documents. This document cannot be reproduced except in full, without prior written approval of the Company. Any unauthorized alteration, forgery or falsification of the content or appearance of this document is unlawful and offenders may be prosecuted to the fullest extent of the law.



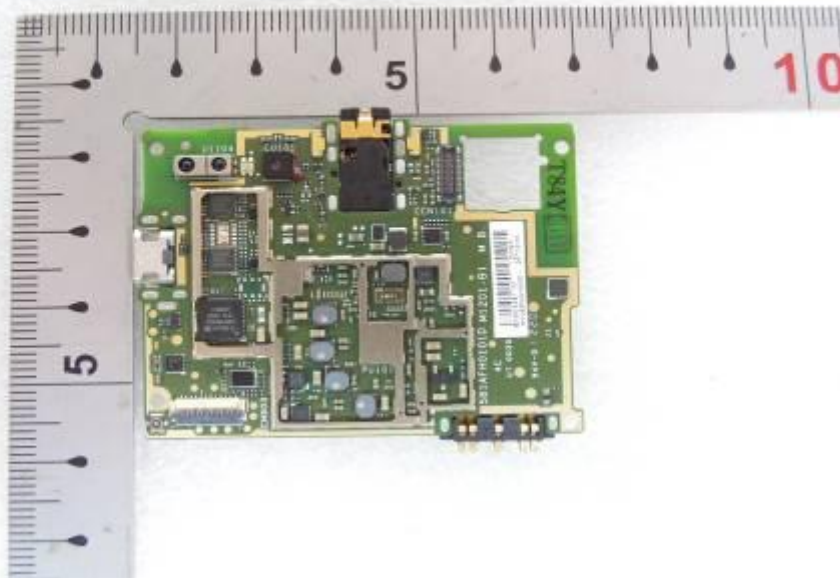

Unless otherwise stated the results shown in this test report refer only to the sample(s) tested and such sample(s) are retained for 90 days only.

除非另有說明，此報告結果僅對測試之樣品負責，同時此樣品僅保留90天。本報告未經本公司書面許可，不可部份複製。

This document is issued by the Company subject to its General Conditions of Service printed overleaf, available on request or accessible at [www.sgs.com/terms\\_and\\_conditions.htm](http://www.sgs.com/terms_and_conditions.htm) and, for electronic format documents, subject to Terms and Conditions for Electronic Documents at [www.sgs.com/terms\\_e-document.htm](http://www.sgs.com/terms_e-document.htm). Attention is drawn to the limitation of liability, indemnification and jurisdiction issues defined therein. Any holder of this document is advised that information contained hereon reflects the Company's findings at the time of its intervention only and within the limits of Client's instructions, if any. The Company's sole responsibility is to its Client and this document does not exonerate parties to a transaction from exercising all their rights and obligations under the transaction documents. This document cannot be reproduced except in full, without prior written approval of the Company. Any unauthorized alteration, forgery or falsification of the content or appearance of this document is unlawful and offenders may be prosecuted to the fullest extent of the law.

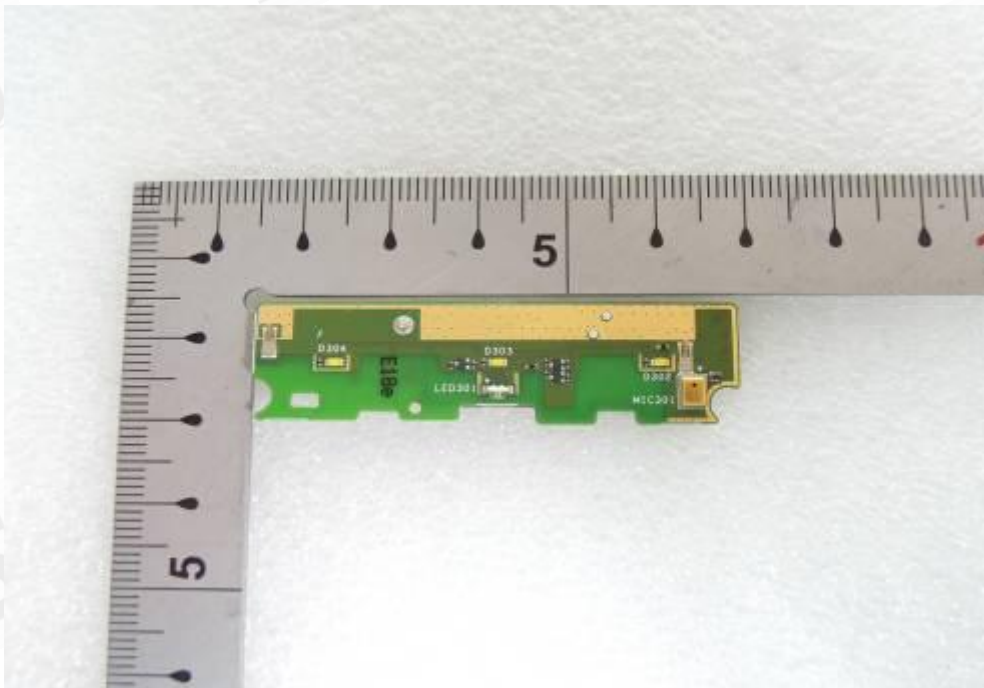
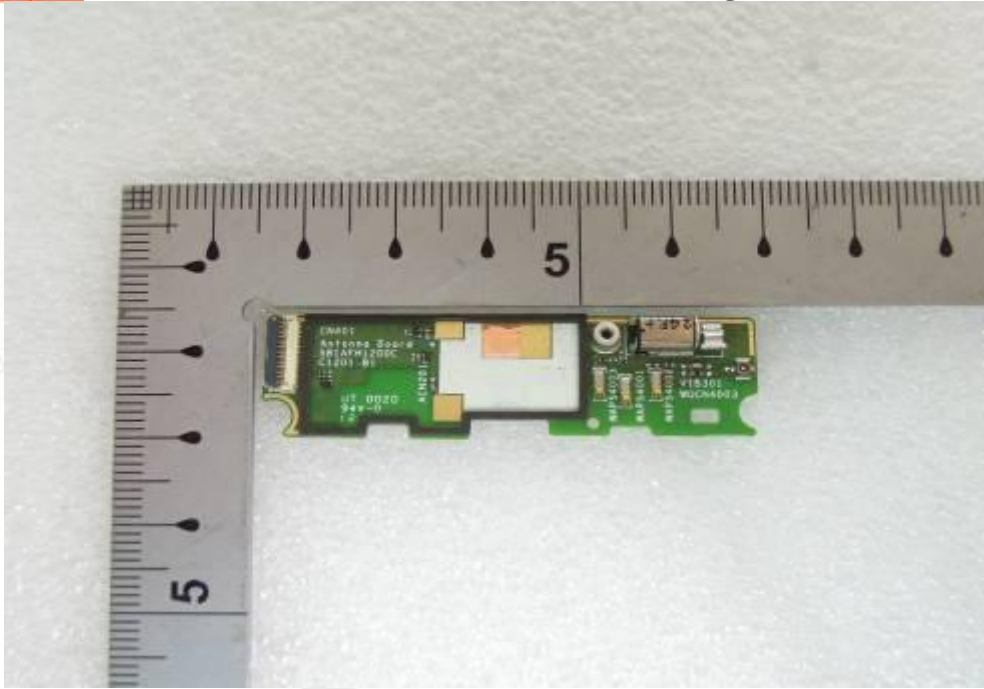

Unless otherwise stated the results shown in this test report refer only to the sample(s) tested and such sample(s) are retained for 90 days only.

除非另有說明，此報告結果僅對測試之樣品負責，同時此樣品僅保留90天。本報告未經本公司書面許可，不可部份複製。

This document is issued by the Company subject to its General Conditions of Service printed overleaf, available on request or accessible at [www.sgs.com/terms\\_and\\_conditions.htm](http://www.sgs.com/terms_and_conditions.htm) and, for electronic format documents, subject to Terms and Conditions for Electronic Documents at [www.sgs.com/terms\\_e-document.htm](http://www.sgs.com/terms_e-document.htm). Attention is drawn to the limitation of liability, indemnification and jurisdiction issues defined therein. Any holder of this document is advised that information contained hereon reflects the Company's findings at the time of its intervention only and within the limits of Client's instructions, if any. The Company's sole responsibility is to its Client and this document does not exonerate parties to a transaction from exercising all their rights and obligations under the transaction documents. This document cannot be reproduced except in full, without prior written approval of the Company. Any unauthorized alteration, forgery or falsification of the content or appearance of this document is unlawful and offenders may be prosecuted to the fullest extent of the law.

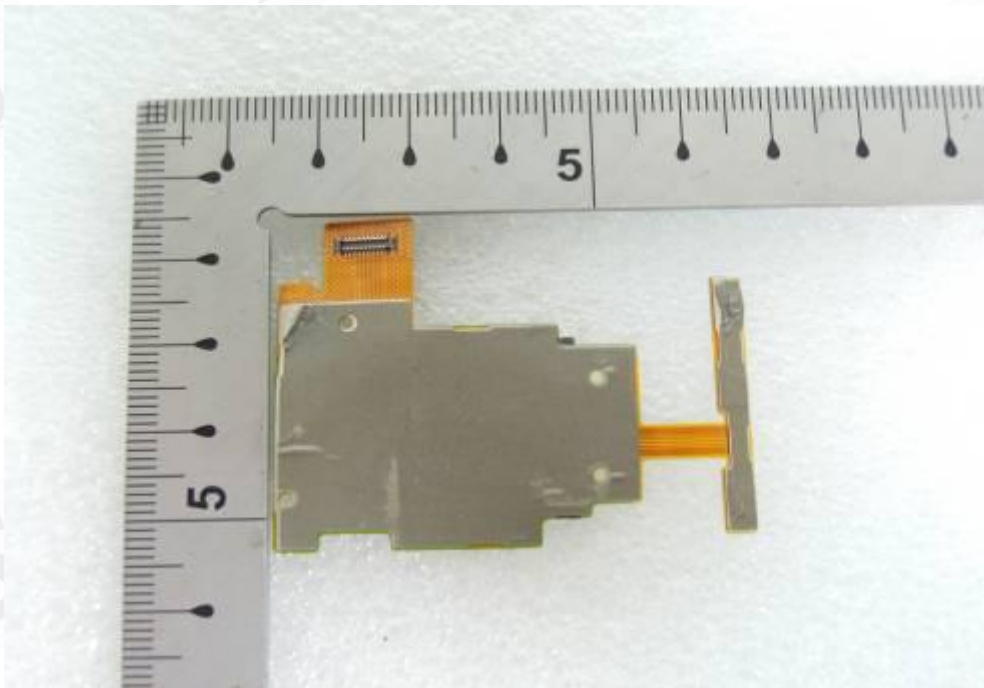
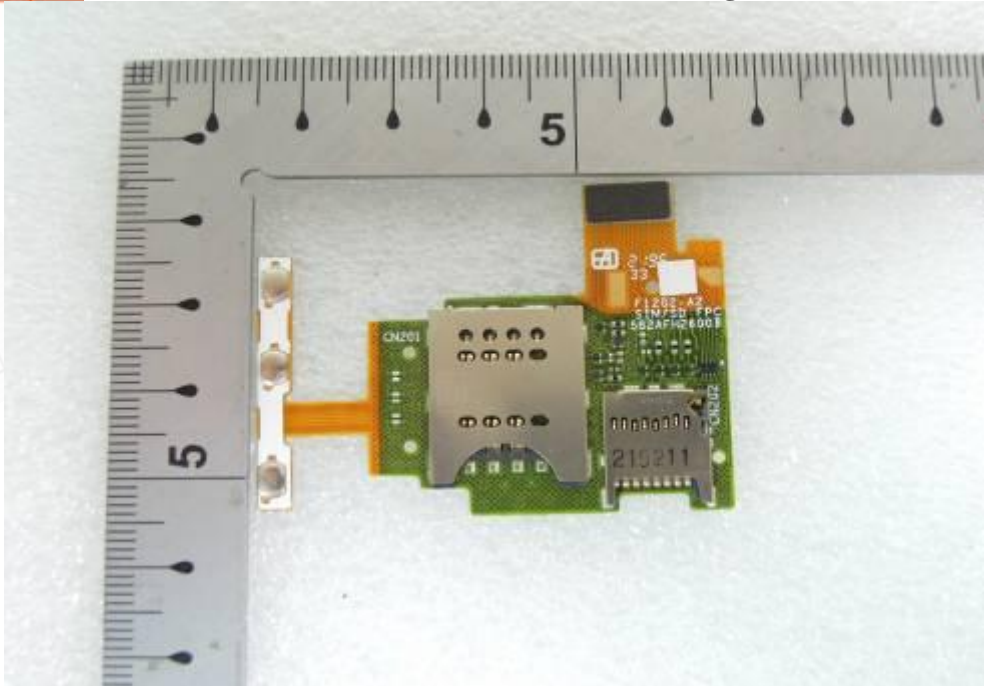

Unless otherwise stated the results shown in this test report refer only to the sample(s) tested and such sample(s) are retained for 90 days only.

除非另有說明，此報告結果僅對測試之樣品負責，同時此樣品僅保留90天。本報告未經本公司書面許可，不可部份複製。

This document is issued by the Company subject to its General Conditions of Service printed overleaf, available on request or accessible at [www.sgs.com/terms\\_and\\_conditions.htm](http://www.sgs.com/terms_and_conditions.htm) and, for electronic format documents, subject to Terms and Conditions for Electronic Documents at [www.sgs.com/terms\\_e-document.htm](http://www.sgs.com/terms_e-document.htm). Attention is drawn to the limitation of liability, indemnification and jurisdiction issues defined therein. Any holder of this document is advised that information contained hereon reflects the Company's findings at the time of its intervention only and within the limits of Client's instructions, if any. The Company's sole responsibility is to its Client and this document does not exonerate parties to a transaction from exercising all their rights and obligations under the transaction documents. This document cannot be reproduced except in full, without prior written approval of the Company. Any unauthorized alteration, forgery or falsification of the content or appearance of this document is unlawful and offenders may be prosecuted to the fullest extent of the law.

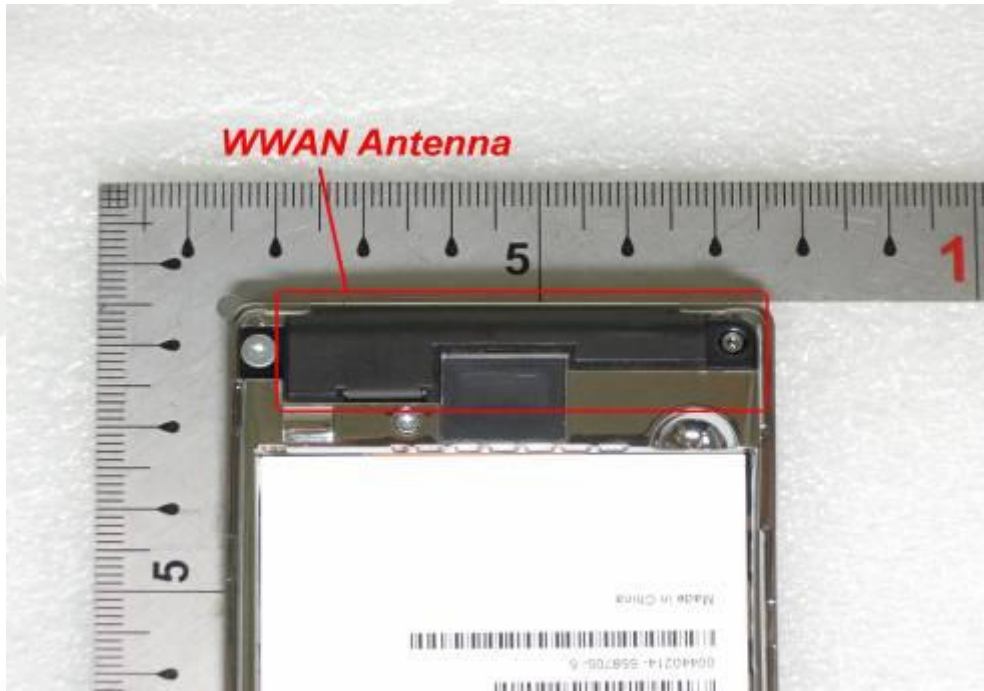

**\*\* End of Report \*\***

Unless otherwise stated the results shown in this test report refer only to the sample(s) tested and such sample(s) are retained for 90 days only.

除非另有說明，此報告結果僅對測試之樣品負責，同時此樣品僅保留90天。本報告未經本公司書面許可，不可部份複製。

This document is issued by the Company subject to its General Conditions of Service printed overleaf, available on request or accessible at [www.sgs.com/terms\\_and\\_conditions.htm](http://www.sgs.com/terms_and_conditions.htm) and, for electronic format documents, subject to Terms and Conditions for Electronic Documents at [www.sgs.com/terms\\_e-document.htm](http://www.sgs.com/terms_e-document.htm). Attention is drawn to the limitation of liability, indemnification and jurisdiction issues defined therein. Any holder of this document is advised that information contained hereon reflects the Company's findings at the time of its intervention only and within the limits of Client's instructions, if any. The Company's sole responsibility is to its Client and this document does not exonerate parties to a transaction from exercising all their rights and obligations under the transaction documents. This document cannot be reproduced except in full, without prior written approval of the Company. Any unauthorized alteration, forgery or falsification of the content or appearance of this document is unlawful and offenders may be prosecuted to the fullest extent of the law.