

# FCC CERTIFICATION REPORT

Test Report No. : EI/2012/70002

Applicant : Sony Mobile Communications AB

Address of Applicant : Nya Vattentornet 22188 Lund/SWEDEN

**Equipment Under Test (EUT) :**

Name : PDA Phone

Brand Name : Sony

Marketing Name : ST21a

Model No. : PM-0120-BV

FCC ID : PY7PM-0120

Added Model(s) : N/A

Standards : FCC Part 15:2010, Subpart B, Class B  
Canada ICES-003(Feb. 2004)

Date of Receipt : Mar. 06, 2012

Date of Test : Mar. 06 ~ 23, 2012, Jul. 01, 2012

Date of Issue : Jul. 02, 2012

<b>Test Result :</b>	<b>PASS</b>
----------------------	-------------

In the configuration tested, the EUT complied with the standards specified above.

**Remarks :**

This report details the results of the testing carried out on one sample, the results contained in this test report do not relate to other samples of the same product. The manufacturer should ensure that all products in series production are in conformity with the product sample detailed in this report.

This report shall not be reproduced except in full, without the written approval of the laboratory. If the product in this report is used in any configuration other than that detailed in the report, the manufacturer must ensure the new system complies with all relevant standards.

<b>Test By:</b>	<i>Marcus Tseng</i>	<b>Date</b>	Jul. 02, 2012
	<hr/> <i>Marcus Tseng / Engineer</i>		
<b>Prepared By:</b>	<i>Jessie Li</i>	<b>Date</b>	Jul. 02, 2012
	<hr/> <i>Jessie Li(Clerk)</i>		
<b>Approved By</b>	<i>Jim Chang</i>	<b>Date</b>	Jul. 02, 2012
	<hr/> <i>Jim Chang / Supervisor</i>		

Unless otherwise stated the results shown in this test report refer only to the sample(s) tested and such sample(s) are retained for 90 days only.  
除非另有說明，此報告結果僅對測試之樣品負責，同時此樣品僅保留90天。本報告未經本公司書面許可，不可部份複製。

This document is issued by the Company subject to its General Conditions of Service printed overleaf, available on request or accessible at [www.sgs.com/terms\\_and\\_conditions.htm](http://www.sgs.com/terms_and_conditions.htm) and, for electronic format documents, subject to Terms and Conditions for Electronic Documents at [www.sgs.com/terms\\_e-document.htm](http://www.sgs.com/terms_e-document.htm). Attention is drawn to the limitation of liability, indemnification and jurisdiction issues defined therein. Any holder of this document is advised that information contained hereon reflects the Company's findings at the time of its intervention only and within the limits of Client's instructions, if any. The Company's sole responsibility is to its Client and this document does not exonerate parties to a transaction from exercising all their rights and obligations under the transaction documents. This document cannot be reproduced except in full, without prior written approval of the Company. Any unauthorized alteration, forgery or falsification of the content or appearance of this document is unlawful and offenders may be prosecuted to the fullest extent of the law.

### Version

Version No.	Description	Date
00	Original report	Mar. 28, 2012
01	Modification : The Part number has been changed to Type number	Jun. 20, 2012
02	Description of test mode and product information	Jun. 28, 2012
03	Added FM Mode	Jul. 02, 2012

Unless otherwise stated the results shown in this test report refer only to the sample(s) tested and such sample(s) are retained for 90 days only.  
 除非另有說明，此報告結果僅對測試之樣品負責，同時此樣品僅保留90天。本報告未經本公司書面許可，不可部份複製。

This document is issued by the Company subject to its General Conditions of Service printed overleaf, available on request or accessible at [www.sgs.com/terms\\_and\\_conditions.htm](http://www.sgs.com/terms_and_conditions.htm) and, for electronic format documents, subject to Terms and Conditions for Electronic Documents at [www.sgs.com/terms\\_e-document.htm](http://www.sgs.com/terms_e-document.htm). Attention is drawn to the limitation of liability, indemnification and jurisdiction issues defined therein. Any holder of this document is advised that information contained hereon reflects the Company's findings at the time of its intervention only and within the limits of Client's instructions, if any. The Company's sole responsibility is to its Client and this document does not exonerate parties to a transaction from exercising all their rights and obligations under the transaction documents. This document cannot be reproduced except in full, without prior written approval of the Company. Any unauthorized alteration, forgery or falsification of the content or appearance of this document is unlawful and offenders may be prosecuted to the fullest extent of the law.

# Contents

<b>1. GENERAL INFORMATION</b>	<b>5</b>
1.1 APPLICANT & MANUFACTURER INFORMATION	5
1.2 GENERAL DESCRIPTION OF EUT	5
1.3 DETAILS OF EUT	5
1.4 EUT DESCRIPTION	6
1.5 OPERATION PROCEDURE	6
1.6 DESCRIPTION OF SUPPORT UNITS	7
1.7 MODIFICATION LIST	7
1.8 CABLE LIST	7
1.9 TEST SET-UP CONFIGURATION	8
1.10 MEASUREMENT PROCEDURE	10
1.11 STANDARDS APPLICABLE FOR TESTING	10
1.12 SUMMARY OF RESULTS	10
<b>2. RADIO DISTURBANCE</b>	<b>11</b>
2.1 TEST RESULTS	11
2.2 FREQUENCY RANGE	11
2.3 LIMITS OF CONDUCTED AND RADIATED EMISSION	11
2.3.1 LIMIT OF CONDUCTED EMISSION OF FCC PART 15, SUBPART B/CISPR 22	11
2.3.2 LIMIT OF RADIATED EMISSIONS OF FCC PART 15, SUBPART B/CISPR 22	12
2.4. TEST OF CONDUCTED EMISSION	13
2.4.1 TEST EQUIPMENTS	13
2.4.2 TEST SITE	13
2.4.3 OPERATING ENVIRONMENT	13
2.4.4 UNCERTAINTY OF CONDUCTED EMISSION	13
2.4.5 MEASUREMENT LEVEL AND FACTOR CALCULATE METHOD	13
2.4.6 MEASUREMENT DATA	14
2.5 TEST OF RADIATED EMISSION	34
2.5.1 TEST INSTRUMENTS	34
2.5.2 TEST SITE	35
2.5.3 OPERATING ENVIRONMENT	35
2.5.4 UNCERTAINTY OF RADIATED EMISSION	35

Unless otherwise stated the results shown in this test report refer only to the sample(s) tested and such sample(s) are retained for 90 days only.  
 除非另有說明，此報告結果僅對測試之樣品負責，同時此樣品僅保留90天。本報告未經本公司書面許可，不可部份複製。

This document is issued by the Company subject to its General Conditions of Service printed overleaf, available on request or accessible at [www.sgs.com/terms\\_and\\_conditions.htm](http://www.sgs.com/terms_and_conditions.htm) and, for electronic format documents, subject to Terms and Conditions for Electronic Documents at [www.sgs.com/terms\\_e-document.htm](http://www.sgs.com/terms_e-document.htm). Attention is drawn to the limitation of liability, indemnification and jurisdiction issues defined therein. Any holder of this document is advised that information contained hereon reflects the Company's findings at the time of its intervention only and within the limits of Client's instructions, if any. The Company's sole responsibility is to its Client and this document does not exonerate parties to a transaction from exercising all their rights and obligations under the transaction documents. This document cannot be reproduced except in full, without prior written approval of the Company. Any unauthorized alteration, forgery or falsification of the content or appearance of this document is unlawful and offenders may be prosecuted to the fullest extent of the law.

2.5.5 MEASUREMENT LEVEL AND FACTOR CALCULATE METHOD .....	35
2.5.6 MEASUREMENT DATA .....	36
3. PHOTOGRAPHS OF TEST .....	54
4. PHOTOGRAPHS OF PRODUCT .....	63

Unless otherwise stated the results shown in this test report refer only to the sample(s) tested and such sample(s) are retained for 90 days only.  
除非另有說明，此報告結果僅對測試之樣品負責，同時此樣品僅保留90天。本報告未經本公司書面許可，不可部份複製。

This document is issued by the Company subject to its General Conditions of Service printed overleaf, available on request or accessible at [www.sgs.com/terms\\_and\\_conditions.htm](http://www.sgs.com/terms_and_conditions.htm) and, for electronic format documents, subject to Terms and Conditions for Electronic Documents at [www.sgs.com/terms\\_e-document.htm](http://www.sgs.com/terms_e-document.htm). Attention is drawn to the limitation of liability, indemnification and jurisdiction issues defined therein. Any holder of this document is advised that information contained hereon reflects the Company's findings at the time of its intervention only and within the limits of Client's instructions, if any. The Company's sole responsibility is to its Client and this document does not exonerate parties to a transaction from exercising all their rights and obligations under the transaction documents. This document cannot be reproduced except in full, without prior written approval of the Company. Any unauthorized alteration, forgery or falsification of the content or appearance of this document is unlawful and offenders may be prosecuted to the fullest extent of the law.

## 1. General Information

### 1.1 Applicant & Manufacturer Information

Applicant : Sony Mobile Communications AB

Address of Applicant : Nya Vattentornet 22188 Lund/SWEDEN

### 1.2 General Description of EUT

Name : PDA Phone

Brand Name : Sony

Marketing Name : ST21a

Model No. : PM-0120-BV

Added Model(s) : N/A

FCC ID : PY7PM-0120

Model Difference : N/A

Filing Type : Certification

### 1.3 Details of EUT

Data Cable (USB):	Model No.: EC450, Supplier: K-one, Part No.: 1242-6715	
Simple Hands-free (SHF):	Model No.: MH410C, Supplier: Foster Electric, Type No.: CCA-0004017	
Car Charger:	Model No.: AN400, Supplier: Salcomp, Type No.: CCA-0003013	
HW version :	A	
SW version :	1.*.J.0.7-userdebug	
Power Supply:	3.7Vdc form Li-Ion battery or 5Vdc form adapter.	
	Battery:	1. Model No.: BA700, Supplier: LG Type No.: CBA-0002025 2. Model No.: BA700, Supplier: Samsung Type No.: CBA-0002026
	Adapter :	1. Model No.: EP800, Supplier: Salcomp Type No.: CAA-0002016-US, CAA-0002016-BV 2. Model No.: EP800, Supplier: EMERSON Type No.: CAA-0002022-US, CAA-0002022-BV

Unless otherwise stated the results shown in this test report refer only to the sample(s) tested and such sample(s) are retained for 90 days only.  
除非另有說明，此報告結果僅對測試之樣品負責，同時此樣品僅保留90天。本報告未經本公司書面許可，不可部份複製。

This document is issued by the Company subject to its General Conditions of Service printed overleaf, available on request or accessible at [www.sgs.com/terms\\_and\\_conditions.htm](http://www.sgs.com/terms_and_conditions.htm) and, for electronic format documents, subject to Terms and Conditions for Electronic Documents at [www.sgs.com/terms\\_e-document.htm](http://www.sgs.com/terms_e-document.htm). Attention is drawn to the limitation of liability, indemnification and jurisdiction issues defined therein. Any holder of this document is advised that information contained hereon reflects the Company's findings at the time of its intervention only and within the limits of Client's instructions, if any. The Company's sole responsibility is to its Client and this document does not exonerate parties to a transaction from exercising all their rights and obligations under the transaction documents. This document cannot be reproduced except in full, without prior written approval of the Company. Any unauthorized alteration, forgery or falsification of the content or appearance of this document is unlawful and offenders may be prosecuted to the fullest extent of the law.

### 1.4 EUT description

The equipment under test (EUT) is the GSM/GPRS 850,1900, WCDMA/HSDPA Band 2, Band 5, FM, BT,WiFi and GPS. The test data contained in this report pertains only to the emissions due to digital circuitry of the EUT.

<b>ST21a</b>	<b>Operation :</b>	<b>Unintentional radiation mode</b>	
	<b>Config 1</b>	<b>Config 2</b>	<b>Config 3</b>
Applicable standard (FCC )	FCC 15B		
Accessories	UE + Battery +USB Cable + SHF	UE + Battery + AC Adaptor +USB Cable + SHF	UE + Battery + AC Adaptor +USB Cable + SHF
Main Function	<b>Data link</b>	<b>Camera</b>	<b>FM Mode</b>
Additional Function	Data link	FULL SYSTEM	FM Mode
<b>Description</b>			
radiated emission	Data link	Recording&Play Recording&MP3	FM Mode (FM87.6 & FM98 & FM107.9 )
conducted emission (DC Power)	N/A	N/A	N/A
conducted emission (AC Power)	Data link	Recording&Play Recording&MP3	FM Mode (FM87.6 & FM98 & FM107.9 )

### 1.5 Operation Procedure

1. Set down EUT with support units and turn on the power of all equipment.
2. Pre-test the EUT in all modes by each model, then figure the worst case out.
3. Tests under the normal operation due to unintentional radiation mode.

Unless otherwise stated the results shown in this test report refer only to the sample(s) tested and such sample(s) are retained for 90 days only.  
除非另有說明，此報告結果僅對測試之樣品負責，同時此樣品僅保留90天。本報告未經本公司書面許可，不可部份複製。

This document is issued by the Company subject to its General Conditions of Service printed overleaf, available on request or accessible at [www.sgs.com/terms\\_and\\_conditions.htm](http://www.sgs.com/terms_and_conditions.htm) and, for electronic format documents, subject to Terms and Conditions for Electronic Documents at [www.sgs.com/terms\\_e-document.htm](http://www.sgs.com/terms_e-document.htm). Attention is drawn to the limitation of liability, indemnification and jurisdiction issues defined therein. Any holder of this document is advised that information contained hereon reflects the Company's findings at the time of its intervention only and within the limits of Client's instructions, if any. The Company's sole responsibility is to its Client and this document does not exonerate parties to a transaction from exercising all their rights and obligations under the transaction documents. This document cannot be reproduced except in full, without prior written approval of the Company. Any unauthorized alteration, forgery or falsification of the content or appearance of this document is unlawful and offenders may be prosecuted to the fullest extent of the law.

### 1.6 Description of Support Units

PRODUCT	MANUFACTURER	MODEL NO.	SERIAL NO.
NOTEBOOK	IBM	L412	LR-ZYMYD
Mouse	HP	M-UAE96	390938-001
Printer	HP	DJ3820	CN34L181B1
Signal Generator	Levear	VP-8194D	N/A

### 1.7 Modification List

No modification by SGS Taiwan Electronics & Communication Laboratory.

### 1.8 Cable List

Cable Type	Length	Shield
USB cable(core*2 near EUT & Adaptor)	1m	Non-Shielding

Unless otherwise stated the results shown in this test report refer only to the sample(s) tested and such sample(s) are retained for 90 days only.  
 除非另有說明，此報告結果僅對測試之樣品負責，同時此樣品僅保留90天。本報告未經本公司書面許可，不可部份複製。

This document is issued by the Company subject to its General Conditions of Service printed overleaf, available on request or accessible at [www.sgs.com/terms\\_and\\_conditions.htm](http://www.sgs.com/terms_and_conditions.htm) and, for electronic format documents, subject to Terms and Conditions for Electronic Documents at [www.sgs.com/terms\\_e-document.htm](http://www.sgs.com/terms_e-document.htm). Attention is drawn to the limitation of liability, indemnification and jurisdiction issues defined therein. Any holder of this document is advised that information contained hereon reflects the Company's findings at the time of its intervention only and within the limits of Client's instructions, if any. The Company's sole responsibility is to its Client and this document does not exonerate parties to a transaction from exercising all their rights and obligations under the transaction documents. This document cannot be reproduced except in full, without prior written approval of the Company. Any unauthorized alteration, forgery or falsification of the content or appearance of this document is unlawful and offenders may be prosecuted to the fullest extent of the law.

## 1.9 Test Set-Up Configuration

Config1

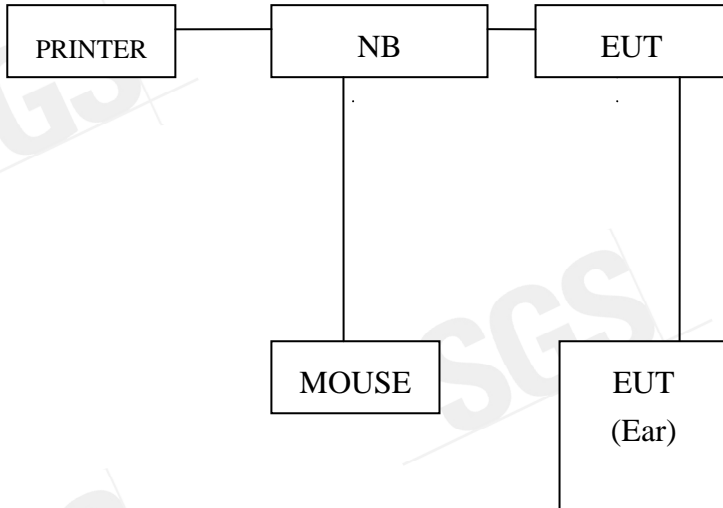

Config2

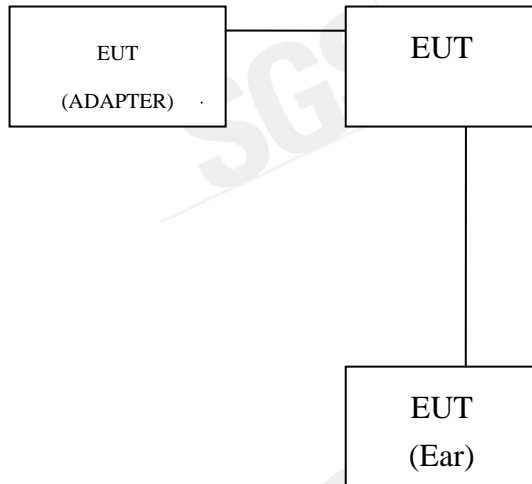

Unless otherwise stated the results shown in this test report refer only to the sample(s) tested and such sample(s) are retained for 90 days only.  
 除非另有說明，此報告結果僅對測試之樣品負責，同時此樣品僅保留90天。本報告未經本公司書面許可，不可部份複製。

This document is issued by the Company subject to its General Conditions of Service printed overleaf, available on request or accessible at [www.sgs.com/terms\\_and\\_conditions.htm](http://www.sgs.com/terms_and_conditions.htm) and, for electronic format documents, subject to Terms and Conditions for Electronic Documents at [www.sgs.com/terms\\_e-document.htm](http://www.sgs.com/terms_e-document.htm). Attention is drawn to the limitation of liability, indemnification and jurisdiction issues defined therein. Any holder of this document is advised that information contained hereon reflects the Company's findings at the time of its intervention only and within the limits of Client's instructions, if any. The Company's sole responsibility is to its Client and this document does not exonerate parties to a transaction from exercising all their rights and obligations under the transaction documents. This document cannot be reproduced except in full, without prior written approval of the Company. Any unauthorized alteration, forgery or falsification of the content or appearance of this document is unlawful and offenders may be prosecuted to the fullest extent of the law.



Config3

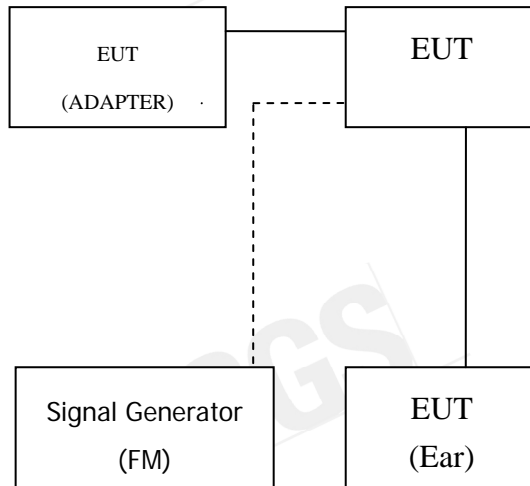

Unless otherwise stated the results shown in this test report refer only to the sample(s) tested and such sample(s) are retained for 90 days only.  
除非另有說明，此報告結果僅對測試之樣品負責，同時此樣品僅保留90天。本報告未經本公司書面許可，不可部份複製。

This document is issued by the Company subject to its General Conditions of Service printed overleaf, available on request or accessible at [www.sgs.com/terms\\_and\\_conditions.htm](http://www.sgs.com/terms_and_conditions.htm) and, for electronic format documents, subject to Terms and Conditions for Electronic Documents at [www.sgs.com/terms\\_e-document.htm](http://www.sgs.com/terms_e-document.htm). Attention is drawn to the limitation of liability, indemnification and jurisdiction issues defined therein. Any holder of this document is advised that information contained hereon reflects the Company's findings at the time of its intervention only and within the limits of Client's instructions, if any. The Company's sole responsibility is to its Client and this document does not exonerate parties to a transaction from exercising all their rights and obligations under the transaction documents. This document cannot be reproduced except in full, without prior written approval of the Company. Any unauthorized alteration, forgery or falsification of the content or appearance of this document is unlawful and offenders may be prosecuted to the fullest extent of the law.

### 1.10 Measurement Procedure

Conducted Emission Testing was performed according ANSI C63.4:2003 in a shielded room with peripherals placed on a table, 0.8m high over a metal floor. It was located more than required distance away from the shielded room wall.

Radiated Emission Testing was performed according to ANSI C63.4:2003 at the open field test site. The EUT was placed in a 0.8m high table along with the peripherals. The turn table was separated from the antenna distance 10meters. Cables were placed in a position to produce maximum emissions as determined by experimentation, and operation mode was selected for maximum.

The frequencies and amplitudes of maximum emission were measured at varying azimuths, antenna heights and antenna polarities. Reported are maximized emission levels.

### 1.11 Standards Applicable for Testing

Table of tests to be carried out under FCC Part 15, Subpart B

Test Standards	Status
FCC Part 15, Subpart B	Applicable
Deviation from Standard	No Deviation

### 1.12 Summary of Results

Highest Emission					
Standard	Test Type	Result	Phase/Polar.	Frequency (MHz)	Margin(dB)
FCC Part 15 Subpart B Class B/CISPR 22 ICES-003(Feb. 2004)	Conducted Emission	PASS	Line	0.3846	-7.19(AVG)
			Neutral	0.3846	-4.98(AVG)
	Radiated Emission	PASS	Ver.	42.1300	-8.06(QP)

Unless otherwise stated the results shown in this test report refer only to the sample(s) tested and such sample(s) are retained for 90 days only.  
除非另有說明，此報告結果僅對測試之樣品負責，同時此樣品僅保留90天。本報告未經本公司書面許可，不可部份複製。

This document is issued by the Company subject to its General Conditions of Service printed overleaf, available on request or accessible at [www.sgs.com/terms\\_and\\_conditions.htm](http://www.sgs.com/terms_and_conditions.htm) and, for electronic format documents, subject to Terms and Conditions for Electronic Documents at [www.sgs.com/terms\\_e-document.htm](http://www.sgs.com/terms_e-document.htm). Attention is drawn to the limitation of liability, indemnification and jurisdiction issues defined therein. Any holder of this document is advised that information contained hereon reflects the Company's findings at the time of its intervention only and within the limits of Client's instructions, if any. The Company's sole responsibility is to its Client and this document does not exonerate parties to a transaction from exercising all their rights and obligations under the transaction documents. This document cannot be reproduced except in full, without prior written approval of the Company. Any unauthorized alteration, forgery or falsification of the content or appearance of this document is unlawful and offenders may be prosecuted to the fullest extent of the law.

## 2. Radio Disturbance

### 2.1 Test Results

	Results
Conducted Emission	<b>Pass</b>
Radiated Emission	<b>Pass</b>

### 2.2 Frequency Range

Conducted Emission : 150 kHz - 30 MHz

Radiated Emission : 30 MHz - 1000 MHz

### 2.3 Limits Of Conducted And Radiated Emission

#### 2.3.1 Limit Of Conducted Emission Of FCC Part 15, Subpart B/CISPR 22

FREQUENCY (MHz)	Class A (dBuV)		Class B (dBuV)	
	Quasi - peak	Average	Quasi - peak	Average
0.15 - 0.5	79	66	66 - 56	56 - 46
0.50 - 5.0	73	60	56	46
5.0 - 30.0	73	60	60	50

Note : (1) The lower limit shall apply at the transition frequencies.

(2) The limit decreases linearly with the logarithm of the frequency in the range 0.15 to 0.50 MHz.

(3) All emanation from a class A/B digital device or system, including any network of conductors and apparatus connected there to, shall not exceed the level of field strengths specified above.

### 2.3.2 Limit Of Radiated Emissions Of FCC Part 15, Subpart B/CISPR 22

**FCC Limit:**

- Detector Function : Quasi – Peak

FREQUENCY (MHz)	Class A (at 10m)	Class B (at 3m)
	dBuV/m	dBuV/m
30~88	39	40
88~216	43.5	43.5
216~960	46.44	46
Above 960	49.54	54

- Detector Function : Peak , Average

FREQUENCY (MHz)	Class A (dBuV) (at 3m)		Class B (dBuV) (at 3m)	
	Peak	Average	Peak	Average
Above 1000	79.3	59.3	73.9	53.9

**CISPR Limit:**

- Detector Function : Quasi – Peak

FREQUENCY (MHz)	Class A (at 10m)	Class B (at 10m)
	dBuV/m	dBuV/m
30-230	40	30
230-1000	47	37

- Detector Function : Peak , Average – Class A

Frequency range GHz	Average Limit dB(μV/m)	Peak Limit dB(μV/m)
1 to 3	56	76
3 to 6	60	80

- Detector Function : Peak , Average – Class B

Frequency range GHz	Average Limit dB(μV/m)	Peak Limit dB(μV/m)
1 to 3	50	70
3 to 6	54	74

Note : The lower limit applies at the transition frequency.

Unless otherwise stated the results shown in this test report refer only to the sample(s) tested and such sample(s) are retained for 90 days only.  
除非另有說明，此報告結果僅對測試之樣品負責，同時此樣品僅保留90天。本報告未經本公司書面許可，不可部份複製。

This document is issued by the Company subject to its General Conditions of Service printed overleaf, available on request or accessible at [www.sgs.com/terms\\_and\\_conditions.htm](http://www.sgs.com/terms_and_conditions.htm) and, for electronic format documents, subject to Terms and Conditions for Electronic Documents at [www.sgs.com/terms\\_e-document.htm](http://www.sgs.com/terms_e-document.htm). Attention is drawn to the limitation of liability, indemnification and jurisdiction issues defined therein. Any holder of this document is advised that information contained hereon reflects the Company's findings at the time of its intervention only and within the limits of Client's instructions, if any. The Company's sole responsibility is to its Client and this document does not exonerate parties to a transaction from exercising all their rights and obligations under the transaction documents. This document cannot be reproduced except in full, without prior written approval of the Company. Any unauthorized alteration, forgery or falsification of the content or appearance of this document is unlawful and offenders may be prosecuted to the fullest extent of the law.

## 2.4. Test of Conducted Emission

### 2.4.1 Test Equipments

Description	Manufacturer	Model No.	Serial No.	Last Calibration Date	Next Calibration Date
EMI Test Receiver	ROHDE&SCHWARZ	ESCS 30	828985/004	Sep. 23, 2011	Sep. 22, 2012
Coaxial Cables	N/A	WK CE Cable	N/A	Jan. 04, 2012	Jan. 03, 2013
L.I.S.N	Rolf-Heine	NNB-2/16Z	99012	Mar. 23, 2012	Mar. 22, 2013
L.I.S.N	FCC	FCC-LISN-50/250-25-2-01	04034	Mar. 23, 2012	Mar. 22, 2013
Software	Farad	EZ-EMC-VER2A1.1(USB)	N/A	N/A	N/A

### 2.4.2 Test Site

SGS Taiwan LTD. Electronics & Communication Laboratory  
 No.134, Wu Kung Road. Wuku Industrial Zone, Taipei County 248, Taiwan (R.O.C.)

### 2.4.3 Operating Environment

Temperature : 26 degree C

Humidity : 59 %RH

Atmospheric Pressure : 996 mBar

### 2.4.4 Uncertainty of Conducted Emission

Expanded uncertainty (k=2) of Conducted Emission measurement is 0.98dB.

### 2.4.5 Measurement level and Factor calculate method

Factor = LISN insertion loss + Cable loss

Measurement Level = Reading Level + Factor

Unless otherwise stated the results shown in this test report refer only to the sample(s) tested and such sample(s) are retained for 90 days only.  
 除非另有說明，此報告結果僅對測試之樣品負責，同時此樣品僅保留90天。本報告未經本公司書面許可，不可部份複製。

This document is issued by the Company subject to its General Conditions of Service printed overleaf, available on request or accessible at [www.sgs.com/terms\\_and\\_conditions.htm](http://www.sgs.com/terms_and_conditions.htm) and, for electronic format documents, subject to Terms and Conditions for Electronic Documents at [www.sgs.com/terms\\_e-document.htm](http://www.sgs.com/terms_e-document.htm). Attention is drawn to the limitation of liability, indemnification and jurisdiction issues defined therein. Any holder of this document is advised that information contained hereon reflects the Company's findings at the time of its intervention only and within the limits of Client's instructions, if any. The Company's sole responsibility is to its Client and this document does not exonerate parties to a transaction from exercising all their rights and obligations under the transaction documents. This document cannot be reproduced except in full, without prior written approval of the Company. Any unauthorized alteration, forgery or falsification of the content or appearance of this document is unlawful and offenders may be prosecuted to the fullest extent of the law.

## 2.4.6 Measurement Data

### Config 1 : Data Link

L

臺灣檢驗科技股份有限公司 - 電子電訊服務部  
 台北縣五股工業區五工路 134 號  
 電話 : ( 02 ) 22993279 傳真 : ( 02 ) 22982698

---

**Conducted Emission Measurement**

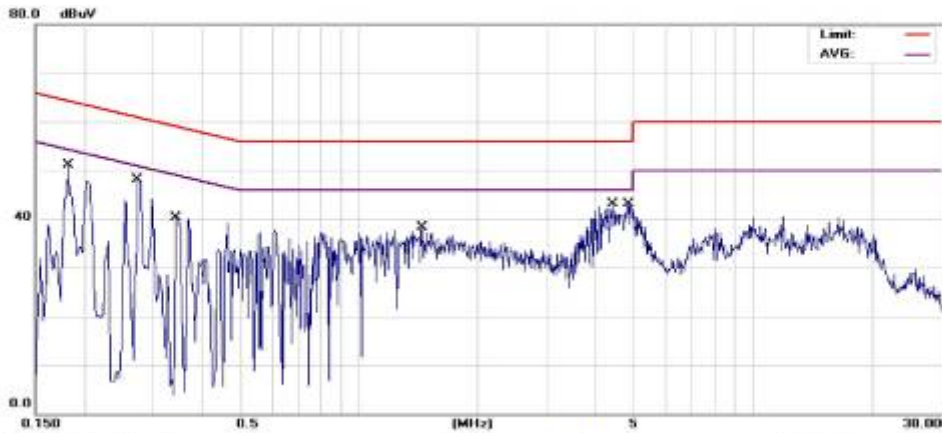

Site: SGS CONDUCTED #1	Phase: <b>L1</b>	Temperature: 25 °C
Limit: FCC Class B Conduction(QP)	Power: From System	Humidity: 59%
EUT:	Distance:	Air Pressure: hpa
MN:		
Note: Config 1: UE+Battery+USB Cable+SHF ; DATA Link ( 27% battery capacity ) , (AC120V/60Hz)		

No.	Mk.	Freq.	Reading Level	Factor	Measurement	Limit	Over	Detector	Comment
		MHz	dBuV		dB	dBuV	dB		
1		0.1820	50.98	0.10	51.08	64.39	-13.31	QP	
2		0.2740	47.93	0.09	48.02	61.00	-12.98	QP	
3		0.3420	40.15	0.08	40.23	59.15	-18.92	QP	
4		1.4420	38.16	0.08	38.24	56.00	-17.76	QP	
5	*	4.4260	43.01	0.12	43.13	56.00	-12.87	QP	
6		4.8340	42.89	0.13	43.02	56.00	-12.98	QP	

\*:Maximum data    x:Over limit    !:over margin    ●ReferenceOnly

Unless otherwise stated the results shown in this test report refer only to the sample(s) tested and such sample(s) are retained for 90 days only.  
 除非另有說明，此報告結果僅對測試之樣品負責，同時此樣品僅保留90天。本報告未經本公司書面許可，不可部份複製。

This document is issued by the Company subject to its General Conditions of Service printed overleaf, available on request or accessible at [www.sgs.com/terms\\_and\\_conditions.htm](http://www.sgs.com/terms_and_conditions.htm) and, for electronic format documents, subject to Terms and Conditions for Electronic Documents at [www.sgs.com/terms\\_e-document.htm](http://www.sgs.com/terms_e-document.htm). Attention is drawn to the limitation of liability, indemnification and jurisdiction issues defined therein. Any holder of this document is advised that information contained hereon reflects the Company's findings at the time of its intervention only and within the limits of Client's instructions, if any. The Company's sole responsibility is to its Client and this document does not exonerate parties to a transaction from exercising all their rights and obligations under the transaction documents. This document cannot be reproduced except in full, without prior written approval of the Company. Any unauthorized alteration, forgery or falsification of the content or appearance of this document is unlawful and offenders may be prosecuted to the fullest extent of the law.

N



臺灣檢驗科技股份有限公司 - 電子資訊服務部  
 台北縣五股工業區五工路 134 號  
 電話 : ( 02 ) 22993279 傳真 : ( 02 ) 22982698

Conducted Emission Measurement

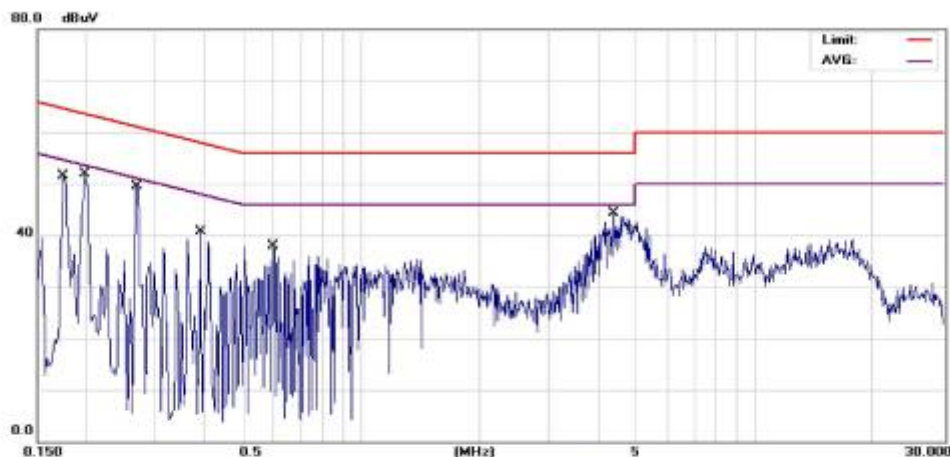

Site: SGS CONDUCTED #1 Phase: **N** Temperature: 26 °C  
 Limit: FCC Class B Conduction(QP) Power: From System Humidity: 56%  
 EUT: Distance: Air Pressure: hpa  
 MN:  
 Note: Config 1: UE+Battery+USB Cable+SHF ; DATA Link  
 ( 27% battery capacity ) , ( AC120V/60Hz )

No.	Mk.	Freq. MHz	Reading Level dBuV	Factor dB	Measurement dBuV	Limit dBuV	Over dB	Detector	Comment
1		0.1740	51.30	0.15	51.45	64.77	-13.32	QP	
2		0.1980	51.75	0.13	51.88	63.69	-11.81	QP	
3	*	0.2700	49.40	0.13	49.53	61.12	-11.59	QP	
4		0.3900	40.59	0.13	40.72	58.06	-17.34	QP	
5		0.5980	37.75	0.13	37.88	56.00	-18.12	QP	
6		4.4020	44.20	0.16	44.36	56.00	-11.64	QP	

\*:Maximum data x:Over limit !:over margin ■ReferenceOnly

Unless otherwise stated the results shown in this test report refer only to the sample(s) tested and such sample(s) are retained for 90 days only.  
 除非另有說明，此報告結果僅對測試之樣品負責，同時此樣品僅保留90天。本報告未經本公司書面許可，不可部份複製。

This document is issued by the Company subject to its General Conditions of Service printed overleaf, available on request or accessible at [www.sgs.com/terms\\_and\\_conditions.htm](http://www.sgs.com/terms_and_conditions.htm) and, for electronic format documents, subject to Terms and Conditions for Electronic Documents at [www.sgs.com/terms\\_e-document.htm](http://www.sgs.com/terms_e-document.htm). Attention is drawn to the limitation of liability, indemnification and jurisdiction issues defined therein. Any holder of this document is advised that information contained hereon reflects the Company's findings at the time of its intervention only and within the limits of Client's instructions, if any. The Company's sole responsibility is to its Client and this document does not exonerate parties to a transaction from exercising all their rights and obligations under the transaction documents. This document cannot be reproduced except in full, without prior written approval of the Company. Any unauthorized alteration, forgery or falsification of the content or appearance of this document is unlawful and offenders may be prosecuted to the fullest extent of the law.

**Config 2 : Recording  
Main:Salcomp  
L**



臺灣檢驗科技股份有限公司-電子電通訊服務部  
台北縣五股工業區五工路 134 號  
電話 : ( 02 ) 22993279 傳真 : ( 02 ) 22982698

**Conducted Emission Measurement**

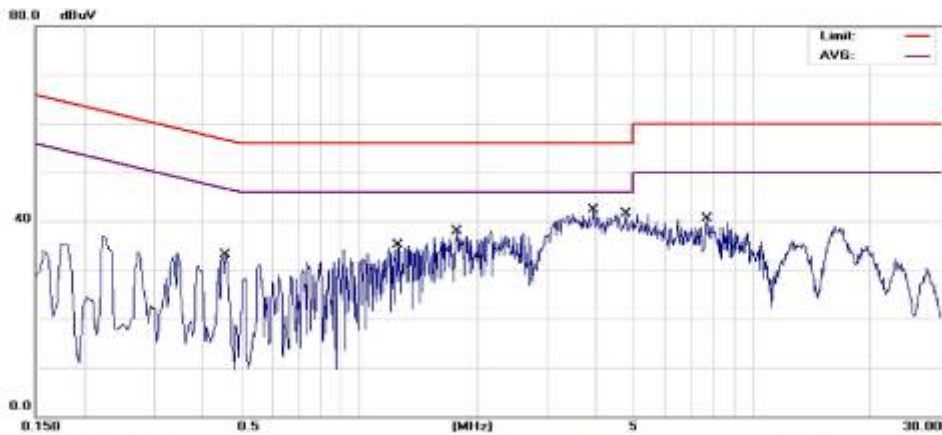

Site: SGS CONDUCTED #1 Phase: **L1** Temperature: 26 °C  
 Limit: FCC Class B Conduction(QP) Power: AC 120V/60Hz Humidity: 56%  
 EUT: Distance: Air Pressure: hpa  
 MN:  
 Note: Config 2: UE+Battery+AC Adaptor+USB Cable+SHF+FULL System ; Recording  
 ( 27% battery capacity ) , Adaptor : 1227-9853.1

No.	Mk.	Freq. MHz	Reading Level dBuV	Factor dB	Measure- ment dBuV	Limit dBuV	Over dB	Detector	Comment
1		0.4580	33.05	0.09	33.14	56.73	-23.59	QP	
2		1.2620	34.96	0.08	35.04	56.00	-20.96	QP	
3		1.7740	37.87	0.10	37.97	56.00	-18.03	QP	
4	*	3.9460	42.28	0.12	42.40	56.00	-13.60	QP	
5		4.7500	41.30	0.13	41.43	56.00	-14.57	QP	
6		7.6500	40.44	0.15	40.59	60.00	-19.41	QP	

\*:Maximum data x:Over limit !:over margin ●Reference Only

Unless otherwise stated the results shown in this test report refer only to the sample(s) tested and such sample(s) are retained for 90 days only.  
 除非另有說明，此報告結果僅對測試之樣品負責，同時此樣品僅保留90天。本報告未經本公司書面許可，不可部份複製。

This document is issued by the Company subject to its General Conditions of Service printed overleaf, available on request or accessible at [www.sgs.com/terms\\_and\\_conditions.htm](http://www.sgs.com/terms_and_conditions.htm) and, for electronic format documents, subject to Terms and Conditions for Electronic Documents at [www.sgs.com/terms\\_e-document.htm](http://www.sgs.com/terms_e-document.htm). Attention is drawn to the limitation of liability, indemnification and jurisdiction issues defined therein. Any holder of this document is advised that information contained hereon reflects the Company's findings at the time of its intervention only and within the limits of Client's instructions, if any. The Company's sole responsibility is to its Client and this document does not exonerate parties to a transaction from exercising all their rights and obligations under the transaction documents. This document cannot be reproduced except in full, without prior written approval of the Company. Any unauthorized alteration, forgery or falsification of the content or appearance of this document is unlawful and offenders may be prosecuted to the fullest extent of the law.





臺灣檢驗科技股份有限公司 - 電子暨通訊服務部  
 台北縣五股工業區五工路 134 號  
 電話 : ( 02 ) 22993279 傳真 : ( 02 ) 22982698

Conducted Emission Measurement

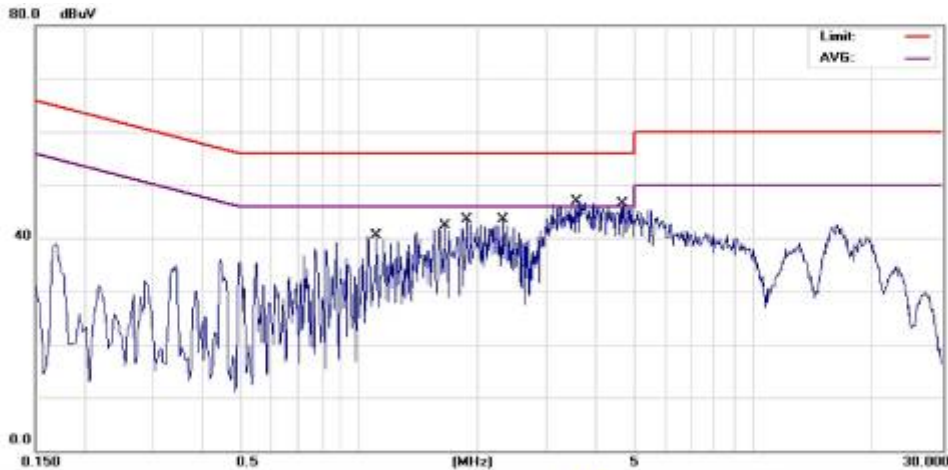

Site SGS CONDUCTED #1 Phase: **N** Temperature: 25 °C  
 Limit: FCC Class B Conduction(QP) Power: AC 120V/60Hz Humidity: 56%  
 EUT: Distance: Air Pressure: hpa  
 MN:  
 Note: Config 2: UE+Battery+AC Adaptor+USB Cable+SHF+FULL System ; Recording  
 ( 27% battery capacity ) , Adaptor : 1227-9853.1

No.	Mk.	Freq. MHz	Reading Level dBuV	Factor dB	Measure- ment dBuV	Limit dBuV	Over dB	Detector	Comment
1		1.1100	40.35	0.12	40.47	56.00	-15.53	QP	
2		1.6460	42.26	0.13	42.39	56.00	-13.61	QP	
3		1.8740	43.29	0.13	43.42	56.00	-12.58	QP	
4	*	2.3180	43.32	0.13	43.45	56.00	-12.55	QP	
5		3.5780	41.24	0.16	41.40	56.00	-14.60	QP	
6		3.5780	32.48	0.16	32.64	46.00	-13.36	AVG	
7		4.6740	40.18	0.17	40.35	56.00	-15.65	QP	
8		4.6740	31.21	0.17	31.38	46.00	-14.62	AVG	

\*:Maximum data x:Over limit !:over margin

●ReferenceOnly

Unless otherwise stated the results shown in this test report refer only to the sample(s) tested and such sample(s) are retained for 90 days only.  
 除非另有說明，此報告結果僅對測試之樣品負責，同時此樣品僅保留90天。本報告未經本公司書面許可，不可部份複製。

This document is issued by the Company subject to its General Conditions of Service printed overleaf, available on request or accessible at [www.sgs.com/terms\\_and\\_conditions.htm](http://www.sgs.com/terms_and_conditions.htm) and, for electronic format documents, subject to Terms and Conditions for Electronic Documents at [www.sgs.com/terms\\_e-document.htm](http://www.sgs.com/terms_e-document.htm). Attention is drawn to the limitation of liability, indemnification and jurisdiction issues defined therein. Any holder of this document is advised that information contained hereon reflects the Company's findings at the time of its intervention only and within the limits of Client's instructions, if any. The Company's sole responsibility is to its Client and this document does not exonerate parties to a transaction from exercising all their rights and obligations under the transaction documents. This document cannot be reproduced except in full, without prior written approval of the Company. Any unauthorized alteration, forgery or falsification of the content or appearance of this document is unlawful and offenders may be prosecuted to the fullest extent of the law.

Second :EMERSON

L



臺灣檢驗科技股份有限公司 -電子資訊服務部  
 台北縣五股工業區五工路 134 號  
 電話 : ( 02 ) 22993279 傳真 : ( 02 ) 22982698

Conducted Emission Measurement

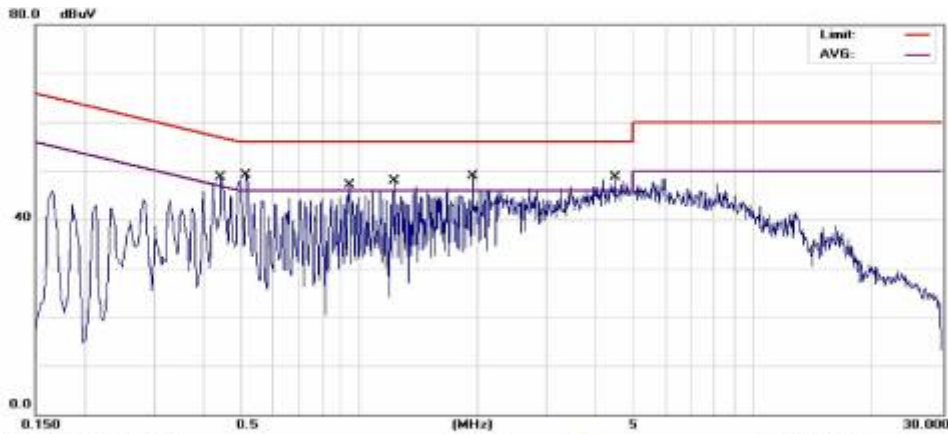

Site: SGS CONDUCTED #1 Phase: **L1** Temperature: 25 °C  
 Limit: FCC Class B Conduction(QP) Power: AC 120V/60Hz Humidity: 59%  
 EUT: Distance: Air Pressure: hpa  
 MN:  
 Note: Config 2: UE+Battery+AC Adaptor+USB Cable+SHF+FULL System ; Recording  
 ( 27% battery capacity ) , Adapter(Sec EMERSON)

No.	Mk.	Freq. MHz	Reading Level dBuV	Factor dB	Measure- ment dBuV	Limit dBuV	Over dB	Detector	Comment
1		0.4460	46.28	0.09	46.37	56.95	-10.58	QP	
2	*	0.4460	37.26	0.09	37.35	46.95	-9.60	AVG	
3		0.5180	44.07	0.09	44.16	56.00	-11.84	QP	
4		0.5180	34.49	0.09	34.58	46.00	-11.42	AVG	
5		0.9460	41.48	0.08	41.56	56.00	-14.44	QP	
6		0.9460	29.34	0.08	29.42	46.00	-16.58	AVG	
7		1.2260	40.19	0.08	40.27	56.00	-15.73	QP	
8		1.2260	29.78	0.08	29.86	46.00	-16.14	AVG	
9		1.9460	40.56	0.10	40.66	56.00	-15.34	QP	
10		1.9460	30.06	0.10	30.16	46.00	-15.84	AVG	
11		4.4700	41.65	0.12	41.77	56.00	-14.23	QP	
12		4.4700	32.39	0.12	32.51	46.00	-13.49	AVG	

\*:Maximum data x:Over limit !:over margin

●ReferenceOnly

Unless otherwise stated the results shown in this test report refer only to the sample(s) tested and such sample(s) are retained for 90 days only.  
 除非另有說明，此報告結果僅對測試之樣品負責，同時此樣品僅保留90天。本報告未經本公司書面許可，不可部份複製。

This document is issued by the Company subject to its General Conditions of Service printed overleaf, available on request or accessible at [www.sgs.com/terms\\_and\\_conditions.htm](http://www.sgs.com/terms_and_conditions.htm) and, for electronic format documents, subject to Terms and Conditions for Electronic Documents at [www.sgs.com/terms\\_e-document.htm](http://www.sgs.com/terms_e-document.htm). Attention is drawn to the limitation of liability, indemnification and jurisdiction issues defined therein. Any holder of this document is advised that information contained hereon reflects the Company's findings at the time of its intervention only and within the limits of Client's instructions, if any. The Company's sole responsibility is to its Client and this document does not exonerate parties to a transaction from exercising all their rights and obligations under the transaction documents. This document cannot be reproduced except in full, without prior written approval of the Company. Any unauthorized alteration, forgery or falsification of the content or appearance of this document is unlawful and offenders may be prosecuted to the fullest extent of the law.

N



臺灣檢驗科技股份有限公司 - 電子資訊服務部  
 台北縣五股工業區五工路 134 號  
 電話 : ( 02 ) 22993279 傳真 : ( 02 ) 22982698

Conducted Emission Measurement

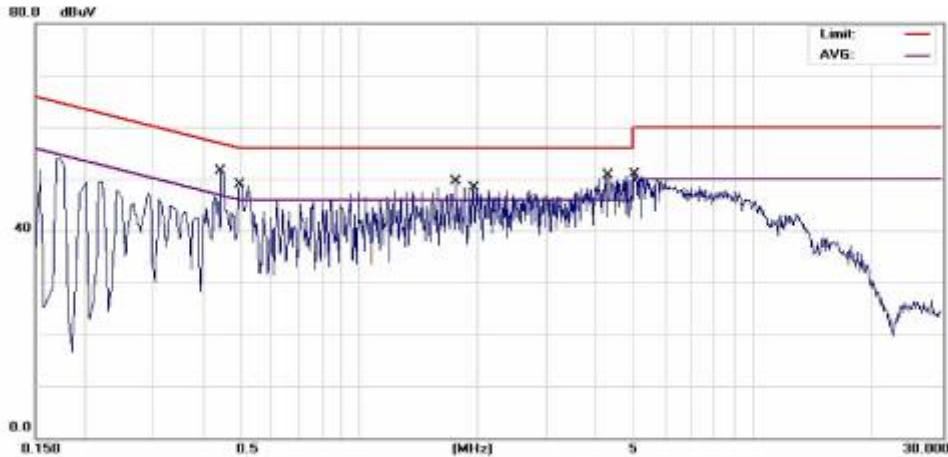

Site SGS CONDUCTED #1 Phase: **N** Temperature: 26 °C  
 Limit: FCC Class B Conduction(QP) Power: AC 120V/60Hz Humidity: 52%  
 EUT: Distance: Air Pressure: hpa  
 MN:  
 Note: Config 2: UE+Battery+AC Adaptor+USB Cable+SHF+FULL System ; Recording  
 ( 27% battery capacity) , Adapter(Sec EMERSON)

No.	Mk.	Freq. MHz	Reading Level dBuV	Factor dB	Measure- ment dBuV	Limit dBuV	Over dB	Detector	Comment
1		0.4460	48.93	0.13	49.06	56.95	-7.89	QP	
2	*	0.4460	41.50	0.13	41.63	46.95	-5.32	AVG	
3		0.4980	45.22	0.13	45.35	56.03	-10.68	QP	
4		0.4980	37.75	0.13	37.88	46.03	-8.15	AVG	
5		1.7660	43.29	0.13	43.42	56.00	-12.58	QP	
6		1.7660	33.12	0.13	33.25	46.00	-12.75	AVG	
7		1.9500	40.59	0.13	40.72	56.00	-15.28	QP	
8		1.9500	32.16	0.13	32.29	46.00	-13.71	AVG	
9		4.2780	43.30	0.16	43.46	56.00	-12.54	QP	
10		4.2780	34.59	0.16	34.75	46.00	-11.25	AVG	
11		4.9660	44.72	0.17	44.89	56.00	-11.11	QP	
12		4.9660	35.40	0.17	35.57	46.00	-10.43	AVG	

\*:Maximum data x:Over limit !:over margin ■ReferenceOnly

Unless otherwise stated the results shown in this test report refer only to the sample(s) tested and such sample(s) are retained for 90 days only.  
 除非另有說明，此報告結果僅對測試之樣品負責，同時此樣品僅保留90天。本報告未經本公司書面許可，不可部份複製。

This document is issued by the Company subject to its General Conditions of Service printed overleaf, available on request or accessible at [www.sgs.com/terms\\_and\\_conditions.htm](http://www.sgs.com/terms_and_conditions.htm) and, for electronic format documents, subject to Terms and Conditions for Electronic Documents at [www.sgs.com/terms\\_e-document.htm](http://www.sgs.com/terms_e-document.htm). Attention is drawn to the limitation of liability, indemnification and jurisdiction issues defined therein. Any holder of this document is advised that information contained hereon reflects the Company's findings at the time of its intervention only and within the limits of Client's instructions, if any. The Company's sole responsibility is to its Client and this document does not exonerate parties to a transaction from exercising all their rights and obligations under the transaction documents. This document cannot be reproduced except in full, without prior written approval of the Company. Any unauthorized alteration, forgery or falsification of the content or appearance of this document is unlawful and offenders may be prosecuted to the fullest extent of the law.

Config 2 : Play Recording  
Main:Salcomp  
L



臺灣檢驗科技股份有限公司 - 電子電訊服務部  
台北縣五股工業區五工路 134 號  
電話 : ( 02 ) 22993279 傳真 : ( 02 ) 22982698

Conducted Emission Measurement

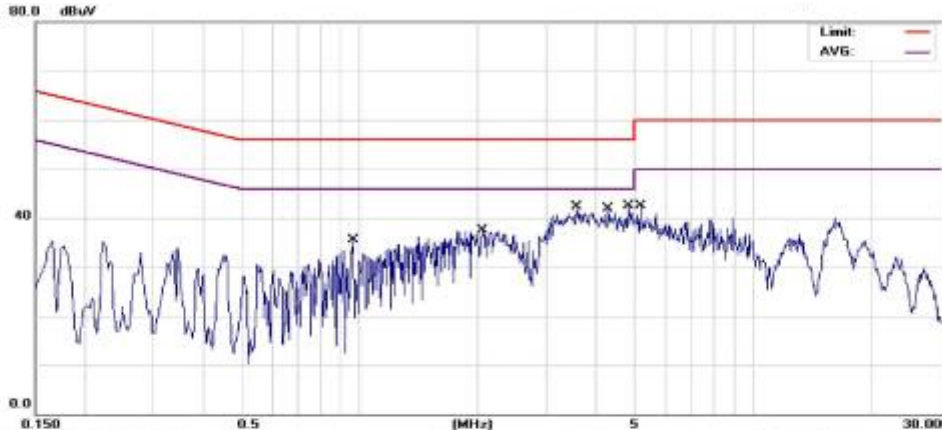

Site SGS CONDUCTED #1 Phase: **L1** Temperature: 28 °C  
Limit: FCC Class B Conduction(QP) Power: AC 120V/60Hz Humidity: 50%  
EUT: Distance: Air Pressure: hpa  
MN:  
Note: Config 2: UE+Battery+AC Adaptor+USB Cable+SHF+FULL System ; Play Recording  
( 27% battery capacity ) , Adaptor : 1227-9853.1

No.	Mk.	Freq. MHz	Reading Level dBuV	Factor dB	Measurement dBuV	Limit dBuV	Over dB	Detector	Comment
1		0.9860	35.45	0.08	35.53	56.00	-20.47	QP	
2		2.0580	37.39	0.10	37.49	58.00	-18.51	QP	
3		3.5740	42.17	0.12	42.29	56.00	-13.71	QP	
4		4.2940	41.85	0.12	41.97	56.00	-14.03	QP	
5	*	4.8280	42.37	0.13	42.50	56.00	-13.50	QP	
6		5.1740	42.30	0.13	42.43	60.00	-17.57	QP	

\*:Maximum data x:Over limit !:over margin Reference Only

Unless otherwise stated the results shown in this test report refer only to the sample(s) tested and such sample(s) are retained for 90 days only.  
除非另有說明，此報告結果僅對測試之樣品負責，同時此樣品僅保留90天。本報告未經本公司書面許可，不可部份複製。

This document is issued by the Company subject to its General Conditions of Service printed overleaf, available on request or accessible at [www.sgs.com/terms\\_and\\_conditions.htm](http://www.sgs.com/terms_and_conditions.htm) and, for electronic format documents, subject to Terms and Conditions for Electronic Documents at [www.sgs.com/terms\\_e-document.htm](http://www.sgs.com/terms_e-document.htm). Attention is drawn to the limitation of liability, indemnification and jurisdiction issues defined therein. Any holder of this document is advised that information contained hereon reflects the Company's findings at the time of its intervention only and within the limits of Client's instructions, if any. The Company's sole responsibility is to its Client and this document does not exonerate parties to a transaction from exercising all their rights and obligations under the transaction documents. This document cannot be reproduced except in full, without prior written approval of the Company. Any unauthorized alteration, forgery or falsification of the content or appearance of this document is unlawful and offenders may be prosecuted to the fullest extent of the law.

N



臺灣檢驗科技股份有限公司 - 電子電訊服務部  
 台北縣五股工業區五工路 134 號  
 電話 : ( 02 ) 22993279 傳真 : ( 02 ) 22982698

Conducted Emission Measurement

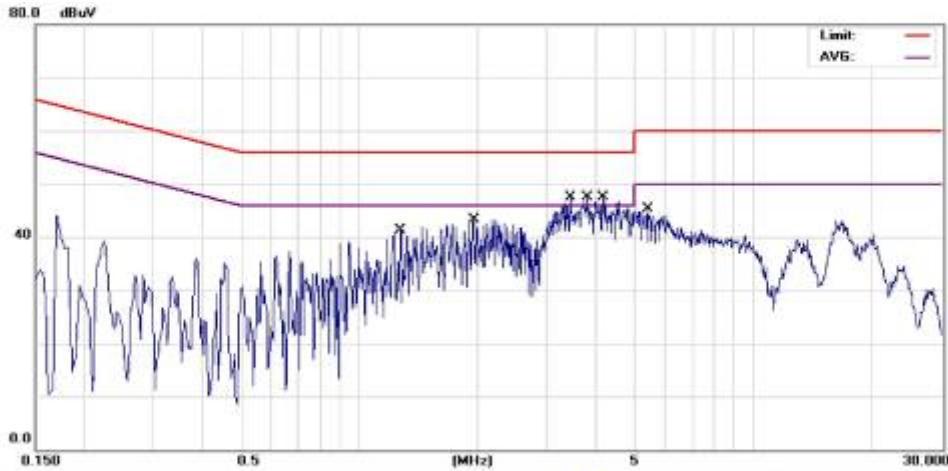

Site SGS CONDUCTED #1 Phase: **N** Temperature: 28 °C  
 Limit: FCC Class B Conduction (QP) Power: AC 120V/60Hz Humidity: 59%  
 EUT: Distance: Air Pressure: hpa  
 MN:  
 Note: Config 2: UE+Battery+AC Adaptor+USB Cable+SHF+FULL System ; Play Recording  
 ( 27% battery capacity ) , Adaptor : 1227-9853.1

No.	Mk.	Freq. MHz	Reading Level dBuV	Factor dB	Measurement dBuV	Limit dBuV	Over dB	Detector	Comment
1		1.2740	41.26	0.12	41.38	56.00	-14.62	QP	
2	*	1.9500	43.09	0.13	43.22	56.00	-12.78	QP	
3		3.4500	40.94	0.15	41.09	56.00	-14.91	QP	
4		3.4500	32.00	0.15	32.15	46.00	-13.85	AVG	
5		3.8180	40.77	0.16	40.93	56.00	-15.07	QP	
6		3.8180	31.91	0.16	32.07	46.00	-13.93	AVG	
7		4.1620	40.21	0.16	40.37	56.00	-15.63	QP	
8		4.1620	31.71	0.16	31.87	46.00	-14.13	AVG	
9		5.4260	45.05	0.17	45.22	60.00	-14.78	QP	

\*:Maximum data x:Over limit !:over margin

●Reference Only

Unless otherwise stated the results shown in this test report refer only to the sample(s) tested and such sample(s) are retained for 90 days only.  
 除非另有說明，此報告結果僅對測試之樣品負責，同時此樣品僅保留90天。本報告未經本公司書面許可，不可部份複製。

This document is issued by the Company subject to its General Conditions of Service printed overleaf, available on request or accessible at [www.sgs.com/terms\\_and\\_conditions.htm](http://www.sgs.com/terms_and_conditions.htm) and, for electronic format documents, subject to Terms and Conditions for Electronic Documents at [www.sgs.com/terms\\_e-document.htm](http://www.sgs.com/terms_e-document.htm). Attention is drawn to the limitation of liability, indemnification and jurisdiction issues defined therein. Any holder of this document is advised that information contained hereon reflects the Company's findings at the time of its intervention only and within the limits of Client's instructions, if any. The Company's sole responsibility is to its Client and this document does not exonerate parties to a transaction from exercising all their rights and obligations under the transaction documents. This document cannot be reproduced except in full, without prior written approval of the Company. Any unauthorized alteration, forgery or falsification of the content or appearance of this document is unlawful and offenders may be prosecuted to the fullest extent of the law.

Second :EMERSON

L



臺灣檢驗科技股份有限公司 -電子電訊服務部  
 台北縣五股工業區五工路 134 號  
 電話 : ( 02 ) 22993279 傳真 : ( 02 ) 22982698

Conducted Emission Measurement

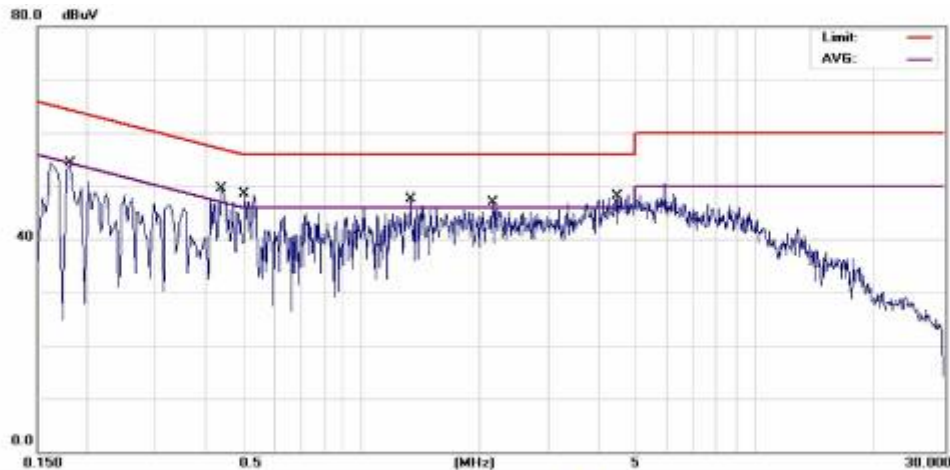

Site SGS CONDUCTED #1 Phase: **L1** Temperature: 25 °C  
 Limit: FCC Class B Conduction(QP) Power: AC 120V/60Hz Humidity: 59%  
 EUT: Distance: Air Pressure: hpa  
 MN:  
 Note: Config 2: UE+Battery+AC Adaptor+USB Cable+SHF+FULL System ; Play Recording  
 ( 27% battery capacity) , Adapter(Sec EMERSON)

No.	Mk.	Freq. MHz	Reading Level dBuV	Factor dB	Measure- ment dBuV	Limit dBuV	Over dB	Detector	Comment
1		0.1820	47.85	0.10	47.95	64.39	-16.44	QP	
2		0.1820	30.18	0.10	30.28	54.39	-24.11	AVG	
3		0.4420	45.01	0.09	45.10	57.02	-11.92	QP	
4		0.4420	35.73	0.09	35.82	47.02	-11.20	AVG	
5	*	0.5060	45.76	0.09	45.85	56.00	-10.15	QP	
6		0.5060	33.83	0.09	33.92	46.00	-12.08	AVG	
7		1.3340	41.37	0.08	41.45	56.00	-14.55	QP	
8		1.3340	29.89	0.08	29.97	46.00	-16.03	AVG	
9		2.1580	40.42	0.10	40.52	56.00	-15.48	QP	
10		2.1580	30.01	0.10	30.11	46.00	-15.89	AVG	
11		4.4860	41.55	0.12	41.67	56.00	-14.33	QP	
12		4.4860	32.27	0.12	32.39	46.00	-13.61	AVG	

\*:Maximum data x:Over limit !:over margin ●Reference Only

Unless otherwise stated the results shown in this test report refer only to the sample(s) tested and such sample(s) are retained for 90 days only.  
 除非另有說明，此報告結果僅對測試之樣品負責，同時此樣品僅保留90天。本報告未經本公司書面許可，不可部份複製。

This document is issued by the Company subject to its General Conditions of Service printed overleaf, available on request or accessible at [www.sgs.com/terms\\_and\\_conditions.htm](http://www.sgs.com/terms_and_conditions.htm) and, for electronic format documents, subject to Terms and Conditions for Electronic Documents at [www.sgs.com/terms\\_e-document.htm](http://www.sgs.com/terms_e-document.htm). Attention is drawn to the limitation of liability, indemnification and jurisdiction issues defined therein. Any holder of this document is advised that information contained hereon reflects the Company's findings at the time of its intervention only and within the limits of Client's instructions, if any. The Company's sole responsibility is to its Client and this document does not exonerate parties to a transaction from exercising all their rights and obligations under the transaction documents. This document cannot be reproduced except in full, without prior written approval of the Company. Any unauthorized alteration, forgery or falsification of the content or appearance of this document is unlawful and offenders may be prosecuted to the fullest extent of the law.

N



臺灣檢驗科技股份有限公司 - 電子電訊服務部  
 台北縣五股工業區五工路 134 號  
 電話 : ( 02 ) 22993279 傳真 : ( 02 ) 22982698

Conducted Emission Measurement

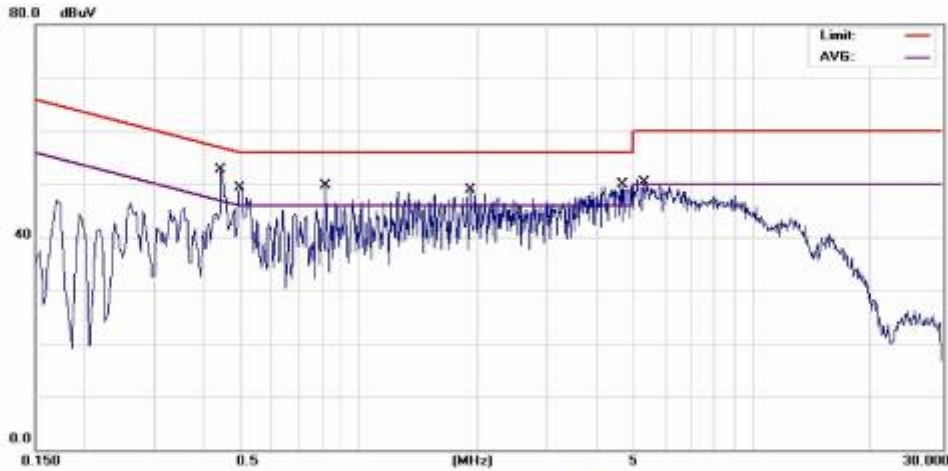

Site: SGS CONDUCTED #1 Phase: N Temperature: 25 °C  
 Limit: FCC Class B Conduction(QP) Power: AC 120V/60Hz Humidity: 59%  
 EUT: Distance: Air Pressure: hpa  
 MN:  
 Note: Config 2: UE+Battery+AC Adaptor+USB Cable+SHF+FULL System ; Play Recording  
 ( 27% battery capacity ) , Adapter(Sec EMERSON)

No.	Mk.	Freq. MHz	Reading Level dBuV	Factor dB	Measure- ment dBuV	Limit dBuV	Over dB	Detector	Comment
1		0.4460	48.73	0.13	48.86	56.95	-8.09	QP	
2	*	0.4460	41.84	0.13	41.97	46.95	-4.98	AVG	
3		0.4980	45.35	0.13	45.48	56.03	-10.55	QP	
4		0.4980	38.06	0.13	38.19	46.03	-7.84	AVG	
5		0.8260	42.88	0.12	43.00	56.00	-13.00	QP	
6		0.8260	32.18	0.12	32.30	46.00	-13.70	AVG	
7		1.9220	44.01	0.13	44.14	56.00	-11.86	QP	
8		1.9220	33.57	0.13	33.70	46.00	-12.30	AVG	
9		4.6780	44.24	0.17	44.41	56.00	-11.59	QP	
10		4.6780	35.37	0.17	35.54	46.00	-10.46	AVG	
11		5.3300	44.19	0.17	44.36	60.00	-15.64	QP	
12		5.3300	35.14	0.17	35.31	50.00	-14.69	AVG	

\*:Maximum data x:Over limit !:over margin

●Reference Only

Unless otherwise stated the results shown in this test report refer only to the sample(s) tested and such sample(s) are retained for 90 days only.  
 除非另有說明，此報告結果僅對測試之樣品負責，同時此樣品僅保留90天。本報告未經本公司書面許可，不可部份複製。

This document is issued by the Company subject to its General Conditions of Service printed overleaf, available on request or accessible at [www.sgs.com/terms\\_and\\_conditions.htm](http://www.sgs.com/terms_and_conditions.htm) and, for electronic format documents, subject to Terms and Conditions for Electronic Documents at [www.sgs.com/terms\\_e-document.htm](http://www.sgs.com/terms_e-document.htm). Attention is drawn to the limitation of liability, indemnification and jurisdiction issues defined therein. Any holder of this document is advised that information contained hereon reflects the Company's findings at the time of its intervention only and within the limits of Client's instructions, if any. The Company's sole responsibility is to its Client and this document does not exonerate parties to a transaction from exercising all their rights and obligations under the transaction documents. This document cannot be reproduced except in full, without prior written approval of the Company. Any unauthorized alteration, forgery or falsification of the content or appearance of this document is unlawful and offenders may be prosecuted to the fullest extent of the law.

Config 2 : MP3  
Main:Salcomp  
L



臺灣檢驗科技股份有限公司 - 電子資訊服務部  
台北縣五股工業區五工路 134 號  
電話 : ( 02 ) 22993279 傳真 : ( 02 ) 22982698

Conducted Emission Measurement

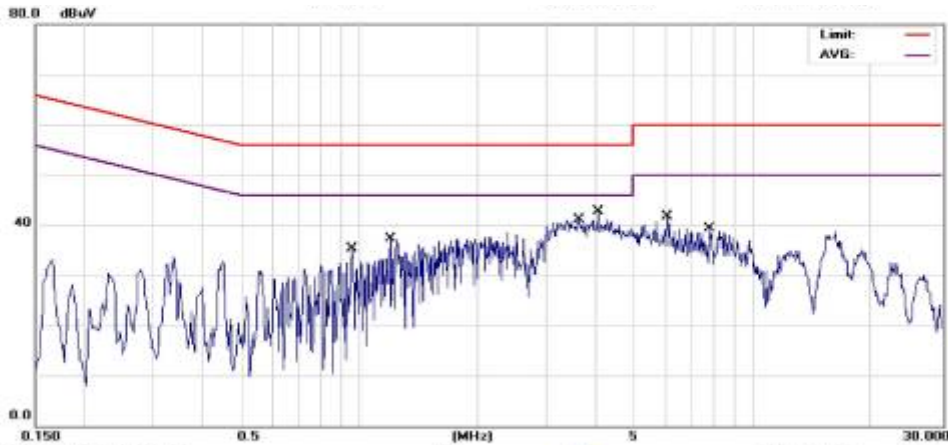

Site: SGS CONDUCTED #1  
Limit: FCC Class B Conduction(QP)  
EUT:  
MN:  
Note: Config 2: UE+Battery+AC Adaptor+USB Cable+SHF+FULL System ; MP3  
( 27% battery capacity) , Adaptor : 1227-9853.1

Phase: L1  
Power: AC 120V/60Hz  
Distance:  
Temperature: 26 °C  
Humidity: 56%  
Air Pressure: hpa

No.	Mk.	Freq. MHz	Reading Level dBuV	Factor dB	Measure- ment dBuV	Limit dBuV	Over dB	Detector	Comment
1		0.9620	35.30	0.08	35.38	56.00	-20.62	QP	
2		1.1980	37.18	0.08	37.26	56.00	-18.74	QP	
3		3.6220	40.95	0.12	41.07	56.00	-14.93	QP	
4	*	4.0620	42.49	0.12	42.61	56.00	-13.39	QP	
5		6.0580	41.63	0.14	41.77	60.00	-18.23	QP	
6		7.7300	39.18	0.15	39.33	60.00	-20.67	QP	

\*:Maximum data x:Over limit !:over margin

●Reference Only

Unless otherwise stated the results shown in this test report refer only to the sample(s) tested and such sample(s) are retained for 90 days only.  
除非另有說明，此報告結果僅對測試之樣品負責，同時此樣品僅保留90天。本報告未經本公司書面許可，不可部份複製。

This document is issued by the Company subject to its General Conditions of Service printed overleaf, available on request or accessible at [www.sgs.com/terms\\_and\\_conditions.htm](http://www.sgs.com/terms_and_conditions.htm) and, for electronic format documents, subject to Terms and Conditions for Electronic Documents at [www.sgs.com/terms\\_e-document.htm](http://www.sgs.com/terms_e-document.htm). Attention is drawn to the limitation of liability, indemnification and jurisdiction issues defined therein. Any holder of this document is advised that information contained hereon reflects the Company's findings at the time of its intervention only and within the limits of Client's instructions, if any. The Company's sole responsibility is to its Client and this document does not exonerate parties to a transaction from exercising all their rights and obligations under the transaction documents. This document cannot be reproduced except in full, without prior written approval of the Company. Any unauthorized alteration, forgery or falsification of the content or appearance of this document is unlawful and offenders may be prosecuted to the fullest extent of the law.



N



臺灣檢驗科技股份有限公司 - 電子資訊服務部  
 台北縣五股工業區五工路 134 號  
 電話 : ( 02 ) 22993279 傳真 : ( 02 ) 22982698

Conducted Emission Measurement

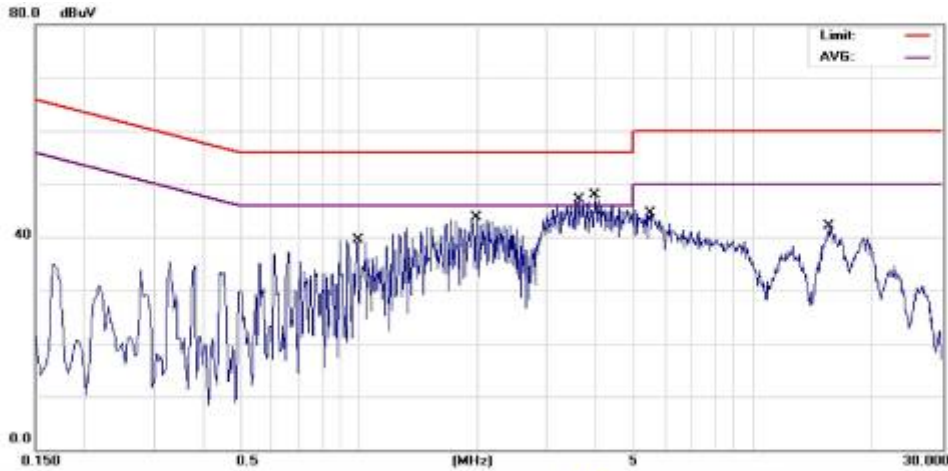

Site: SGS CONDUCTED #1 Phase: N Temperature: 25 °C  
 Limit: FCC Class B Conduction (QP) Power: AC 120V/60Hz Humidity: 59%  
 EUT: Distance: Air Pressure: hpa  
 MN:  
 Note: Config 2: UE+Battery+AC Adaptor+USB Cable+SHF+FULL System ; MP3  
 ( 27% battery capacity ) , Adaptor : 1227-9853.1

No.	Mk.	Freq. MHz	Reading Level dBuV	Factor dB	Measurement dBuV	Limit dBuV	Over dB	Detector	Comment
1		0.9900	39.40	0.12	39.52	56.00	-16.48	QP	
2	*	1.9900	43.63	0.13	43.76	56.00	-12.24	QP	
3		3.6180	40.68	0.16	40.84	56.00	-15.16	QP	
4		3.6180	32.27	0.16	32.43	46.00	-13.57	AVG	
5		3.9660	40.76	0.16	40.92	56.00	-15.08	QP	
6		3.9660	32.12	0.16	32.28	46.00	-13.72	AVG	
7		5.4940	44.37	0.17	44.54	60.00	-15.46	QP	
8		15.7140	41.90	0.27	42.17	60.00	-17.83	QP	

\*:Maximum data x:Over limit !:over margin

●Reference Only

Unless otherwise stated the results shown in this test report refer only to the sample(s) tested and such sample(s) are retained for 90 days only.  
 除非另有說明，此報告結果僅對測試之樣品負責，同時此樣品僅保留90天。本報告未經本公司書面許可，不可部份複製。

This document is issued by the Company subject to its General Conditions of Service printed overleaf, available on request or accessible at [www.sgs.com/terms\\_and\\_conditions.htm](http://www.sgs.com/terms_and_conditions.htm) and, for electronic format documents, subject to Terms and Conditions for Electronic Documents at [www.sgs.com/terms\\_e-document.htm](http://www.sgs.com/terms_e-document.htm). Attention is drawn to the limitation of liability, indemnification and jurisdiction issues defined therein. Any holder of this document is advised that information contained hereon reflects the Company's findings at the time of its intervention only and within the limits of Client's instructions, if any. The Company's sole responsibility is to its Client and this document does not exonerate parties to a transaction from exercising all their rights and obligations under the transaction documents. This document cannot be reproduced except in full, without prior written approval of the Company. Any unauthorized alteration, forgery or falsification of the content or appearance of this document is unlawful and offenders may be prosecuted to the fullest extent of the law.

Second :EMERSON

L



臺灣檢驗科技股份有限公司 -電子電訊服務部  
 台北縣五股工業區五工路 134 號  
 電話 : ( 02 ) 22993279 傳真 : ( 02 ) 22982698

Conducted Emission Measurement

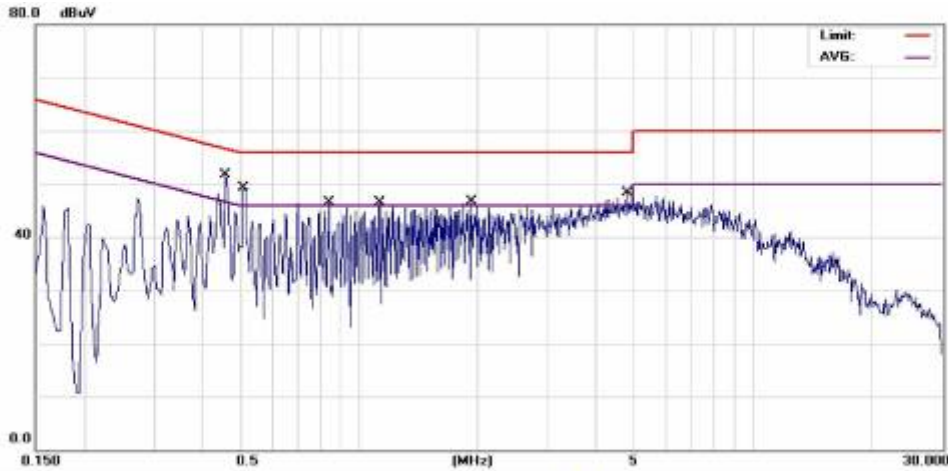

Site SGS CONDUCTED #1 Phase: **L1** Temperature: 25 °C  
 Limit: FCC Class B Conduction(QP) Power: AC 120V/60Hz Humidity: 59%  
 EUT: Distance: Air Pressure: hpa  
 MN:  
 Note: Config 2: UE+Battery+AC Adaptor+USB Cable+SHF+FULL System ; MP3  
 ( 27% battery capacity ) , Adapter(Sec EMERSON)

No.	Mk.	Freq. MHz	Reading Level dBuV	Factor dB	Measure- ment dBuV	Limit dBuV	Over dB	Detector	Comment
1		0.4580	44.85	0.09	44.94	56.73	-11.79	QP	
2		0.4580	33.83	0.09	33.92	46.73	-12.81	AVG	
3	*	0.5100	45.09	0.09	45.18	56.00	-10.82	QP	
4		0.5100	35.07	0.09	35.16	46.00	-10.84	AVG	
5		0.8420	37.73	0.08	37.81	56.00	-18.19	QP	
6		0.8420	26.25	0.08	26.33	46.00	-19.67	AVG	
7		1.1260	40.17	0.08	40.25	56.00	-15.75	QP	
8		1.1260	30.25	0.08	30.33	46.00	-15.67	AVG	
9		1.9380	40.30	0.10	40.40	56.00	-15.60	QP	
10		1.9380	30.06	0.10	30.16	46.00	-15.84	AVG	
11		4.8060	41.64	0.13	41.77	56.00	-14.23	QP	
12		4.8060	32.68	0.13	32.81	46.00	-13.19	AVG	

\*:Maximum data x:Over limit !:over margin

●Reference Only

Unless otherwise stated the results shown in this test report refer only to the sample(s) tested and such sample(s) are retained for 90 days only.  
 除非另有說明，此報告結果僅對測試之樣品負責，同時此樣品僅保留90天。本報告未經本公司書面許可，不可部份複製。

This document is issued by the Company subject to its General Conditions of Service printed overleaf, available on request or accessible at [www.sgs.com/terms\\_and\\_conditions.htm](http://www.sgs.com/terms_and_conditions.htm) and, for electronic format documents, subject to Terms and Conditions for Electronic Documents at [www.sgs.com/terms\\_e-document.htm](http://www.sgs.com/terms_e-document.htm). Attention is drawn to the limitation of liability, indemnification and jurisdiction issues defined therein. Any holder of this document is advised that information contained hereon reflects the Company's findings at the time of its intervention only and within the limits of Client's instructions, if any. The Company's sole responsibility is to its Client and this document does not exonerate parties to a transaction from exercising all their rights and obligations under the transaction documents. This document cannot be reproduced except in full, without prior written approval of the Company. Any unauthorized alteration, forgery or falsification of the content or appearance of this document is unlawful and offenders may be prosecuted to the fullest extent of the law.

N



臺灣檢驗科技股份有限公司 - 電子暨通訊服務部  
 台北縣五股工業區五工路 134 號  
 電話 : ( 02 ) 22993279 傳真 : ( 02 ) 22982698

Conducted Emission Measurement

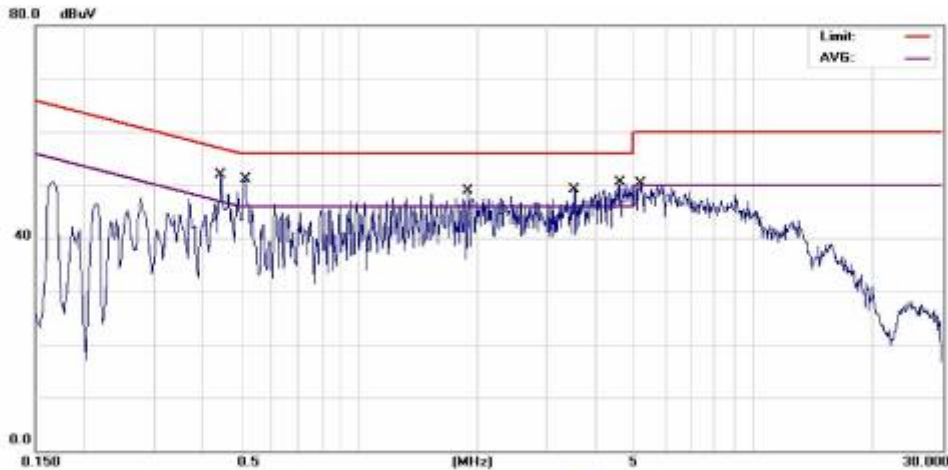

Site: SGS CONDUCTED #1  
 Limit: FCC Class B Conduction(QP)  
 EUT:  
 MN:  
 Note: Config 2: UE+Battery+AC Adaptor+USB Cable+SHF+FULL System ; MP3 ( 27% battery capacity ) , Adapter(Sec EMERSON)

Phase: N  
 Power: AC 120V/60Hz  
 Distance:  
 Temperature: 25 °C  
 Humidity: 56%  
 Air Pressure: hpa

No.	Mk.	Freq. MHz	Reading Level dBuV	Factor dB	Measure- ment dBuV	Limit dBuV	Over dB	Detector	Comment
1		0.4460	48.93	0.13	49.06	56.95	-7.89	QP	
2	*	0.4460	41.77	0.13	41.90	46.95	-5.05	AVG	
3		0.5140	45.51	0.13	45.64	56.00	-10.36	QP	
4		0.5140	38.37	0.13	38.50	46.00	-7.50	AVG	
5		1.8940	43.13	0.13	43.26	56.00	-12.74	QP	
6		1.8940	32.39	0.13	32.52	46.00	-13.48	AVG	
7		3.5180	41.44	0.16	41.60	56.00	-14.40	QP	
8		3.5180	32.72	0.16	32.88	46.00	-13.12	AVG	
9		4.6180	44.02	0.17	44.19	56.00	-11.81	QP	
10		4.6180	34.89	0.17	35.06	46.00	-10.94	AVG	
11		5.1940	43.96	0.17	44.13	60.00	-15.87	QP	
12		5.1940	35.11	0.17	35.28	50.00	-14.72	AVG	

\*:Maximum data x:Over limit !:over margin

●Reference Only

Unless otherwise stated the results shown in this test report refer only to the sample(s) tested and such sample(s) are retained for 90 days only.  
 除非另有說明，此報告結果僅對測試之樣品負責，同時此樣品僅保留90天。本報告未經本公司書面許可，不可部份複製。

This document is issued by the Company subject to its General Conditions of Service printed overleaf, available on request or accessible at [www.sgs.com/terms\\_and\\_conditions.htm](http://www.sgs.com/terms_and_conditions.htm) and, for electronic format documents, subject to Terms and Conditions for Electronic Documents at [www.sgs.com/terms\\_e-document.htm](http://www.sgs.com/terms_e-document.htm). Attention is drawn to the limitation of liability, indemnification and jurisdiction issues defined therein. Any holder of this document is advised that information contained hereon reflects the Company's findings at the time of its intervention only and within the limits of Client's instructions, if any. The Company's sole responsibility is to its Client and this document does not exonerate parties to a transaction from exercising all their rights and obligations under the transaction documents. This document cannot be reproduced except in full, without prior written approval of the Company. Any unauthorized alteration, forgery or falsification of the content or appearance of this document is unlawful and offenders may be prosecuted to the fullest extent of the law.

Config 3 : FM 87.6

L



臺灣檢驗科技股份有限公司 - 電子暨通訊實驗室  
Address : 台北縣五股工業區五工路 134 號  
Tel:02-2299-3279 Fax:02-2298-2698

Conducted Emission Measurement

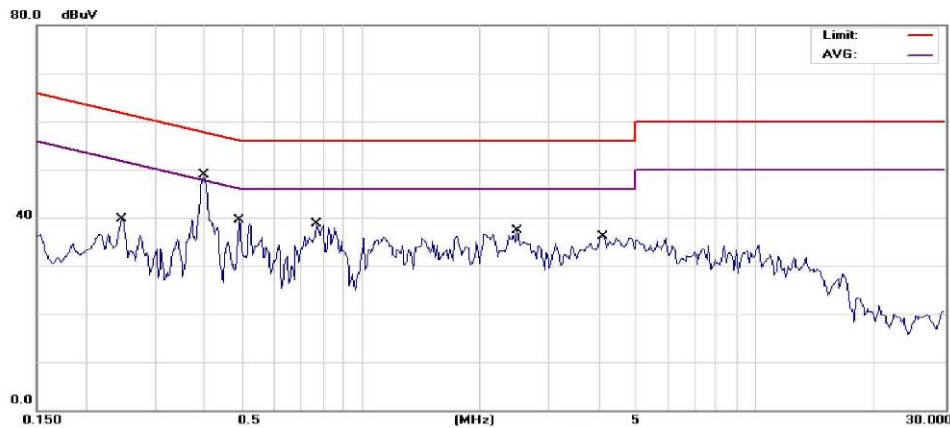

Site: ConductionRoom Phase: **L1** Temperature: 26 °C  
Limit: FCC Class B Conduction(QP) Power: AC 120V/60Hz Humidity: 60%  
EUT: Tapioca Distance:  
M/N:  
Mode: FM87.6  
Note:

No.	Mk.	Freq. MHz	Reading Level dBuV	Correct Factor dB	Measurement dBuV	Limit dBuV	Over dB	Detector	Comment
1		0.2477	34.42	0.21	34.63	61.83	-27.20	QP	
2		0.2477	27.05	0.21	27.26	51.83	-24.57	AVG	
3		0.4002	47.33	0.22	47.55	57.85	-10.30	QP	
4	*	0.4002	40.14	0.22	40.36	47.85	-7.49	AVG	
5		0.4902	35.36	0.22	35.58	56.16	-20.58	QP	
6		0.4902	31.58	0.22	31.80	46.16	-14.36	AVG	
7		0.7698	33.03	0.22	33.25	56.00	-22.75	QP	
8		0.7698	24.21	0.22	24.43	46.00	-21.57	AVG	
9		2.4902	30.76	0.26	31.02	56.00	-24.98	QP	
10		2.4902	23.47	0.26	23.73	46.00	-22.27	AVG	
11		4.0972	29.42	0.30	29.72	56.00	-26.28	QP	
12		4.0972	21.49	0.30	21.79	46.00	-24.21	AVG	

\*:Maximum data x:Over limit !:over margin ●Reference Only

Unless otherwise stated the results shown in this test report refer only to the sample(s) tested and such sample(s) are retained for 90 days only.  
除非另有說明，此報告結果僅對測試之樣品負責，同時此樣品僅保留90天。本報告未經本公司書面許可，不可部份複製。

This document is issued by the Company subject to its General Conditions of Service printed overleaf, available on request or accessible at [www.sgs.com/terms\\_and\\_conditions.htm](http://www.sgs.com/terms_and_conditions.htm) and, for electronic format documents, subject to Terms and Conditions for Electronic Documents at [www.sgs.com/terms\\_e-document.htm](http://www.sgs.com/terms_e-document.htm). Attention is drawn to the limitation of liability, indemnification and jurisdiction issues defined therein. Any holder of this document is advised that information contained hereon reflects the Company's findings at the time of its intervention only and within the limits of Client's instructions, if any. The Company's sole responsibility is to its Client and this document does not exonerate parties to a transaction from exercising all their rights and obligations under the transaction documents. This document cannot be reproduced except in full, without prior written approval of the Company. Any unauthorized alteration, forgery or falsification of the content or appearance of this document is unlawful and offenders may be prosecuted to the fullest extent of the law.

N



臺灣檢驗科技股份有限公司-電子暨通訊實驗室  
Address : 台北縣五股工業區五工路 134 號  
Tel:02-2299-3279 Fax:02-2298-2698

Conducted Emission Measurement



Site: ConductionRoom Phase: **N** Temperature: 26 °C  
Limit: FCC Class B Conduction(QP) Power: AC 120V/60Hz Humidity: 60%  
EUT: Tapioca Distance:  
M/N:  
Mode: FM87.6  
Note:

No.	Mk.	Freq. MHz	Reading Level dBuV	Correct Factor dB	Measure- ment dBuV	Limit dBuV	Over dB	Detector	Comment
1		0.3963	47.63	0.34	47.97	57.93	-9.96	QP	
2	*	0.3963	40.48	0.34	40.82	47.93	-7.11	AVG	
3		0.4941	39.48	0.34	39.82	56.10	-16.28	QP	
4		0.4941	33.22	0.34	33.56	46.10	-12.54	AVG	
5		0.7854	35.44	0.32	35.76	56.00	-20.24	QP	
6		0.7854	26.37	0.32	26.69	46.00	-19.31	AVG	
7		1.0552	33.92	0.31	34.23	56.00	-21.77	QP	
8		1.0552	24.27	0.31	24.58	46.00	-21.42	AVG	
9		1.3798	35.62	0.31	35.93	56.00	-20.07	QP	
10		1.3798	28.22	0.31	28.53	46.00	-17.47	AVG	
11		2.5215	33.68	0.34	34.02	56.00	-21.98	QP	
12		2.5215	24.89	0.34	25.23	46.00	-20.77	AVG	

\*:Maximum data x:Over limit !:over margin ●Reference Only

Unless otherwise stated the results shown in this test report refer only to the sample(s) tested and such sample(s) are retained for 90 days only.  
除非另有說明，此報告結果僅對測試之樣品負責，同時此樣品僅保留90天。本報告未經本公司書面許可，不可部份複製。

This document is issued by the Company subject to its General Conditions of Service printed overleaf, available on request or accessible at [www.sgs.com/terms\\_and\\_conditions.htm](http://www.sgs.com/terms_and_conditions.htm) and, for electronic format documents, subject to Terms and Conditions for Electronic Documents at [www.sgs.com/terms\\_e-document.htm](http://www.sgs.com/terms_e-document.htm). Attention is drawn to the limitation of liability, indemnification and jurisdiction issues defined therein. Any holder of this document is advised that information contained hereon reflects the Company's findings at the time of its intervention only and within the limits of Client's instructions, if any. The Company's sole responsibility is to its Client and this document does not exonerate parties to a transaction from exercising all their rights and obligations under the transaction documents. This document cannot be reproduced except in full, without prior written approval of the Company. Any unauthorized alteration, forgery or falsification of the content or appearance of this document is unlawful and offenders may be prosecuted to the fullest extent of the law.

Config 3 : FM 98

L



臺灣檢驗科技股份有限公司 -電子暨通訊實驗室  
 Address :台北縣五股工業區五工路 134 號  
 Tel:02-2299-3279 Fax:02-2298-2698

Conducted Emission Measurement

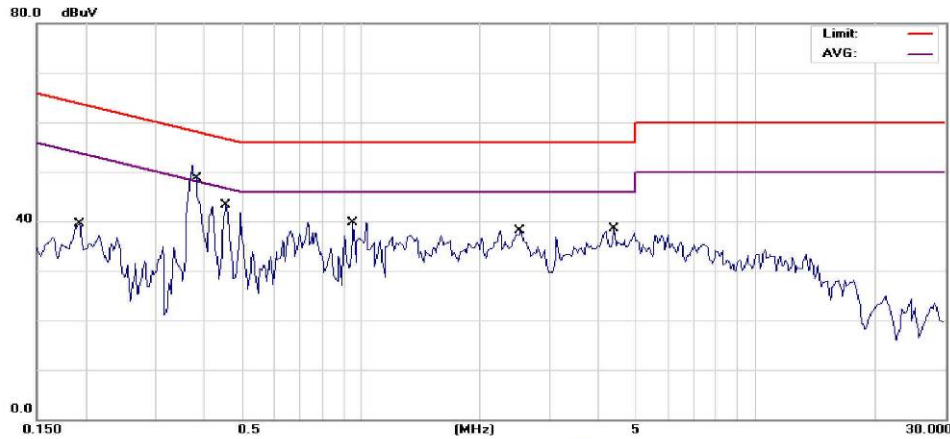

Site: ConductionRoom Phase: L1 Temperature: 26 °C  
 Limit: FCC Class B Conduction(QP) Power: AC 120V/60Hz Humidity: 60%  
 EUT: Tapioca Distance:  
 M/N:  
 Mode: FM98  
 Note:

No.	Mk.	Freq. MHz	Reading Level dBuV	Correct Factor dB	Measure- ment dBuV	Limit dBuV	Over dB	Detector	Comment
1		0.1930	31.19	0.21	31.40	63.91	-32.51	QP	
2		0.1930	20.93	0.21	21.14	53.91	-32.77	AVG	
3		0.3858	48.10	0.22	48.32	58.15	-9.83	QP	
4	*	0.3858	40.29	0.22	40.51	48.15	-7.64	AVG	
5		0.4550	40.10	0.22	40.32	56.78	-16.46	QP	
6		0.4550	32.33	0.22	32.55	46.78	-14.23	AVG	
7		0.9536	32.73	0.22	32.95	56.00	-23.05	QP	
8		0.9536	26.45	0.22	26.67	46.00	-19.33	AVG	
9		2.5371	32.60	0.27	32.87	56.00	-23.13	QP	
10		2.5371	25.08	0.27	25.35	46.00	-20.65	AVG	
11		4.3826	31.27	0.31	31.58	56.00	-24.42	QP	
12		4.3826	22.71	0.31	23.02	46.00	-22.98	AVG	

\*:Maximum data x:Over limit !:over margin ●Reference Only

Unless otherwise stated the results shown in this test report refer only to the sample(s) tested and such sample(s) are retained for 90 days only.  
 除非另有說明，此報告結果僅對測試之樣品負責，同時此樣品僅保留90天。本報告未經本公司書面許可，不可部份複製。

This document is issued by the Company subject to its General Conditions of Service printed overleaf, available on request or accessible at [www.sgs.com/terms\\_and\\_conditions.htm](http://www.sgs.com/terms_and_conditions.htm) and, for electronic format documents, subject to Terms and Conditions for Electronic Documents at [www.sgs.com/terms\\_e-document.htm](http://www.sgs.com/terms_e-document.htm). Attention is drawn to the limitation of liability, indemnification and jurisdiction issues defined therein. Any holder of this document is advised that information contained hereon reflects the Company's findings at the time of its intervention only and within the limits of Client's instructions, if any. The Company's sole responsibility is to its Client and this document does not exonerate parties to a transaction from exercising all their rights and obligations under the transaction documents. This document cannot be reproduced except in full, without prior written approval of the Company. Any unauthorized alteration, forgery or falsification of the content or appearance of this document is unlawful and offenders may be prosecuted to the fullest extent of the law.

N



臺灣檢驗科技股份有限公司 - 電子暨通訊實驗室  
 Address : 台北縣五股工業區五工路 134 號  
 Tel:02-2299-3279 Fax:02-2298-2698

Conducted Emission Measurement

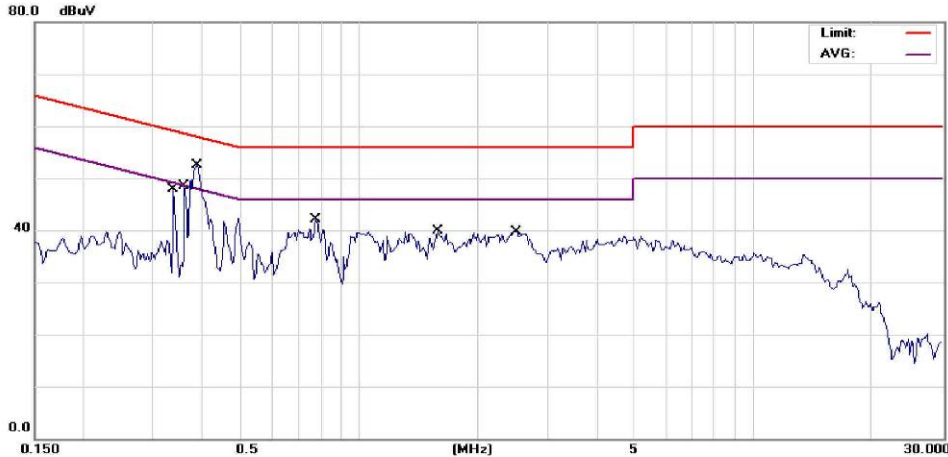

Site: ConductionRoom Phase: **N** Temperature: 26 °C  
 Limit: FCC Class B Conduction(QP) Power: AC 120V/60Hz Humidity: 60%  
 EUT: Tapioca Distance:  
 M/N:  
 Mode: FM98  
 Note:

No.	Mk.	Freq. MHz	Reading Level dBuV	Correct Factor dB	Measurement dBuV	Limit dBuV	Over dB	Detector	Comment
1		0.3377	29.78	0.32	30.10	59.26	-29.16	QP	
2		0.3377	23.93	0.32	24.25	49.26	-25.01	AVG	
3		0.3611	33.44	0.34	33.78	58.70	-24.92	QP	
4		0.3611	26.78	0.34	27.12	48.70	-21.58	AVG	
5		0.3885	50.33	0.34	50.67	58.10	-7.43	QP	
6	*	0.3885	40.42	0.34	40.76	48.10	-7.34	AVG	
7		0.7776	37.49	0.32	37.81	56.00	-18.19	QP	
8		0.7776	28.05	0.32	28.37	46.00	-17.63	AVG	
9		1.5831	33.20	0.33	33.53	56.00	-22.47	QP	
10		1.5831	20.98	0.33	21.31	46.00	-24.69	AVG	
11		2.5058	35.10	0.34	35.44	56.00	-20.56	QP	
12		2.5058	25.14	0.34	25.48	46.00	-20.52	AVG	

\*:Maximum data x:Over limit !:over margin ●ReferenceOnly

Unless otherwise stated the results shown in this test report refer only to the sample(s) tested and such sample(s) are retained for 90 days only.  
 除非另有說明，此報告結果僅對測試之樣品負責，同時此樣品僅保留90天。本報告未經本公司書面許可，不可部份複製。

This document is issued by the Company subject to its General Conditions of Service printed overleaf, available on request or accessible at [www.sgs.com/terms\\_and\\_conditions.htm](http://www.sgs.com/terms_and_conditions.htm) and, for electronic format documents, subject to Terms and Conditions for Electronic Documents at [www.sgs.com/terms\\_e-document.htm](http://www.sgs.com/terms_e-document.htm). Attention is drawn to the limitation of liability, indemnification and jurisdiction issues defined therein. Any holder of this document is advised that information contained hereon reflects the Company's findings at the time of its intervention only and within the limits of Client's instructions, if any. The Company's sole responsibility is to its Client and this document does not exonerate parties to a transaction from exercising all their rights and obligations under the transaction documents. This document cannot be reproduced except in full, without prior written approval of the Company. Any unauthorized alteration, forgery or falsification of the content or appearance of this document is unlawful and offenders may be prosecuted to the fullest extent of the law.

Config 3 : FM 107.9

L



臺灣檢驗科技股份有限公司 -電子暨通訊實驗室  
 Address :台北縣五股工業區五工路 134 號  
 Tel:02-2299-3279 Fax:02-2298-2698

Conducted Emission Measurement

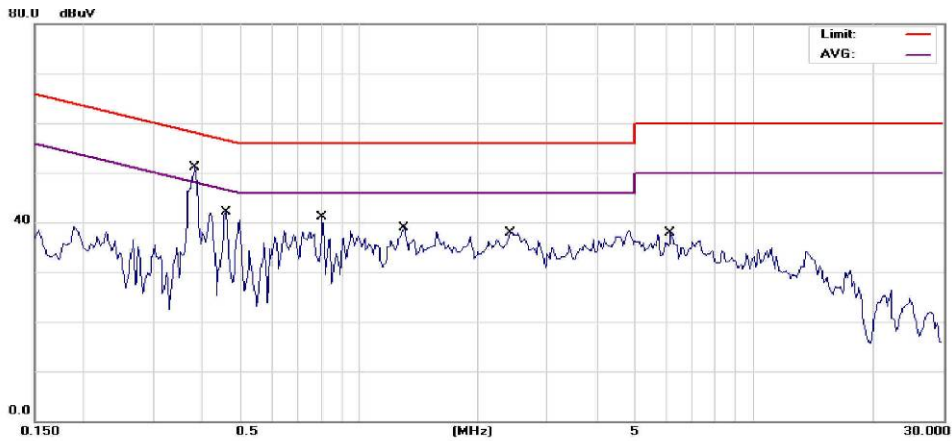

Site: ConductionRoom Phase: L1 Temperature: 26 °C  
 Limit: FCC Class B Conduction(QP) Power: AC 120V/60Hz Humidity: 60%  
 EUT: Tapioca Distance:  
 M/N:  
 Mode: FM107.9  
 Note:

No.	Mk.	Freq. MHz	Reading Level dBuV	Correct Factor dB	Measurement dBuV	Limit dBuV	Over dB	Detector	Comment
1		0.3846	47.66	0.22	47.88	58.18	-10.30	QP	
2	*	0.3846	40.77	0.22	40.99	48.18	-7.19	AVG	
3		0.4589	40.37	0.22	40.59	56.71	-16.12	QP	
4		0.4589	34.46	0.22	34.68	46.71	-12.03	AVG	
5		0.8050	34.29	0.22	34.51	56.00	-21.49	QP	
6		0.8050	27.62	0.22	27.84	46.00	-18.16	AVG	
7		1.3015	34.41	0.23	34.64	56.00	-21.36	QP	
8		1.3015	28.07	0.23	28.30	46.00	-17.70	AVG	
9		2.4120	31.87	0.26	32.13	56.00	-23.87	QP	
10		2.4120	24.23	0.26	24.49	46.00	-21.51	AVG	
11		6.1613	29.45	0.35	29.80	60.00	-30.20	QP	
12		6.1613	21.34	0.35	21.69	50.00	-28.31	AVG	

\*:Maximum data x:Over limit !:over margin

●Reference Only

Unless otherwise stated the results shown in this test report refer only to the sample(s) tested and such sample(s) are retained for 90 days only.  
 除非另有說明，此報告結果僅對測試之樣品負責，同時此樣品僅保留90天。本報告未經本公司書面許可，不可部份複製。

This document is issued by the Company subject to its General Conditions of Service printed overleaf, available on request or accessible at [www.sgs.com/terms\\_and\\_conditions.htm](http://www.sgs.com/terms_and_conditions.htm) and, for electronic format documents, subject to Terms and Conditions for Electronic Documents at [www.sgs.com/terms\\_e-document.htm](http://www.sgs.com/terms_e-document.htm). Attention is drawn to the limitation of liability, indemnification and jurisdiction issues defined therein. Any holder of this document is advised that information contained hereon reflects the Company's findings at the time of its intervention only and within the limits of Client's instructions, if any. The Company's sole responsibility is to its Client and this document does not exonerate parties to a transaction from exercising all their rights and obligations under the transaction documents. This document cannot be reproduced except in full, without prior written approval of the Company. Any unauthorized alteration, forgery or falsification of the content or appearance of this document is unlawful and offenders may be prosecuted to the fullest extent of the law.



N



臺灣檢驗科技股份有限公司 - 電子暨通訊實驗室  
 Address : 台北縣五股工業區五工路 134 號  
 Tel:02-2299-3279 Fax:02-2298-2698

Conducted Emission Measurement

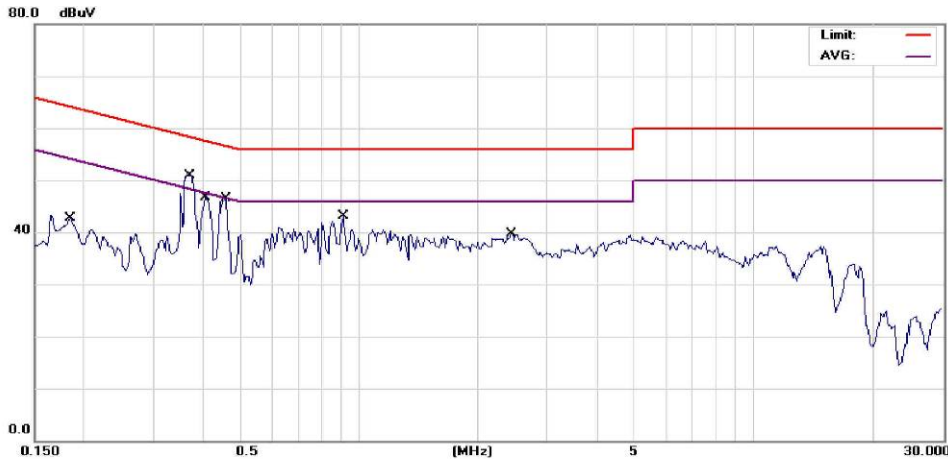

Site: ConductionRoom Phase: N Temperature: 26 °C  
 Limit: FCC Class B Conduction(QP) Power: AC 120V/60Hz Humidity: 60%  
 EUT: Tapioca Distance:  
 M/N:  
 Mode: FM107.9  
 Note:

No.	Mk.	Freq.	Reading Level	Correct Factor	Measurement	Limit	Over	Detector	Comment
		MHz	dBuV	dB	dBuV	dBuV	dB		
1		0.1852	34.51	0.32	34.83	64.25	-29.42	QP	
2		0.1852	25.65	0.32	25.97	54.25	-28.28	AVG	
3		0.3729	49.36	0.34	49.70	58.44	-8.74	QP	
4	*	0.3729	41.16	0.34	41.50	48.44	-6.94	AVG	
5		0.4139	42.99	0.34	43.33	57.57	-14.24	QP	
6		0.4139	37.03	0.34	37.37	47.57	-10.20	AVG	
7		0.4589	42.45	0.34	42.79	56.71	-13.92	QP	
8		0.4589	36.80	0.34	37.14	46.71	-9.57	AVG	
9		0.9105	38.45	0.31	38.76	56.00	-17.24	QP	
10		0.9105	30.99	0.31	31.30	46.00	-14.70	AVG	
11		2.4433	34.99	0.33	35.32	56.00	-20.68	QP	
12		2.4433	26.03	0.33	26.36	46.00	-19.64	AVG	

\*:Maximum data x:Over limit !:over margin ●ReferenceOnly

Unless otherwise stated the results shown in this test report refer only to the sample(s) tested and such sample(s) are retained for 90 days only.  
 除非另有說明，此報告結果僅對測試之樣品負責，同時此樣品僅保留90天。本報告未經本公司書面許可，不可部份複製。

This document is issued by the Company subject to its General Conditions of Service printed overleaf, available on request or accessible at [www.sgs.com/terms\\_and\\_conditions.htm](http://www.sgs.com/terms_and_conditions.htm) and, for electronic format documents, subject to Terms and Conditions for Electronic Documents at [www.sgs.com/terms\\_e-document.htm](http://www.sgs.com/terms_e-document.htm). Attention is drawn to the limitation of liability, indemnification and jurisdiction issues defined therein. Any holder of this document is advised that information contained hereon reflects the Company's findings at the time of its intervention only and within the limits of Client's instructions, if any. The Company's sole responsibility is to its Client and this document does not exonerate parties to a transaction from exercising all their rights and obligations under the transaction documents. This document cannot be reproduced except in full, without prior written approval of the Company. Any unauthorized alteration, forgery or falsification of the content or appearance of this document is unlawful and offenders may be prosecuted to the fullest extent of the law.

## 2.5 Test of Radiated Emission

### 2.5.1 Test Instruments

Below 1G & Above 1G

Description	Manufacturer	Model No.	Serial No.	Last Calibration Date	Next Calibration Date
Site NSA	Chamost	966II Chamber	N/A	Dec. 30, 2011	Dec. 29, 2012
Site VSWR	Chamost	966II Chamber	N/A	Dec. 30, 2011	Dec. 29, 2012
EMI Test Receiver	ROHDE&SCHWARZ	ESCI 7	1166.5950K07 -100760-GK	May 25, 2012	May 24, 2013
Spectrum Analyzer	Agilent	E4440A	MY45304525	Mar. 17, 2012	Mar. 16, 2014
RF-Amplifier (0.1-1300MHz)	HP	8447D	1937A02774	Nov. 26, 2011	Nov. 25, 2012
RF-Amplifier (1-26.5GHz)	HP	8449B	3008A00578	Dec. 27, 2011	Dec. 26, 2012
RF-Amplifier (26-40GHz)	EM Electronics Corp.	EM26400	N/A	Dec. 28, 2011	Dec. 27, 2012
Coaxial Cables (For 9kHz~26.5GHz)	SUCOFLEX	104PEA	N/A	Dec. 28, 2011	Dec. 27, 2012
Re Cables (966II) (For 1~40GHz)	HUBER SUHNER	SUCCOFLEX 102	22962/2	Dec. 28, 2011	Dec. 27, 2012
Re Cables (966II) (For 1~40GHz)	HUBER SUHNER	SUCCOFLEX 102	23051/2	Dec. 28, 2011	Dec. 27, 2012
Antenna Master	MF.	N/A	N/A	N/A	N/A
Turn Table	MF.	N/A	N/A	N/A	N/A
Controller	MF.	3000	MF780208153	N/A	N/A
Antenna	SCHWAZBECK	VULB9160	3068	Nov. 01, 2011	Oct. 31, 2012
Horn Antenna (For 1~18G )	ETS-Lindgren	3117	00135200	Oct. 06, 2011	Oct. 05, 2012
Horn Antenna (For 18~40G )	SCHWAZBECK	BBHA 9170	BBHA9170185	Jul. 11, 2011	Jul. 10, 2013
Software	Farad	EZ-EMC- VER2A1.1(USB)	N/A	N/A	N/A

Unless otherwise stated the results shown in this test report refer only to the sample(s) tested and such sample(s) are retained for 90 days only.  
除非另有說明，此報告結果僅對測試之樣品負責，同時此樣品僅保留90天。本報告未經本公司書面許可，不可部份複製。

This document is issued by the Company subject to its General Conditions of Service printed overleaf, available on request or accessible at [www.sgs.com/terms\\_and\\_conditions.htm](http://www.sgs.com/terms_and_conditions.htm) and, for electronic format documents, subject to Terms and Conditions for Electronic Documents at [www.sgs.com/terms\\_e-document.htm](http://www.sgs.com/terms_e-document.htm). Attention is drawn to the limitation of liability, indemnification and jurisdiction issues defined therein. Any holder of this document is advised that information contained hereon reflects the Company's findings at the time of its intervention only and within the limits of Client's instructions, if any. The Company's sole responsibility is to its Client and this document does not exonerate parties to a transaction from exercising all their rights and obligations under the transaction documents. This document cannot be reproduced except in full, without prior written approval of the Company. Any unauthorized alteration, forgery or falsification of the content or appearance of this document is unlawful and offenders may be prosecuted to the fullest extent of the law.

## 2.5.2 Test Site

SGS Taiwan LTD. Electronics & Communication Laboratory  
No.134, Wu Kung Road. Wuku Industrial Zone, Taipei County 248, Taiwan (R.O.C.)

## 2.5.3 Operating Environment

Temperature : 25 degree C                      Humidity : 60 %RH  
Atmospheric Pressure : 996 mBar

## 2.5.4 Uncertainty of Radiated Emission

Expanded uncertainty (k=2) of radiated emission measurement is 3.70dB.(Below 1G)

Expanded uncertainty (k=2) of radiated emission measurement is 5.63dB.(Above 1G)

## 2.5.5 Measurement level and Factor calculate method

Factor = Antenna loss + Cable loss + Amplifier Compensate

Measurement Level = Reading Level + Factor

Unless otherwise stated the results shown in this test report refer only to the sample(s) tested and such sample(s) are retained for 90 days only.  
除非另有說明，此報告結果僅對測試之樣品負責，同時此樣品僅保留90天。本報告未經本公司書面許可，不可部份複製。

This document is issued by the Company subject to its General Conditions of Service printed overleaf, available on request or accessible at [www.sgs.com/terms\\_and\\_conditions.htm](http://www.sgs.com/terms_and_conditions.htm) and, for electronic format documents, subject to Terms and Conditions for Electronic Documents at [www.sgs.com/terms\\_e-document.htm](http://www.sgs.com/terms_e-document.htm). Attention is drawn to the limitation of liability, indemnification and jurisdiction issues defined therein. Any holder of this document is advised that information contained hereon reflects the Company's findings at the time of its intervention only and within the limits of Client's instructions, if any. The Company's sole responsibility is to its Client and this document does not exonerate parties to a transaction from exercising all their rights and obligations under the transaction documents. This document cannot be reproduced except in full, without prior written approval of the Company. Any unauthorized alteration, forgery or falsification of the content or appearance of this document is unlawful and offenders may be prosecuted to the fullest extent of the law.

## 2.5.6 Measurement Data

Below 1G

Config 1 : Data Link

Adaptor: Salcomp

H

臺灣檢驗科技股份有限公司 - 電子暨通訊實驗室  
Address : 台北縣五股工業區五工路 134 號  
Tel:02-2299-3279 Fax:02-2298-2698

### Radiated Emission Measurement

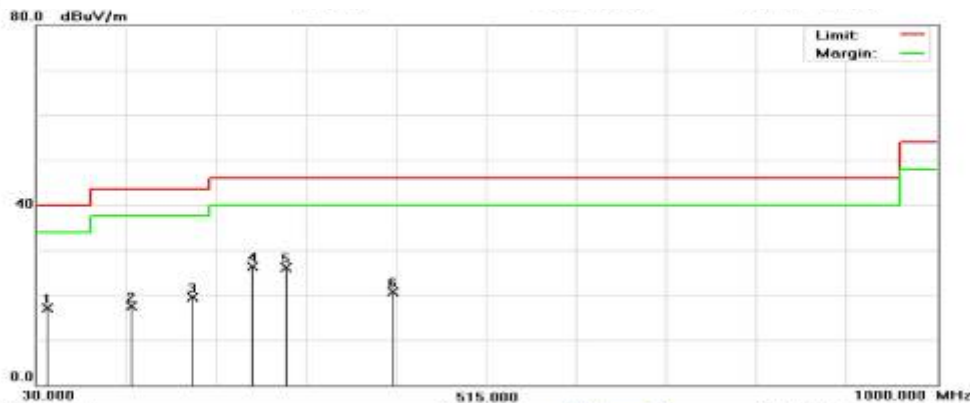

Site : 955 Chamber  
Limit: FCC Class B 3M Radiation  
EUT:  
MN:  
Mode: Config 1:EUT+Battery(LG)+USB Cable+ SHF Data Link  
Note:

Polarization: **Horizontal**  
Power: AC 120V/60Hz  
Distance: 3m

Temperature: 25 °C  
Humidity: 60%

No.	Mk.	Freq. MHz	Reading Level dBuV	Correct Factor dB	Measure- ment dBuV/m	Limit dBuV/m	Over dB	Detector	Comment
1		41.3000	33.40	-16.28	17.14	40.00	-22.86	QP	
2		131.2800	32.99	-15.49	17.50	43.50	-26.00	QP	
3		197.6500	35.84	-16.28	19.56	43.50	-23.94	QP	
4	*	262.4000	39.75	-13.48	26.28	46.00	-19.72	QP	
5		298.7300	38.44	-12.27	26.17	46.00	-19.83	QP	
6		412.3200	30.85	-10.13	20.72	46.00	-25.28	QP	

\*:Maximum data x:Over limit !:over margin

●ReferenceOnly

Printed with FinePrint - purchase at [www.fineprint.com](http://www.fineprint.com)

Unless otherwise stated the results shown in this test report refer only to the sample(s) tested and such sample(s) are retained for 90 days only.  
除非另有說明，此報告結果僅對測試之樣品負責，同時此樣品僅保留90天。本報告未經本公司書面許可，不可部份複製。

This document is issued by the Company subject to its General Conditions of Service printed overleaf, available on request or accessible at [www.sgs.com/terms\\_and\\_conditions.htm](http://www.sgs.com/terms_and_conditions.htm) and, for electronic format documents, subject to Terms and Conditions for Electronic Documents at [www.sgs.com/terms\\_e-document.htm](http://www.sgs.com/terms_e-document.htm). Attention is drawn to the limitation of liability, indemnification and jurisdiction issues defined therein. Any holder of this document is advised that information contained hereon reflects the Company's findings at the time of its intervention only and within the limits of Client's instructions, if any. The Company's sole responsibility is to its Client and this document does not exonerate parties to a transaction from exercising all their rights and obligations under the transaction documents. This document cannot be reproduced except in full, without prior written approval of the Company. Any unauthorized alteration, forgery or falsification of the content or appearance of this document is unlawful and offenders may be prosecuted to the fullest extent of the law.

V

臺灣檢驗科技股份有限公司 - 電子暨通訊實驗室  
 Address : 台北縣五股工業區五工路 134 號  
 Tel:02-2299-3279 Fax:02-2298-2698

**Radiated Emission Measurement**

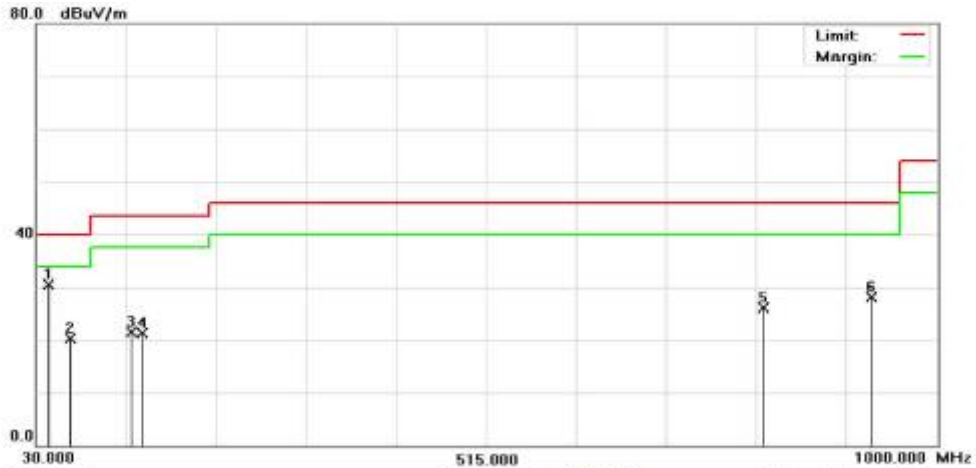

Site :966 Chamber      Polarization: **Vertical**      Temperature: 25 °C  
 Limit: FCC Class B 3M Radiation      Power: AC 120V/60Hz      Humidity: 80%  
 EUT:  
 M/N:  
 Mode: Config1 :EUT+Battery(LG)+USB Cable+ SHF Data Link  
 Note:

No.	Mk.	Freq.	Reading Level	Correct Factor	Measurement	Limit	Over	Detector	Comment
		MHz	dBuV	dB	dBuV/m	dBuV/m	dB		
1	*	43.5800	46.51	-16.04	30.47	40.00	-9.53	QP	
2		65.7400	37.68	-17.37	20.31	40.00	-19.69	QP	
3		132.3600	36.84	-15.40	21.44	43.50	-22.06	QP	
4		142.8400	35.92	-14.61	21.31	43.50	-22.19	QP	
5		812.7400	27.49	-1.31	26.18	46.00	-19.82	QP	
6		928.6700	27.81	0.39	28.20	46.00	-17.80	QP	

\*:Maximum data    x:Over limit    !:over margin      ●:ReferenceOnly

Printed with FinePrint - purchase at www.fineprint.com

Unless otherwise stated the results shown in this test report refer only to the sample(s) tested and such sample(s) are retained for 90 days only.  
 除非另有說明，此報告結果僅對測試之樣品負責，同時此樣品僅保留90天。本報告未經本公司書面許可，不可部份複製。

This document is issued by the Company subject to its General Conditions of Service printed overleaf, available on request or accessible at [www.sgs.com/terms\\_and\\_conditions.htm](http://www.sgs.com/terms_and_conditions.htm) and, for electronic format documents, subject to Terms and Conditions for Electronic Documents at [www.sgs.com/terms\\_e-document.htm](http://www.sgs.com/terms_e-document.htm). Attention is drawn to the limitation of liability, indemnification and jurisdiction issues defined therein. Any holder of this document is advised that information contained hereon reflects the Company's findings at the time of its intervention only and within the limits of Client's instructions, if any. The Company's sole responsibility is to its Client and this document does not exonerate parties to a transaction from exercising all their rights and obligations under the transaction documents. This document cannot be reproduced except in full, without prior written approval of the Company. Any unauthorized alteration, forgery or falsification of the content or appearance of this document is unlawful and offenders may be prosecuted to the fullest extent of the law.

Config 2 : Recording  
Adaptor: EMERSON

H

臺灣檢驗科技股份有限公司 - 電子電訊實驗室  
Address : 台北縣五股工業區五工路 134 號  
Tel:02-2299-3279 Fax:02-2298-2698

### Radiated Emission Measurement

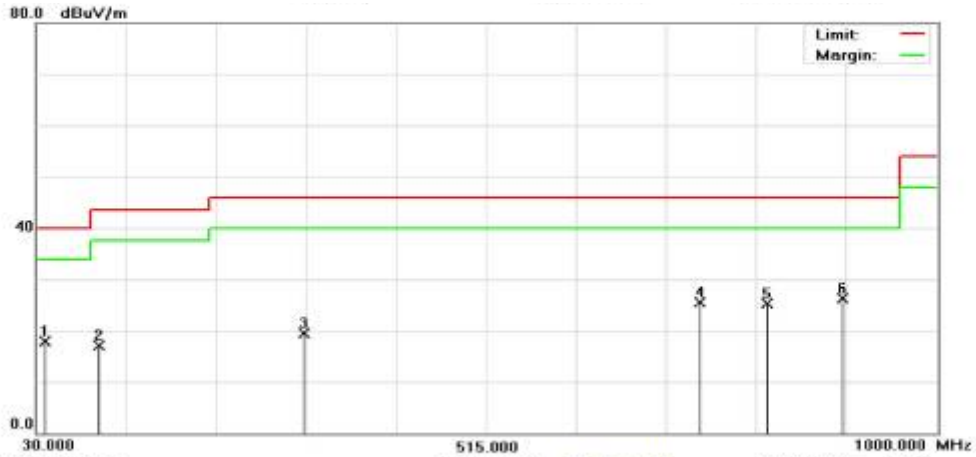

Site : 965 Chamber      Polarization: **Horizontal**      Temperature: 25 °C  
Limit: FCC Class B 3M Radiation      Power: AC 120V/60Hz      Humidity: 60%  
EUT:  
M/N:  
Mode: Config 2:EUT+Battery(LG)+Adapter(Sec EMERSON)+USB Cable+ SHF Recording  
Note:

No.	Mk.	Freq. MHz	Reading Level dBuV	Correct Factor dB	Measure- ment dBuV/m	Limit dBuV/m	Over dB	Detector	Comment
1		39.5200	34.25	-16.44	17.81	40.00	-22.19	QP	
2		96.1300	36.71	-19.67	17.04	43.50	-26.46	QP	
3		318.6400	31.46	-12.05	19.41	46.00	-26.59	QP	
4		745.2400	27.89	-2.45	25.44	46.00	-20.56	QP	
5		817.4900	26.43	-1.12	25.31	46.00	-20.69	QP	
6	*	898.6100	25.64	0.66	26.30	46.00	-19.70	QP	

\*:Maximum data    x:Over limit    !:over margin

●ReferenceOnly

Printed with FreePrint - purchase at [www.freeprint.com](http://www.freeprint.com)

Unless otherwise stated the results shown in this test report refer only to the sample(s) tested and such sample(s) are retained for 90 days only.  
除非另有說明，此報告結果僅對測試之樣品負責，同時此樣品僅保留90天。本報告未經本公司書面許可，不可部份複製。

This document is issued by the Company subject to its General Conditions of Service printed overleaf, available on request or accessible at [www.sgs.com/terms\\_and\\_conditions.htm](http://www.sgs.com/terms_and_conditions.htm) and, for electronic format documents, subject to Terms and Conditions for Electronic Documents at [www.sgs.com/terms\\_e-document.htm](http://www.sgs.com/terms_e-document.htm). Attention is drawn to the limitation of liability, indemnification and jurisdiction issues defined therein. Any holder of this document is advised that information contained hereon reflects the Company's findings at the time of its intervention only and within the limits of Client's instructions, if any. The Company's sole responsibility is to its Client and this document does not exonerate parties to a transaction from exercising all their rights and obligations under the transaction documents. This document cannot be reproduced except in full, without prior written approval of the Company. Any unauthorized alteration, forgery or falsification of the content or appearance of this document is unlawful and offenders may be prosecuted to the fullest extent of the law.

V

臺灣檢驗科技股份有限公司 - 電子電訊實驗室  
 Address : 台北縣五股工業區五工路 134 號  
 Tel:02-2299-3279 Fax:02-2298-2698

**Radiated Emission Measurement**

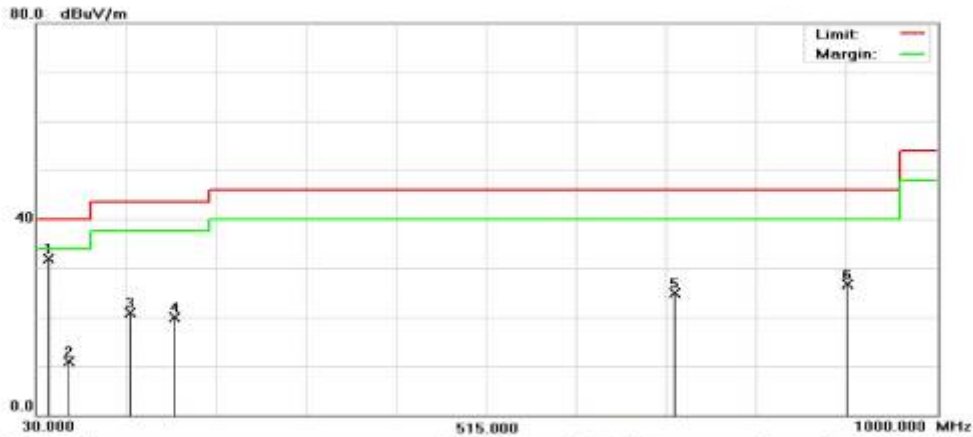

Site : 966 Chamber      Polarization: **Vertical**      Temperature: 25 °C  
 Limit: FCC Class B 3M Radiation      Power: AC 120V/60Hz      Humidity: 60%  
 EUT:      Distance: 3m  
 MN:  
 Mode: Config2 :EUT+Battery(LG)+Adapter(Sec EMERSON)+USB Cable+ SHF Recording  
 Note:

No.	Mk.	Freq. MHz	Reading Level dBuV	Correct Factor dB	Measure- ment dBuV/m	Limit dBuV/m	Over dB	Detector	Comment
1	*	42.1300	48.12	-16.18	31.94	40.00	-8.06	QP	
2		63.7500	27.84	-17.01	10.83	40.00	-29.17	QP	
3		129.5900	36.49	-15.62	20.87	43.50	-22.63	QP	
4		178.6200	34.81	-14.85	19.96	43.50	-23.54	QP	
5		717.3800	28.63	-3.72	24.91	46.00	-21.09	QP	
6		903.4100	25.95	0.73	26.68	46.00	-19.32	QP	

\*:Maximum data    x:Over limit    !:over margin

●ReferenceOnly

Printed with FreePrint - purchase at [www.freeprint.com](http://www.freeprint.com)

Unless otherwise stated the results shown in this test report refer only to the sample(s) tested and such sample(s) are retained for 90 days only.  
 除非另有說明，此報告結果僅對測試之樣品負責，同時此樣品僅保留90天。本報告未經本公司書面許可，不可部份複製。

This document is issued by the Company subject to its General Conditions of Service printed overleaf, available on request or accessible at [www.sgs.com/terms\\_and\\_conditions.htm](http://www.sgs.com/terms_and_conditions.htm) and, for electronic format documents, subject to Terms and Conditions for Electronic Documents at [www.sgs.com/terms\\_e-document.htm](http://www.sgs.com/terms_e-document.htm). Attention is drawn to the limitation of liability, indemnification and jurisdiction issues defined therein. Any holder of this document is advised that information contained hereon reflects the Company's findings at the time of its intervention only and within the limits of Client's instructions, if any. The Company's sole responsibility is to its Client and this document does not exonerate parties to a transaction from exercising all their rights and obligations under the transaction documents. This document cannot be reproduced except in full, without prior written approval of the Company. Any unauthorized alteration, forgery or falsification of the content or appearance of this document is unlawful and offenders may be prosecuted to the fullest extent of the law.

**Config 2 : Play Recording  
Adaptor: Salcomp  
H**

臺灣檢驗科技股份有限公司 - 電子暨通訊實驗室  
Address : 台北縣五股工業區五工路 134 號  
Tel:02-2299-3279 Fax:02-2298-2698

**Radiated Emission Measurement**

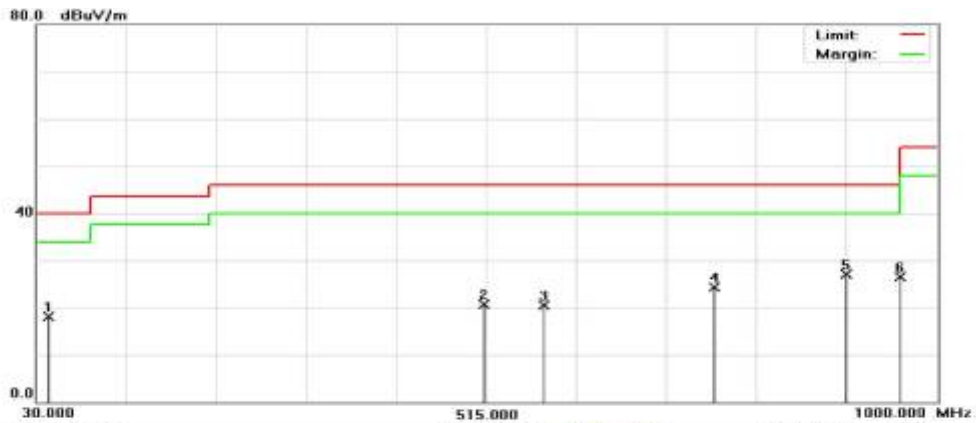

Site : 966 Chamber      Polarization: **Horizontal**      Temperature: 25 °C  
Limit: FCC Class B 3M Radiation      Power: AC 120V/60Hz      Humidity: 60%  
EUT:      Distance: 3m  
M/N:      Mode: Config2 :EUT+Battery(LG)+Adapter(Main Salcomp)+USB Cable+ SHF Play Recording  
Note:

No.	Mk.	Freq. MHz	Reading Level dBuV	Correct Factor dB	Measure- ment dBuV/m	Limit dBuV/m	Over dB	Detector	Comment
1		42.3100	34.21	-16.16	18.05	40.00	-21.95	QP	
2		511.4700	28.72	-7.97	20.75	46.00	-25.25	QP	
3		575.8900	26.89	-6.36	20.53	46.00	-25.47	QP	
4		760.1300	27.10	-2.75	24.35	46.00	-21.65	QP	
5	*	902.9700	26.43	0.74	27.17	46.00	-18.83	QP	
6		960.3600	25.57	1.02	26.59	54.00	-27.41	QP	

\*:Maximum data    x:Over limit    !:over margin

●ReferenceOnly

Printed with FreePrint - purchase at www.freeprint.com

Unless otherwise stated the results shown in this test report refer only to the sample(s) tested and such sample(s) are retained for 90 days only.  
除非另有說明，此報告結果僅對測試之樣品負責，同時此樣品僅保留90天。本報告未經本公司書面許可，不可部份複製。

This document is issued by the Company subject to its General Conditions of Service printed overleaf, available on request or accessible at [www.sgs.com/terms\\_and\\_conditions.htm](http://www.sgs.com/terms_and_conditions.htm) and, for electronic format documents, subject to Terms and Conditions for Electronic Documents at [www.sgs.com/terms\\_e-document.htm](http://www.sgs.com/terms_e-document.htm). Attention is drawn to the limitation of liability, indemnification and jurisdiction issues defined therein. Any holder of this document is advised that information contained hereon reflects the Company's findings at the time of its intervention only and within the limits of Client's instructions, if any. The Company's sole responsibility is to its Client and this document does not exonerate parties to a transaction from exercising all their rights and obligations under the transaction documents. This document cannot be reproduced except in full, without prior written approval of the Company. Any unauthorized alteration, forgery or falsification of the content or appearance of this document is unlawful and offenders may be prosecuted to the fullest extent of the law.



V

臺灣檢驗科技股份有限公司 - 電子暨通訊實驗室  
 Address : 台北縣五股工業區五工路 134 號  
 Tel:02-2299-3279 Fax:02-2298-2698

**Radiated Emission Measurement**

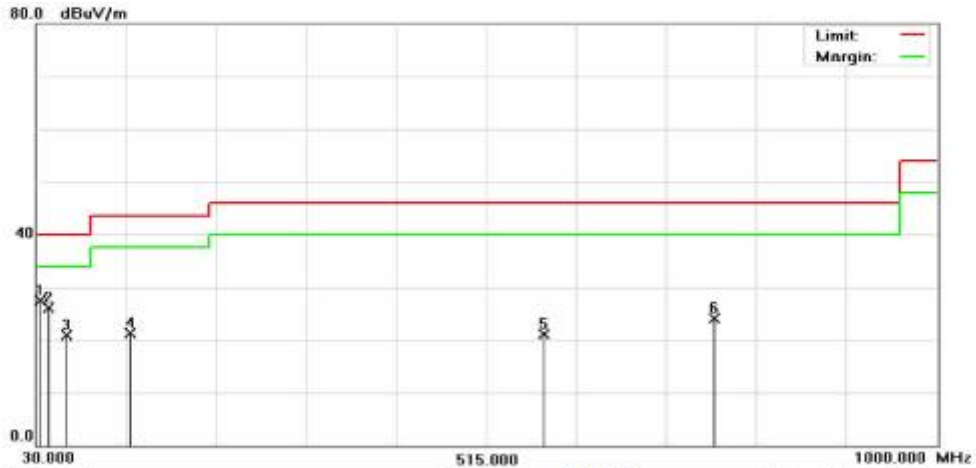

Site :966 Chamber Polarization: **Vertical** Temperature: 25 °C  
 Limit: FCC Class B 3M Radiation Power: AC 120V/60Hz Humidity: 80%  
 EUT: Distance: 3m  
 M/N:  
 Mode: Config 2:EUT+Battery(LG)+Adapter(Main Salcomp)+USB Cable+ SHF Play Recording  
 Note:

No.	Mk.	Freq. MHz	Reading Level dBuV	Correct Factor dB	Measure- ment dBuV/m	Limit dBuV/m	Over dB	Detector	Comment
1	*	33.6400	44.52	-17.08	27.44	40.00	-12.56	QP	
2		42.1800	42.19	-16.18	26.01	40.00	-13.99	QP	
3		62.5600	37.61	-16.80	20.81	40.00	-19.19	QP	
4		129.7800	36.83	-15.61	21.22	43.50	-22.28	QP	
5		576.4900	27.46	-8.33	21.13	46.00	-24.87	QP	
6		760.3800	26.85	-2.76	24.09	46.00	-21.91	QP	

\*:Maximum data x:Over limit l:over margin ●ReferenceOnly

Printed with FinePrint - purchase at www.fineprint.com

Unless otherwise stated the results shown in this test report refer only to the sample(s) tested and such sample(s) are retained for 90 days only.  
 除非另有說明，此報告結果僅對測試之樣品負責，同時此樣品僅保留90天。本報告未經本公司書面許可，不可部份複製。

This document is issued by the Company subject to its General Conditions of Service printed overleaf, available on request or accessible at [www.sgs.com/terms\\_and\\_conditions.htm](http://www.sgs.com/terms_and_conditions.htm) and, for electronic format documents, subject to Terms and Conditions for Electronic Documents at [www.sgs.com/terms\\_e-document.htm](http://www.sgs.com/terms_e-document.htm). Attention is drawn to the limitation of liability, indemnification and jurisdiction issues defined therein. Any holder of this document is advised that information contained hereon reflects the Company's findings at the time of its intervention only and within the limits of Client's instructions, if any. The Company's sole responsibility is to its Client and this document does not exonerate parties to a transaction from exercising all their rights and obligations under the transaction documents. This document cannot be reproduced except in full, without prior written approval of the Company. Any unauthorized alteration, forgery or falsification of the content or appearance of this document is unlawful and offenders may be prosecuted to the fullest extent of the law.

Config 3 : FM 87.6

H



臺灣檢驗科技股份有限公司 - 電子暨通訊實驗室  
 Address : 台北縣五股工業區五工路 134 號  
 Tel:02-2299-3279 Fax:02-2298-2698

Radiated Emission Measurement

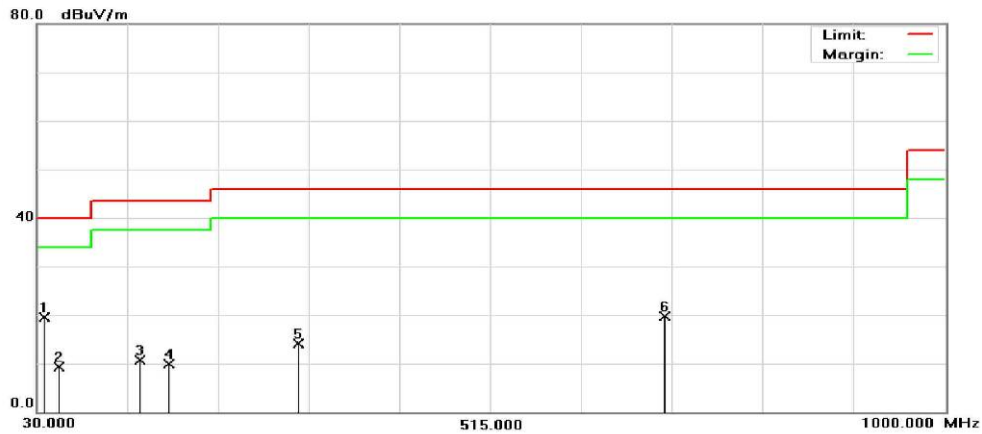

Site : 9\*6 Chamber  
 Limit: FCC Class B 3M Radiation  
 EUT: Tapioca  
 M/N:  
 Note: FM87.6

Polarization: **Horizontal**  
 Power: AC 120V/60Hz  
 Distance: 3m

Temperature: 25 °C  
 Humidity: 60%  
 Air Pressure: 1002hpa

No.	Mk.	Freq. MHz	Reading Level dBuV	Factor dB	Measure- ment dBuV/m	Limit dBuV/m	Over dB	Detector	Comment
1	*	36.7900	36.29	-16.79	19.50	40.00	-20.50	QP	
2		51.6400	25.14	-15.75	9.39	40.00	-30.61	QP	
3		138.7600	25.49	-14.87	10.62	43.50	-32.88	QP	
4		171.6200	24.20	-14.27	9.93	43.50	-33.57	QP	
5		308.0170	26.01	-11.91	14.10	46.00	-31.90	QP	
6		699.5400	23.76	-4.07	19.69	46.00	-26.31	QP	

\*:Maximum data x:Over limit !:over margin

●ReferenceOnly

Unless otherwise stated the results shown in this test report refer only to the sample(s) tested and such sample(s) are retained for 90 days only.  
 除非另有說明，此報告結果僅對測試之樣品負責，同時此樣品僅保留90天。本報告未經本公司書面許可，不可部份複製。

This document is issued by the Company subject to its General Conditions of Service printed overleaf, available on request or accessible at [www.sgs.com/terms\\_and\\_conditions.htm](http://www.sgs.com/terms_and_conditions.htm) and, for electronic format documents, subject to Terms and Conditions for Electronic Documents at [www.sgs.com/terms\\_e-document.htm](http://www.sgs.com/terms_e-document.htm). Attention is drawn to the limitation of liability, indemnification and jurisdiction issues defined therein. Any holder of this document is advised that information contained hereon reflects the Company's findings at the time of its intervention only and within the limits of Client's instructions, if any. The Company's sole responsibility is to its Client and this document does not exonerate parties to a transaction from exercising all their rights and obligations under the transaction documents. This document cannot be reproduced except in full, without prior written approval of the Company. Any unauthorized alteration, forgery or falsification of the content or appearance of this document is unlawful and offenders may be prosecuted to the fullest extent of the law.

V



臺灣檢驗科技股份有限公司 - 電子暨通訊實驗室  
 Address : 台北縣五股工業區五工路 134 號  
 Tel:02-2299-3279 Fax:02-2298-2698

**Radiated Emission Measurement**

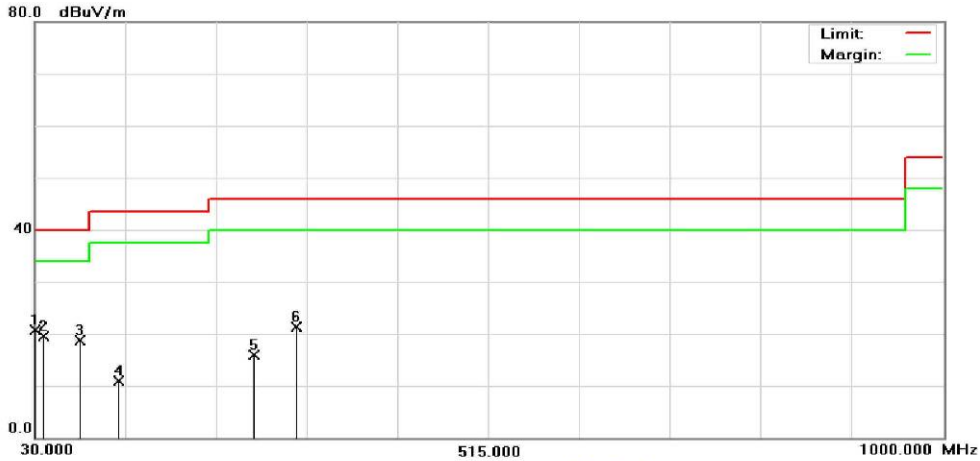

Site : 9\*6\*6 Chamber      Polarization: **Vertical**      Temperature: 25 °C  
 Limit: FCC Class B 3M Radiation      Power: AC 120V/60Hz      Humidity: 60%  
 EUT: Tapioca      Distance: 3m      Air Pressure: 1002hpa  
 M/N:  
 Note: FM87.6

No.	Mk.	Freq. MHz	Reading Level dBuV	Factor dB	Measure- ment dBuV/m	Limit dBuV/m	Over dB	Detector	Comment
1	*	30.5840	37.90	-17.22	20.68	40.00	-19.32	QP	
2		38.1400	36.11	-16.61	19.50	40.00	-20.50	QP	
3		77.8200	38.40	-19.69	18.71	40.00	-21.29	QP	
4		117.4200	27.54	-16.61	10.93	43.50	-32.57	QP	
5		262.8720	29.42	-13.46	15.96	46.00	-30.04	QP	
6		308.0010	33.17	-11.91	21.26	46.00	-24.74	QP	

\*:Maximum data    x:Over limit    !:over margin

●ReferenceOnly

Unless otherwise stated the results shown in this test report refer only to the sample(s) tested and such sample(s) are retained for 90 days only.  
 除非另有說明，此報告結果僅對測試之樣品負責，同時此樣品僅保留90天。本報告未經本公司書面許可，不可部份複製。

This document is issued by the Company subject to its General Conditions of Service printed overleaf, available on request or accessible at [www.sgs.com/terms\\_and\\_conditions.htm](http://www.sgs.com/terms_and_conditions.htm) and, for electronic format documents, subject to Terms and Conditions for Electronic Documents at [www.sgs.com/terms\\_e-document.htm](http://www.sgs.com/terms_e-document.htm). Attention is drawn to the limitation of liability, indemnification and jurisdiction issues defined therein. Any holder of this document is advised that information contained hereon reflects the Company's findings at the time of its intervention only and within the limits of Client's instructions, if any. The Company's sole responsibility is to its Client and this document does not exonerate parties to a transaction from exercising all their rights and obligations under the transaction documents. This document cannot be reproduced except in full, without prior written approval of the Company. Any unauthorized alteration, forgery or falsification of the content or appearance of this document is unlawful and offenders may be prosecuted to the fullest extent of the law.

Config 3 : FM 98

H



臺灣檢驗科技股份有限公司 -電子聾通訊實驗室  
 Address :台北縣五股工業區五工路 134 號  
 Tel:02-2299-3279 Fax:02-2298-2698

Radiated Emission Measurement

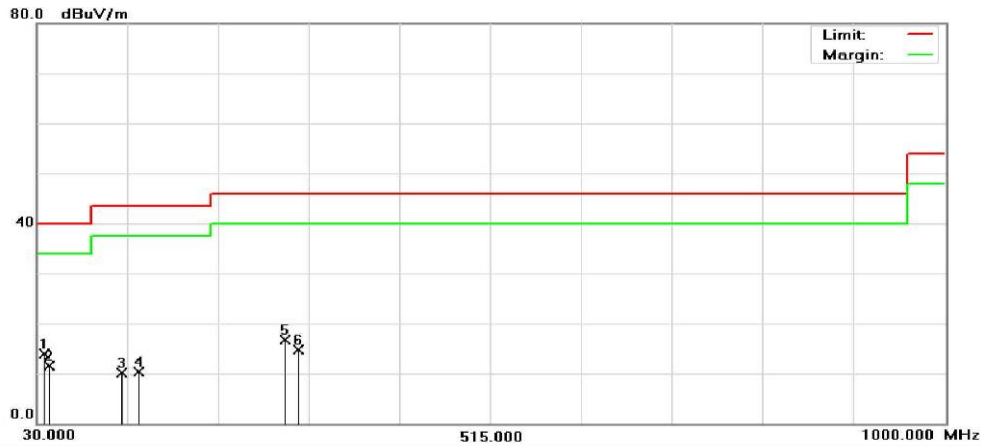

Site : 9\*6\*6 Chamber      Polarization: **Horizontal**      Temperature: 25 °C  
 Limit: FCC Class B 3M Radiation      Power: AC 120V/60Hz      Humidity: 60%  
 EUT: Tapioca      Distance: 3m      Air Pressure: 1002hpa  
 M/N:  
 Note: FM98

No.	Mk.	Freq. MHz	Reading Level dBuV	Factor dB	Measure- ment dBuV/m	Limit dBuV/m	Over dB	Detector	Comment
1	*	36.8600	30.78	-16.78	14.00	40.00	-26.00	QP	
2		43.3200	27.48	-16.07	11.41	40.00	-28.59	QP	
3		120.9400	26.40	-16.31	10.09	43.50	-33.41	QP	
4		138.1200	25.30	-14.92	10.38	43.50	-33.12	QP	
5		294.1660	29.19	-12.39	16.80	46.00	-29.20	QP	
6		308.0000	26.61	-11.91	14.70	46.00	-31.30	QP	

\*:Maximum data    x:Over limit    !:over margin      ●ReferenceOnly

Unless otherwise stated the results shown in this test report refer only to the sample(s) tested and such sample(s) are retained for 90 days only.  
 除非另有說明，此報告結果僅對測試之樣品負責，同時此樣品僅保留90天。本報告未經本公司書面許可，不可部份複製。

This document is issued by the Company subject to its General Conditions of Service printed overleaf, available on request or accessible at [www.sgs.com/terms\\_and\\_conditions.htm](http://www.sgs.com/terms_and_conditions.htm) and, for electronic format documents, subject to Terms and Conditions for Electronic Documents at [www.sgs.com/terms\\_e-document.htm](http://www.sgs.com/terms_e-document.htm). Attention is drawn to the limitation of liability, indemnification and jurisdiction issues defined therein. Any holder of this document is advised that information contained hereon reflects the Company's findings at the time of its intervention only and within the limits of Client's instructions, if any. The Company's sole responsibility is to its Client and this document does not exonerate parties to a transaction from exercising all their rights and obligations under the transaction documents. This document cannot be reproduced except in full, without prior written approval of the Company. Any unauthorized alteration, forgery or falsification of the content or appearance of this document is unlawful and offenders may be prosecuted to the fullest extent of the law.

V



臺灣檢驗科技股份有限公司-電子暨通訊實驗室  
Address : 台北縣五股工業區五工路 134 號  
Tel:02-2299-3279 Fax:02-2298-2698

**Radiated Emission Measurement**

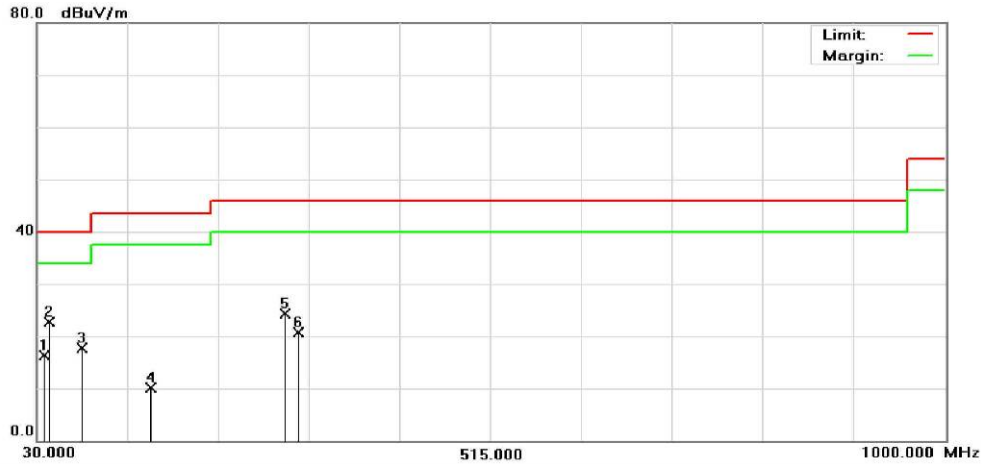

Site : 9\*6\*6 Chamber  
Limit: FCC Class B 3M Radiation  
EUT: Tapioca  
M/N:  
Note: FM98

Polarization: **Vertical**  
Power: AC 120V/60Hz  
Distance: 3m

Temperature: 25 °C  
Humidity: 60%  
Air Pressure: 1002hpa

No.	Mk.	Freq. MHz	Reading Level dBuV	Factor dB	Measure- ment dBuV/m	Limit dBuV/m	Over dB	Detector	Comment
1		35.9040	33.12	-16.90	16.22	40.00	-23.78	QP	
2	*	42.9980	38.71	-16.10	22.61	40.00	-17.39	QP	
3		78.2200	37.50	-19.77	17.73	40.00	-22.27	QP	
4		151.5000	24.25	-14.22	10.03	43.50	-33.47	QP	
5		294.1460	36.62	-12.39	24.23	46.00	-21.77	QP	
6		308.0070	32.54	-11.91	20.63	46.00	-25.37	QP	

\*:Maximum data    x:Over limit    !:over margin    ●Reference Only

Unless otherwise stated the results shown in this test report refer only to the sample(s) tested and such sample(s) are retained for 90 days only.  
除非另有說明，此報告結果僅對測試之樣品負責，同時此樣品僅保留90天。本報告未經本公司書面許可，不可部份複製。

This document is issued by the Company subject to its General Conditions of Service printed overleaf, available on request or accessible at [www.sgs.com/terms\\_and\\_conditions.htm](http://www.sgs.com/terms_and_conditions.htm) and, for electronic format documents, subject to Terms and Conditions for Electronic Documents at [www.sgs.com/terms\\_e-document.htm](http://www.sgs.com/terms_e-document.htm). Attention is drawn to the limitation of liability, indemnification and jurisdiction issues defined therein. Any holder of this document is advised that information contained hereon reflects the Company's findings at the time of its intervention only and within the limits of Client's instructions, if any. The Company's sole responsibility is to its Client and this document does not exonerate parties to a transaction from exercising all their rights and obligations under the transaction documents. This document cannot be reproduced except in full, without prior written approval of the Company. Any unauthorized alteration, forgery or falsification of the content or appearance of this document is unlawful and offenders may be prosecuted to the fullest extent of the law.

Config 3 : FM 107.9

H



臺灣檢驗科技股份有限公司 - 電子暨通訊實驗室  
 Address : 台北縣五股工業區五工路 134 號  
 Tel:02-2299-3279 Fax:02-2298-2698

Radiated Emission Measurement

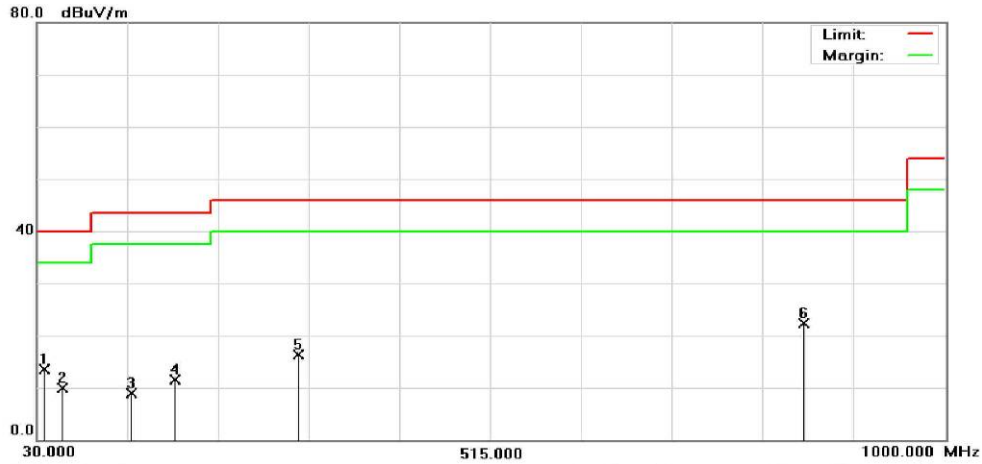

Site : 9\*6\*6 Chamber  
 Limit: FCC Class B 3M Radiation  
 EUT: Tapioca  
 M/N:  
 Note: FM107.9

Polarization: **Horizontal**  
 Power: AC 120V/60Hz  
 Distance: 3m

Temperature: 25 °C  
 Humidity: 60%  
 Air Pressure: 1002hpa

No.	Mk.	Freq. MHz	Reading Level dBuV	Factor dB	Measure- ment dBuV/m	Limit dBuV/m	Over dB	Detector	Comment
1		36.8100	30.20	-16.78	13.42	40.00	-26.58	QP	
2		56.0000	25.99	-16.06	9.93	40.00	-30.07	QP	
3		130.5400	24.46	-15.55	8.91	43.50	-34.59	QP	
4		176.6400	26.11	-14.68	11.43	43.50	-32.07	QP	
5		307.9980	28.20	-11.91	16.29	46.00	-29.71	QP	
6	*	849.2200	23.76	-1.53	22.23	46.00	-23.77	QP	

\*:Maximum data x:Over limit !:over margin

●ReferenceOnly

Unless otherwise stated the results shown in this test report refer only to the sample(s) tested and such sample(s) are retained for 90 days only.  
 除非另有說明，此報告結果僅對測試之樣品負責，同時此樣品僅保留90天。本報告未經本公司書面許可，不可部份複製。

This document is issued by the Company subject to its General Conditions of Service printed overleaf, available on request or accessible at [www.sgs.com/terms\\_and\\_conditions.htm](http://www.sgs.com/terms_and_conditions.htm) and, for electronic format documents, subject to Terms and Conditions for Electronic Documents at [www.sgs.com/terms\\_e-document.htm](http://www.sgs.com/terms_e-document.htm). Attention is drawn to the limitation of liability, indemnification and jurisdiction issues defined therein. Any holder of this document is advised that information contained hereon reflects the Company's findings at the time of its intervention only and within the limits of Client's instructions, if any. The Company's sole responsibility is to its Client and this document does not exonerate parties to a transaction from exercising all their rights and obligations under the transaction documents. This document cannot be reproduced except in full, without prior written approval of the Company. Any unauthorized alteration, forgery or falsification of the content or appearance of this document is unlawful and offenders may be prosecuted to the fullest extent of the law.

**Radiated Emission Measurement**

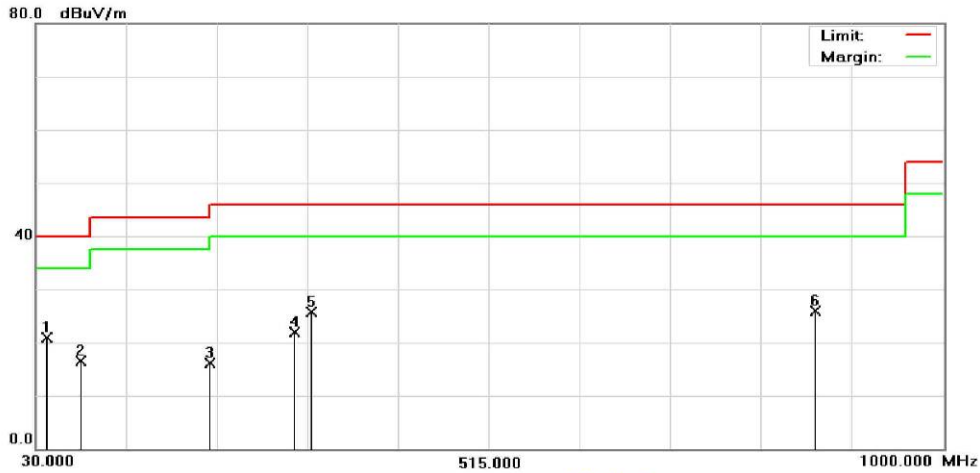

Site : 9\*6\*6 Chamber      Polarization: **Vertical**      Temperature: 25 °C  
 Limit: FCC Class B 3M Radiation      Power: AC 120V/60Hz      Humidity: 60%  
 EUT: Tapioca      Distance: 3m      Air Pressure: 1002hpa  
 M/N:  
 Note: FM107.9

No.	Mk.	Freq. MHz	Reading Level dBuV	Factor dB	Measure- ment dBuV/m	Limit dBuV/m	Over dB	Detector	Comment
1	*	41.3400	37.24	-16.26	20.98	40.00	-19.02	QP	
2		78.4000	36.22	-19.81	16.41	40.00	-23.59	QP	
3		215.8960	31.58	-15.48	16.10	43.50	-27.40	QP	
4		307.4200	33.92	-11.93	21.99	46.00	-24.01	QP	
5		323.8620	37.60	-11.96	25.64	46.00	-20.36	QP	
6		863.4800	27.07	-1.11	25.96	46.00	-20.04	QP	

\*:Maximum data    x:Over limit    !:over margin

●Reference Only

Unless otherwise stated the results shown in this test report refer only to the sample(s) tested and such sample(s) are retained for 90 days only.  
 除非另有說明，此報告結果僅對測試之樣品負責，同時此樣品僅保留90天。本報告未經本公司書面許可，不可部份複製。

This document is issued by the Company subject to its General Conditions of Service printed overleaf, available on request or accessible at [www.sgs.com/terms\\_and\\_conditions.htm](http://www.sgs.com/terms_and_conditions.htm) and, for electronic format documents, subject to Terms and Conditions for Electronic Documents at [www.sgs.com/terms\\_e-document.htm](http://www.sgs.com/terms_e-document.htm). Attention is drawn to the limitation of liability, indemnification and jurisdiction issues defined therein. Any holder of this document is advised that information contained hereon reflects the Company's findings at the time of its intervention only and within the limits of Client's instructions, if any. The Company's sole responsibility is to its Client and this document does not exonerate parties to a transaction from exercising all their rights and obligations under the transaction documents. This document cannot be reproduced except in full, without prior written approval of the Company. Any unauthorized alteration, forgery or falsification of the content or appearance of this document is unlawful and offenders may be prosecuted to the fullest extent of the law.

Above 1G

Config 1 : Data Link  
Adaptor: Salcomp

H

臺灣檢驗科技股份有限公司 - 電子電訊實驗室  
Address : 台北縣五股工業區五工路 134 號  
Tel:02-2299-3279 Fax:02-2298-2698

**Radiated Emission Measurement**

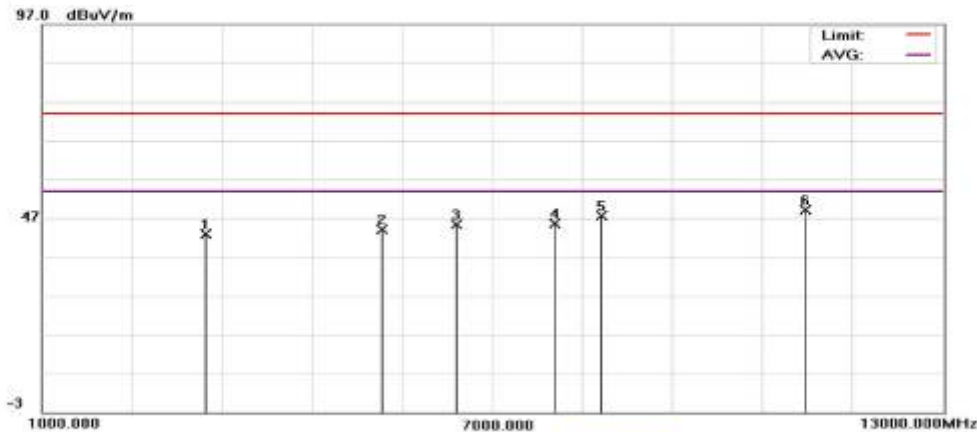

Site : 966 Chamber  
Limit: FCC Class B 3M Radiation(1G-40G)(Pea  
EUT:  
M/N:  
Mode: Config 1:EUT+Battery(LG)+USB Cable+ SHF Data Link  
Note:

Polarization: **Horizontal**  
Power: AC 120V/50Hz  
Distance: 3m  
Temperature: 25 °C  
Humidity: 60%

No.	Mk.	Freq. MHz	Reading Level dBuV	Correct Factor dB	Measurement dBuV/m	Limit dBuV/m	Over dB	Detector	Comment
1		3184.000	39.35	3.64	42.99	74.00	-31.01	peak	
2		5536.000	36.68	7.52	44.20	74.00	-29.80	peak	
3		6520.000	36.31	8.97	45.28	74.00	-28.72	peak	
4		7840.000	35.62	10.09	45.71	74.00	-28.29	peak	
5		8464.000	36.86	10.70	47.56	74.00	-26.44	peak	
6	*	11176.00	33.18	15.99	49.17	74.00	-24.83	peak	

\*:Maximum data x:Over limit l:over margin ●ReferenceOnly

Printed with FreePrint - purchase at www.freeprint.com

Unless otherwise stated the results shown in this test report refer only to the sample(s) tested and such sample(s) are retained for 90 days only.  
除非另有說明，此報告結果僅對測試之樣品負責，同時此樣品僅保留90天。本報告未經本公司書面許可，不可部份複製。

This document is issued by the Company subject to its General Conditions of Service printed overleaf, available on request or accessible at [www.sgs.com/terms\\_and\\_conditions.htm](http://www.sgs.com/terms_and_conditions.htm) and, for electronic format documents, subject to Terms and Conditions for Electronic Documents at [www.sgs.com/terms\\_e-document.htm](http://www.sgs.com/terms_e-document.htm). Attention is drawn to the limitation of liability, indemnification and jurisdiction issues defined therein. Any holder of this document is advised that information contained hereon reflects the Company's findings at the time of its intervention only and within the limits of Client's instructions, if any. The Company's sole responsibility is to its Client and this document does not exonerate parties to a transaction from exercising all their rights and obligations under the transaction documents. This document cannot be reproduced except in full, without prior written approval of the Company. Any unauthorized alteration, forgery or falsification of the content or appearance of this document is unlawful and offenders may be prosecuted to the fullest extent of the law.



V

臺灣檢驗科技股份有限公司 - 電子暨通訊實驗室  
 Address : 台北縣五股工業區五工路 134 號  
 Tel:02-2299-3279 Fax:02-2298-2698

**Radiated Emission Measurement**

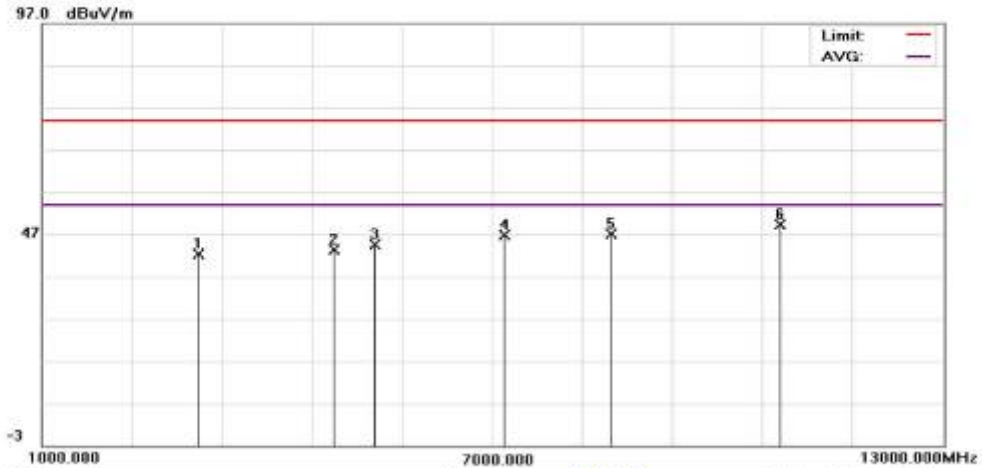

Site :966 Chamber Polarization: **Vertical** Temperature: 25 °C  
 Limit: FCC Class B 3M Radiation(1G-40G)(Pea Power: AC 120V/60Hz Humidity: 80%  
 EUT: Distance: 3m  
 M/N:  
 Mode: Config 1 :EUT+Battery(LG)+USB Cable+ SHF Data Link  
 Note:

No.	Mk.	Freq.	Reading Level	Correct Factor	Measurement	Limit	Over	Detector	Comment
		Mhz	dBuV	dB	dBuV/m	dBuV/m	dB		
1		3088.000	38.81	3.48	42.29	74.00	-31.71	peak	
2		4888.000	36.71	6.61	43.32	74.00	-30.68	peak	
3		5440.000	37.35	7.38	44.73	74.00	-29.27	peak	
4		7168.000	37.56	9.39	46.95	74.00	-27.05	peak	
5		8584.000	36.27	10.87	47.14	74.00	-26.86	peak	
6	*	10840.000	33.77	15.53	49.30	74.00	-24.70	peak	

\*:Maximum data x:Over limit l:over margin ●ReferenceOnly

Printed with FinePrint - purchase at www.fineprint.com

Unless otherwise stated the results shown in this test report refer only to the sample(s) tested and such sample(s) are retained for 90 days only.  
 除非另有說明，此報告結果僅對測試之樣品負責，同時此樣品僅保留90天。本報告未經本公司書面許可，不可部份複製。

This document is issued by the Company subject to its General Conditions of Service printed overleaf, available on request or accessible at [www.sgs.com/terms\\_and\\_conditions.htm](http://www.sgs.com/terms_and_conditions.htm) and, for electronic format documents, subject to Terms and Conditions for Electronic Documents at [www.sgs.com/terms\\_e-document.htm](http://www.sgs.com/terms_e-document.htm). Attention is drawn to the limitation of liability, indemnification and jurisdiction issues defined therein. Any holder of this document is advised that information contained hereon reflects the Company's findings at the time of its intervention only and within the limits of Client's instructions, if any. The Company's sole responsibility is to its Client and this document does not exonerate parties to a transaction from exercising all their rights and obligations under the transaction documents. This document cannot be reproduced except in full, without prior written approval of the Company. Any unauthorized alteration, forgery or falsification of the content or appearance of this document is unlawful and offenders may be prosecuted to the fullest extent of the law.

Config 2 : Recording  
Adaptor: EMERSON

H

臺灣檢驗科技股份有限公司 - 電子暨通訊實驗室  
Address : 台北縣五股工業區五工路 134 號  
Tel:02-2299-3279 Fax:02-2298-2698

### Radiated Emission Measurement

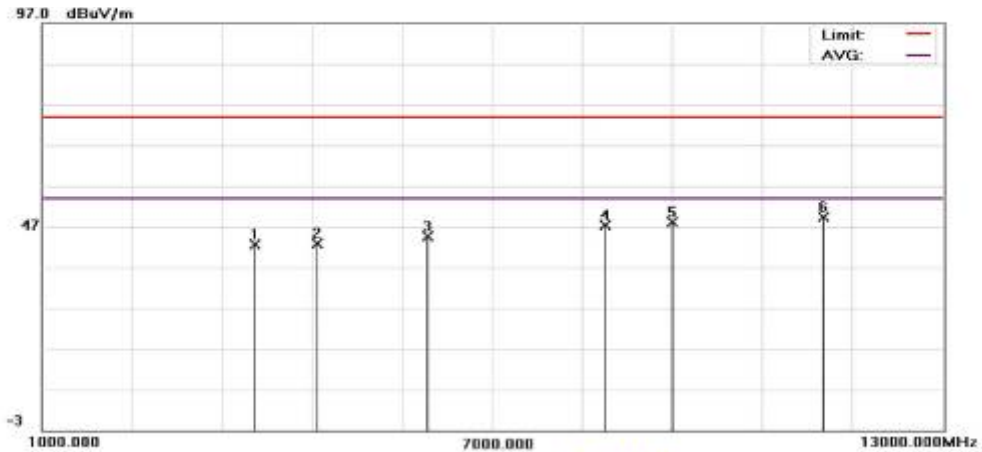

Site : 966 Chamber  
Limit: FCC Class B 3M Radiation(1G-40G)(Pea  
EUT:  
M/N:  
Mode: Config2 :EUT+Battery(LG)+Adapter(Sec EMERSON)+USB Cable+ SHF Recording  
Note:

Polarization: **Horizontal**  
Power: AC 120V/60Hz  
Distance: 3m  
Temperature: 25 °C  
Humidity: 60%

No.	Mk.	Freq. MHz	Reading Level dBuV	Correct Factor dB	Measure- ment dBuV/m	Limit dBuV/m	Over dB	Detector	Comment
1		3832.000	37.72	4.89	42.61	74.00	-31.39	peak	
2		4672.000	36.56	6.32	42.88	74.00	-31.12	peak	
3		6136.000	35.88	8.63	44.51	74.00	-29.49	peak	
4		8512.000	36.57	10.76	47.33	74.00	-26.67	peak	
5		9400.000	36.15	12.08	48.23	74.00	-25.77	peak	
6	*	11416.00	33.17	16.29	49.46	74.00	-24.54	peak	

\*:Maximum data x:Over limit !:over margin

●ReferenceOnly

Printed with FreePrint - purchase at www.FreePrint.com

Unless otherwise stated the results shown in this test report refer only to the sample(s) tested and such sample(s) are retained for 90 days only.  
除非另有說明，此報告結果僅對測試之樣品負責，同時此樣品僅保留90天。本報告未經本公司書面許可，不可部份複製。

This document is issued by the Company subject to its General Conditions of Service printed overleaf, available on request or accessible at [www.sgs.com/terms\\_and\\_conditions.htm](http://www.sgs.com/terms_and_conditions.htm) and, for electronic format documents, subject to Terms and Conditions for Electronic Documents at [www.sgs.com/terms\\_e-document.htm](http://www.sgs.com/terms_e-document.htm). Attention is drawn to the limitation of liability, indemnification and jurisdiction issues defined therein. Any holder of this document is advised that information contained hereon reflects the Company's findings at the time of its intervention only and within the limits of Client's instructions, if any. The Company's sole responsibility is to its Client and this document does not exonerate parties to a transaction from exercising all their rights and obligations under the transaction documents. This document cannot be reproduced except in full, without prior written approval of the Company. Any unauthorized alteration, forgery or falsification of the content or appearance of this document is unlawful and offenders may be prosecuted to the fullest extent of the law.

臺灣檢驗科技股份有限公司 - 電子暨通訊實驗室  
 Address : 台北縣五股工業區五工路 134 號  
 Tel:02-2299-3279 Fax:02-2298-2698

**Radiated Emission Measurement**

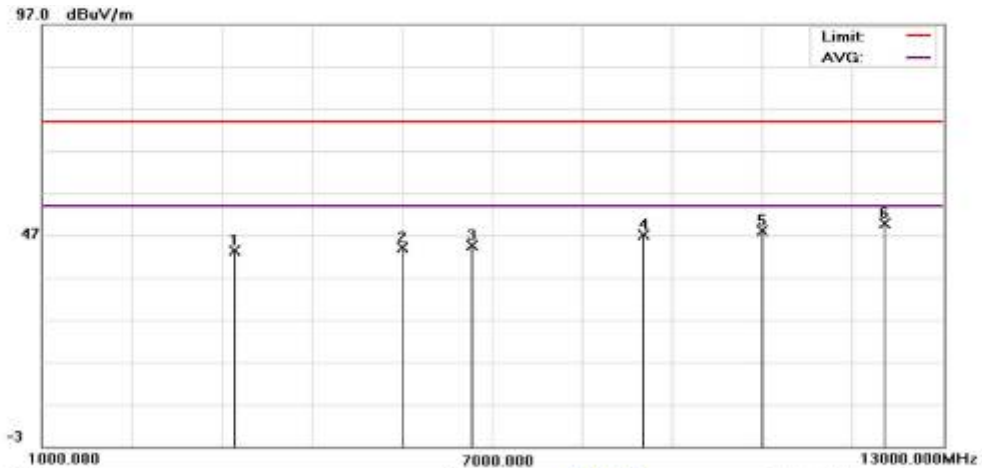

Site :966 Chamber Polarization: **Vertical** Temperature: 25 ℃  
 Limit: FCC Class B 3M Radiation(1G-40G)(Pea Power: AC 120V/60Hz Humidity: 60%  
 EUT: Distance: 3m  
 MN:  
 Mode: Config2 :EUT+Battery(LG)+Adapter(Sec EMERSON)+USB Cable+ SHF Recording  
 Note:

No.	Mk.	Freq. MHz	Reading Level dBuV	Correct Factor dB	Measurement dBuV/m	Limit dBuV/m	Over dB	Detector	Comment
1		3568.000	38.90	4.38	43.28	74.00	-30.72	peak	
2		5800.000	36.12	7.94	44.06	74.00	-29.94	peak	
3		6736.000	35.53	9.09	44.62	74.00	-29.38	peak	
4		9016.000	35.76	11.47	47.23	74.00	-26.77	peak	
5		10600.00	33.13	15.09	48.22	74.00	-25.78	peak	
6	*	12232.00	32.16	17.73	49.89	74.00	-24.11	peak	

\*:Maximum data x:Over limit !:over margin

●ReferenceOnly

Printed with FreePrint - purchase at www.FreePrint.com

Unless otherwise stated the results shown in this test report refer only to the sample(s) tested and such sample(s) are retained for 90 days only.  
 除非另有說明，此報告結果僅對測試之樣品負責，同時此樣品僅保留90天。本報告未經本公司書面許可，不可部份複製。

This document is issued by the Company subject to its General Conditions of Service printed overleaf, available on request or accessible at [www.sgs.com/terms\\_and\\_conditions.htm](http://www.sgs.com/terms_and_conditions.htm) and, for electronic format documents, subject to Terms and Conditions for Electronic Documents at [www.sgs.com/terms\\_e-document.htm](http://www.sgs.com/terms_e-document.htm). Attention is drawn to the limitation of liability, indemnification and jurisdiction issues defined therein. Any holder of this document is advised that information contained hereon reflects the Company's findings at the time of its intervention only and within the limits of Client's instructions, if any. The Company's sole responsibility is to its Client and this document does not exonerate parties to a transaction from exercising all their rights and obligations under the transaction documents. This document cannot be reproduced except in full, without prior written approval of the Company. Any unauthorized alteration, forgery or falsification of the content or appearance of this document is unlawful and offenders may be prosecuted to the fullest extent of the law.

**Config 2 : Play Recording  
Adaptor: Salcomp  
H**

臺灣檢驗科技股份有限公司 - 電子電訊實驗室  
Address : 台北縣五股工業區五工路 134 號  
Tel:02-2299-3279 Fax:02-2298-2698

**Radiated Emission Measurement**

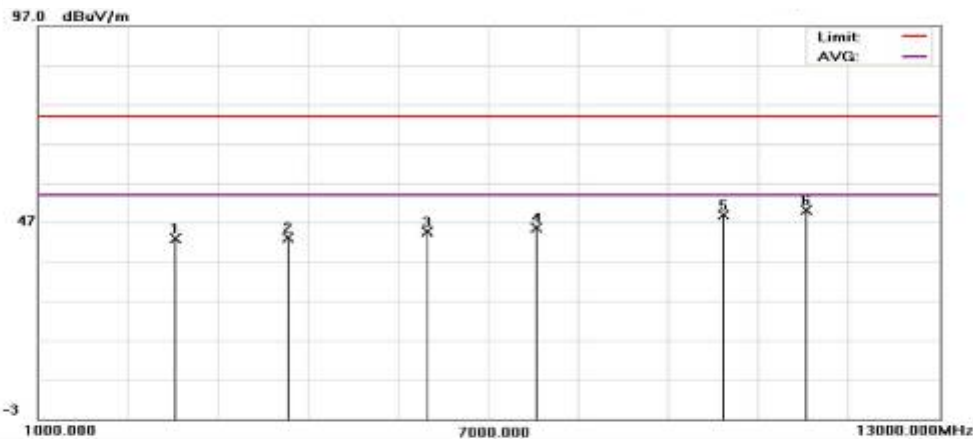

Site : 966 Chamber      Polarization: **Horizontal**      Temperature: 25 °C  
Limit: FCC Class B 3M Radiation(1G-40G)(Pea)      Power: AC 120V/60Hz      Humidity: 60%  
EUT:      Distance: 3m  
M/N:      Mode: Config 2:EUT+Battery(LG)+Adapter(Main Salcomp)+USB Cable+ SHF Play Recording  
Note:

No.	Mk.	Freq. MHz	Reading Level dBuV	Correct Factor dB	Measure- ment dBuV/m	Limit dBuV/m	Over dB	Detector	Comment
1		2824.000	39.87	2.95	42.82	74.00	-31.18	peak	
2		4336.000	37.51	5.62	43.13	74.00	-30.87	peak	
3		6184.000	35.93	8.70	44.63	74.00	-29.37	peak	
4		7648.000	35.77	9.80	45.57	74.00	-28.43	peak	
5		10144.00	35.01	13.93	48.94	74.00	-25.06	peak	
6	*	11248.00	33.91	16.10	50.01	74.00	-23.99	peak	

\*:Maximum data    x:Over limit    !:over margin      ●:ReferenceOnly

Printed with FreePrint - purchase at [www.freeprint.com](http://www.freeprint.com)

Unless otherwise stated the results shown in this test report refer only to the sample(s) tested and such sample(s) are retained for 90 days only.  
除非另有說明，此報告結果僅對測試之樣品負責，同時此樣品僅保留90天。本報告未經本公司書面許可，不可部份複製。

This document is issued by the Company subject to its General Conditions of Service printed overleaf, available on request or accessible at [www.sgs.com/terms\\_and\\_conditions.htm](http://www.sgs.com/terms_and_conditions.htm) and, for electronic format documents, subject to Terms and Conditions for Electronic Documents at [www.sgs.com/terms\\_e-document.htm](http://www.sgs.com/terms_e-document.htm). Attention is drawn to the limitation of liability, indemnification and jurisdiction issues defined therein. Any holder of this document is advised that information contained hereon reflects the Company's findings at the time of its intervention only and within the limits of Client's instructions, if any. The Company's sole responsibility is to its Client and this document does not exonerate parties to a transaction from exercising all their rights and obligations under the transaction documents. This document cannot be reproduced except in full, without prior written approval of the Company. Any unauthorized alteration, forgery or falsification of the content or appearance of this document is unlawful and offenders may be prosecuted to the fullest extent of the law.

臺灣檢驗科技股份有限公司 - 電子暨通訊實驗室  
 Address : 台北縣五股工業區五工路 134 號  
 Tel:02-2299-3279 Fax:02-2298-2698

**Radiated Emission Measurement**

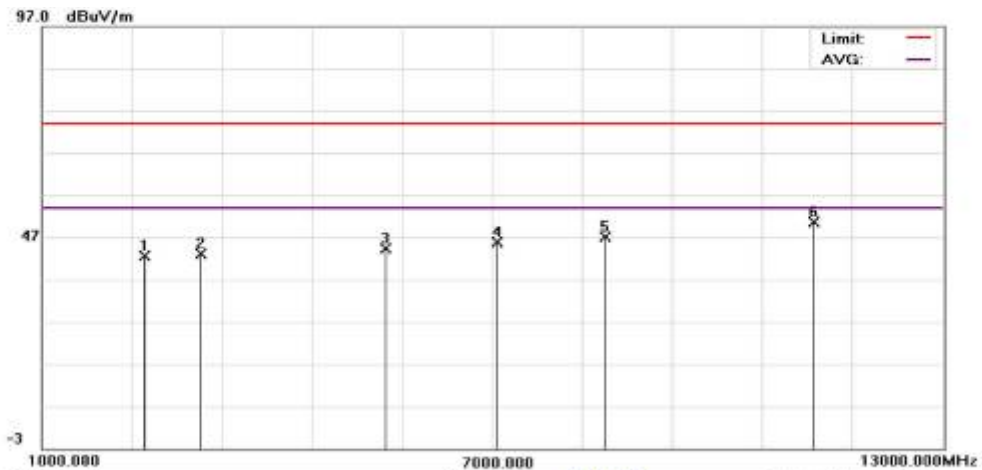

Site :966 Chamber Polarization: **Vertical** Temperature: 25 ℃  
 Limit: FCC Class B 3M Radiation(1G-40G)(Pea Power: AC 120V/60Hz Humidity: 60%  
 EUT: Distance: 3m  
 MN:  
 Mode: Config 2:EUT+Battery(LG)+Adapter(Main Salcomp)+USB Cable+ SHF Play Recording  
 Note:

No.	Mk.	Freq. MHz	Reading Level dBuV	Correct Factor dB	Measurement dBuV/m	Limit dBuV/m	Over dB	Detector	Comment
1		2368.000	40.61	2.08	42.69	74.00	-31.31	peak	
2		3112.000	39.65	3.53	43.18	74.00	-30.82	peak	
3		5584.000	36.84	7.59	44.43	74.00	-29.57	peak	
4		7072.000	36.48	9.36	45.84	74.00	-28.16	peak	
5		8512.000	36.40	10.76	47.16	74.00	-26.84	peak	
6	*	11296.00	34.41	16.15	50.56	74.00	-23.44	peak	

\*:Maximum data x:Over limit !:over margin

●ReferenceOnly

Printed with FreePrint - purchase at www.FreePrint.com

Unless otherwise stated the results shown in this test report refer only to the sample(s) tested and such sample(s) are retained for 90 days only.  
 除非另有說明，此報告結果僅對測試之樣品負責，同時此樣品僅保留90天。本報告未經本公司書面許可，不可部份複製。

This document is issued by the Company subject to its General Conditions of Service printed overleaf, available on request or accessible at [www.sgs.com/terms\\_and\\_conditions.htm](http://www.sgs.com/terms_and_conditions.htm) and, for electronic format documents, subject to Terms and Conditions for Electronic Documents at [www.sgs.com/terms\\_e-document.htm](http://www.sgs.com/terms_e-document.htm). Attention is drawn to the limitation of liability, indemnification and jurisdiction issues defined therein. Any holder of this document is advised that information contained hereon reflects the Company's findings at the time of its intervention only and within the limits of Client's instructions, if any. The Company's sole responsibility is to its Client and this document does not exonerate parties to a transaction from exercising all their rights and obligations under the transaction documents. This document cannot be reproduced except in full, without prior written approval of the Company. Any unauthorized alteration, forgery or falsification of the content or appearance of this document is unlawful and offenders may be prosecuted to the fullest extent of the law.

### 3. Photographs of Test

CE:

Config 1

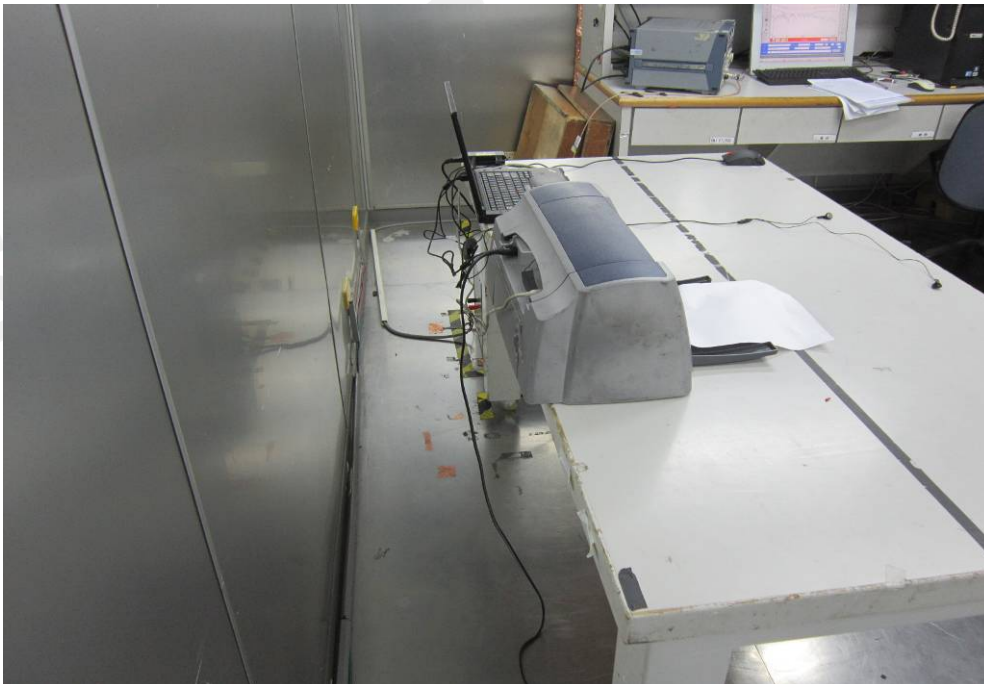

Unless otherwise stated the results shown in this test report refer only to the sample(s) tested and such sample(s) are retained for 90 days only.  
 除非另有說明，此報告結果僅對測試之樣品負責，同時此樣品僅保留90天。本報告未經本公司書面許可，不可部份複製。

This document is issued by the Company subject to its General Conditions of Service printed overleaf, available on request or accessible at [www.sgs.com/terms\\_and\\_conditions.htm](http://www.sgs.com/terms_and_conditions.htm) and, for electronic format documents, subject to Terms and Conditions for Electronic Documents at [www.sgs.com/terms\\_e-document.htm](http://www.sgs.com/terms_e-document.htm). Attention is drawn to the limitation of liability, indemnification and jurisdiction issues defined therein. Any holder of this document is advised that information contained hereon reflects the Company's findings at the time of its intervention only and within the limits of Client's instructions, if any. The Company's sole responsibility is to its Client and this document does not exonerate parties to a transaction from exercising all their rights and obligations under the transaction documents. This document cannot be reproduced except in full, without prior written approval of the Company. Any unauthorized alteration, forgery or falsification of the content or appearance of this document is unlawful and offenders may be prosecuted to the fullest extent of the law.

## Config 2 : Main : Salcomp

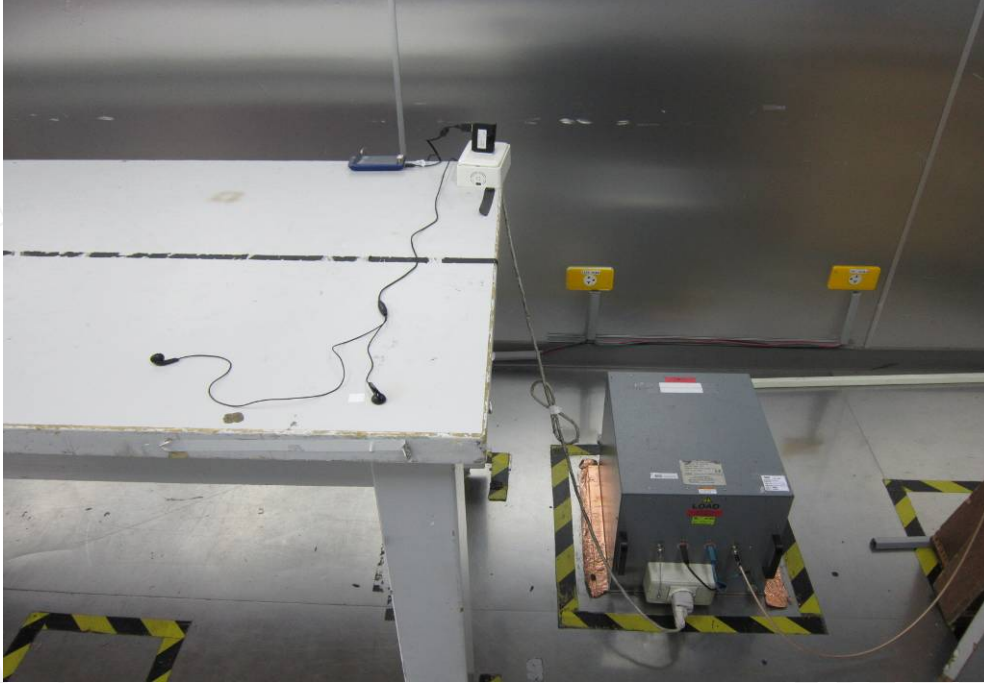

Unless otherwise stated the results shown in this test report refer only to the sample(s) tested and such sample(s) are retained for 90 days only.  
除非另有說明，此報告結果僅對測試之樣品負責，同時此樣品僅保留90天。本報告未經本公司書面許可，不可部份複製。

This document is issued by the Company subject to its General Conditions of Service printed overleaf, available on request or accessible at [www.sgs.com/terms\\_and\\_conditions.htm](http://www.sgs.com/terms_and_conditions.htm) and, for electronic format documents, subject to Terms and Conditions for Electronic Documents at [www.sgs.com/terms\\_e-document.htm](http://www.sgs.com/terms_e-document.htm). Attention is drawn to the limitation of liability, indemnification and jurisdiction issues defined therein. Any holder of this document is advised that information contained hereon reflects the Company's findings at the time of its intervention only and within the limits of Client's instructions, if any. The Company's sole responsibility is to its Client and this document does not exonerate parties to a transaction from exercising all their rights and obligations under the transaction documents. This document cannot be reproduced except in full, without prior written approval of the Company. Any unauthorized alteration, forgery or falsification of the content or appearance of this document is unlawful and offenders may be prosecuted to the fullest extent of the law.

## Config 2 : Second : EMERSON



Unless otherwise stated the results shown in this test report refer only to the sample(s) tested and such sample(s) are retained for 90 days only.  
除非另有說明，此報告結果僅對測試之樣品負責，同時此樣品僅保留90天。本報告未經本公司書面許可，不可部份複製。

This document is issued by the Company subject to its General Conditions of Service printed overleaf, available on request or accessible at [www.sgs.com/terms\\_and\\_conditions.htm](http://www.sgs.com/terms_and_conditions.htm) and, for electronic format documents, subject to Terms and Conditions for Electronic Documents at [www.sgs.com/terms\\_e-document.htm](http://www.sgs.com/terms_e-document.htm). Attention is drawn to the limitation of liability, indemnification and jurisdiction issues defined therein. Any holder of this document is advised that information contained hereon reflects the Company's findings at the time of its intervention only and within the limits of Client's instructions, if any. The Company's sole responsibility is to its Client and this document does not exonerate parties to a transaction from exercising all their rights and obligations under the transaction documents. This document cannot be reproduced except in full, without prior written approval of the Company. Any unauthorized alteration, forgery or falsification of the content or appearance of this document is unlawful and offenders may be prosecuted to the fullest extent of the law.



## Config 3 : FM Mode



Unless otherwise stated the results shown in this test report refer only to the sample(s) tested and such sample(s) are retained for 90 days only.  
除非另有說明，此報告結果僅對測試之樣品負責，同時此樣品僅保留90天。本報告未經本公司書面許可，不可部份複製。

This document is issued by the Company subject to its General Conditions of Service printed overleaf, available on request or accessible at [www.sgs.com/terms\\_and\\_conditions.htm](http://www.sgs.com/terms_and_conditions.htm) and, for electronic format documents, subject to Terms and Conditions for Electronic Documents at [www.sgs.com/terms\\_e-document.htm](http://www.sgs.com/terms_e-document.htm). Attention is drawn to the limitation of liability, indemnification and jurisdiction issues defined therein. Any holder of this document is advised that information contained hereon reflects the Company's findings at the time of its intervention only and within the limits of Client's instructions, if any. The Company's sole responsibility is to its Client and this document does not exonerate parties to a transaction from exercising all their rights and obligations under the transaction documents. This document cannot be reproduced except in full, without prior written approval of the Company. Any unauthorized alteration, forgery or falsification of the content or appearance of this document is unlawful and offenders may be prosecuted to the fullest extent of the law.

RE:

Below 1G

Config 1

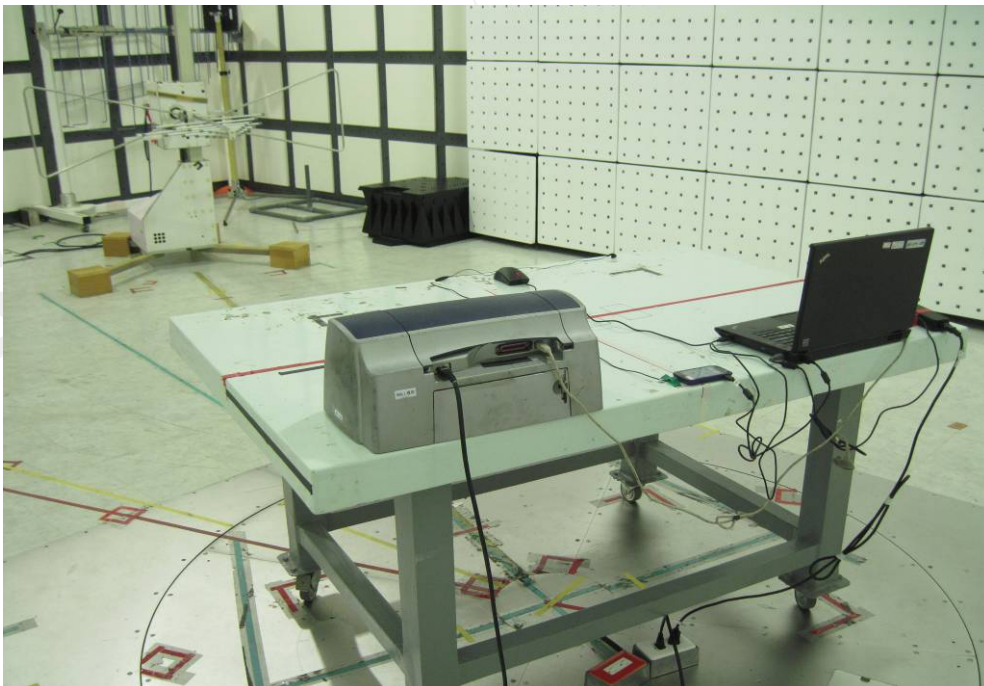
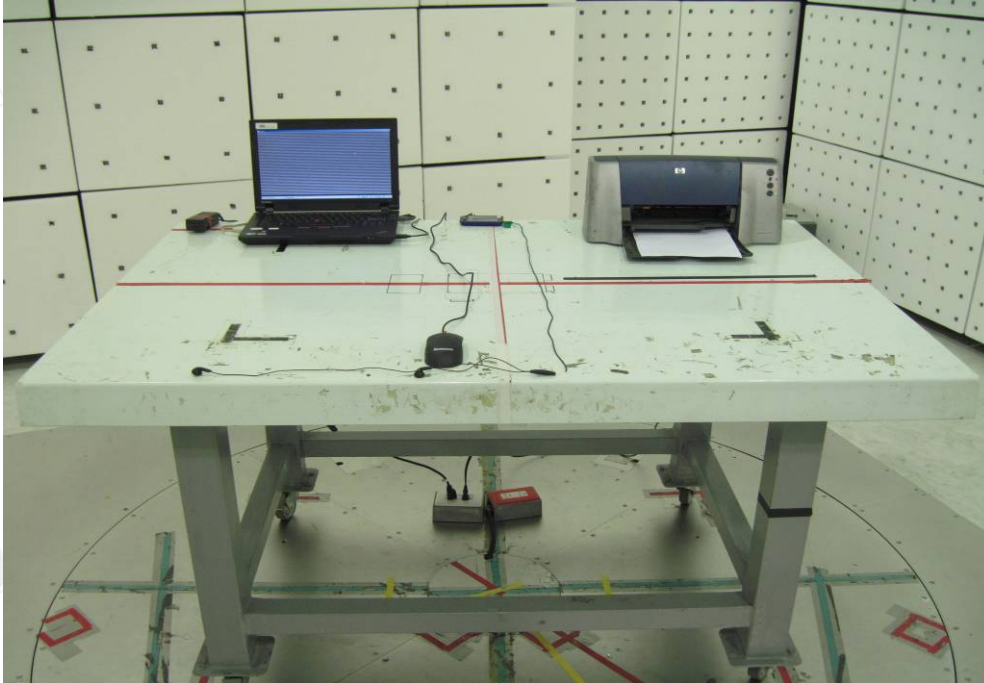

Unless otherwise stated the results shown in this test report refer only to the sample(s) tested and such sample(s) are retained for 90 days only.  
除非另有說明，此報告結果僅對測試之樣品負責，同時此樣品僅保留90天。本報告未經本公司書面許可，不可部份複製。

This document is issued by the Company subject to its General Conditions of Service printed overleaf, available on request or accessible at [www.sgs.com/terms\\_and\\_conditions.htm](http://www.sgs.com/terms_and_conditions.htm) and, for electronic format documents, subject to Terms and Conditions for Electronic Documents at [www.sgs.com/terms\\_e-document.htm](http://www.sgs.com/terms_e-document.htm). Attention is drawn to the limitation of liability, indemnification and jurisdiction issues defined therein. Any holder of this document is advised that information contained hereon reflects the Company's findings at the time of its intervention only and within the limits of Client's instructions, if any. The Company's sole responsibility is to its Client and this document does not exonerate parties to a transaction from exercising all their rights and obligations under the transaction documents. This document cannot be reproduced except in full, without prior written approval of the Company. Any unauthorized alteration, forgery or falsification of the content or appearance of this document is unlawful and offenders may be prosecuted to the fullest extent of the law.

Config 2

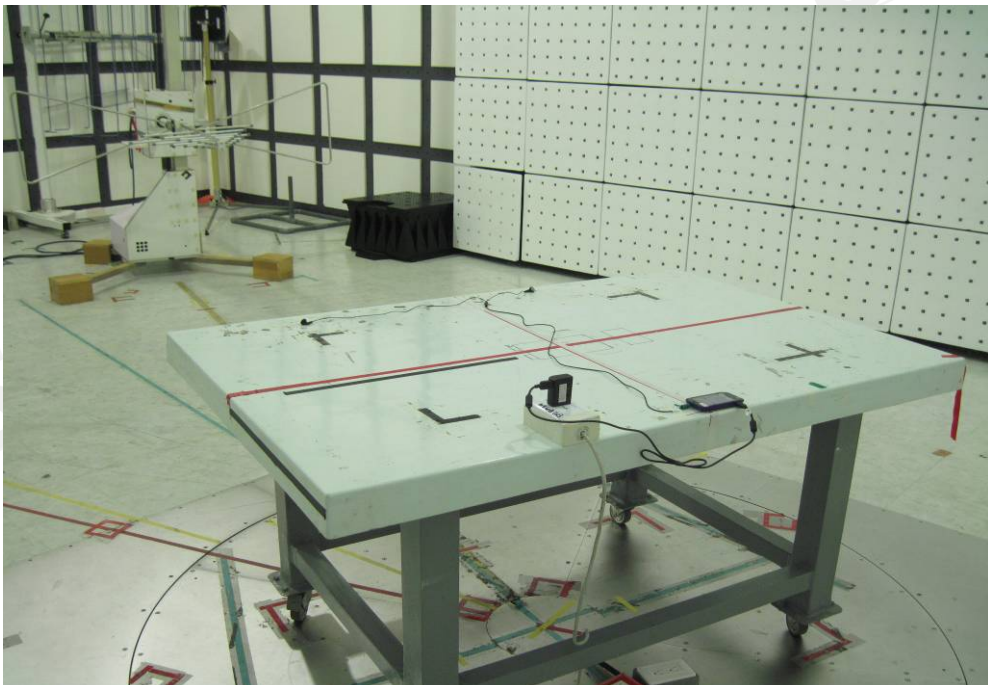
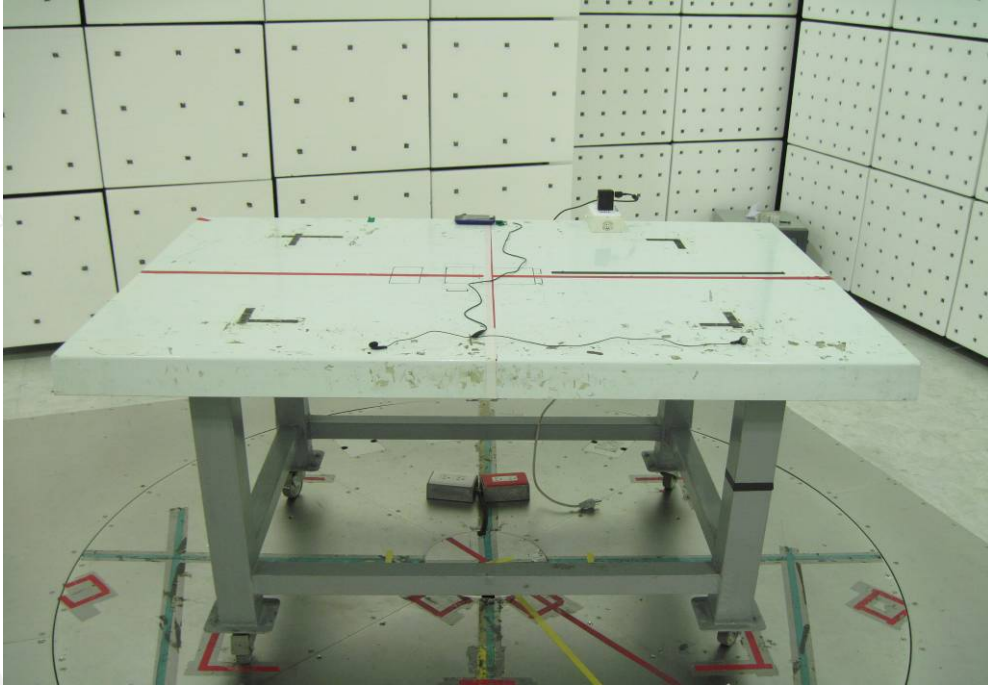

Unless otherwise stated the results shown in this test report refer only to the sample(s) tested and such sample(s) are retained for 90 days only.  
除非另有說明，此報告結果僅對測試之樣品負責，同時此樣品僅保留90天。本報告未經本公司書面許可，不可部份複製。

This document is issued by the Company subject to its General Conditions of Service printed overleaf, available on request or accessible at [www.sgs.com/terms\\_and\\_conditions.htm](http://www.sgs.com/terms_and_conditions.htm) and, for electronic format documents, subject to Terms and Conditions for Electronic Documents at [www.sgs.com/terms\\_e-document.htm](http://www.sgs.com/terms_e-document.htm). Attention is drawn to the limitation of liability, indemnification and jurisdiction issues defined therein. Any holder of this document is advised that information contained hereon reflects the Company's findings at the time of its intervention only and within the limits of Client's instructions, if any. The Company's sole responsibility is to its Client and this document does not exonerate parties to a transaction from exercising all their rights and obligations under the transaction documents. This document cannot be reproduced except in full, without prior written approval of the Company. Any unauthorized alteration, forgery or falsification of the content or appearance of this document is unlawful and offenders may be prosecuted to the fullest extent of the law.

Config 3

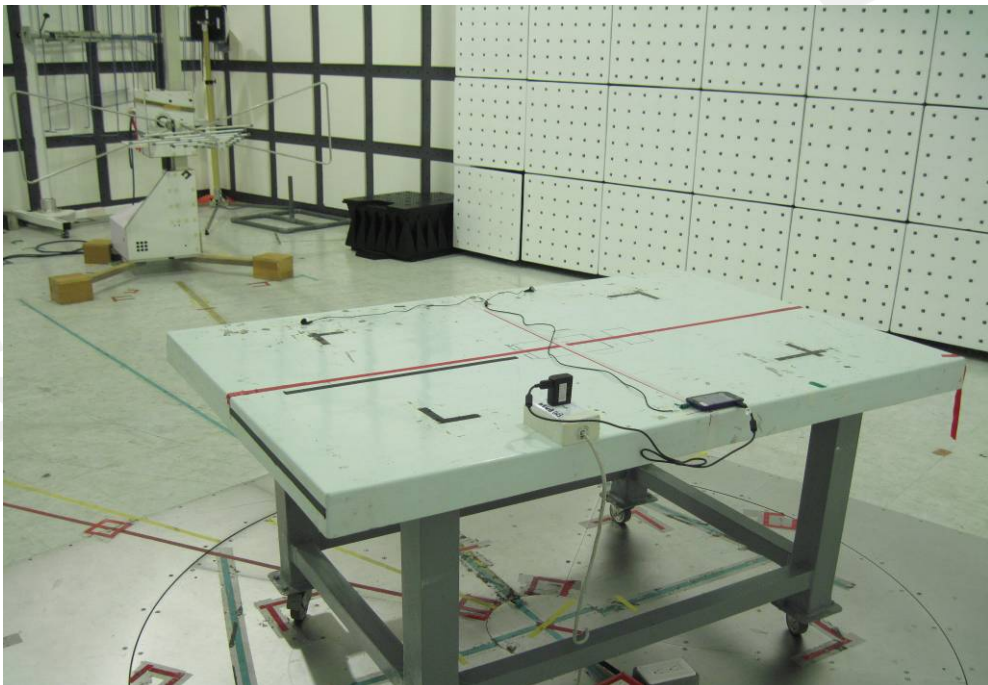
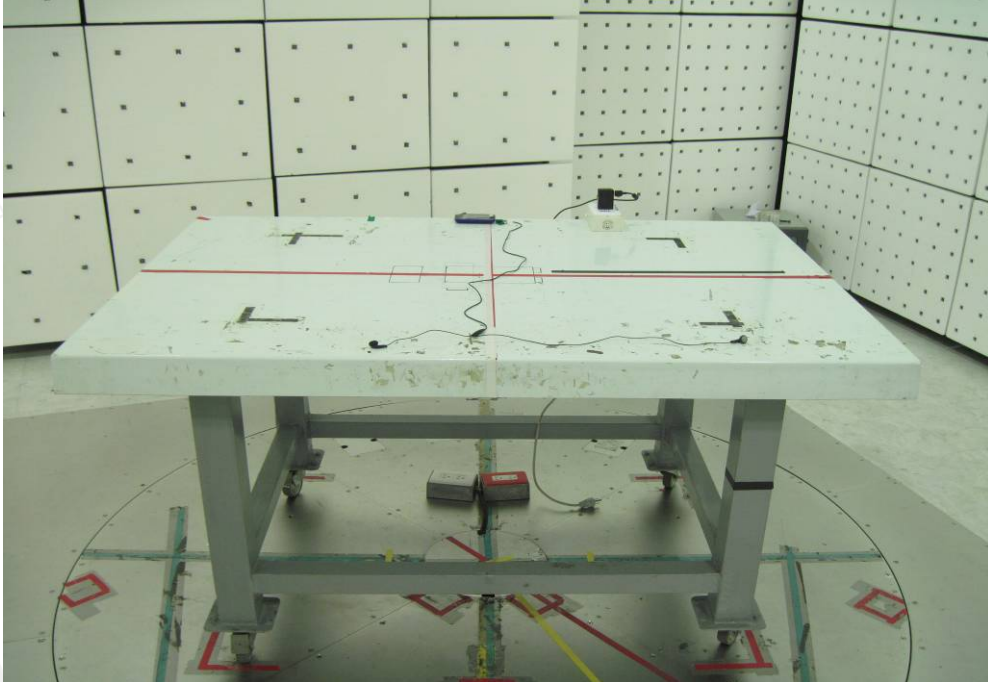

Unless otherwise stated the results shown in this test report refer only to the sample(s) tested and such sample(s) are retained for 90 days only.  
除非另有說明，此報告結果僅對測試之樣品負責，同時此樣品僅保留90天。本報告未經本公司書面許可，不可部份複製。

This document is issued by the Company subject to its General Conditions of Service printed overleaf, available on request or accessible at [www.sgs.com/terms\\_and\\_conditions.htm](http://www.sgs.com/terms_and_conditions.htm) and, for electronic format documents, subject to Terms and Conditions for Electronic Documents at [www.sgs.com/terms\\_e-document.htm](http://www.sgs.com/terms_e-document.htm). Attention is drawn to the limitation of liability, indemnification and jurisdiction issues defined therein. Any holder of this document is advised that information contained hereon reflects the Company's findings at the time of its intervention only and within the limits of Client's instructions, if any. The Company's sole responsibility is to its Client and this document does not exonerate parties to a transaction from exercising all their rights and obligations under the transaction documents. This document cannot be reproduced except in full, without prior written approval of the Company. Any unauthorized alteration, forgery or falsification of the content or appearance of this document is unlawful and offenders may be prosecuted to the fullest extent of the law.

Above 1G

Config 1

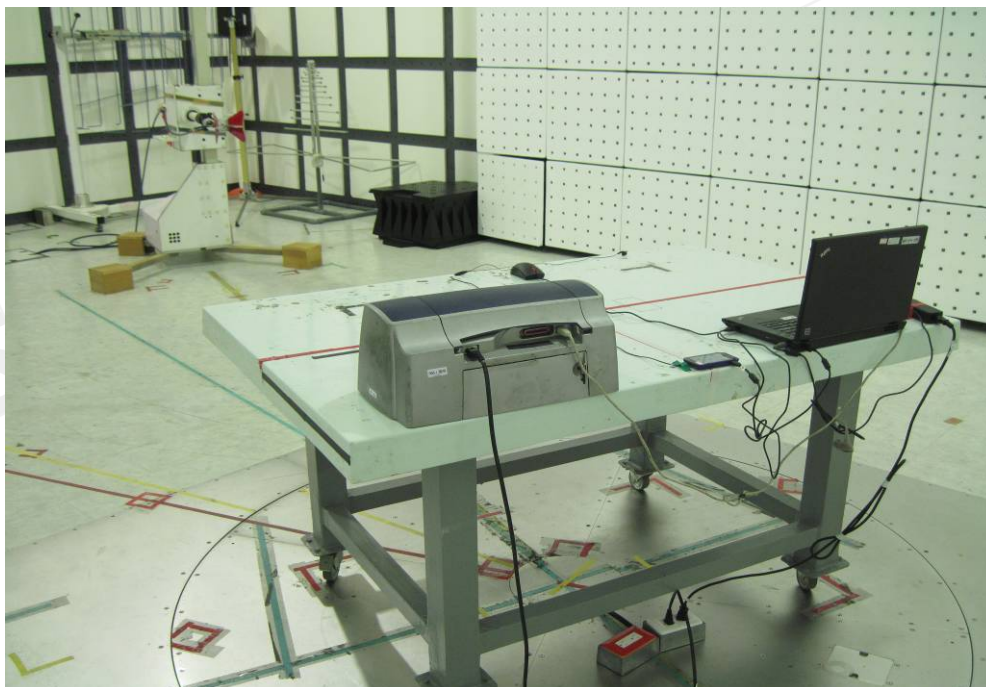

Unless otherwise stated the results shown in this test report refer only to the sample(s) tested and such sample(s) are retained for 90 days only.  
除非另有說明，此報告結果僅對測試之樣品負責，同時此樣品僅保留90天。本報告未經本公司書面許可，不可部份複製。

This document is issued by the Company subject to its General Conditions of Service printed overleaf, available on request or accessible at [www.sgs.com/terms\\_and\\_conditions.htm](http://www.sgs.com/terms_and_conditions.htm) and, for electronic format documents, subject to Terms and Conditions for Electronic Documents at [www.sgs.com/terms\\_e-document.htm](http://www.sgs.com/terms_e-document.htm). Attention is drawn to the limitation of liability, indemnification and jurisdiction issues defined therein. Any holder of this document is advised that information contained hereon reflects the Company's findings at the time of its intervention only and within the limits of Client's instructions, if any. The Company's sole responsibility is to its Client and this document does not exonerate parties to a transaction from exercising all their rights and obligations under the transaction documents. This document cannot be reproduced except in full, without prior written approval of the Company. Any unauthorized alteration, forgery or falsification of the content or appearance of this document is unlawful and offenders may be prosecuted to the fullest extent of the law.

Config 2

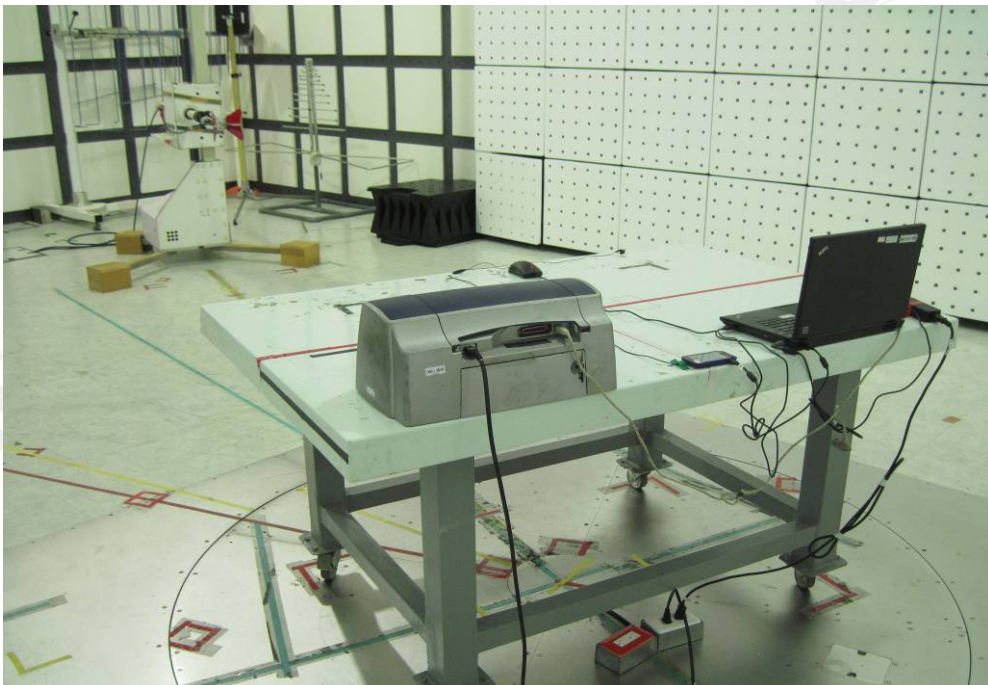
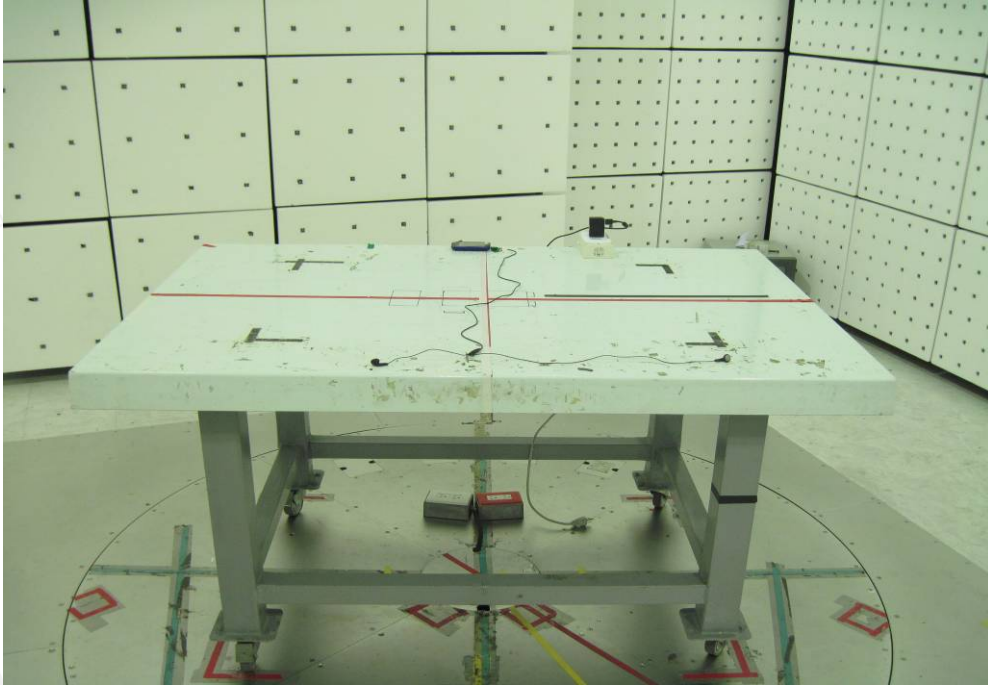

Unless otherwise stated the results shown in this test report refer only to the sample(s) tested and such sample(s) are retained for 90 days only.  
除非另有說明，此報告結果僅對測試之樣品負責，同時此樣品僅保留90天。本報告未經本公司書面許可，不可部份複製。

This document is issued by the Company subject to its General Conditions of Service printed overleaf, available on request or accessible at [www.sgs.com/terms\\_and\\_conditions.htm](http://www.sgs.com/terms_and_conditions.htm) and, for electronic format documents, subject to Terms and Conditions for Electronic Documents at [www.sgs.com/terms\\_e-document.htm](http://www.sgs.com/terms_e-document.htm). Attention is drawn to the limitation of liability, indemnification and jurisdiction issues defined therein. Any holder of this document is advised that information contained hereon reflects the Company's findings at the time of its intervention only and within the limits of Client's instructions, if any. The Company's sole responsibility is to its Client and this document does not exonerate parties to a transaction from exercising all their rights and obligations under the transaction documents. This document cannot be reproduced except in full, without prior written approval of the Company. Any unauthorized alteration, forgery or falsification of the content or appearance of this document is unlawful and offenders may be prosecuted to the fullest extent of the law.

## 4. Photographs of Product

### Exterior



Unless otherwise stated the results shown in this test report refer only to the sample(s) tested and such sample(s) are retained for 90 days only.  
 除非另有說明，此報告結果僅對測試之樣品負責，同時此樣品僅保留90天。本報告未經本公司書面許可，不可部份複製。

This document is issued by the Company subject to its General Conditions of Service printed overleaf, available on request or accessible at [www.sgs.com/terms\\_and\\_conditions.htm](http://www.sgs.com/terms_and_conditions.htm) and, for electronic format documents, subject to Terms and Conditions for Electronic Documents at [www.sgs.com/terms\\_e-document.htm](http://www.sgs.com/terms_e-document.htm). Attention is drawn to the limitation of liability, indemnification and jurisdiction issues defined therein. Any holder of this document is advised that information contained hereon reflects the Company's findings at the time of its intervention only and within the limits of Client's instructions, if any. The Company's sole responsibility is to its Client and this document does not exonerate parties to a transaction from exercising all their rights and obligations under the transaction documents. This document cannot be reproduced except in full, without prior written approval of the Company. Any unauthorized alteration, forgery or falsification of the content or appearance of this document is unlawful and offenders may be prosecuted to the fullest extent of the law.

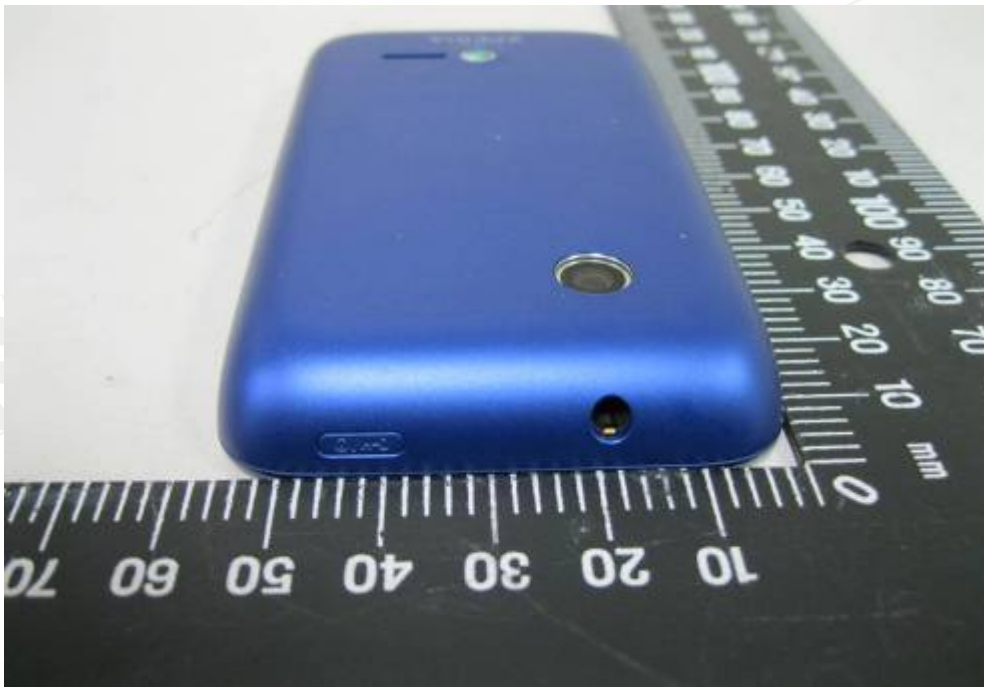

Unless otherwise stated the results shown in this test report refer only to the sample(s) tested and such sample(s) are retained for 90 days only.  
除非另有說明，此報告結果僅對測試之樣品負責，同時此樣品僅保留90天。本報告未經本公司書面許可，不可部份複製。

This document is issued by the Company subject to its General Conditions of Service printed overleaf, available on request or accessible at [www.sgs.com/terms\\_and\\_conditions.htm](http://www.sgs.com/terms_and_conditions.htm) and, for electronic format documents, subject to Terms and Conditions for Electronic Documents at [www.sgs.com/terms\\_e-document.htm](http://www.sgs.com/terms_e-document.htm). Attention is drawn to the limitation of liability, indemnification and jurisdiction issues defined therein. Any holder of this document is advised that information contained hereon reflects the Company's findings at the time of its intervention only and within the limits of Client's instructions, if any. The Company's sole responsibility is to its Client and this document does not exonerate parties to a transaction from exercising all their rights and obligations under the transaction documents. This document cannot be reproduced except in full, without prior written approval of the Company. Any unauthorized alteration, forgery or falsification of the content or appearance of this document is unlawful and offenders may be prosecuted to the fullest extent of the law.



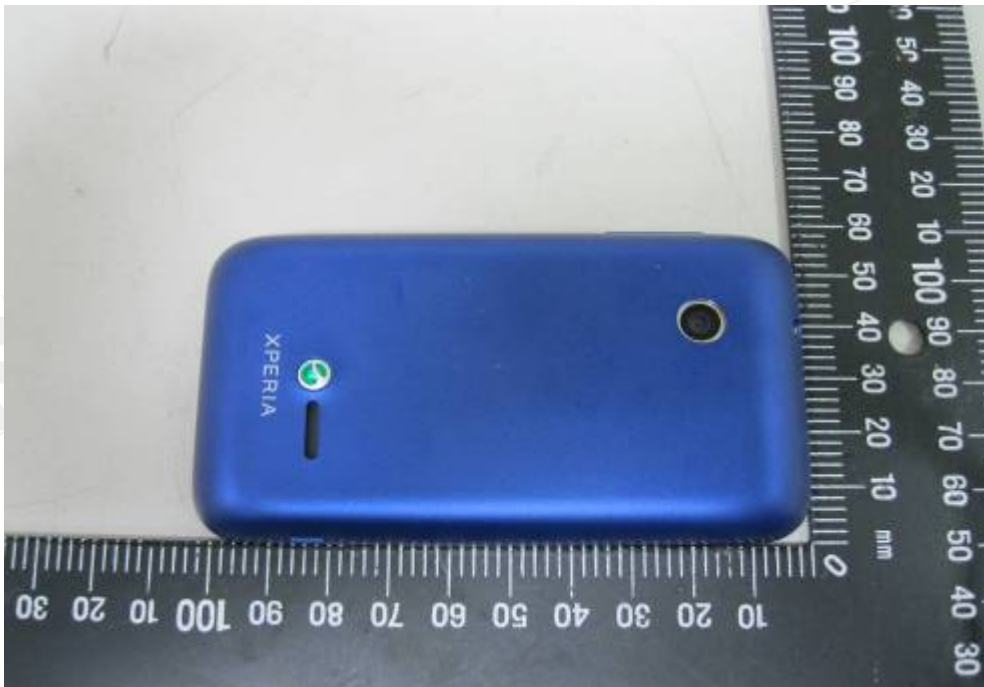

Unless otherwise stated the results shown in this test report refer only to the sample(s) tested and such sample(s) are retained for 90 days only.  
除非另有說明，此報告結果僅對測試之樣品負責，同時此樣品僅保留90天。本報告未經本公司書面許可，不可部份複製。

This document is issued by the Company subject to its General Conditions of Service printed overleaf, available on request or accessible at [www.sgs.com/terms\\_and\\_conditions.htm](http://www.sgs.com/terms_and_conditions.htm) and, for electronic format documents, subject to Terms and Conditions for Electronic Documents at [www.sgs.com/terms\\_e-document.htm](http://www.sgs.com/terms_e-document.htm). Attention is drawn to the limitation of liability, indemnification and jurisdiction issues defined therein. Any holder of this document is advised that information contained hereon reflects the Company's findings at the time of its intervention only and within the limits of Client's instructions, if any. The Company's sole responsibility is to its Client and this document does not exonerate parties to a transaction from exercising all their rights and obligations under the transaction documents. This document cannot be reproduced except in full, without prior written approval of the Company. Any unauthorized alteration, forgery or falsification of the content or appearance of this document is unlawful and offenders may be prosecuted to the fullest extent of the law.



Unless otherwise stated the results shown in this test report refer only to the sample(s) tested and such sample(s) are retained for 90 days only.  
除非另有說明，此報告結果僅對測試之樣品負責，同時此樣品僅保留90天。本報告未經本公司書面許可，不可部份複製。

This document is issued by the Company subject to its General Conditions of Service printed overleaf, available on request or accessible at [www.sgs.com/terms\\_and\\_conditions.htm](http://www.sgs.com/terms_and_conditions.htm) and, for electronic format documents, subject to Terms and Conditions for Electronic Documents at [www.sgs.com/terms\\_e-document.htm](http://www.sgs.com/terms_e-document.htm). Attention is drawn to the limitation of liability, indemnification and jurisdiction issues defined therein. Any holder of this document is advised that information contained hereon reflects the Company's findings at the time of its intervention only and within the limits of Client's instructions, if any. The Company's sole responsibility is to its Client and this document does not exonerate parties to a transaction from exercising all their rights and obligations under the transaction documents. This document cannot be reproduced except in full, without prior written approval of the Company. Any unauthorized alteration, forgery or falsification of the content or appearance of this document is unlawful and offenders may be prosecuted to the fullest extent of the law.



Unless otherwise stated the results shown in this test report refer only to the sample(s) tested and such sample(s) are retained for 90 days only.  
 除非另有說明，此報告結果僅對測試之樣品負責，同時此樣品僅保留90天。本報告未經本公司書面許可，不可部份複製。

This document is issued by the Company subject to its General Conditions of Service printed overleaf, available on request or accessible at [www.sgs.com/terms\\_and\\_conditions.htm](http://www.sgs.com/terms_and_conditions.htm) and, for electronic format documents, subject to Terms and Conditions for Electronic Documents at [www.sgs.com/terms\\_e-document.htm](http://www.sgs.com/terms_e-document.htm). Attention is drawn to the limitation of liability, indemnification and jurisdiction issues defined therein. Any holder of this document is advised that information contained hereon reflects the Company's findings at the time of its intervention only and within the limits of Client's instructions, if any. The Company's sole responsibility is to its Client and this document does not exonerate parties to a transaction from exercising all their rights and obligations under the transaction documents. This document cannot be reproduced except in full, without prior written approval of the Company. Any unauthorized alteration, forgery or falsification of the content or appearance of this document is unlawful and offenders may be prosecuted to the fullest extent of the law.



**Adapter – 1 (Model No.: EP800, Supplier: Salcomp)**



Unless otherwise stated the results shown in this test report refer only to the sample(s) tested and such sample(s) are retained for 90 days only.  
 除非另有說明，此報告結果僅對測試之樣品負責，同時此樣品僅保留90天。本報告未經本公司書面許可，不可部份複製。

This document is issued by the Company subject to its General Conditions of Service printed overleaf, available on request or accessible at [www.sgs.com/terms\\_and\\_conditions.htm](http://www.sgs.com/terms_and_conditions.htm) and, for electronic format documents, subject to Terms and Conditions for Electronic Documents at [www.sgs.com/terms\\_e-document.htm](http://www.sgs.com/terms_e-document.htm). Attention is drawn to the limitation of liability, indemnification and jurisdiction issues defined therein. Any holder of this document is advised that information contained hereon reflects the Company's findings at the time of its intervention only and within the limits of Client's instructions, if any. The Company's sole responsibility is to its Client and this document does not exonerate parties to a transaction from exercising all their rights and obligations under the transaction documents. This document cannot be reproduced except in full, without prior written approval of the Company. Any unauthorized alteration, forgery or falsification of the content or appearance of this document is unlawful and offenders may be prosecuted to the fullest extent of the law.

**Adapter – 2 (Model No.: EP800, Supplier: EMERSON)**

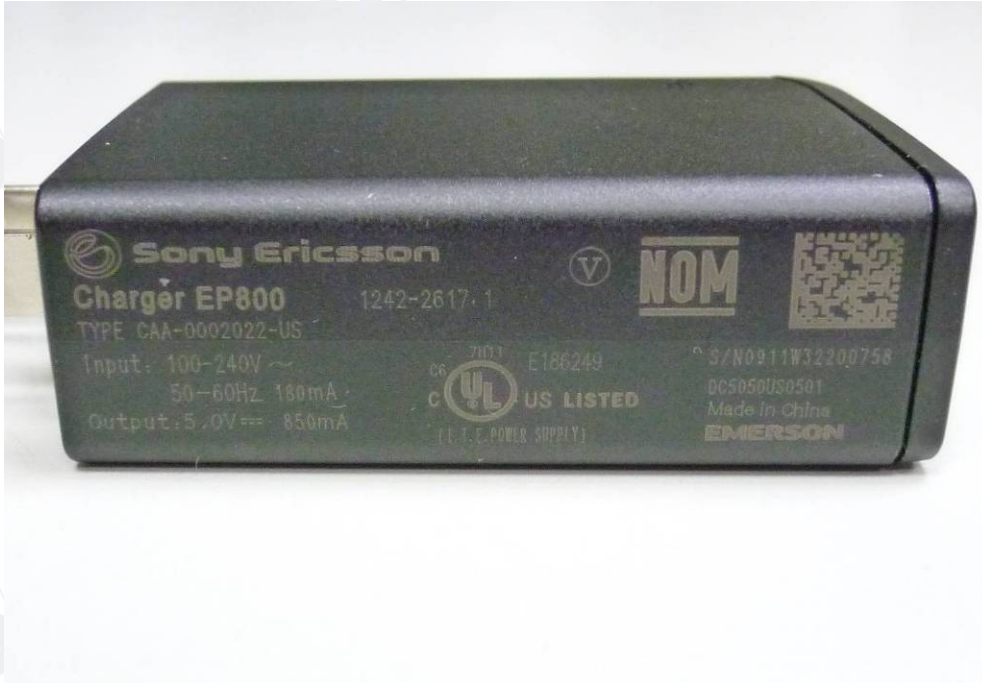

Unless otherwise stated the results shown in this test report refer only to the sample(s) tested and such sample(s) are retained for 90 days only.  
 除非另有說明，此報告結果僅對測試之樣品負責，同時此樣品僅保留90天。本報告未經本公司書面許可，不可部份複製。

This document is issued by the Company subject to its General Conditions of Service printed overleaf, available on request or accessible at [www.sgs.com/terms\\_and\\_conditions.htm](http://www.sgs.com/terms_and_conditions.htm) and, for electronic format documents, subject to Terms and Conditions for Electronic Documents at [www.sgs.com/terms\\_e-document.htm](http://www.sgs.com/terms_e-document.htm). Attention is drawn to the limitation of liability, indemnification and jurisdiction issues defined therein. Any holder of this document is advised that information contained hereon reflects the Company's findings at the time of its intervention only and within the limits of Client's instructions, if any. The Company's sole responsibility is to its Client and this document does not exonerate parties to a transaction from exercising all their rights and obligations under the transaction documents. This document cannot be reproduced except in full, without prior written approval of the Company. Any unauthorized alteration, forgery or falsification of the content or appearance of this document is unlawful and offenders may be prosecuted to the fullest extent of the law.



Unless otherwise stated the results shown in this test report refer only to the sample(s) tested and such sample(s) are retained for 90 days only.  
除非另有說明，此報告結果僅對測試之樣品負責，同時此樣品僅保留90天。本報告未經本公司書面許可，不可部份複製。

This document is issued by the Company subject to its General Conditions of Service printed overleaf, available on request or accessible at [www.sgs.com/terms\\_and\\_conditions.htm](http://www.sgs.com/terms_and_conditions.htm) and, for electronic format documents, subject to Terms and Conditions for Electronic Documents at [www.sgs.com/terms\\_e-document.htm](http://www.sgs.com/terms_e-document.htm). Attention is drawn to the limitation of liability, indemnification and jurisdiction issues defined therein. Any holder of this document is advised that information contained hereon reflects the Company's findings at the time of its intervention only and within the limits of Client's instructions, if any. The Company's sole responsibility is to its Client and this document does not exonerate parties to a transaction from exercising all their rights and obligations under the transaction documents. This document cannot be reproduced except in full, without prior written approval of the Company. Any unauthorized alteration, forgery or falsification of the content or appearance of this document is unlawful and offenders may be prosecuted to the fullest extent of the law.

## Interior

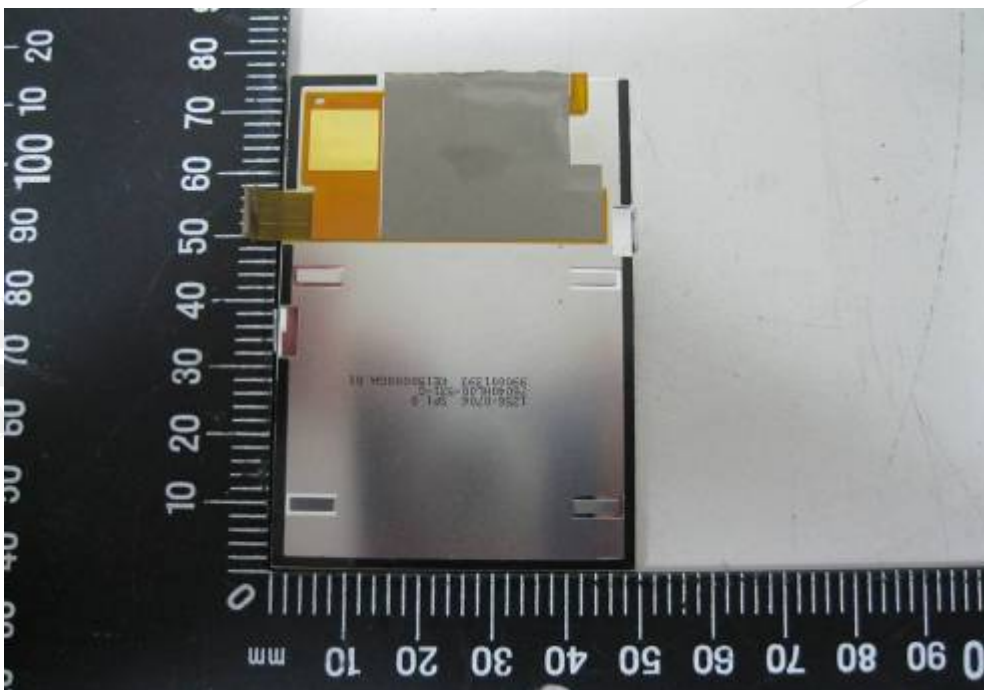
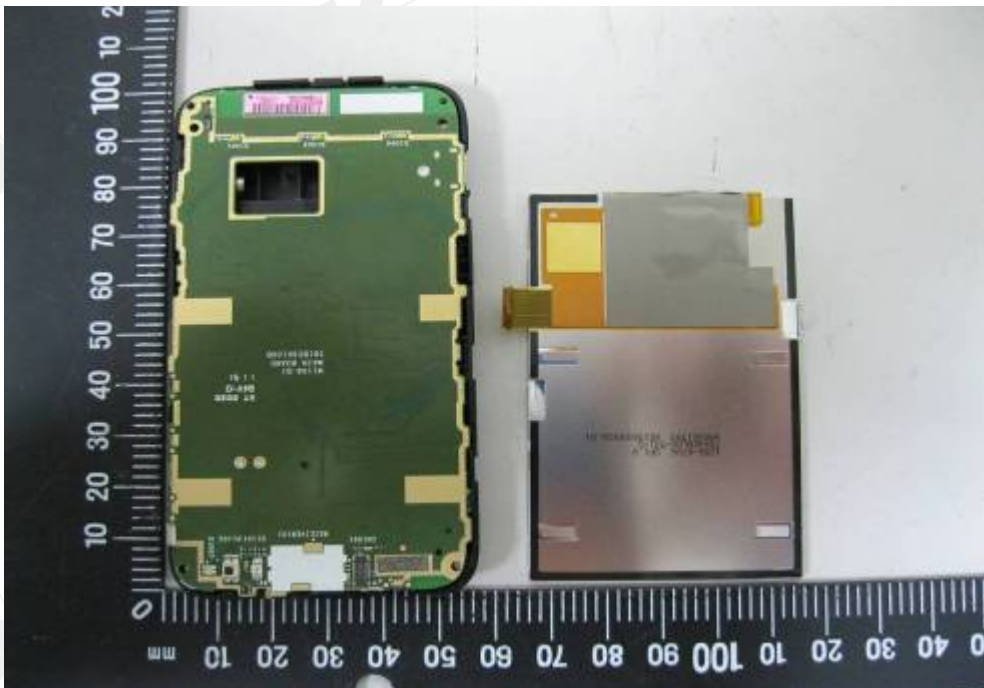

Unless otherwise stated the results shown in this test report refer only to the sample(s) tested and such sample(s) are retained for 90 days only.  
除非另有說明，此報告結果僅對測試之樣品負責，同時此樣品僅保留90天。本報告未經本公司書面許可，不可部份複製。

This document is issued by the Company subject to its General Conditions of Service printed overleaf, available on request or accessible at [www.sgs.com/terms\\_and\\_conditions.htm](http://www.sgs.com/terms_and_conditions.htm) and, for electronic format documents, subject to Terms and Conditions for Electronic Documents at [www.sgs.com/terms\\_e-document.htm](http://www.sgs.com/terms_e-document.htm). Attention is drawn to the limitation of liability, indemnification and jurisdiction issues defined therein. Any holder of this document is advised that information contained hereon reflects the Company's findings at the time of its intervention only and within the limits of Client's instructions, if any. The Company's sole responsibility is to its Client and this document does not exonerate parties to a transaction from exercising all their rights and obligations under the transaction documents. This document cannot be reproduced except in full, without prior written approval of the Company. Any unauthorized alteration, forgery or falsification of the content or appearance of this document is unlawful and offenders may be prosecuted to the fullest extent of the law.

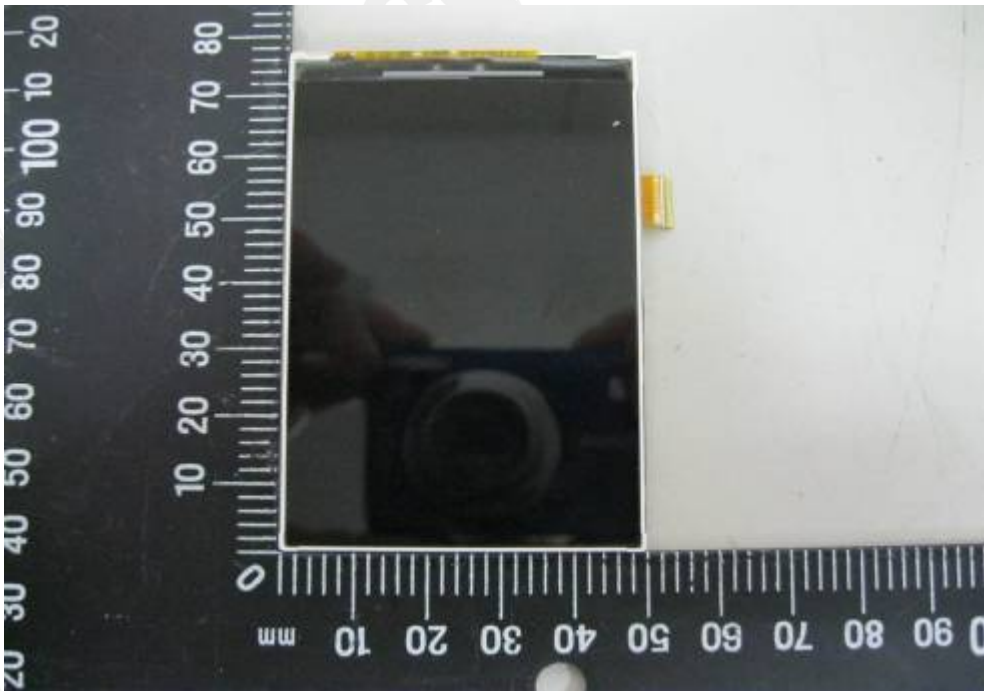

Unless otherwise stated the results shown in this test report refer only to the sample(s) tested and such sample(s) are retained for 90 days only.  
除非另有說明，此報告結果僅對測試之樣品負責，同時此樣品僅保留90天。本報告未經本公司書面許可，不可部份複製。

This document is issued by the Company subject to its General Conditions of Service printed overleaf, available on request or accessible at [www.sgs.com/terms\\_and\\_conditions.htm](http://www.sgs.com/terms_and_conditions.htm) and, for electronic format documents, subject to Terms and Conditions for Electronic Documents at [www.sgs.com/terms\\_e-document.htm](http://www.sgs.com/terms_e-document.htm). Attention is drawn to the limitation of liability, indemnification and jurisdiction issues defined therein. Any holder of this document is advised that information contained hereon reflects the Company's findings at the time of its intervention only and within the limits of Client's instructions, if any. The Company's sole responsibility is to its Client and this document does not exonerate parties to a transaction from exercising all their rights and obligations under the transaction documents. This document cannot be reproduced except in full, without prior written approval of the Company. Any unauthorized alteration, forgery or falsification of the content or appearance of this document is unlawful and offenders may be prosecuted to the fullest extent of the law.



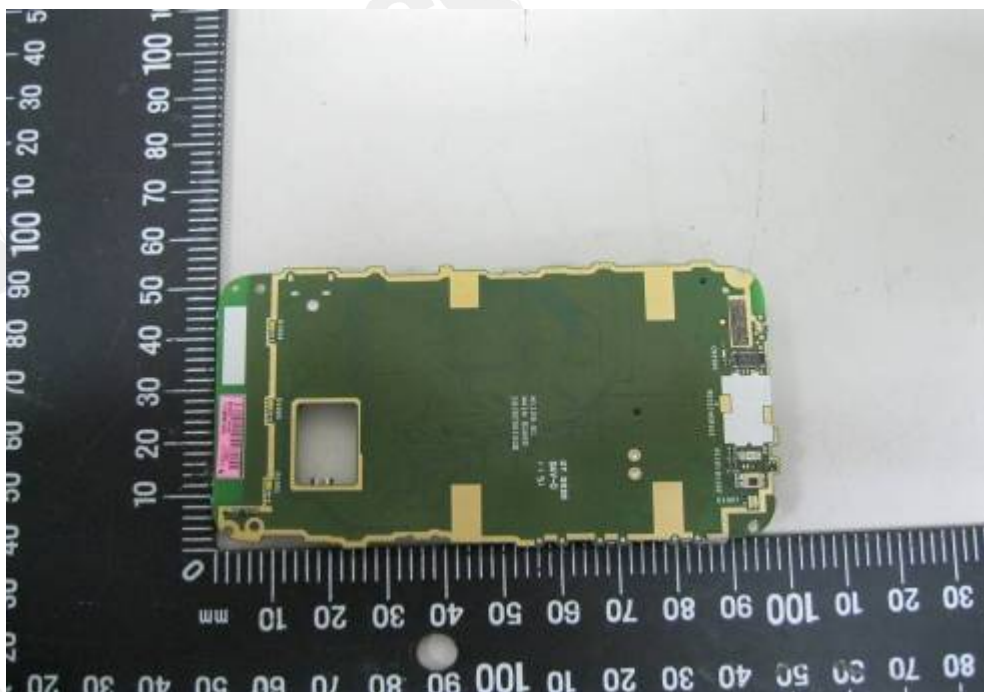

Unless otherwise stated the results shown in this test report refer only to the sample(s) tested and such sample(s) are retained for 90 days only.  
 除非另有說明，此報告結果僅對測試之樣品負責，同時此樣品僅保留90天。本報告未經本公司書面許可，不可部份複製。

This document is issued by the Company subject to its General Conditions of Service printed overleaf, available on request or accessible at [www.sgs.com/terms\\_and\\_conditions.htm](http://www.sgs.com/terms_and_conditions.htm) and, for electronic format documents, subject to Terms and Conditions for Electronic Documents at [www.sgs.com/terms\\_e-document.htm](http://www.sgs.com/terms_e-document.htm). Attention is drawn to the limitation of liability, indemnification and jurisdiction issues defined therein. Any holder of this document is advised that information contained hereon reflects the Company's findings at the time of its intervention only and within the limits of Client's instructions, if any. The Company's sole responsibility is to its Client and this document does not exonerate parties to a transaction from exercising all their rights and obligations under the transaction documents. This document cannot be reproduced except in full, without prior written approval of the Company. Any unauthorized alteration, forgery or falsification of the content or appearance of this document is unlawful and offenders may be prosecuted to the fullest extent of the law.

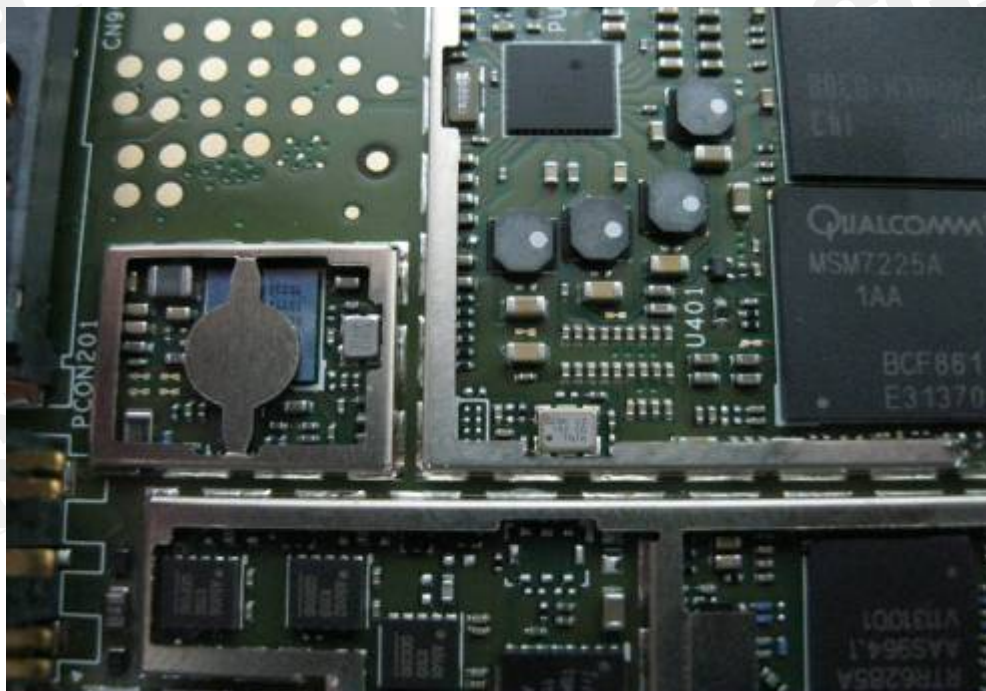
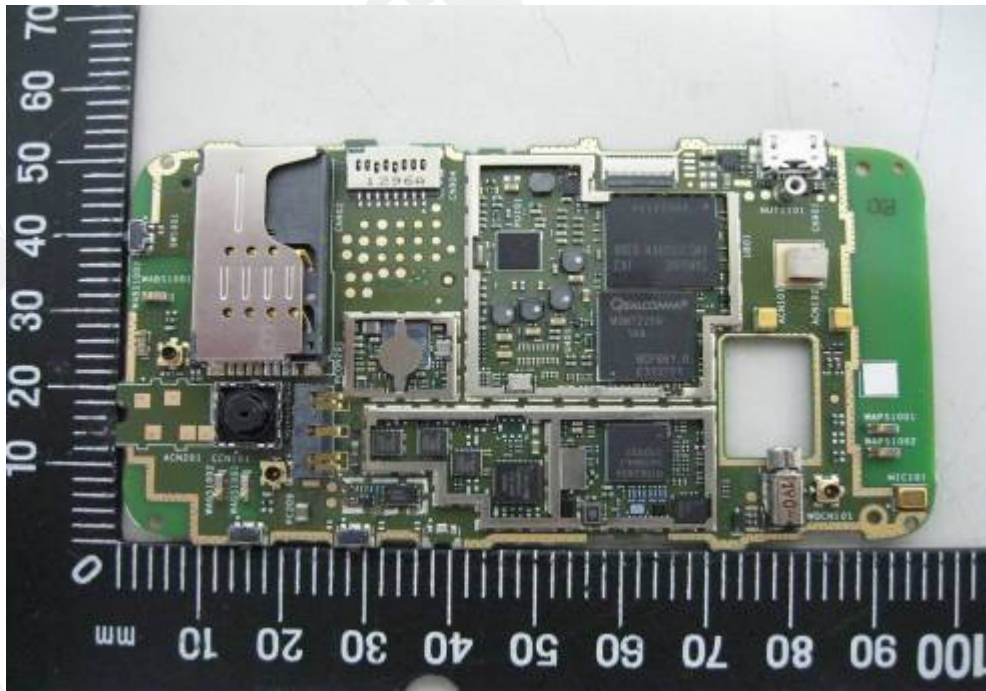

Unless otherwise stated the results shown in this test report refer only to the sample(s) tested and such sample(s) are retained for 90 days only.  
 除非另有說明，此報告結果僅對測試之樣品負責，同時此樣品僅保留90天。本報告未經本公司書面許可，不可部份複製。

This document is issued by the Company subject to its General Conditions of Service printed overleaf, available on request or accessible at [www.sgs.com/terms\\_and\\_conditions.htm](http://www.sgs.com/terms_and_conditions.htm) and, for electronic format documents, subject to Terms and Conditions for Electronic Documents at [www.sgs.com/terms\\_e-document.htm](http://www.sgs.com/terms_e-document.htm). Attention is drawn to the limitation of liability, indemnification and jurisdiction issues defined therein. Any holder of this document is advised that information contained herein reflects the Company's findings at the time of its intervention only and within the limits of Client's instructions, if any. The Company's sole responsibility is to its Client and this document does not exonerate parties to a transaction from exercising all their rights and obligations under the transaction documents. This document cannot be reproduced except in full, without prior written approval of the Company. Any unauthorized alteration, forgery or falsification of the content or appearance of this document is unlawful and offenders may be prosecuted to the fullest extent of the law.

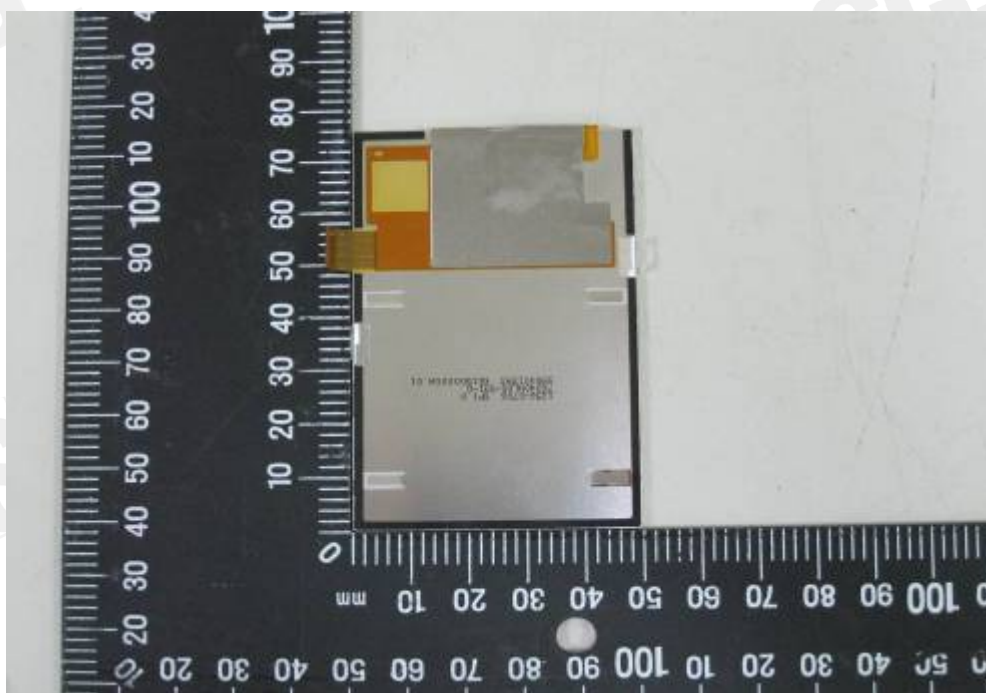
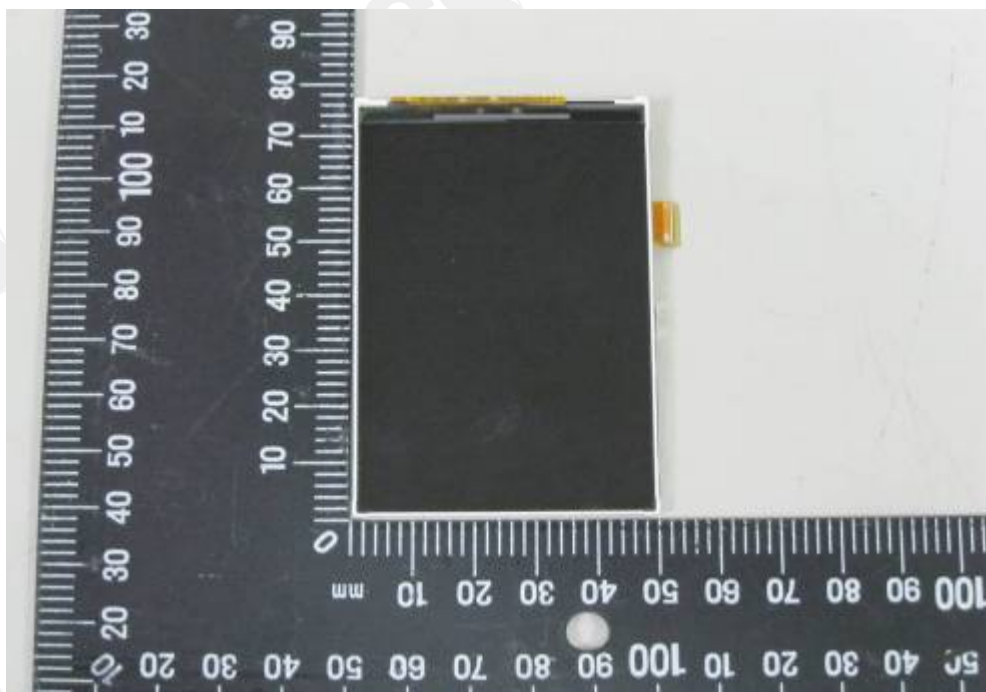

Unless otherwise stated the results shown in this test report refer only to the sample(s) tested and such sample(s) are retained for 90 days only.  
除非另有說明，此報告結果僅對測試之樣品負責，同時此樣品僅保留90天。本報告未經本公司書面許可，不可部份複製。

This document is issued by the Company subject to its General Conditions of Service printed overleaf, available on request or accessible at [www.sgs.com/terms\\_and\\_conditions.htm](http://www.sgs.com/terms_and_conditions.htm) and, for electronic format documents, subject to Terms and Conditions for Electronic Documents at [www.sgs.com/terms\\_e-document.htm](http://www.sgs.com/terms_e-document.htm). Attention is drawn to the limitation of liability, indemnification and jurisdiction issues defined therein. Any holder of this document is advised that information contained hereon reflects the Company's findings at the time of its intervention only and within the limits of Client's instructions, if any. The Company's sole responsibility is to its Client and this document does not exonerate parties to a transaction from exercising all their rights and obligations under the transaction documents. This document cannot be reproduced except in full, without prior written approval of the Company. Any unauthorized alteration, forgery or falsification of the content or appearance of this document is unlawful and offenders may be prosecuted to the fullest extent of the law.

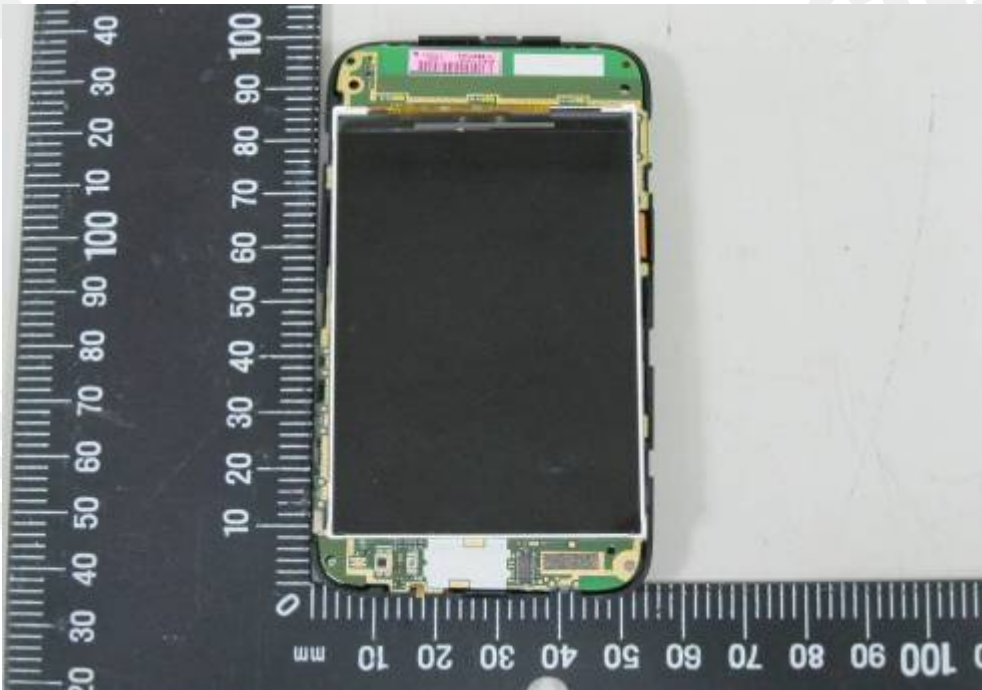
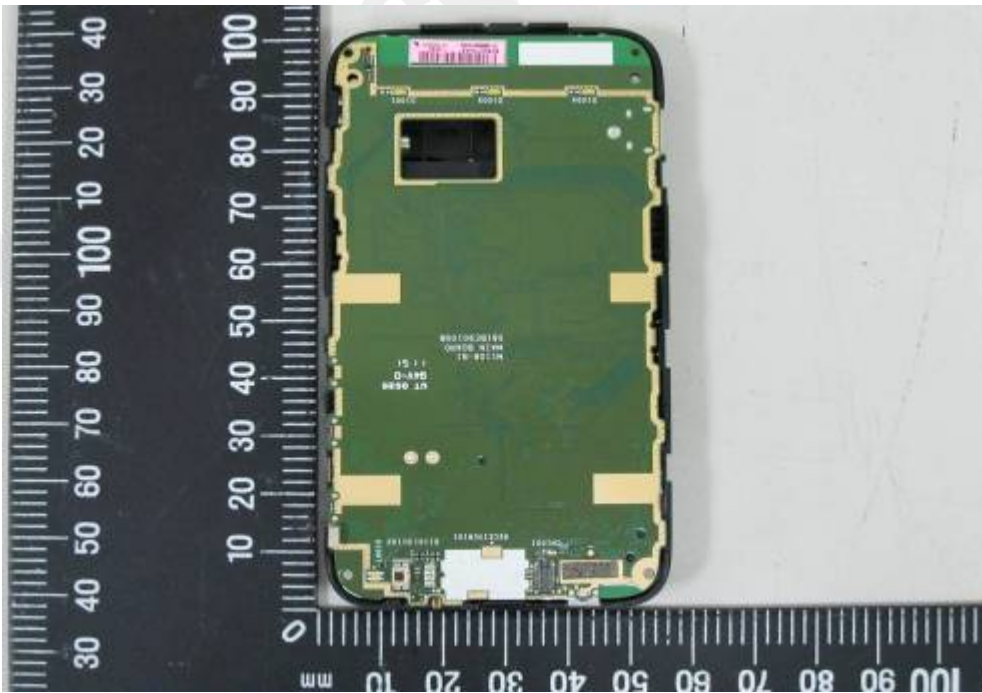

Unless otherwise stated the results shown in this test report refer only to the sample(s) tested and such sample(s) are retained for 90 days only.  
除非另有說明，此報告結果僅對測試之樣品負責，同時此樣品僅保留90天。本報告未經本公司書面許可，不可部份複製。

This document is issued by the Company subject to its General Conditions of Service printed overleaf, available on request or accessible at [www.sgs.com/terms\\_and\\_conditions.htm](http://www.sgs.com/terms_and_conditions.htm) and, for electronic format documents, subject to Terms and Conditions for Electronic Documents at [www.sgs.com/terms\\_e-document.htm](http://www.sgs.com/terms_e-document.htm). Attention is drawn to the limitation of liability, indemnification and jurisdiction issues defined therein. Any holder of this document is advised that information contained hereon reflects the Company's findings at the time of its intervention only and within the limits of Client's instructions, if any. The Company's sole responsibility is to its Client and this document does not exonerate parties to a transaction from exercising all their rights and obligations under the transaction documents. This document cannot be reproduced except in full, without prior written approval of the Company. Any unauthorized alteration, forgery or falsification of the content or appearance of this document is unlawful and offenders may be prosecuted to the fullest extent of the law.

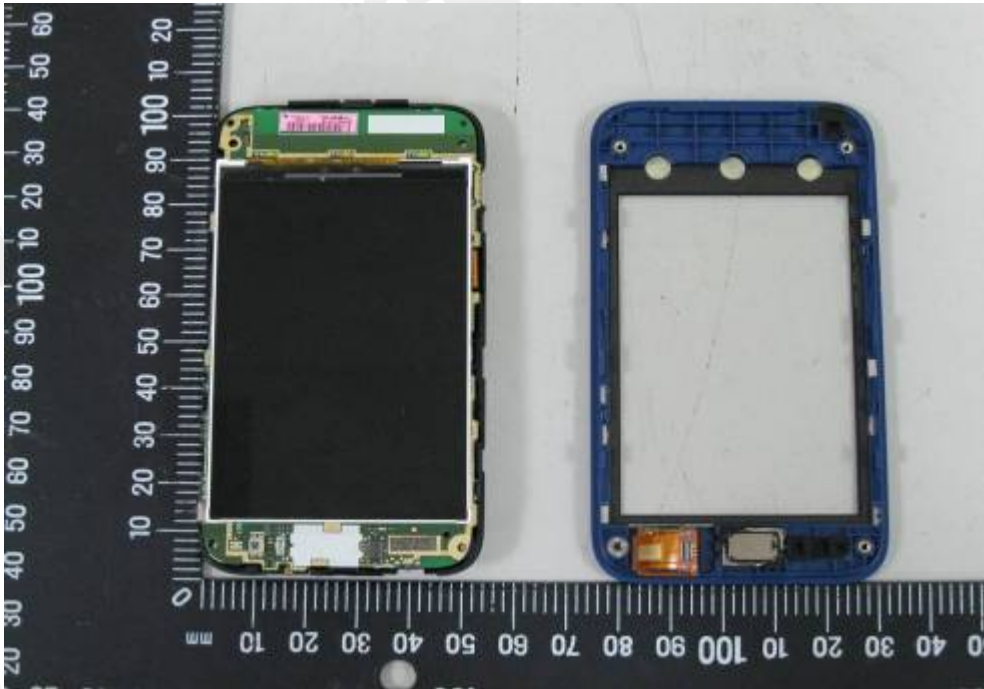

Unless otherwise stated the results shown in this test report refer only to the sample(s) tested and such sample(s) are retained for 90 days only.  
 除非另有說明，此報告結果僅對測試之樣品負責，同時此樣品僅保留90天。本報告未經本公司書面許可，不可部份複製。

This document is issued by the Company subject to its General Conditions of Service printed overleaf, available on request or accessible at [www.sgs.com/terms\\_and\\_conditions.htm](http://www.sgs.com/terms_and_conditions.htm) and, for electronic format documents, subject to Terms and Conditions for Electronic Documents at [www.sgs.com/terms\\_e-document.htm](http://www.sgs.com/terms_e-document.htm). Attention is drawn to the limitation of liability, indemnification and jurisdiction issues defined therein. Any holder of this document is advised that information contained hereon reflects the Company's findings at the time of its intervention only and within the limits of Client's instructions, if any. The Company's sole responsibility is to its Client and this document does not exonerate parties to a transaction from exercising all their rights and obligations under the transaction documents. This document cannot be reproduced except in full, without prior written approval of the Company. Any unauthorized alteration, forgery or falsification of the content or appearance of this document is unlawful and offenders may be prosecuted to the fullest extent of the law.



**\*\* End of Report \*\***

Unless otherwise stated the results shown in this test report refer only to the sample(s) tested and such sample(s) are retained for 90 days only.  
除非另有說明，此報告結果僅對測試之樣品負責，同時此樣品僅保留90天。本報告未經本公司書面許可，不可部份複製。

This document is issued by the Company subject to its General Conditions of Service printed overleaf, available on request or accessible at [www.sgs.com/terms\\_and\\_conditions.htm](http://www.sgs.com/terms_and_conditions.htm) and, for electronic format documents, subject to Terms and Conditions for Electronic Documents at [www.sgs.com/terms\\_e-document.htm](http://www.sgs.com/terms_e-document.htm). Attention is drawn to the limitation of liability, indemnification and jurisdiction issues defined therein. Any holder of this document is advised that information contained hereon reflects the Company's findings at the time of its intervention only and within the limits of Client's instructions, if any. The Company's sole responsibility is to its Client and this document does not exonerate parties to a transaction from exercising all their rights and obligations under the transaction documents. This document cannot be reproduced except in full, without prior written approval of the Company. Any unauthorized alteration, forgery or falsification of the content or appearance of this document is unlawful and offenders may be prosecuted to the fullest extent of the law.