

## TEST REPORT

Test report no.: 1-4254/12-50-04



Deutsche  
Akkreditierungsstelle  
D-PL-12076-01-01

### Testing laboratory

**CETECOM ICT Services GmbH**  
Untertuerkheimer Strasse 6 – 10  
66117 Saarbruecken / Germany  
Phone: + 49 681 5 98 - 0  
Fax: + 49 681 5 98 - 9075  
Internet: <http://www.cetecom.com>  
e-mail: [ict@cetecom.com](mailto:ict@cetecom.com)

**Accredited Testing Laboratory:**

The testing laboratory (area of testing) is accredited according to DIN EN ISO/IEC 17025 (2005) by the Deutsche Akkreditierungsstelle GmbH (DAkkS). The accreditation is valid for the scope of testing procedures as stated in the accreditation certificate with the registration number: D-PL-12076-01-01  
Area of Testing: Radio/Satellite Communications

### Applicant

**Sony Mobile Communications AB**  
Nya Vattentornet  
22188 Lund / SWEDEN  
Phone: +46 46 19 30 00  
Fax: +46 46 19 32 95  
Contact: Håkan Sjöberg  
e-mail: [hakan.sjoberg@sonymobile.com](mailto:hakan.sjoberg@sonymobile.com)  
Phone: +46 46 19 35 59

### Manufacturer

**Sony Mobile Communications AB**  
Nya Vattentornet  
22188 Lund / SWEDEN

### Test standard/s

47 CFR Part 22                      Title 47 of the Code of Federal Regulations; Chapter I  
Part 22 - Public mobile services

For further applied test standards please refer to section 3 of this test report.

### Test Item

**Kind of test item:** GSM Mobile Phone GPRS/EGPRS 850/900/1800/1900; UMTS HSPA FDDI/V/VIII; LTE FDD 1/3/5/7/20; WLAN a/b/g/n; BT 3.1; RFID; FM Rx; A-GPS  
**Model name:** PM-0060-BV  
**FCC ID:** PY7PM-0060  
**IC:** -/-  
**Frequency:** LTE Band V; 824 MHz to 849 MHz  
**Technology tested:** LTE  
**Antenna:** Integrated antenna  
**Power Supply:** 3.7 V DC by Li-polymer battery  
**Temperature Range:** -30°C to +60 °C

**Test report authorised:**

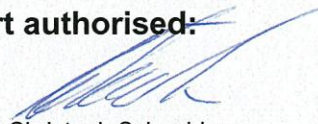

2012-10-01 Christoph Schneider

**Test performed:**

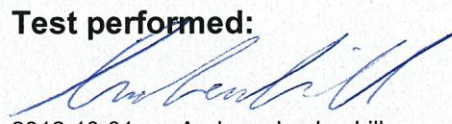

2012-10-01 Andreas Luckenbill

**1 Table of contents**

1 Table of contents .....2

2 General information .....3

    2.1 Notes and disclaimer .....3

    2.2 Application details.....3

3 Test standard/s .....3

4 Test environment.....4

5 Test item .....4

    5.1 Additional information .....4

6 Test laboratories sub-contracted .....4

7 Summary of measurement results .....5

    7.1 LTE band V .....5

8 RF measurements .....6

    8.1 Description of test setup .....6

        8.1.1 Radiated measurements.....6

        8.1.2 Conducted measurements.....7

    8.2 Results LTE band V .....8

        8.2.1 RF output power .....8

        8.2.2 Frequency stability.....11

        8.2.3 Spurious emissions radiated .....14

        8.2.4 Spurious emissions conducted .....19

        8.2.5 Block edge compliance .....35

        8.2.6 Occupied bandwidth .....44

9 Test equipment and ancillaries used for tests .....54

10 Observations .....54

Annex A Document history .....55

Annex B Further information.....55

Annex C Accreditation Certificate .....56

## 2 General information

### 2.1 Notes and disclaimer

The test results of this test report relate exclusively to the test item specified in this test report. CETECOM ICT Services GmbH does not assume responsibility for any conclusions and generalizations drawn from the test results with regard to other specimens or samples of the type of the equipment represented by the test item.

The test report may only be reproduced or published in full. Reproduction or publication of extracts from the report requires the prior written approval of CETECOM ICT Services GmbH.

The testing service provided by CETECOM ICT Services GmbH has been rendered under the current "General Terms and Conditions for CETECOM ICT Services GmbH".

CETECOM ICT Services GmbH will not be liable for any loss or damage resulting from false, inaccurate, inappropriate or incomplete product information provided by the customer.

Under no circumstances does the CETECOM ICT Services GmbH test report include any endorsement or warranty regarding the functionality, quality or performance of any other product or service provided.

Under no circumstances does the CETECOM ICT Services GmbH test report include or imply any product or service warranties from CETECOM ICT Services GmbH, including, without limitation, any implied warranties of merchantability, fitness for purpose, or non-infringement, all of which are expressly disclaimed by CETECOM ICT Services GmbH.

All rights and remedies regarding vendor's products and services for which CETECOM ICT Services GmbH has prepared this test report shall be provided by the party offering such products or services and not by CETECOM ICT Services GmbH.

In no case this test report can be considered as a Letter of Approval.

### 2.2 Application details

Date of receipt of order:	2012-09-05
Date of receipt of test item:	2012-09-05
Start of test:	2012-09-25
End of test:	2012-09-28
Person(s) present during the test:	-/-

## 3 Test standard/s

Test standard	Date	Test standard description
47 CFR Part 22	2010-10	Title 47 of the Code of Federal Regulations; Chapter I Part 22 - Public mobile services

#### 4 Test environment

Temperature:	$T_{nom}$	+22 °C during room temperature tests
	$T_{max}$	+60 °C during high temperature tests
	$T_{min}$	-30 °C during low temperature tests
Relative humidity content:		54 %
Barometric pressure:		not relevant for this kind of testing
Power supply:	$V_{nom}$	3.7 V DC by Li-polymer battery
	$V_{max}$	4.4 V
	$V_{min}$	3.3 V

#### 5 Test item

Kind of test item	:	GSM Mobile Phone GPRS/EGPRS 850/900/1800/1900; UMTS HSPA FDDI/V/VIII; LTE FDD 1/3/5/7/20; WLAN a/b/g/n; BT 3.1; RFID; FM Rx; A-GPS
Type identification	:	PM-0060-BV
S/N serial number	:	Rad. CB5A1KT6BM, CB5A1KT6BW Cond. CB5A1KT6B1, CB5A1KTGW4
HW hardware status	:	AP1.1
SW software status	:	9.0.D.0.164, s_atp_tsubasa_2_0_s
Frequency band [MHz]	:	LTE Band V; 824 MHz to 849 MHz
Type of modulation	:	QPSK, 16-QAM
Antenna	:	Integrated antenna
Power supply	:	3.7 V DC by Li-polymer battery
Temperature range	:	-30°C to +60 °C

#### 5.1 Additional information

Test setup- and EUT-photos are included in test report 1-4254/12-50-03

#### 6 Test laboratories sub-contracted

None

## 7 Summary of measurement results

- No deviations from the technical specifications were ascertained
- There were deviations from the technical specifications ascertained

TC identifier	Description	verdict	date	Remark
RF-Testing	CFR Part 22	passed	2012-10-01	-/-

### 7.1 LTE band V

Test Case	temperature conditions	power source voltages	Pass	Fail	NA	NP	Remark
RF Output Power	Nominal	Nominal	<input checked="" type="checkbox"/>	<input type="checkbox"/>	<input type="checkbox"/>	<input type="checkbox"/>	-/-
Frequency Stability	Nominal	Nominal	<input checked="" type="checkbox"/>	<input type="checkbox"/>	<input type="checkbox"/>	<input type="checkbox"/>	-/-
Spurious Emissions Radiated	Nominal	Nominal	<input checked="" type="checkbox"/>	<input type="checkbox"/>	<input type="checkbox"/>	<input type="checkbox"/>	-/-
Spurious Emissions Conducted	Nominal	Nominal	<input checked="" type="checkbox"/>	<input type="checkbox"/>	<input type="checkbox"/>	<input type="checkbox"/>	-/-
Block Edge Compliance	Nominal	Nominal	<input checked="" type="checkbox"/>	<input type="checkbox"/>	<input type="checkbox"/>	<input type="checkbox"/>	-/-
Occupied Bandwidth	Nominal	Nominal	<input checked="" type="checkbox"/>	<input type="checkbox"/>	<input type="checkbox"/>	<input type="checkbox"/>	-/-

**Note:** NA = Not applicable; NP = Not performed

## 8 RF measurements

### 8.1 Description of test setup

For the spurious measurements we use the substitution method according TIA/EIA 603.

#### 8.1.1 Radiated measurements

The radiated emissions from the EUT are performed in a semi anechoic chamber. The EUT is placed on a conductive turntable and powered with nominal voltage. The signalling is performed either from outside the chamber with a signalling unit (AP or other) by air link using a signalling antenna or directly by special test software from the customer.

Semi anechoic chamber

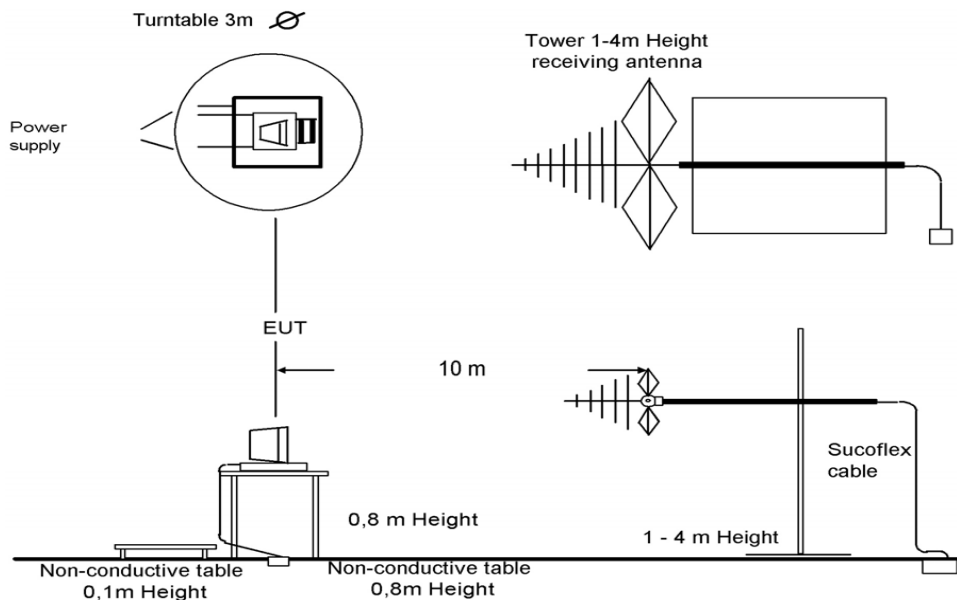

Picture 1: Diagram radiated measurements

9 kHz - 30 MHz:	active loop antenna
30 MHz – 1 GHz:	tri-log antenna
> 1 GHz:	horn antenna

### 8.1.2 Conducted measurements

The EUT's RF signal is coupled out by the antenna connector which is supplied by the manufacturer. The signal is first 10dB attenuated before it is power divided (~6dB loss per branch). One of the signal paths is connected to the signalling unit (AP or other), the other one is connected to the spectrum analyzer. The specific losses for both signal paths are first checked within a calibration. The measurement readings on the signalling unit/spectrum analyzer are corrected by the specific test set-up loss. The attenuator, power divider, signalling unit and the spectrum analyzer are impedance matched on 50 Ohm. If special software is used, there is no power divider necessary.

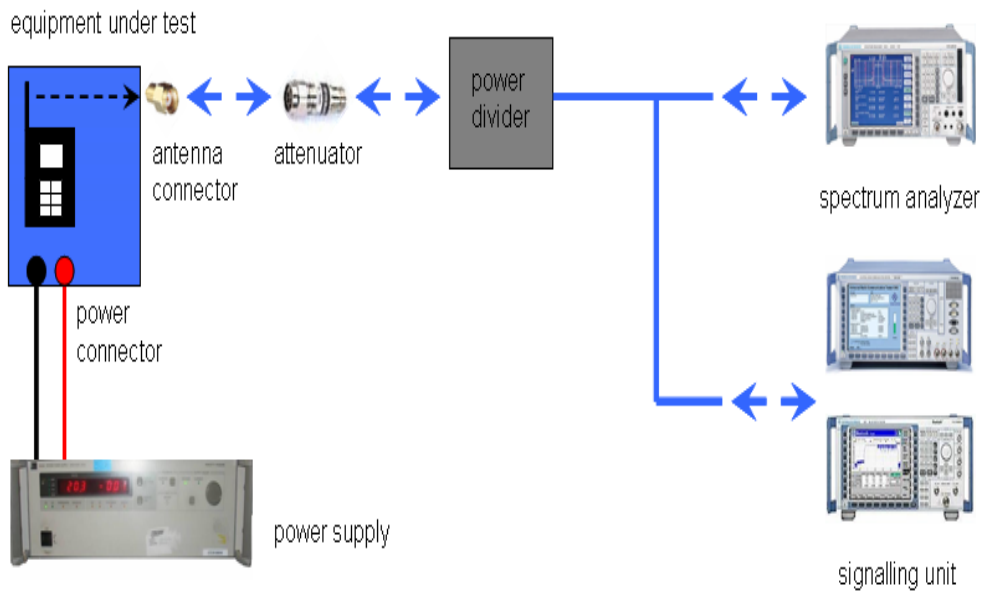

Picture 2: Diagram conducted measurements

The term measuring receiver refers to either a selective voltmeter or a spectrum analyser.

Frequency being measured f	Measuring receiver bandwidth 6 dB	Spectrum analyser bandwidth 3dB
$f < 150 \text{ kHz}$	200 Hz or	300 Hz
$150 \text{ kHz} \leq f < 25 \text{ MHz}$	9 kHz or	10 kHz
$25 \text{ MHz} \leq f < 1000 \text{ MHz}$	120 kHz or	100 kHz
$1000 \text{ MHz} \leq f$		1 MHz
NOTE: Specific requirements in CEPT/ERC/Recommendation 70-03 [2] shall be applied where applicable.		

## 8.2 Results LTE band V

The EUT was set to transmit the maximum power.

### 8.2.1 RF output power

**Description:**

This paragraph contains average power, peak output power and ERP measurements for the mobile station. In all cases, the peak output power is within the required mask (this mask is specified in the JTC standards, TIA PN3389 Vol. 1 Chap 7, and is no FCC requirement).

**Measurement:**

The mobile was set up for the maximum output power with pseudo random data modulation.

To determine the Peak-To-Average Power Ratio (PAPR) the measurement was performed with the Power Complementary Cumulative Distribution Function (CCDF).

Measurement parameters
Measured with CMW500

**Limits:**

FCC	IC
CFR Part 22.913 CFR Part 2.1046	-/-
Nominal Peak Output Power	
+38.45 dBm	
In measuring transmissions in this band using an average power technique, the peak-to-average ratio (PAR) of the transmission may not exceed 13 dB.	



**Results:**

Output Power (conducted)						
Bandwidth (MHz)	Frequency (MHz)	Resource block allocation	Average Output Power (dBm) QPSK	Peak to Average Ratio (dB)	Average Output Power (dBm) 16-QAM	Peak to Average Ratio (dB)
1.4	824.7	1 RB low	23.9	4.3	23.2	5.5
		1 RB high	24.0	4.3	23.4	5.6
		50% RB mid	23.1	5.2	23.0	5.5
		100% RB	23.0	5.4	22.0	6.6
	836.5	1 RB low	24.1	4.4	23.5	4.9
		1 RB high	24.0	4.4	23.4	4.9
		50% RB mid	23.2	5.7	23.2	5.7
		100% RB	23.2	5.5	22.3	5.9
	848.3	1 RB low	24.0	4.6	23.3	5.3
		1 RB high	24.0	4.6	23.3	5.2
		50% RB mid	23.0	5.8	23.1	5.7
		100% RB	23.0	5.7	22.1	6.2
3	825.5	1 RB low	24.1	4.8	22.8	5.5
		1 RB high	24.1	4.8	23.0	5.5
		50% RB mid	23.9	4.6	24.0	4.5
		100% RB	23.1	5.6	22.0	6.6
	836.5	1 RB low	24.1	4.6	23.2	5.3
		1 RB high	24.1	4.6	23.2	5.3
		50% RB mid	24.1	4.5	24.2	4.4
		100% RB	23.1	5.7	22.2	6.6
	847.5	1 RB low	24.1	4.7	22.9	5.6
		1 RB high	24.1	4.5	22.8	5.5
		50% RB mid	23.9	4.9	24.1	4.8
		100% RB	23.1	6.0	22.0	6.6
5	826.5	1 RB low	24.0	4.6	23.3	5.1
		1 RB high	23.9	4.7	23.2	5.2
		50% RB mid	21.9	6.6	21.9	6.6
		100% RB	22.8	5.8	21.9	6.7
	836.5	1 RB low	24.2	4.5	22.9	5.5
		1 RB high	24.2	4.5	22.8	5.5
		50% RB mid	21.9	6.7	22.0	6.7
		100% RB	23.0	5.7	22.0	7.1
	846.5	1 RB low	23.9	4.5	23.4	5.6
		1 RB high	23.9	4.4	23.2	5.5
		50% RB mid	21.9	6.6	22.0	6.7
		100% RB	22.9	6.0	21.9	6.7

10	829	1 RB low	24.2	4.7	23.3	5.5
		1 RB high	24.2	4.5	23.3	5.4
		50% RB mid	22.7	6.1	22.6	6.7
		100% RB	22.6	6.3	21.8	6.9
	836.5	1 RB low	24.0	4.8	22.8	5.7
		1 RB high	24.1	4.8	22.9	5.6
		50% RB mid	22.7	6.2	22.7	6.7
		100% RB	22.7	6.3	21.7	7.1
	844	1 RB low	24.1	4.8	23.3	5.4
		1 RB high	23.8	4.8	23.1	5.4
		50% RB mid	22.7	6.4	22.7	6.3
		100% RB	23.8	4.8	21.7	5.8
Measurement uncertainty			± 0.5 dB			

The radiated output power was measured with the lowest supported channel bandwidth and with the maximum number of resource blocks.

All other bandwidths were calculated with the corresponding antenna gain (with full resource blocks).

Output Power (radiated)			
Bandwidth (MHz)	Frequency (MHz)	Average Output Power (dBm)	
		QPSK	16-QAM
1.4	824.7	21.0	20.0*)
	836.5	21.7	20.8*)
	848.3	22.8	21.9*)
3	825.5	21.1*)	20.0*)
	836.5	21.6*)	20.7*)
	847.5	22.9*)	21.8*)
5	826.5	20.8*)	19.9*)
	836.5	21.5*)	20.5*)
	846.5	22.7*)	21.7*)
10	829.0	20.6*)	19.8*)
	836.5	21.2*)	20.2*)
	844.0	23.6*)	21.5*)
Measurement uncertainty		± 3.0 dB	

\*) calculated with antenna gain

**Result: Passed**

### 8.2.2 Frequency stability

**Description:**

In order to measure the carrier frequency under the condition of AFC lock, it is necessary to make measurements with the mobile station in a “call mode”. This is accomplished with the use of a R&S CMW500 DIGITAL RADIOCOMMUNICATION TESTER.

1. Measure the carrier frequency at room temperature.
2. Subject the mobile station to overnight soak at -30 C.
3. With the mobile station, powered with  $V_{nom}$ , connected to the CMW500 and in a simulated call on channel 4180 (centre channel), measure the carrier frequency. These measurements should be made within two minutes of powering up the mobile station, to prevent significant self warming.
4. Repeat the above measurements at 10°C increments from -30°C to +60°C. Allow at least 1.5 hours at each temperature, unpowered, before making measurements.
5. Remeasure carrier frequency at room temperature with  $V_{nom}$ . Vary supply voltage from  $V_{min}$  to  $V_{max}$ , in 0.1 Volt steps remeasuring carrier frequency at each voltage. Pause at  $V_{nom}$  for 1.5 hours unpowered, to allow any self heating to stabilize, before continuing.
6. At all temperature levels hold the temperature to +/- 0.5°C during the measurement procedure.

**Measurement:**

Measurement parameters	
Detector:	Measured with CMW500
Sweep time:	
Video bandwidth:	
Resolution bandwidth:	
Span:	
Trace-Mode:	

**Limits:**

FCC	IC
CFR Part 22.355 CFR Part 2.1055	-/-
Frequency Stability	
± 0.1 ppm	

**Results:****AFC FREQ ERROR versus VOLTAGE**

Voltage (V)	Frequency Error (Hz)	Frequency Error (%)	Frequency Error (ppm)
3.3	5	0.00000060	0.0060
3.4	4	0.00000048	0.0048
3.5	6	0.00000072	0.0072
3.6	5	0.00000060	0.0060
3.7	5	0.00000060	0.0060
3.8	4	0.00000048	0.0048
3.9	4	0.00000048	0.0048
4.0	5	0.00000060	0.0060
4.1	-4	-0.00000048	-0.0048
4.2	4	0.00000048	0.0048
4.3	5	0.00000060	0.0060
4.4	4	0.00000048	0.0048

**AFC FREQ ERROR versus TEMPERATURE**

Temperature (°C)	Frequency Error (Hz)	Frequency Error (%)	Frequency Error (ppm)
-30	6	0.00000072	0.0072
-20	6	0.00000072	0.0072
-10	5	0.00000060	0.0060
± 0	4	0.00000048	0.0048
10	5	0.00000060	0.0060
20	5	0.00000060	0.0060
30	5	0.00000060	0.0060
40	-5	-0.00000060	-0.0060
50	5	0.00000060	0.0060
60	5	0.00000060	0.0060

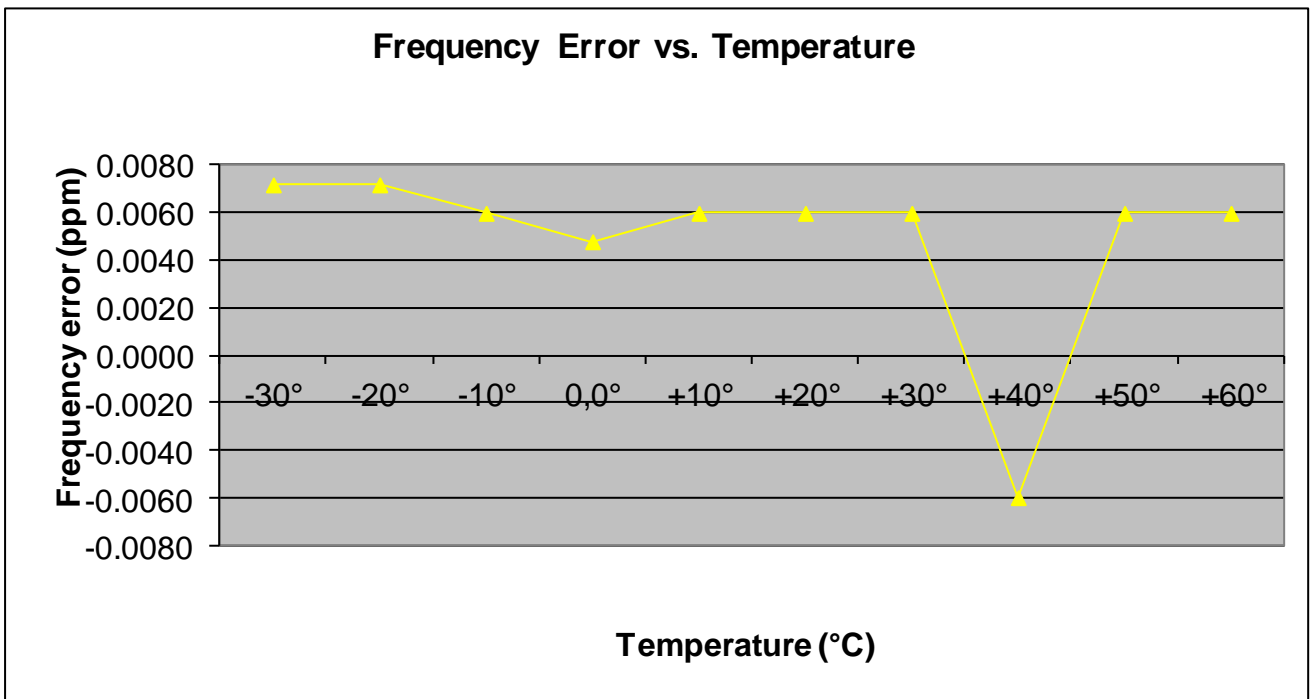
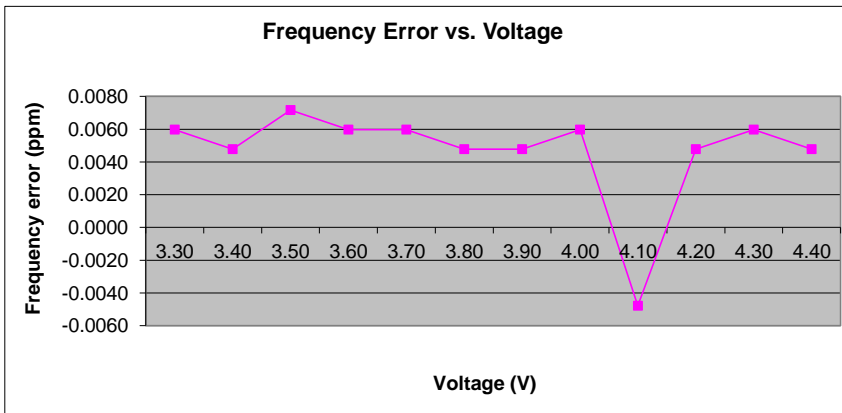

**Result:** Passed

### 8.2.3 Spurious emissions radiated

**Description:**

The following steps outline the procedure used to measure the radiated emissions from the mobile station. The site is constructed in accordance with ANSI C63.4:2009 requirements and is recognized by the FCC to be in compliance for a 3 and a 10 meter site. The spectrum was scanned from 30 MHz to the 10th harmonic of the highest frequency generated within the equipment, which is the transmitted carrier that can be as high as 846.6 MHz. This was rounded up to 12 GHz. The resolution bandwidth is set as outlined in Part 22.917. The spectrum was scanned with the mobile station transmitting at carrier frequencies that pertain to low, mid and high channels of the LTE band V.

The final open field emission (here 10m semi-anechoic chamber listed by FCC) test procedure is as follows:

- a) The test item was placed on a 0.8 meter high non-conductive stand at a 3 meter test distance from the receive antenna.
- b) The antenna output was terminated in a 50 ohm load (if possible).
- c) A double ridged wave guide antenna was placed on an adjustable height antenna mast 3 meters from the test item for emission measurements.
- d) Detected emissions were maximized at each frequency by rotating the test item and adjusting the receive antenna height and polarization. The maximum meter reading was recorded. The radiated emission measurements of the harmonics of the transmit frequency through the 10th harmonic were measured with peak detector and 1 MHz bandwidth. If the harmonic could not be detected above the noise floor, the ambient level was recorded. The equivalent power into a dipole antenna was calculated from the field intensity levels measured at 3 meters.
- e) Now each detected emissions were substituted by the substitution method, in accordance with the TIA/EIA 603.

**Measurement:**

Measurement parameters	
Detector:	Peak
Sweep time:	2 sec.
Video bandwidth:	Below 1 GHz: 100 kHz Above 1 GHz: 1 MHz
Resolution bandwidth:	Below 1 GHz: 100 kHz Above 1 GHz: 1 MHz
Span:	100 MHz Steps
Trace-Mode:	Max Hold

**Limits:**

FCC	IC
CFR Part 22.917 CFR Part 2.1053	-/-
Spurious Emissions Radiated	
Attenuation $\geq 43 + 10\log(P)$ (P, Power in Watts)	
-13 dBm	

**Results:**

Radiated emissions measurements were made only at the center carrier frequency of the LTE band V (836.5 MHz). It was decided that measurements at this carrier frequency would be sufficient to demonstrate compliance with emissions limits because it was seen that all the significant spurs occur well outside the band and no radiation was seen from a carrier in one block of the LTE band V into any of the other blocks. The equipment must still, however, meet emissions requirements with the carrier at all frequencies over which it is capable of operating and it is the manufacturer's responsibility to verify this.

The final open field radiated levels are presented on the next pages. All measurements were done in horizontal and vertical polarization; the plots show the worst case. The plots show only the middle channel. If spurious were detected, the lowest and highest channel were checked too. The found values are stated in the table below.

As can be seen from this data, the emissions from the test item were within the specification limit.

**QPSK:**

SPURIOUS EMISSION LEVEL (dBm)								
Harmonic	Lowest channel Freq. (MHz)	Level [dBm]	Harmonic	Middle channel Freq. (MHz)	Level [dBm]	Harmonic	Highest channel Freq. (MHz)	Level [dBm]
2	1658.0	-	2	1673.0	-	2	1688.0	-
3	2487.0	-	3	2509.5	-	3	2532.0	-
4	3316.0	-	4	3346.0	-	4	3376.0	-
5	4145.0	-	5	4182.5	-	5	4220.0	-
6	4974.0	-	6	5019.0	-	6	5064.0	-
7	5803.0	-	7	5855.5	-	7	5908.0	-
8	6632.0	-	8	6692.0	-	8	6752.0	-
9	7461.0	-	9	7528.5	-	9	7596.0	-
10	8290.0	-	10	8365.0	-	10	8440.0	-
Measurement uncertainty					± 3dB			

**16-QAM:**

SPURIOUS EMISSION LEVEL (dBm)								
Harmonic	Lowest channel Freq. (MHz)	Level [dBm]	Harmonic	Middle channel Freq. (MHz)	Level [dBm]	Harmonic	Highest channel Freq. (MHz)	Level [dBm]
2	1658.0	-	2	1673.0	-	2	1688.0	-
3	2487.0	-	3	2509.5	-	3	2532.0	-
4	3316.0	-	4	3346.0	-	4	3376.0	-
5	4145.0	-	5	4182.5	-	5	4220.0	-
6	4974.0	-	6	5019.0	-	6	5064.0	-
7	5803.0	-	7	5855.5	-	7	5908.0	-
8	6632.0	-	8	6692.0	-	8	6752.0	-
9	7461.0	-	9	7528.5	-	9	7596.0	-
10	8290.0	-	10	8365.0	-	10	8440.0	-
Measurement uncertainty					± 3dB			

**Result: Passed**



**QPSK with 10 MHz channel bandwidth**

**Plot 1: Channel 20525 (Traffic mode up to 30 MHz)**

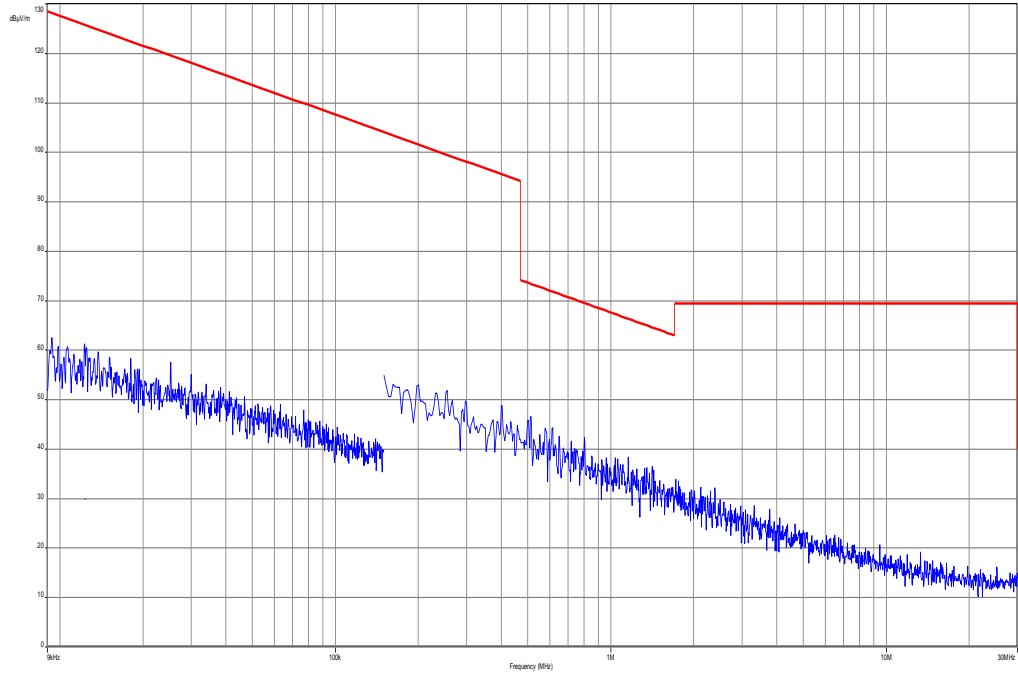

**Plot 2: Channel 20525 (30 MHz – 12.75 GHz)**

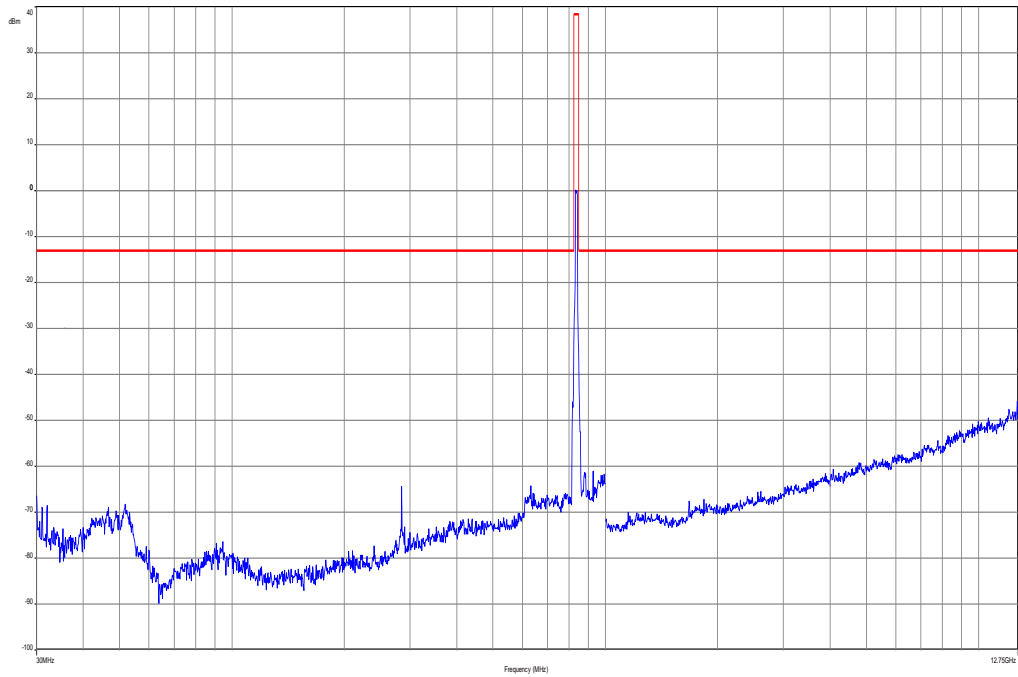

**16-QAM with 10 MHz channel bandwidth**

**Plot 3: Channel 20525 (Traffic mode up to 30 MHz)**

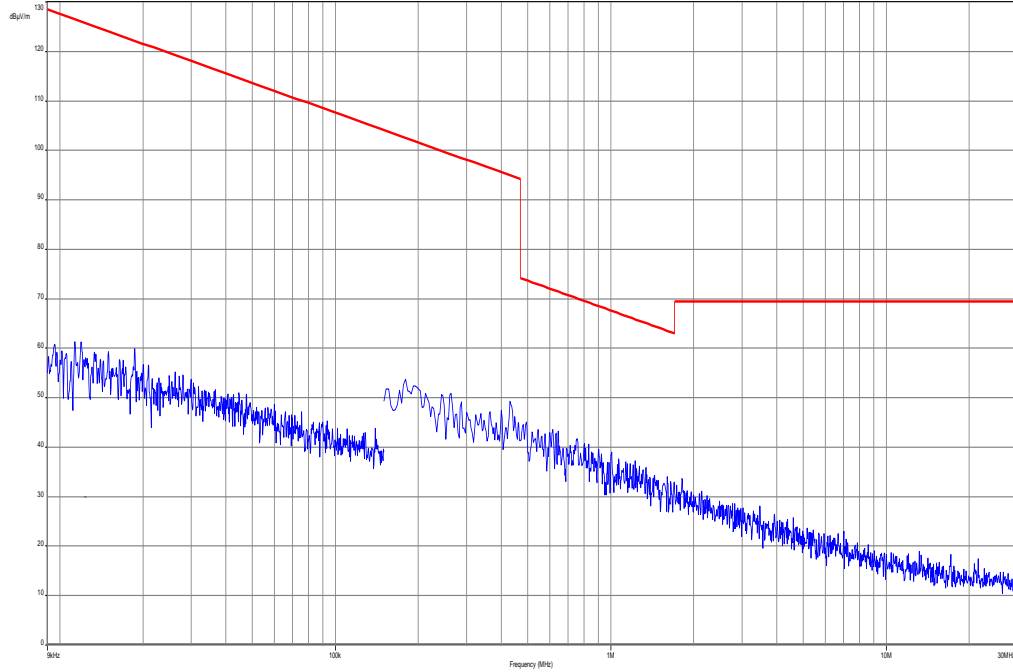

**Plot 4: Channel 20525 (30 MHz – 12.75 GHz)**

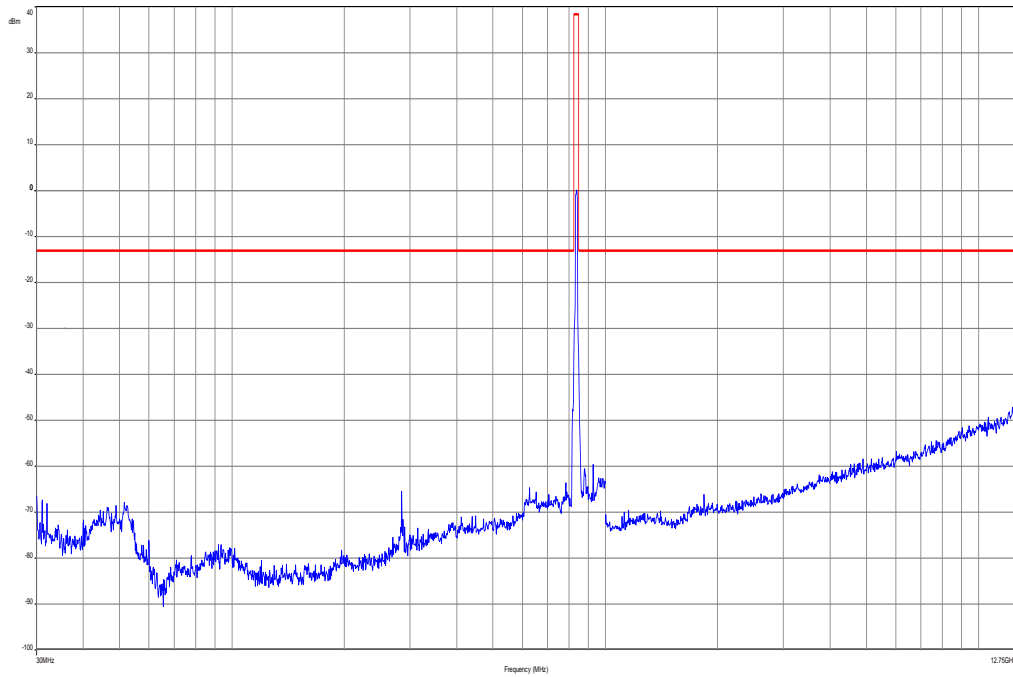

## 8.2.4 Spurious emissions conducted

### Description:

The following steps outline the procedure used to measure the conducted emissions from the mobile station.

1. Determine frequency range for measurements: From CFR 2.1057 the spectrum should be investigated from the lowest radio frequency generated in the equipment up to at least the 10th harmonic of the carrier frequency. For the mobile station equipment tested, this equates to a frequency range of 13 MHz to 9 GHz, data taken from 10 MHz to 25 GHz.

2. Determine mobile station transmits frequencies: below outlines the band edge frequencies pertinent to conducted emissions testing.

### Measurement:

Measurement parameters	
Detector:	Peak
Sweep time:	Auto
Video bandwidth:	Pre-measurement with 1 MHz On spurious detection re-measurement below 1 GHz with 100 kHz Above 1 GHz with 1 MHz
Resolution bandwidth:	Pre-measurement with 1 MHz On spurious detection re-measurement below 1 GHz with 100 kHz Above 1 GHz with 1 MHz
Span:	10 MHz – 25 GHz
Trace-Mode:	Max Hold

### Limits:

FCC	IC
CFR Part 22.917 CFR Part 2.1051	-/-
Spurious Emissions Conducted	
Attenuation $\geq 43 + 10\log(P)$ (P, Power in Watts)	
-13 dBm	

**Results:** for 1.4 MHz channel bandwidth**QPSK**

SPURIOUS EMISSION LEVEL (dBm)								
Harmonic	Lowest channel Freq. (MHz)	Level [dBm]	Harmonic	Middle channel Freq. (MHz)	Level [dBm]	Harmonic	Highest channel Freq. (MHz)	Level [dBm]
2	1649.4	-	2	1673.0	-	2	1696,6	-
3	2474.1	-	3	2509.5	-	3	2544,9	-
4	3298.8	-	4	3346.0	-	4	3393,2	-
5	4123.5	-	5	4182.5	-	5	4241,5	-
6	4948.2	-	6	5019.0	-	6	5089,8	-
7	5772.9	-	7	5855.5	-	7	5938,1	-
8	6597.6	-	8	6692.0	-	8	6786,4	-
9	7422.3	-	9	7258.5	-	9	7634,7	-
10	8247.0	-	10	8365.0	-	10	8483	-
Measurement uncertainty					± 0.5dB			

**16-QAM**

SPURIOUS EMISSION LEVEL (dBm)								
Harmonic	Lowest channel Freq. (MHz)	Level [dBm]	Harmonic	Middle channel Freq. (MHz)	Level [dBm]	Harmonic	Highest channel Freq. (MHz)	Level [dBm]
2	1649.4	-	2	1673.0	-	2	1696.6	-
3	2474.1	-	3	2509.5	-	3	2544.9	-
4	3298.8	-	4	3346.0	-	4	3393.2	-
5	4123.5	-	5	4182.5	-	5	4241.5	-
6	4948.2	-	6	5019.0	-	6	5089.8	-
7	5772.9	-	7	5855.5	-	7	5938.1	-
8	6597.6	-	8	6692.0	-	8	6786.4	-
9	7422.3	-	9	7258.5	-	9	7634.7	-
10	8247.0	-	10	8365.0	-	10	8483.0	-
Measurement uncertainty					± 0.5dB			

**Results: for 5 MHz channel bandwidth**

**QPSK**

SPURIOUS EMISSION LEVEL (dBm)								
Harmonic	Lowest channel Freq. (MHz)	Level [dBm]	Harmonic	Middle channel Freq. (MHz)	Level [dBm]	Harmonic	Highest channel Freq. (MHz)	Level [dBm]
2	1653.0	-	2	1673.0	-	2	1693.0	-
3	2479.5	-	3	2509.5	-	3	2539.5	-
4	3306.0	-	4	3346.0	-	4	3386.0	-
5	4132.5	-	5	4182.5	-	5	4232.5	-
6	4959.0	-	6	5019.0	-	6	5079.0	-
7	5785.5	-	7	5855.5	-	7	5925.5	-
8	6612.0	-	8	6692.0	-	8	6772.0	-
9	7438.5	-	9	7528.5	-	9	7618.5	-
10	8265.0	-	10	8365.0	-	10	8465.0	-
Measurement uncertainty					± 0.5dB			

**16-QAM**

SPURIOUS EMISSION LEVEL (dBm)								
Harmonic	Lowest channel Freq. (MHz)	Level [dBm]	Harmonic	Middle channel Freq. (MHz)	Level [dBm]	Harmonic	Highest channel Freq. (MHz)	Level [dBm]
2	1653.0	-	2	1673.0	-	2	1693.0	-
3	2479.5	-	3	2509.5	-	3	2539.5	-
4	3306.0	-	4	3346.0	-	4	3386.0	-
5	4132.5	-	5	4182.5	-	5	4232.5	-
6	4959.0	-	6	5019.0	-	6	5079.0	-
7	5785.5	-	7	5855.5	-	7	5925.5	-
8	6612.0	-	8	6692.0	-	8	6772.0	-
9	7438.5	-	9	7528.5	-	9	7618.5	-
10	8265.0	-	10	8365.0	-	10	8465.0	-
Measurement uncertainty					± 0.5dB			

**Results:** for 10 MHz channel bandwidth

**QPSK**

SPURIOUS EMISSION LEVEL (dBm)								
Harmonic	Lowest channel Freq. (MHz)	Level [dBm]	Harmonic	Middle channel Freq. (MHz)	Level [dBm]	Harmonic	Highest channel Freq. (MHz)	Level [dBm]
2	1658.0	-	2	1673.0	-	2	1688.0	-
3	2487.0	-	3	2509.5	-	3	2532.0	-
4	3316.0	-	4	3346.0	-	4	3376.0	-
5	4145.0	-	5	4182.5	-	5	4220.0	-
6	4974.0	-	6	5019.0	-	6	5064.0	-
7	5803.0	-	7	5855.5	-	7	5908.0	-
8	6632.0	-	8	6692.0	-	8	6752.0	-
9	7461.0	-	9	7528.5	-	9	7596.0	-
10	8290.0	-	10	8365.0	-	10	8440.0	-
Measurement uncertainty					± 0.5dB			

**16-QAM**

SPURIOUS EMISSION LEVEL (dBm)								
Harmonic	Lowest channel Freq. (MHz)	Level [dBm]	Harmonic	Middle channel Freq. (MHz)	Level [dBm]	Harmonic	Highest channel Freq. (MHz)	Level [dBm]
2	1658.0	-	2	1673.0	-	2	1688.0	-
3	2487.0	-	3	2509.5	-	3	2532.0	-
4	3316.0	-	4	3346.0	-	4	3376.0	-
5	4145.0	-	5	4182.5	-	5	4220.0	-
6	4974.0	-	6	5019.0	-	6	5064.0	-
7	5803.0	-	7	5855.5	-	7	5908.0	-
8	6632.0	-	8	6692.0	-	8	6752.0	-
9	7461.0	-	9	7528.5	-	9	7596.0	-
10	8290.0	-	10	8365.0	-	10	8440.0	-
Measurement uncertainty					± 0.5dB			

**Result:** Passed

**Plots: QPSK with 1.4 MHz channel bandwidth**

**Plot 1: Lowest Channel (10 MHz - 25 GHz)**

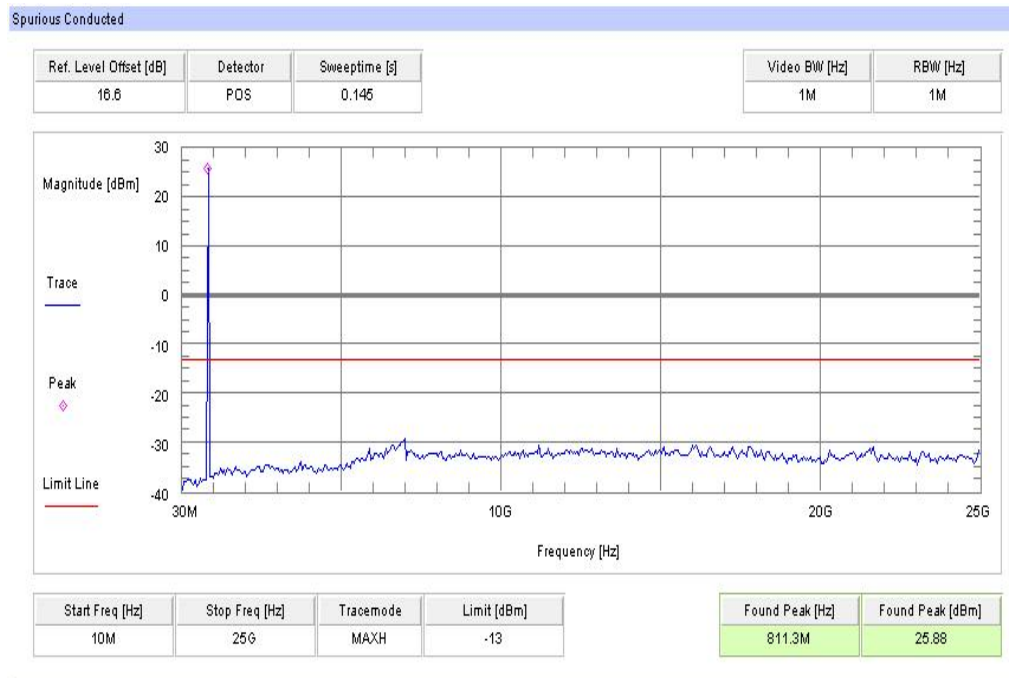

**Plot 2: Middle Channel (10 MHz - 25 GHz)**

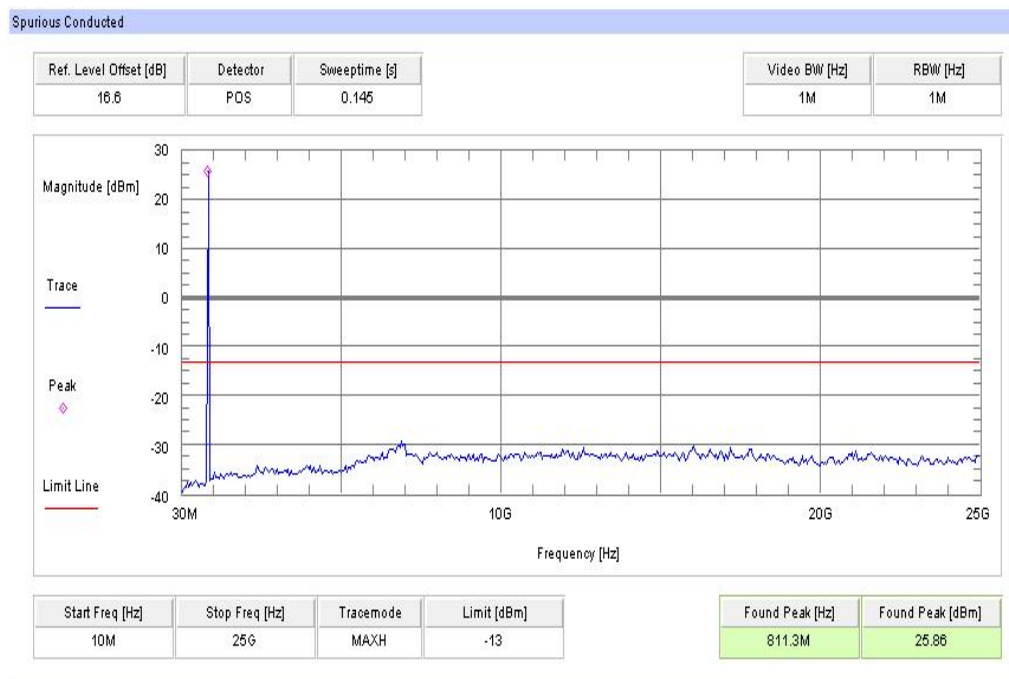

Plot 3: Highest Channel (10 MHz - 25 GHz)

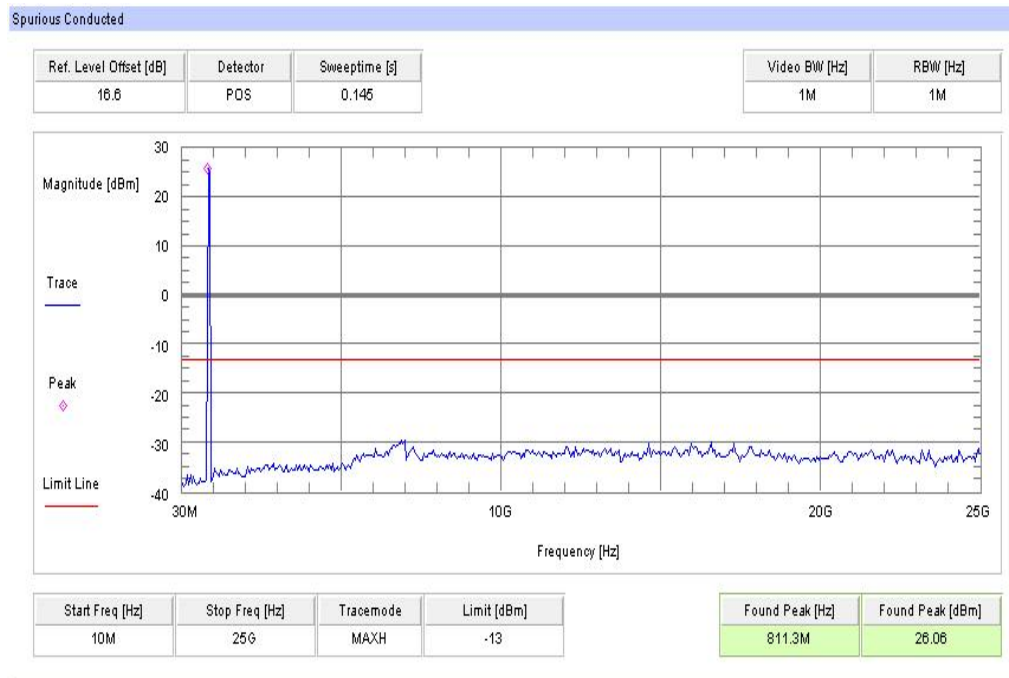



**Plots: 16-QAM with 1.4 MHz channel bandwidth**

**Plot 4: Lowest Channel (10 MHz - 25 GHz)**

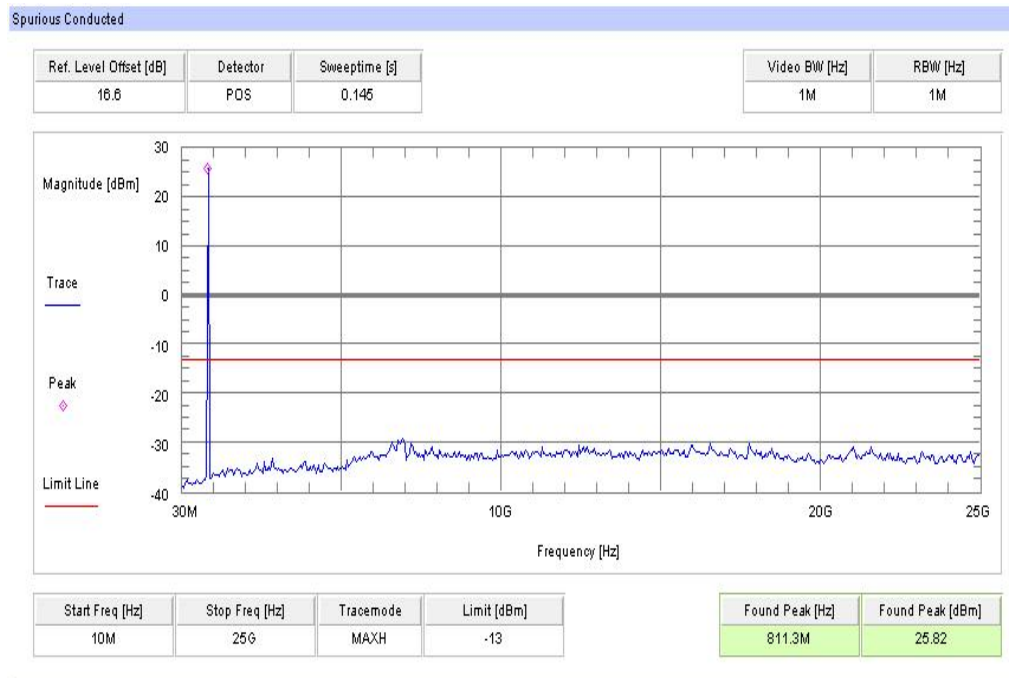

**Plot 5: Middle Channel (10 MHz - 25 GHz)**

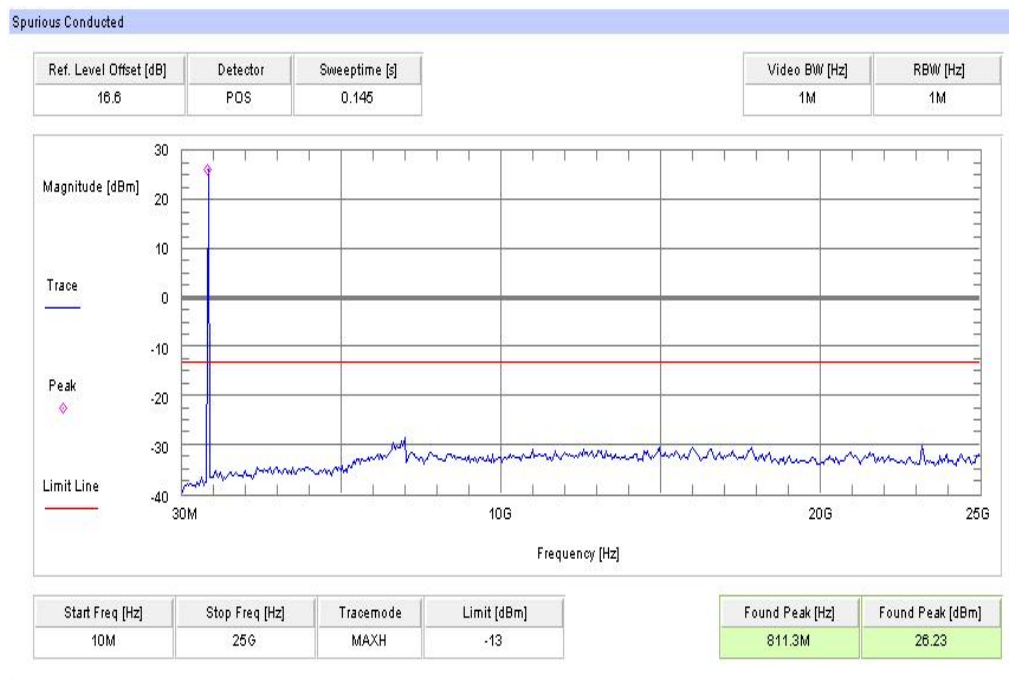

**Plot 6: Highest Channel (10 MHz - 25 GHz)**

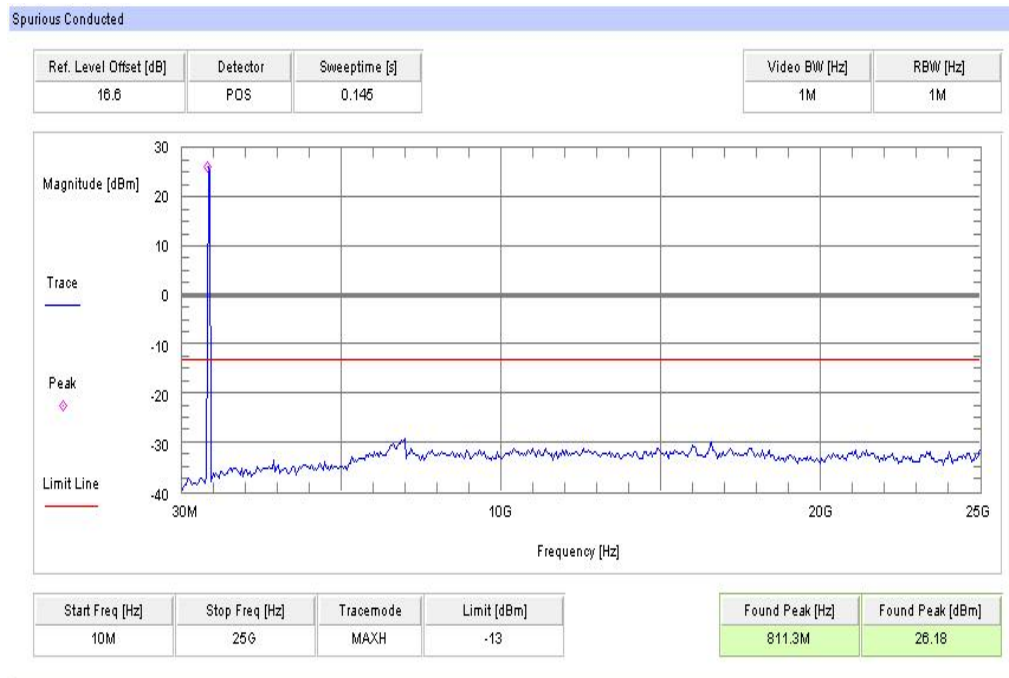

**Plots: QPSK with 5 MHz channel bandwidth**

**Plot 1: Lowest Channel (10 MHz - 25 GHz)**

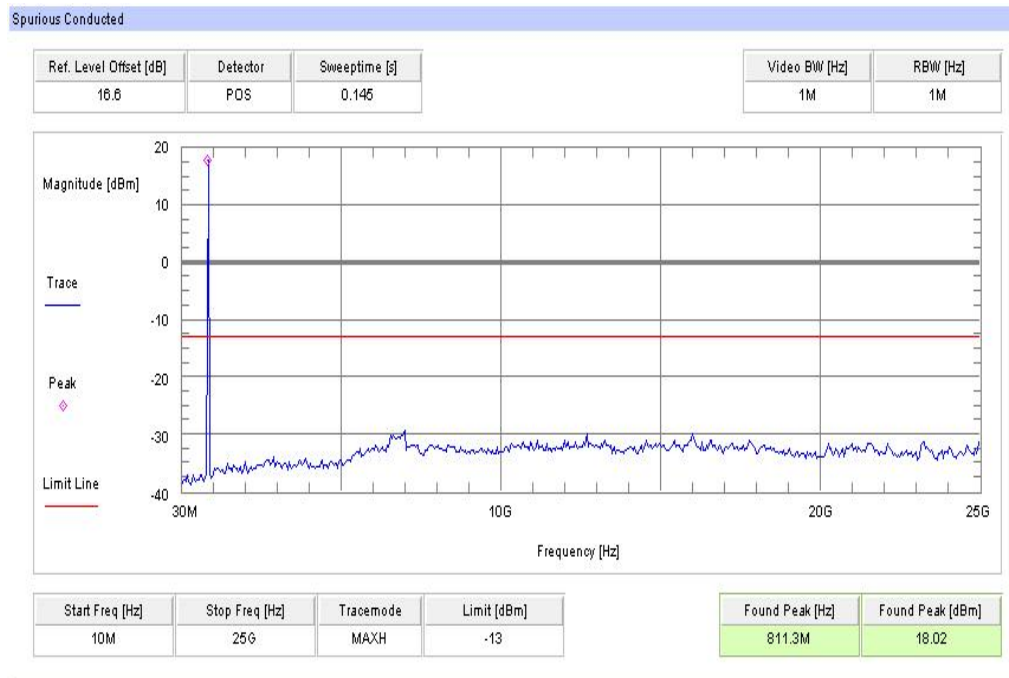

**Plot 2: Middle Channel (10 MHz - 25 GHz)**

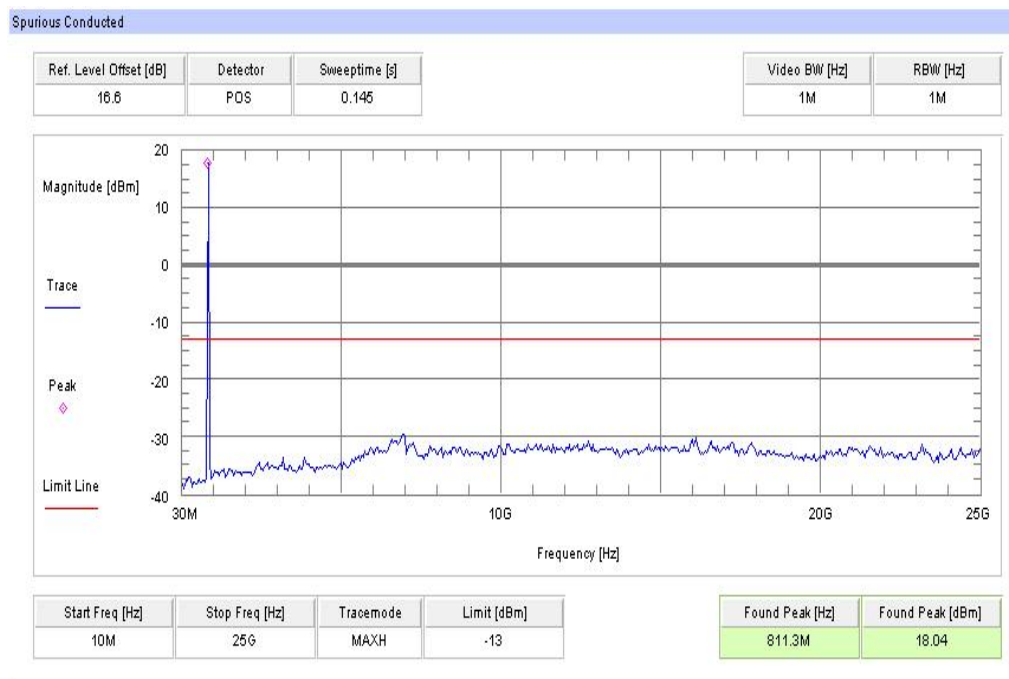

**Plot 3: Highest Channel (10 MHz - 25 GHz)**

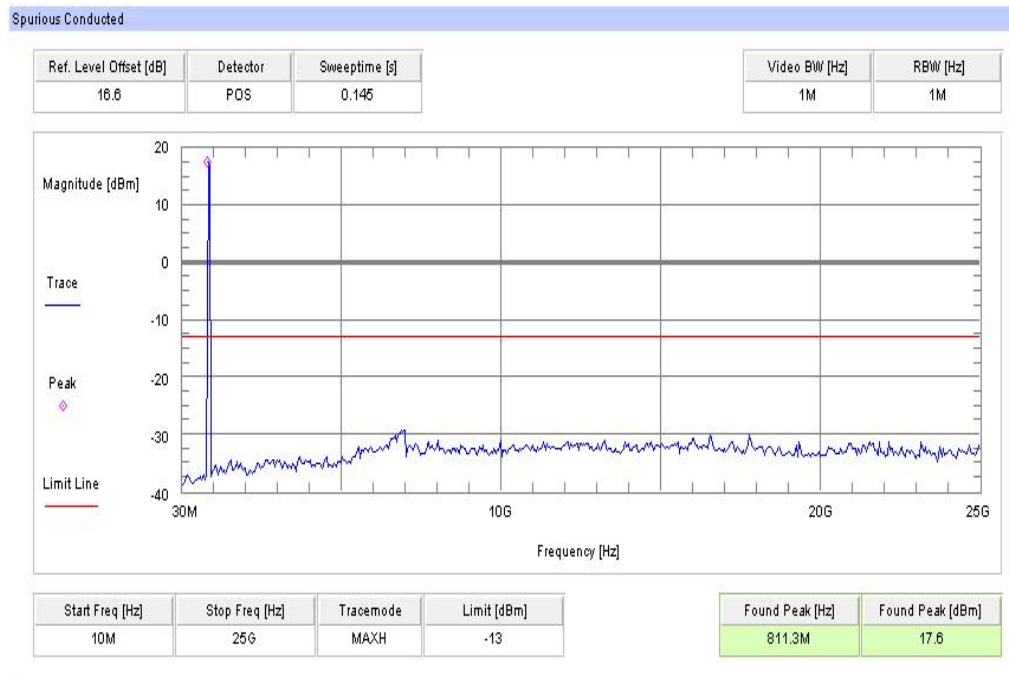

**Plots: 16-QAM with 5 MHz channel bandwidth**

**Plot 4: Lowest Channel (10 MHz - 25 GHz)**

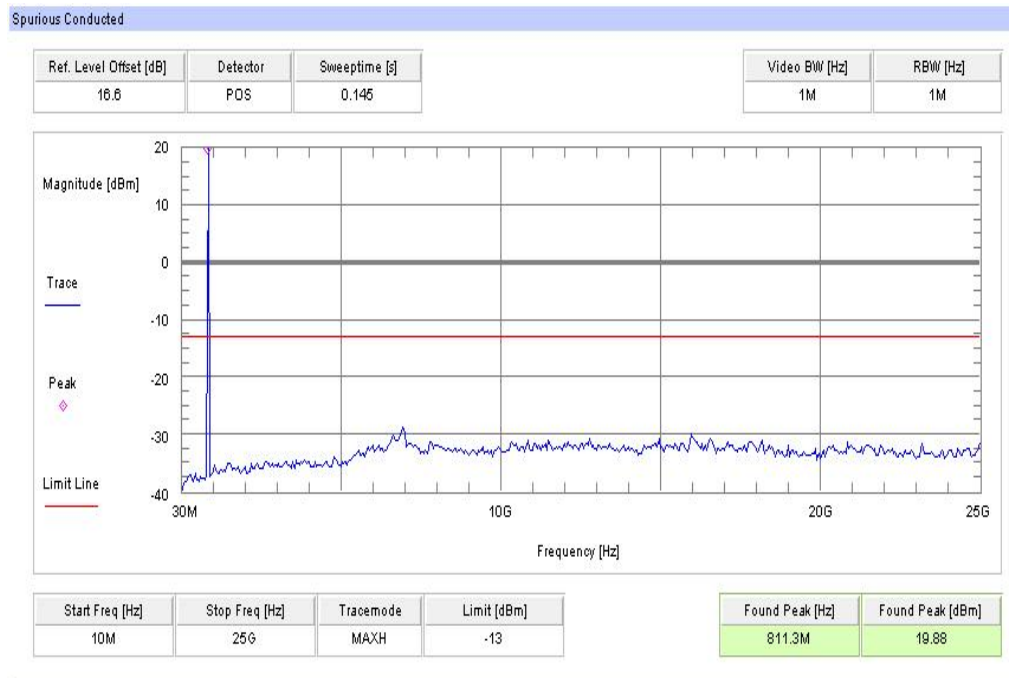

**Plot 5: Middle Channel (10 MHz - 25 GHz)**

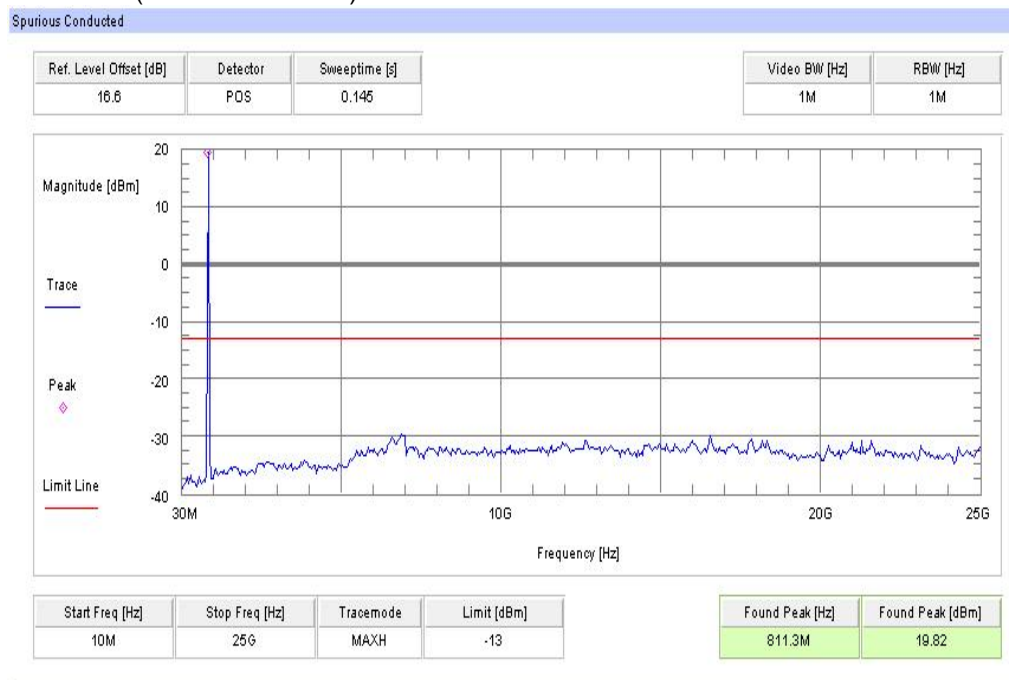

**Plot 6: Highest Channel (10 MHz - 25 GHz)**

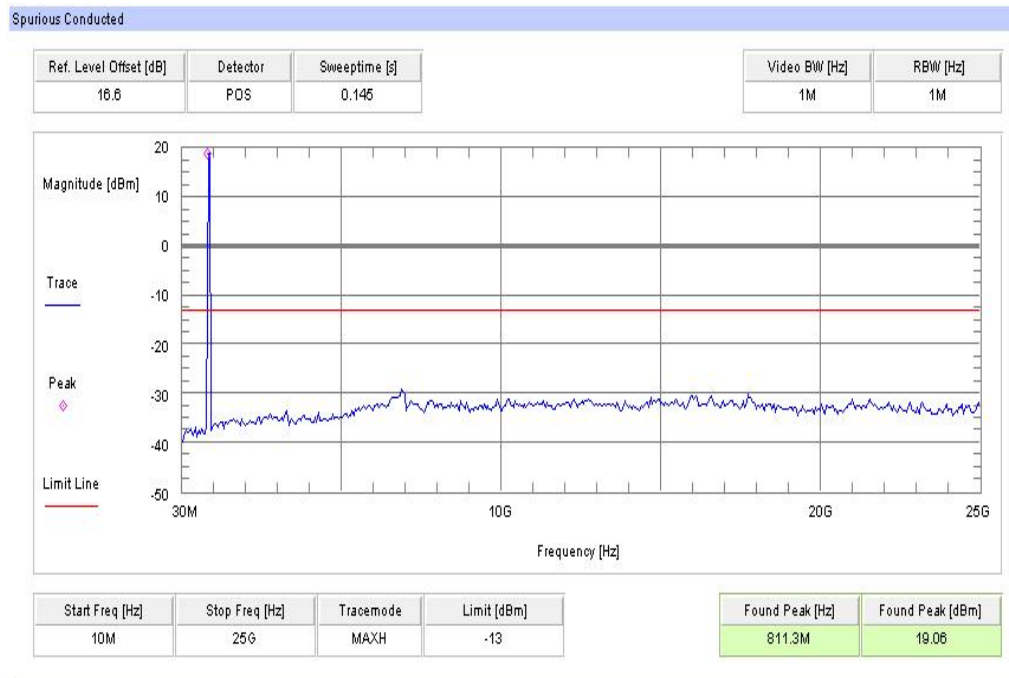

**Plots: QPSK with 10 MHz channel bandwidth**

**Plot 1: Lowest Channel (10 MHz - 25 GHz)**

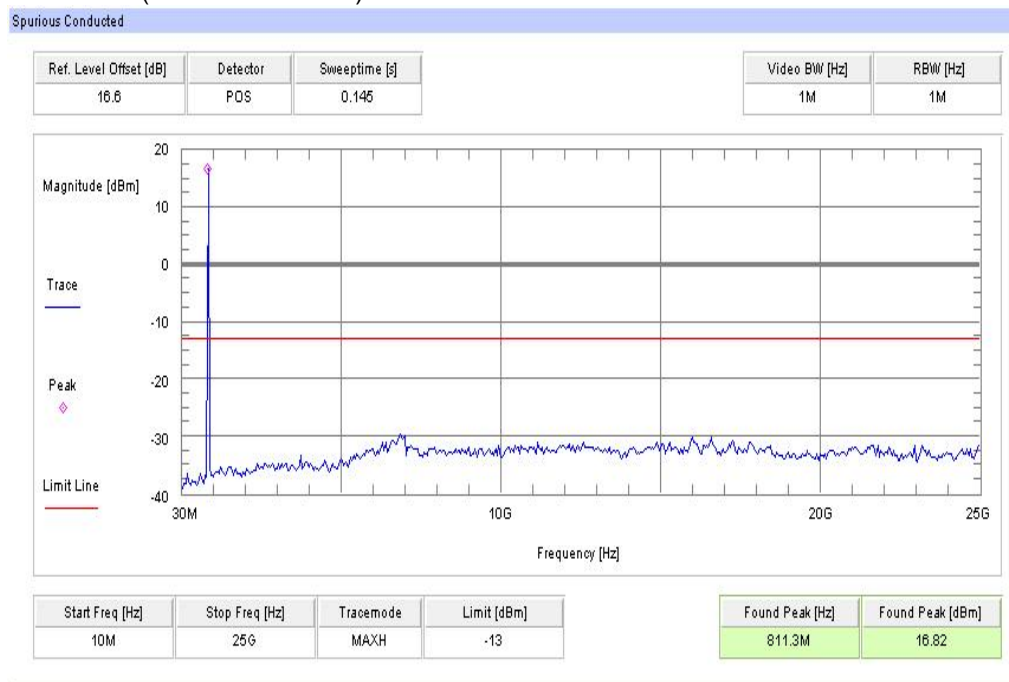

**Plot 2: Middle Channel (10 MHz - 25 GHz)**

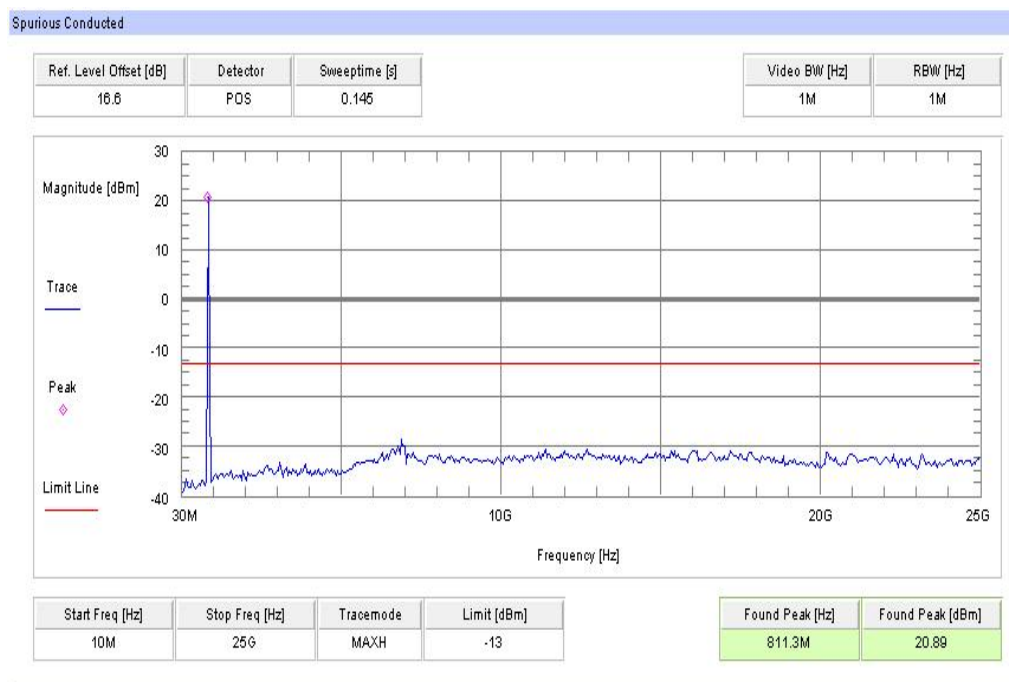

**Plot 3: Highest Channel (10 MHz - 25 GHz)**

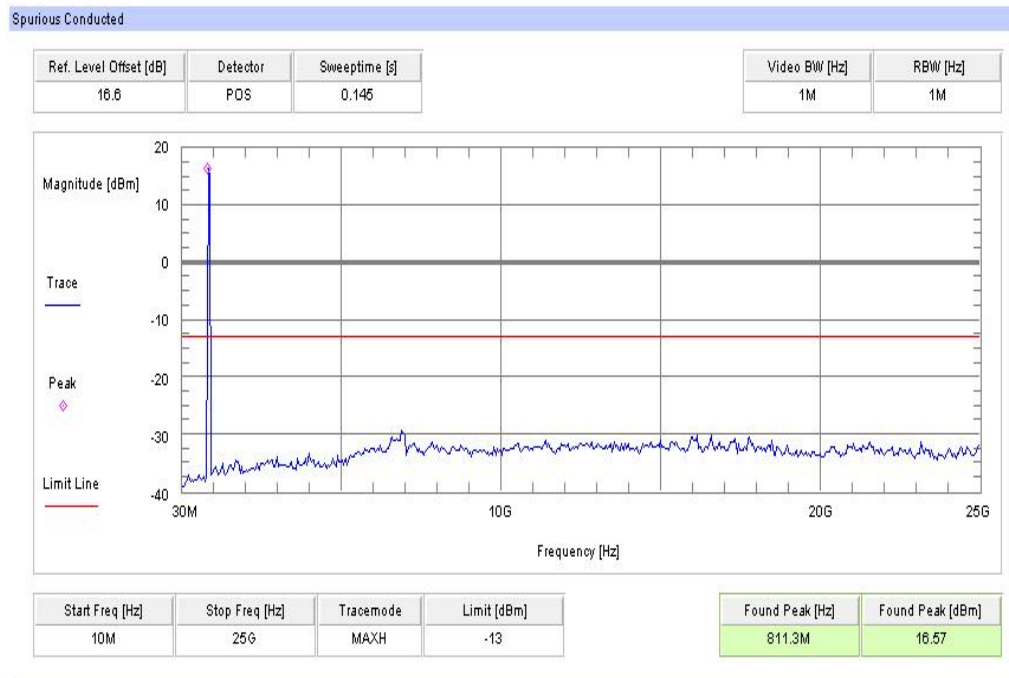



**Plots: 16-QAM with 10 MHz channel bandwidth**

**Plot 4: Lowest Channel (10 MHz - 25 GHz)**

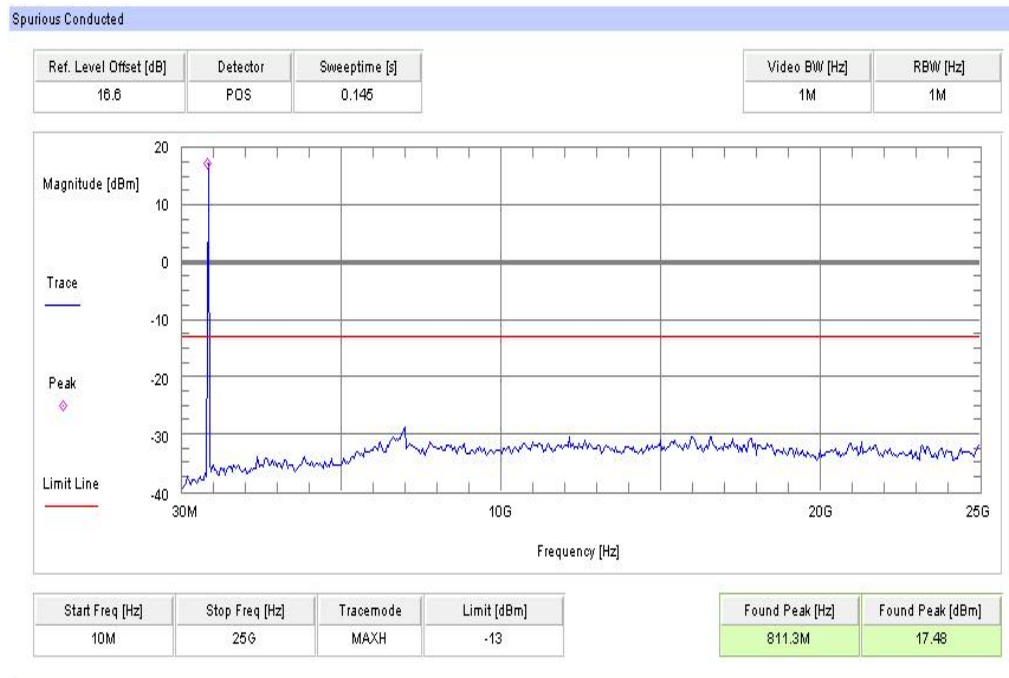

**Plot 5: Middle Channel (10 MHz - 25 GHz)**

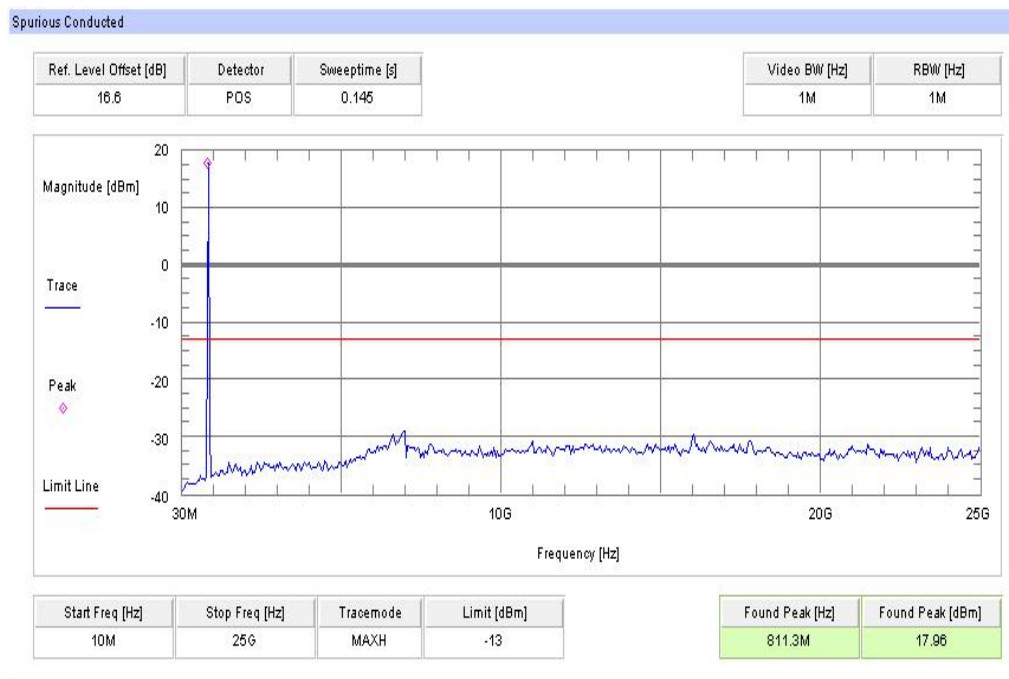

**Plot 6: Highest Channel (10 MHz - 25 GHz)**

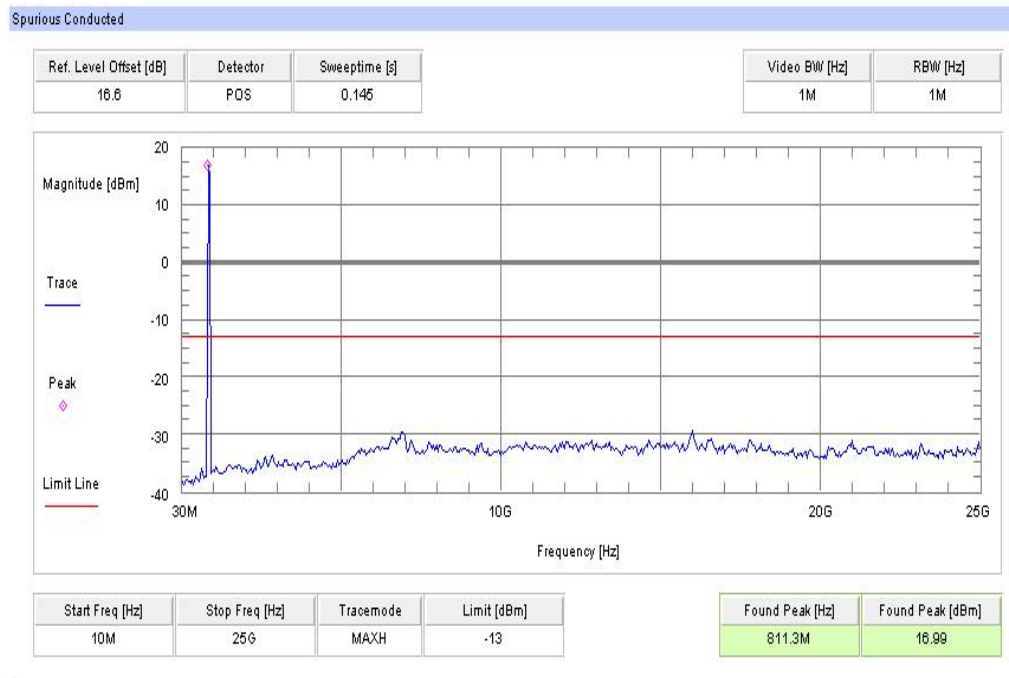

## 8.2.5 Block edge compliance

### Description:

The spectrum at the band edges must comply with the spurious emissions limits.

### Measurement:

Measurement parameters	
Detector:	RMS
Sweep time:	60 s
Video bandwidth:	30 kHz
Resolution bandwidth:	30 kHz
Span:	1 MHz
Trace-Mode:	Max Hold

### Limits:

FCC	IC
CFR Part 22.917 CFR Part 2.1051	-/-
Block Edge Compliance	
<p>Part 22.917 specifies that “the power of any emission outside of the authorized operating frequency ranges must be attenuated below the transmitting power (P) by a factor of at least <math>43 + 10 \log(P)</math> dB.”</p> <p>However, in publication number 890810, The FCC Office of Engineering and Technology specified the following correction to the limits when a resolution bandwidth smaller than 1% of the emission bandwidth is used:</p> <p>“An alternative is to add an additional correction factor of <math>10 \log(RBW1/RBW2)</math> to the <math>43 + 10 \log(P)</math> limit. RBW1 is the narrower measurement resolution bandwidth and RBW2 is either the 1% emissions bandwidth or 1 MHz.”</p> <p>When using a 30 kHz bandwidth, this yields a -5.23 adjustment to the limit [<math>10 \log(30\text{kHz}/100\text{kHz}) = -5.23</math>]. When this adjustment is applied to the limit, the limit becomes -18.23 dBm.</p>	
-18.23 dBm	

**Results: 1.4 MHz channel bandwidth**

**Plot 1: Lowest channel – QPSK**

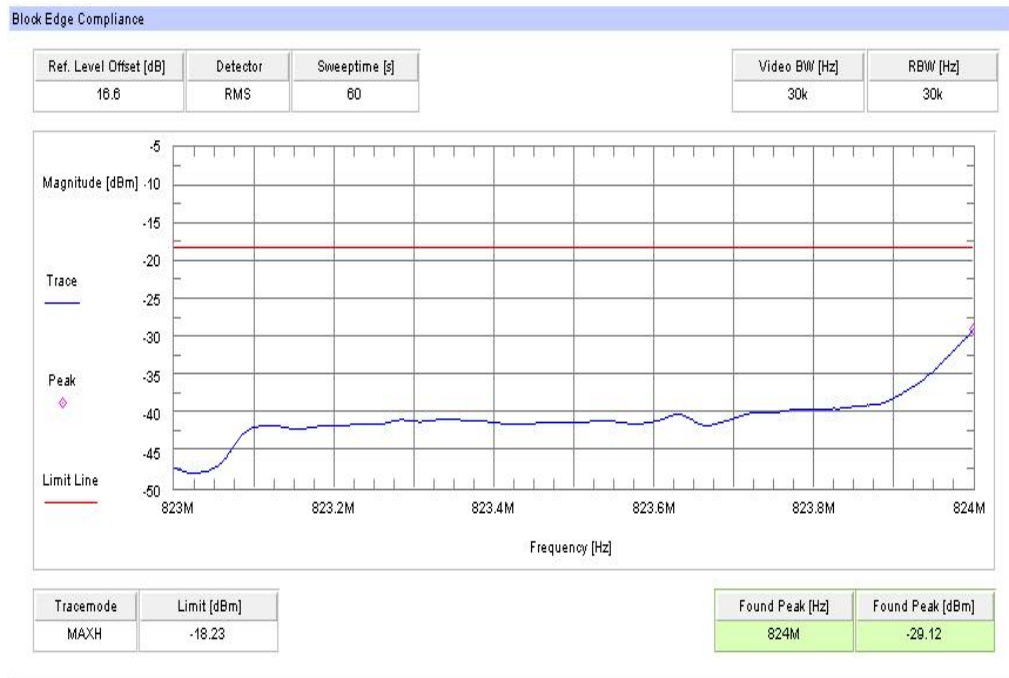

**Plot 2: Highest channel – QPSK**



Plot 3: Lowest channel – 16-QAM

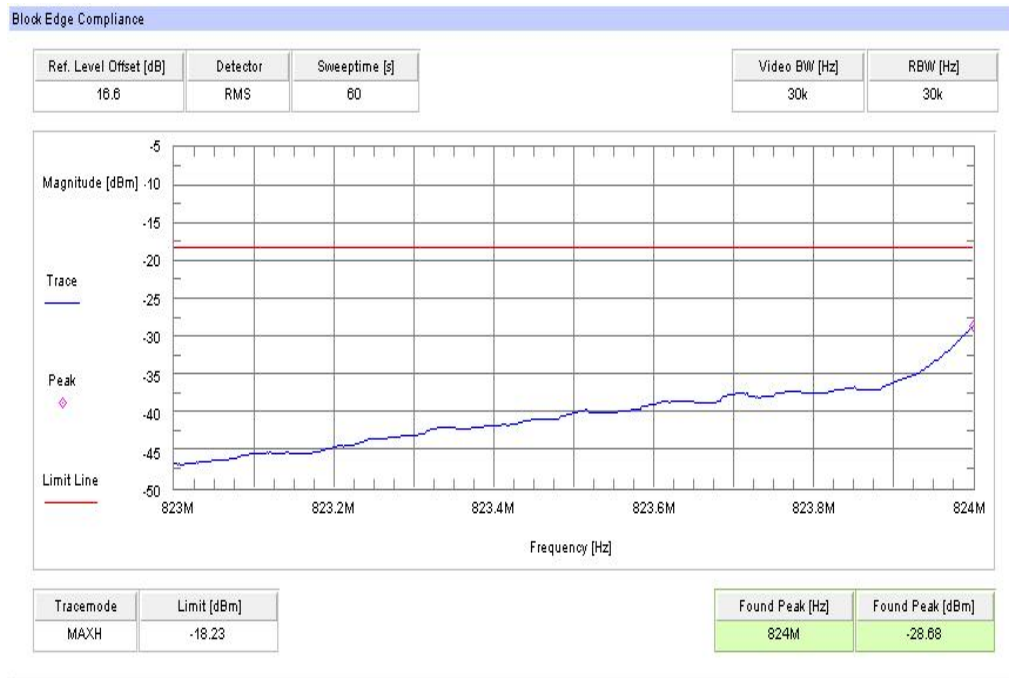

Plot 4: Highest channel – 16-QAM



**Results: 3 MHz channel bandwidth**

**Plot 1: Lowest channel – QPSK**

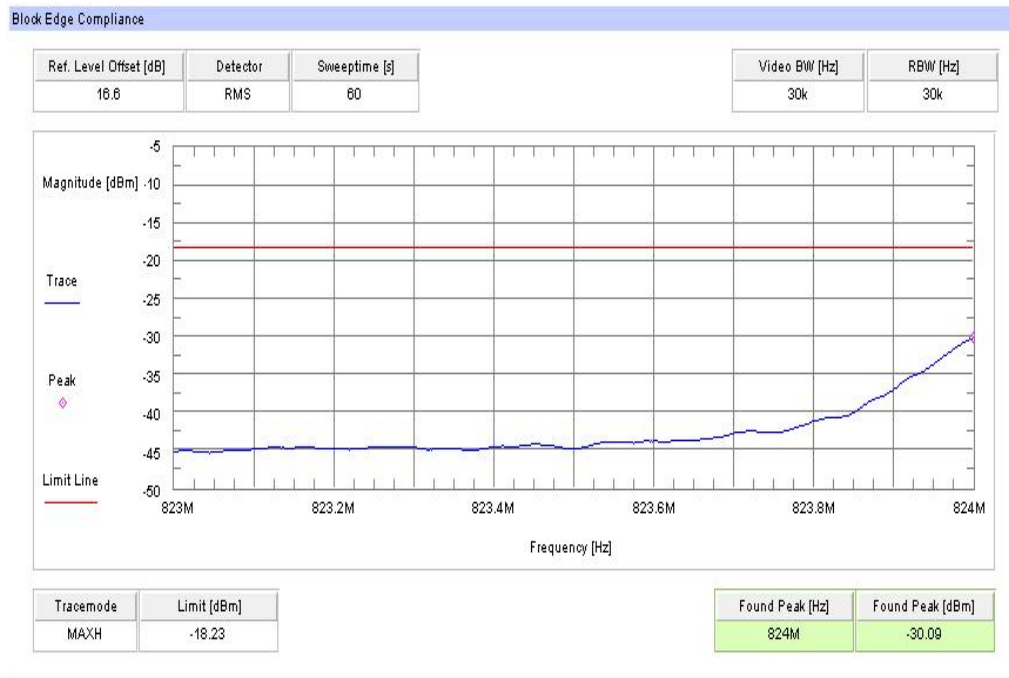

**Plot 2: Highest channel – QPSK**

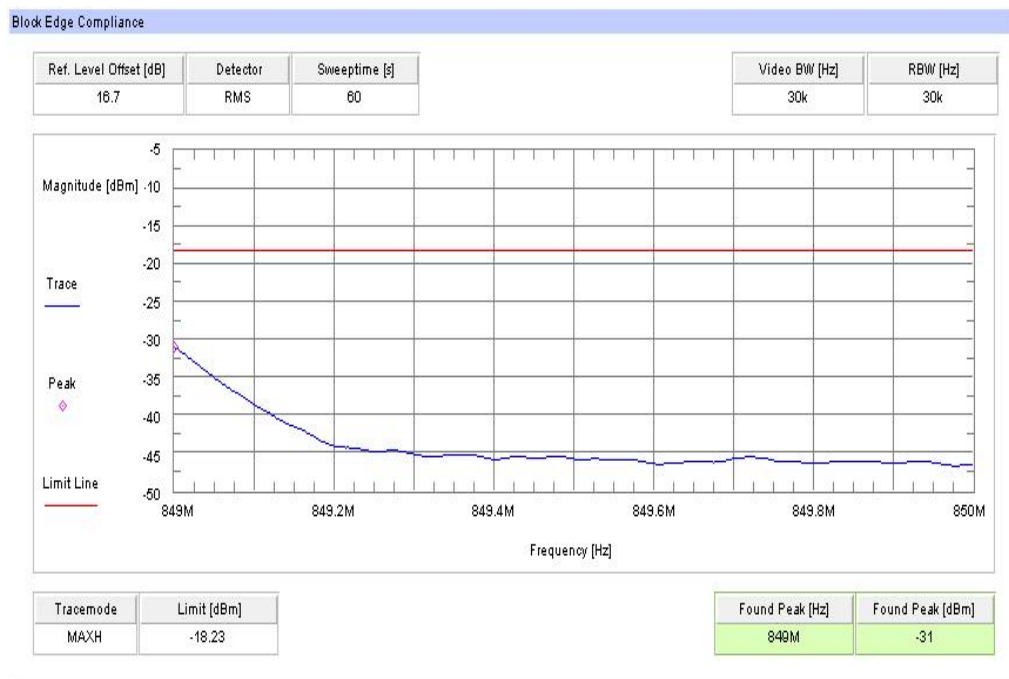

**Plot 3: Lowest channel – 16-QAM**

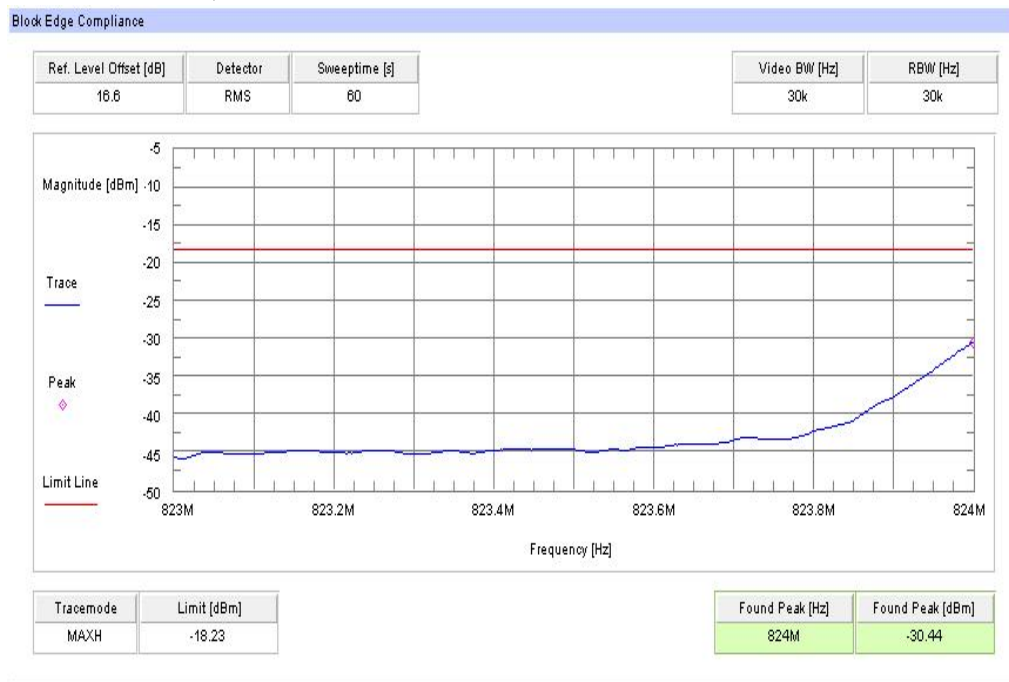

**Plot 4: Highest channel – 16-QAM**



**Results: 5 MHz channel bandwidth**

**Plot 1: Lowest channel – QPSK**

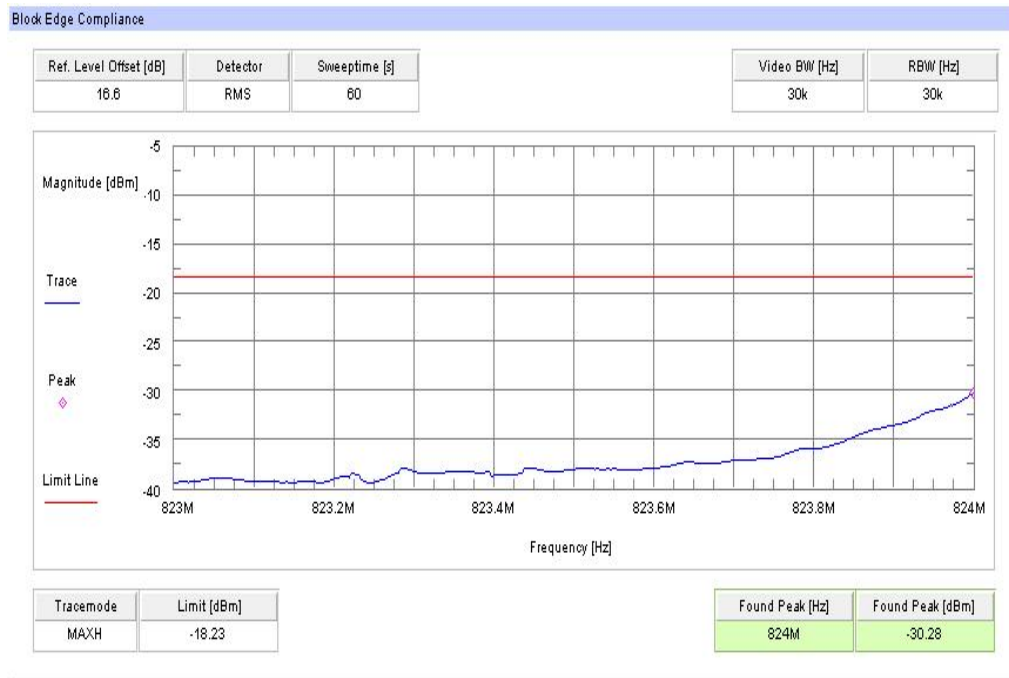

**Plot 2: Highest channel – QPSK**





Plot 3: Lowest channel – 16-QAM

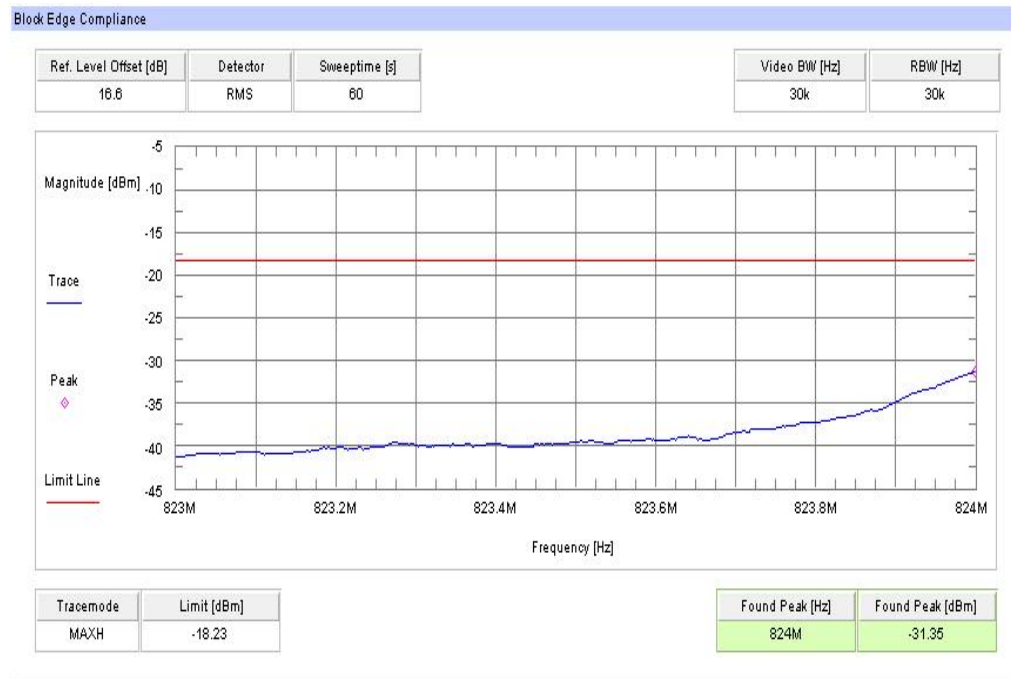

Plot 4: Highest channel – 16-QAM

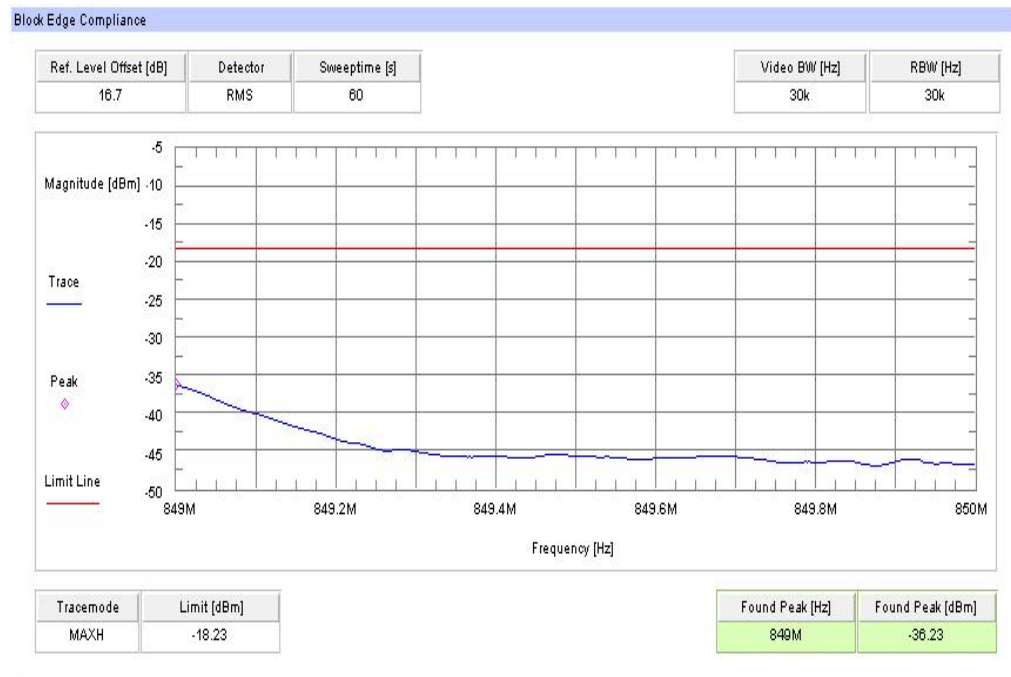

**Results: 10 MHz channel bandwidth**

**Plot 1: Lowest channel – QPSK**

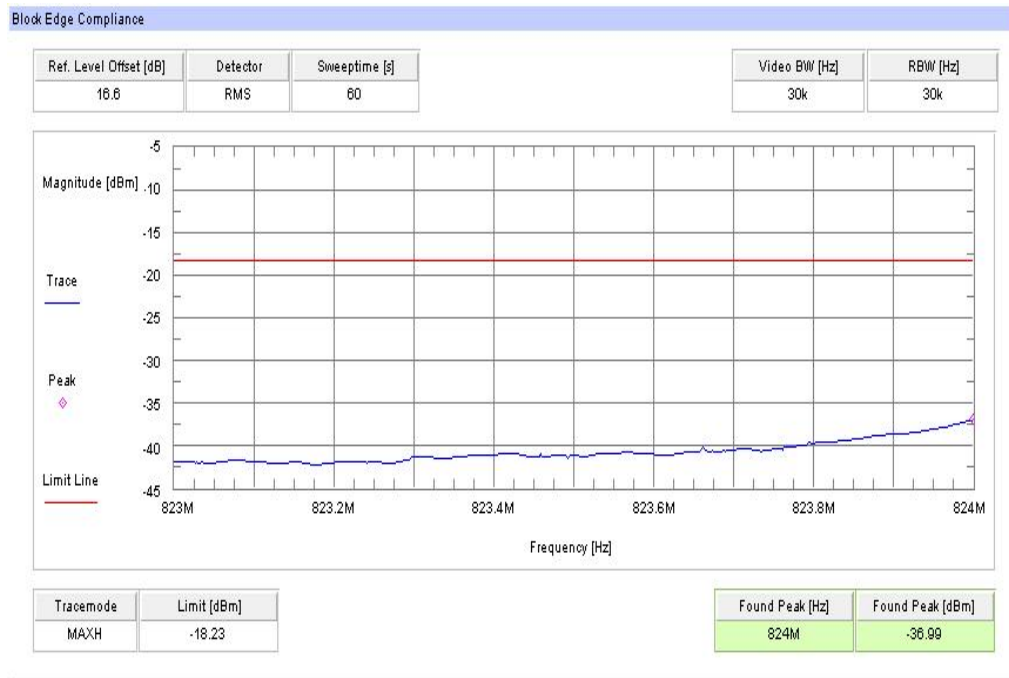

**Plot 2: Highest channel – QPSK**



**Plot 3: Lowest channel – 16-QAM**

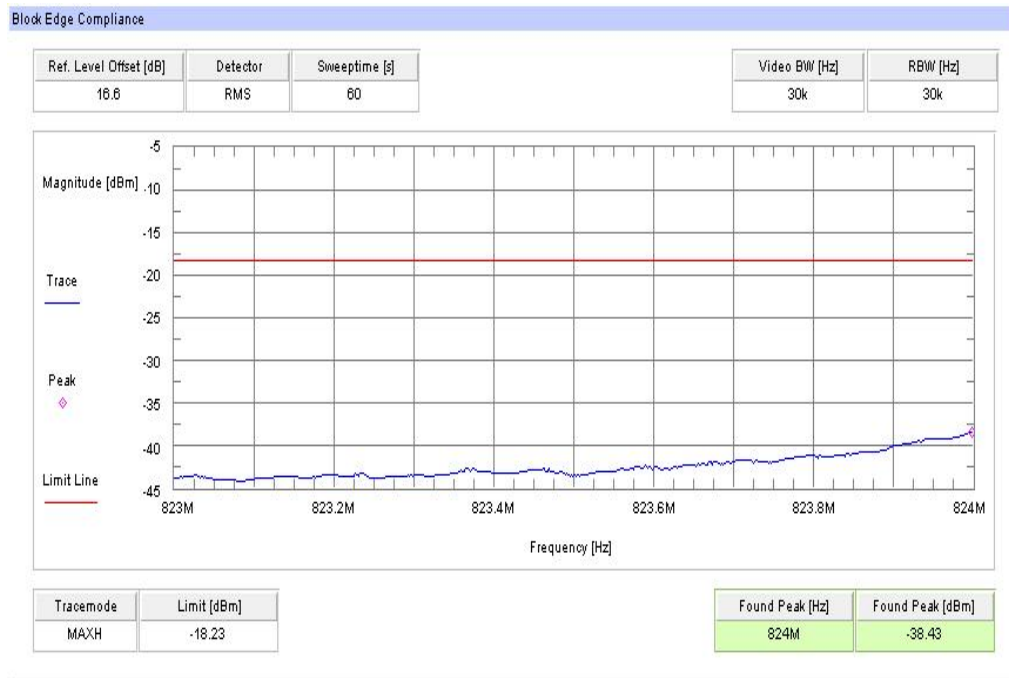

**Plot 4: Highest channel – 16-QAM**



**Result: Passed**

### 8.2.6 Occupied bandwidth

**Description:**

Measurement of the occupied bandwidth of the transmitted signal.

**Measurement:**

Similar to conducted emissions, occupied bandwidth measurements are only provided for selected frequencies in order to reduce the amount of submitted data. Data were taken at the extreme and mid frequencies of the LTE band V. The table below lists the measured 99% power and -26dBc occupied bandwidths. Spectrum analyzer plots are included on the following pages.

Measurement parameters	
Detector:	Peak
Sweep time:	Auto
Video bandwidth:	10 kHz
Resolution bandwidth:	10 kHz
Span:	2 x nominal BW
Trace-Mode:	Max Hold

**Limits:**

FCC	IC
CFR Part 22.917 CFR Part 2.1049	-/-
Occupied Bandwidth	
Spectrum must fall completely in the specified band	

**Results:**

Occupied Bandwidth – QPSK		
Bandwidth (MHz)	99% OBW (kHz)	-26 dBc BW (kHz)
1.4	1133	1212
3.0	2766	2874
5.0	4569	4669
10.0	9098	9259
Measurement uncertainty	± 10 kHz	

Occupied Bandwidth – 16-QAM		
Bandwidth (MHz)	99% OBW (kHz)	-26 dBc BW (kHz)
1.4	1156	1234
3.0	2754	2850
5.0	4569	4689
10.0	9098	9218
Measurement uncertainty	± 10 kHz	

**Result: Passed**

**Plots: QPSK**

**Plot 1: 1.4 MHz (99% - OBW)**

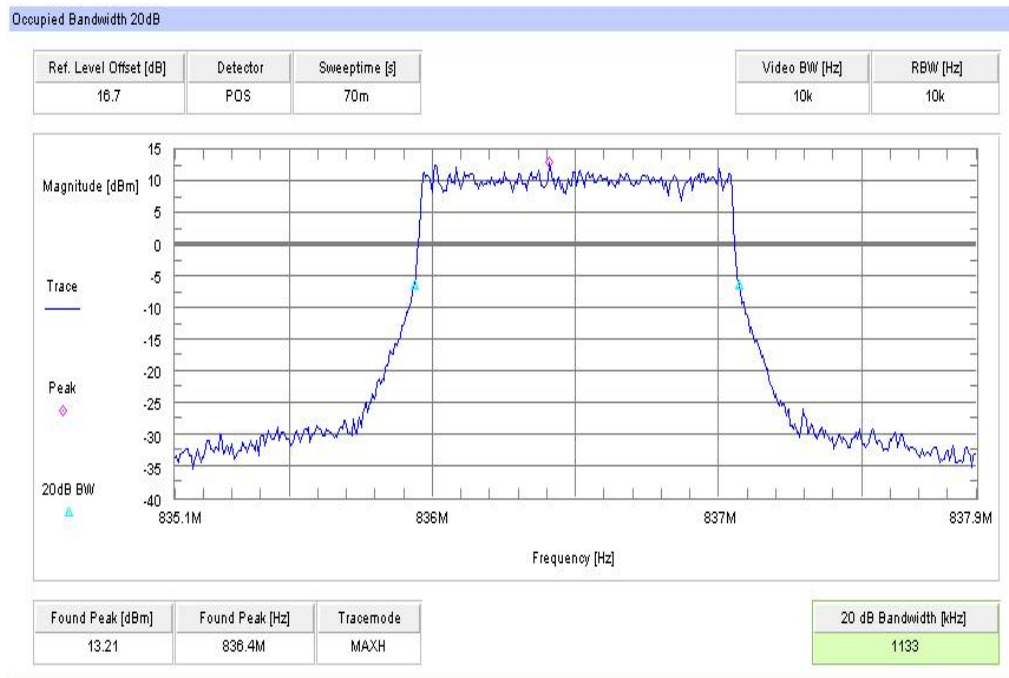

**Plot 2: 1.4 MHz (-26 dBc BW)**

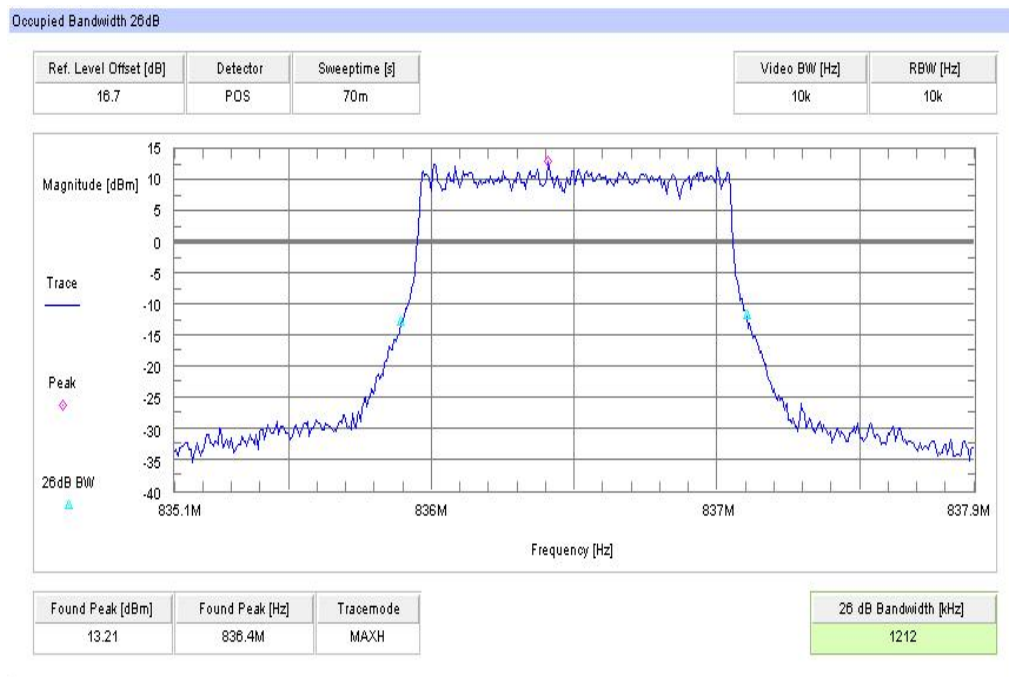

Plot 3: 3 MHz (99% - OBW)

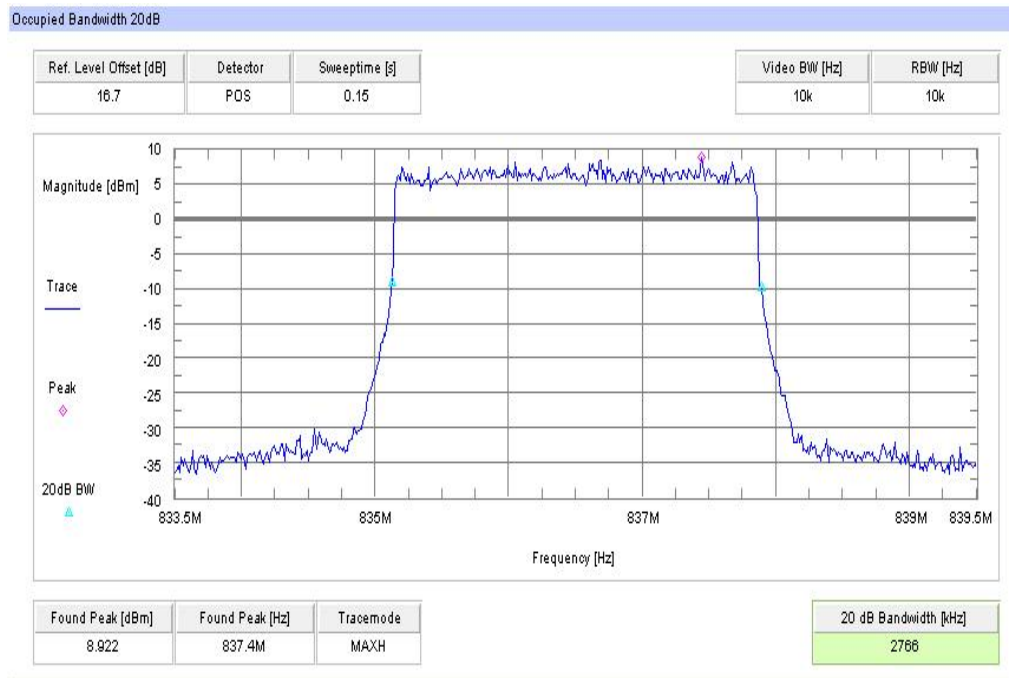

Plot 4: 3 MHz (-26 dBc BW)

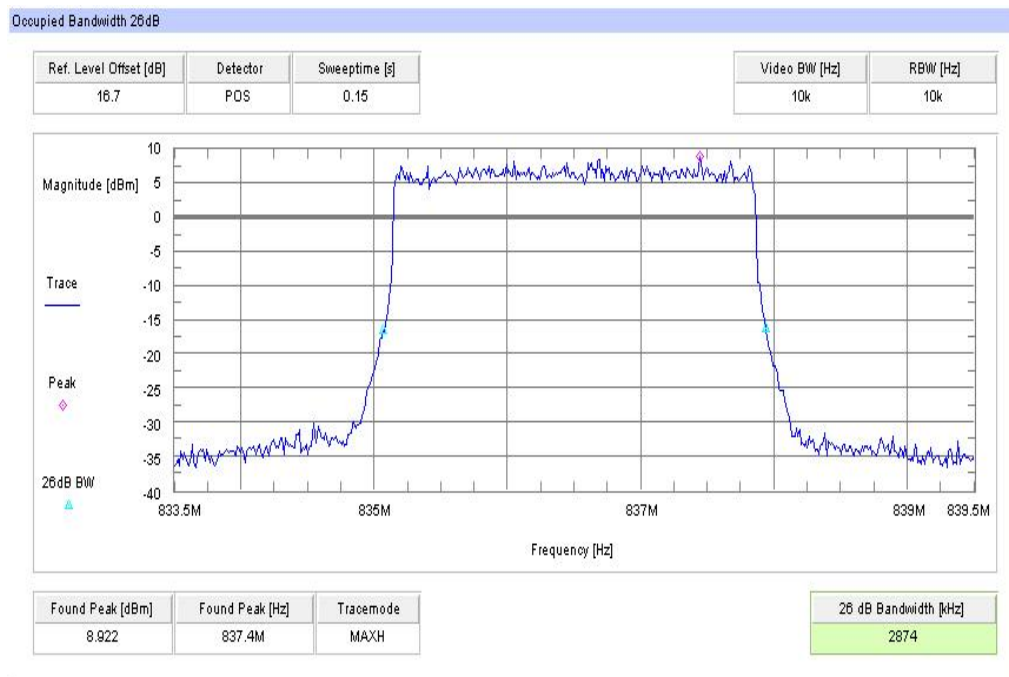

Plot 5: 5 MHz (99% - OBW)

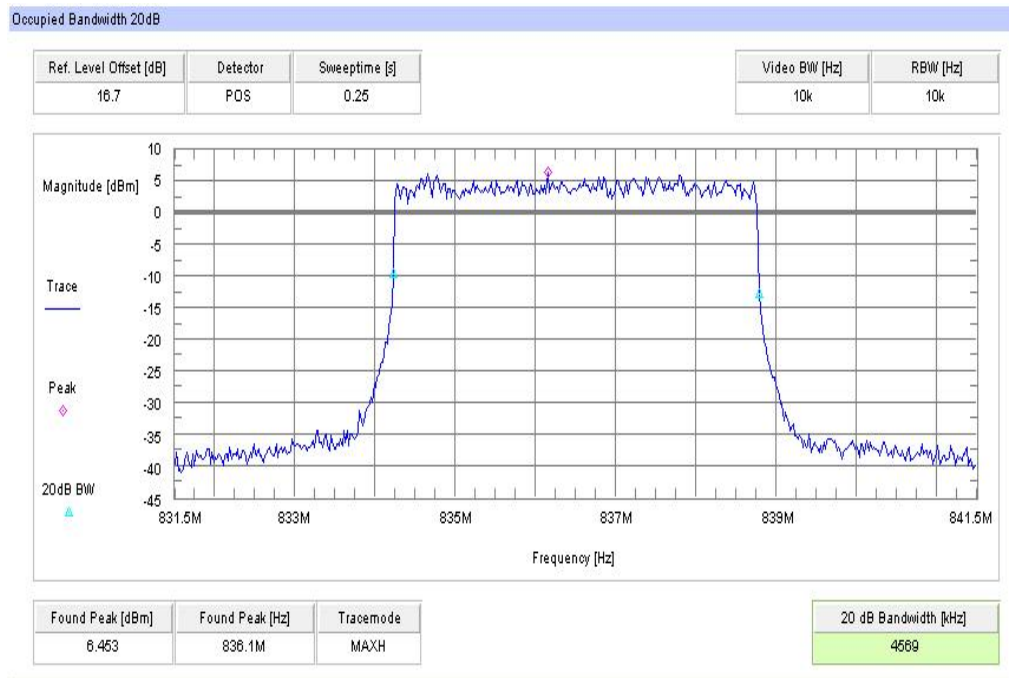

Plot 6: 5 MHz (-26 dBc BW)

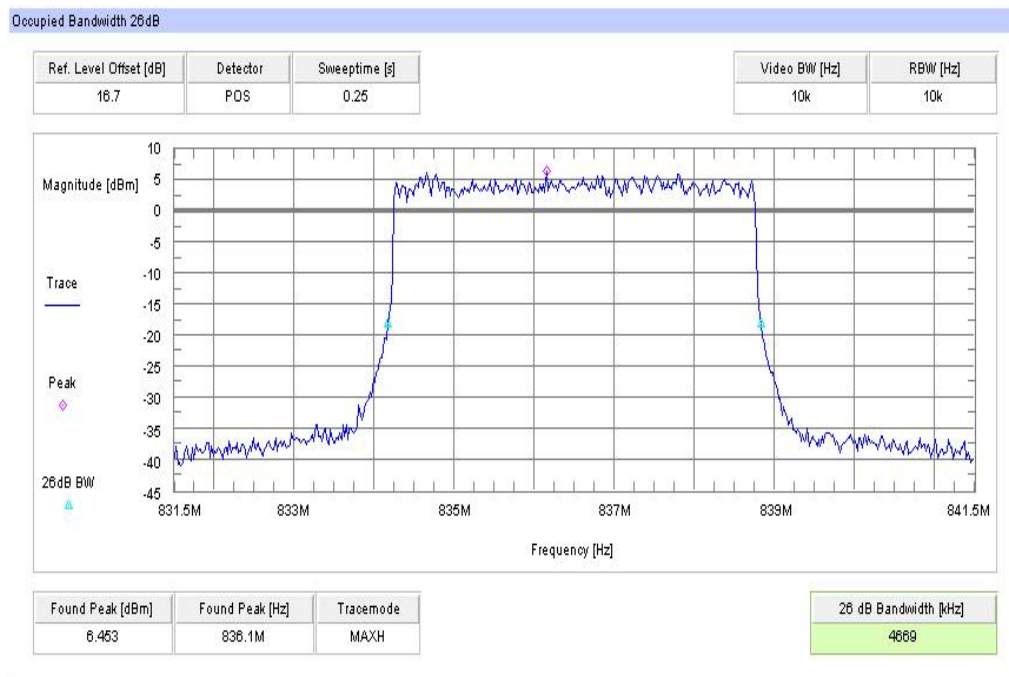



Plot 7: 10 MHz (99% - OBW)

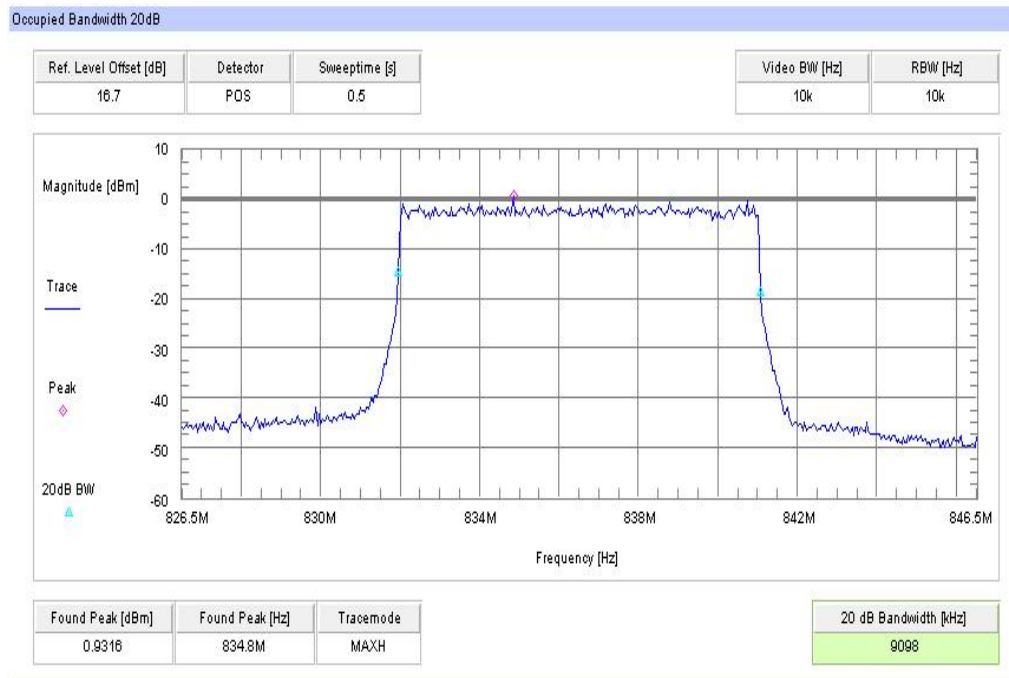

Plot 8: 10 MHz (-26 dBc BW)

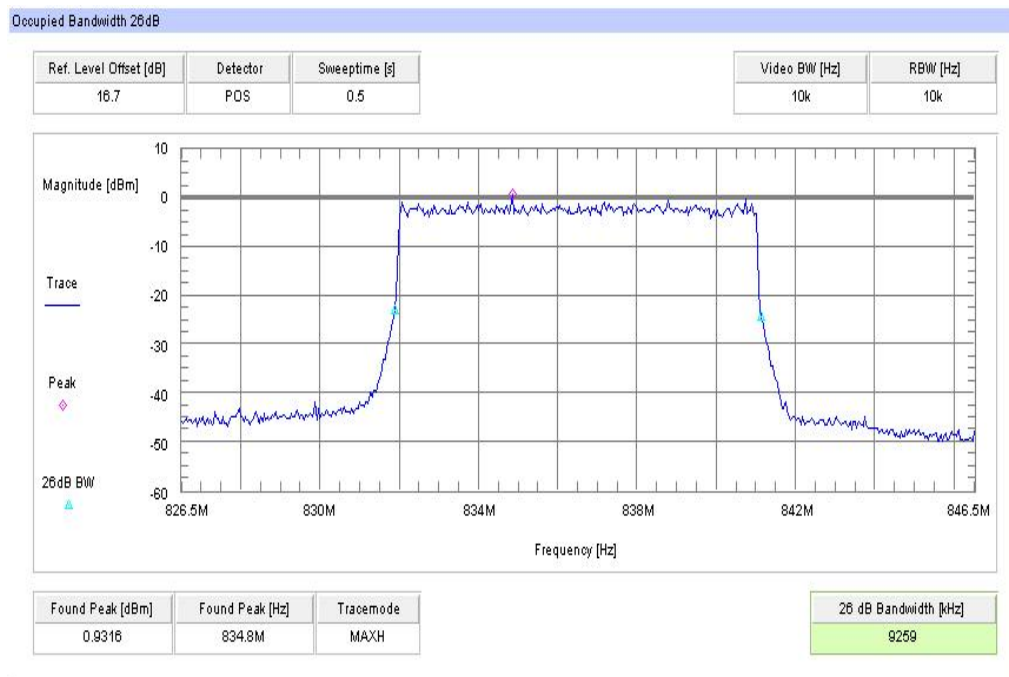

**Plots: 16-QAM**

**Plot 1: 1.4 MHz (99% - OBW)**

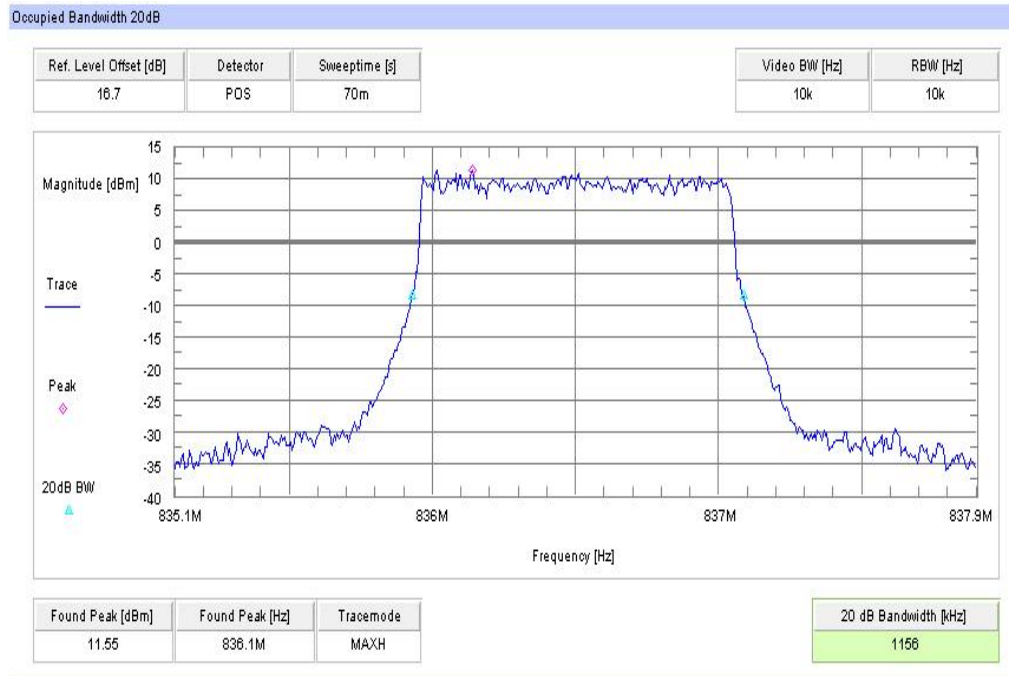

**Plot 2: 1.4 MHz (-26 dBc BW)**

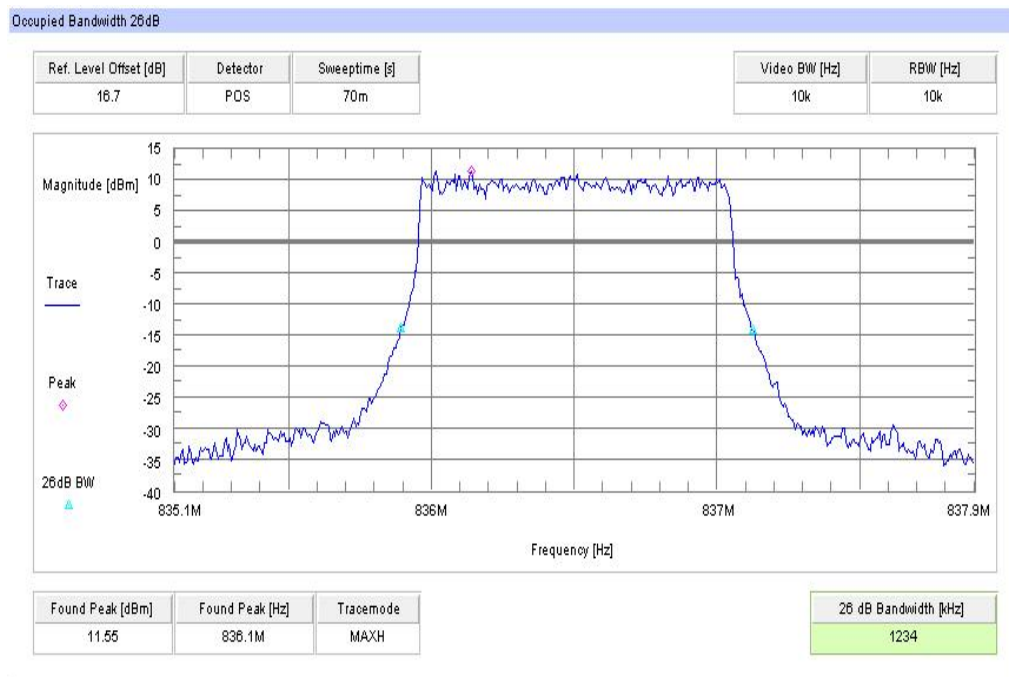

Plot 3: 3 MHz (99% - OBW)

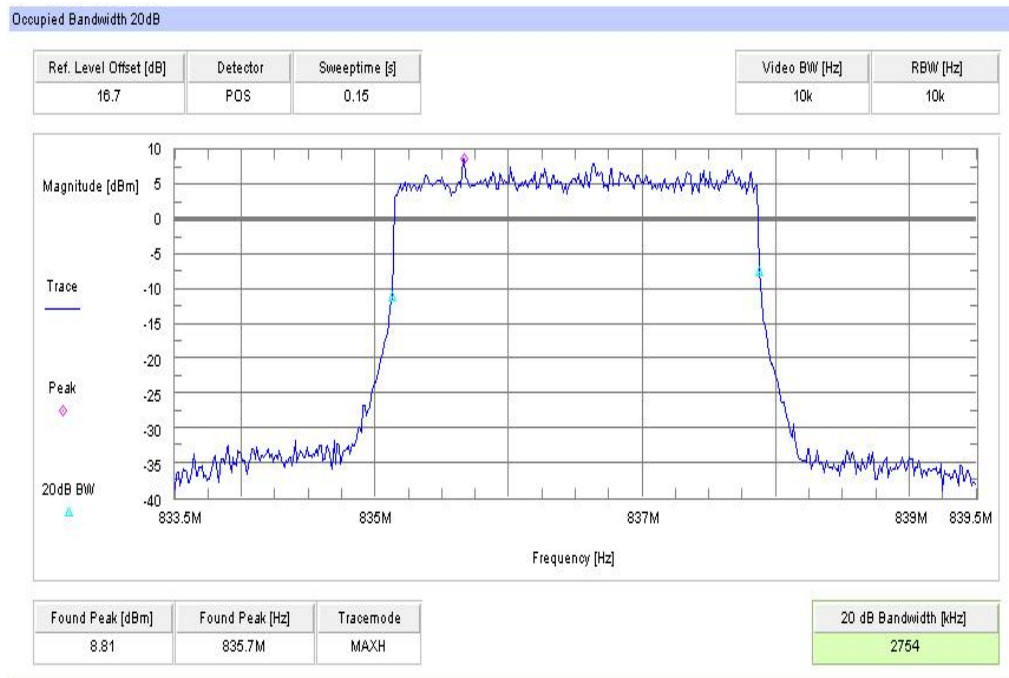

Plot 4: 3 MHz (-26 dBc BW)

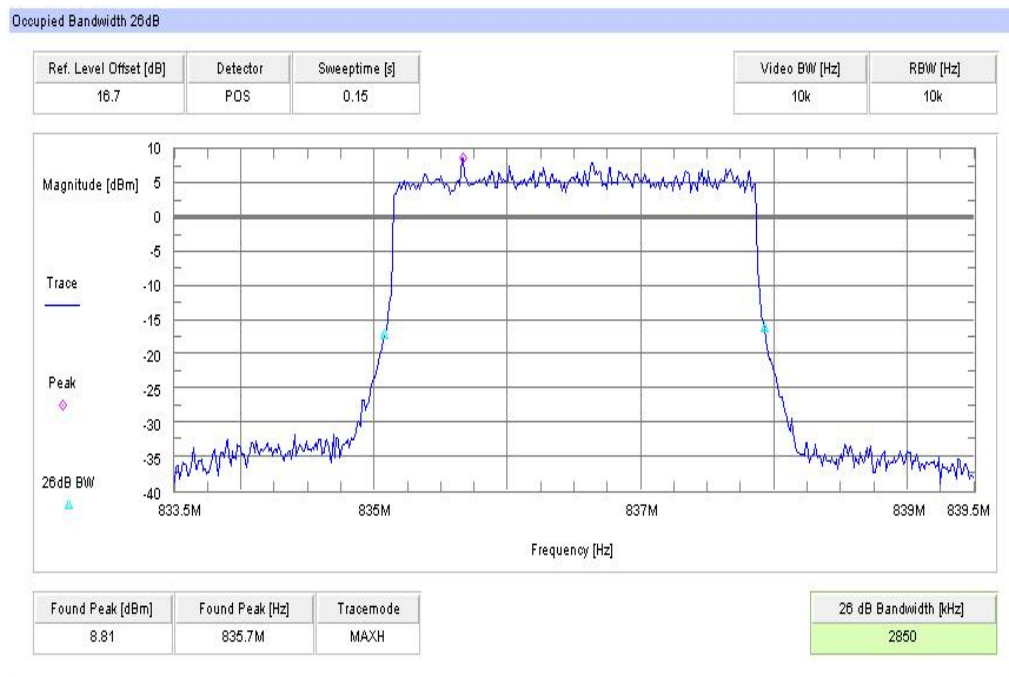

Plot 5: 5 MHz (99% - OBW)

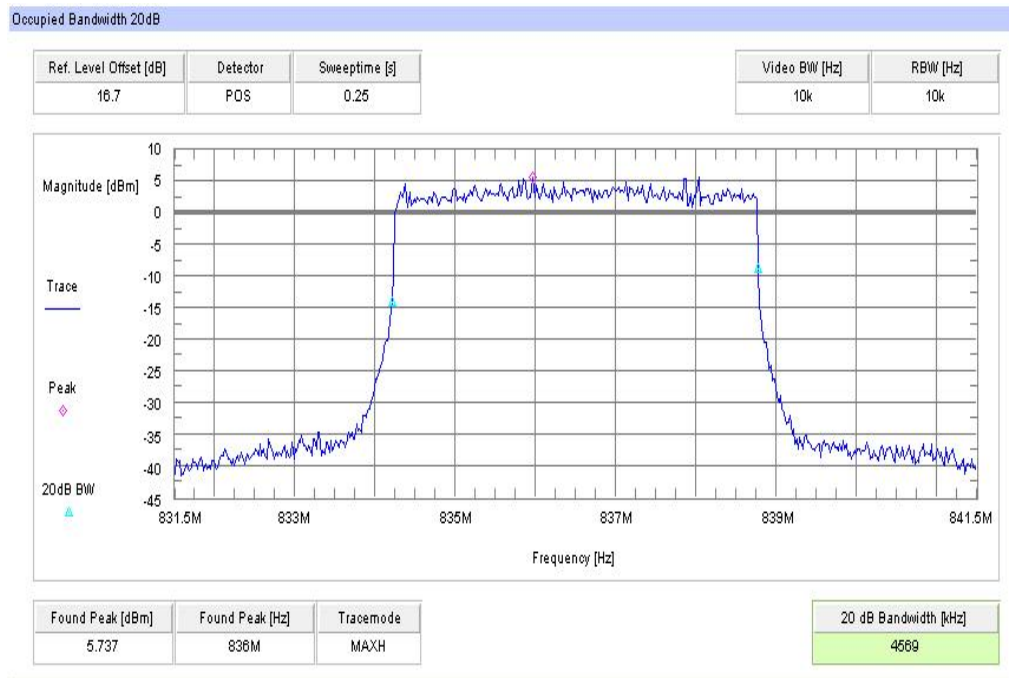

Plot 6: 5 MHz (-26 dBc BW)

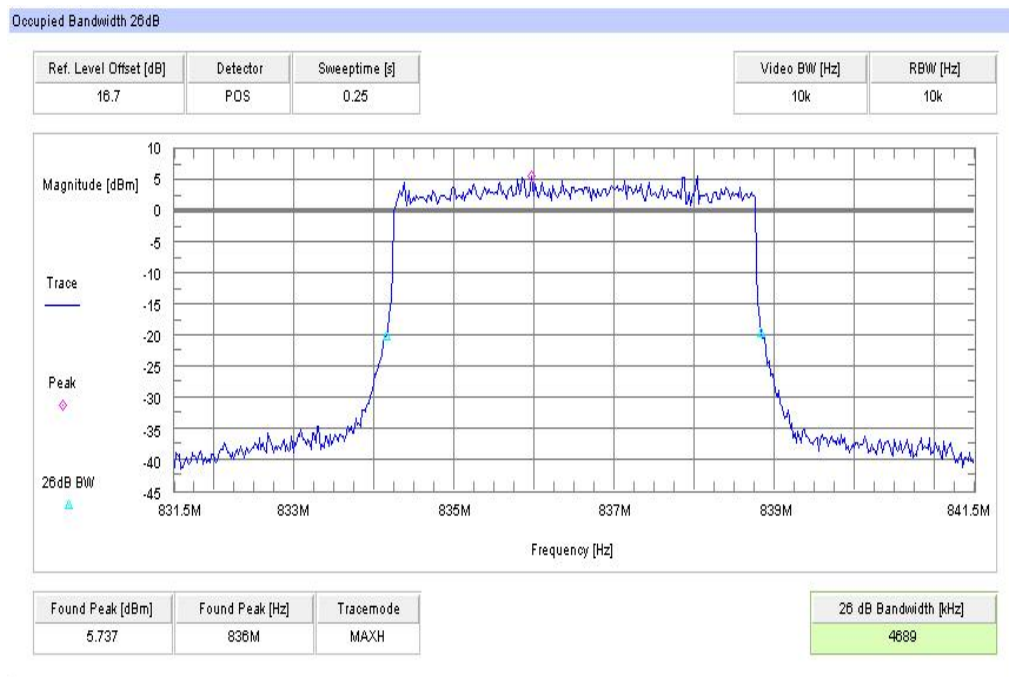

Plot 7: 10 MHz (99% - OBW)

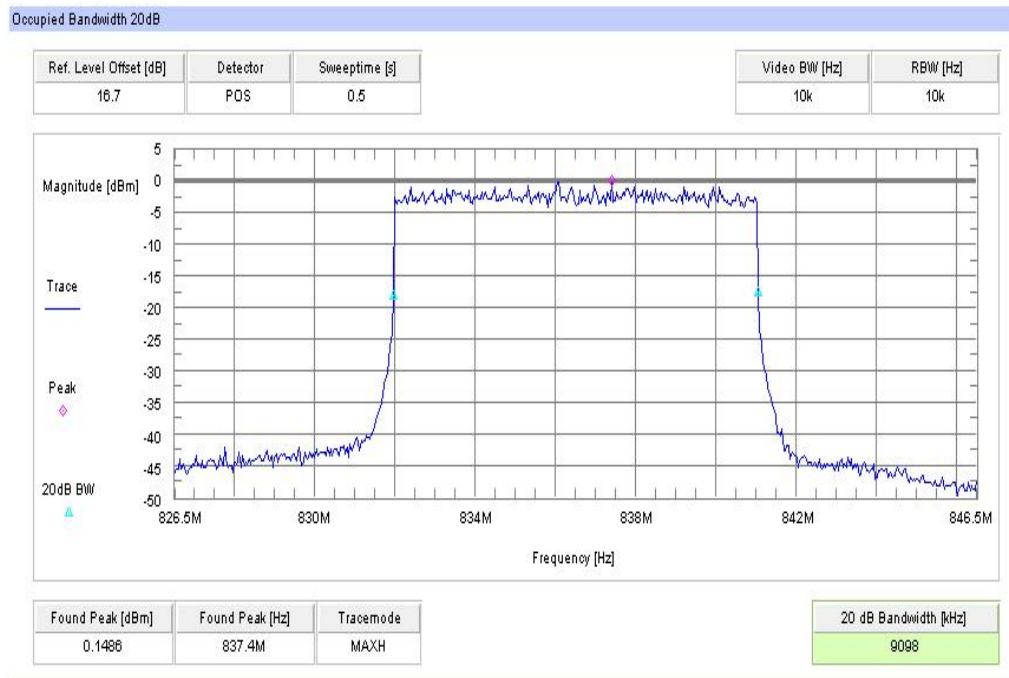

Plot 8: 10 MHz (-26 dBc BW)

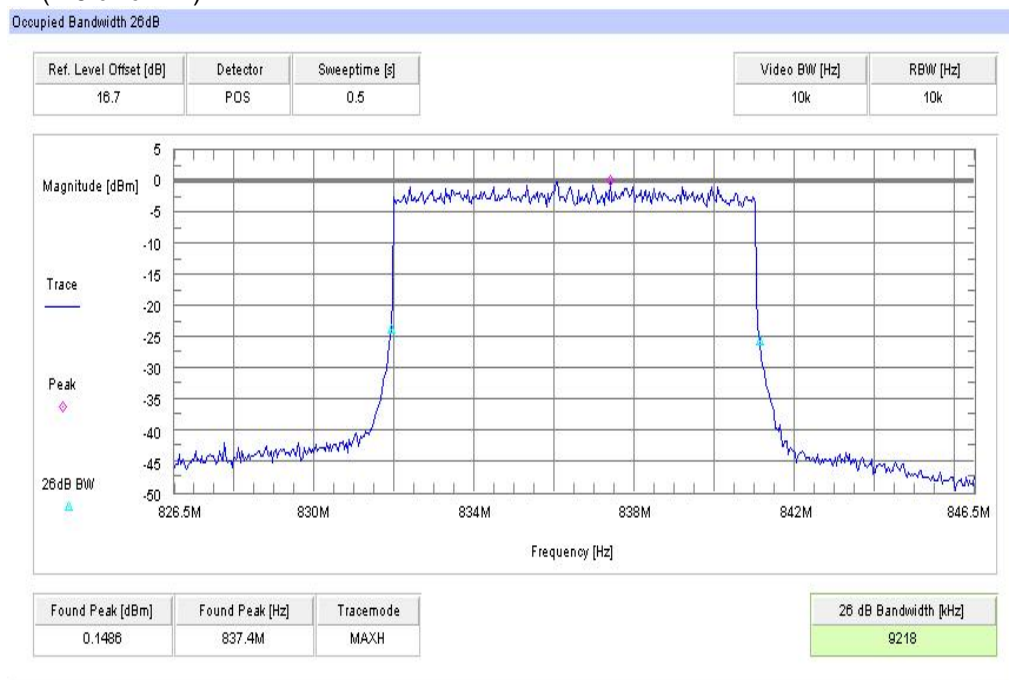

## 9 Test equipment and ancillaries used for tests

Typically, the calibrations of the test apparatus are commissioned to and performed by an accredited calibration laboratory. The calibration intervals are determined in accordance with the DIN EN ISO/IEC 17025. In addition to the external calibrations, the laboratory executes comparison measurements with other calibrated test systems or effective verifications. Weekly chamber inspections and range calibrations are performed. Where possible, rf-generating and signalling equipment as well as measuring receivers and analyzers are connected to an external high-precision 10 MHz reference (GPS-based or rubidium frequency standard).

In order to simplify the identification of the equipment used at some special tests, some items of test equipment and ancillaries can be provided with an identifier or number in the equipment list below (Labor/Item).

No.	Lab / Item	Equipment	Type	Manufact.	Serial No.	INV. No Cetecom	Kind of Calibration	Last Calibration	Next Calibration
1	n. a.	Wideband Radio Communication Tester	CMW500	R&S	102375	300004187		04.01.2011	04.01.2013
2	n. a.	DC power supply, 60Vdc, 50A, 1200 W	6032A	HP Meßtechnik	2818A03450	300001040	Ve	12.01.2012	12.01.2015
3	n. a.	Double-Ridged Waveguide Horn Antenna 1-18.0GHz	3115	EMCO	8812-3088	300001032	vIKI!	11.05.2011	11.05.2013
4	n. a.	Active Loop Antenna	6502	EMCO	2210	300001015	ne		
5	n. a.	Anechoic chamber	FAC 3/5m	MWB / TDK	87400/02	300000996	ev		
6	n. a.	Relais Matrix	3488A	HP Meßtechnik	2719A15013	300001156	ne		
7	n. a.	Switch / Control Unit	3488A	HP	2605e08770	300001443	ne		
8	n. a.	Amplifier	js42- 00502650- 28-5a	Parzich GMBH	928979	300003143	ne		
9	n. a.	TRIOLOG Broadband Test-Antenna 30 MHz - 3 GHz	VULB9163	Schwarzbe ck	371	300003854	vIKI!	14.10.2011	14.10.2014
10	n. a.	MXE EMI Receiver 20 Hz bis 26,5 GHz	N9038A	Agilent Technologi es	MY51210197	300004405	k	19.12.2011	19.12.2012
11	19	Double-Ridged Waveguide Horn Antenna 1-18.0GHz	3115	EMCO	9107-3697	300001605	Ve	20.08.2012	20.08.2014
12	n. a.	DC Power Supply 0 – 32V	1108-32	Heiden	001802	300001383	Ve	23.06.2010	23.06.2013
13	n. a.	Signal Analyzer 20Hz-26,5GHz- 150 to + 30 DBM	FSIQ26	R&S	835111/0004	300002678	Ve	04.11.2010	04.11.2012
14	n. a.	Temperature Test Chamber	T-40/50	CTS GmbH	064023	300003540	vIKI!	20.09.2011	20.09.2013

### Agenda: Kind of Calibration

k	calibration / calibrated	EK	limited calibration
ne	not required (k, ev, izw, zw not required)	zw	cyclical maintenance (external cyclical maintenance)
ev	periodic self verification	izw	internal cyclical maintenance
Ve	long-term stability recognized	g	blocked for accredited testing
vIKI!	Attention: extended calibration interval	*	next calibration ordered / currently in progress
NK!	Attention: not calibrated		

## 10 Observations

No observations exceeding those reported with the single test cases have been made.

**Annex A Document history**

Version	Applied changes	Date of release
1.0	Initial release	2012-10-01

**Annex B Further information****Glossary**

AVG	-	Average
DUT	-	Device under test
EMC	-	Electromagnetic Compatibility
EN	-	European Standard
EUT	-	Equipment under test
ETSI	-	European Telecommunications Standard Institute
FCC	-	Federal Communication Commission
FCC ID	-	Company Identifier at FCC
HW	-	Hardware
IC	-	Industry Canada
Inv. No.	-	Inventory number
N/A	-	Not applicable
PP	-	Positive peak
QP	-	Quasi peak
S/N	-	Serial number
SW	-	Software

**Annex C Accreditation Certificate**



Deutsche Akkreditierungsstelle GmbH  
German Accreditation Body

Entrusted according to Section 8 subsection 1 AkkStelleG in connection with Section 1 subsection 1 AkkStelleGBV  
Signatory to the Multilateral Agreements of EA, ILAC and IAF for Mutual Recognition

**Accreditation**



The Deutsche Akkreditierungsstelle GmbH (German Accreditation Body) attests that the testing laboratory

**CETECOM ICT Services GmbH**  
Untertürkheimer Straße 6-10  
66117 Saarbrücken

is competent under the terms of DIN EN ISO/IEC 17025:2005 to carry out tests in the following fields:

- Wired communications and DECT
- Acoustic
- Radio
- Shirt Range Devices (SRD)
- RFID
- WiMax and Richtfunk
- Mobile radio (GSM / DCS), Over the Air (OTA) Performance
- Electromagnetic Compatibility (EMC) incl. Automotive
- Product safety
- SAR and Hearing Aid Compatibility (HAC)
- Environmental simulation
- Smart Card Terminals
- Bluetooth
- Wi-Fi-Services

The accreditation certificate shall only apply in connection with the notice of accreditation of 13.04.2011 with the accreditation number D-PL-12076-01 and is valid until 03.09.2014. It comprises the cover sheet, the reverse side of the cover sheet and the following annex with a total of 82 pages.

Registration number of the certificate: **D-PL-12076-01-01**

Frankfurt am Main, 13.04.2011

Dipl.-Ing. (FH) Ralf Eger  
Head of Division 2

This document is a translation. The definitive version is the original German accreditation certificate.  
See annex overleaf.

Front side of certificate

Deutsche Akkreditierungsstelle GmbH

Office Berlin  
Spittelmarkt 10  
10117 Berlin

Office Frankfurt am Main  
Gartenstraße 6  
60594 Frankfurt am Main

Office Braunschweig  
Bundesallee 100  
38116 Braunschweig

The publication of extracts of the accreditation certificate is subject to the prior written approval by Deutsche Akkreditierungsstelle GmbH (DAKKS). Exempted is the unchanged form of separate disseminations of the cover sheet by the conformity assessment body mentioned overleaf.

No impression shall be made that the accreditation also extends to fields beyond the scope of accreditation attested by DAKKS.

The accreditation was granted pursuant to the Act on the Accreditation Body (AkkStelleG) of 31 July 2009 (Federal Law Gazette I p. 2625) and the Regulation (EC) No 765/2008 of the European Parliament and of the Council of 9 July 2008 setting out the requirements for accreditation and market surveillance relating to the marketing of products (Official Journal of the European Union L 218 of 9 July 2008, p. 30). DAKKS is a signatory to the Multilateral Agreements for Mutual Recognition of the European co-operation for Accreditation (EA), International Accreditation Forum (IAF) and International Laboratory Accreditation Cooperation (ILAC). The signatories to these agreements recognise each other's accreditations.

The up-to-date state of membership can be retrieved from the following websites:  
EA: [www.european-accreditation.org](http://www.european-accreditation.org)  
ILAC: [www.ilac.org](http://www.ilac.org)  
IAF: [www.iaf.nu](http://www.iaf.nu)

Back side of certificate

**Note:**

The current certificate including annex is published on our website (see link below) or may be received from CETECOM ICT Services on request.

[http://www.cetecom.com/fileadmin/de/CETECOM\\_D\\_Saarbruecken/accreditations\\_Jan\\_2010/DAKKS\\_Akkredi\\_Urk\\_EN17025-En\\_incl\\_Annex.pdf](http://www.cetecom.com/fileadmin/de/CETECOM_D_Saarbruecken/accreditations_Jan_2010/DAKKS_Akkredi_Urk_EN17025-En_incl_Annex.pdf)