

TEST REPORT

Test report no.: 1-4254/12-19-24-A



Deutsche
 Akkreditierungsstelle
 D-PL-12076-01-01

Testing laboratory

CETECOM ICT Services GmbH
 Untertuerkheimer Strasse 6 – 10
 66117 Saarbruecken / Germany
 Phone: + 49 681 5 98 - 0
 Fax: + 49 681 5 98 - 9075
 Internet: <http://www.cetecom.com>
 e-mail: ict@cetecom.com

Accredited Testing Laboratory:

The testing laboratory (area of testing) is accredited according to DIN EN ISO/IEC 17025 (2005) by the Deutsche Akkreditierungsstelle GmbH (DAkkS). The accreditation is valid for the scope of testing procedures as stated in the accreditation certificate with the registration number: D-PL-12076-01-01
 Area of Testing: Radio/Satellite Communications

Applicant

Sony Mobile Communications AB
 Nya Vattentornet
 22188 Lund / SWEDEN
 Phone: +46 46 19 30 00
 Fax: +46 46 19 32 95
 Contact: Håkan Sjöberg
 e-mail: hakan.sjoberg@sonymobile.com
 Phone: +46 46 19 35 59

Manufacturer

Sony Mobile Communications AB
 Nya Vattentornet
 22188 Lund / SWEDEN

Test standard/s

47 CFR Part 15	Title 47 of the Code of Federal Regulations; Chapter I Part 15 - Radio frequency devices Subpart E – UNII Devices
RSS - 210 Issue 8	Spectrum Management and Telecommunications - Radio Standards Specification Low-power Licence-exempt Radiocommunication Devices (All Frequency Bands): Category I Equipment

For further applied test standards please refer to section 3 of this test report.

Test Item

Kind of test item: GSM Mobile Phone GPRS/EGPRS 850/900/1800/1900; UMTS FDDI/FDDV/FDDVI/FDDXIX; HSPA; LTE Band 1; BT3.1; WLAN a/b/g/n; AGPS; RFID, FM Rx

Model name: PM-0000-BV

Frequency: 5250 MHz – 5350 MHz ISM band 2
(lowest channel 5260; highest channel 5320 MHz)
5470 MHz – 5725 MHz ISM band 3
(lowest channel 5500; highest channel 5700 MHz)

FCC ID: PY7PM-0000

IC-Nr: 4170B-PM0000

Technology tested: WLAN (DFS client)

Antenna: Integrated antenna

Power Supply: 3.7 V DC by Li-ion battery BA900

Temperature Range: -20°C to +55 °C

Test performed:

2012-06-25 Stefan Bös
 Senior Testing Manager

Test report authorised:

2012-06-25 Marco Bertolino
 Testing Manager

1 Table of contents	
1	Table of contents2
2	General information3
2.1	Notes.....3
2.2	Application details.....3
3	Test standard/s3
4	Test environment.....3
5	Test item4
6	Test laboratories sub-contracted4
7	Summary of measurement results5
8	RF measurements6
8.1	Description of test setup6
8.1.1	Conducted measurements.....6
8.1.2	Parameters of DFS test signals7
8.2	DFS test results8
8.2.1	Channel move time / channel closing transmission time.....8
8.2.2	Non-Occupancy Period.....9
9	Test equipment and ancillaries used for tests12
10	Observations12
Annex A	Photographs of the test setup13
Annex B	External photographs of the EUT14
Annex C	Internal photographs of the EUT20
Annex D	Document history28
Annex E	Further information.....28
Annex F	Accreditation Certificate29

2 General information

2.1 Notes

The test results of this test report relate exclusively to the test item specified in this test report. CETECOM ICT Services GmbH does not assume responsibility for any conclusions and generalisations drawn from the test results with regard to other specimens or samples of the type of the equipment represented by the test item. The test report may only be reproduced or published in full. Reproduction or publication of extracts from the report requires the prior written approval of CETECOM ICT Services GmbH.

2.2 Application details

Date of receipt of order:	2012-03-27
Date of receipt of test item:	2012-04-11
Start of test:	2012-06-01
End of test:	2012-06-11
Person(s) present during the test:	-/-

3 Test standard/s

Test standard	Version	Test standard description
47 CFR Part 15	2010-10	Title 47 of the Code of Federal Regulations; Chapter I Part 15 - Radio frequency devices Subpart E – UNII Devices
RSS - 210 Issue 8	2010-12	Spectrum Management and Telecommunications - Radio Standards Specification Low-power Licence-exempt Radiocommunication Devices (All Frequency Bands): Category I Equipment

4 Test environment

Temperature:	T_{nom}	+22 °C during room temperature tests
	T_{max}	+55 °C during high temperature tests
	T_{min}	-20 °C during low temperature tests
Relative humidity content:		39 %
Barometric pressure:		not relevant for this kind of testing
Power supply:	V_{nom}	3.7 V DC by Li-ion battery BA900
	V_{max}	4.1 V
	V_{min}	3.3 V

5 Test item

Kind of test item	:	GSM Mobile Phone GPRS/EGPRS 850/900/1800/1900; UMTS FDDI/FDDV/FDDVI/FDDXIX; HSPA; LTE Band 1; BT3.1; WLAN a/b/g/n; AGPS; RFID, FM Rx
Type identification	:	PM-0000-BV
S/N serial number	:	CB5A1JYNE8
HW hardware status	:	AP1
SW software status	:	7.0.D.0.80
Frequency band [MHz]	:	5250 MHz – 5350 MHz ISM band 2 (lowest channel 5260; highest channel 5320 MHz) 5470 MHz – 5725 MHz ISM band 3 (lowest channel 5500; highest channel 5700 MHz)
Type of radio transmission	:	DSSS & OFDM
Use of frequency spectrum	:	
Channel access method	:	FDMA
Type of modulation	:	BPSK, QPSK, 16 – & 64 – QAM
Number of channels	:	ISM band 2: 4 ISM band 3: 11
Antenna	:	Integrated antenna
Power supply	:	3.7 V DC by Li-ion battery BA900
Temperature range	:	-20°C to +55 °C

6 Test laboratories sub-contracted

None

7 Summary of measurement results

- No deviations from the technical specifications were ascertained
- There were deviations from the technical specifications ascertained

TC Identifier	Description	Verdict	Date	Remark
DFS-Testing	CFR Part 15 RSS 210, Issue 8, Annex 8	Pass	2012-06-13	only DFS

Test Report Clause	Test Case	Temperature / Voltage	Pass	Fail	NA	NP	Results (max.)
§15.407 (h)(2) (iii)	Channel move time and channel closing transmission time	nominal / nominal	<input checked="" type="checkbox"/>	<input type="checkbox"/>	<input type="checkbox"/>	<input type="checkbox"/>	complies
§15.407 (h)(2) (iv)	Non-Occupancy Period	nominal / nominal	<input checked="" type="checkbox"/>	<input type="checkbox"/>	<input type="checkbox"/>	<input type="checkbox"/>	complies

Note: NA = Not Applicable; NP = Not Performed

8 RF measurements

8.1 Description of test setup

8.1.1 Conducted measurements

Setup

Figure 1 shows a setup whereby the UUT is a RLAN device operating in slave mode, without Radar Interference Detection function. This setup also contains a RLAN device operating in master mode. The radar test signals are injected into the master device. The UUT (slave device) is associated with the master device.

Figure 1 shows an example

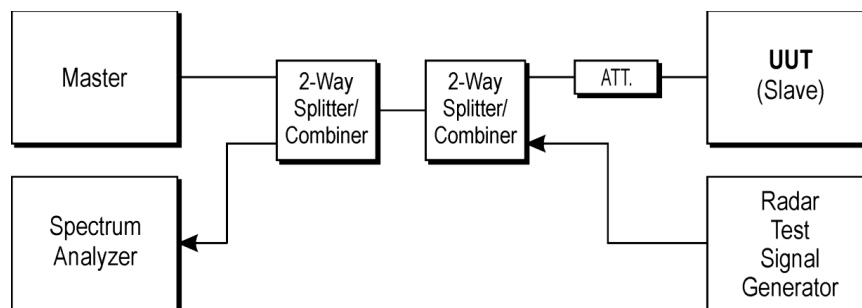

Figure 1: Setup

8.1.2 Parameters of DFS test signals

1. Interference Threshold values, Master or Client incorporating In-Service Monitoring

Maximum Transmit Power	Value (see note)
≥ 200 mW	-64 dBm
< 200 mW	-62 dBm
<p>Note 1: This is the level at the input of the receiver assuming a 0 dBi receive antenna Note 2: Throughout these test procedures an additional 1 dB has been added to the amplitude of the test transmission waveforms to account for variations in measurement equipment. This will ensure that the test signal is at or above the detection threshold level to trigger a DFS response.</p>	

2. DFS Response requirement values

Parameter	Value
Non-occupancy period	minimum 30 minutes
Channel Availability Check Time	60 seconds
Channel Move Time	10 seconds See Note 1.
Channel Closing Transmission Time	200 milliseconds + an aggregate of 60 milliseconds over remaining 10 second period. See Notes 1 and 2.
U-NII Detection Bandwidth	Minimum 80% of the 99% transmission power bandwidth See Note 3.
<p>Note 1: The instant that the Channel Move Time and the Channel Closing Transmission Time begins is as follows:</p> <ul style="list-style-type: none"> • For the Short pulse radar Test Signals this instant is the end of the Burst. • For the Frequency Hopping radar Test Signal, this instant is the end of the last radar Burst generated. • For the Long Pulse radar Test Signal this instant is the end of the 12 second period defining the radar transmission. <p>Note 2: The Channel Closing Transmission Time is comprised of 200 milliseconds starting at the beginning of the Channel Move Time plus any additional intermittent control signals required to facilitate Channel changes (an aggregate of 60 milliseconds) during the remainder of the 10 second period. The aggregate duration of control signals will not count quiet periods in between transmissions.</p> <p>Note 3: During the U-NII Detection Bandwidth detection test, radar type 1 is used and for each frequency step the minimum percentage of detection is 90%. Measurements are performed with no data traffic.</p>	

8.2 DFS test results

8.2.1 Channel move time / channel closing transmission time

Description:

Channel Move Time. After a radar's presence is detected, all transmissions shall cease on the operating channel within 10 seconds. Transmissions during this period shall consist of normal traffic for a maximum of 200 ms after detection of the radar signal. In addition, intermittent management and control signals can be sent during the remaining time to facilitate vacating the operating channel.

Test Procedure:

Perform the test with one of the type 1 to type 4 short pulse radar waveforms.

Result: Channel 116

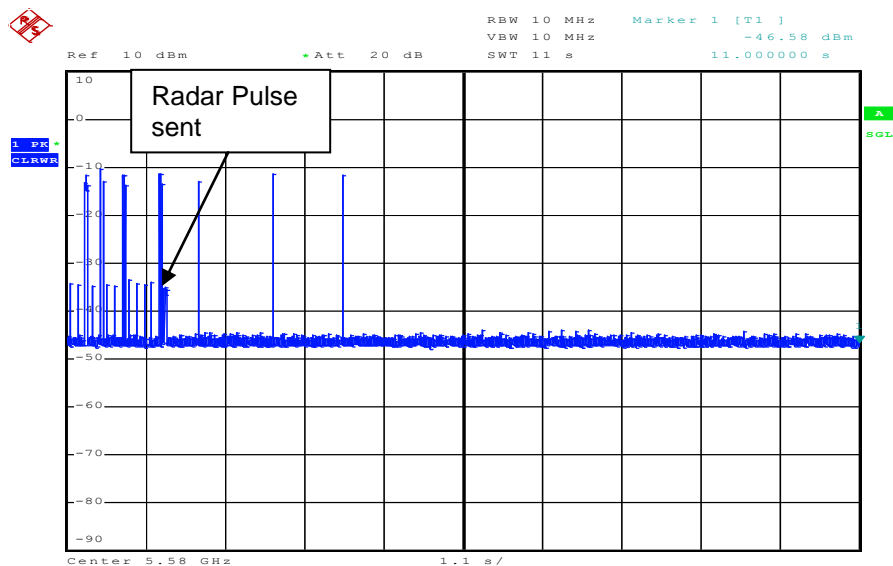

Date: 11.JUN.2012 10:24:40

The arrow shows the time of the radar pulse. On the plot you can see that no transmissions occur from the AP after sending the radar burst. The time difference between the recognition of the radar burst by the AP and its last transmission is called as Channel Move Time (Limit: 10 s). The accumulated transmission time of the AP and for the slave device after detection of a radar signal is called channel closing transmission time (Limit: in total 200 ms + 60 ms).

The accumulated channel closing transmission time after 200ms of the slave device is less than 60 ms.

Final verdict: Pass

8.2.2 Non-Occupancy Period

Description:

Non-occupancy Period. A channel that has been flagged as containing a radar system, either by a channel availability check or in-service monitoring, is subject to a non-occupancy period of at least 30 minutes. The non occupancy period starts at the time when the radar system is detected.

Test Procedure:

Client device is not permitted to transmit beacons on DFS frequencies.

- 1) Non-associated test:
The master has been off, monitor the analyzer on the test mode frequency that have been selected for testing, power up the client for 30 minutes to make sure no beacons have been transmitted.
- 2) Associated test:
Associate the master and client and stream the movie as specified for non- occupancy test. Transmit Radar type 1; monitor the test frequency to make sure no beacons have been transmitted for 30 minutes.

Mode	Results
Non-Associated	No Beacons transmit
Associated	No transmissions

Please refer to the following plots.

1) Non-associated:

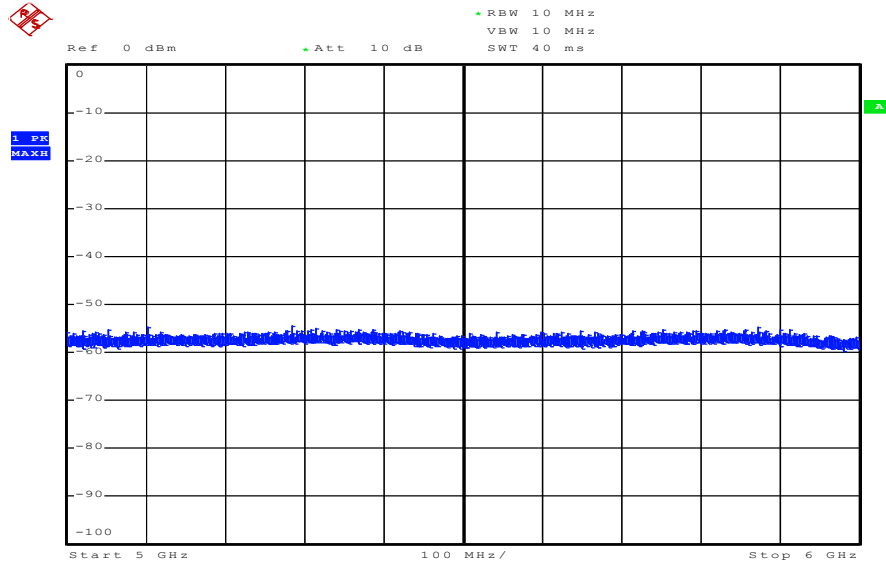

Date: 11.JUN.2012 16:42:44

The plot shows no transmissions over a 30 minutes period over the whole frequency band 5 GHz - 6 GHz.

2) Associated:

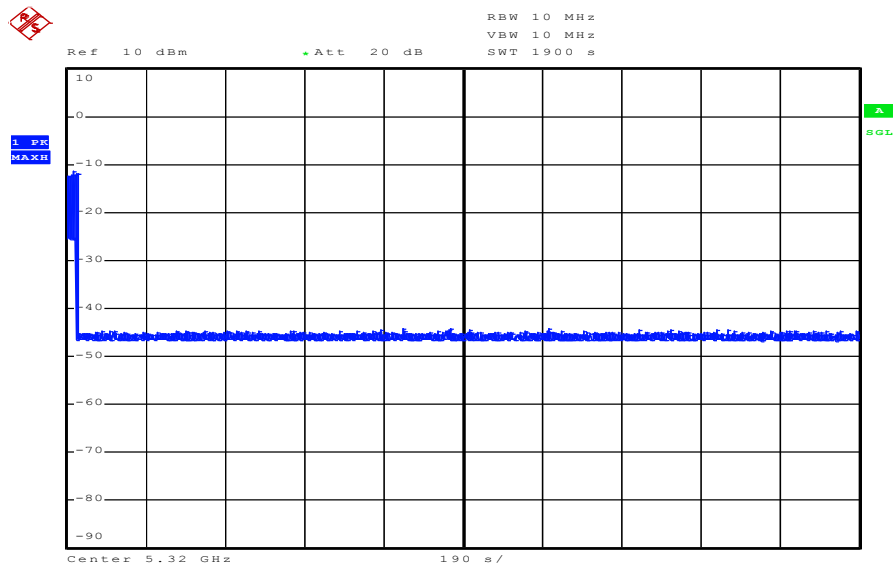

Date: 11.JUN.2012 13:16:51

In the plot above you can see, that the client does not transmit any emission within 30 minutes after having received the "stop transmit" order from the Access Point (DFS-Master).

Final verdict: Pass

9 Test equipment and ancillaries used for tests

Typically, the calibrations of the test apparatus are commissioned to and performed by an accredited calibration laboratory. The calibration intervals are determined in accordance with the DIN EN ISO/IEC 17025. In addition to the external calibrations, the laboratory executes comparison measurements with other calibrated test systems or effective verifications. Weekly chamber inspections and range calibrations are performed. Where possible, rf-generating and signalling equipment as well as measuring receivers and analyzers are connected to an external high-precision 10 MHz reference (GPS-based or rubidium frequency standard).

In order to simplify the identification of the equipment used at some special tests, some items of test equipment and ancillaries can be provided with an identifier or number in the equipment list below (Lab/Item).

No.	Lab / Item	Equipment	Type	Manufact.	Serial No.	INV. No Cetecom	Kind of Calibration	Last Calibration	Next Calibration
1	n. a.	Spectrum Analyzer 20 Hz - 50 GHz	FSU50	R&S	200012	300003443	ve	01.07.2010	01.07.2012
2	n. a.	Signal Generator	SMU200A	Rohde & Schwarz	101633	300003496	k	19.08.2011	19.08.2014
3	n. a.	Power-Splitter	11667B	Hewlett Packard	00616	300002421	ev		
4	n. a.	Power-Splitter	DMS 211	Technical Research Manufacturing Inc.	9321		ev		
5	U025	Cables	Sucotest 18	Huber & Suhner	div.		ev		
6		Attenuator 30dB, k-con.	Inmet	40A-30dB	div.		ev		

Agenda: Kind of Calibration

k	calibration / calibrated	EK	limited calibration
ne	not required (k, ev, izw, zw not required)	zw	cyclical maintenance (external cyclical maintenance)
ev	periodic self verification	izw	internal cyclical maintenance
Ve	long-term stability recognized	g	blocked for accredited testing
vkl!	Attention: extended calibration interval		
NK!	Attention: not calibrated	*)	next calibration ordered / currently in progress

10 Observations

No observations exceeding those reported with the single test cases have been made.

Annex A Photographs of the test setup

Photo documentation:

Photo 1:



Annex B External photographs of the EUT

Photo documentation:

Photo 1:



Photo 2:



Photo 3:



Photo 4:

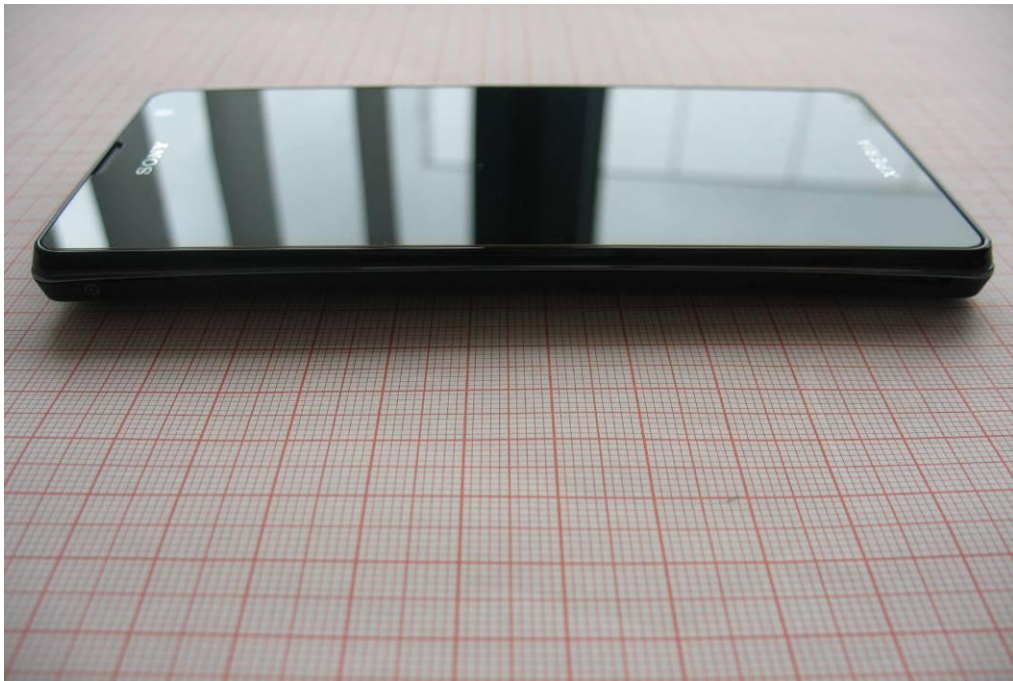

Photo 5:

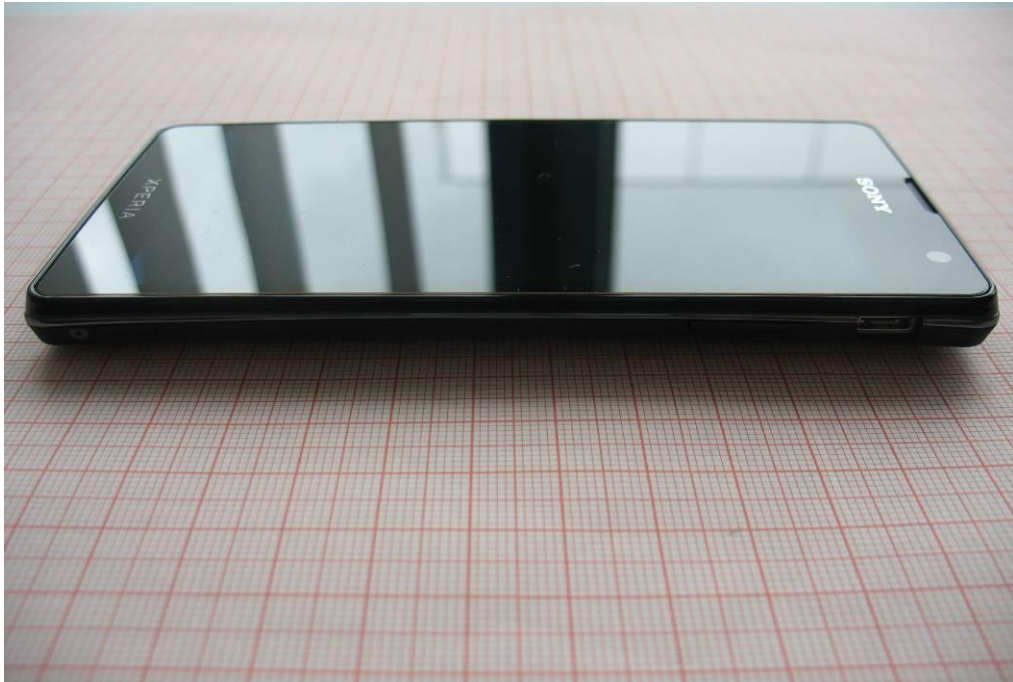

Photo 6:



Photo 7:



Photo 8:



Photo 9:



Photo 10:



Photo 11:



Annex C Internal photographs of the EUT

Photo documentation:

Photo 1:



Photo 2:

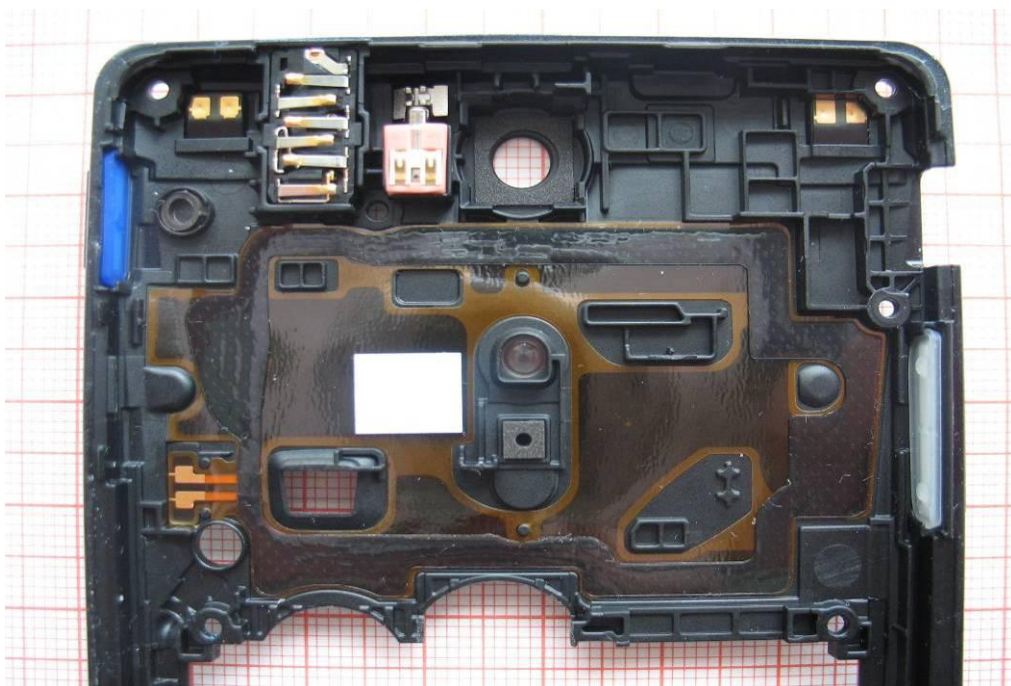

Photo 3:

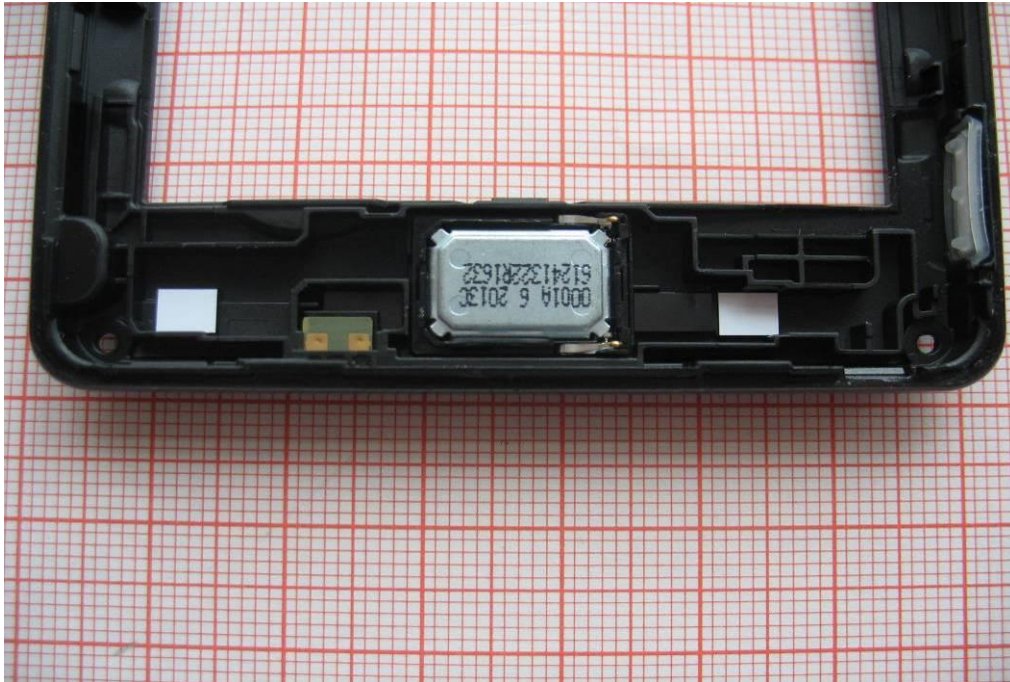

Photo 4:



Photo 5:



Photo 6:

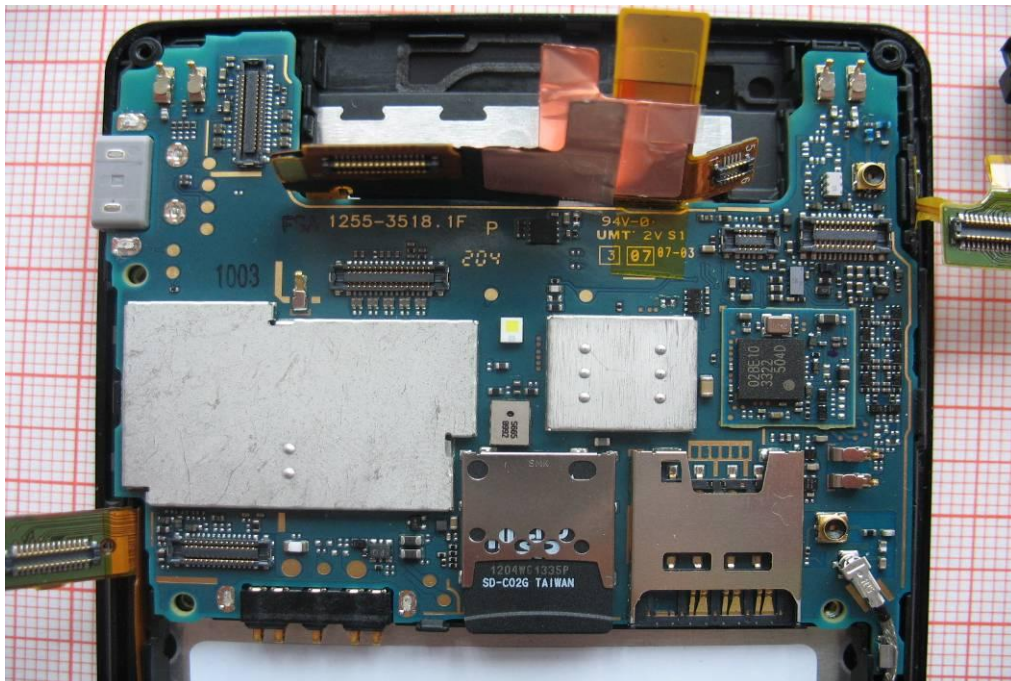

Photo 7:

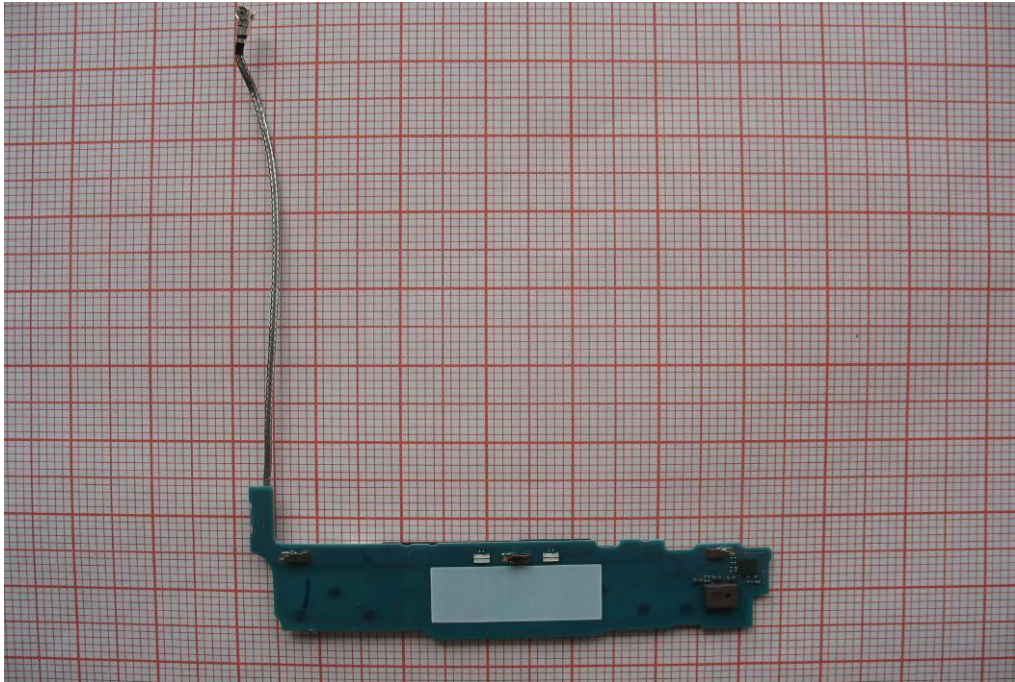

Photo 8:

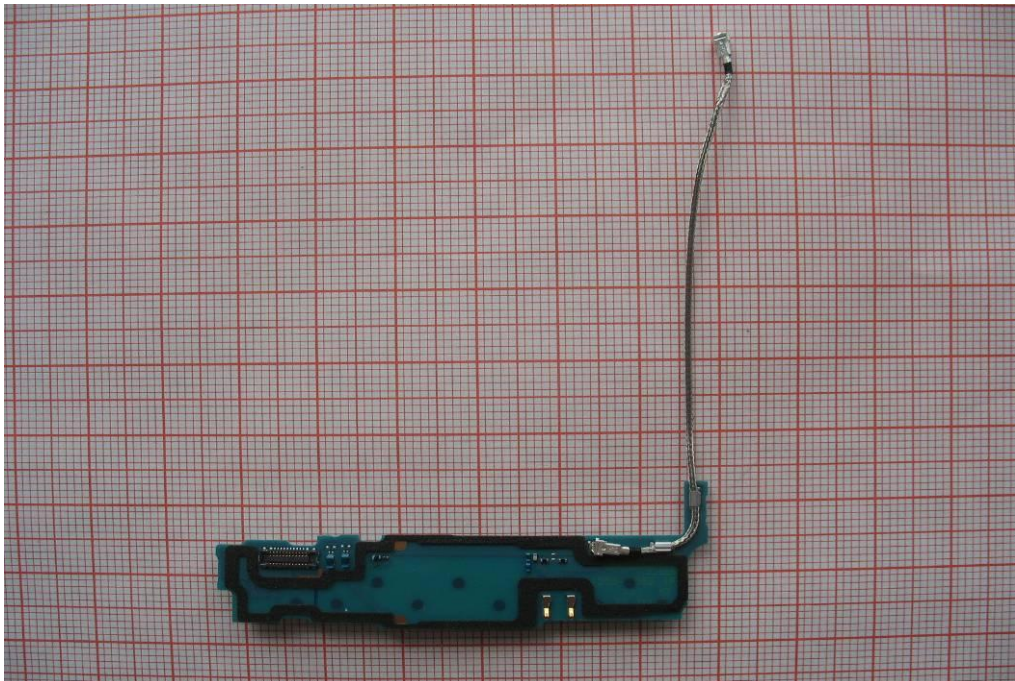

Photo 9:

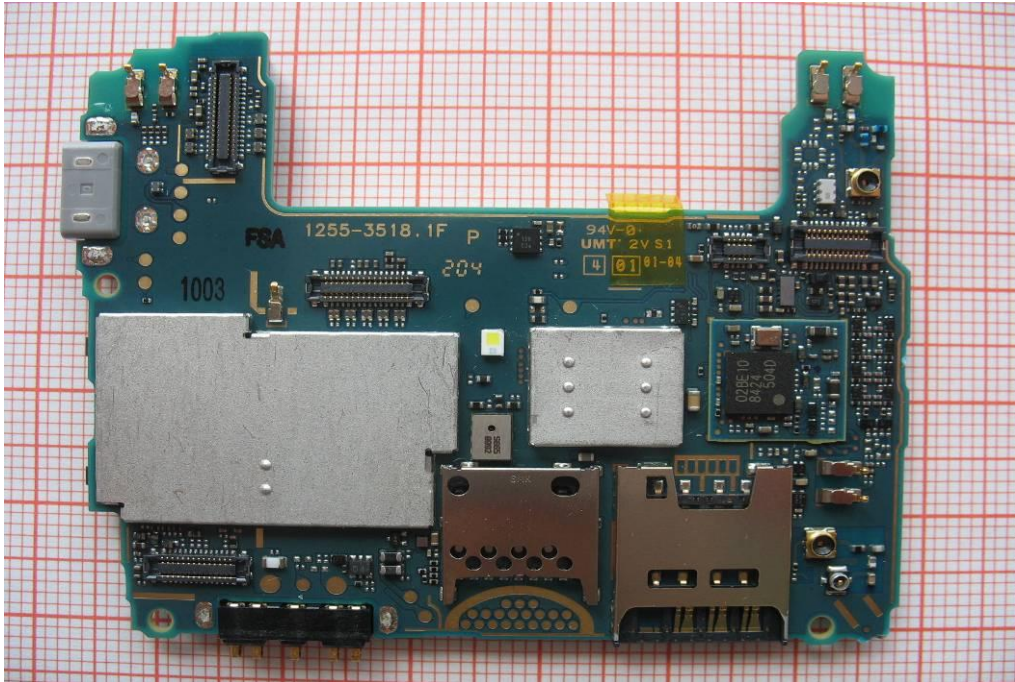

Photo 10:

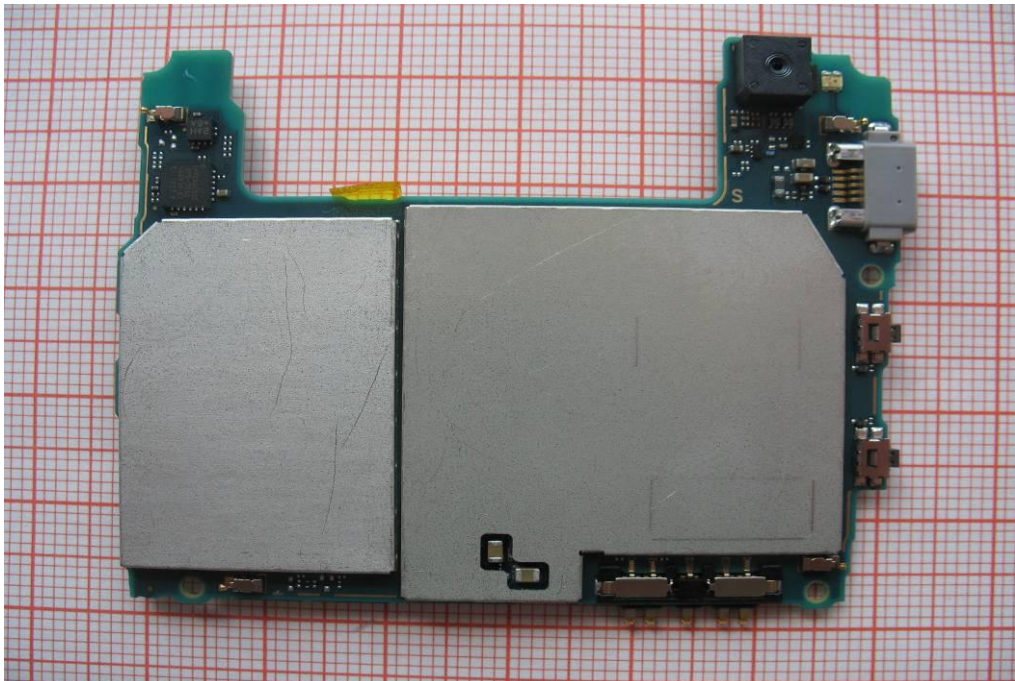

Photo 11:

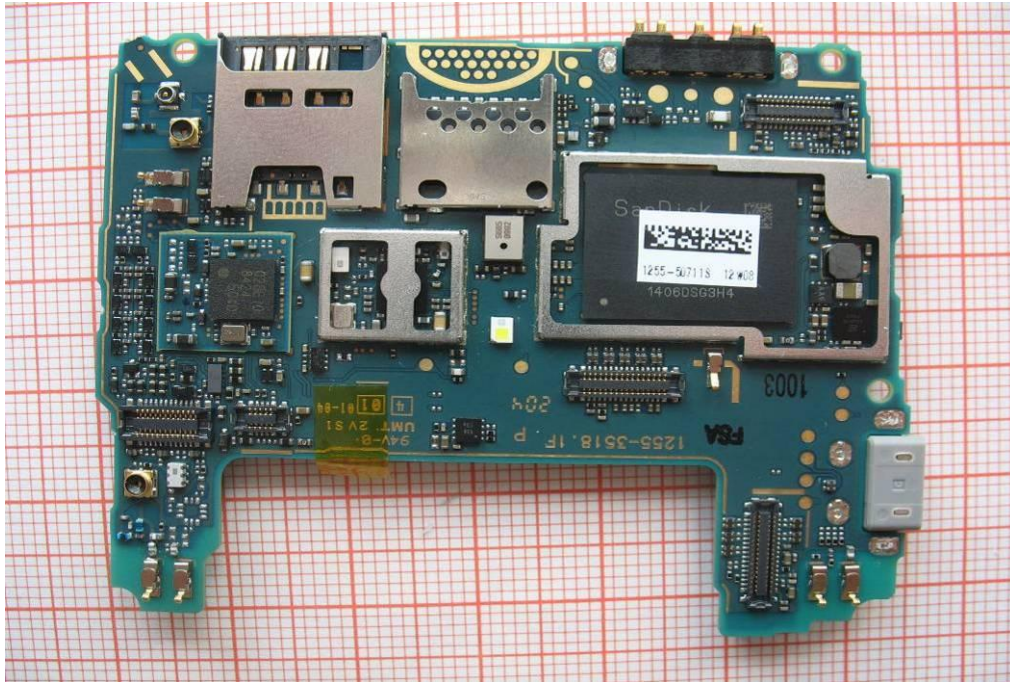

Photo 12:



Photo 13:

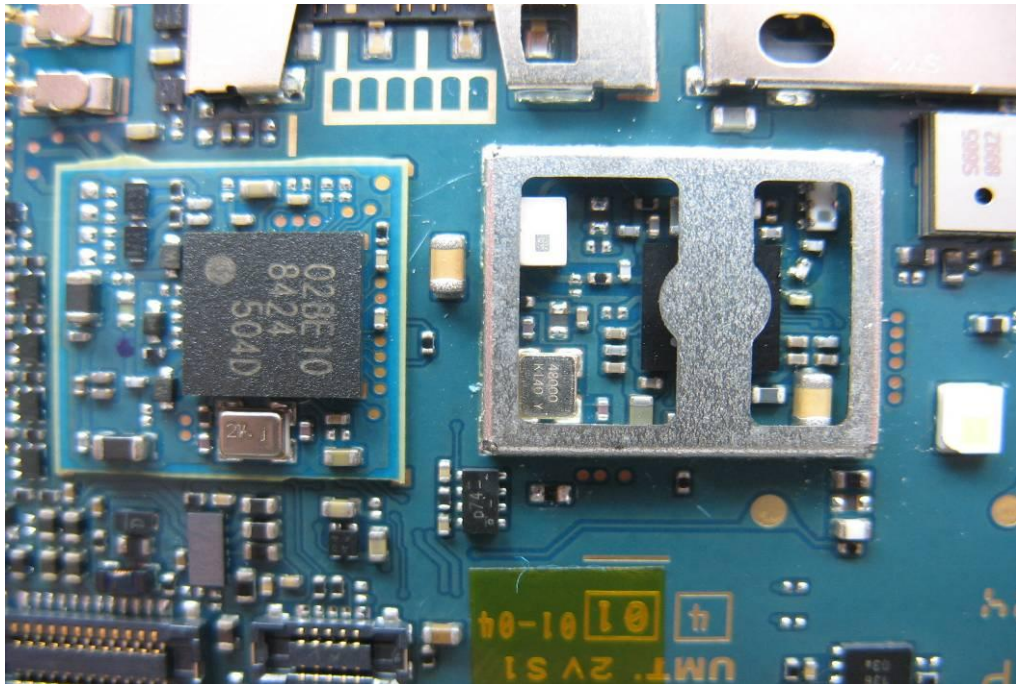

Photo 14:

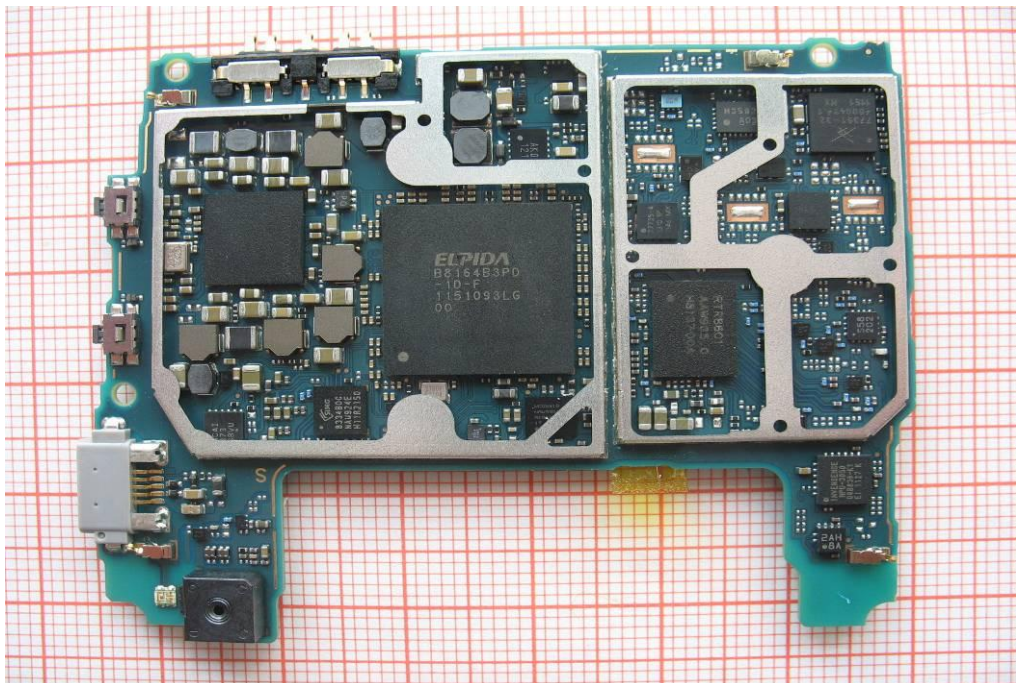

Photo 15:

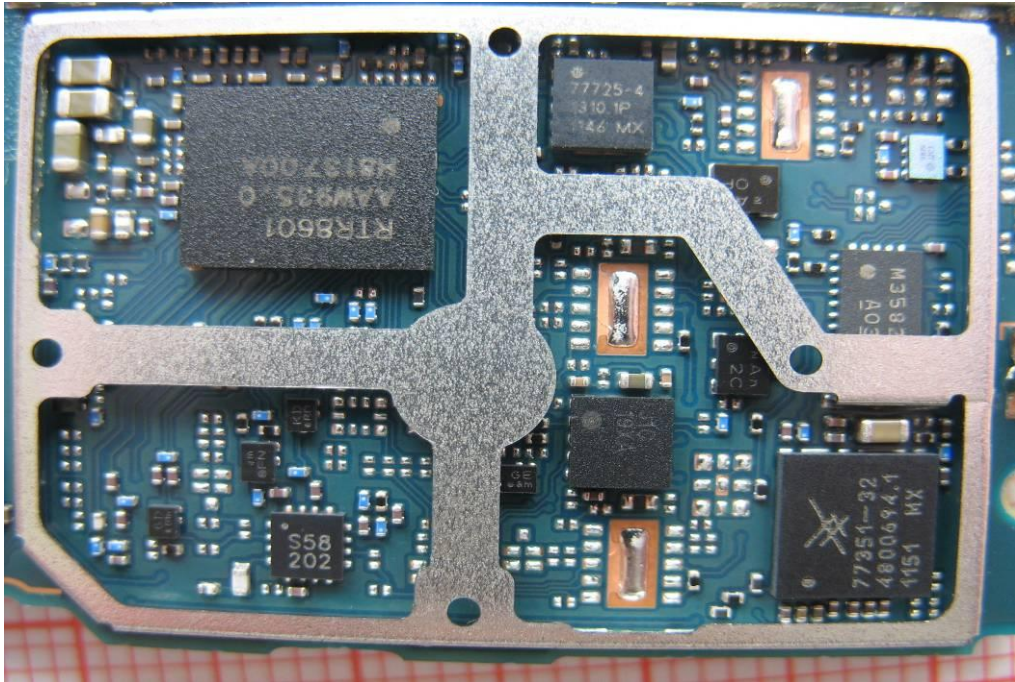
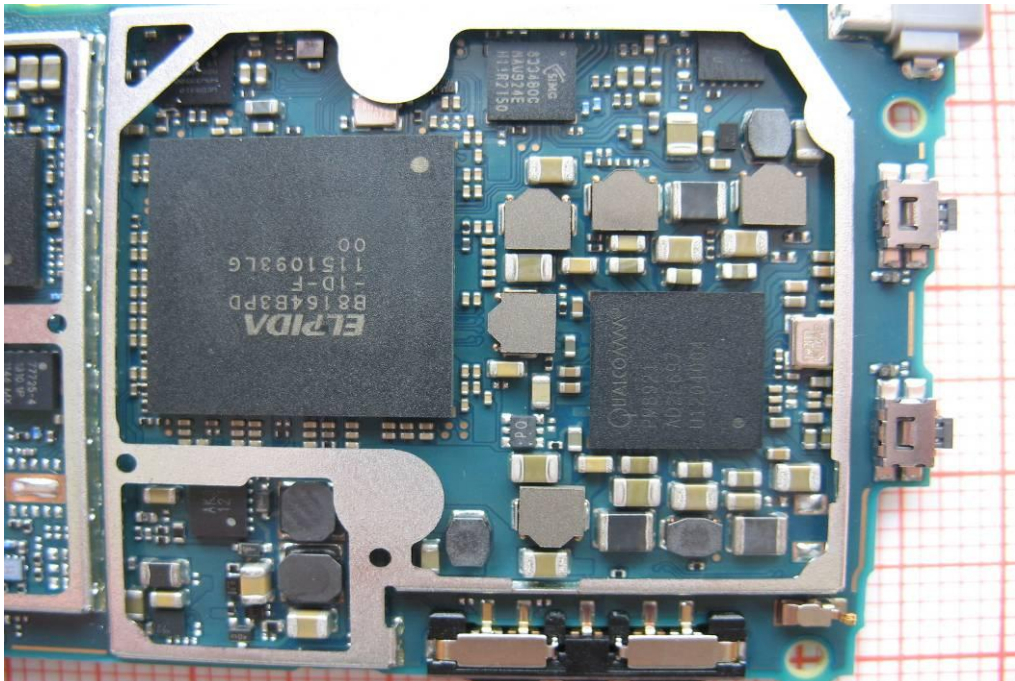

Photo 16:



Annex D Document history

Version	Applied changes	Date of release
1.0	Initial release	2012-06-13
-A	Changed IC certification number	2012-06-25

Annex E Further information**Glossary**

AVG	-	Average
DUT	-	Device under test
EMC	-	Electromagnetic Compatibility
EN	-	European Standard
EUT	-	Equipment under test
ETSI	-	European Telecommunications Standard Institute
FCC	-	Federal Communication Commission
FCC ID	-	Company Identifier at FCC
HW	-	Hardware
IC	-	Industry Canada
Inv. No.	-	Inventory number
N/A	-	Not applicable
PP	-	Positive peak
QP	-	Quasi peak
S/N	-	Serial number
SW	-	Software

Annex F Accreditation Certificate



Deutsche Akkreditierungsstelle GmbH
German Accreditation Body

Entrusted according to Section 8 subsection 1 AkkStelleG in connection with Section 1 subsection 1 AkkStelleGBV
Signatory to the Multilateral Agreements of EA, ILAC and IAF for Mutual Recognition

Accreditation



The Deutsche Akkreditierungsstelle GmbH (German Accreditation Body) attests that the testing laboratory

CETECOM ICT Services GmbH
Untertürkheimer Straße 6-10
66117 Saarbrücken

is competent under the terms of DIN EN ISO/IEC 17025:2005 to carry out tests in the following fields:

- Wired communications and DECT
- Acoustic
- Radio
- Short Range Devices (SRD)
- RFID
- WiMax and Richtfunk
- Mobile radio (GSM / DCS), Over the Air (OTA) Performance
- Electromagnetic Compatibility (EMC) incl. Automotive
- Product safety
- SAR and Hearing Aid Compatibility (HAC)
- Environmental simulation
- Smart Card Terminals
- Bluetooth
- Wi-Fi-Services

The accreditation certificate shall only apply in connection with the notice of accreditation of 13.04.2011 with the accreditation number D-PL-12076-01 and is valid until 03.09.2014. It comprises the cover sheet, the reverse side of the cover sheet and the following annex with a total of 82 pages.

Registration number of the certificate: **D-PL-12076-01-01**

Frankfurt am Main, 13.04.2011

Dipl.-Ing. (FH) Eger
Head of Division 2

This document is a translation. The definitive version is the original German accreditation certificate.
See annex overleaf.

Deutsche Akkreditierungsstelle GmbH

Office Berlin
Spittelmarkt 10
10117 Berlin

Office Frankfurt am Main
Gartenstraße 6
60594 Frankfurt am Main

Office Braunschweig
Bundesallee 100
38116 Braunschweig

The publication of extracts of the accreditation certificate is subject to the prior written approval by Deutsche Akkreditierungsstelle GmbH (DAKKS). Exempted is the unchanged form of separate disseminations of the cover sheet by the conformity assessment body mentioned overleaf.

No impression shall be made that the accreditation also extends to fields beyond the scope of accreditation attested by DAKKS.

The accreditation was granted pursuant to the Act on the Accreditation Body (AkkStelleG) of 31 July 2009 (Federal Law Gazette I p. 2625) and the Regulation (EC) No 765/2008 of the European Parliament and of the Council of 9 July 2008 setting out the requirements for accreditation and market surveillance relating to the marketing of products (Official Journal of the European Union L 218 of 9 July 2008, p. 30). DAKKS is a signatory to the Multilateral Agreements for Mutual Recognition of the European co-operation for Accreditation (EA), International Accreditation Forum (IAF) and International Laboratory Accreditation Cooperation (ILAC). The signatories to these agreements recognise each other's accreditations.

The up-to-date state of membership can be retrieved from the following websites:
EA: www.european-accreditation.org
ILAC: www.ilac.org
IAF: www.iaf.nu

Front side of certificate

Back side of certificate

Note:

The current certificate including annex is published on our website (see link below) or may be received from CETECOM ICT Services on request.

http://www.cetecom.com/fileadmin/de/CETECOM_D_Saarbruecken/accreditations_Jan_2010/DAKKS_Akkredi_Urk_EN17025-En_incl_Annex.pdf