

Bluetooth™ Headset
HBH-IV835
English
Language
Language
Language

Draft for Sony Ericsson Internal Use Only

Sony Ericsson

Bluetooth™ Headset HBH-IV835



2

User Guide
User Guide
User Guide
User Guide

FCC statement

This device complies with part 15 of the FCC rules. Operation is subject to the following two conditions: (1) This device may not cause harmful interference, and (2) This device must accept any interference received, including interference that may cause undesired operation.

Sony Ericsson HBH-IV835

This manual is published by Sony Ericsson Mobile Communications AB, without any warranty. Improvements and changes to this manual necessitated by typographical errors, inaccuracies of current information, or improvements to programs and/or equipment, may be made by Sony Ericsson Mobile Communications AB at any time and without notice. Such changes will, however, be incorporated into new editions of this manual. All rights reserved.

©Sony Ericsson Mobile Communications AB, 2005

Publication number: LZT 108 7941/x P5A

Some of the services in this manual are not supported by all networks. This also applies to the GSM International Emergency Number 112. Contact your network operator or service provider if you are in doubt whether you can use a particular service or not.

The Bluetooth word mark and logos are owned by the Bluetooth SIG, Inc. and any use of such marks by Sony Ericsson is under license.

This product is leadfree and halogenfree.



Draft for Sony Ericsson Internal Use Only

Introduction 3
Introduction
Introduction
Introduction

Bluetooth™ Headset HBH-IV835

The Bluetooth™ Headset HBH-IV835 can be connected to any device with Bluetooth wireless technology that supports the handsfree or headset profile. This user guide focuses on usage with a Sony Ericsson mobile phone.

Bluetooth™ Headset HBH-IV835

The Bluetooth™ Headset HBH-IV835 can be connected to any device with Bluetooth wireless technology that supports the handsfree or headset profile. This user guide focuses on usage with a Sony Ericsson mobile phone.

Bluetooth™ Headset HBH-IV835

The Bluetooth™ Headset HBH-IV835 can be connected to any device with Bluetooth wireless technology that supports the handsfree or headset profile. This user guide focuses on usage with a Sony Ericsson mobile phone.

Bluetooth™ Headset HBH-IV835

The Bluetooth™ Headset HBH-IV835 can be connected to any device with Bluetooth wireless technology that supports the handsfree or headset profile. This user guide focuses on usage with a Sony Ericsson mobile phone.

Draft for Sony Ericsson Internal Use Only

Front
Front
Front
Front

Charging connector
Charging connector
Charging connector
Charging connector

Indicator light
Indicator light
Indicator light
Indicator light

Call handling button
Call handling button
Call handling button
Call handling button

Draft for Sony Ericsson Internal Use Only

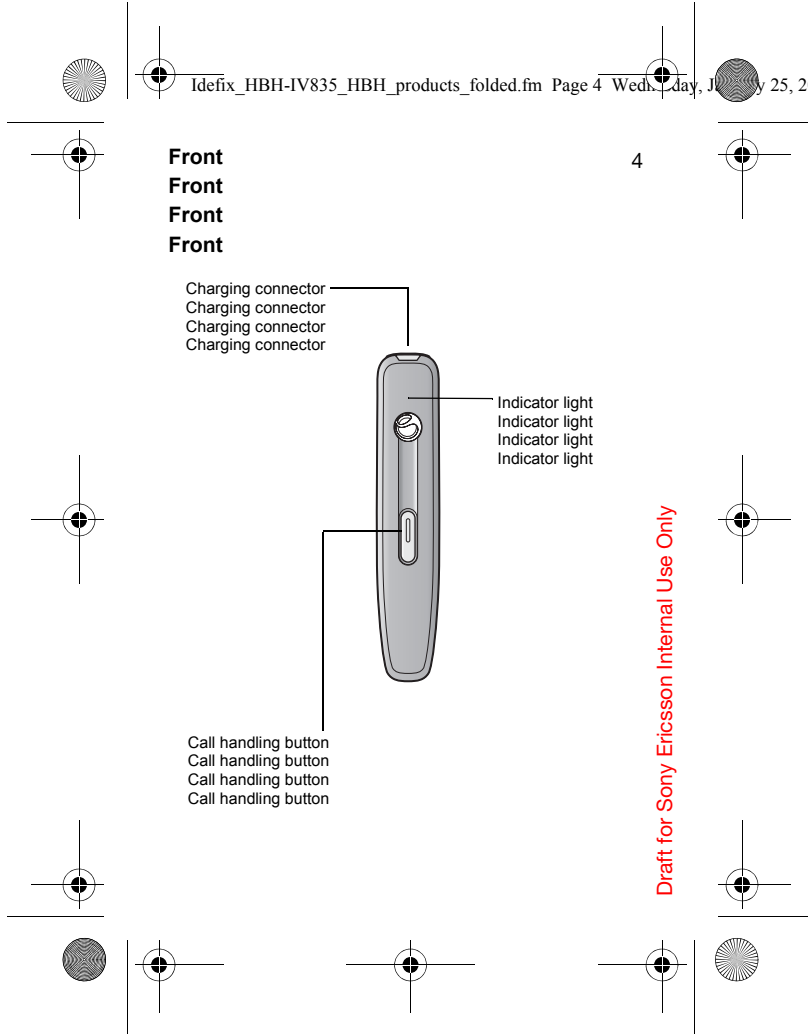

Back
Back
Back
Back

Power button
Power button
Power button
Power button

Speaker
Speaker
Speaker
Speaker

Microphone
Microphone
Microphone
Microphone



Draft for Sony Ericsson Internal Use Only

User Guide symbols
User Guide symbols
User Guide symbols
User Guide symbols

6



Press and release
Press and release
Press and release
Press and release



Press twice within 1/2 second
Press twice within 1/2 second
Press twice within 1/2 second
Press twice within 1/2 second



Press and hold
Press and hold
Press and hold
Press and hold



Press and hold simultaneously
Press and hold simultaneously
Press and hold simultaneously
Press and hold simultaneously



Steady red light
Steady red light
Steady red light
Steady red light



Steady green light
Steady green light
Steady green light
Steady green light

Draft for Sony Ericsson Internal Use Only

User Guide symbols (continued)
User Guide symbols (continued)
User Guide symbols (continued)
User Guide symbols (continued)



Red flash
Red flash
Red flash
Red flash



Green flash
Green flash
Green flash
Green flash



Beep tone
Beep tone
Beep tone
Beep tone



Ring signal
Ring signal
Ring signal
Ring signal

Draft for Sony Ericsson Internal Use Only

Getting started 8
Getting started
Getting started
Getting started

Chargers
Chargers
Chargers
Chargers

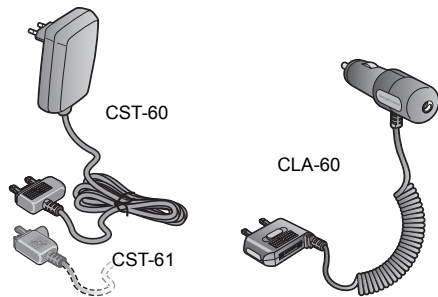

First time use: Charge approximately 8 hours.
First time use: Charge approximately 8 hours.
First time use: Charge approximately 8 hours.
First time use: Charge approximately 8 hours.

Draft for Sony Ericsson Internal Use Only

Charging
Charging
Charging
Charging

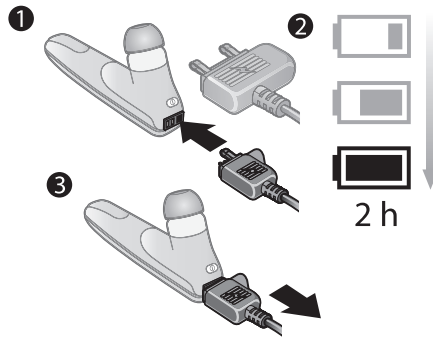

Charging
Charging
Charging
Charging



Fully charged
Fully charged
Fully charged
Fully charged



Battery needs charging
Battery needs charging
Battery needs charging
Battery needs charging

Draft for Sony Ericsson Internal Use Only

Adding the headset to the phone
Adding the headset to the phone
Adding the headset to the phone
Adding the headset to the phone

10

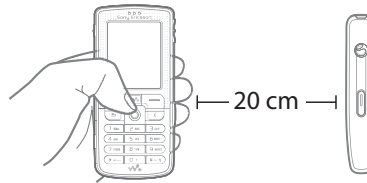

Before you can use your Bluetooth headset with your phone it has to be added once to the phone. Follow the instructions from the phone user guide on how to turn on Bluetooth in your phone.

1. Turn on Bluetooth in your phone.
2. Turn on Bluetooth visibility in your phone. This makes your phone visible to other Bluetooth devices.
3. Prepare your headset according to page 15.
4. If your phone supports auto pairing, press YES when Add device? appears in your phone to complete the procedure. If not, continue with step 5.

Draft for Sony Ericsson Internal Use Only

5. Prepare your phone according to the phone's user guide on how to add a Bluetooth device. Please note that for some phones you may need to enter a passcode. The headset passcode is 0000.

After you have added the headset to the phone, it will automatically connect to the phone as soon as it is turned on and within range.



The headset beeps and flashes green when successfully added
The headset beeps and flashes green when successfully added
The headset beeps and flashes green when successfully added
The headset beeps and flashes green when successfully added

Before you can use your Bluetooth headset with your phone it has to be added once to the phone. Follow the instructions from the phone user guide on how to turn on Bluetooth in your phone.

1. Turn on Bluetooth in your phone.
2. Turn on Bluetooth visibility in your phone. This makes your phone visible to other Bluetooth devices.
3. Prepare your headset according to page 15.

Draft for Sony Ericsson Internal Use Only

4. If your phone supports auto pairing, press YES when Add device? appears in your phone to complete the procedure. If not, continue with step 5.

5. Prepare your phone according to the phone's user guide on how to add a Bluetooth device. Please note that for some phones you may need to enter a passcode. The headset passcode is 0000.

After you have added the headset to the phone, it will automatically connect to the phone as soon as it is turned on and within range.



The headset beeps and flashes green when successfully added
The headset beeps and flashes green when successfully added
The headset beeps and flashes green when successfully added
The headset beeps and flashes green when successfully added

Before you can use your Bluetooth headset with your phone it has to be added once to the phone. Follow the instructions from the phone user guide on how to turn on Bluetooth in your phone.

1. Turn on Bluetooth in your phone.
2. Turn on Bluetooth visibility in your phone. This makes your phone visible to other Bluetooth devices.

Draft for Sony Ericsson Internal Use Only



3. Prepare your headset according to page 15. 13



4. If your phone supports auto pairing, press YES when Add device? appears in your phone to complete the procedure. If not, continue with step 5.

5. Prepare your phone according to the phone's user guide on how to add a Bluetooth device. Please note that for some phones you may need to enter a passcode. The headset passcode is 0000.

After you have added the headset to the phone, it will automatically connect to the phone as soon as it is turned on and within range.

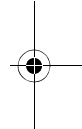
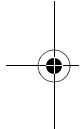

The headset beeps and flashes green when successfully added
The headset beeps and flashes green when successfully added
The headset beeps and flashes green when successfully added
The headset beeps and flashes green when successfully added

Before you can use your Bluetooth headset with your phone it has to be added once to the phone. Follow the

Draft for Sony Ericsson Internal Use Only



instructions from the phone user guide on how to turn on Bluetooth in your phone. 14

1. Turn on Bluetooth in your phone.
2. Turn on Bluetooth visibility in your phone. This makes your phone visible to other Bluetooth devices.
3. Prepare your headset according to page 15.
4. If your phone supports auto pairing, press YES when Add device? appears in your phone to complete the procedure. If not, continue with step 5.
5. Prepare your phone according to the phone's user guide on how to add a Bluetooth device. Please note that for some phones you may need to enter a passcode. The headset passcode is 0000.

After you have added the headset to the phone, it will automatically connect to the phone as soon as it is turned on and within range.



The headset beeps and flashes green when successfully added
The headset beeps and flashes green when successfully added
The headset beeps and flashes green when successfully added
The headset beeps and flashes green when successfully added

Draft for Sony Ericsson Internal Use Only

Prepare the headset
Prepare the headset
Prepare the headset
Prepare the headset

Make sure the headset is turned off (see p.19).
Make sure the headset is turned off (see p.19).
Make sure the headset is turned off (see p.19).
Make sure the headset is turned off (see p.19).

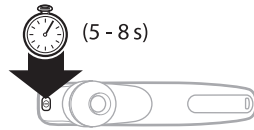

Make sure the indicator light flashes red/green
Make sure the indicator light flashes red/green
Make sure the indicator light flashes red/green
Make sure the indicator light flashes red/green

Draft for Sony Ericsson Internal Use Only

Range
Range
Range
Range

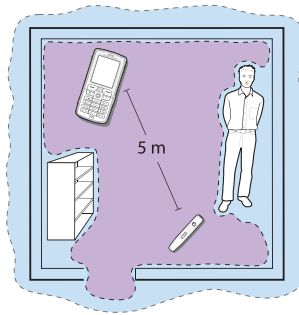

- Optimal performance
- Optimal performance
- Optimal performance
- Optimal performance
- Limited performance
- Limited performance
- Limited performance
- Limited performance

Draft for Sony Ericsson Internal Use Only

Putting the headset on
Putting the headset on
Putting the headset on
Putting the headset on

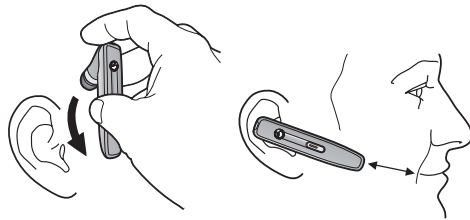
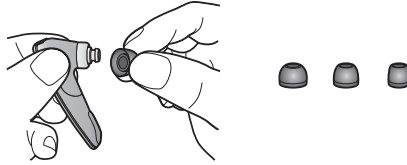

Make sure you place the earpiece firmly in your ear.
Make sure you place the earpiece firmly in your ear.
Make sure you place the earpiece firmly in your ear.
Make sure you place the earpiece firmly in your ear.

Draft for Sony Ericsson Internal Use Only

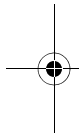

www.SonyEricsson.com

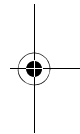

Sony Ericsson Mobile Communications AB
SE-221 88 Lund, Sweden

LZT 108 7941/x P5A
Printed in **XXXX**

Draft for Sony Ericsson Internal Use Only

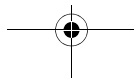
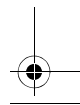
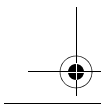

Calling 19
Calling
Calling
Calling

Turning the headset on (and off)
Turning the headset on (and off)
Turning the headset on (and off)
Turning the headset on (and off)

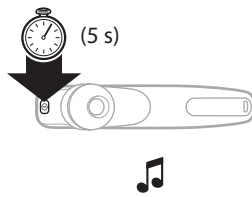

Indicator light when headset is on
Indicator light when headset is on
Indicator light when headset is on
Indicator light when headset is on

Warning! Loud volume could damage your hearing.
Warning! Loud volume could damage your hearing.
Warning! Loud volume could damage your hearing.
Warning! Loud volume could damage your hearing.

Draft for Sony Ericsson Internal Use Only

Draft for Sony Ericsson Internal Use Only

Answering a call
Answering a call
Answering a call
Answering a call

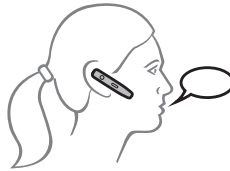
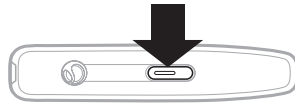

Draft for Sony Ericsson Internal Use Only

Making a call
Making a call
Making a call
Making a call

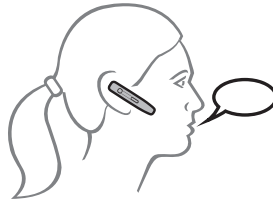
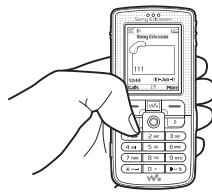

Draft for Sony Ericsson Internal Use Only



Using voice commands
Using voice commands
Using voice commands
Using voice commands



Voice commands, such as dial, redial, answer and reject, can be useful when using the headset. For more information on voice commands, and to know if your phone supports it, refer to the phone user guide.

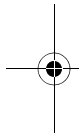

Voice commands, such as dial, redial, answer and reject, can be useful when using the headset. For more information on voice commands, and to know if your phone supports it, refer to the phone user guide.

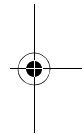

Voice commands, such as dial, redial, answer and reject, can be useful when using the headset. For more information on voice commands, and to know if your phone supports it, refer to the phone user guide.

Voice commands, such as dial, redial, answer and reject, can be useful when using the headset. For more information on voice commands, and to know if your phone supports it, refer to the phone user guide.

Draft for Sony Ericsson Internal Use Only



Making a call using voice commands
Making a call using voice commands
Making a call using voice commands
Making a call using voice commands

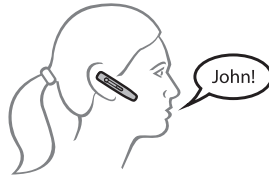
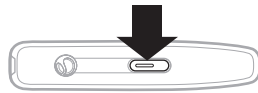

Draft for Sony Ericsson Internal Use Only

Redialling
Redialling
Redialling
Redialling

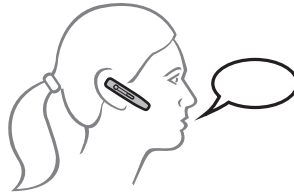
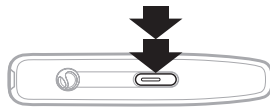

Draft for Sony Ericsson Internal Use Only

Transferring sound
Transferring sound
Transferring sound
Transferring sound

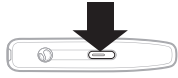

To transfer from headset to phone, refer to the phone user guide.

To transfer from headset to phone, refer to the phone user guide.

To transfer from headset to phone, refer to the phone user guide.

To transfer from headset to phone, refer to the phone user guide.

Draft for Sony Ericsson Internal Use Only

Ending a call
Ending a call
Ending a call
Ending a call

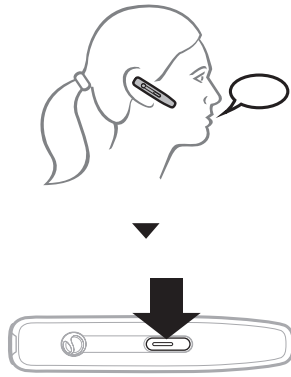

Draft for Sony Ericsson Internal Use Only



Rejecting a call
Rejecting a call
Rejecting a call
Rejecting a call

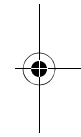
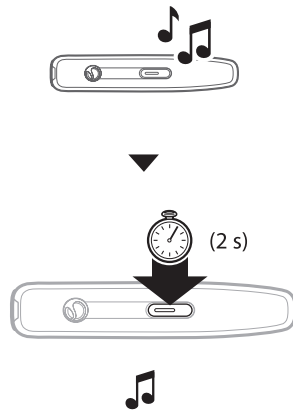
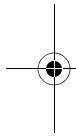

Draft for Sony Ericsson Internal Use Only

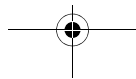

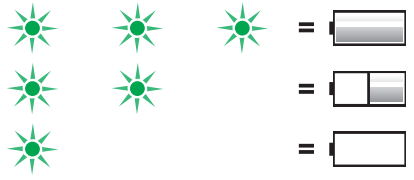
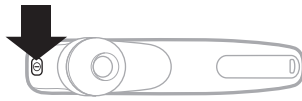

Draft for Sony Ericsson Internal Use Only

Settings 30
Settings
Settings
Settings

Adjusting speaker volume
Adjusting speaker volume
Adjusting speaker volume
Adjusting speaker volume

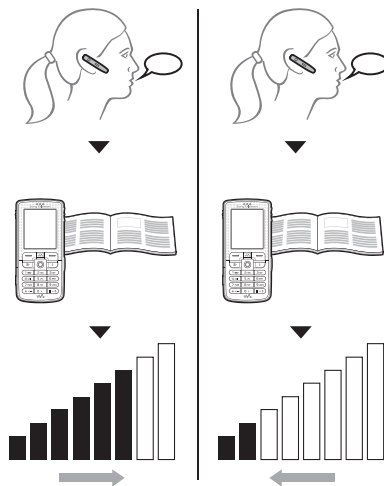

Draft for Sony Ericsson Internal Use Only



**Prepare the headset according to page 15.
Prepare the headset according to page 15.
Prepare the headset according to page 15.
Prepare the headset according to page 15.**

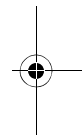
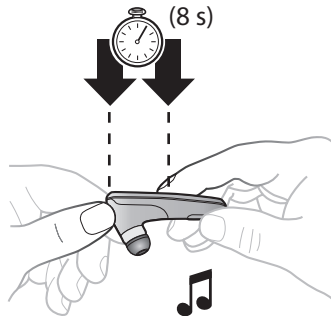
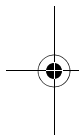

Draft for Sony Ericsson Internal Use Only



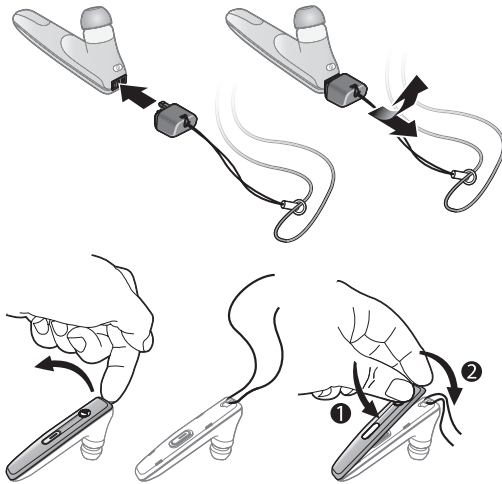
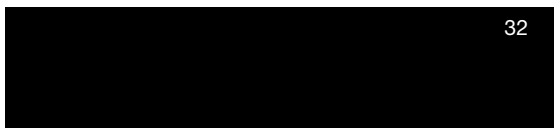

Check for regulatory information under the cover.
Check for regulatory information under the cover.
Check for regulatory information under the cover.
Check for regulatory information under the cover.

Draft for Sony Ericsson internal use only

No connection between headset and phone

Make sure the headset is charged and within range of the phone. Check or redo the Bluetooth settings in the phone. Try to pair the headset again (see p.10).

For more information on Bluetooth and pairing, go to www.sonyericsson.com/learnabout

The headset is automatically switched off

- The battery is too low. The indicator light on the headset flashes red and you hear a low beep.
- The headset switches off if you do not add it to the phone within 10 minutes.

Unexpected behaviour

Reset the headset (see p.31).

Battery capacity

A battery that has been infrequently used, or a new one, could have reduced capacity. It may need to be recharged a number of times.

Redial does not work

If the call list in the phone is empty you cannot use the redial function.

Draft for Sony Ericsson Internal Use Only



Voice commands

34

Make sure that voice commands are enabled and recorded in your phone before you start using them.

No connection between headset and phone

Make sure the headset is charged and within range of the phone. Check or redo the Bluetooth settings in the phone. Try to pair the headset again (see p.10).

For more information on Bluetooth and pairing, go to www.sonyericsson.com/learnabout

The headset is automatically switched off

- The battery is too low. The indicator light on the headset flashes red and you hear a low beep.
- The headset switches off if you do not add it to the phone within 10 minutes.

Unexpected behaviour

Reset the headset (see p.31).

Battery capacity

A battery that has been infrequently used, or a new one, could have reduced capacity. It may need to be recharged a number of times.

Redial does not work

If the call list in the phone is empty you cannot use the redial function.

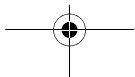
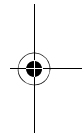
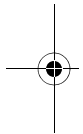

Voice commands

Make sure that voice commands are enabled and recorded in your phone before you start using them.

No connection between headset and phone

Make sure the headset is charged and within range of the phone. Check or redo the Bluetooth settings in the phone. Try to pair the headset again (see p.10).

For more information on Bluetooth and pairing, go to www.sonyericsson.com/learnabout

The headset is automatically switched off

- The battery is too low. The indicator light on the headset flashes red and you hear a low beep.
- The headset switches off if you do not add it to the phone within 10 minutes.

Unexpected behaviour

Reset the headset (see p.31).

Battery capacity

A battery that has been infrequently used, or a new one, could have reduced capacity. You may need to recharge it a number of times.

Redial does not work

If the call list in the phone is empty you cannot use the redial function.

Voice commands

Make sure that voice commands are enabled and recorded in your phone before you start using them.

Draft for Sony Ericsson Internal Use Only

No connection between headset and phone

Make sure the headset is charged and within range of the phone. Check or redo the Bluetooth settings in the phone. Try to pair the headset again (see p.10).

For more information on Bluetooth and pairing, go to www.sonyericsson.com/learnabout

The headset is automatically switched off

- The battery is too low. The indicator light on the headset flashes red and you hear a low beep.
- The headset switches off if you do not add it to the phone within 10 minutes.

Unexpected behaviour

Reset the headset (see p.31).

Battery capacity

A battery that has been infrequently used, or a new one, could have reduced capacity. It may need to be recharged a number of times.

Redial does not work

If the call list in the phone is empty you cannot use the redial function.

Voice commands

Make sure that voice commands are enabled and recorded in your phone before you start using them.

www.sonyericsson.com/support/

Draft for Sony Ericsson Internal Use Only

Declaration of conformity 37

We, **Sony Ericsson Mobile Communications AB**
of
Nya Vattentorget
221 88 Lund, Sweden
declare under our sole responsibility that our product
Sony Ericsson type DDA-0002003

to which this declaration relates is in conformity with the appropriate standards EN 300 328, EN 301 489-17, EN 301 489-7 and EN 60950 following the provisions of Radio Equipment and Telecommunication Equipment directive **1999/5/EC** with requirements covering EMC directive **89/336/EEC** and Low Voltage directive **73/23/EEC**.

Lund, November 2005



CE 0682

Ulf Persson, Head of Product Business Unit Accessories

We fulfill the R&TTE Directive.

We fulfill the R&TTE Directive.

We fulfill the R&TTE Directive.

We fulfill the R&TTE Directive.

Draft for Sony Ericsson Internal Use Only