

Congratulations on your purchase of the Sony Ericsson Z610i. A sleek clamshell mobile phone designed to impress. In addition to the pre-installed Z610i content, you have more waiting for you at www.sonyericsson.com/fun.

And if you register at www.sonyericsson.com/register, you get an exclusive offer. Don't miss out. Go there now.

Added dimensions – Accessories from Sony Ericsson

Desk Stand CDS-60

Your phone's best assistant: connect a USB cable, charger and portable handsfree.



Bluetooth™ Headset HBH-PV705

A powerful Bluetooth™ headset with compact design.



Stereo Portable Handsfree HPM-65

Light design with ear-hook for a stable fit.



The full range of accessories may not be available in every market.

Contents

Getting started	4
Getting to know the phone	8
Calling	17
Messaging	25
Imaging	29
Entertainment	31
Connectivity	33
More features	39
Important information	41
Index	51

www.sonyericsson.com/support
At Sony Ericsson Product Support there is more information and help to get the most out of your product:

User guide with additional information, troubleshooting, tips and tricks, software, settings for Internet and messaging.

Sony Ericsson

UMTS 2100 GSM 900/1800/1900

This user guide is published by Sony Ericsson Mobile Communications AB, without any warranty. Improvements and changes to this user guide necessitated by typographical errors, inaccuracies of current information, or improvements to programs and/or equipment, may be made by Sony Ericsson Mobile Communications AB at any time and without notice. Such changes will, however, be incorporated into new editions of this user guide.

All rights reserved.

©Sony Ericsson Mobile Communications AB, 2006

Publication number: EN/LZT 108 8254/1 R1A

Please note:

Some of the services in this user guide are not supported by all networks. *This also applies to the GSM International Emergency Number 112.*

Please contact your network operator or service provider if you are in doubt whether you can use a particular service or not.

Please read the *Guidelines for safe and efficient use* and the *Limited warranty* chapters before you use your mobile phone.

Your mobile phone has the capability to download, store and forward additional content, e.g. ringtones. The use of such content may be restricted or prohibited by rights of third parties, including but not limited to restriction under applicable copyright laws. You, and not Sony Ericsson, are entirely responsible for additional content that you download to or forward from your mobile phone. Prior to your use of any additional content, please verify that your intended use is properly licensed or is otherwise authorized. Sony Ericsson does not guarantee the accuracy, integrity or quality of any additional

content or any other third party content. Under no circumstances will Sony Ericsson be liable in any way for your improper use of additional content or other third party content.

Bluetooth™ is a trademark or registered trademark of Bluetooth SIG Inc.

PlayNow, MusicDJ, PhotoDJ and VideoDJ are trademarks or registered trademarks of Sony Ericsson Mobile Communications AB.

Memory Stick Micro™ and M2™ are registered trademarks of Sony Corporation.

Real is a trademark or a registered trademark of RealNetworks, Inc. RealPlayer® for Mobile is included under license from RealNetworks, Inc. Copyright 1995-2004, RealNetworks, Inc. All rights reserved.

Adobe™ Photoshop™ Album Starter Edition is a registered trademark of Adobe Systems Incorporated.

Microsoft, Windows is either a registered trademark or trademark of Microsoft Corporation in the U.S. and other countries.

Mac OS is a trademark of Apple Computer, Inc., registered in the U.S. and other countries.

T9™ Text Input is a trademark or a registered trademark of Tegic Communications. T9™ Text Input is licensed under one or more of the following: U.S. Pat. Nos. 5,818,437, 5,953,541, 5,187,480, 5,945,928, and 6,011,554; Canadian Pat. No. 1,331,057, United Kingdom Pat. No. 2238414B; Hong Kong Standard Pat. No. HK0940329; Republic of Singapore Pat. No. 51383; Euro.Pat. No. 0 842 463(96927260.8) DE/DK, FI, FR, IT, NL, PT, ES, SE, GB; and additional patents are pending worldwide.

Java and all Java based trademarks and logos are trademarks or registered trademarks of Sun Microsystems, Inc. in the U.S. and other countries.

End-user license agreement for Sun™ Java™ J2ME™.

- 1 Restrictions: Software is confidential copyrighted information of Sun and title to all copies is retained by Sun and/or its licensors. Customer shall not modify, decompile, disassemble, decrypt, extract, or otherwise reverse engineer Software. Software may not be leased, assigned, or sublicensed, in whole or in part.
- 2 Export Regulations: Software, including technical data, is subject to U.S. export control laws, including the U.S. Export Administration Act and its associated regulations, and may be subject to export or import regulations in other countries. Customer agrees to comply strictly with all such regulations and acknowledges that it has the responsibility to obtain licenses to export, re-export, or import Software. Software may not be downloaded, or otherwise exported or re-exported (i) into, or to a national or resident of, Cuba, Iraq, Iran, North Korea, Libya, Sudan, Syria (as such listing may be revised from time to time) or any country to which the U.S. has embargoed goods; or (ii) to anyone on the U.S. Treasury Department's list of Specially Designated Nations or the U.S. Commerce Department's Table of Denial Orders.
- 3 Restricted Rights: Use, duplication or disclosure by the United States government is subject to the restrictions as set forth in the Rights in Technical Data and Computer Software Clauses in DFARS 252.227-7013(c) (1) (ii) and FAR 52.227-19(c) (2) as applicable.

Part of the software in this product is copyright © SyncML initiative Ltd. (1999-2002). All rights reserved.

Other product and company names mentioned herein may be the trademarks of their respective owners.

Any rights not expressly granted herein are reserved.

Instruction symbols

The following appear in the User guide:



Note



A service or function is network- or subscription-dependent. Contact your network operator for details.



See also page...



Use a selection or navigation key to scroll and select

➤ *12 Navigation.*



Press the navigation key centre.



Press the upper part of the navigation key.



Press the lower part of the navigation key.



Press the left part of the navigation key.



Press the right part of the navigation key.

Getting started

SIM card and battery

To insert SIM card and battery

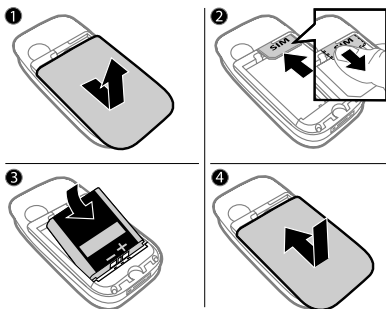

- 1 Remove the battery cover by pressing and sliding it as shown in the picture.
- 2 Slide the SIM card into its holder with the contacts facing down.
- 3 Insert the battery with the label side up and the connectors facing each other.
- 4 Slide the battery cover into place.

To charge the battery

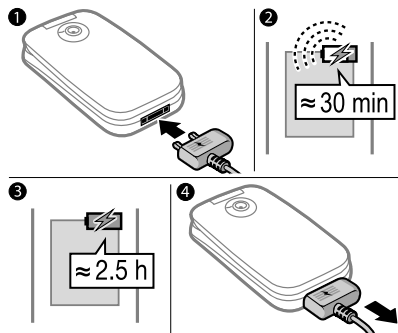



- 1 Connect the charger plug to the phone with the symbol facing upwards.
- 2 It may take up to 30 minutes before the battery icon appears.
- 3 Wait approximately 2.5 hours or until the battery icon indicates a full charge. Press a key to activate the screen.
- 4 Pull out the charger plug.

Turning on your phone

Make sure the phone is charged and a SIM card inserted before turning the phone on. After turning on, use the setup wizard to quickly and easily prepare for use.

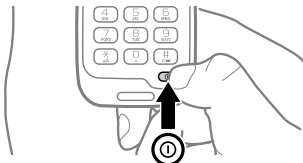
To turn on the phone



- 1 Open the phone.
- 2 Press and hold . The first start-up may take a few minutes.
- 3 Select to use the phone in:
 - **Normal** – full functionality or
 - **Flight mode** – limited functionality with network and Bluetooth™ transceivers off.
- 4 Enter your SIM card PIN, if requested.
- 5 At first start-up, select the language for your phone menus.
- 6 ► **Yes** for the setup wizard to help you.
- 7 Follow instructions to complete setup.

 *Predefined settings may already exist in your phone.*



You may be asked to register your phone at Sony Ericsson. If you accept to register your phone, no personal data, such as your phone number, will be transferred to or processed by Sony Ericsson.

Standby

After you have turned the phone on and entered your PIN, the name of the network operator will appear on the display. This is called standby mode.

Making calls

The phone must be in normal mode (not flight mode).

To make a call

- 1 Enter a phone number (with international prefix and area code if applicable).
- 2 ► **Call** to make a voice call or ► **More** ► **Make video call** to make a video call.
- 3 ► **More** for options during the call.
- 4 ► **End call** or close your phone to end the call.

Help in your phone

Help and information is available in your phone at any time.

To use the setup wizard

► **Settings** ► the **General** tab ► **Setup wizard** and select an option:

- **Settings download**

- Basic setup
- Tips and tricks

To view information about functions
Scroll to a function ► **More** ► **Info**, if available.



To view the phone demonstration
► **Entertainment** ► **Demo tour**.

Activity menu

You can open the activity menu almost anywhere in the phone to view and handle new events, and access bookmarks and shortcuts.

To open and close the activity menu
Press .

Activity menu tabs

- **New events** – when you have missed a call or received a new message, the **New events** tab appears. Press  to dismiss an event. New events can also be set to appear as pop-up text instead, ► **Settings** ► the **General** tab ► **New events** ► **Pop-up**.
- **Running apps** – applications that are running in the background. Select an application to return to it or press  to end it.

- **My shortcuts** – add, delete and change the order of shortcuts. When you select a shortcut and the application opens, other programs are closed or minimized.
- **Internet** – your Internet bookmarks. When you select a bookmark and the browser opens, other programs are closed or minimized.

PC Suite software

Enhance the experience of your phone by installing the PC Suite software on your computer. This allows you to, for example, synchronize your phone calendar with a computer calendar.

To install the PC Suite software

- 1 Turn on your computer and insert the CD that came with your phone into the CD drive of your computer. The CD starts automatically and the installation window opens.
- 2 **Computer:** Select a language and click *OK*.
- 3 **Computer:** Click *Install* in the PC Suite section and follow the instructions on the screen. When the installation is complete, the PC Suite icon appears on the desktop of your computer.

 *For the latest version of PC Suite, visit www.sonyericsson.com/support.*

Take pictures or record video clips

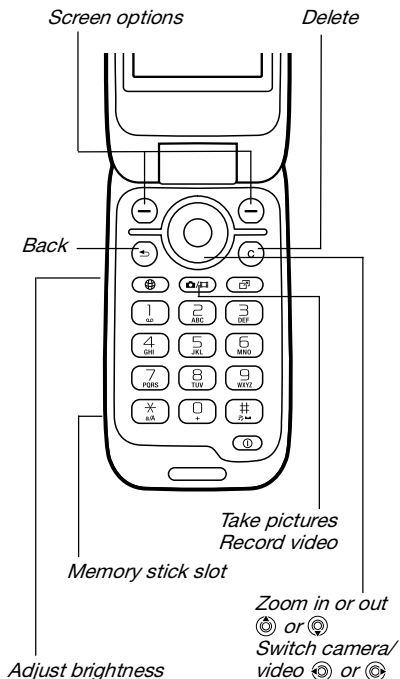

To take a picture or record video

- 1 From standby, press and hold **CAM** to activate the camera.
- 2 Use the navigation key to switch between camera and video recorder. 
- 3 **Camera**: Press **CAM** to take a picture.
Video: Press **CAM** to start recording. To stop recording, press **CAM** again.

Your pictures and video clips are automatically saved in File manager ► Camera album.

- 4 To take another picture or record another video clip, press **CAM** to return to the viewfinder.
To stop using the camera or video recorder, press and hold **END**.

Your personal Web page

Publish your pictures on a Web page. The phone creates the Web page for you.

To blog a photo







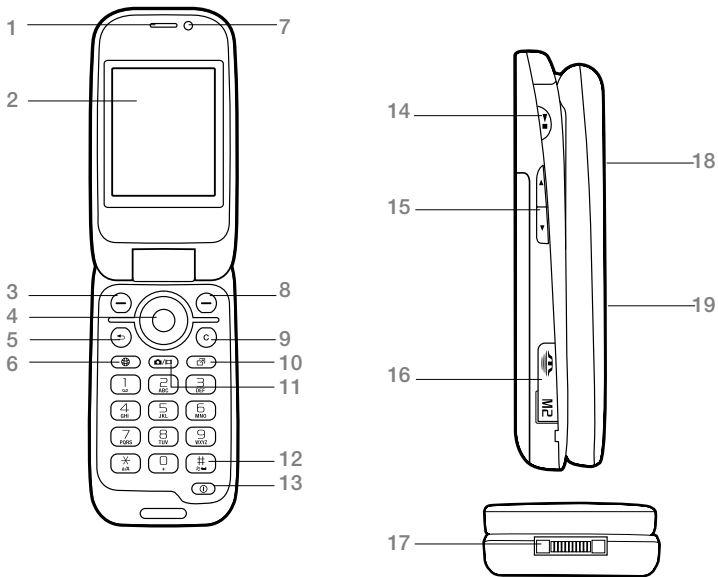



- 1 Take a photo ► **More** ► **Blog this**.
- 2 Follow the instructions for first time use.
- 3 Add title and text ► **OK** ► **Publish**.
- 4 You will receive a text message with your Web address and log-in data.

Getting to know the phone

Phone overview



 *Some icons on keys may differ.*

- 1 Ear speaker
- 2 Screen
- 3  Selection key
- 4 Navigation key/Music player control
- 5  Back key
- 6  Internet key
- 7 Video call camera
- 8  Selection key
- 9  Clear key
- 10  Activity menu key
- 11  Camera button
- 12  Silent key
- 13  Power on/off button
- 14  Play/stop button
- 15  Volume, camera adjust brightness buttons
- 16 Memory Stick Micro™ (M2™) slot
- 17 Connector for charger, handsfree and USB cable
- 18 Camera lens
- 19 External display

For more information ➔ *12 Navigation*

Menu overview



PlayNow™*



Internet*



Entertainment

- Online services*
- Games
- Video player
- VideoDJ™
- PhotoDJ™
- MusicDJ™
- Remote control
- Record sound
- Demo tour



Camera



Messaging

- Write new
- Inbox
- Email
- RSS reader
- Drafts
- Outbox
- Sent messages
- Saved messages
- My friends*
- Call voicemail
- Templates
- Settings



Music player

- Now playing
- Artists
- Tracks
- Playlists



File manager^{*/}**

- Camera album
- Music
- Pictures
- Videos
- Themes
- Web pages
- Games
- Applications
- Other



Contacts

New contact



Video call

**Calls****

All



Answered



Dialled



Missed

**Organizer**

Alarms
Applications
Calendar
Tasks
Notes
Synchronization
Timer
Stopwatch
Calculator
Code memo

**Settings******General**

Profiles
Time & date
Language
Update service
Voice control
New events
Shortcuts
Flight mode
Security
Setup wizard
Phone status
Master reset

**Sounds & alerts**

Ring volume
Ringtone
Silent mode
Increasing ring
Vibrating alert
Message alert
Key sound

**Display**

Wallpaper
Themes
Start-up screen
Screen saver
Clock size
Brightness
Edit line names*

**Calls**

Divert calls
Switch to line 2*
Manage calls
Time & cost*
Show/hide my no.
Handsfree
Open to answer

**Connectivity***

Bluetooth
USB
Synchronization
Device mgmt.
Mobile networks
Data comm.
Internet settings
Streaming settings
Accessories

* Some menus are operator-, network- and subscription-dependent.

** Use the navigation key to move across tabs in submenus. For more information 12 Navigation.

Navigation

The main menus are shown as icons. Some submenus include tabs. Scroll to a tab by pressing the left or right part of the navigation key.

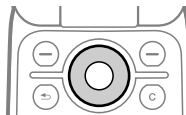

Key

	Go to the main menus or select highlighted items.
	Move through the menus and tabs.
	Select options shown above these keys on the screen.
	Go back one level in the menus. Press and hold to return to standby or to end a function.
	Delete items, such as pictures, sounds and contacts. During a call, press and hold to mute the microphone.
	Open the browser.
	Open the activity menu ➔ <i>6 Activity menu</i> .
	Open or minimize the Music player .
	Press and hold to take a picture or record a video clip.
	Press and hold to call your voicemail service (if set).
-	Press and hold any of these keys to reach a contact beginning with a specific letter.

-
- 1 - 9** Press a number key and then ► **Call to speed dial**.
Press for shortcuts when browsing ► *33 To use Internet keypad shortcuts or access keys.*
-
- 0 +** View a shortcut guide when using the camera.
-
- # (M)** Turn off the ringtone when receiving a call.
Press and hold to set the phone to silent. The alarm signals even if the phone is set to silent.
-
- ▲** View status information in standby.
Increase the volume during a call, or when using the **Music player**.
Adjust brightness when using the camera.
Press and hold to go back one music track.
Press twice to reject a call.
Press and hold to voice dial, alternatively say your magic word (if set)
► *23 Voice dialling.*
-
- ▼** Decrease the volume during a call, or when using the **Music player**.
Adjust brightness when using the camera.
Press and hold to go forward one music track.
Press and hold to voice dial, alternatively say your magic word (if set)
► *23 Voice dialling.*
-
- **Info** Find more information, explanations or tips about selected features, menus or functions available in your phone ► *5 Help in your phone.*
-
- **More** Enter a list of options. There are different alternatives in the list of options depending on where you are in the menus.
-

Entering letters

Enter letters in one of the following ways (text input methods), for example, when writing messages:

- Multitap text input
- T9™ Text Input

To change the text input method

Before, or when entering letters, press and hold **(*) (1) (2)** to change the method.

To change the writing language

Before, or when entering letters, press and hold **(#) (2)** and select another writing language.

Options when entering letters

► **More** for options when writing a message.

To enter letters using multitap input

- Press **(2)** - **(9)** repeatedly until the desired character appears.
- Press **(*) (1) (2)** to shift between capital and lower-case letters.
- Press and hold **(0) (+)** - **(9)** to enter numbers.
- Press **(C)** to delete letters or numbers.
- Press **(1)** for the most common punctuation marks.
- Press **(#) (2)** to add a space.





T9™ Text Input

The T9™ Text Input method uses a built-in dictionary to recognize the most commonly used word for each sequence of key presses. This way, you press each key only once, even if the letter you want is not the first letter on the key.

To enter letters using T9 Text Input

- 1 To enter text, you have to be in a function where text input is possible, for example, ► **Messaging** ► **Write new** ► **Text message**.
- 2 For example, to write the word “Jane”, press **(5)**, **(2)**, **(6)**, **(3)**.
- 3 If the word shown is the one you want, press **(#) (2)** to accept and add a space. To accept a word without adding a space, press **(C)**. If the word shown is not the one you want, press **(C)** or **(Q)** repeatedly to view alternative words. Accept a word and add a space by pressing **(#) (2)**.
- 4 Continue writing the message. To enter a punctuation mark, press **(1)** and then **(C)** or **(Q)** repeatedly, press **(#) (2)** to accept and add a space.

To add words to the T9 Text Input dictionary

- 1 When entering letters ► **More** ► **Spell** word.
- 2 Edit the word by using multitap input. Use  and  to move the cursor between the letters. To delete a character, press . To delete the entire word, press and hold . When you have edited the word ► **Insert**. The word is added to the T9 Text Input dictionary. Next time you enter this word using T9 Text Input, it appears in alternative words.

Next word prediction

When writing a message, you can use T9 Text Input to predict the next word, if previously used in a sentence.

To turn next word prediction on/off

When entering letters ► **More** ► **Writing** options ► **Nxt word pred.**

To use next word prediction

When entering letters, press  to accept or continue.

File manager

Use the file manager to handle items such as pictures, videos, music, themes, Web pages, games and applications saved in the phone memory or on the Memory Stick Micro™ (M2™) memory card.

You can also move and copy files between a computer and the memory card.

Create subfolders to move or copy files to. Games and applications can be moved within the **Games** and **Applications** folders and from the phone memory to the memory card. Unrecognized files are saved in the **Other** folder. When handling files, you can select several or all files in a folder at the same time for all items except **Games** and **Applications**.

Memory status

If all available memory is full, you cannot save any files until content is removed. Check the memory status for your phone and memory card by highlighting a folder ► **More** ► **Memory** status.

File manager menu tabs

The file manager is divided into three tabs, and icons are included to indicate where the files are saved.

- All files - all content in the phone memory and on the memory card.
- On Memory Stick - all content on the memory card.
- In phone - all content in the phone memory.

File information

View file information by highlighting it ► More ► Information.

To use a file from the file manager

- 1 ► File manager and open a folder.
- 2 Scroll to a file ► More.

To move or copy files to a computer

► 37 Transferring files using the USB cable.

To create a subfolder

- 1 ► File manager and open a folder.
- 2 ► More ► New folder and enter a name for the folder.
- 3 ► OK to save the folder.

To select several files

- 1 ► File manager and open a folder.
- 2 ► More ► Mark ► Mark several.
- 3 Scroll to select files ► Mark or Unmark.

To select all files in a folder

- File manager and open a folder
- More ► Mark ► Mark all.

To delete a file or a subfolder from the file manager

- 1 ► File manager and open a folder.
- 2 Scroll to a file ► More ► Delete.

Calling

Making and receiving calls

Before you can make or receive any calls, you must turn on your phone and be within range of a network.



► **5 Turning on your phone.** To make a video call ► **19 Video call.**

Networks

When you turn on the phone, it automatically selects your home network if this is within range. If it is not within range, you may use another network, provided your network operator has an agreement that allows you to do so. This is called roaming.

Select the network to use, or you can add a network to your preferred networks. You can also change the order in which networks are selected during an automatic search.

To view available network options

► **Settings and use**  or  to scroll to the **Connectivity tab** ► **Mobile networks.**

To make a call

- 1 Enter a phone number (with international country code and area code, if applicable).
- 2 ► **Call** to make a voice call or ► **More** to view options, such as **Make video call** ► **19 Video call.**
- 3 ► **End call** or close your phone to end the call.

 *You can call numbers from your contacts and call list* ► **20 Contacts, and** ► **23 Call list.**

To join two calls into a conference call

- 1 Call the first person to include in the conference.
- 2 ► **More** ► **Hold** to hold the ongoing call.
- 3 Call the second person.
- 4 ► **More** ► **Join calls.**

To make international calls

- 1 Press and hold  until a + sign appears.
- 2 Enter the country code, area code (without the first zero) and phone number. ► **Call** to make a voice call, or ► **More** ► **Make video call** to make a video call.

To re-dial a number



If a call connection fails and **Retry?** appears ► **Yes**.

 *Do not hold the phone to your ear when waiting. When the call connects, the phone gives a loud signal.*



To answer a call

Open your phone or ► **Answer**.

To reject a call

- Quickly press  or  twice,
- close your phone, or
- ► **Busy**

To turn off the microphone



- 1 Press and hold .
- 2 To resume the conversation press and hold  again.

To turn the loudspeaker on or off during a voice call

► **More** ► **Turn on speaker** or **Turn off speaker**.

 *Do not hold the phone to your ear when using the loudspeaker. This could damage your hearing.*









To change the ear speaker volume

Press  to increase or  to decrease the ear speaker volume during a call.

Missed calls

When the activity menu is set to default, missed calls appear in the **New events** tab in standby. If pop-up is set to default **Missed calls:** appears in standby ► **6 Activity menu**.

To check missed calls from standby

- If activity menu is set to default, press  and use  or  to scroll to the **New events** tab. Scroll  or  to select a number and ► **Call** to call.
- If pop-up is set to default, ► **Calls** and use  or  to scroll to the **Missed** tab. Scroll  or  to select a number and ► **Call** to call.

Emergency calls

Your phone supports international emergency numbers, for example, 112, 911. These numbers can normally be used to make emergency calls in any country, with or without a SIM card inserted, if a 3G (UMTS) or GSM network is within range.

 *In some countries, other emergency numbers may also be promoted. Your network operator may therefore have saved additional local emergency numbers on the SIM card.*

To make an emergency call

Enter 112 (the international emergency number) ► **Call**.

To view your local emergency numbers

► **Contacts** ► **More** ► **Options** ► **Special numbers** ► **Emergency nos.**

Video call

See a person on screen during calls.

Before you start

To make a video call, both you and the person you are calling need a subscription that supports the 3G (UMTS) service, and you need to be within range of a 3G (UMTS) network. 3G (UMTS) service is available when the 3G icon appears in the status bar.

Video call demo mode

You can use most video call functions without making a call, for example, to prepare a camera view before calling.
► **Video call**.

To make a video call

When 3G (UMTS) service is available, you can make a video call in one of the following ways:

- Enter a phone number (international prefix and area code if applicable)
► **More** ► **Make video call**.
- **Contacts** and select the contact to call. Use Ⓞ or Ⓟ to select a number
► **More** ► **Make video call**.
- **Video call** ► **Call....** ► **Contacts** to retrieve a phone number ► **Call** or enter a phone number ► **Call**.

To zoom the outgoing video in or out

Press Ⓞ to zoom in the outgoing video and press Ⓟ to zoom out.

To accept an incoming video call

Open your phone or ► **Answer**.

To end a video call

Close your phone or ► **End call**.

Video call options

► **More** for the following options:

- **Switch camera** – to switch between the main and video call cameras. Use the main camera to show a full image of your surroundings to the recipient.
- **Stop camera/Start camera** – turn the video camera off or on. An alternative picture is shown when off.
- **Save picture** – save the image shown in the large view, for example, the incoming caller image.

- **Camera – options**
 - **Brightness** – adjust the level for the outgoing picture.
 - **Turn on night m.** – use when lighting conditions are poor. This setting affects the outgoing video.
- **Sound – options during a video call**
 - **Turn off speaker/Turn on speaker** – incoming sound.
 - **Mute microphone/Unmute mic.** – microphone off or on.
 - **Transfer sound** – to and from Bluetooth handsfree equipment.
- **Layout – options**
 - **Switch pictures** – show incoming or outgoing video in full size view.
 - **Hide small pic./Show small pic.**
 - **Mirror image** – set if you want to see yourself as in a mirror.
- **Settings – when answering**
 - **Answer mode** – set the video call camera to on or off.
 - **Alternative pic.** – set a picture to show to the recipient when the camera is off.
 - **Audio options** – select if microphone, speaker phone, or both should be on or off.
 - **Video quality** – select picture quality of the incoming video call.

Contacts

You can save your contact information in the phone memory or on a SIM card.

Choose which contact information – **Phone contacts** or **SIM contacts** – is shown as default.

For useful information and settings
▶ **Contacts** ▶ **More** ▶ **Options**.





Default contact

If **Phone contacts** is selected as default, your contacts show all the information saved in **Contacts**. If you select **SIM contacts** as default, your contacts show information depending on the SIM card.

To select default contacts

- 1 ▶ **Contacts** ▶ **More** ▶ **Options**
▶ **Advanced** ▶ **Default contacts**.
- 2 ▶ **Phone contacts** or **SIM contacts**.

Phone contacts

Save contacts in the phone with names, phone numbers and personal information. You can also add pictures and ringtones to contacts. Use , ,  and  to scroll between tabs and their information fields.

To add a phone contact

- 1 If **Contacts** is selected as default, ► **Contacts** ► **New contact** ► **Add**.
- 2 Enter the name ► **OK**.
- 3 Enter the number ► **OK**.
- 4 Select a number option.
- 5 Scroll between tabs and select the fields to add information. To enter symbols such as @, ► **More** ► **Add symbol** and select a symbol ► **Insert**.
- 6 When all information is added ► **Save**.

To delete a contact

- 1 ► **Contacts** and scroll to a contact.
- 2 Press **(C)** and select **Yes**.

To delete all phone contacts

If **Phone contacts** is selected as default, ► **Contacts** ► **More** ► **Options** ► **Advanced** ► **Delete all contacts** ► **Yes** and ► **Yes**. Names and numbers on the SIM card are not deleted.

SIM contacts

Save contacts on your SIM card.

To add a SIM contact

- 1 If **SIM contacts** is selected as default, ► **Contacts** ► **New contact** ► **Add**.
- 2 Enter the name ► **OK**.

- 3 Enter the number ► **OK** and select a number option. Add more information, if available ► **Save**.

To automatically save names and phone numbers on the SIM card

► **Contacts** ► **More** ► **Options** ► **Advanced** ► **Auto save on SIM** and select **On**.

Memory status

The number of contacts you can save in the phone or on the SIM card depends on available memory.

To view memory status



► **Contacts** ► **More** ► **Options** ► **Advanced** ► **Memory status**.

Using contacts



Contacts can be used in many ways. Below you can see how to:

- call phone and SIM contacts.
- send phone contacts to another device.
- copy contacts to phone and SIM card.
- add a picture or a ringtone to a phone contact.
- edit contacts.
- synchronize your contacts.

To call a phone contact

- 1 ► **Contacts**. Scroll to, or enter the first letter or letters of the contact.
- 2 When the contact is highlighted press  or  to select a number ► **Call** to make a voice call, or ► **More** ► **Make video call** to make a video call.

To call a SIM contact

- If **SIM contacts** is default ► **Contacts** and when the contact is highlighted press  or  to select a number. ► **Call** to make a voice call, or ► **More** ► **Make video call** to make a video call.
- If **Phone contacts** is set as default ► **Contacts** ► **More** ► **Options** ► **SIM contacts** and select the contact ► **Call** to make a voice call, or ► **More** ► **Make video call** to make a video call.

To send a contact

► **Contacts** and select a contact ► **More** ► **Send contact** and select a transfer method.

To send all contacts

► **Contacts** ► **More** ► **Options** ► **Advanced** ► **Send all contacts** and select a transfer method.

To copy names and numbers to the SIM card

- 1 ► **Contacts** ► **More** ► **Options** ► **Advanced** ► **Copy to SIM**.
- 2 Select one of the alternatives.



When copying all contacts from the phone to the SIM card, all existing SIM card information is replaced.

To copy names and numbers to phone contacts

- 1 ► **Contacts** ► **More** ► **Options** ► **Advanced** ► **Copy from SIM**.
- 2 Select one of the alternatives.

To add a picture, ringtone sound or video to a phone contact

- 1 ► **Contacts** and select the contact ► **More** ► **Edit contact**.
- 2 Select the relevant tab and then select **Picture** or **Ringtone** ► **Add**.
- 3 Select an option and an item ► **Save**.



If your subscription supports Calling Line Identification (CLI) service, you can assign personal ringtones to contacts.

To edit a phone contact

- 1 ► **Contacts** and select a contact ► **More** ► **Edit contact**.
- 2 Scroll to the relevant tab and select the field to edit ► **Edit**.
- 3 Edit the information ► **Save**.

To edit a SIM contact

- 1 If SIM contacts is default ► **Contacts** and select the name and number to edit. If phone contacts is default ► **Contacts** ► **More** ► **Options** ► **SIM contacts** and select the name and number to edit.
- 2 ► **More** ► **Edit contact** and edit the name and number.

Call list

Information about most recent calls.

To call a number from the call list

- 1 From standby, ► **Calls** and select a tab.
- 2 Scroll to the name or number to call ► **Call** to make a voice call, or ► **More** ► **Make video call** to make a video call.

To add a call list number to contacts

- 1 From standby, ► **Calls** and select a tab.
- 2 Scroll to the number to add ► **More** ► **Save number**.
- 3 ► **New contact** to create a new contact, or select an existing contact to add the number to.

To clear the call list

- **Calls** and select the **All** tab ► **More** ► **Delete all**.



Voice control

Manage calls with your voice by creating voice commands.

Before voice dialling

Activate the voice dialling function and record your voice commands. An icon appears next to a phone number that has a voice command.

To activate voice dialling and record names

- 1 ► **Settings** ► the **General** tab ► **Voice control** ► **Voice dialling** ► **Activate** ► **Yes** ► **New voice** and select a contact.
- 2 If the contact has more than one number, use  and  to view the numbers. Select the number to add the voice command to. Record a voice command such as "John mobile".
- 3 Instructions appear. Wait for the tone and say the command to record. The voice command is played back to you.
- 4 If the recording sounds OK ► **Yes**. If not ► **No** and repeat step 3. To record another voice command for a contact ► **New voice** ► **Add again** and repeat steps 2-4 above.

Voice dialling

Start voice dialling from standby.

To make a call

- 1 From standby, press and hold one of the volume keys.
- 2 Wait for the tone and say a recorded name, for example "John mobile". The name is played back to you and the call is connected.

Groups

Create a group of numbers and email addresses to send messages to several recipients at the same time

► *25 Messaging.*

 *If you send a text message to a group, you will be charged for each member.*

To create a group of numbers and email addresses

- 1 ► **Contacts** ► **More** ► **Options** ► **Groups** ► **New group** ► **Add.**
- 2 Enter a name for the group ► **Continue.**
- 3 ► **New** ► **Add** to find and select a contact number or email address.
- 4 Repeat step 3 to add more numbers or email addresses. ► **Done.**

Business cards

Add your own business card as a contact.

To add your own business card

► **Contacts** ► **More** ► **Options** ► **My business card** and add information for your business card ► **Save.**

To send your business card

► **Contacts** ► **More** ► **Options** ► **My business card** ► **Send my card** and select a transfer method.

Messaging

Your phone supports various messaging services. Please contact your service provider about the services you can use, or for more information, visit www.sonyericsson.com/support.

Text messaging (SMS)

Text messages can contain simple pictures, sound effects, animations, and melodies. You can also create and use templates for your messages.

Before you start

The number to your service centre is supplied by your service provider and is usually set on the SIM card. If not, you can enter the number yourself.

To set a service centre number

- 1 ► Messaging ► Settings ► Text message ► Service centre. If the service centre number is saved on the SIM card it is shown.
- 2 If there is no number shown ► Edit ► New ServiceCentre and enter the number, including the international "+" prefix and country/region code ► Save.

Sending text messages

For information about entering letters
► 14 Entering letters.

 *Some language-specific characters use more space. For some languages you can deactivate National chars. to save space.*

To write and send a text message

- 1 ► Messaging ► Write new ► Text message.
- 2 Write your message ► Continue. (You can save a message for later in Drafts by pressing  ► Save message.)
- 3 ► Enter phone no. and enter a number, or ► Contacts look-up to retrieve a number or a group from Contacts, or ► Enter email addr. or select from last used recipients ► Send.

 *To send a message to an email address, you need to set an email gateway number, ► Messaging ► Settings ► Text message ► Email gateway. The number is supplied by your service provider.*

To copy and paste text in a message

- 1 When writing your message ► More ► Copy & paste.
- 2 ► Copy all or ► Mark & copy and use the navigation key to scroll and mark text in your message.
- 3 ► More ► Copy & paste ► Paste.

To insert an item in a text message

- 1 When writing your message ► **More** ► **Add item**.
- 2 Select an option and then an item, for example, a picture.

 *You can convert your text message to a picture message. When writing your message ► **More** ► **To picture msg** and continue creating a picture message, ► **26 Picture messaging (MMS)**.*

To delete a message

- 1 ► **Messaging** and select a folder.
- 2 Select the message to delete and press **(C)**.

To set default text message options

► **Messaging** ► **Settings** ► **Text message** and select the options to change.

Picture messaging (MMS)

Picture messages can contain text, pictures, camera pictures, slides, sound recordings, video clips, signatures and attachments. You can send picture messages to a mobile phone or an email address.

Before you start



Both you and the recipient must have subscriptions that support picture messaging.

If no Internet profile or message server exists, you can receive all the settings for MMS automatically from your network operator or from www.sonyericsson.com/support.

Before sending a picture message, you can check:

The address of your message server and an Internet profile are set ► **Messaging** ► **Settings** ► **Picture message** ► **MMS profile** and select a profile. ► **More** ► **Edit** ► **Message server** and ► **More** ► **Edit** ► **Internet profile**.

To create and send a picture message

- 1 ► **Messaging** ► **Write new** ► **Picture msg**. Scroll  to use toolbar options. Scroll  or  to select an option.
- 2 When ready to send ► **Continue**.
- 3 ► **Enter email addr.** or ► **Enter phone no.** or ► **Contacts look-up** to retrieve a number or group in Contacts or select from last used recipients ► **Send**.



When writing and editing picture messages you can use the copy and paste functionality ► 25 To copy and paste text in a message.

To create your own signature for picture messages

- 1 ► Messaging ► Settings ► Picture message.
- 2 ► Signature ► New signature and create your signature as a picture message.

To set default picture message options

► Messaging ► Settings ► Picture message and select options to change.



Email

Read your email messages in your phone at any time. The email address that you use on your computer can also be used in your phone. To do this, your phone needs the same email settings as used by your computer for email address. To use your computer email address in your phone, do one of the following:

- **Receive settings automatically**
The easiest way is to have settings sent directly to your phone. Use Internet on your computer to go to www.sonyericsson.com/support.

• Enter settings manually

- Ask your email provider for settings information. An email provider is the person or company who provided your email address, for example, your IT administrator at work or an Internet provider, or
- you may have a document at home from your email provider with the settings information, or
- you may find the information in your computer email program settings.

What information do I need?

The minimum you need is the following:

Setting types	Examples
Connection type	POP3 or IMAP4
Email address	joe.smith@example.com
Incoming server	mail.example.com
Username	jsmith
Password	zX123
Outgoing server	mail.example.com



There are many different email providers. Their terminology and required information may differ. Not all service providers allow email access.

There are also setup instructions and help information as you enter settings.

To enter email settings

- 1 ► **Messaging** ► **Email** ► **Settings**.
- 2 After settings are entered, ► **Inbox** ► **More** ► **Send & receive** to access your email.

When settings are entered, your phone can connect to an email server to send and receive email messages.

For more information, contact your email provider or see the *User guide with additional information* at www.sonyericsson.com/support.

Push email

Receive a notification in your phone from your email server that you have new email, if supported by your email provider.

To turn on push email notification

- When using send & receive, ► **Yes** to turn on, if required or
- ► **Messaging** ► **Email** ► **Settings**. Select an account to edit ► **More** ► **Edit account** ► **Advanced settings** ► **Push email** and select an option.

My friends

Connect and log in to the My friends server to communicate online with your favourite friends. If your subscription supports instant messaging and presence services, you can send and receive messages and see contact status if online. If no settings exist in your phone, you need to enter server settings.



Contact your service provider for more information.

Imaging

Camera and video recorder

Take pictures and record video clips to save, view and send in messages

➤ *7 Take pictures or record video clips.*

Camera settings

When you are in the viewfinder ► **More** for options to adjust and enhance your pictures and video clips before taking or recording them.

💡 *If you try to record with a strong light source such as direct sunlight or a lamp in the background, the screen may black out or the picture may be distorted.*

To use the zoom

Use the navigation key to zoom in and out.

To adjust brightness

Use volume buttons to increase or decrease brightness.

Camera and video options

When the camera or video is activated ► **More** for the following options:





- View all pictures (camera)
- View all clips (video)

- Shoot mode (camera):
 - Normal – no frame.
 - Burst – take a rapid sequence of pictures.
 - Panorama – join several pictures into one.
 - Frames – add a frame to your picture.
- Shoot mode (video):
 - Hi-quality video
 - For picture msg
- Picture size (camera) – select from:
 - 2 MP (1600x1200 pixels)
 - 1 MP (1280x960)
 - VGA (640x480) (640x480)
- Night mode – adapt to poor lighting conditions.
- Self-timer (camera) – take a picture a few seconds after pressing the camera button.
- Effects – select from:
 - Off – no effect.
 - Black & white – no colour.
 - Negative – reversed colours.
 - Sepia – brown tint.
- White balance – adjust colours to lighting conditions. Select from Auto, Daylight, Cloudy, Fluorescent or Incandescent.
- Picture quality (camera):
 - Normal
 - Fine
- Microphone (video) – set microphone.

- **Shutter sound (camera)** – select different shutter sounds.
- **Time and date (camera)** – add time and date to a picture to appear as red text in the lower right corner. View in 1:1 size or use zoom when viewing a picture to see the text.
- **Reset file no.** – reset the file number counter.
- **Save to** – select to save to **Memory Stick** or **Phone memory**.

Camera shortcuts

When using the camera, you can also use keys as shortcuts to options.

Key	Shortcut
	Shoot mode (camera and video)
	Picture size (camera)
	Night mode (camera and video)
	Camera key guide

Transferring pictures

Transfer to your computer

Using the USB cable, you can drag and drop camera pictures to a computer

➡ *37 Transferring files using the USB cable.*

To further enhance and organize camera pictures on a computer, Windows® application users can install Adobe™ Photoshop™ Album Starter Edition, included on the CD with phone or visit www.sonyericsson.com/support.

Blog on the Internet

Send pictures to publish in a blog if your subscription supports it.

 *Web services may require a separate license agreement between you and the service provider. In some locations, additional regulations and/or charges may apply. For more information, contact your service provider.*

To send camera pictures to a blog

- 1 When viewing a picture you have just taken ► **More** ► **Blog** this.
- 2 Follow the instructions that appear for first-time use, for example, approve terms and conditions.
- 3 Add title and text ► **OK** ► **Publish** to send a picture to your blog.

A text message is sent to your phone with your Web address and log-in information. Your Web address will also be bookmarked. You can forward the bookmark so that others can access your Web page photos.

To send pictures to a blog

- 1 ► File manager and select a picture in a folder.
- 2 ► More ► Send ► To blog.
- 3 Add title and text ► OK ► Publish.

To visit a blog address in a contact

- Contacts and select a contact Web address ► Go to.

Pictures

To view and use pictures

- 1 ► File manager ► Pictures.
- 2 Select a picture ► View or ► More ► Use as and select an option.

To send a picture

- File manager ► Pictures and scroll to a picture. ► More ► Send and select a transfer method.

 *Some phones cannot receive large picture sizes.*

To receive a picture

- Settings ► Connectivity and select a transfer method.

Entertainment







Music and video player



Your phone supports, for example, the following file types: MP3, MP4, M4A, 3GPP, AMR, MIDI, iMelody, eMelody, WMA, WMV, WAV (16 kHz maximum sample rate) and Real@8. The phone also supports streamed files that are 3GPP compatible.

To play music and videos

- 1 ► Music player or ► Entertainment ► Video player. A player browser opens.
- 2 Browse for music by artist or track, or in playlists. You can also browse for video clips. Select a list ► Open.
- 3 Highlight a title ► Play.

The following options are available:

- Press  to play or stop during playback.
- Press  to stop the playback. Press again to resume playing.
- Press  to go to the next music file.
- Press  to go to the previous music file.
- Press and hold  or  to fast forward or rewind when playing music files or video clips.
- Press **Play** to select a highlighted file.

- When in **Now playing**, press  to go to the music player browser.
- When playing music, ► **More** for options, for example, **Minimize** to use in the background.
- Press and hold  to exit.

PlayNow™

Listen to music before you purchase and download it to your phone.



This function is network- or operator-dependent. Contact your network operator for information about your subscription and PlayNow™. In some countries you may be able to purchase music tones from some of the world's top musical artists.



This service is not available in all countries.

To listen to PlayNow™ music

► **PlayNow™** and select music from a list.

Downloading from PlayNow™

The price appears when you select to download and save a music file. Your phone bill or prepay card is debited when a purchase is accepted. Terms and conditions are also provided in the phone kit.

To download a music file

- 1 When you have listened to a music file preview, you can agree to accept the conditions ► **Yes** to download or not.
- 2 A text message is sent to confirm payment and the file is made available to download. Music is saved in **File manager** ► **Music**.

Ringtones and melodies

You can exchange music, sounds and tracks, for example, using one of the available transfer methods.



You are not allowed to exchange some copyright-protected material. A copyright-protected file has a key symbol.



To select a ringtone

- **Settings** ► the **Sounds & alerts** tab
- **Ringtone**.

To turn the ringtone on or off

Press and hold  from standby or ► **Settings** ► the **Sounds & alerts** tab for more options. All signals except the alarm signal are affected.

To set ringtone volume

- 1 ► **Settings** ► the **Sounds & alerts** tab
- **Ring volume** and press  or  to decrease or increase the volume.
- 2 ► **Save**.

To set the vibrating alert

- ▶ Settings ▶ the Sounds & alerts tab
- ▶ Vibrating alert and select an option.

Sounds and alerts options

From Settings ▶ the Sounds & alerts tab, you can also set:

- Message alert – select how to be notified of an incoming message.
- Key sound – select what sound to hear when you press the keys.

Connectivity

Using Internet

Use Internet to access online services for example, news and banking, search and browse the Web.

To start browsing

- ▶ Internet and select a service such as
- ▶ More ▶ Go to ▶ Search Internet or
- Enter address to any Web page.

To view options

- ▶ Internet ▶ More.

To stop browsing

- ▶ More ▶ Exit browser.



For more information contact your network operator or visit www.sonyericsson.com/support.

To use Internet keypad shortcuts or access keys

- 1 When browsing, press and hold **(#-*)** to select **Shortcuts** or **Access keys**.
- 2 If you select **Shortcuts**, you can press a key for a function as follows:

Key	Shortcut
1	Bookmarks
2	Enter address



3	Search Internet
4	History
5	Refresh page
6	Forward
7	Page up
8	Not used
9	Page down - one at the time
⌘ AA↔	Fullscreen or Landscape or Normal screen
□ +	Zoom
# ↵	Shortcuts

RSS reader

When browsing, you can receive frequently updated content, such as news headlines, as feeds via a Web site. You can browse to a Web page to add new feeds, if available. Really Simple Syndication (RSS) options are set via the RSS reader and shown in the Internet browser.

To add new feeds for a Web page

When browsing ► **More** ► **RSS feeds**.

To create a new feed

- **Messaging** ► **RSS reader** ► **More** ► **New feed**.
- **Select from list or By address** and enter the address.

34 Connectivity

To set and use RSS reader options

► **Messaging** ► **RSS reader** ► **More** and select an option.

Synchronizing

Synchronize phone contacts, appointments, tasks and notes via Bluetooth™ wireless technology, Internet services or the USB cable included with the phone.

Synchronization with a computer

Install synchronization software for your computer found in the Sony Ericsson PC Suite on the CD, included with the phone. The software includes help information. You can also visit www.sonyericsson.com/support to download the software or the document *Getting started guide for synchronization*.

Remote synchronization via Internet

Synchronize online via an Internet service.

Before you start

- Register a synchronization account online.
- Enter remote synchronization settings.

To enter remote synchronization settings

- 1 ► **Organizer** ► **Synchronization** ► **Yes** or ► **New account** to create a new account.
- 2 Enter a name for the new account ► **Continue**.
- 3 Enter the following:
 - **Server address** – server URL.
 - **Username** – account username.
 - **Password** – account password.
 - **Connection** – select an Internet profile.
 - **Applications** – mark applications to synchronize.
 - **App. settings** – select an application and enter a database name, and if required, username and password.
 - **Sync. interval** – set how often to synchronize.
 - **Remote initiation** – select to always accept, never accept or always ask when starting synchronization from a service.
 - **Remote security** – insert a server ID and a server password.
- 4 ► **Save** to save your new account.

To start remote synchronization

- **Organizer** ► **Synchronization** and select an account ► **Start**.

Bluetooth™ wireless technology

The Bluetooth™ function makes wireless connection to other Bluetooth devices possible.

 *We recommend a range within 10 metres, with no solid objects in between, for Bluetooth communication.*

Before you start

- Turn on the Bluetooth function to communicate with other devices.
- Add Bluetooth devices to your phone to communicate with.

 *Please check if local laws or regulations restrict the use of Bluetooth wireless technology. If Bluetooth wireless technology is not allowed, you must ensure that the Bluetooth function is turned off. The maximum allowed Bluetooth radio output power in the phone is automatically adjusted according to possible local restrictions. This means range may vary.*

To turn the Bluetooth function on

- **Settings** ► the **Connectivity** tab
► **Bluetooth** ► **Turn on**.

Adding devices to your phone

Enter a passcode to set up a secure link between your phone and the device. Enter the same passcode on the device when prompted. A device with no user interface, such as a handsfree, will have a predefined passcode. Consult the device User guide for more information.

 *Make sure that the device you want to add has the Bluetooth function activated and is visible.*

To add a device to your phone

- ▶ Settings ▶ the Connectivity tab ▶ Bluetooth ▶ My devices ▶ New device to search for available devices. Make sure the other device is visible.
- Select a device from the list.
- Enter a passcode, if required.

To allow connection or edit your device list

- ▶ Settings ▶ the Connectivity tab ▶ Bluetooth ▶ My devices and select a device from the list.
- ▶ More to view a list of options.

To add a Bluetooth handsfree

- ▶ Settings ▶ the Connectivity tab ▶ Bluetooth ▶ Handsfree.
- ▶ Yes if you are adding a Bluetooth handsfree for the first time or ▶ My handsfree ▶ New handsfree ▶ Add if you are adding another Bluetooth handsfree. Ensure that your handsfree is in the correct mode. Consult the device User guide for more information.

Phone name

Enter a name for your phone to be shown as when other devices find it.

To enter a phone name

- ▶ Settings ▶ the Connectivity tab ▶ Bluetooth ▶ Phone name.

Visibility

Choose to make your phone visible to other Bluetooth devices or not. If your phone is set to hide, only devices in ▶ Settings ▶ the Connectivity tab ▶ Bluetooth ▶ My devices are able to find your phone via Bluetooth wireless technology.

To show or hide your phone

- ▶ Settings ▶ the Connectivity tab ▶ Bluetooth ▶ Visibility ▶ Show phone or Hide phone.

Transferring files using the USB cable

Connect your phone to a computer, via the USB cable, to use your phone in one of the following: **File transfer** or **Phone mode**.

File transfer

Drag and drop files between your memory card and computer in Microsoft Windows Explorer.

Use Sony Disc2Phone (music transfer) or Adobe™ Photoshop™ Album Starter Edition (picture transfer/storage). These applications are found on the CD that come with the phone or at www.sonyericsson.com/support, and can only be used with file transfer mode.

 *Only use the USB cable that comes with the phone, and connect the USB cable directly to your computer. Do not remove the USB cable from the phone or computer during file transfer as this may corrupt the memory card.*

To use file transfer mode

- 1 Connect the USB cable to the phone and the computer.

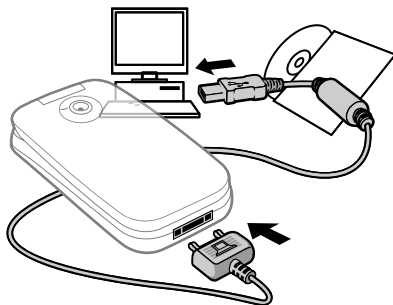

- 2 **Phone:** Select **File transfer** or **Settings** ► **the Connectivity tab** ► **USB** ► **USB connection** ► **File transfer**. The phone shuts down.
- 3 Wait until your memory card appears as an external disk in Windows Explorer. You can use:
 - Windows Explorer to drag and drop files between your memory card and computer.
 - Sony Disc2Phone to transfer music to your memory card.
 - Adobe™ Photoshop™ Album Starter Edition, to transfer and organize your pictures on your computer.

To disconnect the USB cable safely

- 1 When using file transfer mode, right-click the removable disk icon in Windows Explorer and select Eject.
- 2 Remove the USB cable from your phone.

Phone mode

Synchronize contacts and calendar, transfer files, use the phone as modem and more from your computer. Applications supported in phone mode include: Synchronization, File manager and Mobile Networking Wizard. For other applications, use the file transfer mode.

You need to install and use Sony Ericsson PC Suite, included on the CD that came with the phone or found at www.sonyericsson.com/support.

 *Your computer needs to have one of the following operating systems to be able to use this feature: Windows 2000 with SP3/SP4, Windows XP (Pro and Home) with SP1/SP2.*

USB drivers are installed automatically with the PC Suite software.

To use phone mode

- 1 **Computer:** Install the Sony Ericsson PC Suite from the CD that came with your phone.

- 2 **Computer:** Start PC Suite from Start/Programs/Sony Ericsson/PC Suite.
- 3 Connect the USB cable to the phone and the computer.
- 4 **Phone:** Select **Phone mode** or **Settings** ► **the Connectivity tab** ► **USB** ► **USB connection** ► **Phone mode**.
- 5 **Computer:** Wait while Windows installs the required drivers.
- 6 **Computer:** When PC Suite has found your phone you are notified. All applications that you can use with your connected phone are found in the Sony Ericsson PC Suite.

Update service

Always keep your phone updated with the latest software to improve performance. You do not lose personal or phone information, for example messages or settings during an update.

There are two ways to update your phone:

- over the air via your phone.
- via the provided USB cable and an Internet-connected computer.



The update service requires data access (GPRS). Your operator will provide you with a subscription with data access and price information.

To use Update service over the air

- 1 ► Settings ► the General tab ► Update service.
- 2 ► Search for update to search for the latest available software.
- 3 Start the update process by following the installation instructions, or ► Software version to show the current software in your phone, or ► Reminder to set when to search for new software.

To use Update service via a computer

- 1 Visit www.sonyericsson.com/support.
- 2 Select a region and country.
- 3 Enter the product name.
- 4 Select Sony Ericsson Update Service and follow the instructions.

More features

Alarms

Set an alarm for a specific time or specific days to recur on.

To use alarms

- 1 ► Organizer ► Alarms and select an alarm to set ► Edit.
- 2 Time: ► Edit and set a time ► OK. Select more options, if required:
 - Recurrent: ► Edit and set a day or days ► Mark ► Done.
 - Alarm signal: ► Edit and select a sound.
 - Press  to edit text, pictures and the silent mode for alarms.
- 3 ► Save.

To turn an alarm signal off when it sounds

Press any key. If you do not want to repeat the alarm ► Turn off.

To cancel an alarm

► Organizer ► Alarms and select an alarm, ► Turn off.

Calendar

You can use the calendar to keep track of important meetings. The calendar can be synchronized with a computer calendar or with a calendar on the Web ► *34 Synchronizing*.

Appointments

Add new appointments or use existing appointments as templates.

To add a new appointment

- ▶ **Organizer** ▶ **Calendar** and select a date ▶ **Select** ▶ **New appointm.** ▶ **Add**.
- Select from the following options and confirm each entry, if required:
 - **General tab** - subject, start time, duration, reminder, start date.
 - **Details tab** - location, description, all day, recurrence.
- ▶ **Save**.

To view an appointment

- ▶ **Organizer** ▶ **Calendar** and select a day (appointment days marked with frames).
- Select an appointment ▶ **View**.

To view a calendar week

▶ **Organizer** ▶ **Calendar** ▶ **More** ▶ **View week**.

To set when reminders should sound

- ▶ **Organizer** ▶ **Calendar** ▶ **More** ▶ **Advanced** ▶ **Reminders**.
- ▶ **Always** for a reminder to sound even when the phone is turned off or set to silent.

Navigating in your calendar

Use the navigation key to move between days or weeks. In the monthly and weekly views, you can also use the keypad as follows.

-
- | | | | |
|----------|---------------------|---------------------|-------------------|
| | C | <i>Today's date</i> | |
| 1 | <i>Back a week</i> | 3 | <i>Next week</i> |
| 4 | <i>Back a month</i> | 6 | <i>Next month</i> |
| 7 | <i>Back a year</i> | 9 | <i>Next year</i> |
-

Calendar settings

▶ **Organizer** ▶ **Calendar** ▶ **More** to select an option:

- **View week** – view the week's appointments.
- **New appointm.** – add a new appointment.
- **Change date** – go to another date in the calendar.
- **Advanced** – find an appointment, set reminders or select a start day for the week.
- **Delete** – delete old or all appointments.
- **Help** – for more information.

Exchanging appointments

Exchange appointments using a transfer method. You can also synchronize appointments with a computer ► *34 Synchronizing*.

To send an appointment

Select an appointment in the list for a certain day ► **More** ► **Send** and select a transfer method.

Important information

Sony Ericsson Consumer Web site

On www.sonyericsson.com/support there is a support section where help and tips are only a few clicks away. Here you will find the latest computer software updates and tips on how to use your product more efficiently.

Service and support

From now on you will have access to a portfolio of exclusive service advantages such as:

- Global and local Web sites providing support
- A global network of Call Centers
- An extensive network of Sony Ericsson service partners
- A warranty period. Learn more about the warranty conditions in this User guide

On www.sonyericsson.com, under the support section in the language of your choice, you will find the latest support tools and information, such as software updates, Knowledge base, Phone setup and additional help when you require it.

For operator-specific services and features, please contact your network operator for more information.

You can also contact our Call Centers. Use the phone number for the nearest Call Center in the list below. If your country/region is not represented in the list, please contact your local dealer. (The phone numbers below were correct at the time of going to print. You can always find the latest updates on www.sonyericsson.com.)

In the unlikely event that your product needs service, please contact the dealer from whom it was purchased, or one of our service partners. Save your proof of purchase, you will need it if you need to claim warranty.

You will be charged for a call to one of our Call Centers according to national rates, including local taxes, unless the phone number is a toll-free number.

Country	Phone number	Email address
Australia	1-300 650 050	questions.AU@support.sonyericsson.com
Argentina	800-333-7427	questions.AR@support.sonyericsson.com
Austria	0810 200245	questions.AT@support.sonyericsson.com
Belgium	02-7451611	questions.BE@support.sonyericsson.com
Brazil	4001-0444	questions.BR@support.sonyericsson.com
Canada	1-866-766-9374	questions.CA@support.sonyericsson.com
Central Africa	+27 112589023	questions.CF@support.sonyericsson.com
Chile	123-0020-0656	questions.CL@support.sonyericsson.com
China	4008100000	questions.CN@support.sonyericsson.com
Colombia	18009122135	questions.CO@support.sonyericsson.com
Croatia	062 000 000	questions.HR@support.sonyericsson.com
Czech Republic	844 550 055	questions.CZ@support.sonyericsson.com
Denmark	33 31 28 28	questions.DK@support.sonyericsson.com
Finland	09-299 2000	questions.FI@support.sonyericsson.com
France	0 825 383 383	questions.FR@support.sonyericsson.com
Germany	0180 534 2020	questions.DE@support.sonyericsson.com
Greece	801-11-810-810 210-89 91 919 (from mobile phone)	questions.GR@support.sonyericsson.com
Hong Kong	8203 8863	questions.HK@support.sonyericsson.com
Hungary	+36 1 880 47 47	questions.HU@support.sonyericsson.com
India	1800 11 1800 (Toll free number) 39011111 (from mobile phone)	questions.IN@support.sonyericsson.com
Indonesia	021-2701388	questions.ID@support.sonyericsson.com
Ireland	1850 545 888	questions.IE@support.sonyericsson.com
Italy	06 48895206	questions.IT@support.sonyericsson.com
Malaysia	1-800-889900	questions.MY@support.sonyericsson.com
Mexico	01 800 000 4722 (international toll free number)	questions.MX@support.sonyericsson.com
Netherlands	0900 899 8318	questions.NL@support.sonyericsson.com
New Zealand	0800-100150	questions.NZ@support.sonyericsson.com

Norway	815 00 840
Philippines	02-6351860
Poland	0 (prefix) 22 6916200
Portugal	808 204 466
Romania	(+4021) 401 0401
Russia	8(495) 787 0986
Singapore	67440733
Slovakia	02-5443 6443
South Africa	0861 632222
Spain	902 180 576
Sweden	013-24 45 00
Switzerland	0848 824 040
Taiwan	02-25625511
Thailand	02-2483030
Turkey	0212 47 37 777
Ukraine	(+380) 44 590 1515
United Arab Emirates	43 919880
United Kingdom	08705 23 7237
United States	1-866-766-9374
Venezuela	0-800-100-2250

Guidelines for Safe and Efficient Use

Please read this information before using your mobile phone.

These instructions are intended for your safety. Please follow these guidelines. If the product has been subject to any of the conditions listed below or you have any doubt as to its proper function make sure you have the product checked by a certified service partner before charging or using it. Failure to do so might entail a risk of product malfunction or even a potential hazard to your health.



questions.NO@support.sonyericsson.com
 questions.PH@support.sonyericsson.com
 questions.PL@support.sonyericsson.com
 questions.PT@support.sonyericsson.com
 questions.RO@support.sonyericsson.com
 questions.RU@support.sonyericsson.com
 questions.SG@support.sonyericsson.com
 questions.SK@support.sonyericsson.com
 questions.ZA@support.sonyericsson.com
 questions.ES@support.sonyericsson.com
 questions.SE@support.sonyericsson.com
 questions.CH@support.sonyericsson.com
 questions.TW@support.sonyericsson.com
 questions.TH@support.sonyericsson.com
 questions.TR@support.sonyericsson.com
 questions.UA@support.sonyericsson.com
 questions.AE@support.sonyericsson.com
 questions.GB@support.sonyericsson.com
 questions.US@support.sonyericsson.com
 questions.VE@support.sonyericsson.com

Recommendations for safe use of product (mobile phone, battery, charger and other accessories)

- Always treat your product with care and keep it in a clean and dust-free place.
- **Warning!** May explode if disposed of in fire.
- Do not expose your product to liquid or moisture or humidity.
- Do not expose your product to extremely high or low temperatures. Do not expose the battery to temperatures above +60°C (+140°F).
- Do not expose your product to open flames or lit tobacco products.
- Do not drop, throw or try to bend your product.
- Do not paint your product.



- Do not attempt to disassemble or modify your product. Only Sony Ericsson authorized personnel should perform service.
- Do not close your product with an object inserted between keypad and display; this may damage your product.
- Do not use your product near medical equipment without requesting permission from your treating physician or authorized medical staff.
- Do not use your product when in, or around aircraft, or areas showing the sign "turn off two-way radio".
- Do not use your product in an area where a potentially explosive atmosphere exists.
- Do not place your product or install wireless equipment in the area above an air bag in your car.



CHILDREN

KEEP OUT OF CHILDRENS REACH. DO NOT ALLOW CHILDREN TO PLAY WITH YOUR MOBILE PHONE OR ITS ACCESSORIES. THEY COULD HURT THEMSELVES OR OTHERS, OR COULD ACCIDENTALLY DAMAGE THE MOBILE PHONE OR ACCESSORY. YOUR MOBILE PHONE OR ITS ACCESSORY MAY CONTAIN SMALL PARTS THAT COULD BECOME DETACHED AND CREATE A CHOKING HAZARD.

Power supply (Charger)

Connect the AC power adapter only to designated power sources as marked on the product. Make sure the cord is positioned so that it will not be subjected to damage or stress. To reduce risk of electric shock, unplug the unit from any power source before attempting to clean it. The AC power adapter must not be used outdoors or in damp

areas. Never alter the cord or plug. If the plug does not fit into the outlet, have a proper outlet installed by a qualified electrician.

Use only Sony Ericsson branded original chargers intended for use with your mobile phone. Other chargers may not be designed to the same safety and performance standards.

Battery

We recommend that you fully charge the battery before you use your mobile phone for the first time. A new battery or one that has not been used for a long time could have reduced capacity the first few times it is used. The battery should only be charged in temperatures between +5°C (+41°F) and +45°C (+113°F).

Use only Sony Ericsson branded original batteries intended for use with your mobile phone. Using other batteries and chargers could be dangerous. Talk and standby times depend on several different conditions such as signal strength, operating temperature, application usage patterns, features selected and voice or data transmissions when the mobile phone is being used.

Turn off your mobile phone before removing the battery. Do not put the battery into your mouth. Battery electrolytes may be toxic if swallowed. Do not let the metal contacts on the battery touch another metal object. Doing this could short-circuit and damage the battery. Use the battery for the intended purpose only.

Personal medical devices

Mobile phones may affect the operation of pacemakers and other implanted equipment. Please avoid placing the mobile phone over the pacemaker, e.g. in your breast pocket. When using the mobile phone, use it at the ear on the opposite side of the body to the pacemaker. If a minimum distance of 15 cm (6 inches) is kept between the mobile phone and the pacemaker, the risk of

interference is limited. If you have any reason to suspect that interference is taking place, immediately turn off your mobile phone. Contact your cardiologist for more information.

For other medical devices, please consult your physician and the manufacturer of the device.

Driving

Please check if local laws and regulations restrict the use of mobile phones while driving or require drivers to use handsfree solutions. We recommend that you use only Sony Ericsson handsfree solutions intended for use with your product.

Please note that because of possible interference to electronic equipment, some vehicle manufacturers forbid the use of mobile phones in their vehicles unless a handsfree kit with an external antenna has been installed.

Always pay full attention to driving and pull off the road and park before making or answering a call if driving conditions so require.

Emergency calls

Mobile phones operate using radio signals, which cannot guarantee connection in all conditions. You should therefore never rely solely upon any mobile phone for essential communications (e.g. medical emergencies).

Emergency calls may not be possible in all areas, on all cellular networks, or when certain network services and/or mobile phone features are in use. Check with your local service provider.

Antenna

This phone contains a built-in antenna. Use of antenna devices not marketed by Sony Ericsson specifically for this model could damage your mobile phone, reduce performance, and produce SAR levels above the established limits (see below).

Efficient use

Hold your mobile phone as you would any other phone. Do not cover the top of the phone when it is in use, as this affects call quality and may cause the phone to operate at a higher power level than needed, thus shortening talk and standby times.

Radio frequency (RF) exposure and Specific Absorption Rate (SAR)

Your mobile phone is a low-power radio transmitter and receiver. When it is turned on, it emits low levels of radio frequency energy (also known as radio waves or radio frequency fields).

Governments around the world have adopted comprehensive international safety guidelines, developed by scientific organizations, e.g. ICNIRP (International Commission on Non-ionizing Radiation Protection) and IEEE (The Institute of Electrical and Electronics Engineers Inc.), through periodic and thorough evaluation of scientific studies. These guidelines establish permitted levels of radio wave exposure for the general population. The levels include a safety margin designed to assure the safety of all persons, regardless of age and health, and to account for any variations in measurements.

Specific Absorption Rate (SAR) is the unit of measurement for the amount of radio frequency energy absorbed by the body when using a mobile phone. The SAR value is determined at the highest certified power level in laboratory conditions, but the actual SAR level of the mobile phone while it is operating can be well below this value. This is because the mobile phone is designed to use the minimum power required to reach the network.

Variations in SAR below the radio frequency exposure guidelines do not mean that there are variations in safety. While there may be differences in SAR levels among mobile phones, all Sony Ericsson mobile phone models are designed to meet radio frequency exposure guidelines.



For phones sold in the U.S., before a phone model is available for sale to the public, it must be tested and certified by the Federal Communications Commission (FCC) that it does not exceed the limit established by the government-adopted requirement for safe exposure. The tests are performed in positions and locations (that is, at the ear and worn on the body) as required by the FCC for each model. For body-worn operation, this phone has been tested and meets FCC RF exposure guidelines when the handset is positioned a minimum of 15 mm from the body without any metal parts in the vicinity of the phone or when used with the original Sony Ericsson accessory intended for this phone and worn on the body. Use of other accessories may not ensure compliance with FCC RF exposure guidelines.

A separate leaflet with SAR information about this mobile phone model is included with the material accompanying this mobile phone. This information can also be found, together with more information on radio frequency exposure and SAR, on: www.sonyericsson.com/health.

Accessible Solutions/Special Needs

For phones sold in the US, you can use your TTY terminal with your Sony Ericsson mobile phone (with the necessary accessory). For information on Accessible Solutions for individuals with special needs call the Sony Ericsson Special Needs Center on 877 878 1996 (TTY) or 877 207 2056 (voice), or visit the Sony Ericsson Special Needs Center at www.sonyericsson-snc.com.

Disposal of old electrical and electronic equipment

This symbol indicates that all electrical and electronic equipment included shall not be treated as household waste. Instead it shall be left at the appropriate collection point for recycling of electrical and electronic equipment. By ensuring this product is disposed of correctly, you will help prevent potential negative consequences for the environment and human health, which could otherwise be caused by inappropriate waste handling of this product. The recycling of materials will help to conserve natural resources. For more detailed information about recycling this product, please contact your local city office, your household waste disposal service or the shop where you purchased the product.



Disposing of the battery

Please check local regulations for disposal of batteries or call your local Sony Ericsson Call Center for information.

The battery should never be placed in municipal waste. Use a battery disposal facility if available.



Memory Card

Your product comes complete with a removable memory card. It is generally compatible with the handset purchased but may not be compatible with other devices or the capabilities of their memory cards. Check other devices for compatibility before purchase or use.

The memory card is formatted prior to shipping. To reformat the memory card, use a compatible device. Do not use the standard operating system format when formatting the memory card on a PC. For details, refer to the operating instructions of the device or contact customer support.

WARNING:

If your device requires an adapter for insertion into the handset or another device, do not insert the card directly without the required adapter.

Precautions on Memory Card Use

- Do not expose the memory card to moisture.
- Do not touch terminal connections with your hand or any metal object.
- Do not strike, bend, or drop the memory card.
- Do not attempt to disassemble or modify the memory card.
- Do not use or store the memory card in humid or corrosive locations or in excessive heat such as a closed car in summer, in direct sunlight or near a heater, etc.
- Do not press or bend the end of the M2 adapter with excessive force.
- Do not let dirt, dust, or foreign objects get into the insert port of any memory card adapter.
- **Check you have inserted the memory card correctly.**
- Insert the memory card as far as it will go into any memory card adapter needed. The memory card may not operate properly unless fully inserted.
- We recommend that you make a backup copy of important data. We are not responsible for any loss or damage to content you store on the memory card.
- Recorded data may be damaged or lost when you remove the memory card or memory card adapter, turn off the power while formatting, reading or writing data, or use the memory card in locations subject to static electricity or high electrical field emissions.

End User Licence Agreement

This wireless device, including without limitation any media delivered with the device, ("Device") contains software owned by Sony Ericsson Mobile Communications AB and its affiliated companies ("Sony Ericsson") and its third party suppliers and licensors ("Software").

As user of this Device, Sony Ericsson grants you a non-exclusive, non-transferable, non-assignable license to use the Software solely in conjunction with the Device on which it is installed and/or delivered with. Nothing herein shall be construed as a sale of the Software to a user of this Device. You shall not reproduce, modify, distribute, reverse engineer, decompile, otherwise alter or use any other means to discover the source code of the Software or any component of the Software. For avoidance of doubt, you are at all times entitled to transfer all rights and obligations to the Software to a third party, solely together with the Device with which you received the Software, provided always that such third party agrees in writing to be bound by these rules.

You are granted this license for a term of the useful life of this Device. You can terminate this license by transferring all your rights to the Device on which you have received the Software to a third party in writing. If you fail to comply with any of the terms and conditions set out in this license, it will terminate with immediate effect.

Sony Ericsson and its third party suppliers and licensors are the sole and exclusive owner of and retain all rights, title and interest in and to the Software. Sony Ericsson, and, to the extent that the Software contains material or code of a third party, such third party, shall be entitled third party beneficiaries of these terms.

The validity, construction and performance of this license shall be governed by the laws of Sweden. The foregoing shall apply to the full extent permitted by, when applicable, statutory consumer rights.



Limited Warranty

Sony Ericsson Mobile Communications AB, S-221 88 Lund, Sweden, (Sony Ericsson), provides this Limited Warranty for your mobile phone and original accessory delivered with your mobile phone (hereinafter referred to as "Product").

Should your Product need warranty service, please return it to the dealer from whom it was purchased, or contact your local Sony Ericsson Call Center (national rates may apply) or visit www.sonyericsson.com to get further information.

OUR WARRANTY

Subject to the conditions of this Limited Warranty, Sony Ericsson warrants this Product to be free from defects in design, material and workmanship at the time of its original purchase by a consumer, and for a subsequent period of one (1) year.

WHAT WE WILL DO

If, during the warranty period, this Product fails to operate under normal use and service, due to defects in design, materials or workmanship, Sony Ericsson authorised distributors or service partners, in the country/region* where you purchased the Product, will, at their option, either repair or replace the Product in accordance with the terms and conditions stipulated herein.

Sony Ericsson and its service partners reserve the right to charge a handling fee if a returned Product is found not to be under warranty according to the conditions below.

Please note that some of your personal settings, downloads or other information may be lost when your Sony Ericsson Product is repaired or replaced. At present Sony Ericsson may be prevented by applicable law, other regulation or technical restrictions from making a backup copy of certain downloads. Sony Ericsson does not take any responsibility for any lost information of any kind and will not reimburse you for any such loss. You

should always make backup copies of all the information stored on your Sony Ericsson Product such as downloads, calendar and contacts before handing in your Sony Ericsson Product for repair or replacement.

CONDITIONS

- 1 The warranty is valid only if the original proof of purchase issued to the original purchaser by a Sony Ericsson authorised dealer, specifying the date of purchase and serial number**, for this Product, is presented with the Product to be repaired or replaced. Sony Ericsson reserves the right to refuse warranty service if this information has been removed or changed after the original purchase of the Product from the dealer.
- 2 If Sony Ericsson repairs or replaces the Product, the repaired or replaced Product shall be warranted for the remaining time of the original warranty period or for ninety (90) days from the date of repair, whichever is longer. Repair or replacement may involve the use of functionally equivalent reconditioned units. Replaced parts or components will become the property of Sony Ericsson.
- 3 This warranty does not cover any failure of the Product due to normal wear and tear, or due to misuse, including but not limited to use in other than the normal and customary manner, in accordance with the Sony Ericsson instructions for use and maintenance of the Product. Nor does this warranty cover any failure of the Product due to accident, software or hardware modification or adjustment, acts of God or damage resulting from liquid.

A rechargeable battery can be charged and discharged hundreds of times. However, it will eventually wear out – this is not a defect. When the talk-time or standby time is noticeably shorter, it is time to replace your battery. Sony Ericsson recommends that you use only batteries and chargers approved by Sony Ericsson.

Minor variations in display brightness and color may occur between phones. There may be tiny bright or dark dots on the display. These are called defective pixels and occur when individual dots have malfunctioned and can not be adjusted. Two defective pixels are deemed acceptable.

Minor variations in the appearance of the camera image may occur between phones. This is not uncommon in digital cameras and does not mean that the camera is defective in any way.

- 4 Since the cellular system on which the Product is to operate is provided by a carrier independent from Sony Ericsson, Sony Ericsson will not be responsible for the operation, availability, coverage, services or range of that system.
- 5 This warranty does not cover Product failures caused by installations, modifications, or repair or opening of the Product performed by a non-Sony Ericsson authorised person.
- 6 The warranty does not cover Product failures which have been caused by use of accessories or other peripheral devices which are not Sony Ericsson branded original accessories intended for use with the Product.
- 7 Tampering with any of the seals on the Product will void the warranty.
- 8 **THERE ARE NO EXPRESS WARRANTIES, WHETHER WRITTEN OR ORAL, OTHER THAN THIS PRINTED LIMITED WARRANTY. ALL IMPLIED WARRANTIES, INCLUDING WITHOUT LIMITATION THE IMPLIED WARRANTIES OF MERCHANTABILITY OR FITNESS FOR A PARTICULAR PURPOSE, ARE LIMITED TO THE DURATION OF THIS LIMITED WARRANTY. IN NO EVENT SHALL SONY ERICSSON OR ITS LICENSORS BE LIABLE FOR INCIDENTAL OR CONSEQUENTIAL DAMAGES OF ANY NATURE WHATSOEVER, INCLUDING BUT NOT LIMITED TO LOST PROFITS OR COMMERCIAL LOSS; TO THE FULL EXTENT THOSE DAMAGES CAN BE DISCLAIMED BY LAW.**

Some countries/states do not allow the exclusion or limitation of incidental or consequential damages, or limitation of the duration of implied warranties, so the preceding limitations or exclusions may not apply to you.

The warranty provided does not affect the consumer's statutory rights under applicable legislation in force, nor the consumer's rights against the dealer arising from their sales / purchase contract.

*EUROPEAN UNION (EU)

If you have purchased your Product in an EU country you can have your Product serviced, under the conditions set out above, within the warranty period in any EU country where an identical Product is sold by an authorised Sony Ericsson distributor. To find out if your Product is sold in the EU country you are in, please call the local Sony Ericsson Call Center. Please observe that certain services may not be possible elsewhere than in the country of original purchase, for example due to the fact that your Product may have an interior or exterior which is different from equivalent models sold in other EU countries. It may not be possible to repair SIM-locked Products.

** In some countries/regions additional information is requested. If so, this is clearly shown on the valid proof of purchase.

FCC Statement

This device complies with Part 15 of the FCC rules. Operation is subject to the following two conditions:



(1) This device may not cause harmful interference, and (2) This device must accept any interference received, including interference that may cause undesired operation.

Bluetooth wireless technology

Bluetooth™ Qualified Design ID is B011122.

Declaration of Conformity

We, Sony Ericsson Mobile Communications AB of Nya Vattentorget

S-221 88 Lund, Sweden

declare under our sole responsibility that our product

Sony Ericsson type AAD-3022044-BV

and in combination with our accessories, to which this declaration relates is in conformity with the appropriate standards 3GPP TS 51.010-1, EN 301908-1, EN 301489-7, EN 301489-24, EN 300328, EN 301489-17 and EN 60950, following the provisions of, Radio Equipment and Telecommunication Terminal Equipment directive 99/5/EC with requirements covering EMC directive 89/336/EEC, and Low Voltage directive 73/23/EEC.

Lund, June 2006

CE 0682

Shoji Nemoto,
Head of Product Business Unit GSM/UMTS

We fulfil the requirements of the R&TTE Directive (99/5/EC).

Index

- A**
- Activity menu 6
 - alarms 39
 - appointments 40
 - automatic redialling 18
- B**
- battery
 - inserting and charging 4
 - use and care 44
 - blog 30
 - Bluetooth™ wireless technology 35
 - business cards 24
- C**
- calendar 39–41
 - call list 23
 - calls
 - emergency 18
 - international 17
 - making 5, 17
 - missed 18
 - receiving 18
 - video 19
- E**
- camera 7, 29
 - contacts
 - adding phone contacts 21
 - default contacts 20
 - groups of 24
 - synchronizing 34
 - email 27
 - entering letters 14
- F**
- file manager 15
- H**
- handsfree 9, 20
 - Bluetooth 36
 - help 5
- I**
- Internet
 - blog 30
- K**
- keys 8, 12

M		S	
M2™	9, 46	safety guidelines	43
memory card	15, 46	sending	
memory status	15	appointments and tasks	41
menu overview	10	business cards	24
menus	12	pictures	31
messages		settings	
email	27	email	27
picture	26	setup wizard	5
text	25	SIM card	
microphone	18	contact numbers	21
music player	31	copying to/from	22
		SMS <i>See</i> text messages	25
N		SOS <i>See</i> emergency numbers	18
navigating menus	12	standby	5
networks	17	synchronizing	34–35
P		T	
phone overview	8	T9™ Text Input	14
picture messages	26–27	text messages	25–26
pictures	31	transferring	
PlayNow™	32	camera pictures	30
		files	37
R		U	
ringtones	32–33	Update service	38
RSS reader	34		

V

video player	31
video recorder	29
voice dialling	23
volume	
ear speaker	18
ringtone	32

W

warranty	47
----------------	----

Z

zoom	29
------------	----

