

Prepared (also subject responsible if other)

LD/SEMC/BGGI/NM *Ramadan Plicanic*

Approved

LD/SEMC/BGGI/NMC *Mats Hansson*

Checked

060519

Company Internal
REPORT

No.

BGGIN06:183

Date

060519

Rev

A

Reference

File

Report issued by Accredited SAR Laboratory**for****PY7AD022031 (K800)****Date of test:** 12 and 15 May, 2006**Laboratory:** Sony Ericsson SAR Test Laboratory
Sonyericsson Mobile Communications AB
Nya Vattentornet
SE-221 82 LUND, Sweden**Testing Engineer:** *Ramadan Plicanic*
Ramadan.Plicanic@sonyericsson.com
+46 46 19 38 62**Testing Approval** *Mats Hansson*
Mats.Hansson@sonyericsson.com
+46 46 19 33 57**Statement of Compliance**

Sony Ericsson Mobile Communications AB declares under its sole responsibility that the product

Sony EricssonType : AAD-3022031-BV; FCC ID : PY7AD022031; IC:4170B-AD022031

to which this declaration relates, is in conformity with the appropriate RF exposure standards recommendations and guidelines. It also declares that the product was tested in accordance with the appropriate measurement standards, guidelines and recommended practices. Any deviations from these standards, guidelines and recommended practices are noted below:

(None)

This laboratory is accredited to ISO/IEC 17025 (SWEDAC accreditation no. 1847).



Laboratories are accredited by the Swedish Board for Accreditation and Conformity Assessment (SWEDAC) under the terms of Swedish legislation. The accredited laboratory activities meet the requirements in SS-EN ISO/IEC 17025 (2000). This report may not be reproduced other than in full, except with the prior written approval of the issuing laboratory.

The results and statements contained herein relate only to the items tested. The names of individuals involved may be mentioned only in connection with the statements or results from this report.

Sony Ericsson encourages all feedback, both positive and negative, on this report.

© Sony Ericsson Mobile Communication AB, 2006



Prepared (also subject responsible if other)

LD/SEMC/BGGI/NM *Ramadan Plicanic*

Approved

LD/SEMC/BGGI/NMC Mats Hansson

Checked

060519

No.

BGGIN06:183

Date

060519

Rev

A

Reference

File

1 Table of contents

2 INTRODUCTION.....3

3 DEVICE UNDER TEST.....3

3.1 ANTENNA DESCRIPTION3

3.2 DEVICE DESCRIPTION3

4 TEST EQUIPMENT.....4

4.1 DOSIMETRIC SYSTEM.....4

4.2 ADDITIONAL EQUIPMENT4

5 ELECTRICAL PARAMETERS ON THE TISSUE SIMULATING LIQUID5

6 SYSTEM ACCURACY VERIFICATION.....5

7 SAR MEASUREMENT UNCERTAINTY6

8 TEST RESULTS7

9 REFERENCES.....8

10 APPENDIX9

10.1 PHOTOGRAPHS OF THE DEVICE UNDER TEST10

10.2 DEVICE POSITION ON SAM TWINS PHANTOM11



Prepared (also subject responsible if other)

LD/SEMC/BGGI/NM *Ramadan Plicanic*

Approved

LD/SEMC/BGGI/NMC Mats Hansson

Checked

060519

No.

BGGIN06:183

Date

060519

Rev

A

Reference

File

2 Introduction

In this test report, compliance of the Sony Ericsson PY7AD022031 portable telephone with RF safety guidelines is demonstrated. The applicable RF safety guidelines and the SAR measurement specifications used for the test are described in the *SAR Measurement Specifications of Wireless Handsets* [1].

3 Device Under Test

3.1 Antenna Description

Type	Build in	
Location	Up on the back side	
Dimensions	Max length	38mm
	Max width	28mm
Configuration	PIFA	

3.2 Device description

Device model	PY7AD022031					
Serial number	CB5107FYE6 (#4715)					
Mode	GSM1900					
Multiple Access Scheme	TDMA			TDMA, GPRS 2slots		
Output Power Setting	fl	fm	fh	fl	fm	fh
	30.5	30.4	30.4	30.5	30.4	30.4
Factory Tolerance in Power Setting	±0.5 dB			±0.5 dB		
Maximum Peak Output Power	30.5dBm			30.5dBm		
Crest Factor	8.3			4.15		
Transmitting Frequency Range(MHz)	1850.2 – 1909.8					
Prototype or Production Unit	Preproduction HW FP2.2					
Device Category	Portable					
RF exposure environment	General population / uncontrolled					



Prepared (also subject responsible if other)

LD/SEMC/BGGI/NM *Ramadan Plicanic*

Approved

LD/SEMC/BGGI/NMC Mats Hansson

Checked

060519

No.

BGGIN06:183

Date

060519

Rev

A

Reference

File

4 Test equipment

4.1 Dosimetric system

SAR measurements were made using the DASY4 professional system (software version 4.6, Built 23.7) with SAM twin phantom, manufactured by Schmid & Partner Engineering AG (SPEAG). The list of calibrated equipment is given below.

Description	Serial Number	Due Date
DASY DAE V1	640	012007
E-field probe ET3DV6	1815	012007
Dipole Validation Kit, D1900V2	5d002	032007

4.2 Additional equipment

Description	Inventory Number	Due Date
Signal generator ESG-D4000A	INV 462935	032007
Directional coupler HP778D	INV 2903	032007
Power meter R&S NRVD	INV 20007668	122007
Power sensor R&S NRV-Z5	INV 20007670	122007
Power sensor R&S NRV-Z5	INV 20007671	122007
Termination 65N50-0-11	INV 2903	032007
Network analyzer HP8753C	INV421671	032007
S-parameter test set HP85047A	INV 421670	032007
Dielectric probe kit HP85070D	INV 20000053	Self cal



Prepared (also subject responsible if other)

LD/SEMC/BGGI/NM *Ramadan Plicanic*

Approved

LD/SEMC/BGGI/NMC Mats Hansson

Checked

060519

No.

BGGIN06:183

Date

060519

Rev

A

Reference

File

5 Electrical parameters on the tissue simulating liquid

Prior to conducting SAR measurements, the relative permittivity, ϵ_r , and the conductivity, σ , of the tissue simulating liquids were measured with the dielectric probe kit. These values are shown in the table below. The mass density, ρ , entered into the DASY3 software is also given.

Recommended limits for permittivity ϵ_r , conductivity σ and mass density ρ are also shown.

f (MHz)	Tissue type	Limits / Measured	Dielectric Parameters		
			ϵ_r	σ (S/m)	ρ (g/cm ³)
1900	Head	Measured, 12/May/2006	39.0	1.46	1.00
		Recommended	40.0	1.40	1.00
1900	Body	Measured, 15/May/2006	50.9	1.53	1.00
		Recommended	53.3	1.52	1.00

6 System accuracy verification

A system accuracy verification of the DASY4 was performed using the dipole validation kit listed in section 3.1. The system verification test was conducted on the same day as the measurement of the DUT. Measurement made in ambient temperature 23.0 °C and humidity 31%. The obtained results are displayed in the table below.

RF noise had been measured in liquid when all RF equipment in lab was set off. Measured value was 0.000012mW/g in 1g mass.

f (MHz)	Liquid	Measured / Reference	SAR (W/kg) 1g/10g	Dielectric Parameters			Liquid t(°C)
				ϵ_r	σ (S/m)	ρ (g/cm ³)	
1900	Head	Measured, 12/May/2006	38.8/20.4	39.0	1.46	1.00	22.6
		Reference	39.2/20.6	39.6	1.45	1.00	21.5
1900	Body	Measured, 15/May/2006	39.3/21.0	50.9	1.53	1.00	22.1
		Reference	39.6/20.9	51.6	1.58	1.00	22



Prepared (also subject responsible if other)

LD/SEMC/BGGI/NM *Ramadan Plicanic*

Approved

LD/SEMC/BGGI/NMC *Mats Hansson*

Checked

060519

No.

BGGIN06:183

Date

060519

Rev

A

Reference

File

7 SAR measurement uncertainty

DASY4 SAR measurement uncertainty evaluation for Sony Ericsson PY7AD022031 phone According to IEEE 1528

Uncertainty Component	Uncer. (%)	Prob Dist.	Div.	C _i	GSM 1900-Head	GSM 1900-Body
Measurement System						
Probe Calibration	±5.9	N	1	1	±5.9	±5.9
Axial Isotropy	±4.7	R	√3	0.7	±1.9	±1.9
Spherical Isotropy	±9.6	R	√3	0.7	±3.9	±3.9
Boundary Effect	±1.0	R	√3	1	±1.0	±1.0
Linearity	±4.7	R	√3	1	±2.7	±2.7
System Detection Limits	±1.0	R	√3	1	±0.6	±0.6
Readout electronics	±0.3	N	1	1	±0.3	±0.3
Response time	±0.8	R	√3	1	±0.5	±0.5
Integration time	±2.6	R	√3	1	±1.5	±1.5
RF Ambient Conditions	±3.0	R	√3	1	±1.7	±1.7
Probe Positioner	±0.4	R	√3	1	±0.2	±0.2
Probe Positioning	±2.9	R	√3	1	±1.7	±1.7
Max. SAR Evaluation	±1.0	R	√3	1	±0.6	±0.6
Measurement System Uncertainty					±8.4	±8.4
Test Sample Related						
Device positioning	±2.9	N	1	1	±2.9	±2.9
Device holder uncertainty	±3.6	N	1	1	±3.6	±3.6
Power drift	-2.1/-1.8	R	√3	1	-1.2	-1.0
Test Sample Related Uncertainty					±4.8	±4.7
Phantom and Tissue Parameters						
Phantom uncertainty	±4.0	R	√3	1	±2.3	±2.3
Liquid conductivity (meas)	±2.5	N	1	0.64	±1.6	±1.6
Liquid conductivity (target)	+4.3/+0.7	R	√3	0.64	+1.6	+0.3
Liquid Permittivity (meas)	±2.5	N	1	0.6	±1.5	±1.5
Liquid Permittivity (target)	-2.5/-4.5	R	√3	0.6	-0.9	-1.6
Phantom and Tissue Parameters Uncertainty					±3.7	±3.6
Combined standard uncertainty					±10.4	±10.3
Extended standard uncertainty (k=2)					±20.8	±20.6



Prepared (also subject responsible if other)

LD/SEMC/BGGI/NM *Ramadan Plicanic*

Approved

LD/SEMC/BGGI/NMC Mats Hansson

Checked

060519

No.

BGGIN06:183

Date

060519

Rev

A

Reference

File

8 Test results

The measured 1-gram averaged SAR values of the device against head and body are provided in Table 1 and Table 2. The ambient humidity and temperature of test facility were (33-31) % and (22.0–23.0) °C respectively.

The depth of the head and body tissue simulating liquids were 15.3cm and 15.2cm. A base station simulator was used to control the device during the SAR measurements. The phone was supplied with full-charged battery for each measurement.

For head measurement, the device was tested on the right-hand phantom (corresponding to the right side of the head) and the left-hand phantom in two different phones position, cheek (touch) and tilt (cheek + 15deg). For all modes, the device was tested at the lowest, middle and highest frequencies in the transmit band.

For body measurements the phone was tested in speech and data mode when the phone's antenna (Back) was against the flat section of the phantom with 15mm distance. For worst case phone was tested with front against the flat section. For speech mode it's used Sony Ericsson portable hands free HPM-20 or BT portable hands free HBH-610a.

Mode	Channel	Power (dB)	Phone Position	Liquid t (°C)	SAR (W/kg)	
					Right-hand	Left-hand
					1g mass	1g mass
1900 GSM	512	30.5	Cheek	22.6	0.44	0.48
			Tilt	22.6	0.47	0.45
	661	30.4	Cheek	22.6	0.62	0.71
			Tilt	22.6	0.76	0.72
	810	30.4	Cheek	22.6	0.72	0.83
			Tilt	22.6	0.88	0.81

Table1: SAR measurement result for Sony Ericsson PY7AD022031 telephone at highest possible output power. Measured against the head.

Mode	Channel	Power (dBm)	Phone Position	Liquid t (°C)	SAR (W/kg) in 1 g mass
1900 GSM	512	30.5	Antenna to phantom, speech, HBH610a	22.1	0.29
			Antenna to phantom, data, GPRS 2SI	22.1	0.54
	661	30.4	Antenna to phantom, speech, HBH610a	22.1	0.36
			Antenna to phantom, data, GPRS 2SI	22.1	0.68
	810	30.4	Antenna to phantom, speech, HBH610a	22.1	0.40
			Antenna to phantom, speech, HPM20	22.1	0.31
		Antenna to phantom, data, GPRS 2SI	22.1	0.77	

Table2: SAR measurement result for Sony Ericsson PY7AD022031 telephone at highest possible output power. Measured against the body.



Company Internal
REPORT

Prepared (also subject responsible if other)

LD/SEMC/BGGI/NM *Ramadan Plicanic*

Approved

LD/SEMC/BGGI/NMC Mats Hansson

Checked

060519

No.

BGGIN06:183

Date

060519

Rev

A

Reference

File

9 References

[1] R.Plicanic, "SAR Measurement Specification of Wireless Handsets", Sony Ericsson SAR Test Laboratory internal document GUG/N 03:141

[2] Basic standard for the Measurement of Specific Absorption Rate related to human exposure to electromagnetic fields from mobile phones (300MHz-3GHz), European Standard EN 50361, July 2001

[3] FCC, "Evaluating Compliance with FCC Guidelines for Human Exposure to Radio Frequency Electromagnetic Fields: Additional Information for Evaluating Compliance of Mobile and Portable Devices with FCC Limits for Human Exposure to Radio Frequency Emissions," Supplement C (Edition 01-01) to OET Bulletin 65 (Edition 97- 01).

[4] IEEE, "Recommended Practice for Determining the Peak Spatial-Average Specific Absorption Rate (SAR) in the Human Body Due to Wireless Communications Devices: Experimental Techniques," Std 1528-2003, June, 2003.



Prepared (also subject responsible if other)

LD/SEMC/BGGI/NM *Ramadan Plicanic*

Approved

LD/SEMC/BGGI/NMC Mats Hansson

Checked

060519

No.

BGGIN06:183

Date

060519

Rev

A

Reference

File

10 Appendix

10.1 Photographs of the device under test



Front & Back sides



System Connector



Profile



Sony Ericsson

Company Internal
REPORT

Prepared (also subject responsible if other)

LD/SEMC/BGGI/NM *Ramadan Plicanic*

Approved

LD/SEMC/BGGI/NMC Mats Hansson

Checked

060519

No.

BGGIN06:183

Date

060519

Rev

A

Reference

File



Back side with battery

Prepared (also subject responsible if other)

LD/SEMC/BGGI/NM *Ramadan Plicanic*

Approved

LD/SEMC/BGGI/NMC Mats Hansson

Checked

060519

No.

BGGIN06:183

Date

060519

Rev

A

Reference

File

10.2 Device position on SAM Twins Phantom

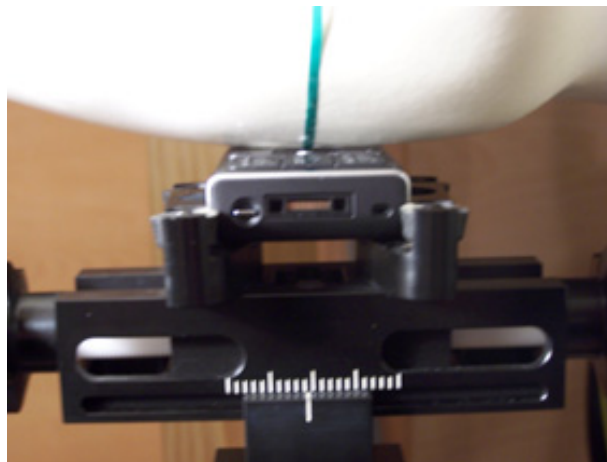

Device position against the head: Cheek (touch) phone position



Device position against the head: Tilt (cheek+15deg) phone position



Company Internal
REPORT

Prepared (also subject responsible if other)

LD/SEMC/BGGI/NM *Ramadan Plicanic*

Approved

LD/SEMC/BGGI/NMC Mats Hansson

Checked

060519

No.

BGGIN06:183

Date

060519

Rev

A

Reference

File



Device position against the body: 15mm distance from Phantom.

DASY4 Validation Report for Head TSL

Date/Time: 09.03.2005 15:20:45

Test Laboratory: SPEAG, Zurich, Switzerland

DUT: Dipole 1900 MHz; Type: D1900V2; Serial: D1900V2 - SN:5d002

Communication System: CW-1900; Frequency: 1900 MHz; Duty Cycle: 1:1

Medium: HSL 1900 MHz;

Medium parameters used: $f = 1900$ MHz; $\sigma = 1.46$ mho/m; $\epsilon_r = 39.5$; $\rho = 1000$ kg/m³

Phantom section: Flat Section

Measurement Standard: DASY4 (High Precision Assessment)

DASY4 Configuration:

- Probe: ET3DV6 - SN1507; ConvF(4.96, 4.96, 4.96); Calibrated: 26.10.2004
- Sensor-Surface: 4mm (Mechanical Surface Detection)
- Electronics: DAE4 Sn601; Calibrated: 07.01.2005
- Phantom: Flat Phantom 5.0; Type: QD000P50AA; Serial: 1001;
- Measurement SW: DASY4, V4.5 Build 19; Postprocessing SW: SEMCAD, V1.8 Build 146

Pin = 250 mW; d = 10 mm/Area Scan (81x81x1): Measurement grid: dx=15mm, dy=15mm
Maximum value of SAR (interpolated) = 11.4 mW/g

Pin = 250 mW; d = 10 mm/Zoom Scan (7x7x7)/Cube 0: Measurement grid: dx=5mm, dy=5mm, dz=5mm

Reference Value = 91.4 V/m; Power Drift = 0.037 dB

Peak SAR (extrapolated) = 16.9 W/kg

SAR(1 g) = 9.81 mW/g; SAR(10 g) = 5.15 mW/g

Maximum value of SAR (measured) = 11.0 mW/g

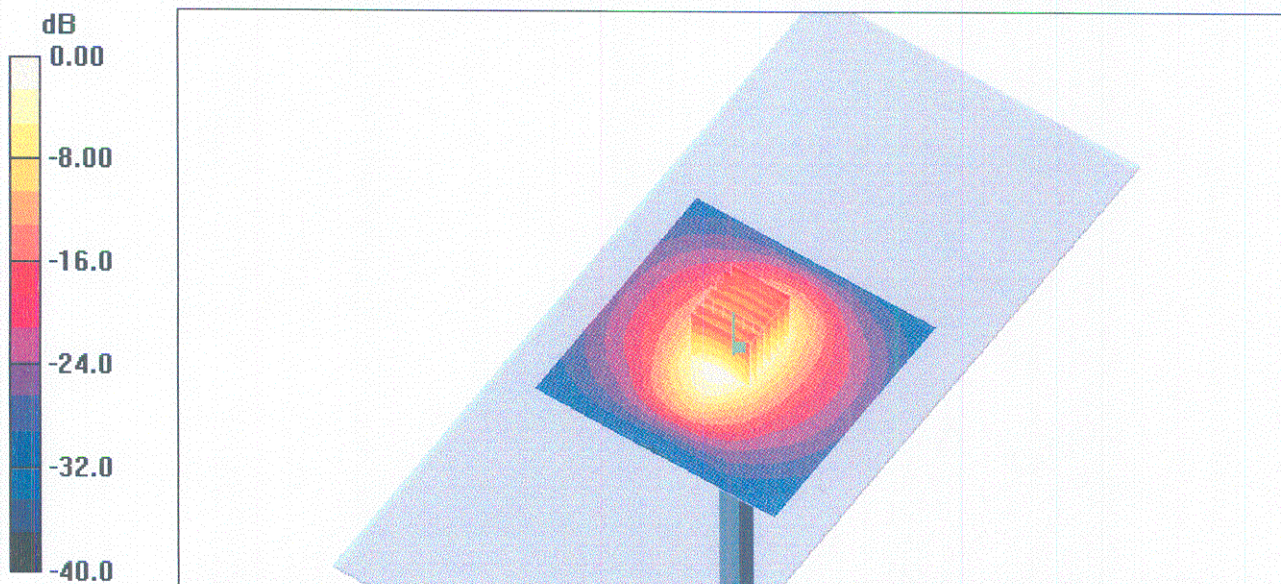

0 dB = 11.0mW/g

DASY4 Validation Report for Body TSL

Date/Time: 15.03.2005 15:20:32

Test Laboratory: SPEAG, Zurich, Switzerland

DUT: Dipole 1900 MHz; Type: D1900V2; Serial: D1900V2 - SN:5d002

Communication System: CW-1900; Frequency: 1900 MHz; Duty Cycle: 1:1

Medium: MSL 1900 MHz;

Medium parameters used: $f = 1900$ MHz; $\sigma = 1.57$ mho/m; $\epsilon_r = 52.2$; $\rho = 1000$ kg/m³

Phantom section: Flat Section

Measurement Standard: DASY4 (High Precision Assessment)

DASY4 Configuration:

- Probe: ET3DV6 - SN1507; ConvF(4.43, 4.43, 4.43); Calibrated: 26.10.2004
- Sensor-Surface: 4mm (Mechanical Surface Detection)
- Electronics: DAE4 Sn601; Calibrated: 07.01.2005
- Phantom: Flat Phantom 5.0; Type: QD000P50AA; Serial: 1001;
- Measurement SW: DASY4, V4.5 Build 19; Postprocessing SW: SEMCAD, V1.8 Build 146

Pin = 250 mW; d = 10 mm/Area Scan (81x81x1): Measurement grid: dx=15mm, dy=15mm
Maximum value of SAR (interpolated) = 11.4 mW/g

Pin = 250 mW; d = 10 mm/Zoom Scan (7x7x7)/Cube 0: Measurement grid: dx=5mm, dy=5mm, dz=5mm

Reference Value = 87.3 V/m; Power Drift = 0.061 dB

Peak SAR (extrapolated) = 16.8 W/kg

SAR(1 g) = 9.91 mW/g; SAR(10 g) = 5.23 mW/g

Maximum value of SAR (measured) = 11.3 mW/g

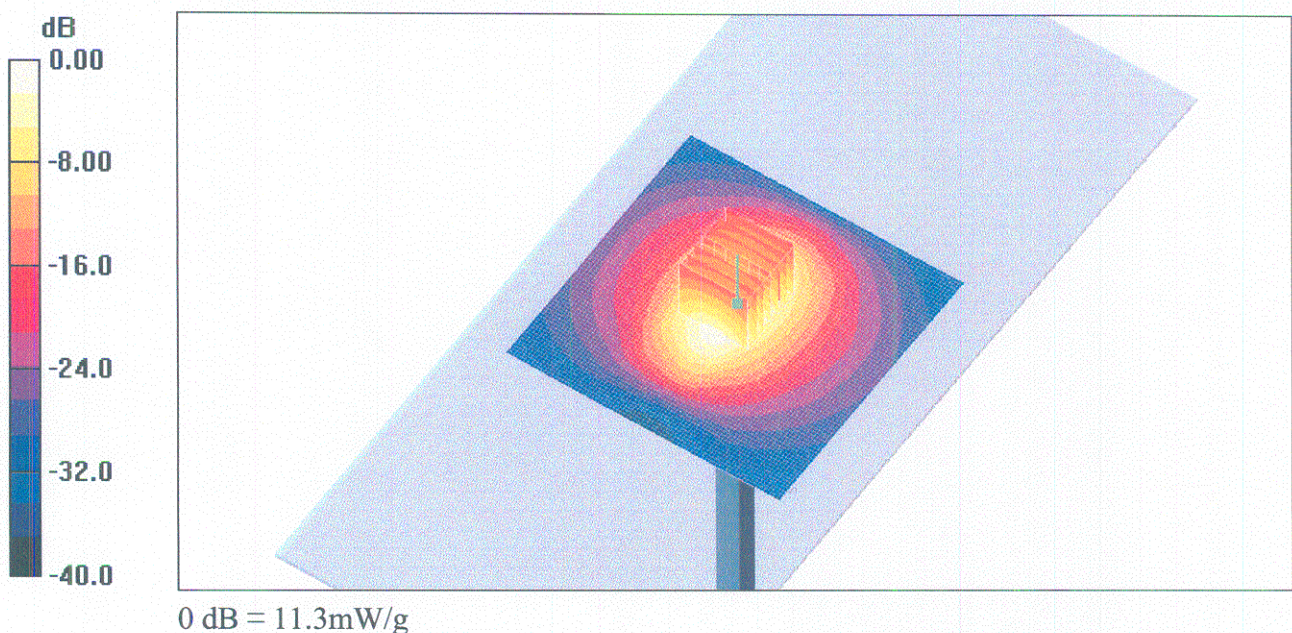

Date/Time: 2006-05-15 10:03:03

Test Laboratory: Sony Ericsson Mobile Communications
File Name: [Verification_1900MHz_Body_060515_RP.da4](#)

DUT: Dipole 1900 MHz; Type: D1900V2; Serial: D1900V2 - SN:5d002
Program Name: Verification Measurement on 1900MHz with BSL

Communication System: CW; Frequency: 1900 MHz; Duty Cycle: 1:1
Medium parameters used: $f = 1900$ MHz; $\sigma = 1.53$ mho/m; $\epsilon_r = 50.9$; $\rho = 1000$ kg/m³
Phantom section: Flat Section

DASY4 Configuration:

- Probe: ET3DV6 - SN1815; ConvF(4.6, 4.6, 4.6); Calibrated: 2006-01-20
- Sensor-Surface: 4mm (Mechanical Surface Detection)
- Electronics: DAE4 SN640; Calibrated: 2006-01-18
- Phantom: SAM 6; Type: SAM; Serial: 1351
- Measurement SW: DASY4, V4.6 Build 23; Postprocessing SW: SEMCAD, V1.8 Build 161

Flat, 10mm/Area Scan (61x61x1): Measurement grid: dx=10mm, dy=10mm
Maximum value of SAR (interpolated) = 4.57 mW/g

Flat, 10mm/Zoom Scan (5x5x7)/Cube 0: Measurement grid: dx=8mm, dy=8mm, dz=5mm
Reference Value = 57.9 V/m; Power Drift = -0.028 dB
Peak SAR (extrapolated) = 6.47 W/kg
SAR(1 g) = 3.93 mW/g; SAR(10 g) = 2.1 mW/g
Maximum value of SAR (measured) = 4.40 mW/g

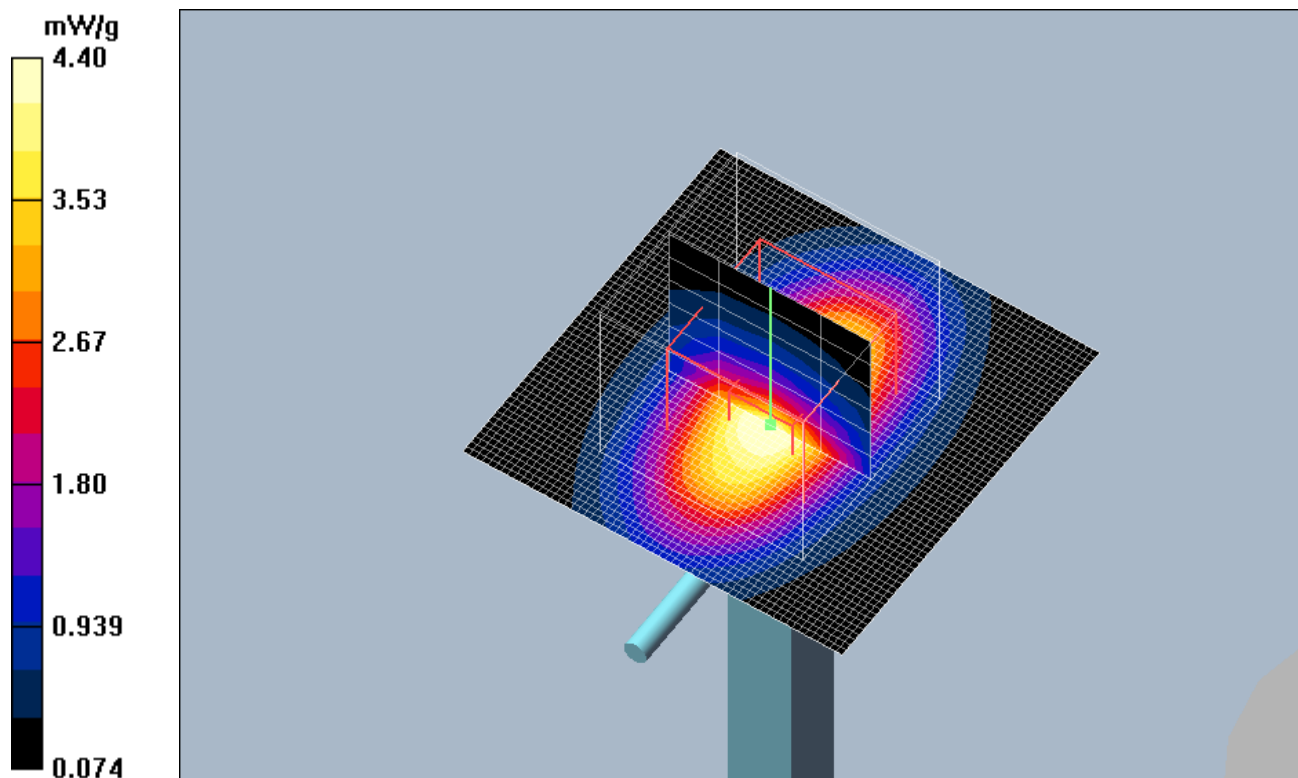

Date/Time: 2006-05-12 09:10:49

Test Laboratory: Sony Ericsson Mobile Communications
 File Name: [Verification_1900MHz_Head_060512_RP.da4](#)

DUT: Dipole 1900 MHz; Type: D1900V2; Serial: D1900V2 - SN:5d002
Program Name: Verification Measurement on 1900MHz with HSL

Communication System: CW; Frequency: 1900 MHz; Duty Cycle: 1:1
 Medium parameters used: $f = 1900$ MHz; $\sigma = 1.46$ mho/m; $\epsilon_r = 39$; $\rho = 1000$ kg/m³
 Phantom section: Flat Section

DASY4 Configuration:

- Probe: ET3DV6 - SN1815; ConvF(5.23, 5.23, 5.23); Calibrated: 2006-01-20
- Sensor-Surface: 4mm (Mechanical Surface Detection)
- Electronics: DAE4 SN640; Calibrated: 2006-01-18
- Phantom: SAM 6; Type: SAM; Serial: 1351
- Measurement SW: DASY4, V4.6 Build 23; Postprocessing SW: SEMCAD, V1.8 Build 161

Flat, 10mm/Area Scan (61x61x1): Measurement grid: dx=10mm, dy=10mm
 Maximum value of SAR (interpolated) = 4.37 mW/g

Flat, 10mm/Zoom Scan (5x5x7)/Cube 0: Measurement grid: dx=8mm, dy=8mm, dz=5mm
 Reference Value = 57.8 V/m; Power Drift = -0.021 dB
 Peak SAR (extrapolated) = 6.70 W/kg
SAR(1 g) = 3.88 mW/g; SAR(10 g) = 2.04 mW/g
 Maximum value of SAR (measured) = 4.39 mW/g

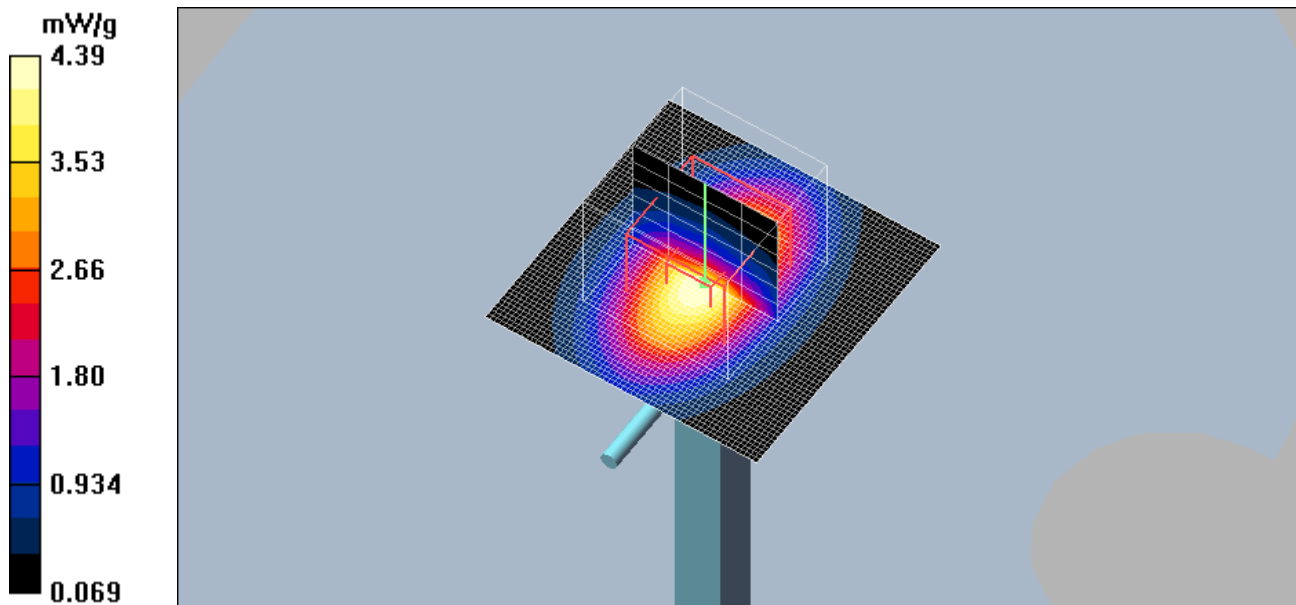

Date/Time: 2006-05-12 12:22:51

Test Laboratory: Sony Ericsson Mobile Communications

File Name: [ch810_Right_Cheek_060512_RP.da4](#)

DUT: PY7AD022031 (K800); Type: GSM900,1800,1900 and UMTS; Serial: #4715
Program Name: SAR Measurement on the Head

Communication System: GSM 1900; Frequency: 1909.8 MHz; Duty Cycle: 1:8.3

Medium parameters used: $f = 1909.8$ MHz; $\sigma = 1.47$ mho/m; $\epsilon_r = 39$; $\rho = 1000$ kg/m³

Phantom section: Right Section

DASY4 Configuration:

- Probe: ET3DV6 - SN1815; ConvF(5.23, 5.23, 5.23); Calibrated: 2006-01-20

- Sensor-Surface: 4mm (Mechanical Surface Detection)

- Electronics: DAE4 SN640; Calibrated: 2006-01-18

- Phantom: SAM 6; Type: SAM; Serial: 1351

- Measurement SW: DASY4, V4.6 Build 23; Postprocessing SW: SEMCAD, V1.8 Build 161

Right, Cheek/Area Scan (61x121x1): Measurement grid: dx=10mm, dy=10mm

Maximum value of SAR (interpolated) = 0.806 mW/g

Right, Cheek/Zoom Scan (5x5x7)/Cube 0: Measurement grid: dx=8mm, dy=8mm, dz=5mm

Reference Value = 16.1 V/m; Power Drift = -0.096 dB

Peak SAR (extrapolated) = 1.11 W/kg

SAR(1 g) = 0.717 mW/g; SAR(10 g) = 0.407 mW/g

Maximum value of SAR (measured) = 0.780 mW/g

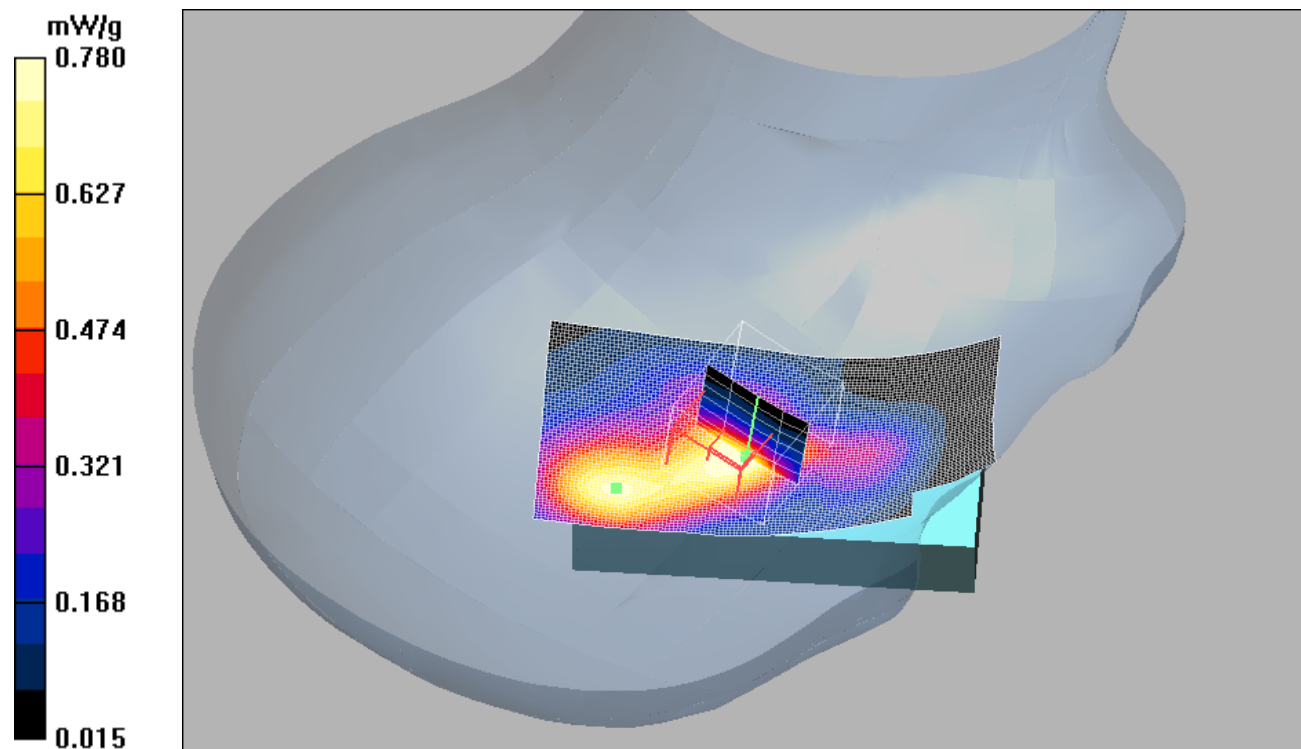

Date/Time: 2006-05-12 11:24:23

Test Laboratory: Sony Ericsson Mobile Communications
File Name: [ch810_Left_Tilt_060512_RP.da4](#)

DUT: PY7AD022031 (K800); Type: GSM900,1800,1900 and UMTS; Serial: #4715
Program Name: SAR Measurement on the Head

Communication System: GSM 1900; Frequency: 1909.8 MHz; Duty Cycle: 1:8.3
Medium parameters used: $f = 1909.8$ MHz; $\sigma = 1.47$ mho/m; $\epsilon_r = 39$; $\rho = 1000$ kg/m³
Phantom section: Left Section

DASY4 Configuration:

- Probe: ET3DV6 - SN1815; ConvF(5.23, 5.23, 5.23); Calibrated: 2006-01-20
- Sensor-Surface: 4mm (Mechanical Surface Detection)
- Electronics: DAE4 SN640; Calibrated: 2006-01-18
- Phantom: SAM 6; Type: SAM; Serial: 1351
- Measurement SW: DASY4, V4.6 Build 23; Postprocessing SW: SEMCAD, V1.8 Build 161

Left, Tilt/Area Scan (61x121x1): Measurement grid: dx=10mm, dy=10mm
Maximum value of SAR (interpolated) = 0.910 mW/g

Left, Tilt/Zoom Scan (5x5x7)/Cube 0: Measurement grid: dx=8mm, dy=8mm, dz=5mm
Reference Value = 23.7 V/m; Power Drift = -0.062 dB
Peak SAR (extrapolated) = 1.35 W/kg
SAR(1 g) = 0.814 mW/g; SAR(10 g) = 0.449 mW/g
Maximum value of SAR (measured) = 0.917 mW/g

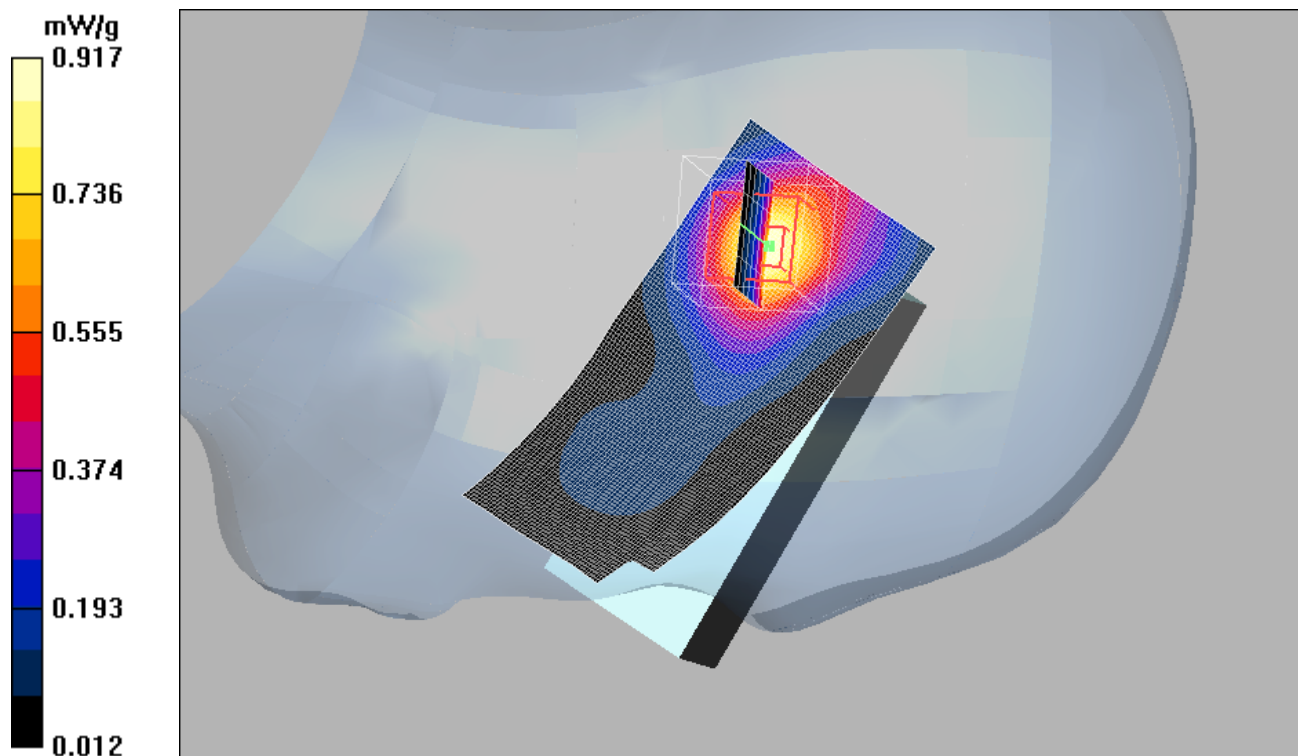

Date/Time: 2006-05-12 11:04:01

Test Laboratory: Sony Ericsson Mobile Communications
 File Name: [ch810_Left_Cheek_060512_RP.da4](#)

DUT: PY7AD022031 (K800); Type: GSM900,1800,1900 and UMTS; Serial: #4715
Program Name: SAR Measurement on the Head

Communication System: GSM 1900; Frequency: 1909.8 MHz; Duty Cycle: 1:8.3
 Medium parameters used: $f = 1909.8$ MHz; $\sigma = 1.47$ mho/m; $\epsilon_r = 39$; $\rho = 1000$ kg/m³
 Phantom section: Left Section

DASY4 Configuration:

- Probe: ET3DV6 - SN1815; ConvF(5.23, 5.23, 5.23); Calibrated: 2006-01-20
- Sensor-Surface: 4mm (Mechanical Surface Detection)
- Electronics: DAE4 SN640; Calibrated: 2006-01-18
- Phantom: SAM 6; Type: SAM; Serial: 1351
- Measurement SW: DASY4, V4.6 Build 23; Postprocessing SW: SEMCAD, V1.8 Build 161

Left, Cheek/Area Scan (61x121x1): Measurement grid: dx=10mm, dy=10mm
 Maximum value of SAR (interpolated) = 0.958 mW/g

Left, Cheek/Zoom Scan (5x5x7)/Cube 0: Measurement grid: dx=8mm, dy=8mm, dz=5mm
 Reference Value = 18.6 V/m; Power Drift = -0.111 dB
 Peak SAR (extrapolated) = 1.38 W/kg
SAR(1 g) = 0.828 mW/g; SAR(10 g) = 0.449 mW/g
 Maximum value of SAR (measured) = 0.934 mW/g

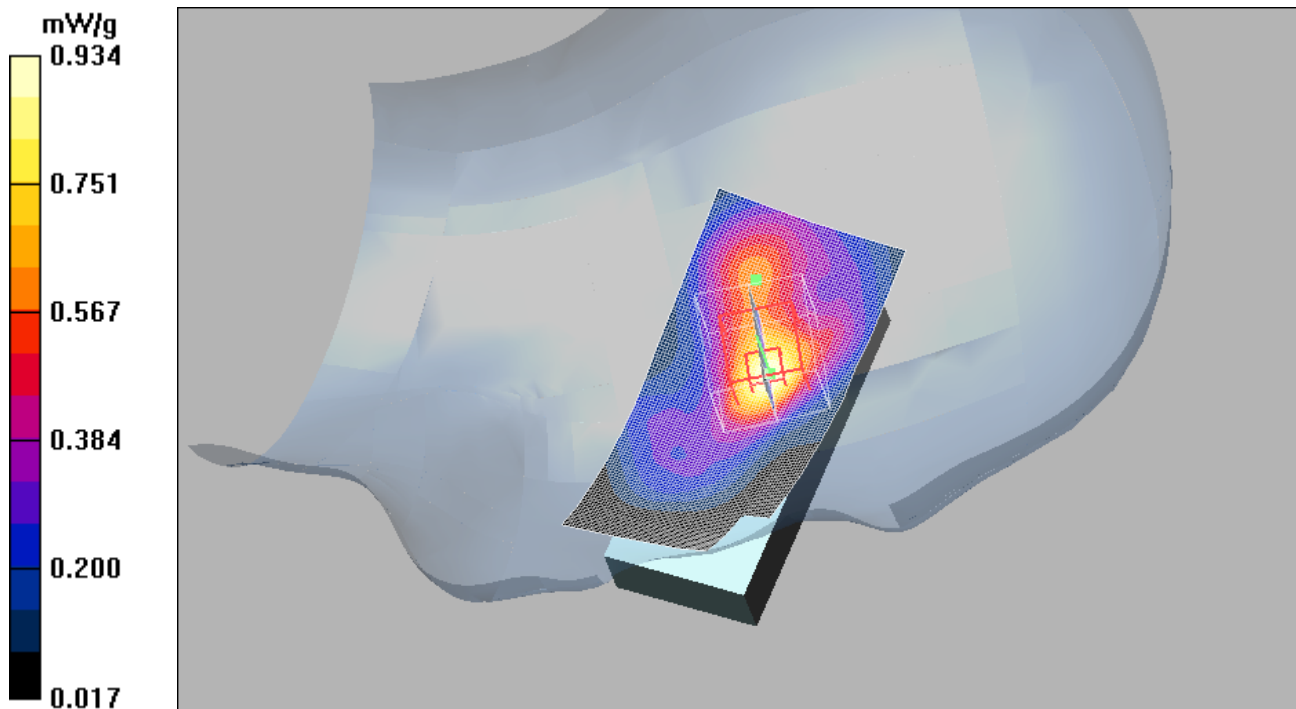

Date/Time: 2006-05-12 12:41:39

Test Laboratory: Sony Ericsson Mobile Communications

File Name: [ch810_Right_Tilt_060512_RP.da4](#)

DUT: PY7AD022031 (K800); Type: GSM900,1800,1900 and UMTS; Serial: #4715
Program Name: SAR Measurement on the Head

Communication System: GSM 1900; Frequency: 1909.8 MHz; Duty Cycle: 1:8.3

Medium parameters used: $f = 1909.8$ MHz; $\sigma = 1.47$ mho/m; $\epsilon_r = 39$; $\rho = 1000$ kg/m³

Phantom section: Right Section

DASY4 Configuration:

- Probe: ET3DV6 - SN1815; ConvF(5.23, 5.23, 5.23); Calibrated: 2006-01-20

- Sensor-Surface: 4mm (Mechanical Surface Detection) Sensor-Surface: 0mm (Fix Surface)

- Electronics: DAE4 SN640; Calibrated: 2006-01-18

- Phantom: SAM 6; Type: SAM; Serial: 1351

- Measurement SW: DASY4, V4.6 Build 23; Postprocessing SW: SEMCAD, V1.8 Build 161

Right, Tilt/Area Scan (61x121x1): Measurement grid: dx=10mm, dy=10mm

Maximum value of SAR (interpolated) = 1.03 mW/g

Right, Tilt/Zoom Scan (5x5x7)/Cube 0: Measurement grid: dx=8mm, dy=8mm, dz=5mm

Reference Value = 19.1 V/m; Power Drift = -0.049 dB

Peak SAR (extrapolated) = 1.56 W/kg

SAR(1 g) = 0.883 mW/g; SAR(10 g) = 0.475 mW/g

Maximum value of SAR (measured) = 0.983 mW/g

Right, Tilt/Z Scan (1x1x16): Measurement grid: dx=20mm, dy=20mm, dz=20mm

Maximum value of SAR (interpolated) = 0.155 mW/g

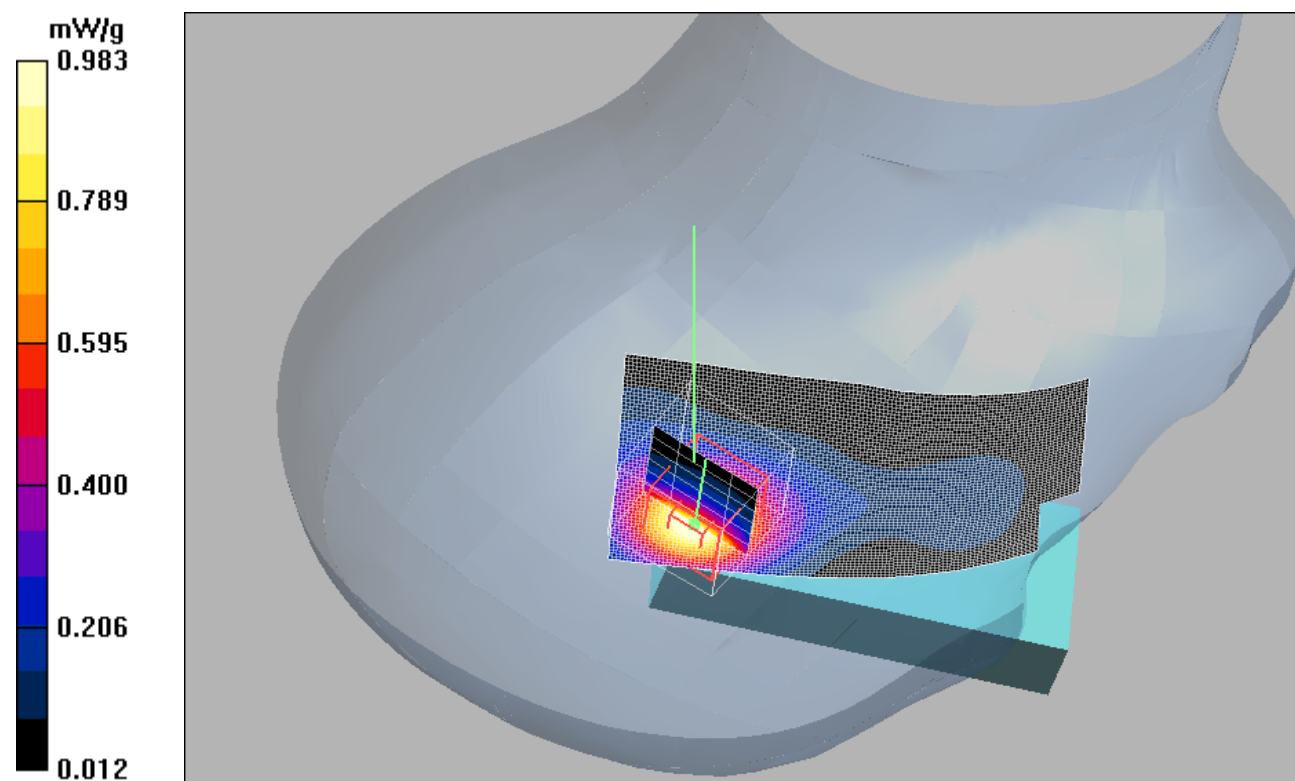

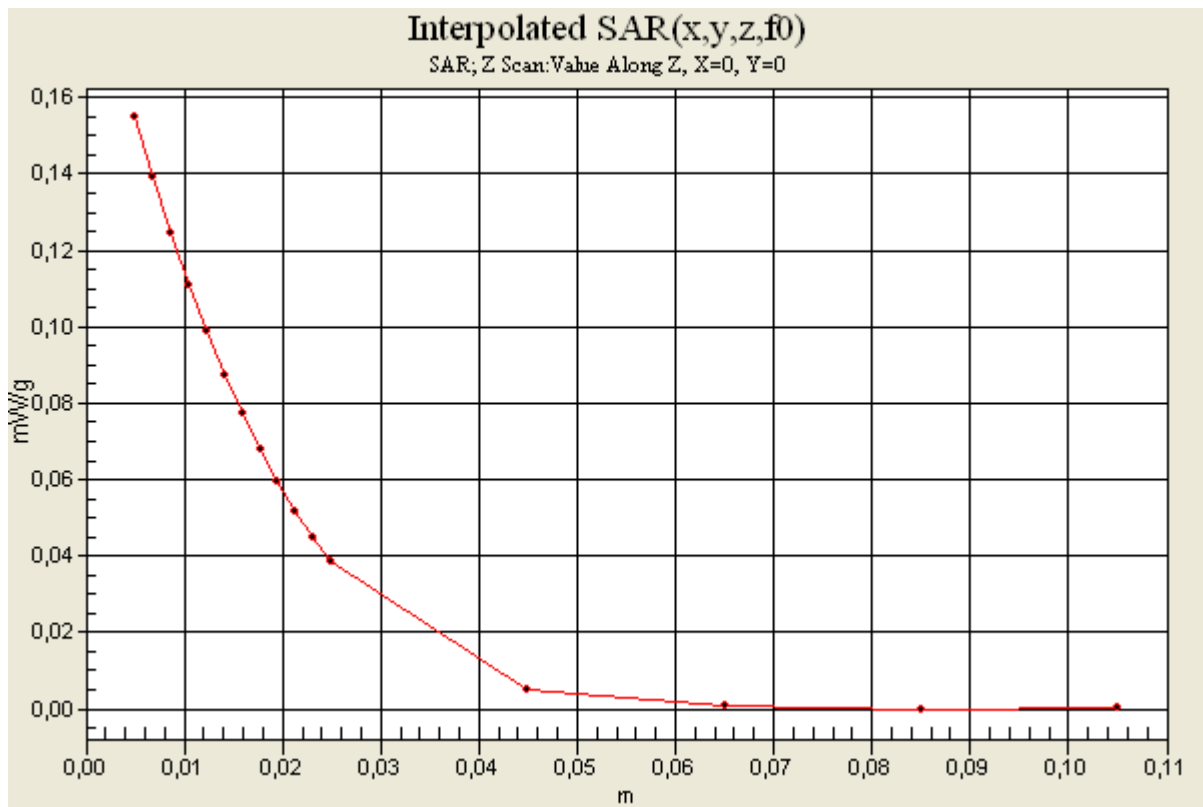

Date/Time: 2006-05-15 13:50:36

Test Laboratory: Sony Ericsson Mobile Communications
 File Name: [ch810_15mm_Speech_BT_060515_RP.da4](#)

DUT: PY7AD022031 (K800); Type: GSM900,1800,1900 and UMTS; Serial: #4715
Program Name: Measurement on the Body

Communication System: GSM 1900; Frequency: 1909.8 MHz; Duty Cycle: 1:8.3
 Medium parameters used: $f = 1909.8$ MHz; $\sigma = 1.54$ mho/m; $\epsilon_r = 50.8$; $\rho = 1000$ kg/m³
 Phantom section: Flat Section

DASY4 Configuration:

- Probe: ET3DV6 - SN1815; ConvF(4.6, 4.6, 4.6); Calibrated: 2006-01-20
- Sensor-Surface: 4mm (Mechanical Surface Detection)
- Electronics: DAE4 SN640; Calibrated: 2006-01-18
- Phantom: SAM 6; Type: SAM; Serial: 1351
- Measurement SW: DASY4, V4.6 Build 23; Postprocessing SW: SEMCAD, V1.8 Build 161

Flat,Speech, PHF,15mm/Area Scan (61x121x1): Measurement grid: dx=10mm, dy=10mm
 Maximum value of SAR (interpolated) = 0.435 mW/g

Flat,Speech, PHF,15mm/Zoom Scan (5x5x7)/Cube 0: Measurement grid: dx=8mm, dy=8mm, dz=5mm

Reference Value = 14.9 V/m; Power Drift = -0.036 dB

Peak SAR (extrapolated) = 0.619 W/kg

SAR(1 g) = 0.401 mW/g; SAR(10 g) = 0.252 mW/g

Maximum value of SAR (measured) = 0.430 mW/g

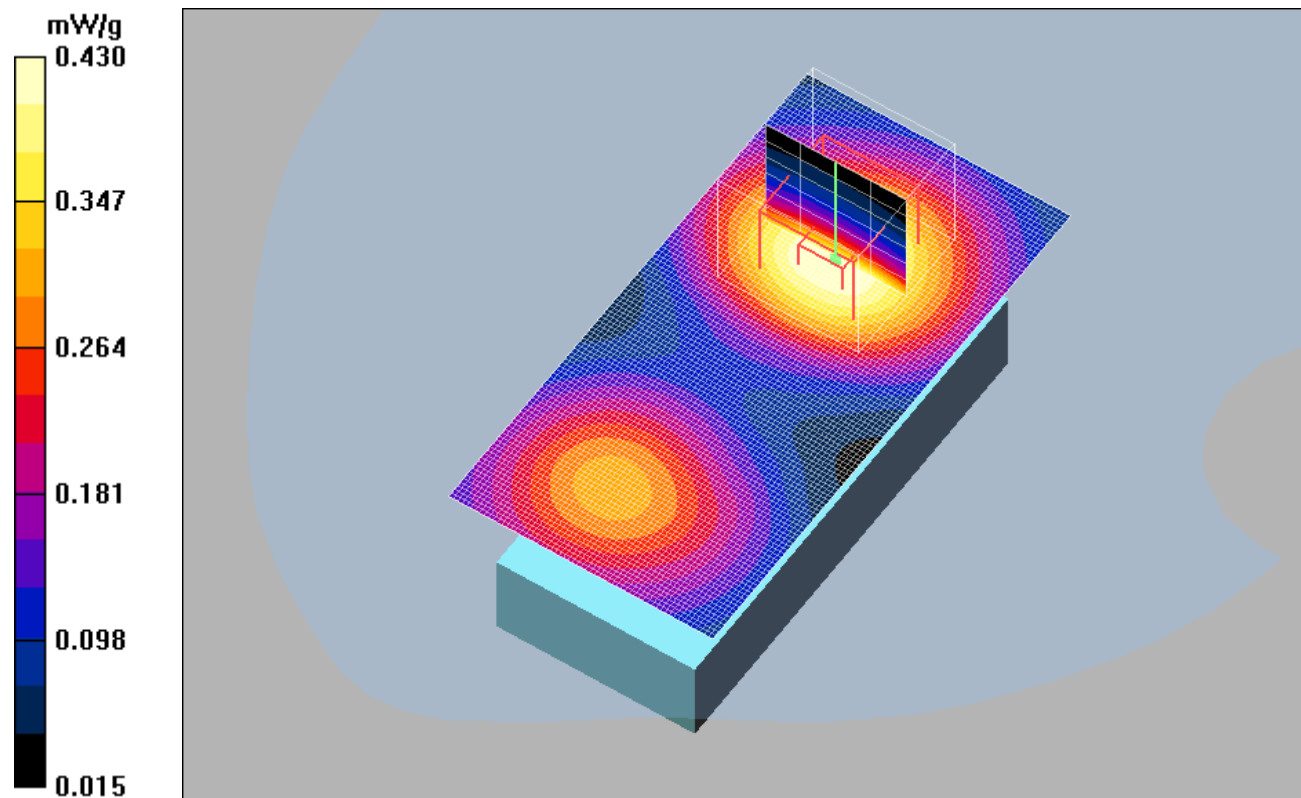

Date/Time: 2006-05-15 12:35:32

Test Laboratory: Sony Ericsson Mobile Communications
 File Name: [ch810_15mm_GPRS2Slot_060515_RP.da4](#)

DUT: PY7AD022031 (K800); Type: GSM900,1800,1900 and UMTS; Serial: #4715
Program Name: Measurement on the Body

Communication System: GSM1900_GPRS; Frequency: 1909.8 MHz; Duty Cycle: 1:4.15
 Medium parameters used: $f = 1909.8$ MHz; $\sigma = 1.54$ mho/m; $\epsilon_r = 50.8$; $\rho = 1000$ kg/m³
 Phantom section: Flat Section

DASY4 Configuration:

- Probe: ET3DV6 - SN1815; ConvF(4.6, 4.6, 4.6); Calibrated: 2006-01-20
- Sensor-Surface: 4mm (Mechanical Surface Detection) Sensor-Surface: 0mm (Fix Surface)
- Electronics: DAE4 SN640; Calibrated: 2006-01-18
- Phantom: SAM 6; Type: SAM; Serial: 1351
- Measurement SW: DASY4, V4.6 Build 23; Postprocessing SW: SEMCAD, V1.8 Build 161

Flat,GPRS2Slots,15mm/Area Scan (61x121x1): Measurement grid: dx=10mm, dy=10mm
 Maximum value of SAR (interpolated) = 0.848 mW/g

Flat,GPRS2Slots,15mm/Zoom Scan (5x5x7)/Cube 0: Measurement grid: dx=8mm, dy=8mm, dz=5mm

Reference Value = 20.7 V/m; Power Drift = -0.066 dB

Peak SAR (extrapolated) = 1.20 W/kg

SAR(1 g) = 0.773 mW/g; SAR(10 g) = 0.486 mW/g

Maximum value of SAR (measured) = 0.822 mW/g

Flat,GPRS2Slots,15mm/Z Scan (1x1x16): Measurement grid: dx=20mm, dy=20mm, dz=20mm

Maximum value of SAR (interpolated) = 0.248 mW/g

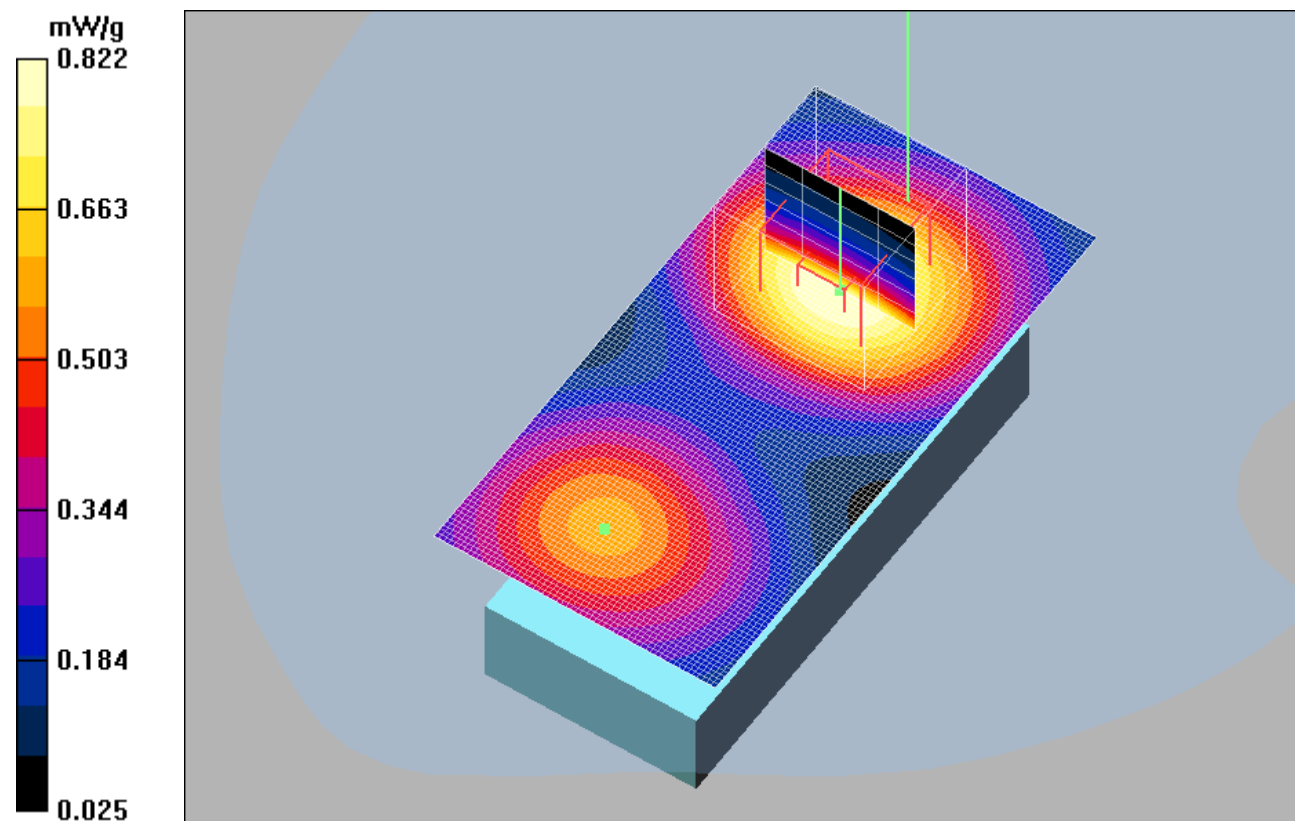

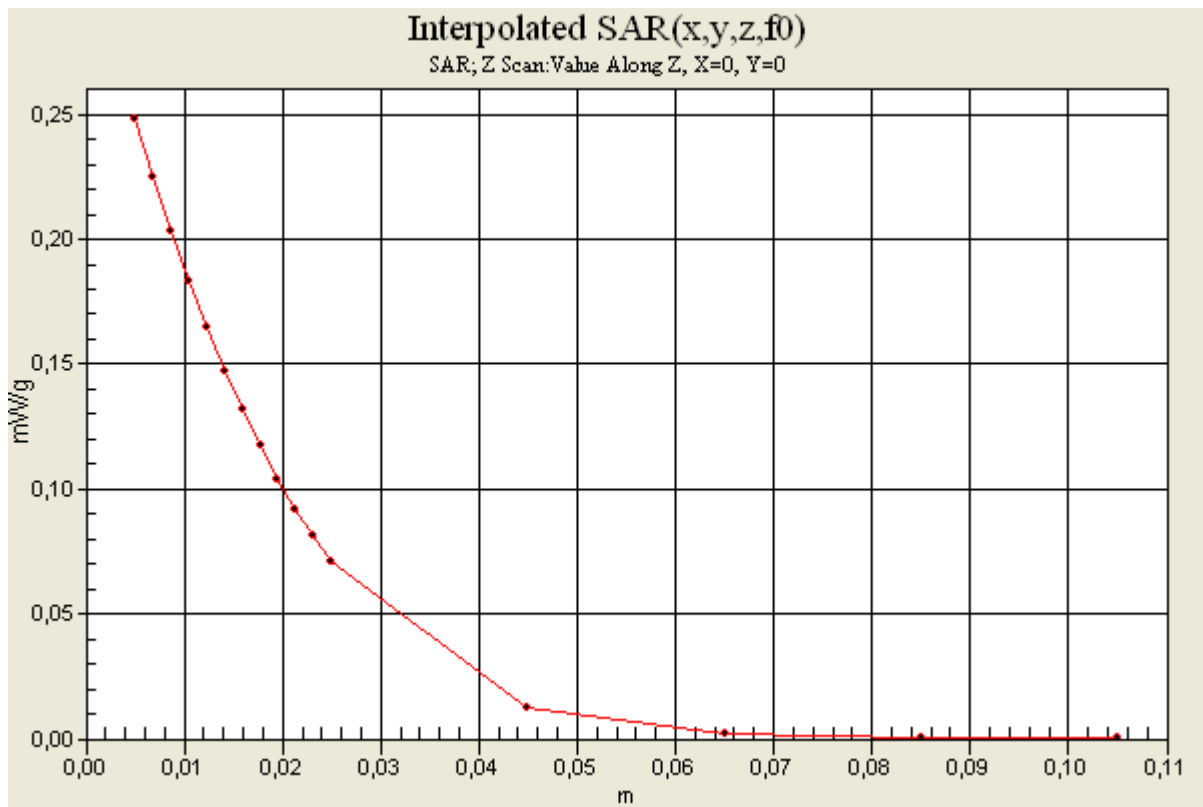

Date/Time: 2006-05-15 13:32:44

Test Laboratory: Sony Ericsson Mobile Communications
 File Name: [ch810_15mm_Speech_PHF_060515_RP.da4](#)

DUT: PY7AD022031 (K800); Type: GSM900,1800,1900 and UMTS; Serial: #4715
Program Name: Measurement on the Body

Communication System: GSM 1900; Frequency: 1909.8 MHz; Duty Cycle: 1:8.3
 Medium parameters used: $f = 1909.8$ MHz; $\sigma = 1.54$ mho/m; $\epsilon_r = 50.8$; $\rho = 1000$ kg/m³
 Phantom section: Flat Section

DASY4 Configuration:

- Probe: ET3DV6 - SN1815; ConvF(4.6, 4.6, 4.6); Calibrated: 2006-01-20
- Sensor-Surface: 4mm (Mechanical Surface Detection)
- Electronics: DAE4 SN640; Calibrated: 2006-01-18
- Phantom: SAM 6; Type: SAM; Serial: 1351
- Measurement SW: DASY4, V4.6 Build 23; Postprocessing SW: SEMCAD, V1.8 Build 161

Flat,Speech, PHF,15mm/Area Scan (61x121x1): Measurement grid: dx=10mm, dy=10mm
 Maximum value of SAR (interpolated) = 0.339 mW/g

Flat,Speech, PHF,15mm/Zoom Scan (5x5x7)/Cube 0: Measurement grid: dx=8mm, dy=8mm, dz=5mm

Reference Value = 13.7 V/m; Power Drift = -0.049 dB

Peak SAR (extrapolated) = 0.481 W/kg

SAR(1 g) = 0.310 mW/g; SAR(10 g) = 0.195 mW/g

Maximum value of SAR (measured) = 0.333 mW/g

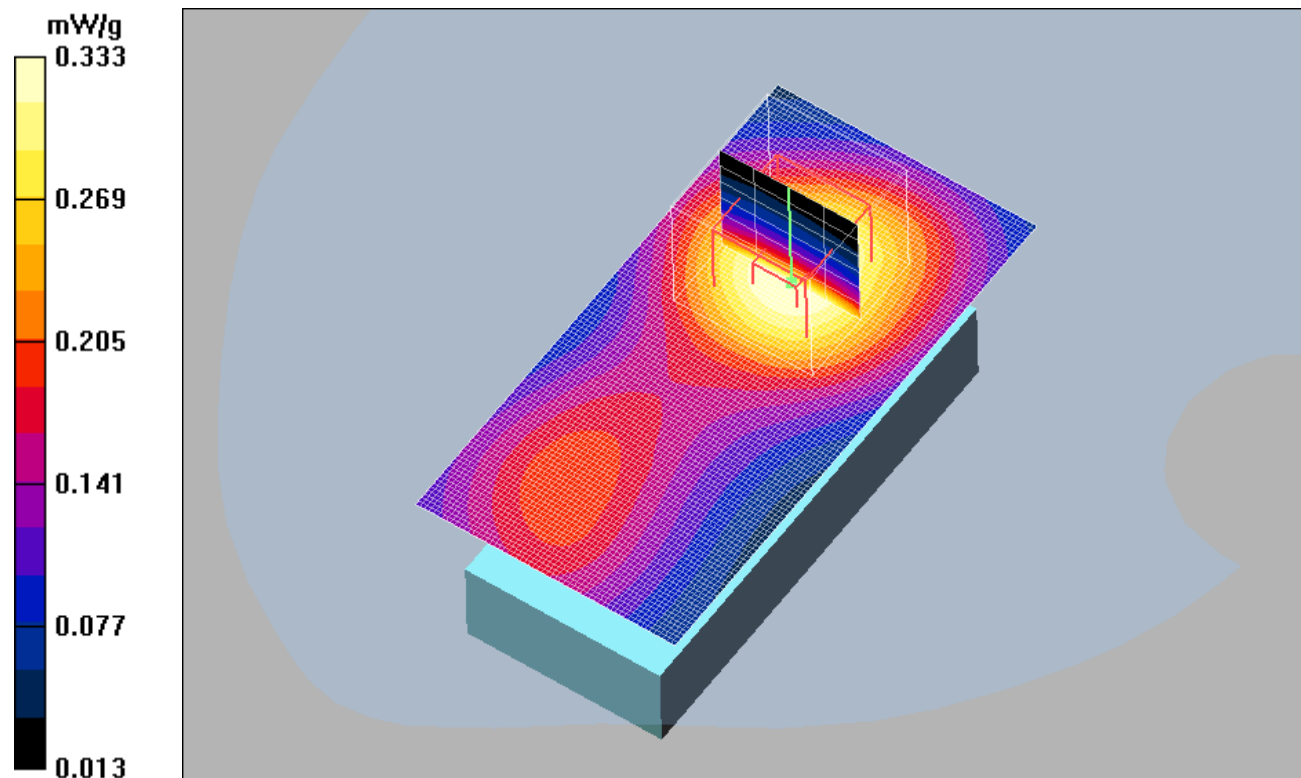



Accredited by the Swiss Federal Office of Metrology and Accreditation
The Swiss Accreditation Service is one of the signatories to the EA
Multilateral Agreement for the recognition of calibration certificates

Accreditation No.: **SCS 108**

Client **Sony Ericsson Lund**

Certificate No. **ET3-1815_Jan06**

CALIBRATION CERTIFICATE

Object **ET3DV6 - SN:1815**

Calibration procedure(s) **QA CAL-01.v5
Calibration procedure for dosimetric E-field probes**

Calibration date: **January 20, 2006**

Condition of the calibrated item **In Tolerance**

This calibration certificate documents the traceability to national standards, which realize the physical units of measurements (SI).
The measurements and the uncertainties with confidence probability are given on the following pages and are part of the certificate.

All calibrations have been conducted in the closed laboratory facility: environment temperature (22 ± 3)°C and humidity < 70%.

Calibration Equipment used (M&TE critical for calibration)

Primary Standards	ID #	Cal Date (Calibrated by, Certificate No.)	Scheduled Calibration
Power meter E4419B	GB41293874	3-May-05 (METAS, No. 251-00466)	May-06
Power sensor E4412A	MY41495277	3-May-05 (METAS, No. 251-00466)	May-06
Power sensor E4412A	MY41498087	3-May-05 (METAS, No. 251-00466)	May-06
Reference 3 dB Attenuator	SN: S5054 (3c)	11-Aug-05 (METAS, No. 251-00499)	Aug-06
Reference 20 dB Attenuator	SN: S5086 (20b)	3-May-05 (METAS, No. 251-00467)	May-06
Reference 30 dB Attenuator	SN: S5129 (30b)	11-Aug-05 (METAS, No. 251-00500)	Aug-06
Reference Probe ES3DV2	SN: 3013	2-Jan-06 (SPEAG, No. ES3-3013_Jan06)	Jan-07
DAE4	SN: 654	27-Oct-05 (SPEAG, No. DAE4-654_Oct05)	Oct-06
Secondary Standards	ID #	Check Date (in house)	Scheduled Check
RF generator HP 8648C	US3642U01700	4-Aug-99 (SPEAG, in house check Nov-05)	In house check: Nov-07
Network Analyzer HP 8753E	US37390585	18-Oct-01 (SPEAG, in house check Nov-05)	In house check: Nov 06

Calibrated by: **Name: Katja Pokovic, Function: Technical Manager, Signature: [Signature]**

Approved by: **Name: Fin Bernholt, Function: R&D Director, Signature: [Signature]**

Issued: January 20, 2006

This calibration certificate shall not be reproduced except in full without written approval of the laboratory.



Accredited by the Swiss Federal Office of Metrology and Accreditation
The Swiss Accreditation Service is one of the signatories to the EA
Multilateral Agreement for the recognition of calibration certificates

Accreditation No.: **SCS 108**

Glossary:

TSL	tissue simulating liquid
NORM _{x,y,z}	sensitivity in free space
ConF	sensitivity in TSL / NORM _{x,y,z}
DCP	diode compression point
Polarization ϕ	ϕ rotation around probe axis
Polarization ϑ	ϑ rotation around an axis that is in the plane normal to probe axis (at measurement center), i.e., $\vartheta = 0$ is normal to probe axis

Calibration is Performed According to the Following Standards:

- IEEE Std 1528-2003, "IEEE Recommended Practice for Determining the Peak Spatial-Averaged Specific Absorption Rate (SAR) in the Human Head from Wireless Communications Devices: Measurement Techniques", December 2003
- CENELEC EN 50361, "Basic standard for the measurement of Specific Absorption Rate related to human exposure to electromagnetic fields from mobile phones (300 MHz - 3 GHz), July 2001

Methods Applied and Interpretation of Parameters:

- NORM_{x,y,z}**: Assessed for E-field polarization $\vartheta = 0$ ($f \leq 900$ MHz in TEM-cell; $f > 1800$ MHz: R22 waveguide). NORM_{x,y,z} are only intermediate values, i.e., the uncertainties of NORM_{x,y,z} does not effect the E²-field uncertainty inside TSL (see below *ConvF*).
- NORM(f)_{x,y,z}** = NORM_{x,y,z} * *frequency_response* (see Frequency Response Chart). This linearization is implemented in DASY4 software versions later than 4.2. The uncertainty of the frequency response is included in the stated uncertainty of *ConvF*.
- DCP_{x,y,z}**: DCP are numerical linearization parameters assessed based on the data of power sweep (no uncertainty required). DCP does not depend on frequency nor media.
- ConvF and Boundary Effect Parameters**: Assessed in flat phantom using E-field (or Temperature Transfer Standard for $f \leq 800$ MHz) and inside waveguide using analytical field distributions based on power measurements for $f > 800$ MHz. The same setups are used for assessment of the parameters applied for boundary compensation (alpha, depth) of which typical uncertainty values are given. These parameters are used in DASY4 software to improve probe accuracy close to the boundary. The sensitivity in TSL corresponds to NORM_{x,y,z} * *ConvF* whereby the uncertainty corresponds to that given for *ConvF*. A frequency dependent *ConvF* is used in DASY version 4.4 and higher which allows extending the validity from ± 50 MHz to ± 100 MHz.
- Spherical isotropy (3D deviation from isotropy)**: in a field of low gradients realized using a flat phantom exposed by a patch antenna.
- Sensor Offset**: The sensor offset corresponds to the offset of virtual measurement center from the probe tip (on probe axis). No tolerance required.

Probe ET3DV6

SN:1815

Manufactured:	February 27, 2004
Last calibrated:	January 20, 2005
Recalibrated:	January 20, 2006

Calibrated for DASYS Systems

(Note: non-compatible with DASYS2 system!)

DASY - Parameters of Probe: ET3DV6 SN:1815

Sensitivity in Free Space^A

NormX	1.95 ± 10.1%	$\mu\text{V}/(\text{V}/\text{m})^2$
NormY	2.02 ± 10.1%	$\mu\text{V}/(\text{V}/\text{m})^2$
NormZ	2.04 ± 10.1%	$\mu\text{V}/(\text{V}/\text{m})^2$

Diode Compression^B

DCP X	93 mV
DCP Y	93 mV
DCP Z	93 mV

Sensitivity in Tissue Simulating Liquid (Conversion Factors)

Please see Page 8.

Boundary Effect

TSL **900 MHz** **Typical SAR gradient: 5 % per mm**

Sensor Center to Phantom Surface Distance		3.7 mm	4.7 mm
SAR _{be} [%]	Without Correction Algorithm	7.7	4.3
SAR _{be} [%]	With Correction Algorithm	0.0	0.2

TSL **1750 MHz** **Typical SAR gradient: 10 % per mm**

Sensor Center to Phantom Surface Distance		3.7 mm	4.7 mm
SAR _{be} [%]	Without Correction Algorithm	6.8	3.9
SAR _{be} [%]	With Correction Algorithm	0.1	0.3

Sensor Offset

Probe Tip to Sensor Center	2.7 mm
Optical Surface Detection	low, but repeatable

The reported uncertainty of measurement is stated as the standard uncertainty of measurement multiplied by the coverage factor k=2, which for a normal distribution corresponds to a coverage probability of approximately 95%.

^A The uncertainties of NormX,Y,Z do not affect the E²-field uncertainty inside TSL (see Page 8).

^B Numerical linearization parameter: uncertainty not required.

Frequency Response of E-Field

(TEM-Cell:ifi110 EXX, Waveguide: R22)

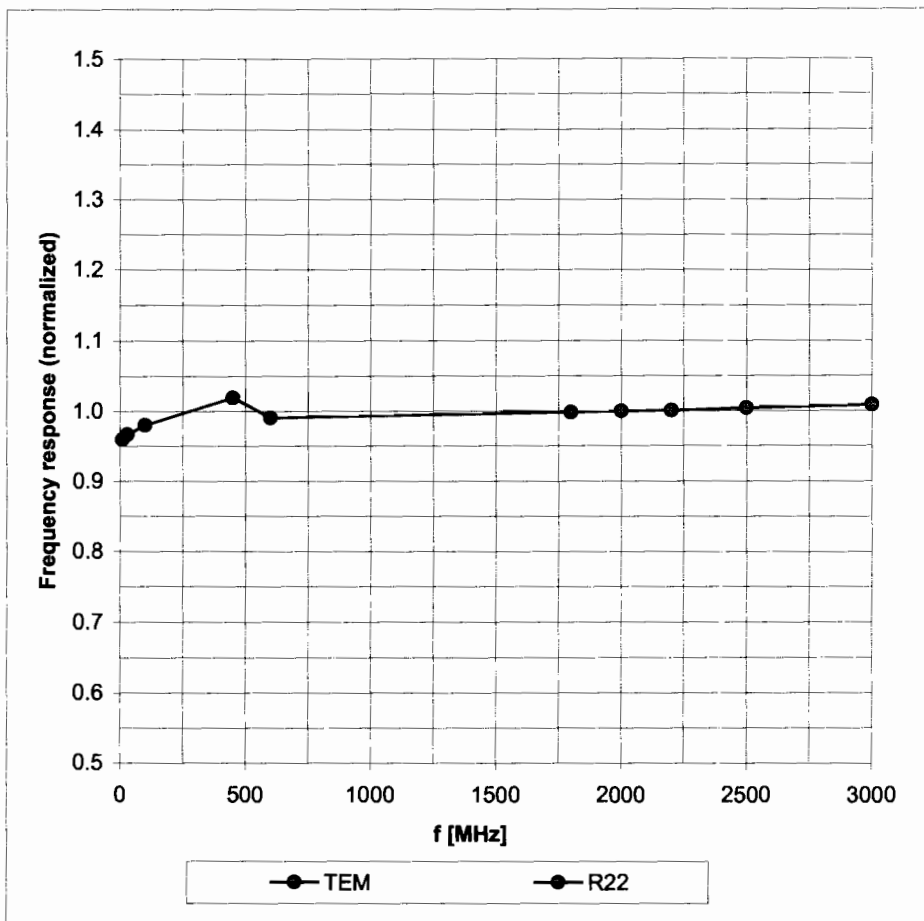

Uncertainty of Frequency Response of E-field: $\pm 6.3\%$ ($k=2$)

Receiving Pattern (ϕ), $\vartheta = 0^\circ$

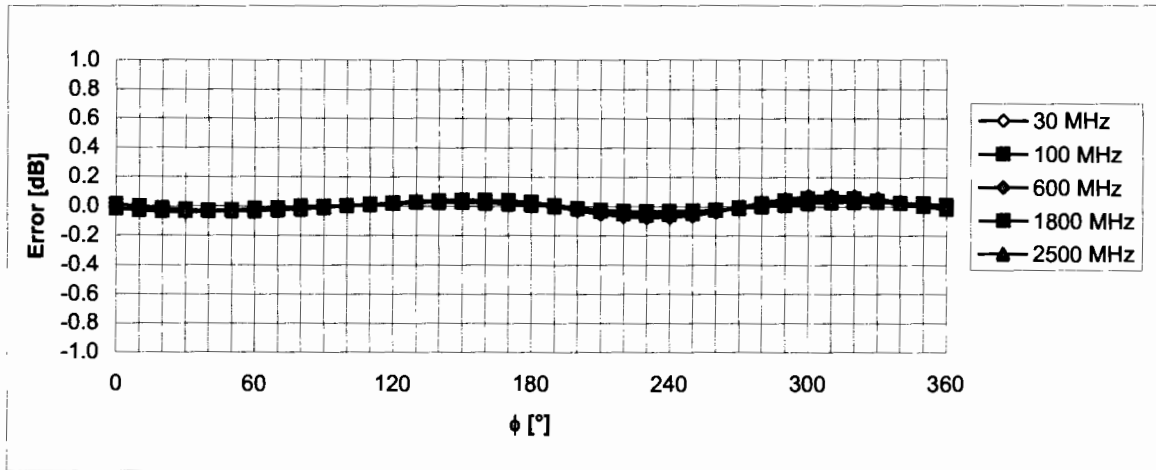
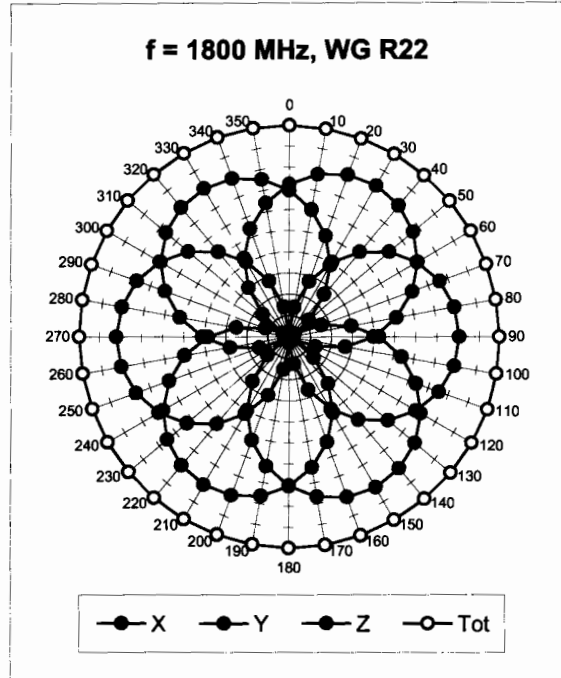
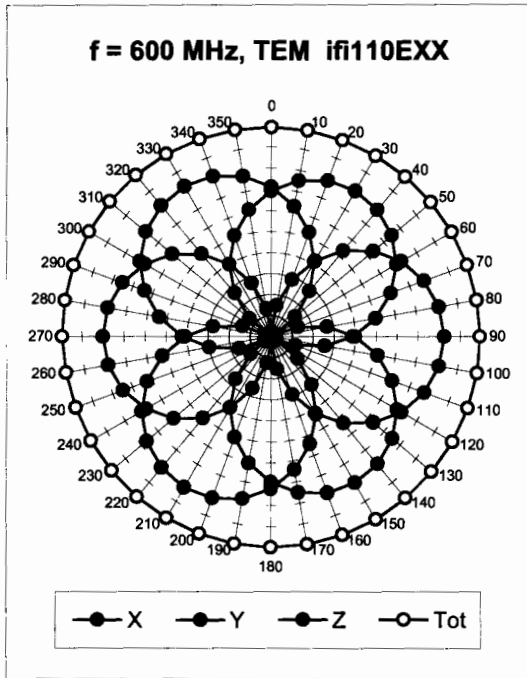

Uncertainty of Axial Isotropy Assessment: $\pm 0.5\%$ (k=2)

Dynamic Range $f(SAR_{head})$ (Waveguide R22, $f = 1800$ MHz)

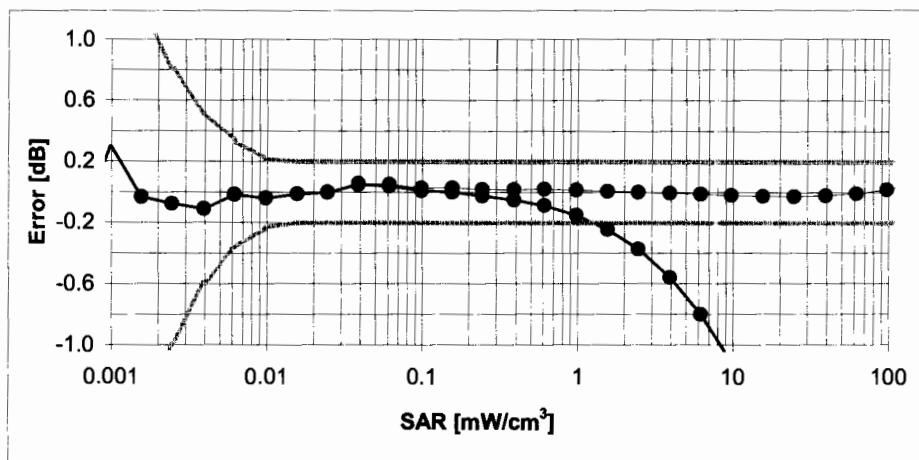
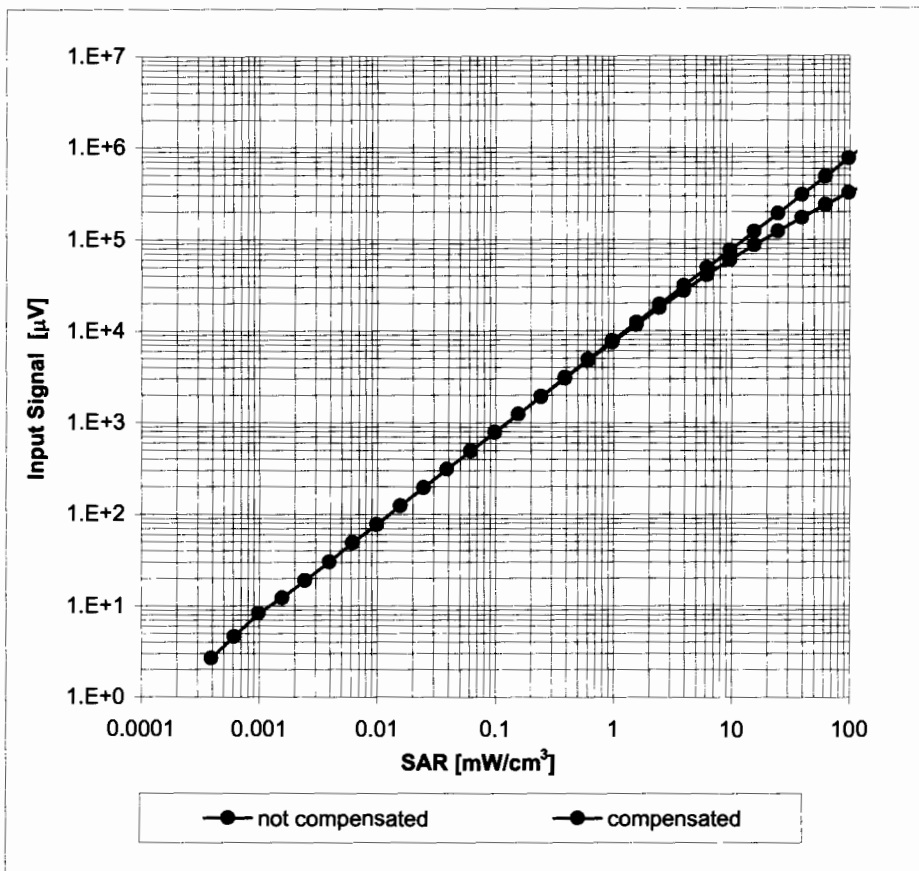

Uncertainty of Linearity Assessment: $\pm 0.6\%$ ($k=2$)

Conversion Factor Assessment

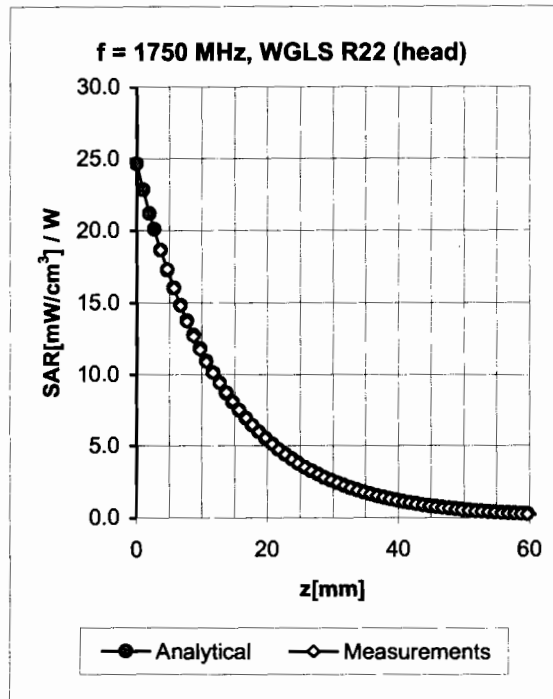
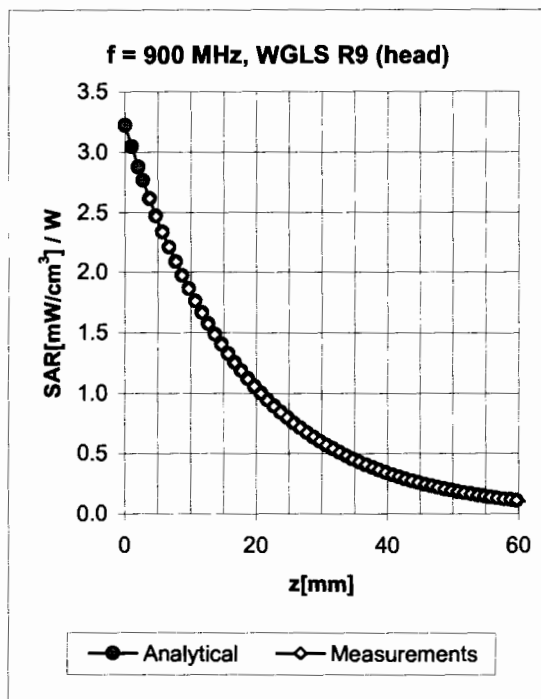

f [MHz]	Validity [MHz] ^c	TSL	Permittivity	Conductivity	Alpha	Depth	ConvF Uncertainty
835	± 50 / ± 100	Head	41.5 ± 5%	0.90 ± 5%	0.54	1.76	6.82 ± 11.0% (k=2)
900	± 50 / ± 100	Head	41.5 ± 5%	0.97 ± 5%	0.48	1.93	6.66 ± 11.0% (k=2)
1750	± 50 / ± 100	Head	40.1 ± 5%	1.37 ± 5%	0.54	1.72	5.40 ± 11.0% (k=2)
1900	± 50 / ± 100	Head	40.0 ± 5%	1.40 ± 5%	0.60	1.66	5.23 ± 11.0% (k=2)
2450	± 50 / ± 100	Head	39.2 ± 5%	1.80 ± 5%	0.60	1.42	4.57 ± 11.8% (k=2)
835	± 50 / ± 100	Body	55.2 ± 5%	0.97 ± 5%	0.42	2.10	6.51 ± 11.0% (k=2)
900	± 50 / ± 100	Body	55.0 ± 5%	1.05 ± 5%	0.41	2.19	6.36 ± 11.0% (k=2)
1750	± 50 / ± 100	Body	53.4 ± 5%	1.49 ± 5%	0.65	1.97	4.85 ± 11.0% (k=2)
1900	± 50 / ± 100	Body	53.3 ± 5%	1.52 ± 5%	0.62	2.14	4.60 ± 11.0% (k=2)
2450	± 50 / ± 100	Body	52.7 ± 5%	1.95 ± 5%	0.40	2.06	4.20 ± 11.8% (k=2)

^c The validity of ± 100 MHz only applies for DASY v4.4 and higher (see Page 2). The uncertainty is the RSS of the ConvF uncertainty at calibration frequency and the uncertainty for the indicated frequency band.

Deviation from Isotropy in HSL

Error (ϕ, ϑ), $f = 900$ MHz

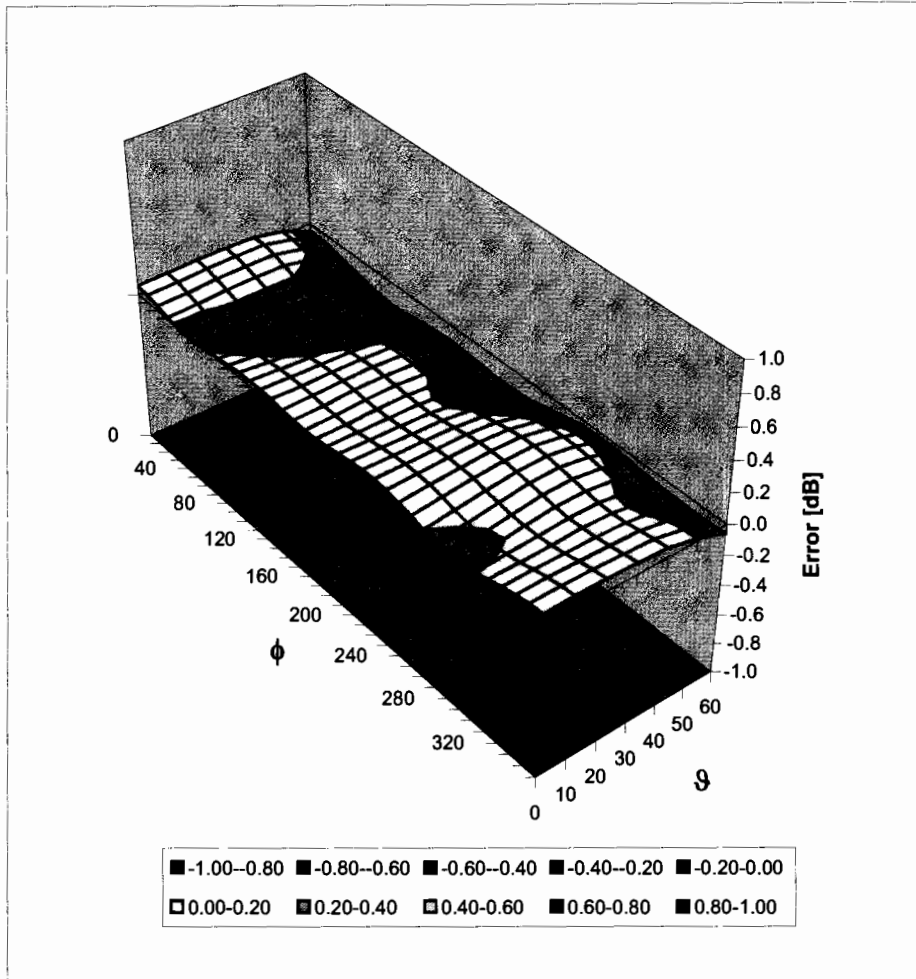

Uncertainty of Spherical Isotropy Assessment: $\pm 2.6\%$ ($k=2$)



Prepared (also subject responsible if other)

LD/SEMC/BGUG/NM Ramadan Plicanic

Approved

LD/SEMC/BGUG/NMC Mats Hansson

Checked

No.

GUG/N 03:141

Date

060220

Rev

E

Reference

File

Sony Ericsson SAR Measurement Specification of Wireless Terminals

Contents

1	Introduction and scope	2
2	References	2
3	Physical quantities, units and constants.....	4
4	Definitions	4
5	Measurement system specifications	4
5.1	General	4
5.2	Phantom.....	5
5.3	SAR measurement equipment	5
5.4	Scanning system	6
5.5	Wireless device holder	6
5.6	Other equipment	6
6	Protocol for SAR assessment	7
6.1	Measurement preparation	7
6.2	Tests to be performed	7
6.3	Measurement procedure	7
6.4	Post processing	8
7	Measurement uncertainty	9
Annex A	Tissue simulating material preparation	9
Annex B	Dielectric property measurements	12
Annex C	SAR measurement procedure	13
Annex D	Measurement system performance check and validation	15
Annex E	Uncertainty budgets for 1g and 10g SAR assessments with DASYS	17

Prepared (also subject responsible if other)

LD/SEMC/BGUG/NM Ramadan Plicanic

Approved

LD/SEMC/BGUG/NMC Mats Hansson

Checked

Company Internal
INSTRUCTION

No.

GUG/N 03:141

Date

060220

Rev

E

Reference

File

1. Introduction and scope

It is a Sony Ericsson policy that all RF transmitting product models shall comply with relevant recommendations, standards and regulations on human exposure to electromagnetic fields. In the reference section below, the most important RF safety guidelines are listed [9-13]. If no national standard or regulation is available in a country, the international recommendation from ICNIRP [9] shall be applied.

The RF safety guidelines specify *basic restrictions* and *reference levels*. In the frequency range of interest for mobile communications, the basic restrictions are expressed as Specific Absorption Rate (SAR) limits and the reference levels as field strength or power density limits. The reference levels are provided for the purpose of simple measurements of compliance with the basic restrictions, and they are primarily applicable in the far-field region of a RF source. Measured values greater than the reference levels do not necessarily mean that the basic restrictions are exceeded.

In the near-field region of mobile communication devices (handsets), field strength values exceeding the reference levels may be observed. Compliance with the basic SAR restrictions has therefore to be verified. SAR (W/kg) is a measure of the rate of RF energy absorption in tissue. The localized SAR limits depend on whether the device is classified for use by the general public (uncontrolled environment) or workers (controlled environment). Mobile communication equipment are usually used by the general public and should consequently be in compliance with the general public limits, which are 2.0 W/kg averaged in 10 gram of tissue in the ICNIRP guidelines [9] and 1.6 W/kg averaged in 1 gram in the ANSI/IEEE standard [10]. Because of the lower limit and the smaller averaging mass, the ANSI/IEEE limit is slightly more conservative than the ICNIRP limit. The averaging times are also different, 6 minutes in the ICNIRP recommendations and 30 minutes in the IEEE guidelines.

This document describes the SAR measurement procedures used by the SAR testing laboratories of Sony Ericsson. SAR measurement standardization is currently evolving. Many standards and guidelines have recently been released [1, 2 and 5] or are in progress (e.g. [3, 4]). Sony Ericsson is firmly committed to using the latest technology and the latest standards to ensure that the SAR measurements are of the highest quality.

2. References

SAR measurement standards and guidelines

The following standards and guidelines are used as a basis for the SAR measurement specification described herein. Although these documents are well harmonized, some differences exist. References [1] and [2] are approved European standards, [5] is IEEE standard, [3] and [4] draft measurement standards and references [6] are published guidelines. This measurement specification closely conforms to these documents.

- [1] European Standard EN 50360, "Product standard to demonstrate the compliance of mobile phones with the basic restrictions related to human exposure to electromagnetic fields (300 MHz – 3 GHz)", CENELEC, July 2001.
- [2] European Standard EN 50361, "Basic standard for the measurement of Specific Absorption Rate related to human exposure to electromagnetic fields from mobile phones (300 MHz – 3 GHz)", CENELEC, July 2001.
- [3] IEC 62209_Part1 (CD), "Procedure to determine the Specific Absorption Rate (SAR) for hand-held mobile wireless devices in the frequency range of 300 MHz to 3 GHz", IEC, February 2005
- [4] IEC 62209 Part 2, "Evaluation of Human Exposure to Radio Frequency Fields from Handheld and Body-Mounted Wireless Communication Devices in the Frequency Range of 30 MHz to 6 GHz: Human models, Instrumentation, and Procedures, Part 2: Procedure to measure the Specific Absorption Rate (SAR) for two-way radios, palmtop terminals, laptop terminals, desktop terminals, and body-mounted devices including accessories and multiple transmitters", Draft Version 0.6, October 2002
- [5] Standard 1528-2003, "Recommended Practice for Determining the Peak Spatial-Average Specific Absorption Rate (SAR) in the Human Body Due to Wireless Communications Devices: Experimental Techniques", IEEE, June, 2003,
- [6] Supplement C (Edition 01-01) to OET Bulletin 65 (Edition 97-01), "Evaluating Compliance with FCC Guidelines for Human Exposure to Radiofrequency Electromagnetic Fields: Additional Information for Evaluating Compliance of Mobile and Portable Devices with FCC Limits for Human Exposure to Radiofrequency Emissions", FCC, June 2001.

Company Internal
INSTRUCTION

Prepared (also subject responsible if other)

LD/SEMC/BGUG/NM Ramadan Plicanic

Approved

LD/SEMC/BGUG/NMC Mats Hansson

Checked

No.

GUG/N 03:141

Date

060220

Rev

E

Reference

File

- [7] Radiocommunications (Electromagnetic Radiation Human Exposure) Standard 2003, Australian Communications Authority (ACA), February 2003.
- [8] ARIB Standard STD-T56, "Method of Measuring the Specific Absorption Rate from Portable Wireless Terminals", 2nd Edition, Association of Radio Industries and Businesses, January 24th, 2002. (Translation by Asia Technical Translation Pty Ltd 10/04/02).

Other references

- [9] ICNIRP, "Guidelines for limiting exposure to time-varying electric, magnetic, and electromagnetic fields (up to 300 GHz)", International Commission on Non-Ionizing Radiation Protection (ICNIRP), Health Physics, vol. 74, pp 494-522, April 1998.
- [10] ANSI/IEEE C95.1-1992, "Safety levels with respect to human exposure to radio frequency electromagnetic fields, 3 kHz to 300 GHz", The Institute of Electrical and Electronics Engineers Inc., New York, 1992.
- [11] CENELEC ENV 50166-2, "Human exposure to electromagnetic fields: High-frequency (10 kHz – 300 GHz)", European Prestandard, European Committee for Electrotechnical Standardization (CENELEC), January 1995.
- [12] MPT, "Radio-radiation protection guidelines for human exposure to electromagnetic fields", Telecommunications Technology Council, Ministry of Posts and Telecommunications, Japan, April 1997.
- [13] AS/NZS 2772.1(Int):1998, Interim Australian/New Zealand Standard, "Radiofrequency fields, Part 1: Maximum exposure levels – 3 kHz to 300 GHz", Standards Australia/Standards New Zealand, 1998.
- [14] FCC Report and Order, ET Docket 93-62, FCC 96-326, Federal Communications Commission (FCC), August 1996.
- [15] Safety code 6, Canadian Standard, Health Canada, 1999.
- [16] Thomas Schmid, Oliver Egger, Niels Kuster, "Automated E-field scanning system for dosimetric assessments", *IEEE Transactions on Microwave Theory and Techniques*, vol. 44, pp. 105-113, January 1996.
- [17] Schmid & Partner Engineering AG, "DASY3 User Manual", August 1999 Edition, Zurich, Switzerland.
- [18] Klaus Meier, Michael Burkhardt, Thomas Schmid and Niels Kuster, "Broadband calibration of E-field probes in lossy media", *IEEE transactions on Microwave Theory and Techniques*, vol. 44, no. 10, pp. 1954-1962, October 1996.
- [19] K. Pokovic, T Schmid and N. Kuster, "E-field Probe with Improved Isotropy in Brain Simulating Liquids", *Proceedings ELMAR*, Zadar, Croatia, June 23-25, 1996.
- [20] NIS 81, "The treatment of uncertainty in EMC measurements", Technical Report, NAMAS Executive, National Physical Laboratory, Teddington, Middlesex, England, Edition 1, May 1994.
- [21] Barry N. Taylor and Christ E. Kuyatt, "Guidelines for evaluating and expressing the uncertainty of NIST measurement results", NIST Technical Report 1297, National Institute of Standards and Technology, September 1994.
- [22] T. Schmid and N. Kuster, "Preliminary uncertainty budget for SAR evaluations with DASY3," contribution to IEEE Standards Coordinating Committee 34, Subcommittee 2, July, 1998.
- [23] ISO/IEC Guide Expres (1995-01),"Guide to the expression of uncertainty in measurement (1995)", Ed. 1.0 English, 1995.
- [24] HP 8752C Network analyzer User's guide. Hewlett Packard part number 08752-90157.
- [25] HP 85070D Dielectric probe kit manual, Hewlett Packard part number 85070-90009.
- [26] M. Siegbahn, "A SAR test procedure for wireless devices with simultaneous multi-band transmission", EAB/TF-02:118, Rev. A, November 19, 2002

Prepared (also subject responsible if other)

LD/SEMC/BGUG/NM Ramadan Plicanic

Approved

LD/SEMC/BGUG/NMC Mats Hansson

Checked

No.

GUG/N 03:141

Date

060220

Rev

E

Reference

File

3. Physical quantities, units and constants

The physical quantities, units and constants given in section 3 of [2] and section 4 of [3] are applicable for this procedure document.

4. Definitions

The definitions given in section 4 of [2], section 3 of [3] and section 2 of [4] apply.

5. Measurement system specifications

Requirements and recommendations are listed in section 5 of [2] and [3] and in sections 3, 4 of 5 of [4].

5.1 General

Requirements and recommendations are listed in section 5.1 of [2] and [3] and in section 5.6.1.1 of [4].

Tests are performed using a miniature electric field probe that is positioned by a robot whose movements are software controlled. The probes are positioned to measure the internal electric field of a liquid-filled phantom representing the human head while the phantom is exposed to electromagnetic energy from a wireless device. The software processes the electric field data to determine the SAR distribution and the highest mass-averaged SAR.

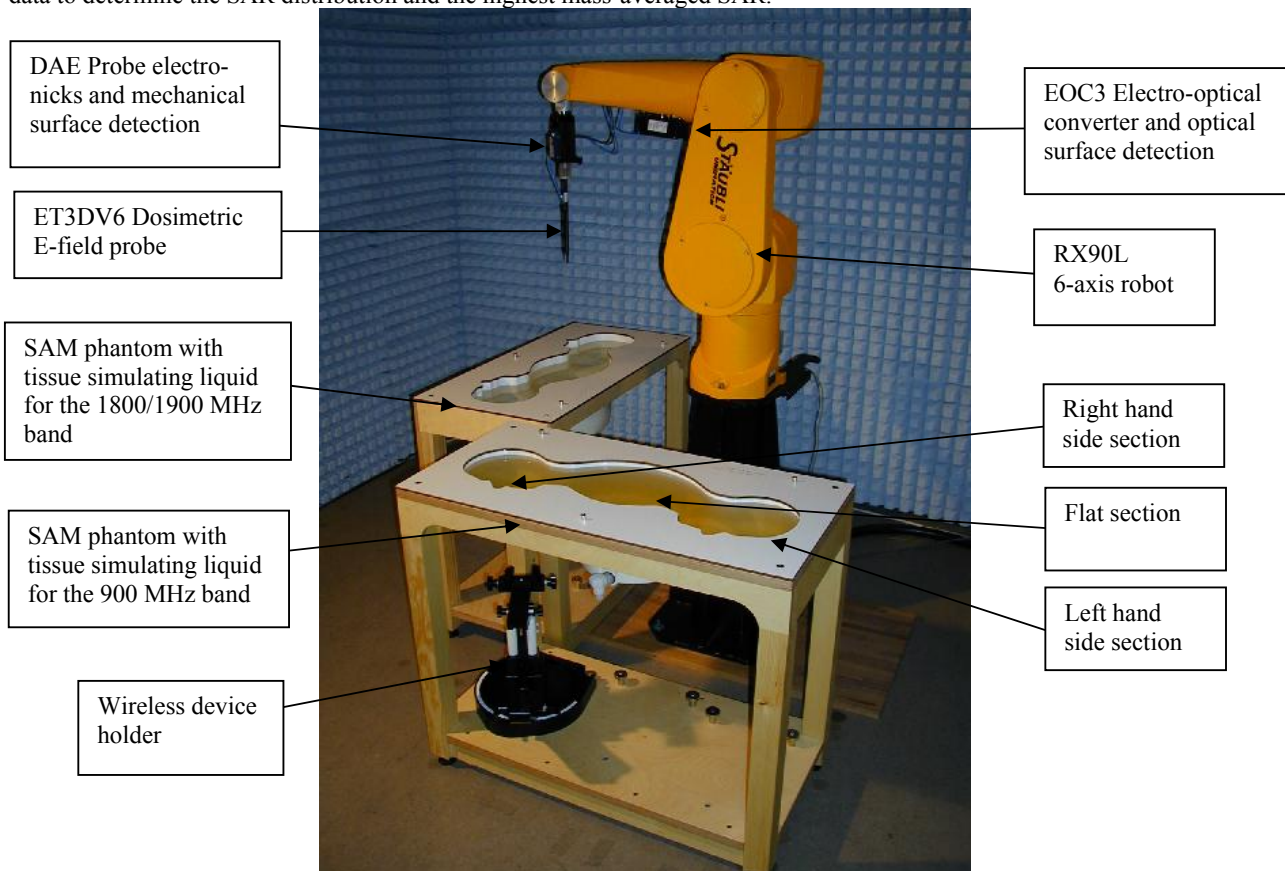

Figure 5.1 SAR measurement system

Prepared (also subject responsible if other)

LD/SEMC/BGUG/NM Ramadan Plicanic

Approved

LD/SEMC/BGUG/NMC Mats Hansson

Checked

Company Internal
INSTRUCTION

No.

GUG/N 03:141

Date

060220

Rev

E

Reference

File

The SAR measurement system used in the Sony Ericsson SAR testing laboratories is the DASY near-field scanner manufactured by Schmid & Partner Engineering AG (SPEAG). The system is based on the E-field probe technique and includes a high precision 6-axis robot, liquid-filled plastic phantoms and miniature electric field probes [16, 17]. The specifications of the system are further described below. Figure 5.1 is a picture of the SAR measurement system.

The Ericsson SAR testing laboratories conform to the following environmental conditions:

- Measurements are conducted in a metal screen room, which is designed to provide shielding from external radiofrequency signals and to prevent devices under test from interfering with local wireless networks.
- The ambient temperature is kept in the range 20 – 25°C (this simultaneously satisfies several recommendations and requirements [2-5], which are 15 – 30°C, 18 – 25°C and 20 – 26°C, respectively).
- The relative humidity of the laboratory is kept within 30 – 70% [5].
- During measurements, the temperature of the liquid is kept within ± 2 °C of the temperature at which the dielectric parameters were measured [2-4].
- The ambient noise level is kept low so that the 1-gram averaged SAR is below 12 mW/kg when the device under test (DUT) is turned off (this simultaneously satisfies the requirements of [2] and [4]).

5.2 Phantom

Phantom requirements and specifications are provided in section 5.2 of [2] and [3] and in section 4 of [4 and 5].

The phantom used is an implementation of the Specific Anthropomorphic Mannequin (SAM) model [2-5]. It consists of three measurement areas or sections, one section corresponding to right hand side use and an identical but mirrored section for the left-hand side. In the middle of the phantom there is a flat section for tests of mobile phones when worn on the body. The flat section is also used for system validation.

The phantom shell was manufactured by SPEAG to meet stringent shape, thickness and material requirements [2-5]. The length and width of the flat section are at least $0.75 \lambda_0$ and $0.6 \lambda_0$ respectively at frequencies of 824 MHz and above (λ_0 = wavelength in air).

The phantom is filled with a tissue simulating liquid to a depth of at least 15 cm at each ear reference point [2-5]. The dielectric properties of the liquid conform to all the tabulated values [2-5]. Liquids are prepared according to Annex A and dielectric properties are measured according to Annex B.

5.3 SAR measurement equipment

Measurement equipment requirements and specifications are provided in section 5.3 of [2] and [3] and in section 3 of [4 and 5].

The Dosimetric Assessment System (DASY) Professional by Schmid & Partner Engineering AG consists of the dosimetric probe ET3DV6 connected to the readout electronics DAE3 which is attached to the tool joint of a Stäubli RX90L 6-axis high precision robot. The measurement signal is transferred via a fiber optical link from the DAE3 to the electro-optical converter EOC3 that is connected to the ISA type PC card in the system computer.

The dosimetric probe is sensitive to E-fields and incorporates three dipoles arranged so that the overall response is close to isotropic [14, 15]. The probe sensors are covered by an outer protective shell made of plastic, which is resistant to organic solvents i.e. glycol. In the center line of the probe an optical fiber for surface detection is located. The table below summarizes the technical data of this probe. The E-fields probes have been calibrated once per year and after calibration Technical Lead Engineer or Technical Engineer are responsible to change correction factor in DASY system software for each probes. Other probe parameters are provided in the uncertainty budget in Section 7.

The DAE probe electronics incorporates one measurement amplifier for each sensor dipole and a mechanical surface detection system that automatically stops the robot in a probe collision emergency. The fiber optical surface detection system is located

Prepared (also subject responsible if other)

LD/SEMC/BGUG/NM Ramadan Plicanic

Approved

LD/SEMC/BGUG/NMC Mats Hansson

Checked

Company Internal

INSTRUCTION

No.

GUG/N 03:141

Date

060220

Rev

E

Reference

File

in the EOC. Either the mechanical or the optical surface detection system is used for controlling the distance between the probe and the inner surface of the phantom shell.

Property	Data
Frequency range	30 MHz – 3 GHz
Linearity	± 0.2 dB
Dynamic Range	5 µW/kg - >100 W/kg
Tip diameter (including protective cover)	6.8 mm
Distance from probe tip to sensors	2.7 mm
Length of sensor dipoles	3 mm
Optical surface detection repeatability	± 0.2 mm

Table 5.1 The technical data for the SAR probe ET3DV6.

Property	Data
Frequency range	10 MHz – 6 GHz
Linearity	± 0.2 dB
Dynamic Range	5 µW/kg - >100 W/kg
Tip diameter (including protective cover)	4 mm
Distance from probe tip to sensors	2 mm
Length of sensor dipoles	2 mm
Optical surface detection repeatability	± 0.2 mm

Table 5.2 The technical data for the SAR probe ES3DV3

The data acquisition electronic have been calibrated once per year and after calibration Technical Lead Engineer or Technical Engineer are responsible to change correction factor in DASY system software for each DAE.. System performance check is conducted for the complete system for each relevant tissue equivalent liquid at the appropriate frequency.

5.4 Scanning system

Requirements and recommendations are listed in section 5.4 of [2] and [3] and in section 5.5 of [4 and 5].

The robotic scanning system works in such a way that the system identifies the measurement areas in the phantom shell by three reference points located on the phantom table and a laser beam on the robot stand which determines the alignment of the probe. The coordinates of the three reference point are entered into the system by manually steering the robotic arm so that the probe tip is above each of these points. Measurement grids can then be defined in each of the available measurement sections of the phantom, the right ear section, the left ear section and in the middle of the shell, the flat section. The robotic arm automatically positions the probe in the selected measurement grid and the distance from the probe tip to the inner surface of the phantom shell is controlled by either a mechanical or an optical surface detection system. The measurement grids are defined so that the whole tested device is covered. During the measurement the local SAR results can be continuously monitored.

5.5 Wireless device holder

Requirements and recommendations are listed in section 5.5 of [2] and [3] and in section 4.1.4 of [4 and 5].

The wireless device holder is a positioning system that allows for very accurate and repeatable device positioning [17]. Tilt and rotation angles have a positioning repeatability better than 1°. Care is taken at the laboratory to ensure that the wireless

Prepared (also subject responsible if other)

LD/SEMC/BGUG/NM Ramadan Plicanic

Approved

LD/SEMC/BGUG/NMC Mats Hansson

Checked

Company Internal
INSTRUCTION

No.

GUG/N 03:141

Date

060220

Rev

E

Reference

File

device is placed in the holder in such a way that the holder has a minimal effect on the measured results. Test personnel are trained on proper positioning techniques.

5.6 Other equipment

Requirements and recommendations are listed in section 5.6 of [2] and [3] and in section 5.5 of [4 and 5].

The measurement system also includes dipole antennas for system performance checking and system validation procedures at frequency bands of interest. The dipole antennas conform to the specifications of Annex G of [3] and Annex F of [4]. These dipole antennas are checked yearly according to the following items:

- dipole arms are parallel to a flat surface with a tolerance of 2°.
- return loss at the center frequency is below -20 dB while the dipole is positioned under the flat phantom according to Section 7 of [4].
- current distribution along the dipole is symmetric within 5%, as measured using an H-field probe.
- SAR is measured in a flat phantom and compared with reference SAR values in Table D.1 of [3] or in Table 7.1 of [4 and 5].

SAR measurement system performance check is described in detail in Annex D.

6 Protocol for SAR assessment

Requirements and recommendations are listed in section 6 of [2] and [3] and in section 5 of [4 and 5].

This section presents an overview of the process of assessing SAR for a wireless terminal in Sony Ericsson SAR testing laboratories, the setup of the tested device and the measurement system, which tests are performed and how the test results are processed.

6.1 Measurement preparation

Requirements and recommendations are listed in section 6.1 of [2] and [3] and in section 5.4 and 5.6 of [4 and 5].

Prior to conducting SAR measurements of the DUT, the dielectric properties of the tissue simulating liquid are measured (see Annex B). System performance check (see Annex D) is performed prior to the SAR measurements or when any part of the SAR testing system has been altered, which includes change of probe and calibration of tissue simulating liquid etc.

For SAR compliance measurements, the peak output power level of the mobile phone is set to the maximum power level of that device with a digital radio tester acting as a base station. The peak power level is measured with either a power meter, a sensor suitable for the carrier frequency and the duty cycle, or a digital radio tester.

Tests are conducted for each of the test configurations of the DUT (operational modes, test frequencies, and configurations).

If the device is intended to be used next to the ear, it is positioned next to the SAM head phantom in the “cheek” and “tilt” positions on both the left and right sides of the phantom according to section 5.4 of [4 and 5].

If the device is intended to be used while placed against the body, the phone is tested on the flat section of the phantom. The device, with its original carry case(s) and with hands-free accessories, shall be positioned on the phantom simulating the intended use position, i.e. with the case placed against the phantom shell. Alternatively, the device can be placed against the phantom using a spacer that separates the device from the phantom by the minimum distance allowable using all carry cases. Additional guidance given in [5] on conducting body-worn measurements should be followed.

Prepared (also subject responsible if other)

LD/SEMC/BGUG/NM Ramadan Plicanic

Approved

LD/SEMC/BGUG/NMC Mats Hansson

Checked

Company Internal
INSTRUCTION

No.

GUG/N 03:141

Date

060220

Rev

E

Reference

File

6.2 Tests to be performed

Requirements and recommendations are listed in section 6.2 of [2] and [3] and in section 5.6 of [4 and 5].

A wireless handset can have many test conditions (operational modes, test frequencies, configurations and test positions against the phantom). At a minimum, the steps outlined in the above listed sections are followed to determine the maximum spatial-averaged SAR of the device.

6.3 Measurement procedure

Requirements and recommendations are listed in section 6.3 of [2] and [3] and in section 5.6 of [4 and 5].

The measurement procedure is described in detail in Annex C. The measurement procedure can be summarized in the following steps:

1. Setup of DASY: liquid parameters, test device properties, probe, DAE and measurement areas are specified in the system configuration setting.
2. Setup of the device: positioning on the phantom, output power level and test channel are selected and checked.
3. SAR measurement, the following measurement jobs are conducted:
 - Reference measurement where the robot moves the probe to a fixed reference position in the tissue liquid and the E-field is recorded.
 - Coarse SAR scan with grid covering the whole device for finding maximum.
 - Fine cubical SAR scan around maximum for obtaining mass averaged SAR.
 - Second reference measurement for checking device output power drift. Repeat the SAR measurement if the drift is higher than $\pm 5\%$ (± 0.21 dB).
 - Surface checks (optional) where the robot repeatedly moves the probe to the phantom surface at a specified point to check the repeatability of the mechanical and optical surface detection are conducted before the reference measurements if needed. If the repeatability is greater than ± 0.1 mm, the system should be inspected (e.g. check for air bubbles trapped under the probe) and the surface check procedure should be repeated.

6.4 Post processing

Requirements and recommendations are listed in section 6.4 of [2] and [3] and in section 5.5 of [4 and 5].

The specific absorption rate (SAR) is calculated from the recorded E-fields by the following expression:

$$SAR = \sigma \frac{E^2}{\rho}$$

where σ is the measured electric conductivity (S/m) of the liquid, E is the measured root-mean-squared E field (V/m), and ρ is the chosen tissue density ($\rho = 1000 \text{ kg/m}^3 = 1 \text{ g/cm}^3$ should always be used [2,4 and 5]). The SAR distribution of the tested device is determined by a coarse scan where the probe is moved in a coarse grid following the inner surface of the phantom. The size of the scanned region should be large enough to guarantee that all possible SAR peaks are included. The distance between adjacent measured points should be 10 – 20 mm [2-5]. Spline interpolation is then used to determine the point of maximum SAR.

The mass averaged SAR is determined by a fine cubical scan, a measurement taken on a fine grid around the position of the maximum SAR. The grid typically consists of 5x5x7 points with 8 mm between the individual points [2] and thus contains about 27 grams of tissue. Numerical extrapolation is then used to determine the SAR values between measurement points in the cube and in the small region between the cube and the inner surface of the phantom where the E-field sensors cannot be positioned. The extrapolation distance is the sum of the probe tip - sensor offset, the surface detection distance and the grid offset. The extrapolation is based on fourth-order polynomial functions. Next, a 3D-spline interpolation algorithm is used to interpolate the measured data to a 1g cube (20x20x20=8000 points) over which the SAR is averaged. The cube is shifted throughout the fine scan area until the highest averaged SAR is found. The same procedure is repeated for the 10 gram cube



Company Internal
INSTRUCTION

Prepared (also subject responsible if other)

LD/SEMC/BGUG/NM Ramadan Plicanic

Approved

LD/SEMC/BGUG/NMC Mats Hansson

Checked

No.

GUG/N 03:141

Date

060220

Rev

E

Reference

File

(also 20x20x20=8000 points). If the 1g and 10g maximum SAR is found when the averaging cube is touching any side of the measurement grid a message “Maximum outside” is given and a second fine scan has to be conducted. This in order to assess the absolute maximum mass averaged SAR.

7 Measurement uncertainty

Requirements and recommendations are listed in section 7 of [2] and [3] and in sections 3 and 4 of [4 and 5]. The measurement uncertainty of the DASY has been determined according to the NIS81 [18] and NIST1297 documents [19]. The total uncertainty of the SAR assessment is composed of two main factors: measurement uncertainty and source uncertainty. Each of these uncertainties consists of a number of individual factors. A detailed breakdown of uncertainties, according to T. Schmid *et. al.* [20], is provided in Annex E. The combined uncertainty ($k=1$) of the 1g SAR assessment is $\pm 13.6\%$ and for 10g SAR assessments $\pm 13.3\%$. The extended uncertainties ($k=2$) is $\pm 27.1\%$ and $\pm 26.6\%$ for 1g and 10g assessments, respectively [21].



Prepared (also subject responsible if other)

LD/SEMC/BGUG/NM Ramadan Plicanic

Approved

LD/SEMC/BGUG/NMC Mats Hansson

Checked

Company Internal
INSTRUCTION

No.

GUG/N 03:141

Date

060220

Rev

E

Reference

File

Annex A Tissue simulating material preparation

This section describes the preparation procedure for the tissue simulating liquids used in SAR testing.

A.1 Liquid parameters

The liquids prepared for the SAR testing meet both the requirements of [2] in table 1 and the requirements of [3] and [4 and 5] in table 2. The parameters below are applicable to average head tissue simulating material. Since dielectric parameters for average body tissue have not yet been developed, liquids meeting the below stated data are also used for measurements of body SAR. The parameters for a liquid used in SAR measurements has to be within $\pm 5\%$ of the target values.

Frequency (MHz)	ϵ_r	σ (S/m)
300	45	0.85
450	44	0.88
900	42	0.99
1450	41	1.20
1800	40	1.38
2450	39	1.84
3000	39	2.40

Table A.1. The dielectric properties of tissue simulating material given in [2].

Frequency (MHz)	ϵ_r	σ (S/m)
300	45.3	0.87
450	43.5	0.87
835	41.5	0.90
900	41.5	0.97
1450	40.5	1.20
1800	40.0	1.40
1900	40.0	1.40
2000	40.0	1.40
2450	39.2	1.80
3000	38.5	2.40

Table A.2. The dielectric properties of tissue simulating material given in [3], [5] and [6].

A.2 Liquid recipes

Ingredients

Water	distilled water
Sugar	as available in food shops
Salt	as available in food shops (Note, no iodine!)
Cellulose	HEC Hydroxyethyl-cellulose (Optional ingredient)
Preservative	Preventol D7 Bayer AG or Sodium Nitrate
DGBE	Diethyleneglycolbutyl ether (CAS No. 112-34-5)

Note 1: It is important to follow the instructions provided in the Material Safety Data Sheet (MSDS) for any material, or any local regulations. It is also important to have material handling procedures (including procedures for handling, storage and disposal).

Prepared (also subject responsible if other)

No.

LD/SEMC/BGUG/NM Ramadan Plicanic

GUG/N 03:141

Approved

Checked

Date

Rev

Reference

LD/SEMC/BGUG/NMC Mats Hansson

060220

E

File

Note 2: Similar materials can also be substituted for the ones above (e.g. deionized water instead of distilled water). The specifications of the materials (e.g. purity) are not critical (although they may change the recipes below), because the after the tissue simulating liquid is made, its dielectric parameters must be verified to be within the target ranges.

Preparation equipment

- Balance (range: 0-6000 g, accuracy: ± 0.1 g)
- Stirrer with hotplate
- Jars and beakers
- Mixing spoon

Liquids for the 835 MHz and 900 MHz

Ingredient	835 MHz and 900 MHz head	
	weight (%)	weight (g)
Distilled water	40.29	532.63
HEC	0.24	3.20
NaCl	1.40	18.29
Preservative	0.18	2.4
Sugar	57.90	765.49
Total amount		1322.00
Goal		
Frequency (MHz)	835	900
Relative Permittivity	41.5	41.5
Conductivity	0.90	0.97

Ingredient	835 MHz and 900 MHz body	
	weight (%)	weight (g)
Distilled water	50.75	633.91
HEC	-	0.00
NaCl	0.94	11.76
Preservative	0.10	1.2
Sugar	48.21	602.12
Total amount		1249.00
Goal		
Frequency (MHz)	835	900
Relative Permittivity	55.2	55.0
Conductivity	0.97	1.05

Liquids for the 1800 MHz and 1900 MHz

Ingredient	1800 MHz and 1900 MHz head	
	weight (%)	weight (g)



Prepared (also subject responsible if other)

No.

LD/SEMC/BGUG/NM Ramadan Plicanic

GUG/N 03:141

Approved

Checked

Date

Rev

Reference

LD/SEMC/BGUG/NMC Mats Hansson

060220

E

File

Distilled water	55.24	552.42
DGBE	44.45	444.52
NaCl (Salt)	0.31	3.06
Total amount		1000.00
Goal		
Frequency (MHz)	1800	1900
Relative Permittivity	40.0	40.0
Conductivity	1.40	1.40

Ingredient	1800 MHz and 1900 MHz body	
	weight (%)	weight (g)
Distilled water	70.17	701.66
DGBE	29.44	294.42
NaCl (Salt)	0.39	3.92
Total amount		1000.00
Goal		
Frequency (MHz)	1800	1900
Relative Permittivity	53.3	53.3
Conductivity	1.52	1.52

Liquids for the 2450 MHz

Ingredient	2450 MHz head	
	weight (%)	weight (g)
Distilled water	55.0	550.00
DGBE	45.0	450.00
Total amount		1000.00
Goal		
Frequency (MHz)	2450	
Relative Permittivity	39.2	
Conductivity	1.80	

Ingredient	2450 MHz body	
	weight (%)	weight (g)
Distilled water	68.64	686.64
DGBE	31.37	313.65
Total amount		1000.00
Goal		
Frequency (MHz)	2450	
Relative Permittivity	52.7	
Conductivity	1.95	

A.2 Preparation procedure

Sugar-based liquids

Add the water to a large container. Begin heating and stirring.

Add the cellulose, preservative and salt (if required). While keeping the container covered, leave the solution on the heating plate until the mixture becomes sufficiently transparent and homogeneous. The temperature of the mixture should be hot enough to aid in mixing the ingredients but cool enough to prevent a significant amount of water evaporation.

Add the sugar. Hand stirring may be necessary at the beginning until the sugar is sufficiently dissolved.

Company Internal
INSTRUCTION

Prepared (also subject responsible if other)

LD/SEMC/BGUG/NM Ramadan Plicanic

Approved

LD/SEMC/BGUG/NMC Mats Hansson

Checked

No.

GUG/N 03:141

Date

060220

Rev

E

Reference

File

Keep the liquid hot and the container covered until the solids are dissolved and the liquid is homogenous.

Turn the hotplate off and allow the liquid to cool off to room temperature prior to performing dielectric measurements.

Alcohol-based liquids

1. Add all the ingredients in a large container.
2. Stir until the liquids are solved.

A.3 Tissue liquid maintenance

In order to keep the dielectric parameters of the tissue simulating liquids within their target ranges, ingredients may be added to adjust the parameters. For example, one can add water to increase the permittivity, sugar to reduce the permittivity or salt to increase the conductivity. Parameters should each be within a $\pm 5\%$ range of target values.

A batch of tissue simulating liquid may last several months or more but regular maintenance is necessary in order to keep the dielectric properties within target ranges. The electrical parameters of the tissue simulating liquids are assessed prior to SAR compliance testing and checked that they are within tolerance of the specified values (see tables above). The parameters are subject to small variations due to evaporation, and ingredients have to be added on a regular basis in order to adjust the parameters. The amount of ingredient to add depends on the parameter deviations and the total liquid volume and is therefore not easily calculated. However, based on experience, for sugar-salt-water liquids a rule of thumb can be applied: to a 25-liter liquid with a permittivity deviation of about -7% and a conductivity deviation around -3% to -7%, 200 – 400 grams of water should be added. It is recommended that a batch be disposed of and replaced with a new batch when it becomes difficult to keep its dielectric parameters within the ranges specified.

Prepared (also subject responsible if other)

LD/SEMC/BGUG/NM Ramadan Plicanic

Approved

LD/SEMC/BGUG/NMC Mats Hansson

Checked

Company Internal
INSTRUCTION

No.

GUG/N 03:141

Date

060220

Rev

E

Reference

File

Annex B: Dielectric property measurements

This annex describes the procedures used to measure the dielectric properties of the tissue simulating liquid.

B.1 Equipment

- HP network analyzer, models in the HP8753 series, HP8752C or similar
- HP dielectric probe kit HP85070 of versions A, B, C or D [25]
- HP 85070 software (any software version)
- PC using GPIB card [24] for communication with network analyzer
- Syringe
- Small glass jars for liquid samples
- Thermometer

B.2 Procedure for testing tissue simulating liquid

1. Turn the NWA (Network analyzer) on and allow it to warm up.
2. Start the PC and run the HP 85070 software.
3. Mount dielectric probe kit so that interconnecting cable to NWA will not be moved during measurement or calibration.
4. Perform calibration according to the HP85070 manual [25]. In short the following steps are covered:
 - Inspect the probe and ensure that it is properly cleaned.
 - Pour distilled water in a sample container and measure the water temperature.
 - Set start and stop frequency, frequency step and water temperature.
 - Perform calibration measurement with probe in air, connected to short circuiting block and in distilled water. Assure proper contact which requires attaching the block firmly. Monitor the polar chart on the network analyzer to assure good contact as explained in the manual.
5. Assure that the probe is thoroughly cleaned before performing the measurement.
6. Inspect the liquid for in homogeneities. Surface bubbles can be moved to one side, but if there are numerous bubbles throughout the liquid (e.g. as happens after a new liquid has been poured into a phantom), wait until the bubbles have floated to the surface before proceeding. Also remove any debris or lumps in the liquid.
7. Stir the liquid to be measured.
8. Measure the temperature of the tissue simulating liquid in the phantom. Save value for reference, SAR measurements are only conducted for temperatures $\pm 2^{\circ}\text{C}$ from this reference temperature.
9. Extract a sample (approximately 50 ml or more).
10. Measure liquid shortly after calibration of the network analyzer and at most within an hour of this calibration. It is also important to measure the liquid sample soon after extracting it so that evaporation and temperature variation do not affect the results.
11. Immerse the dielectric probe in the liquid sample. Check that there are no air bubbles in front of the opening in the dielectric probe kit.
12. Perform measurements. Repeat measurement five times to increase reliability and use average value for comparison with target value. If a single measurement deviates substantially from the rest then redo that measurement to reject possible artifact. The accuracy specified by the dielectric probe kit manufacturer [23] is $\pm 5\%$ for the dielectric constant ϵ' and ± 0.05 for the loss tangent ϵ''/ϵ' .
13. Conductivity σ can be calculated from ϵ'' according to
$$\sigma = \omega \epsilon_0 \epsilon'' \cong \epsilon'' f \text{ (GHz)}/18.$$
14. Clean the probe thoroughly after use.
15. Pour the sample back into the phantom.

Prepared (also subject responsible if other)

LD/SEMC/BGUG/NM Ramadan Plicanic

Approved

LD/SEMC/BGUG/NMC Mats Hansson

Checked

Company Internal
INSTRUCTION

No.

GUG/N 03:141

Date

060220

Rev

E

Reference

File

Annex C: SAR measurement procedure

This section gives a step-by-step procedure for measuring the DUT. The instructions of this section are only valid under the assumption that the measurement equipment is calibrated. More information is found in the user manual for the measurement system [13].

C.1 Initial setup

1. Ensure that the computer, robot controller and DAE are turned on, and that the DASY software is running.
2. Press the robot button on the toolbar to set up the communications between the software and the robot. Go through the self-check procedure in the software to ensure that the system is properly running and set up for measurement.
3. Choose the appropriate test configuration in the "Setup" menu. NOTE, check that the medium parameters in the "options" window are equal to those measured previously with the dielectric probe kit for the liquid in the phantom.
5. Remove the plastic cover on the phantom.
6. Verify that the system knows the reference points on the phantom. Check the distance between the reference points and the probe tip with the plastic spacer. If it does not accurately locate one or more of the points, install the reference points. Should the installation fail to give results within the tolerances set out in the factory settings for the phantom, the procedure will give an error and the user will have to reinstall the reference points. Afterwards, move the probe to the resting point above the flat section.
7. Stir the liquid in the phantom to ensure that it is homogeneous. Surface bubbles can be moved to one side, but if there are numerous bubbles throughout the liquid (e.g. as happens after a new liquid has been poured into a phantom), wait until the bubbles have floated to the surface before proceeding. Also remove any debris or lumps in the liquid.
8. Measure the temperature of the tissue simulating liquid in the phantom. The liquid temperature has to be within ± 2 °C of the temperature recorded when the electrical parameters were measured.

C.2 Measurement procedure

The following steps should be carried out for each of the test conditions described in Section 6.2.

1. Open the appropriate predefined measurement file or prepare a new measurement file by selecting jobs from the menu. The measurement file contains the following jobs: reference measurement, drift measurement, coarse scan covering the whole device, two cubical fine scans and a final drift measurement. The recording time for the coarse and fine scans is 1 second, which gives sufficient accuracy, but for reference/drift measurements 4 seconds giving increased noise-reduction. Additionally, a surface check can be inserted before the reference/drift measurements. During this check, the robot repeatedly moves the probe to the phantom surface at a specified point to check the repeatability of the mechanical and optical surface detection. If the repeatability is worse than ± 0.1 mm, the system should be inspected (e.g. check for air bubbles trapped under the probe) and the surface check procedure should be repeated. Save the measurement file under an appropriate name.
2. Move the probe so that the tip is below the surface of the liquid in the selected measurement section. Stir the liquid again to remove any bubbles trapped under the probe tip.
3. Power on the DUT and set it to transmit at full power in one of the operational configurations (as described in Section 6.1). Check the signal with the spectrum analyzer.
4. Position the DUT against the phantom in one of the required test positions (as described in Section 6.1).
5. Select and start the first five measurement jobs; reference measurement, 3-minute time sweep, drift measurement, the coarse and one fine scan). Note the time sweep can be omitted once the device has warmed up.



Company Internal
INSTRUCTION

Prepared (also subject responsible if other)

LD/SEMC/BGUG/NM Ramadan Plicanic

Approved

LD/SEMC/BGUG/NMC Mats Hansson

Checked

No.

GUG/N 03:141

Date

060220

Rev

E

Reference

File

6. Check the measured fine scan when the measurement jobs have been completed. If the maximum SAR has been found within the measured grid (no system message "Maximum outside") delete the second fine scan in the file and proceed with the final drift measurement. Otherwise, measure both the second fine scan and the drift measurement. Additionally, check for local maxima of at least 50% of maximum SAR.
7. Check the system drift. If the measurement data is not within $\pm 5\%$ (± 0.21 dB), check the DUT and change battery if necessary, check the DASY and repeat the measurement. If the drift cannot be maintained within 5%, add the drift to the measured SAR value.
8. Save the measurement data and enter it into the laboratory log.

C.3 Post measurement procedure

When the SAR measurements are finished, do the following:

1. Power off the DUT.
2. Move the probe to the resting point and clean it with water.
3. Put the plastic cover on the phantom.

Prepared (also subject responsible if other)

LD/SEMC/BGUG/NM Ramadan Plicanic

Approved

LD/SEMC/BGUG/NMC Mats Hansson

Checked

Company Internal
INSTRUCTION

No.

GUG/N 03:141

Date

060220

Rev

E

Reference

File

Annex D: Measurement system performance check and validation

D.1 General

Measurement system validation consists of three procedures:

1. System performance checking
2. System validation
3. Inter laboratory comparison

These three procedures are defined in section 7 of [4 and 5]. System performance checking and inter laboratory comparison are also described in Annex D of [2] (they are called Simplified performance checking and system validation, respectively) and in Annex D of [3].

System performance checking is conducted prior to the SAR testing of a wireless device with a reference dipole antenna and the flat section of the SAM phantom. The results are compared to reference data provided by the system manufacturer, Schmid & Partner Engineering AG. The DASY3 manufacturer conducts system validation. Inter laboratory comparison between the Ericsson SAR testing laboratories is conducted according to a separate procedure.

D.2 System performance check procedure

System performance check is conducted according to the following steps.

Setup of the dipole antenna

1. Turn on the signal generator, power meter and power amplifier (if used). Allow them sufficient time to warm up, to reduce drift.
2. Position the dipole antenna under the flat phantom and adjust the height of the stand until the specified spacer is touching the shell of the flat phantom. The center of the dipole antenna should be positioned under the middle of the flat phantom, as indicated by a mark on the flat phantom.
3. Connect one end of the coax line to the power meter sensor and the other end to the output of the signal generator. If the power amplifier is used, connect it between the signal generator and the power meter sensor.
4. Set the signal generator to transmit in CW mode and ensure that any signal modulation is turned off. This ensures that the power amplifier will transmit a pure sinusoid.
5. Set the frequency of the signal generator to the resonant frequency of the dipole antenna.
6. Set the output power of the signal generator (and optionally adjust the gain of the power amplifier) so that the same amount of power as used by the system manufacturer at calibration is delivered to the power meter.
7. Disconnect the coax line from the power meter and connect it to the dipole antenna.

Setup of the DASY

1. Mount the 3D electric field probe, as shown in the SPEAG manual.
2. Remove the plastic cover on the phantom.
3. Power up the DAE. The LED indicates that the power is on.
4. Power up the computer.
5. Turn on the robot controller
6. Start the DASY software on the computer.

Company Internal
INSTRUCTION

Prepared (also subject responsible if other)

LD/SEMC/BGUG/NM Ramadan Plicanic

Approved

LD/SEMC/BGUG/NMC Mats Hansson

Checked

No.

GUG/N 03:141

Date

060220

Rev

E

Reference

File

7. Choose the appropriate measurement configuration in the “Setup” menu of the software for the dipole measurement. Record the dielectric constant and conductivity of the liquid in the program.
8. Press the robot button on the toolbar to set up the communications between the software and the robot. Go through the self-check procedure in the software to ensure that the system is properly running and set up for measurement.
9. Verify that the robot knows the reference points on the phantom. Check the distance between the reference points and the probe tip with the plastic spacer. If it does not accurately locate one or more of the reference points to within ± 5 mm, install the reference points. Should the installation fail to give results within the tolerances set out in the factory settings for the phantom, the procedure will give an error and the user will have to reinstall the reference points. Afterward, move the probe to the resting point above the flat section.
10. Measure the temperature of the tissue simulating liquid in the phantom. The liquid temperature has to be within ± 2 °C of the temperature recorded when the electrical parameters were measured.

Measurement procedure

1. Open a measurement file. Select the predefined dipole test provided by SPEAG. This file includes all of the necessary measurements for the dipole test. Rename the file with an appropriate name and save it in the appropriate directory.
2. Tell the robot to move the probe tip below the surface of the liquid. Stir the liquid again to remove any bubbles trapped under the probe tip.
3. Select and start the measurement jobs in the file. These include the reference check, coarse scan, fine scan, and drift measurements.

Analysis of measured data

1. Normalize the measurement data to 1 Watt and compare the one-gram and ten-gram averaged peak SAR values to the standard values provided in the reference documents. If they do not agree within $\pm 10\%$, check the system parameters (e.g. antenna output power, dielectric parameters of the tissue simulating liquid, homogeneity of the liquid) and repeat the measurement.
2. Also check that the distribution of measured SAR agrees with that provided in the reference data. The peak SAR should be located over the center of the dipole, and the SAR should monotonically decrease away from this point. If the SAR distribution does not compare well with the reference data, repeat the measurement.
3. Make sure that the drift measurement is within $\pm 5\%$ (± 0.2 dB). If not, check the system parameters and repeat the measurement.
4. Save the measurement data and enter it into the logbook.
5. Move the probe out of the liquid and clean it with warm water.

Prepared (also subject responsible if other)

No.

LD/SEMC/BGUG/NM Ramadan Plicanic

GUG/N 03:141

Approved

Checked

Date

Rev

Reference

LD/SEMC/BGUG/NMC Mats Hansson

060220

E

File

Annex E Uncertainty budgets for 1g and 10g SAR assessments with DASY

E.1 Uncertainty budget for measurements of 1g mass averaged SAR

Error description	Uncertainty (%)	Distrib.	Divisor	c_i 1g	Standard unc 1g (%)	v_i^2 or v_{eff}
Measurement system						
Probe calibration	± 4.4	Normal	1	1	± 4.4	∞
Axial isotropy	± 4.7	Rectang.	$\sqrt{3}$	$(1-c_p)^{1/2}$	± 1.9	∞
Spherical isotropy	± 9.6	Rectang.	$\sqrt{3}$	$(c_p)^{1/2}$	± 3.9	∞
Spatial resolution	± 0.0	Rectang.	$\sqrt{3}$	1	± 0.0	∞
Boundary effects	± 5.5	Rectang.	$\sqrt{3}$	1	± 3.2	∞
Probe linearity	± 4.7	Rectang.	$\sqrt{3}$	1	± 2.7	∞
Detection limit	± 1.0	Rectang.	$\sqrt{3}$	1	± 0.6	∞
Readout electronics	± 1.0	Normal	1	1	± 1.0	∞
Response time	± 0.8	Rectang.	$\sqrt{3}$	1	± 0.5	∞
Integration time	± 1.4	Rectang.	$\sqrt{3}$	1	± 0.8	∞
RF ambient conditions	± 3.0	Rectang.	$\sqrt{3}$	1	± 1.7	∞
Mech. Constraints of robot	± 0.4	Rectang.	$\sqrt{3}$	1	± 0.2	∞
Probe positioning	± 2.9	Rectang.	$\sqrt{3}$	1	± 1.7	∞
Extrap. and integration	± 3.9	Rectang.	$\sqrt{3}$	1	± 2.3	∞
Test sample related						
Device positioning	± 6.0	Normal	0.89	1	± 6.7	12
Device holder uncertainty	± 5.0	Normal	0.84	1	± 5.9	8
Power drift	± 5.0	Rectang.	$\sqrt{3}$	1	± 2.9	∞
Phantom and setup						
Phantom uncertainty	± 4.0	Rectang.	$\sqrt{3}$	1	± 2.3	∞
Liquid conductivity (target)	± 5.0	Rectang.	$\sqrt{3}$	0.6	± 1.7	∞
Liquid conductivity (meas)	± 10.0	Rectang.	$\sqrt{3}$	0.6	± 3.5	∞
Liquid permittivity (target)	± 5.0	Rectang.	$\sqrt{3}$	0.6	± 1.7	∞
Liquid permittivity (meas)	± 5.0	Rectang.	$\sqrt{3}$	0.6	± 1.7	∞
Combined standard uncertainty					± 13.6	
Extended standard uncertainty (k=2)					± 27.1	

Prepared (also subject responsible if other)

No.

LD/SEMC/BGUG/NM Ramadan Plicanic

GUG/N 03:141

Approved

Checked

Date

Rev

Reference

LD/SEMC/BGUG/NMC Mats Hansson

060220

E

File

E.2 Uncertainty budget for measurements of 10g mass averaged SAR

Error description	Uncertainty (%)	Distrib.	Divisor	c_i 10g	Standard unc 10g (%)	v_i^2 or v_{eff}
Measurement system						
Probe calibration	± 4.4	Normal	1	1	± 4.4	∞
Axial isotropy	± 4.7	Rectang.	$\sqrt{3}$	$(1-c_p)^{1/2}$	± 1.9	∞
Spherical isotropy	± 9.6	Rectang.	$\sqrt{3}$	$(c_p)^{1/2}$	± 3.9	∞
Spatial resolution	± 0.0	Rectang.	$\sqrt{3}$	1	± 0.0	∞
Boundary effects	± 5.5	Rectang.	$\sqrt{3}$	1	± 3.2	∞
Probe linearity	± 4.7	Rectang.	$\sqrt{3}$	1	± 2.7	∞
Detection limit	± 1.0	Rectang.	$\sqrt{3}$	1	± 0.6	∞
Readout electronics	± 1.0	Normal	1	1	± 1.0	∞
Response time	± 0.8	Rectang.	$\sqrt{3}$	1	± 0.5	∞
Integration time	± 1.4	Rectang.	$\sqrt{3}$	1	± 0.8	∞
RF ambient conditions	± 3.0	Rectang.	$\sqrt{3}$	1	± 1.7	∞
Mech. Constraints of robot	± 0.4	Rectang.	$\sqrt{3}$	1	± 0.2	∞
Probe positioning	± 2.9	Rectang.	$\sqrt{3}$	1	± 1.7	∞
Extrap. and integration	± 3.9	Rectang.	$\sqrt{3}$	1	± 2.3	∞
Test sample related						
Device positioning	± 6.0	Normal	0.89	1	± 6.7	12
Device holder uncertainty	± 5.0	Normal	0.84	1	± 5.9	8
Power drift	± 5.0	Rectang.	$\sqrt{3}$	1	± 2.9	∞
Phantom and setup						
Phantom uncertainty	± 4.0	Rectang.	$\sqrt{3}$	1	± 2.3	∞
Liquid conductivity (target)	± 5.0	Rectang.	$\sqrt{3}$	0.6	± 1.4	∞
Liquid conductivity (meas)	± 10.0	Rectang.	$\sqrt{3}$	0.6	± 2.9	∞
Liquid permittivity (target)	± 5.0	Rectang.	$\sqrt{3}$	0.6	± 1.4	∞
Liquid permittivity (meas)	± 5.0	Rectang.	$\sqrt{3}$	0.6	± 1.4	∞
Combined standard uncertainty					± 13.3	
Extended standard uncertainty (k=2)					± 26.6	