



TEST REPORT

Test report no.: 1-2977/11-94-04



Testing laboratory

CETECOM ICT Services GmbH
Untertuerkheimer Strasse 6 – 10
66117 Saarbruecken / Germany
Phone: + 49 681 5 98 - 0
Fax: + 49 681 5 98 - 9075
Internet: <http://www.cetecom.com>
e-mail: ict@cetecom.com

Accredited Testing Laboratory:

The testing laboratory (area of testing) is accredited according to DIN EN ISO/IEC 17025 (2005) by the Deutsche Akkreditierungsstelle GmbH (DAkkS). The accreditation is valid for the scope of testing procedures as stated in the accreditation certificate with the registration number: D-PL-12076-01-01
Area of Testing: Radio/Satellite Communications

Applicant

Sony Ericsson Mobile Communications AB
Nya Vattentornet
22188 Lund / SWEDEN
Phone: +46 46 19 30 00
Fax: +46 46 19 32 95
Contact: Håkan Sjöberg
e-mail: hakan.sjoberg@sonyericsson.com
Phone: +46 46 19 35 59

Manufacturer

Sony Ericsson Mobile Communications AB
Nya Vattentornet
22188 Lund / SWEDEN

Test standard/s

47 CFR Part 15	Title 47 of the Code of Federal Regulations; Chapter I Part 15 - Radio frequency devices
RSS - 210 Issue 8	Spectrum Management and Telecommunications - Radio Standards Specification Low-power Licence-exempt Radiocommunication Devices (All Frequency Bands): Category I Equipment

For further applied test standards please refer to section 3 of this test report.

Test Item

Kind of test item:	GSM Mobile Phone 850/900/1800/1900; GPRS/EGPRS; UMTS FDDI/FDDV/FDDVI/FDDIX/FDDXIX; HSPA; RFID; BT EDR; WLAN b/g/n; ANT+; GPS
Model name:	AAD-3880132-BV
FCC ID:	PY7A3880132
IC:	4170B-A3880132
Frequency [MHz]:	ISM band 2400 MHz to 2483.5 MHz (lowest channel 00 – 2402 MHz, highest channel 78 – 2480 MHz)
Technology tested:	Bluetooth®
Antenna:	Integrated PCB antenna
Power Supply:	3.7 V DC by Li - polymer battery
Temperature Range:	-20°C to +50 °C

Test report authorised:

2012-01-10 Stefan Bös
Senior Testing Manager

Test performed:

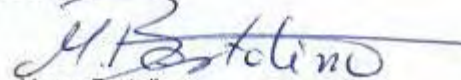
2012-01-10 Marco Bertolino
Testing Manager

1 Table of contents	
1	Table of contents2
2	General information3
2.1	Notes and disclaimer3
2.2	Application details.....3
3	Test standard/s3
4	Test environment.....4
5	Test item4
6	Test laboratories sub-contracted4
7	Summary of measurement results5
8	RF measurements6
8.1	Description of test setup6
8.1.1	Radiated measurements.....6
8.1.2	Conducted measurements.....7
8.2	Additional comments7
8.3	RSP100 test report cover sheet / performance test data8
9	Measurement results.....9
9.1	Antenna gain9
9.2	Power spectral density10
9.3	Carrier frequency separation11
9.4	Number of hopping channels13
9.5	Time of occupancy (dwell time)15
9.6	Spectrum bandwidth of a FHSS system – 20 dB bandwidth16
9.7	Maximum output power22
9.8	Band edge compliance conducted29
9.9	Band edge compliance radiated36
9.10	TX spurious emissions conducted43
9.11	TX spurious emissions radiated.....51
9.12	RX spurious emissions radiated65
9.13	TX spurious emissions radiated < 30 MHz70
9.14	TX spurious emissions conducted < 30 MHz.....73
10	Test equipment and ancillaries used for tests76
11	Observations77
Annex A	Photographs of the test setup78
Annex B	External photographs of the EUT83
Annex C	Internal photographs of the EUT86
Annex D	Document history112
Annex E	Further information.....112
Annex F	Accreditation Certificate113

2 General information

2.1 Notes and disclaimer

The test results of this test report relate exclusively to the test item specified in this test report. CETECOM ICT Services GmbH does not assume responsibility for any conclusions and generalizations drawn from the test results with regard to other specimens or samples of the type of the equipment represented by the test item.

The test report may only be reproduced or published in full. Reproduction or publication of extracts from the report requires the prior written approval of CETECOM ICT Services GmbH.

The testing service provided by CETECOM ICT Services GmbH has been rendered under the current "General Terms and Conditions for CETECOM ICT Services GmbH".

CETECOM ICT Services GmbH will not be liable for any loss or damage resulting from false, inaccurate, inappropriate or incomplete product information provided by the customer.

Under no circumstances does the CETECOM ICT Services GmbH test report include any endorsement or warranty regarding the functionality, quality or performance of any other product or service provided.

Under no circumstances does the CETECOM ICT Services GmbH test report include or imply any product or service warranties from CETECOM ICT Services GmbH, including, without limitation, any implied warranties of merchantability, fitness for purpose, or non-infringement, all of which are expressly disclaimed by CETECOM ICT Services GmbH.

All rights and remedies regarding vendor's products and services for which CETECOM ICT Services GmbH has prepared this test report shall be provided by the party offering such products or services and not by CETECOM ICT Services GmbH.

In no case this test report can be considered as a Letter of Approval.

This test report is electronically signed and valid without handwritten signature. For verification of the electronic signatures, the public keys can be requested at the testing laboratory.

2.2 Application details

Date of receipt of order:	2011-10-19
Date of receipt of test item:	2011-11-30
Start of test:	2011-11-30
End of test:	2012-01-04
Person(s) present during the test:	-/-

3 Test standard/s

Test standard	Date	Test standard description
47 CFR Part 15	2010-10	Title 47 of the Code of Federal Regulations; Chapter I Part 15 - Radio frequency devices
RSS - 210 Issue 8	2010-12	Spectrum Management and Telecommunications - Radio Standards Specification Low-power Licence-exempt Radiocommunication Devices (All Frequency Bands): Category I Equipment

4 Test environment

Temperature:	T_{nom}	+22 °C during room temperature tests
	T_{max}	+50 °C during high temperature tests
	T_{min}	-20 °C during low temperature tests
Relative humidity content:		42 %
Barometric pressure:		not relevant for this kind of testing
Power supply:	V_{nom}	3.7 V DC by Li - polymer battery
	V_{max}	4.1 V
	V_{min}	3.3 V

5 Test item

Kind of test item	:	GSM Mobile Phone 850/900/1800/1900; GPRS/EGPRS; UMTS FDDI/FDDV/FDDVI/FDDIX/FDDXIX; HSPA; RFID; BT EDR; WLAN b/g/n; ANT+; GPS
Type identification	:	AAD-3880132-BV
S/N serial number	:	Radiated units: CB511VCP0K Conducted units: CB511UVFGR, CB511UVFGG
HW hardware status	:	AP1
SW software status	:	6.0.A.0.463 ATP R1A034
Frequency band [MHz]	:	ISM band 2400 MHz to 2483.5 MHz (lowest channel 00 – 2402 MHz, highest channel 78 – 2480 MHz)
Type of radio transmission	:	FHSS
Use of frequency spectrum	:	
Channel access method	:	FDMA
Type of modulation	:	QPSK, Pi/DQPSK and 8DPSK
Number of channels	:	79
Antenna	:	Integrated PCB antenna
Power supply	:	3.7 V DC by Li - polymer battery
Temperature range	:	-20°C to +50 °C

6 Test laboratories sub-contracted

None

7 Summary of measurement results

- No deviations from the technical specifications were ascertained
- There were deviations from the technical specifications ascertained

TC Identifier	Description	Verdict	Date	Remark
RF-Testing	CFR Part 15 RSS 210, Issue 8, Annex 8	Passed	2012-01-10	-/-

Test specification clause	Test case	Temperature conditions	Power source voltages	Mode	Pass	Fail	NA	NP	Remark
§15.247(b)(4) RSS 210 / A8.4(2)	Antenna gain	Nominal	Nominal	GFSK	<input checked="" type="checkbox"/>	<input type="checkbox"/>	<input type="checkbox"/>	<input type="checkbox"/>	complies
§15.247(e) RSS 210 / A8.2(b)	Power spectral density	Nominal	Nominal	GFSK Pi/4 DQPSK 8 DPSK	<input type="checkbox"/>	<input type="checkbox"/>	<input checked="" type="checkbox"/>	<input type="checkbox"/>	Not applicable for FHSS!
§15.247(a)(1) RSS 210 / A8.1(b)	Carrier frequency separation	Nominal	Nominal	GFSK	<input checked="" type="checkbox"/>	<input type="checkbox"/>	<input type="checkbox"/>	<input type="checkbox"/>	complies
§15.247(a)(1) RSS 210 / A8.1(d)	Number of hopping channels	Nominal	Nominal	GFSK	<input checked="" type="checkbox"/>	<input type="checkbox"/>	<input type="checkbox"/>	<input type="checkbox"/>	complies
§15.247(a)(1) (iii) RSS 210 / A8.3(1)	Time of occupancy (dwell time)	Nominal	Nominal	GFSK Pi/4 DQPSK 8 DPSK	<input checked="" type="checkbox"/>	<input type="checkbox"/>	<input type="checkbox"/>	<input type="checkbox"/>	complies
§15.247(a)(1) RSS 210 / A8.2(a)	Spectrum bandwidth of a FHSS system 20dB bandwidth	Nominal	Nominal	GFSK Pi/4 DQPSK 8 DPSK	<input checked="" type="checkbox"/> <input checked="" type="checkbox"/> <input checked="" type="checkbox"/>	<input type="checkbox"/> <input type="checkbox"/> <input type="checkbox"/>	<input type="checkbox"/> <input type="checkbox"/> <input type="checkbox"/>	<input type="checkbox"/> <input type="checkbox"/> <input type="checkbox"/>	complies
§15.247(b)(1) RSS-210 / A8.4(2)	Maximum output power	Nominal	Nominal	GFSK Pi/4 DQPSK 8 DPSK	<input checked="" type="checkbox"/> <input checked="" type="checkbox"/> <input checked="" type="checkbox"/>	<input type="checkbox"/> <input type="checkbox"/> <input type="checkbox"/>	<input type="checkbox"/> <input type="checkbox"/> <input type="checkbox"/>	<input type="checkbox"/> <input type="checkbox"/> <input type="checkbox"/>	complies
§15.247(d) RSS-210 / A8.5	Band edge compliance conducted	Nominal	Nominal	GFSK Pi/4 DQPSK 8 DPSK	<input checked="" type="checkbox"/> <input checked="" type="checkbox"/> <input checked="" type="checkbox"/>	<input type="checkbox"/> <input type="checkbox"/> <input type="checkbox"/>	<input type="checkbox"/> <input type="checkbox"/> <input type="checkbox"/>	<input type="checkbox"/> <input type="checkbox"/> <input type="checkbox"/>	complies
§15.205 RSS-210 / A8.5	Band edge compliance radiated	Nominal	Nominal	GFSK Pi/4 DQPSK 8 DPSK	<input checked="" type="checkbox"/> <input checked="" type="checkbox"/> <input checked="" type="checkbox"/>	<input type="checkbox"/> <input type="checkbox"/> <input type="checkbox"/>	<input type="checkbox"/> <input type="checkbox"/> <input type="checkbox"/>	<input type="checkbox"/> <input type="checkbox"/> <input type="checkbox"/>	complies
§15.247(d) RSS-210 / A8.5	TX spurious emissions conducted	Nominal	Nominal	GFSK Pi/4 DQPSK 8 DPSK	<input checked="" type="checkbox"/> <input checked="" type="checkbox"/> <input checked="" type="checkbox"/>	<input type="checkbox"/> <input type="checkbox"/> <input type="checkbox"/>	<input type="checkbox"/> <input type="checkbox"/> <input type="checkbox"/>	<input type="checkbox"/> <input type="checkbox"/> <input type="checkbox"/>	complies
§15.247(d) RSS-210 / A8.5	TX spurious emissions radiated	Nominal	Nominal	8 DPSK	<input checked="" type="checkbox"/>	<input type="checkbox"/>	<input type="checkbox"/>	<input type="checkbox"/>	complies
§15.109 RSS-Gen.	RX spurious emissions radiated	Nominal	Nominal	-/-	<input checked="" type="checkbox"/>	<input type="checkbox"/>	<input type="checkbox"/>	<input type="checkbox"/>	complies
§15.209(a) RSS-Gen	TX spurious emissions radiated < 30 MHz	Nominal	Nominal	8 DPSK	<input checked="" type="checkbox"/>	<input type="checkbox"/>	<input type="checkbox"/>	<input type="checkbox"/>	complies
§15.107(a)	Conducted emissions < 30 MHz	Nominal	Nominal	8 DPSK	<input checked="" type="checkbox"/>	<input type="checkbox"/>	<input type="checkbox"/>	<input type="checkbox"/>	complies

Note: NA = Not Applicable; NP = Not Performed

8 RF measurements

8.1 Description of test setup

8.1.1 Radiated measurements

The radiated measurements are performed in vertical and horizontal plane in the frequency range from 9 kHz to 25 GHz in semi-anechoic chambers. The EUT is positioned on a non-conductive support with a height of 0.80 m above a conductive ground plane that covers the whole chamber. The receiving antennas are confirmed with specifications ANSI C63.2-1996 clause 15 and ANSI C63.4-2009 clause 4.1.5. These antennas can be moved over the height range between 1.0 m and 4.0 m in order to search for maximum field strength emitted from EUT. The measurement distances between EUT and receiving antennas are indicated in the test setups for the various frequency ranges. For each measurement, the EUT is rotated in all three axes until the maximum field strength is received. The wanted and unwanted emissions are received by spectrum analysers where the detector modes and resolution bandwidths over various frequency ranges are set according to requirement ANSI C63-4-2009 clause 4.2.

Antennas are confirmed with ANSI C63.2-1996 item 15.

Semi anechoic chamber

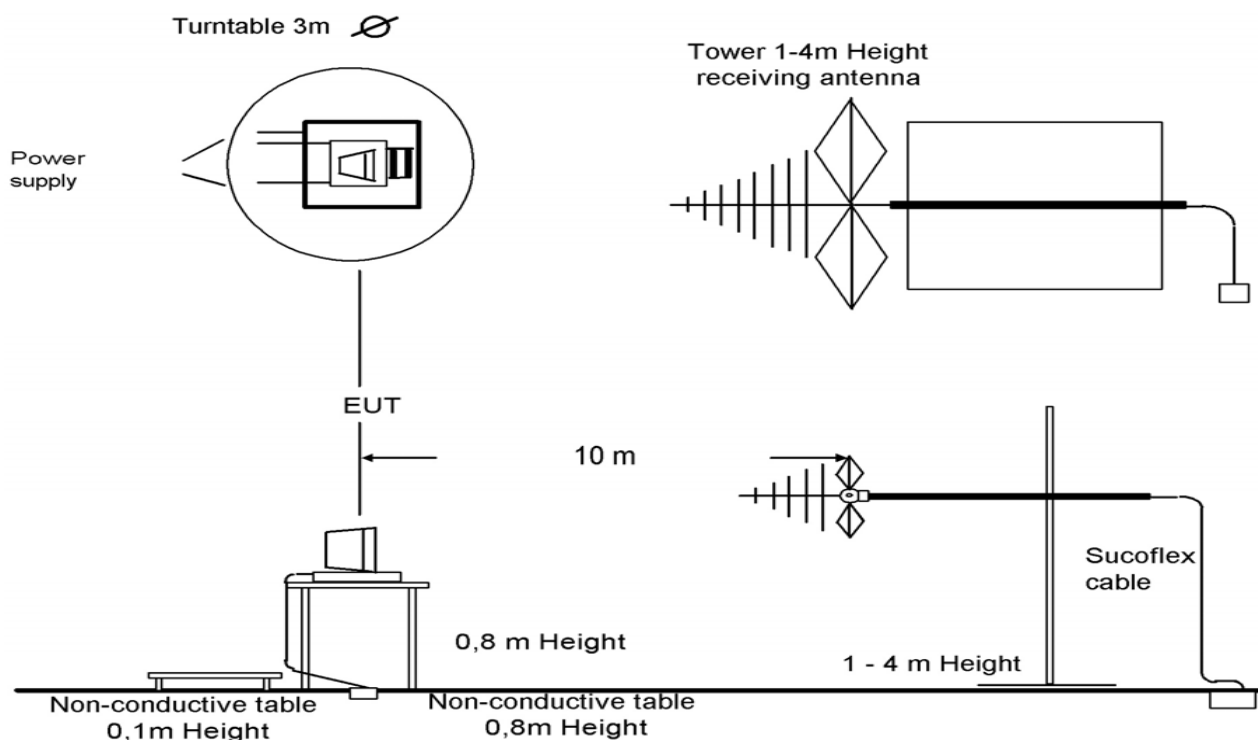

Picture 1: Diagram radiated measurements

9 kHz - 30 MHz:	active loop antenna
30 MHz – 1 GHz:	tri-log antenna
> 1 GHz:	horn antenna

All measurements are done in accordance with the Filing and Measurement Guidelines for Frequency Hopping Spread Spectrum Systems DA 00-705 and Appendix A "BLUETOOTH® APPROVALS"

The EUT is powered by an external power supply with nominal voltage. The signalling is performed from outside the chamber with a signalling unit (CMU200 or other) by air link using signalling antenna.

8.1.2 Conducted measurements

The EUT's RF signal is coupled out by the antenna connector which is supplied by the manufacturer. The signal is first 10dB attenuated before it is power divided (~6dB loss per branch). One of the signal paths is connected to the communication base Station (CMU200 or other), the other one is connected to the spectrum analyzer. The specific losses for both signal paths are first checked within a calibration. The measurement readings on the signalling unit/spectrum analyzer are corrected by the specific test set-up loss. The attenuator, power divider, signalling unit and the spectrum analyzer are impedance matched on 50 Ohm.

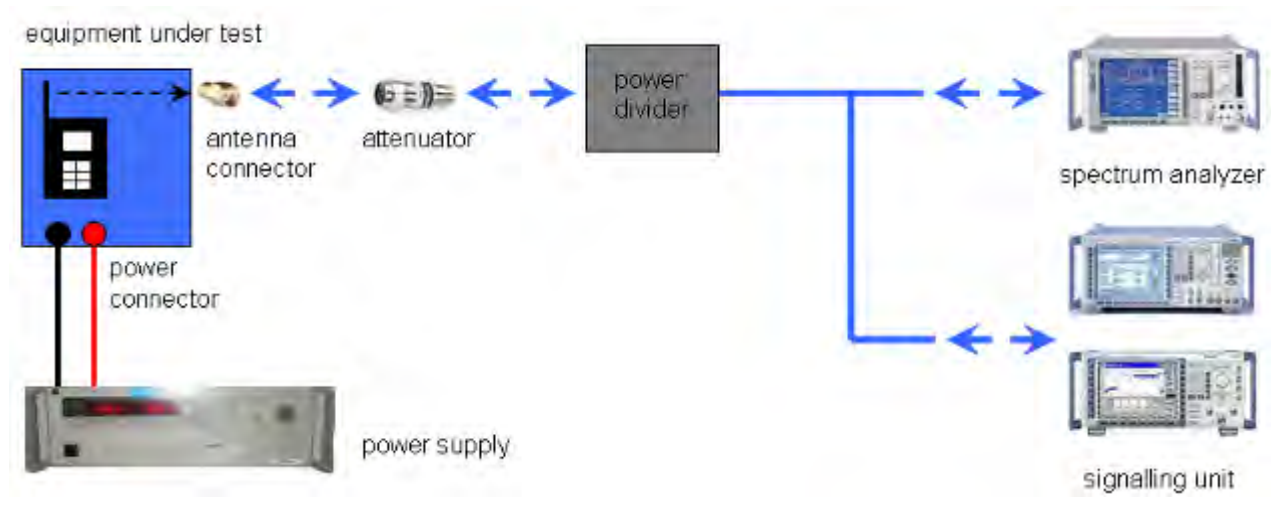

Picture 2: Diagram conducted measurements

8.2 Additional comments

The Bluetooth® word mark and logos are owned by the Bluetooth SIG Inc. and any use of such marks by Cetecom ICT Services GmbH is under license.

Reference documents: None

Special test descriptions: None

Configuration descriptions: TX tests: were performed with x-DH5 packets and static PRBS pattern payload.
RX/Standby tests: BT test mode enabled, scan enabled, TX Idle

Test mode:

- Bluetooth Test mode loop back enabled (EUT is controlled over CBT/CMU)
- Special software is used. EUT is transmitting pseudo random data by itself

8.3 RSP100 test report cover sheet / performance test data

Test report number	:	1-2977/11-94-04
Equipment model number	:	AAD-3880132-BV
Certification number	:	4170B-A3880132
Manufacturer (complete address)	:	Sony Ericsson Mobile Communications AB Nya Vattentorget 22188 Lund / SWEDEN
Tested to radio standards specification no.	:	RSS 210, Issue 8, Annex 8
Open area test site IC No.	:	IC 3462C-1
Frequency range	:	ISM band 2400 MHz to 2483.5 MHz (lowest channel 2402 MHz, highest channel 2480 MHz)
RF-power [W] (max.)	:	Cond.: 6.04 mW (GFSK modulation) EIRP: 3.05 mW (GFSK modulation) Cond.: 5.65 mW (Pi/4-DQPSK modulation) EIRP: 2.86 mW (Pi/4-DQPSK modulation) Cond.: 6.47 mW (8DPSK modulation) EIRP: 3.27 mW (8DPSK modulation)
Occupied bandwidth (99%-BW) [kHz]	:	1028 (GFSK modulation) 1335 (Pi/4-DQPSK modulation) 1317 (8DPSK modulation)
Type of modulation	:	FHSS technology with GFSK, Pi/4 DQPSK and 8 DPSK modulation.
Emission designator (TRC-43)	:	1M03FXD (GFSK modulation) 1M34GXD (Pi/4-DQPSK modulation) 1M32GXD (8DPSK modulation)
Antenna information	:	Integrated PCB antenna
Transmitter spurious (worst case) [dBµV/m @ 3m]:		45 @ 12.05 GHz (noise floor)
Receiver spurious (worst case) [dBµV/m @ 3m]:		44 @ 12.05 GHz (noise floor)

ATTESTATION:

DECLARATION OF COMPLIANCE:

I attest that the testing was performed or supervised by me; that the test measurements were made in accordance with the above-mentioned Industry Canada standard(s); and that the equipment identified in this application has been subjected to all the applicable test conditions specified in the Industry Canada standards and all of the requirements of the standard have been met.

Laboratory manager:

2012-01-10

Marco Bertolino

Date

Name

Signature

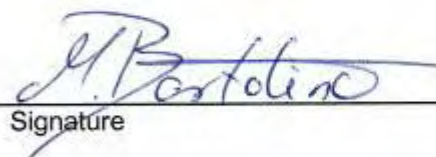

9 Measurement results

9.1 Antenna gain

Measurement:

The antenna gain of the complete system is calculated by the difference of radiated power in EIRP and the conducted power of the module. For normal Bluetooth[®] devices, the GFSK modulation is used.

Measurement parameters:

Measurement parameter	
Detector:	Peak
Sweep time:	Auto
Video bandwidth:	3 MHz
Resolution bandwidth:	3 MHz
Span:	5 MHz
Trace-Mode:	Max hold

Limits:

FCC	IC
CFR Part 15.247 (b)(4)	RSS 210, Issue 8, A 8.4(2)
Antenna Gain	
6 dBi	

Results:

T _{nom}	V _{nom}	lowest channel 2402 MHz	middle channel 2441 MHz	highest channel 2480 MHz
Conducted power [dBm] Measured with GFSK modulation		7.84	8.62	8.47
Radiated power [dBm] Measured with GFSK modulation		3.94	4.11	4.85
Gain [dBi] Calculated		-3.90	-4.51	-3.62

Result: The result of the measurement is passed.

9.2 Power spectral density

Description:

Measurement of the power spectral density of a digital modulated system. This requirement is only valid for digitally modulated systems without hopping functionality.

Measurement:

Measurement parameter	
Detector:	Peak
Sweep time:	500 s
Video bandwidth:	3 kHz
Resolution bandwidth:	3 kHz
Span:	150 kHz
Trace-Mode:	Max Hold

Limits:

FCC	IC
CFR Part 15.247 (e)	RSS 210, Issue 8, A 8.2(b)
Power Spectral Density	
For digitally modulated systems the transmitter power spectral density conducted from the transmitter to the antenna shall not be greater than 8 dBm in any 3 kHz band during any time interval of continuous transmission or over 1.0 second if the transmission exceeds 1.0-second duration.	

Results:

Modulation	Power spectral density [dBm/3kHz]		
	2412 MHz	2437 MHz	2462 MHz
Frequency			
GFSK	Not required for hopping systems!		
Pi/4 DQPSK			
8DPSK			
Measurement uncertainty	± 1.5 dB		

9.3 Carrier frequency separation

Description:

Measurement of the carrier frequency separation of a hopping system. The carrier frequency separation is constant for all modulation-modes. We use GFSK-modulation to show compliance. EUT in hopping mode.

Measurement:

Measurement parameter	
Detector:	Peak
Sweep time:	Auto
Video bandwidth:	100 kHz
Resolution bandwidth:	100 kHz
Span:	4 MHz
Trace-Mode:	Max Hold

Limits:

FCC	IC
CFR Part 15.247 (a)(1)	RSS 210, Issue 8, A 8.1(b)
Carrier Frequency Separation	
Minimum 25 kHz or two-thirds of the 20 dB bandwidth of the hopping system whichever is greater.	

Result:

Carrier frequency separation	~ 1 MHz
------------------------------	---------

Result: [The result of the measurement is passed.](#)

Plot:

Plot 1: Carrier frequency separation (GFSK modulation)

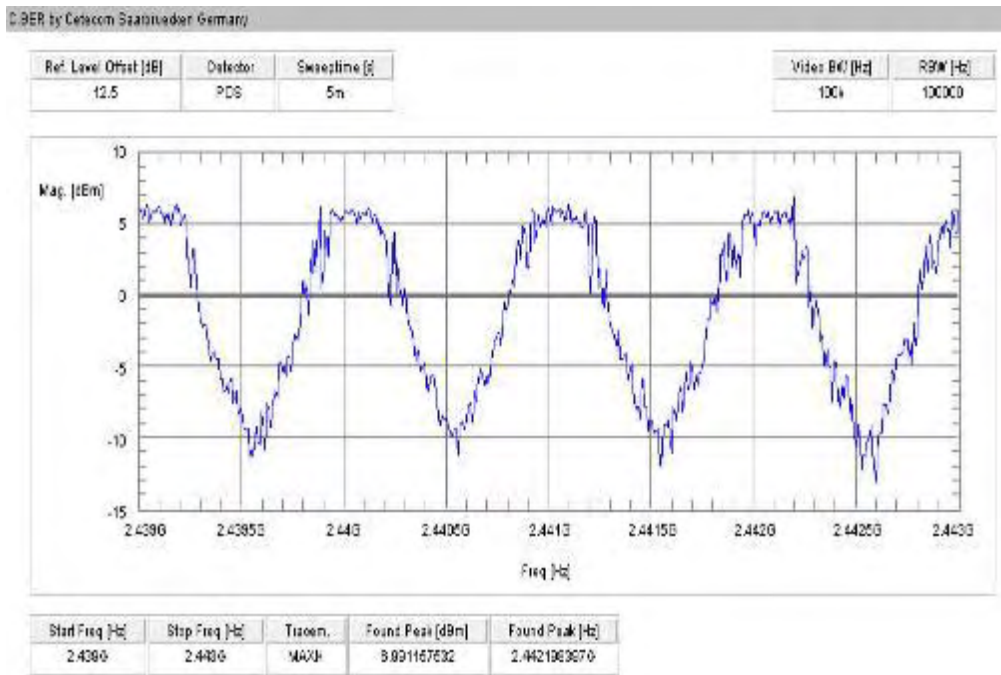

9.4 Number of hopping channels

Description:

Measurement of the total number of used hopping channels. The number of hopping channels is constant for all modulation-modes. We use GFSK-modulation to show compliance. EUT in hopping mode.

Measurement:

Measurement parameter	
Detector:	Peak
Sweep time:	Auto
Video bandwidth:	500 kHz
Resolution bandwidth:	500 kHz
Span:	Plot 1: 2400 – 2445 MHz Plot 2: 2445 – 2485 MHz
Trace-Mode:	Max Hold

Limits:

FCC	IC
CFR Part 15.247 (a)(1)	RSS 210, Issue 8, A 8.1(d)
Number of hopping channels	
At least 15 non overlapping hopping channels	

Result:

Number of hopping channels	79
----------------------------	----

Result: The result of the measurement is passed.

Plots:

Plot 1: Number of hopping channels (GFSK modulation)

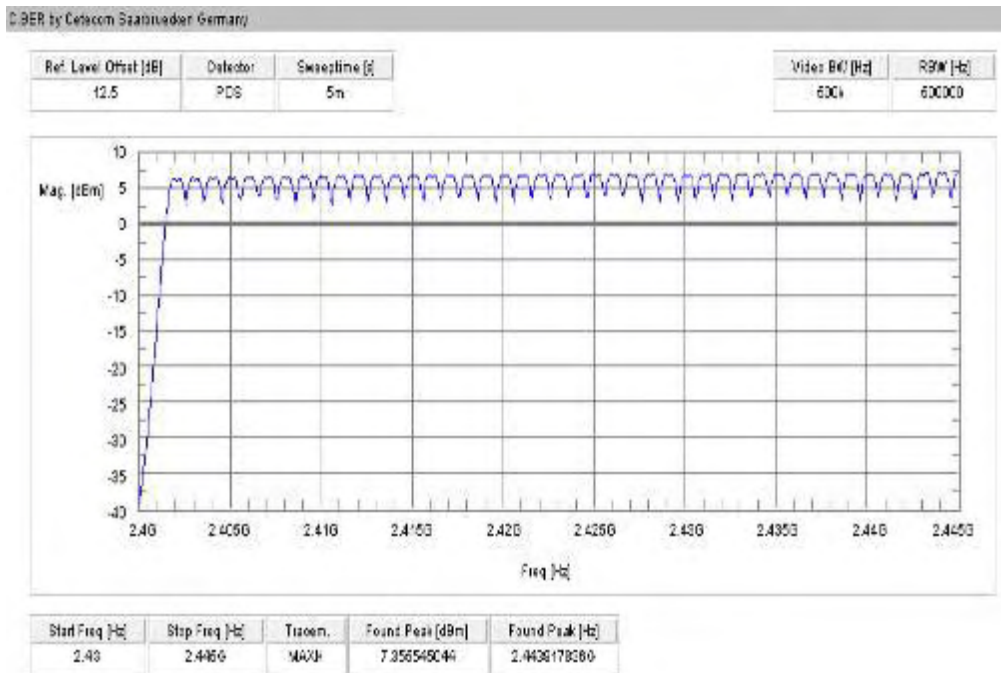

Plot 2: Number of hopping channels (GFSK modulation)

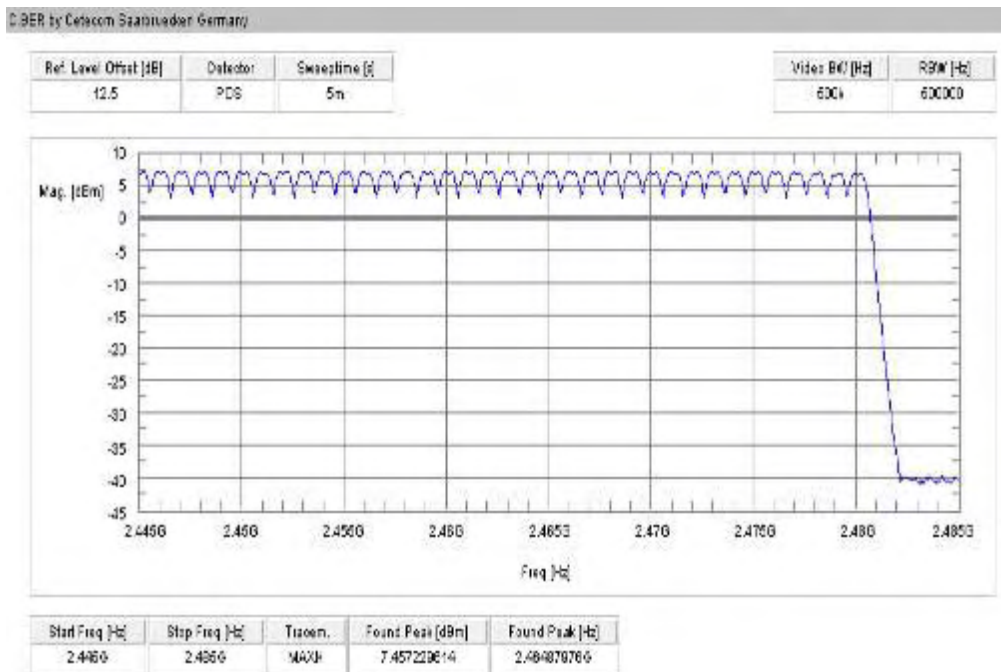

9.5 Time of occupancy (dwell time)

Measurement:

For Bluetooth® devices no measurements mandatory depending on the fixed requirements according to the Bluetooth® Core Specifications!

For Bluetooth® devices:

The channel staying time of 0.4 s within a 31.6 second period in data mode is constant for Bluetooth® devices and independent from the packet type (packet length). The calculation for a 31.6 second period is as follows:

Channel staying time = time slot length * hop rate / number of hopping channels * 31.6 s

Example for a DH1 packet (with a maximum length of one time slot)
 Channel staying time = $625 \mu\text{s} * 1600 * 1/\text{s} / 79 * 31.6 \text{ s} = 0.4 \text{ s}$ (in a 31.6 s period)

For multi-slot packets the hopping is reduced according to the length of the packet.

Example for a DH3 packet (with a maximum length of three time slots)
 Channel staying time = $3 * 625 \mu\text{s} * 1600/3 * 1/\text{s} / 79 * 31.6 \text{ s} = 0.4 \text{ s}$ (in a 31.6 s period)

Example for a DH5 packet (with a maximum length of five time slots)
 Channel staying time = $5 * 625 \mu\text{s} * 1600/5 * 1/\text{s} / 79 * 31.6 \text{ s} = 0.4 \text{ s}$ (in a 31.6 s period)

This is according to the Bluetooth® Core Specification V2.0 & V2.1 & V3.0 & V4.0 (+ critical errata) for all Bluetooth® devices.

The following table shows the relations:

Packet Size	Pulse Width [ms] *	Max. number of transmissions per channel in 31.6 sec
DH1	0.366	640
DH3	1.622	214
DH5	2.870	128

* according to Bluetooth® specification

Results:

Packet Size	Pulse Width [ms]*	Max. number of transmissions in 31.6 sec	Dwell time [Pulse width * Number of transmissions]
DH1	0.366	640	234.2 ms
DH3	1.622	214	347.1 ms
DH5	2.870	128	367.4 ms

Limits:

FCC	IC
CFR Part 15.247 (a)(1)(iii)	RSS 210, Issue 8, A 8.3(1)
Time of occupancy (dwell time)	
The frequency hopping operation shall have an average time of occupancy on any frequency not exceeding 0.4 seconds within a duration in seconds equal to the number of hopping frequencies multiplied by 0.4.	

Result: The result of the measurement is passed.

9.6 Spectrum bandwidth of a FHSS system – 20 dB bandwidth

Description:

Measurement of the 20dB bandwidth of the modulated signal. The measurement is performed according to the “Measurement Guidelines” (DA 00-705, March 30, 2000). EUT in single channel mode.

Measurement:

Measurement parameter	
Detector:	Peak
Sweep time:	2 s
Video bandwidth:	30 kHz
Resolution bandwidth:	10 kHz
Span:	3 MHz
Trace-Mode:	Max Hold

Limits:

FCC	IC
CFR Part 15.247 (a)(1)	RSS 210, Issue 8, A 8.2(a)
Spectrum bandwidth of a FHSS system – 20 dB bandwidth	
GFSK < 1500 kHz Pi/4 DQPSK < 1500 kHz 8DPSK < 1500 kHz	

Results:

Modulation	20 dB BANDWIDTH [kHz]		
	2402 MHz	2441 MHz	2480 MHz
Frequency			
GFSK	956	1028	956
Pi/4 DQPSK	1335	1335	1335
8DPSK	1335	1317	1335
Measurement uncertainty	± 10 kHz		

Result: The result of the measurement is passed.

Plots:

Plot 1: lowest channel – 2402 MHz, GFSK modulation

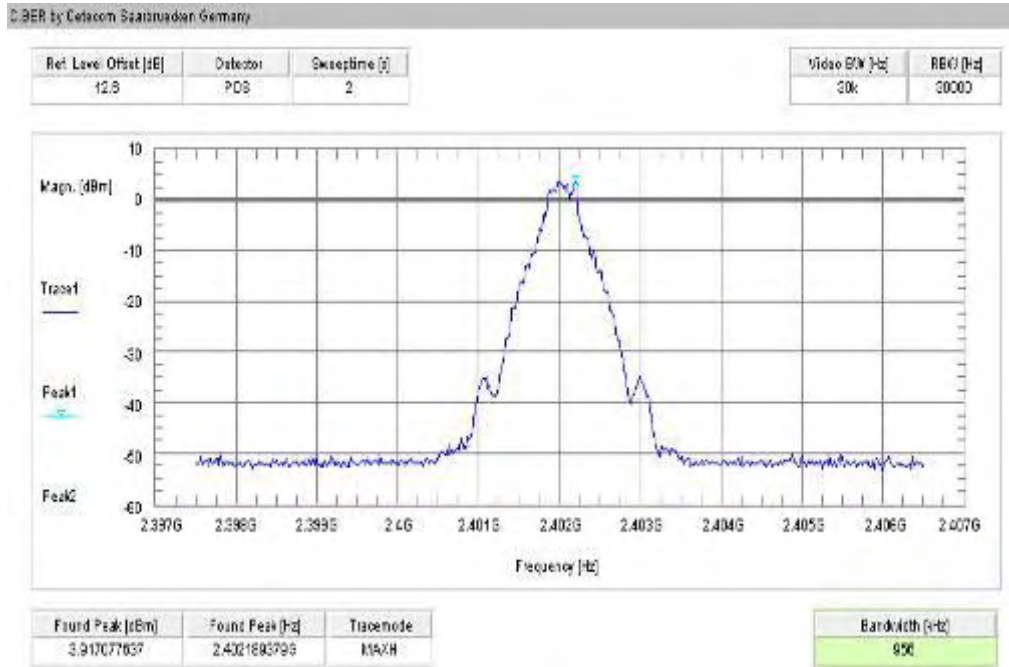

Plot 2: middle channel – 2441 MHz, GFSK modulation

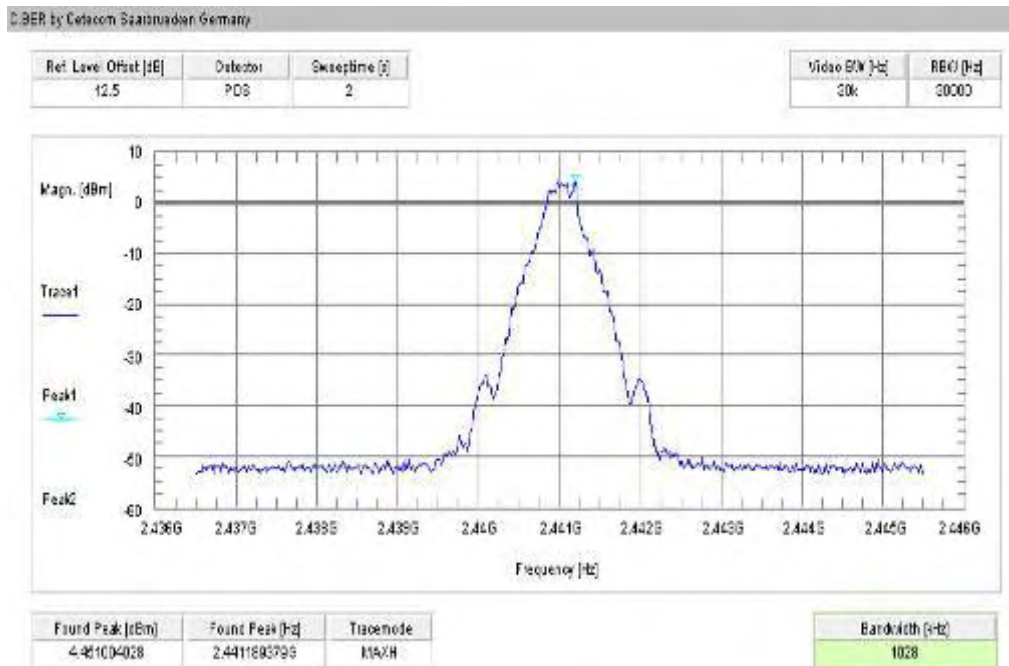

Plot 3: highest channel – 2480 MHz, GFSK modulation

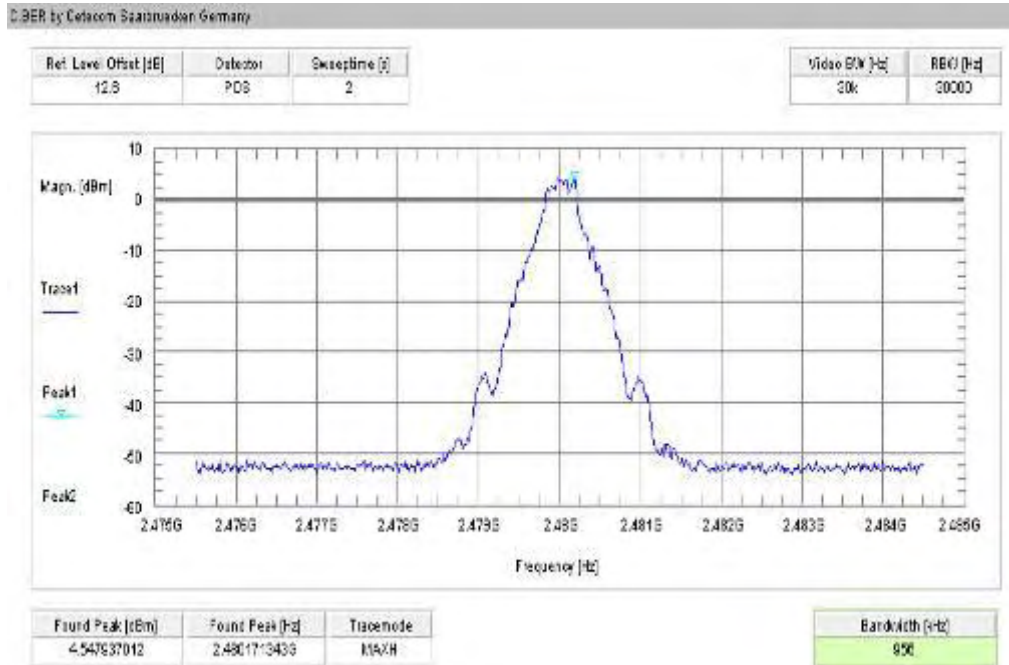

Plot 4: lowest channel – 2402 MHz, Pi / DQPSK modulation

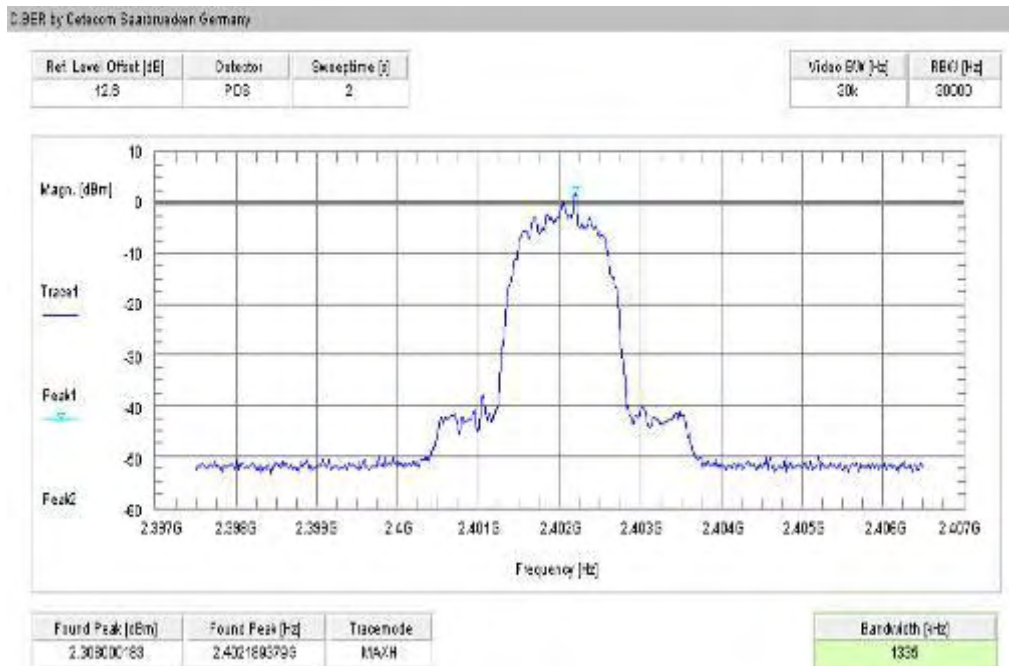

Plot 5: middle channel – 2441 MHz, Pi / DQPSK modulation

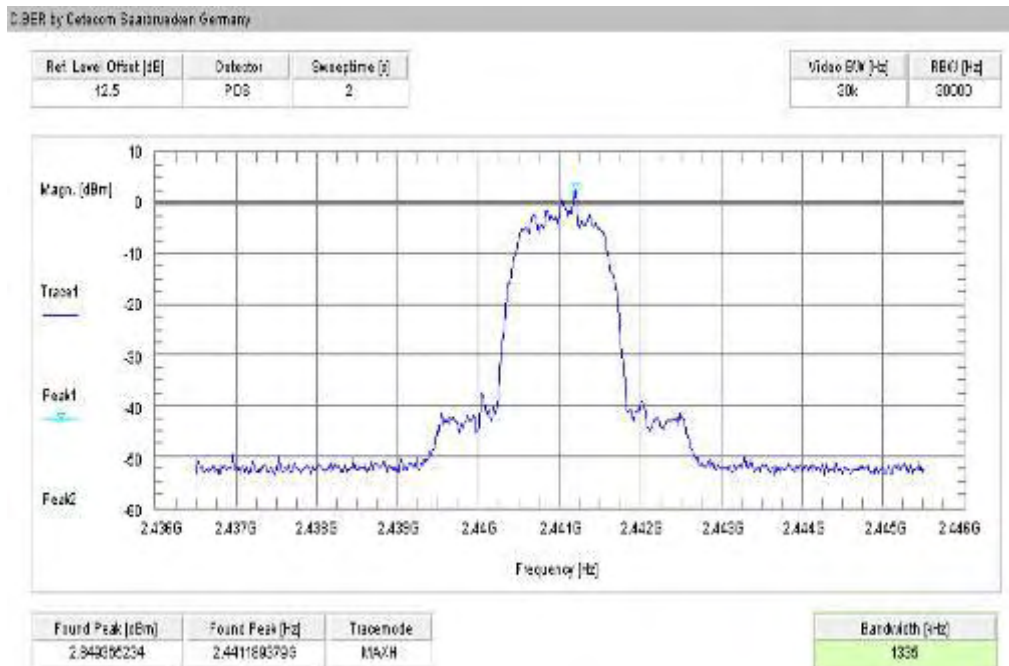

Plot 6: highest channel – 2480 MHz, Pi / DQPSK modulation

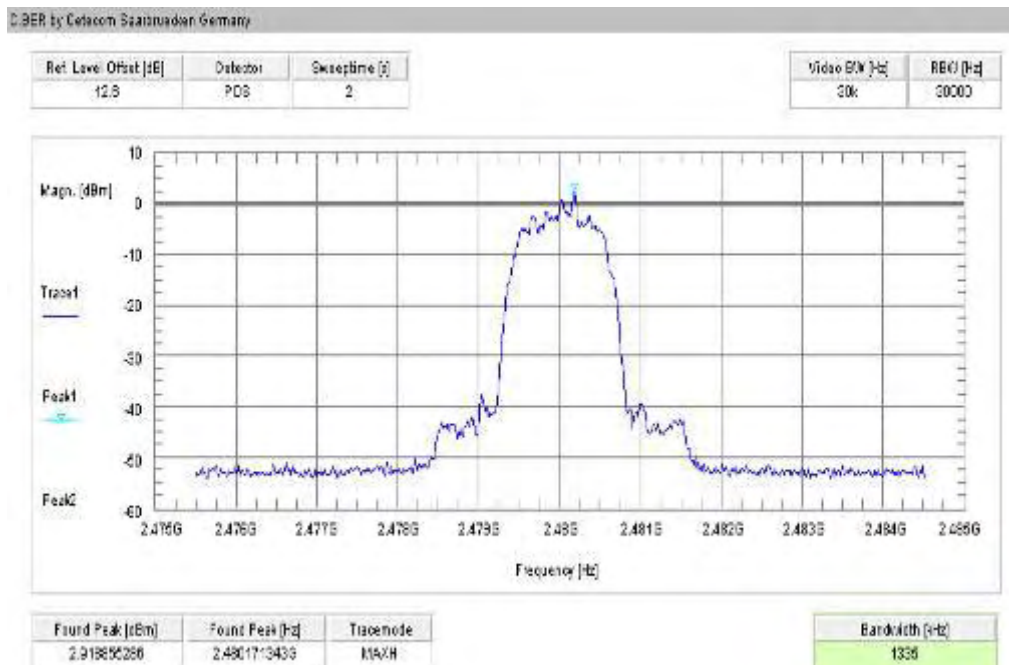

Plot 7: lowest channel – 2402 MHz, 8 DPSK modulation

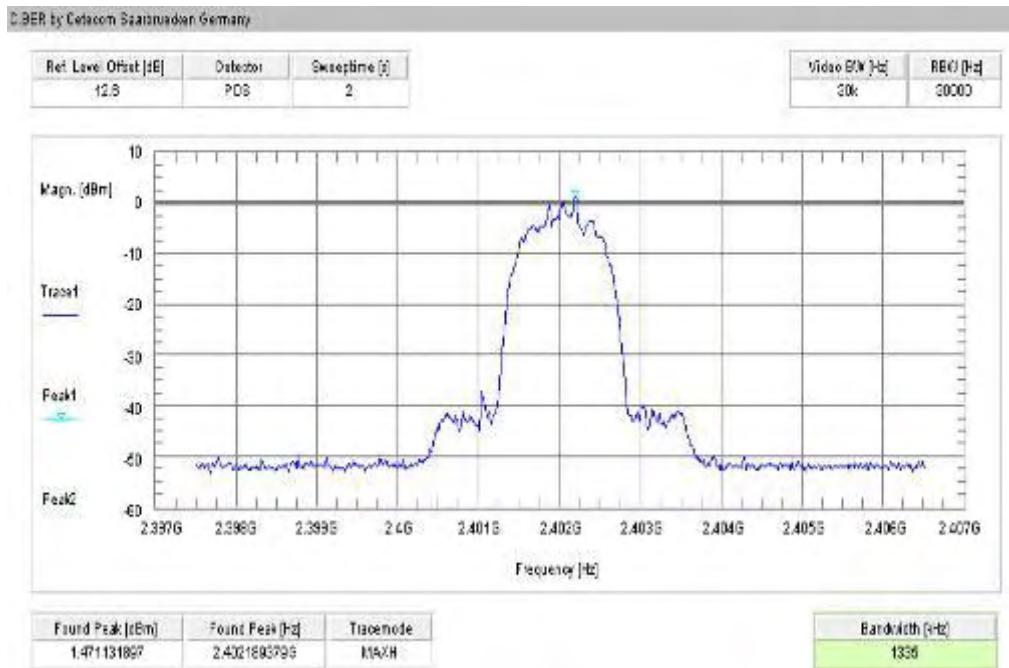

Plot 8: middle channel – 2441 MHz, 8 DPSK modulation

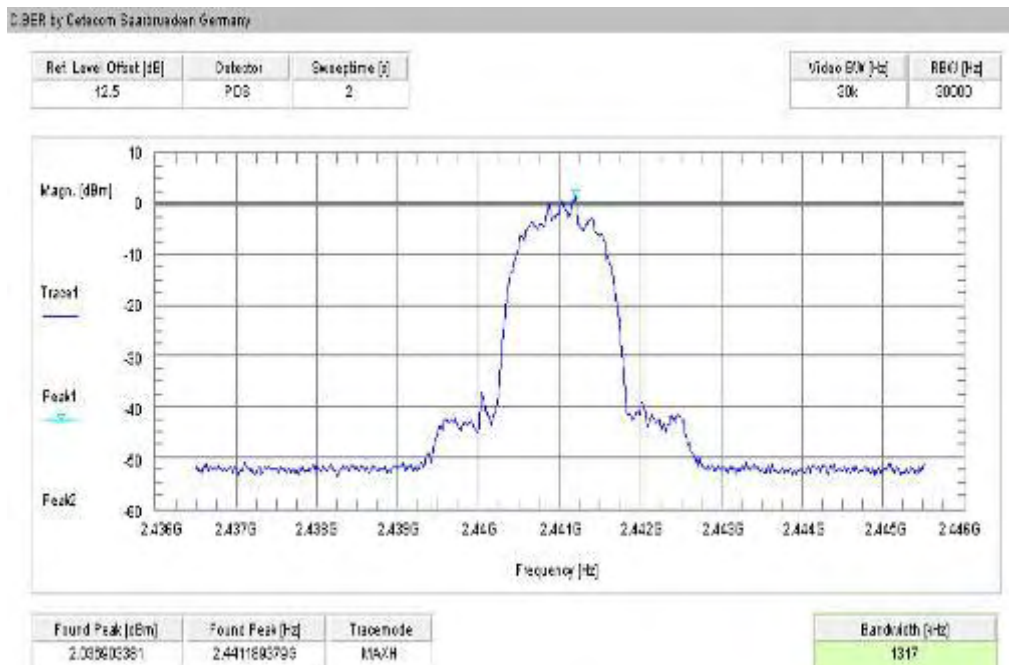

Plot 9: highest channel – 2480 MHz, 8 DPSK modulation

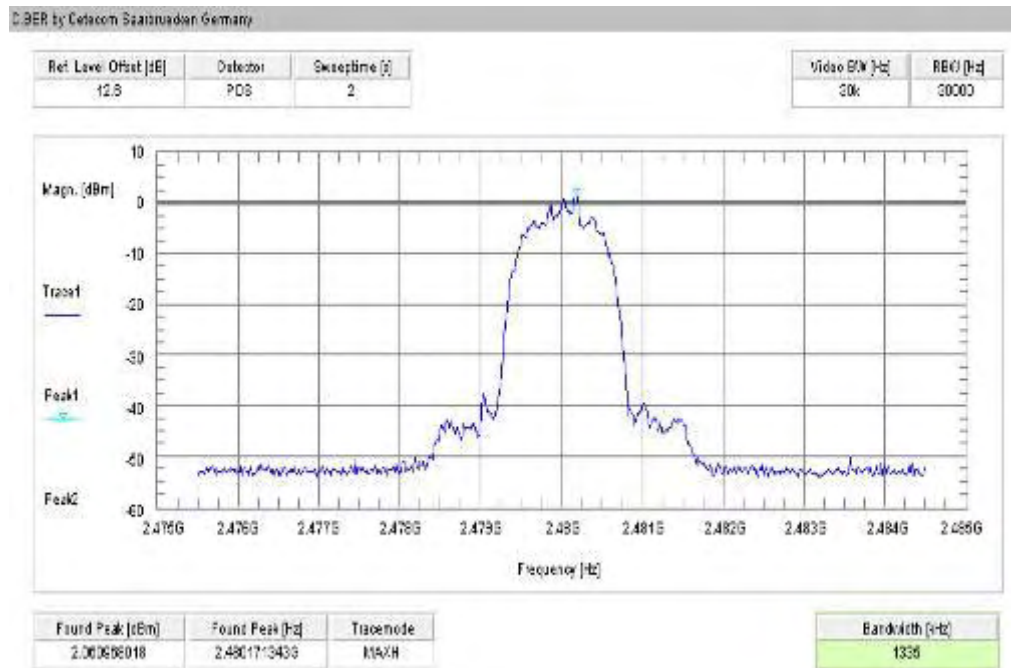

9.7 Maximum output power

Description:

Measurement of the maximum output power conducted and radiated. EUT in single channel mode.

Measurement:

Measurement parameter	
Detector:	Peak
Sweep time:	Auto
Video bandwidth:	3 MHz
Resolution bandwidth:	3 MHz
Span:	3 MHz
Trace-Mode:	Max Hold

Limits:

FCC	IC
CFR Part 15.247 (b)(1)	RSS 210, Issue 8, A 8.4(2)
Maximum output power	
[Conducted: 0.125 W – antenna gain max. 6 dBi] Systems using more than 75 hopping channels: Conducted: 1.0 W – antenna gain max. 6 dBi	

Results:

Modulation Frequency	Maximum output power conducted [dBm]		
	2402 MHz	2441 MHz	2480 MHz
GFSK	7.12	7.75	7.81
Pi/4 DQPSK	6.86	7.51	7.52
8DPSK	7.41	7.97	8.11
Measurement uncertainty	± 1 dB		

Result: The result of the measurement is passed.

Results:

Modulation Frequency	Maximum output power radiated - EIRP [dBm]		
	2402 MHz	2441 MHz	2480 MHz
GFSK	3.94	4.11	4.85
Pi/4 DQPSK *)	3.68	3.87	4.56
8DPSK *)	4.23	4.33	5.15
Measurement uncertainty	± 3 dB		

*) - Values calculated with antenna gain

Result: The result of the measurement is passed.

Plots:

Plot 1: lowest channel – 2402 MHz, GFSK modulation

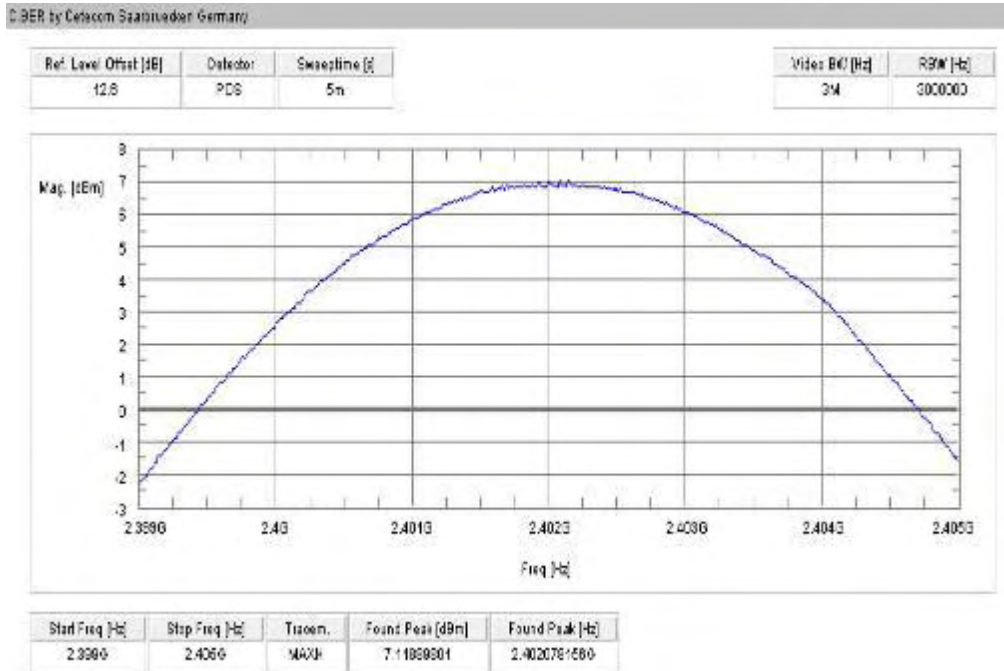

Plot 2: middle channel – 2441 MHz, GFSK modulation

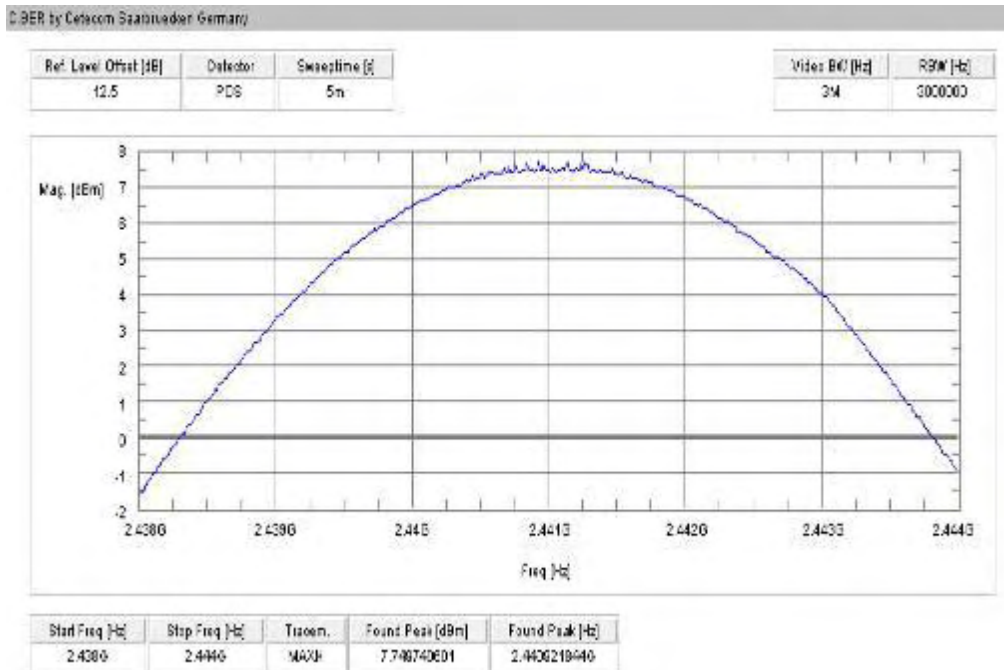

Plot 3: highest channel – 2480 MHz, GFSK modulation

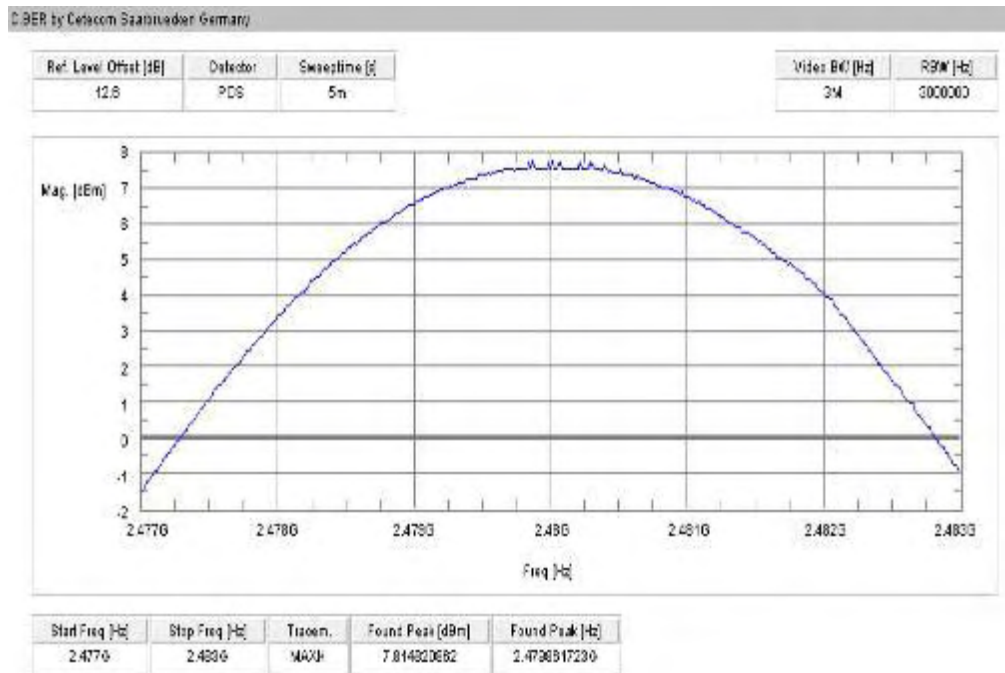

Plot 4: lowest channel – 2402 MHz, Pi / DQPSK modulation

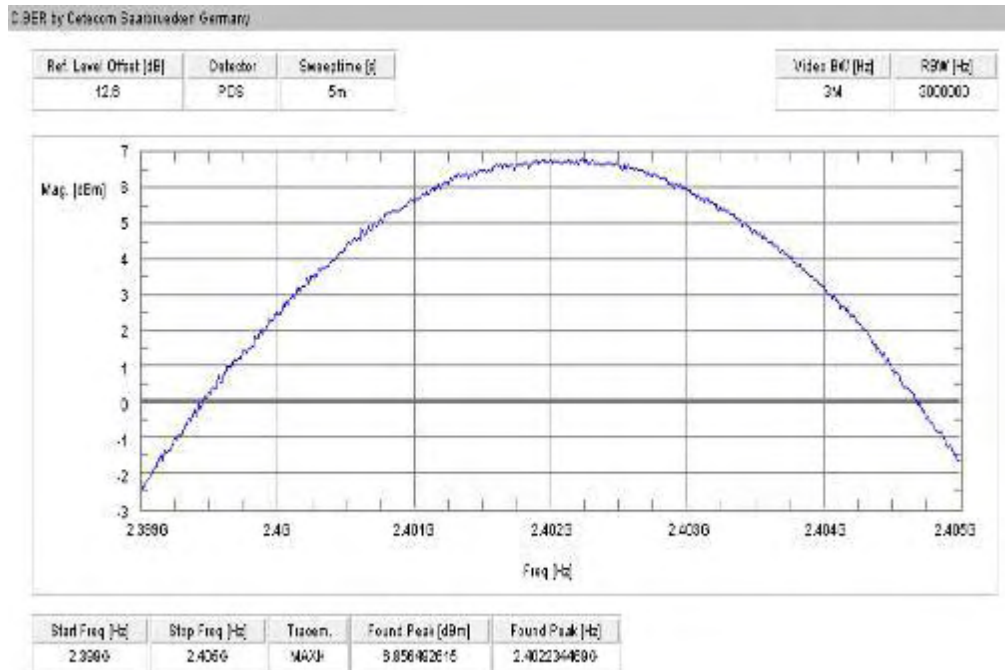

Plot 5: middle channel – 2441 MHz, Pi / DQPSK modulation

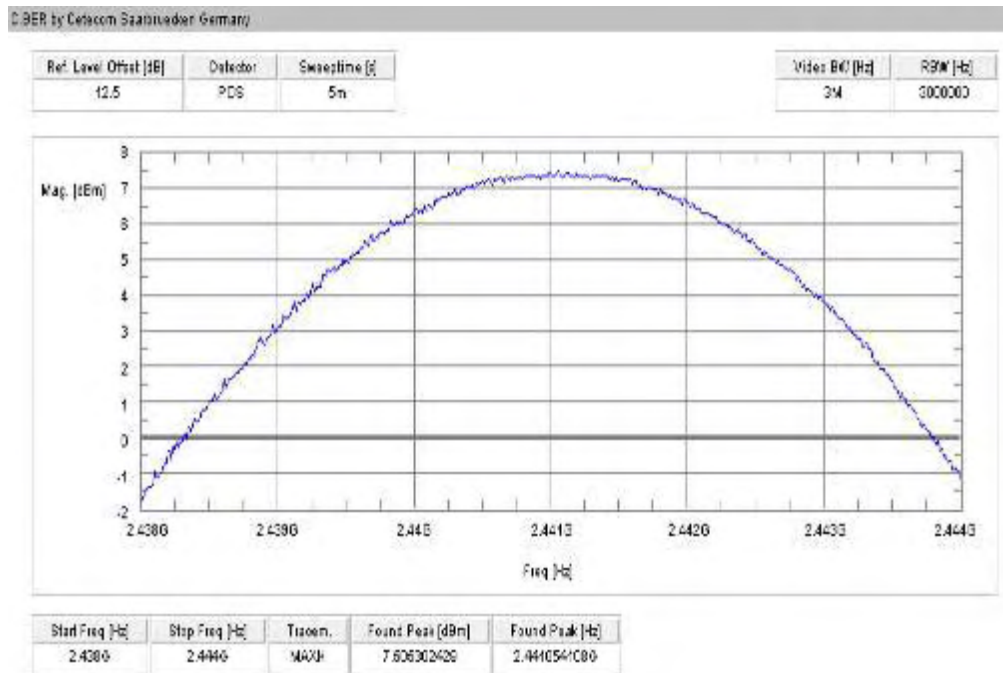

Plot 6: highest channel – 2480 MHz, Pi / DQPSK modulation

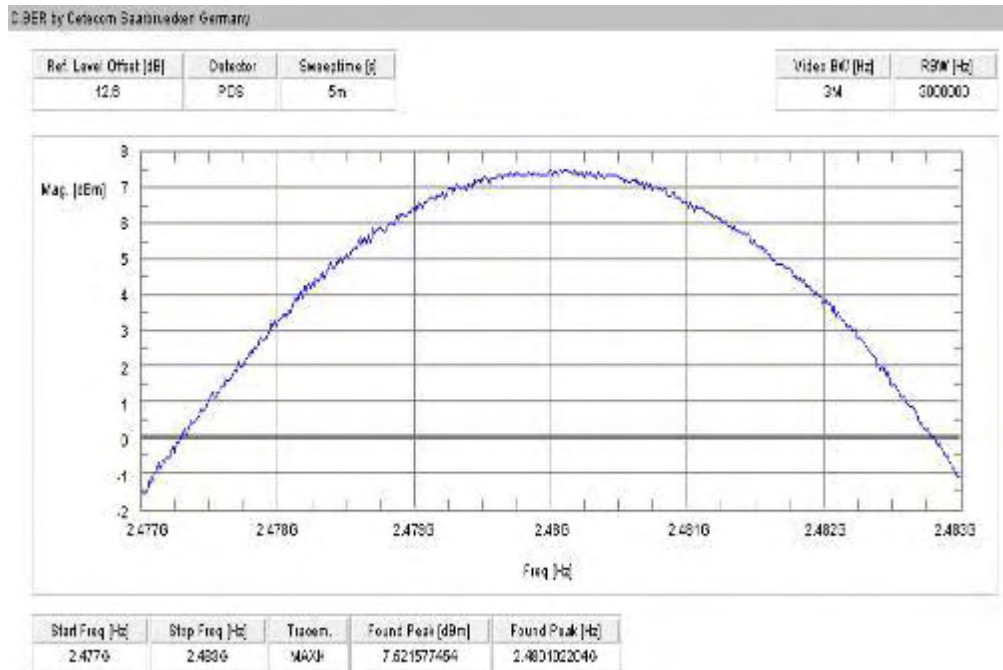

Plot 7: lowest channel – 2402 MHz, 8 DPSK modulation

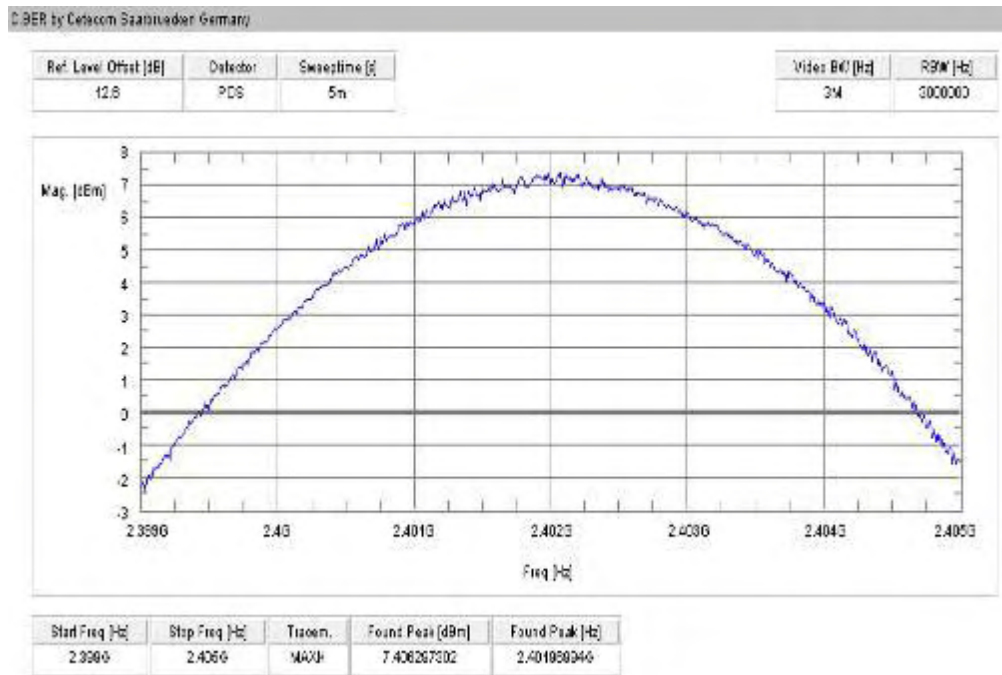

Plot 8: middle channel – 2441 MHz, 8 DPSK modulation

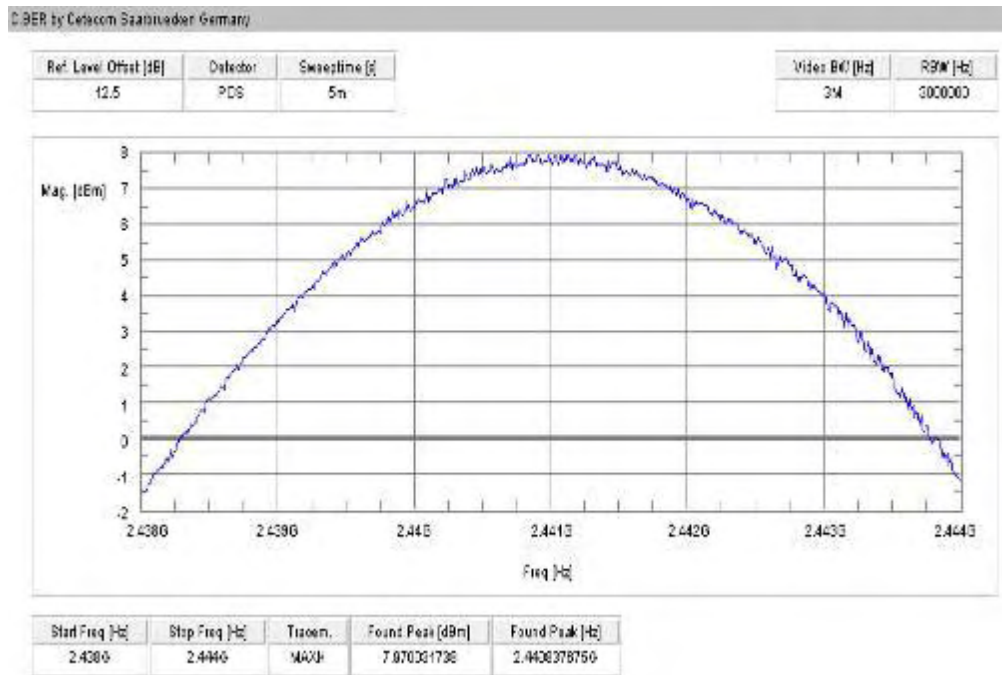

Plot 9: highest channel – 2480 MHz, 8 DPSK modulation

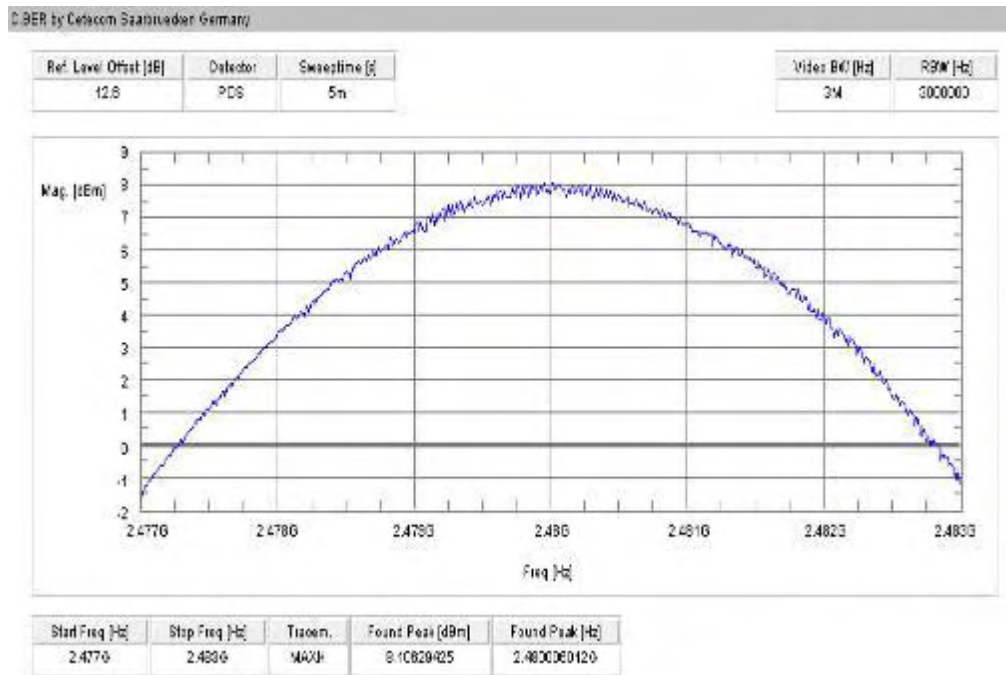

9.8 Band edge compliance conducted

Description:

Measurement of the conducted band edge compliance. EUT is measured at the lower and upper band edge in single channel and hopping mode. The measurement is repeated for all modulations.

Measurement:

Measurement parameter	
Detector:	Peak
Sweep time:	Auto
Video bandwidth:	100 kHz
Resolution bandwidth:	100 kHz
Span:	Lower Band Edge: 2395 – 2405 MHz higher Band Edge: 2478 – 2489 MHz
Trace-Mode:	Max Hold

Limits:

FCC	IC
CFR Part 15.247 (d)	RSS 210, Issue 8, A 8.5
Band edge compliance conducted	
<p>In any 100 kHz bandwidth outside the frequency band in which the spread spectrum or digitally modulated intentional radiator is operating, the radio frequency power that is produced by the intentional radiator shall be at least 20 dB below that in the 100 kHz bandwidth within the band that contains the highest level of the desired power, based on either an RF conducted or a radiated measurement. Attenuation below the general limits specified in Section 15.209(a) is not required.</p>	

Results:

Scenario Modulation	Band edge compliance conducted [dB]		
	GFSK	Pi/4 DQPSK	8DPSK
Lower band edge – hopping off	> 20 dB	> 20 dB	> 20 dB
Lower band edge – hopping on	> 20 dB	> 20 dB	> 20 dB
Upper band edge – hopping off	> 20 dB	> 20 dB	> 20 dB
Upper band edge – hopping on	> 20 dB	> 20 dB	> 20 dB
Measurement uncertainty	± 1.5 dB		

Result: The result of the measurement is passed.

Plots:

Plot 1: Lower band edge – hopping on, GFSK modulation

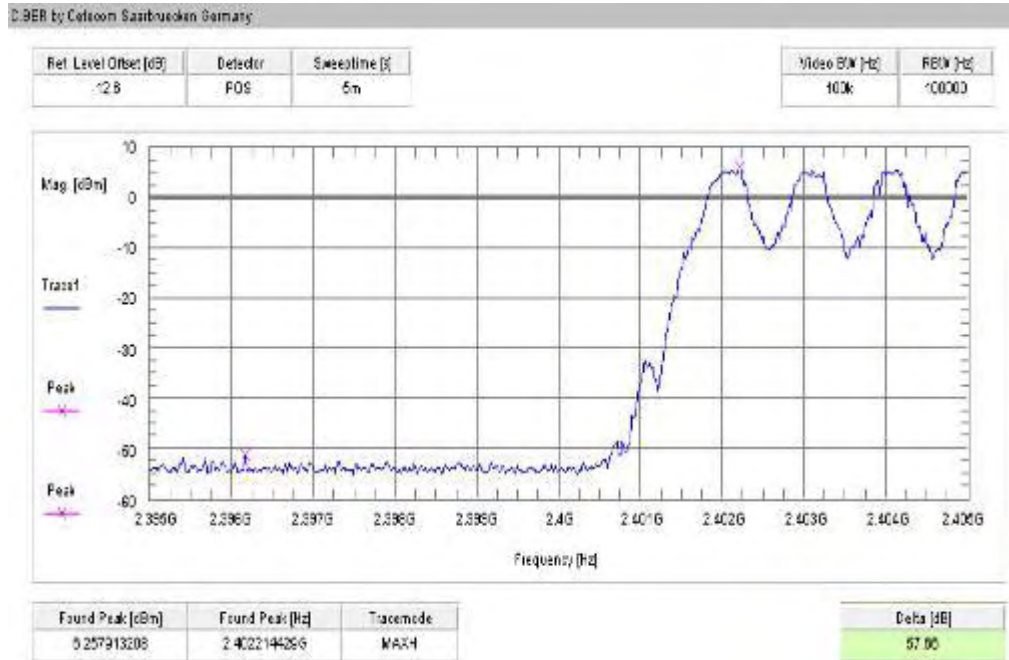

Plot 2: Upper band edge – hopping on, GFSK modulation

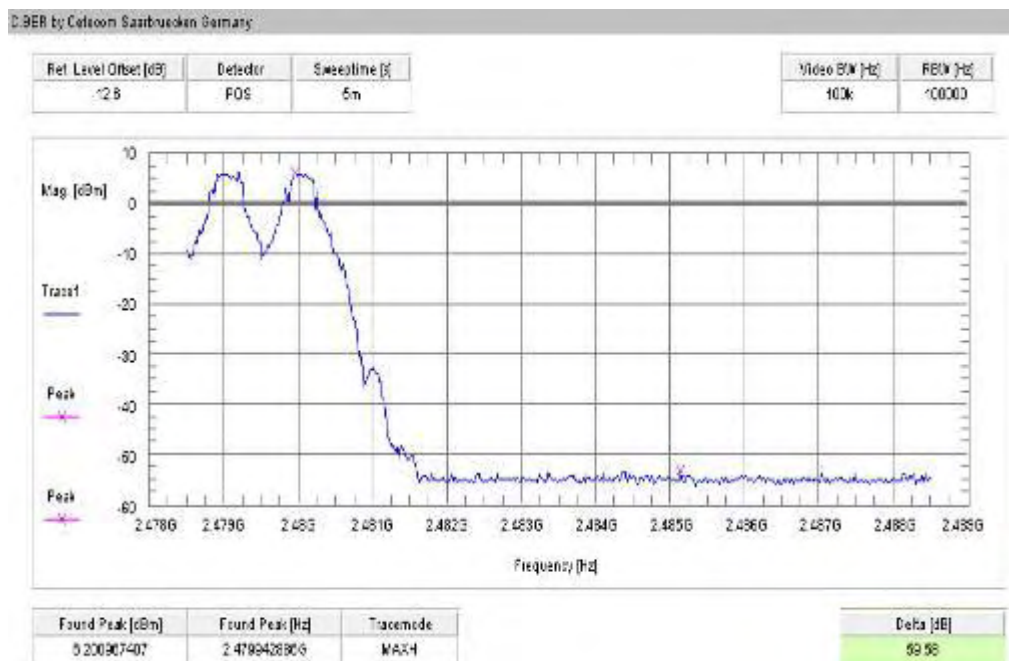

Plot 3: Lower band edge – hopping off, GFSK modulation

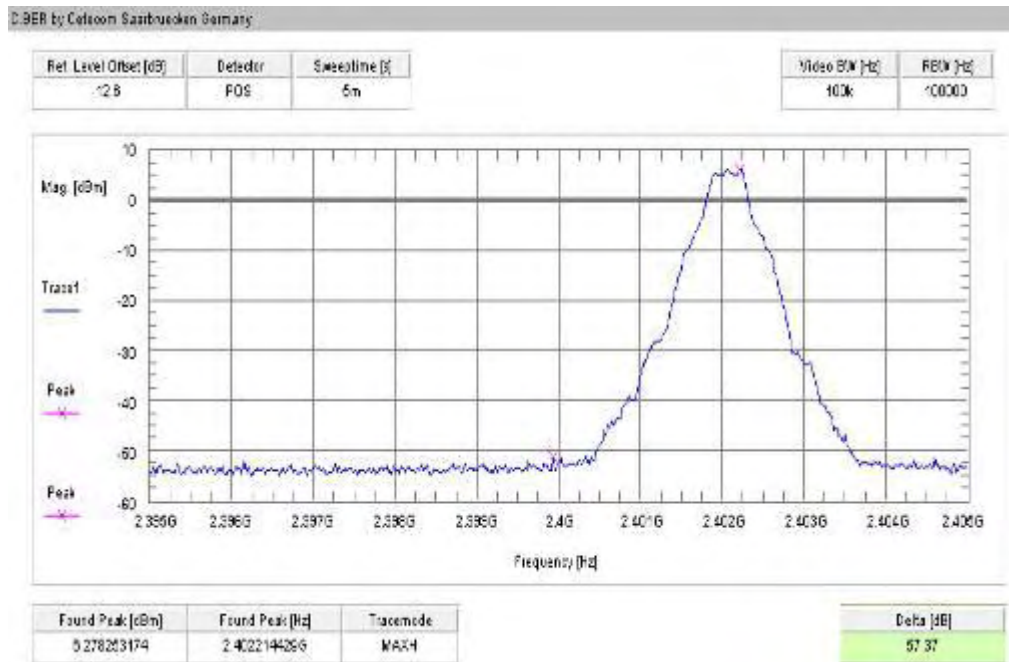

Plot 4: Upper band edge – hopping off, GFSK modulation

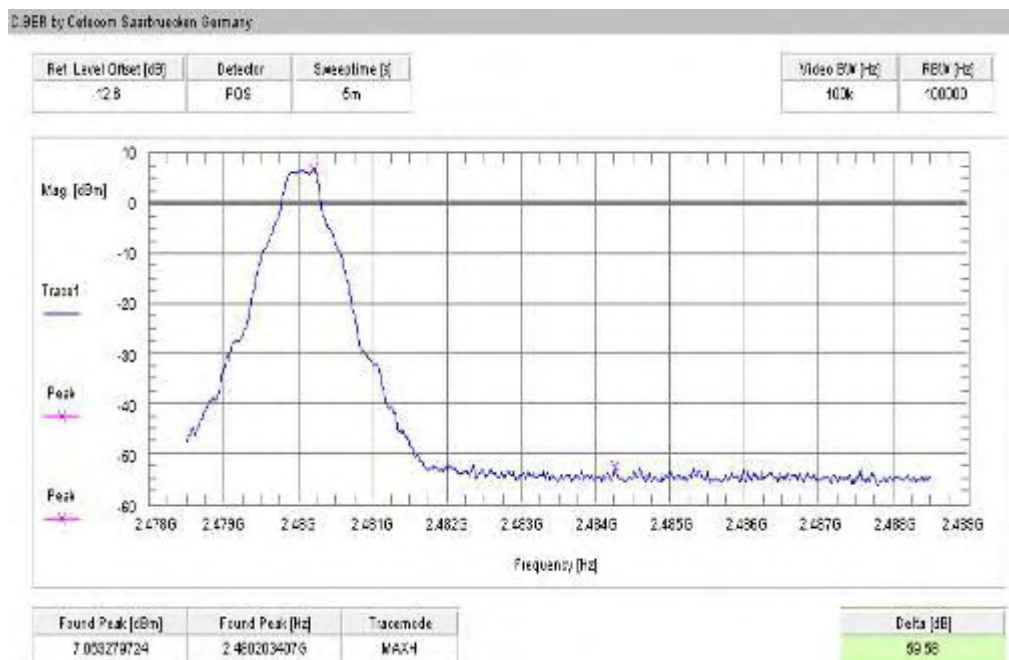

Plot 5: Lower band edge – hopping on, Pi/4 DQPSK modulation

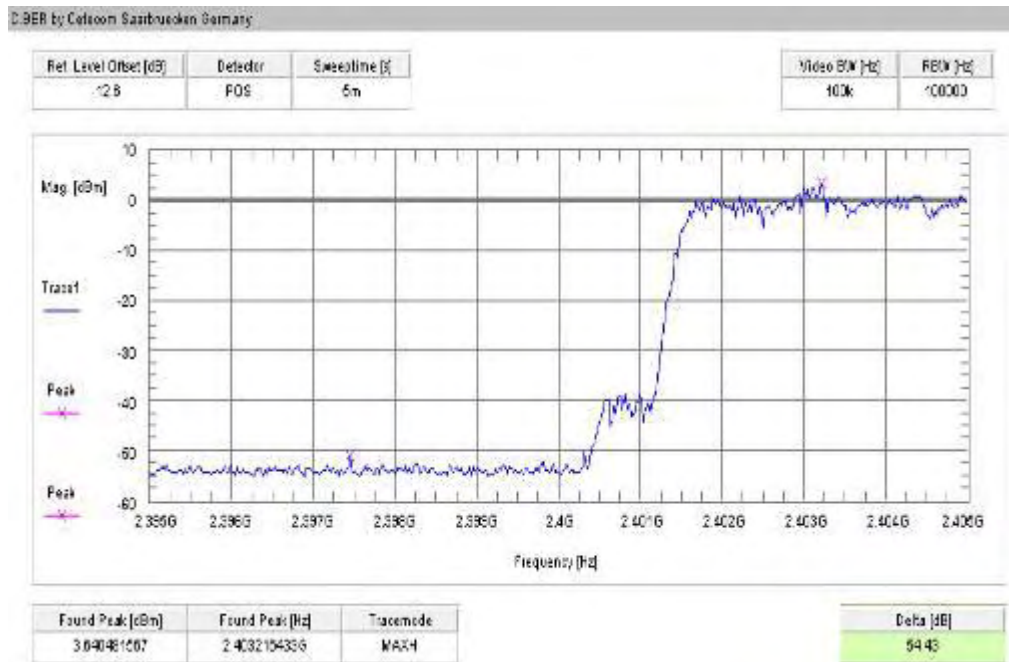

Plot 6: Upper band edge – hopping on, Pi/4 DQPSK modulation

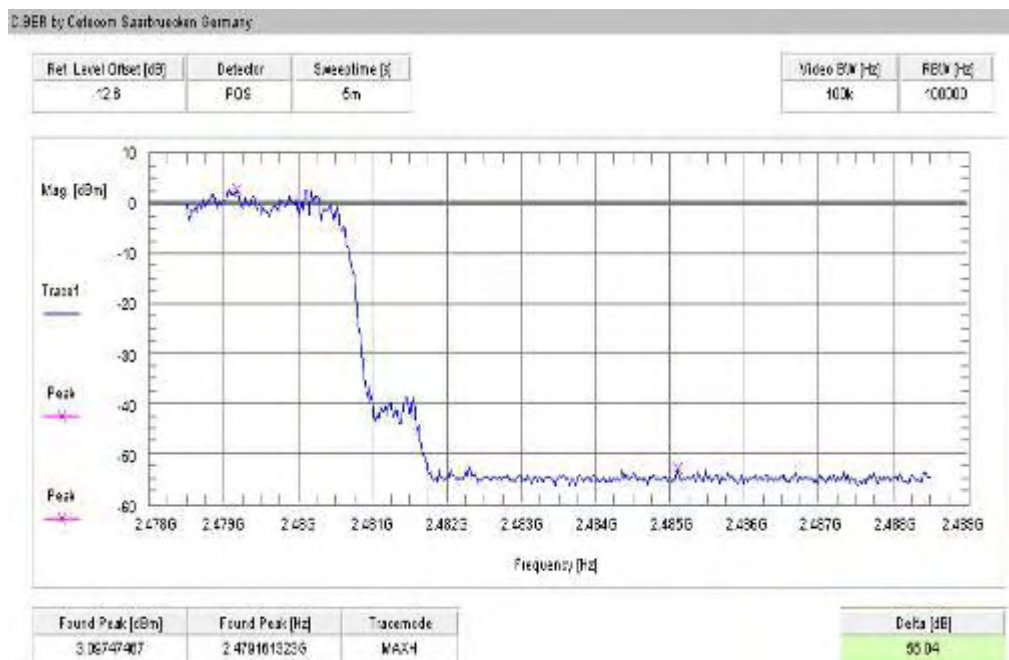

Plot 7: Lower band edge – hopping off, Pi/4 DQPSK modulation

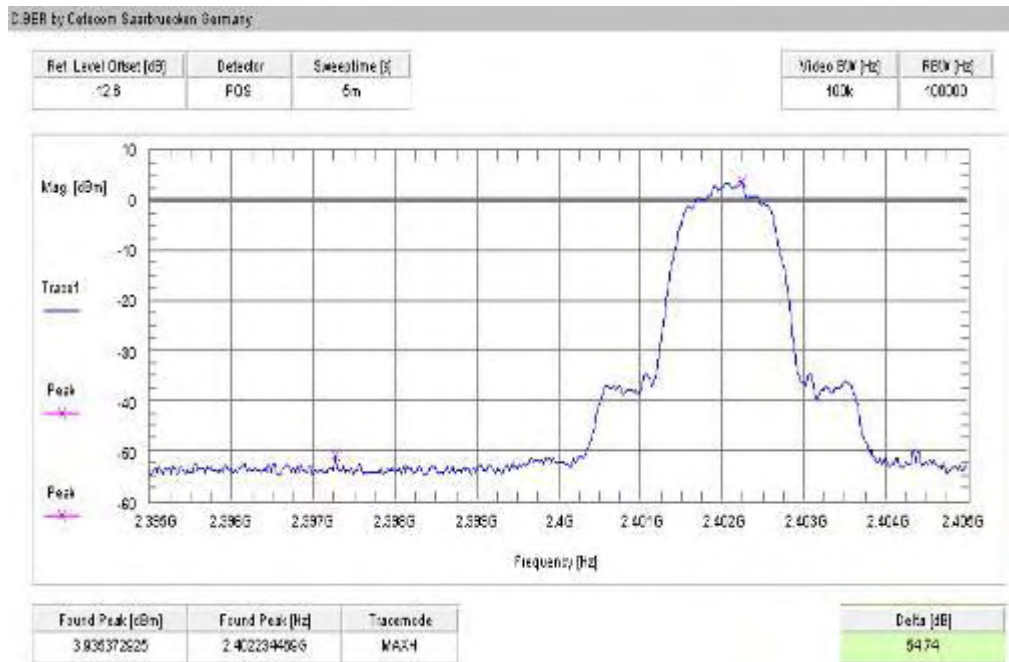

Plot 8: Upper band edge – hopping off, Pi/4 DQPSK modulation

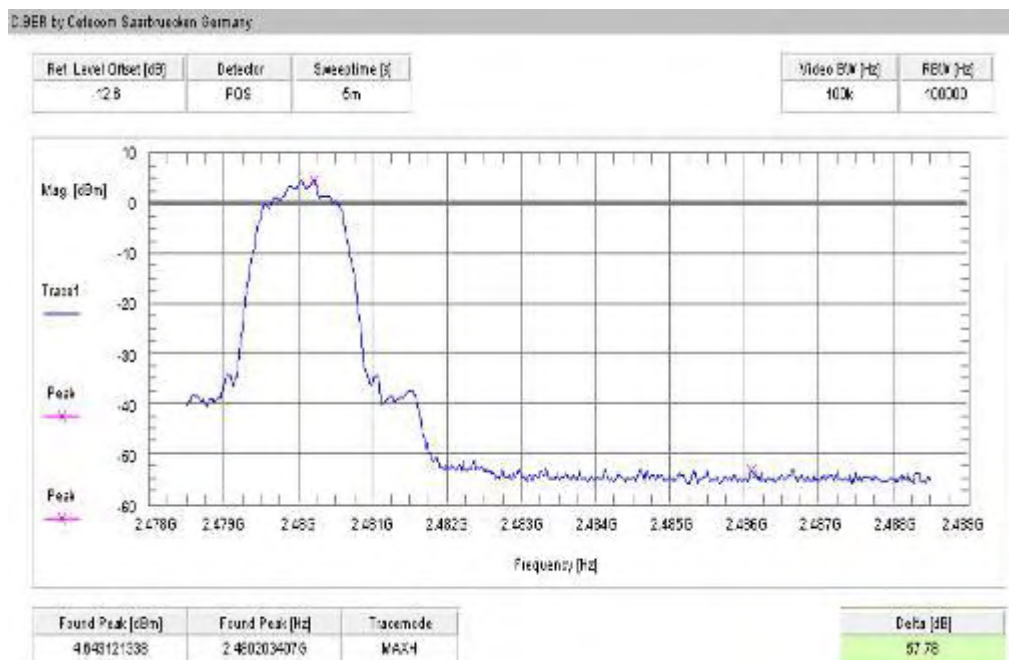

Plot 9: Lower band edge – hopping on, 8DPSK modulation

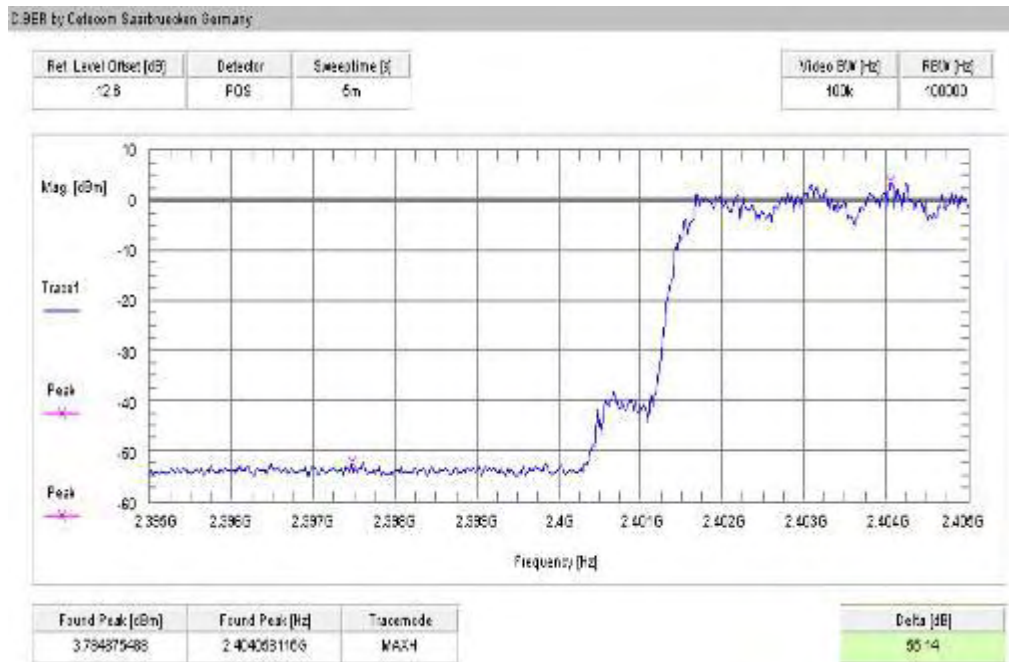

Plot 10: Upper band edge – hopping on, 8DPSK modulation

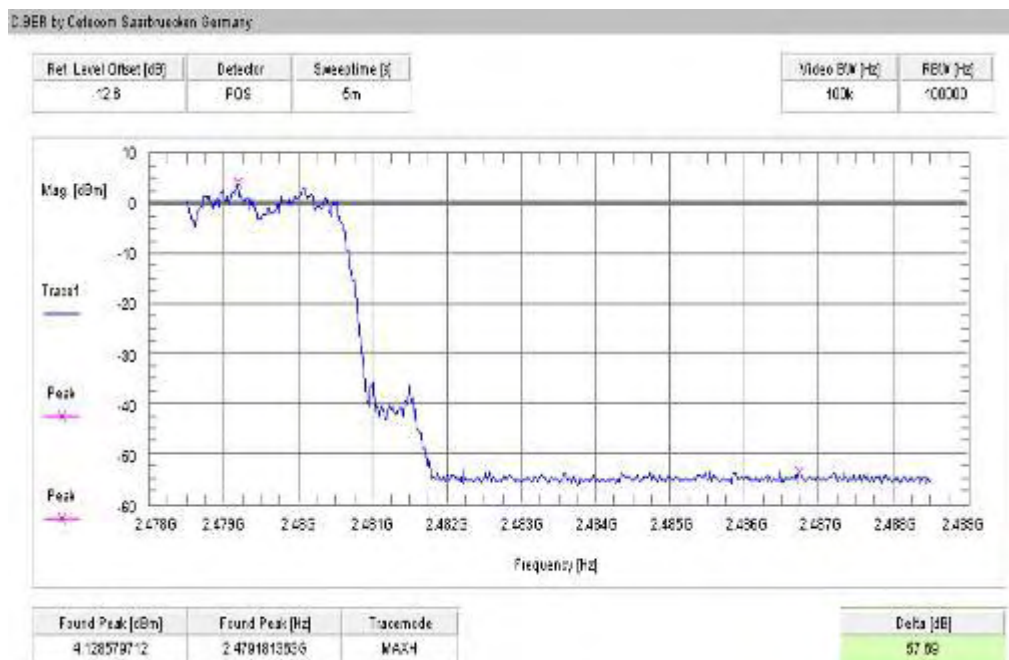

Plot 11: Lower band edge – hopping off, 8DPSK modulation

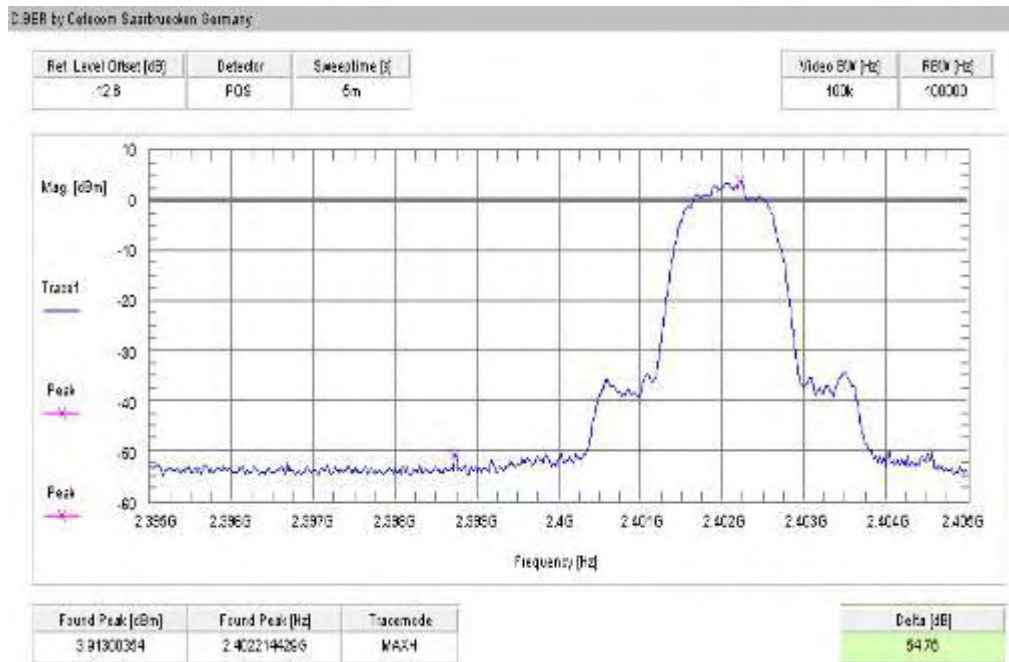

Plot 12: Upper band edge – hopping off, 8DPSK modulation

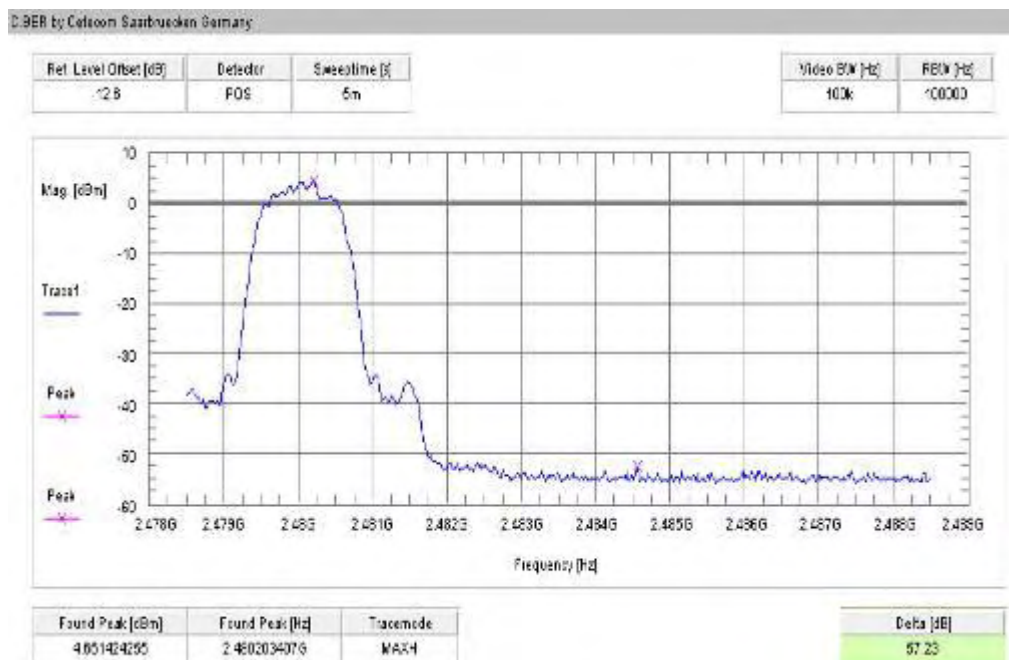

9.9 Band edge compliance radiated

Description:

Measurement of the radiated band edge compliance. The EUT is turned in the position that results in the maximum level at the band edge. Then a sweep over the corresponding restricted band is performed. The EUT is set to single channel mode and the transmit channel is channel 00 for the lower restricted band and channel 78 for the upper restricted band. The measurement is repeated for all modulations. Measurement distance is 3m.

Measurement:

Measurement parameter	
Detector:	Peak
Sweep time:	Auto
Video bandwidth:	10 Hz
Resolution bandwidth:	1 MHz
Span:	Lower Band: 2300 – 2400 MHz Higher Band: 2480 – 2500 MHz
Trace-Mode:	Max Hold

Limits:

FCC	IC
CFR Part 15.205	RSS 210, Issue 8, A 8.5
Band edge compliance radiated	
<p>In any 100 kHz bandwidth outside the frequency band in which the spread spectrum or digitally modulated intentional radiator is operating, the radio frequency power that is produced by the intentional radiator shall be at least 20 dB below that in the 100 kHz bandwidth within the band that contains the highest level of the desired power, based on either an RF conducted or a radiated measurement. Attenuation below the general limits specified in Section 15.209(a) is not required. In addition, radiated emissions which fall in the restricted bands, as defined in Section 15.205(a), must also comply with the radiated emission limits specified in Section 15.209(a) (see Section 5.205(c)).</p>	
54 dB μ V/m AVG	

Results:

Scenario	Band edge compliance radiated [dB μ V/m]		
	GFSK	Pi/4 DQPSK	8DPSK
Modulation			
Lower restricted band	< 54	< 54	< 54
Upper restricted band	< 54	< 54	< 54
Measurement uncertainty	\pm 3 dB		

Result: The result of the measurement is passed.

Plots:

Plot 1: Lower band edge, GFSK modulation, vertical polarization

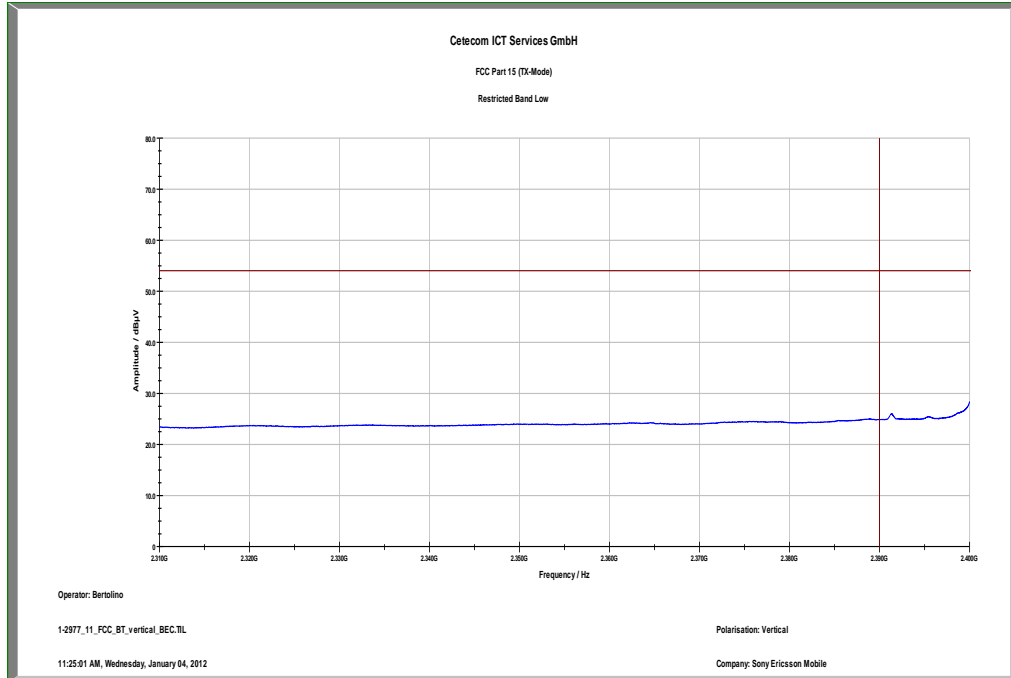

Plot 2: Upper band edge, GFSK modulation, vertical polarization

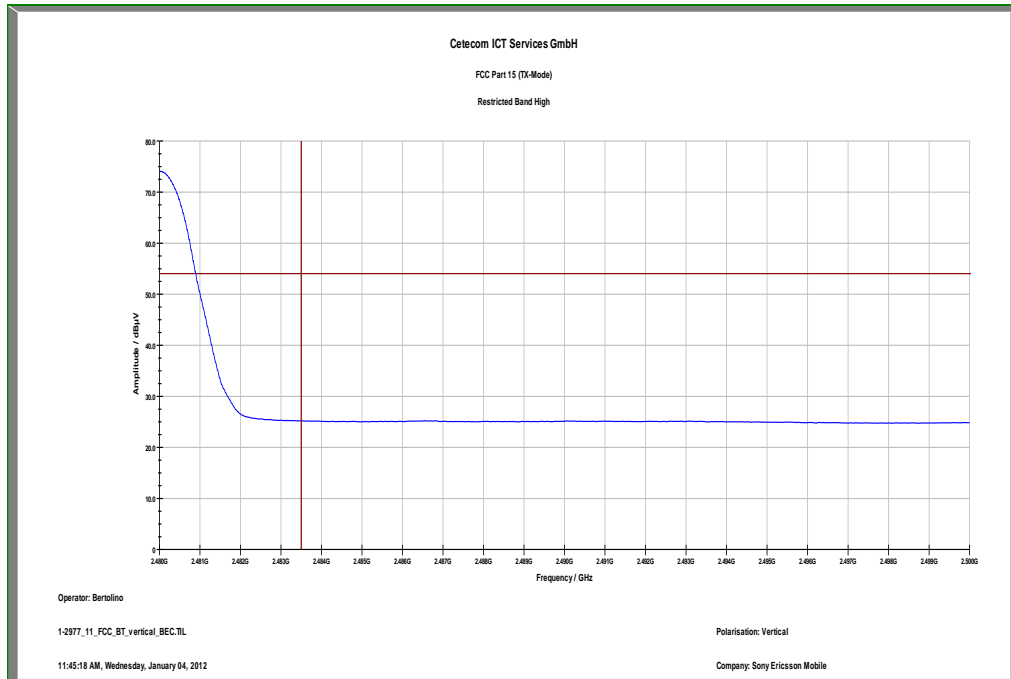

Plot 3: Lower band edge, GFSK modulation, horizontal polarization

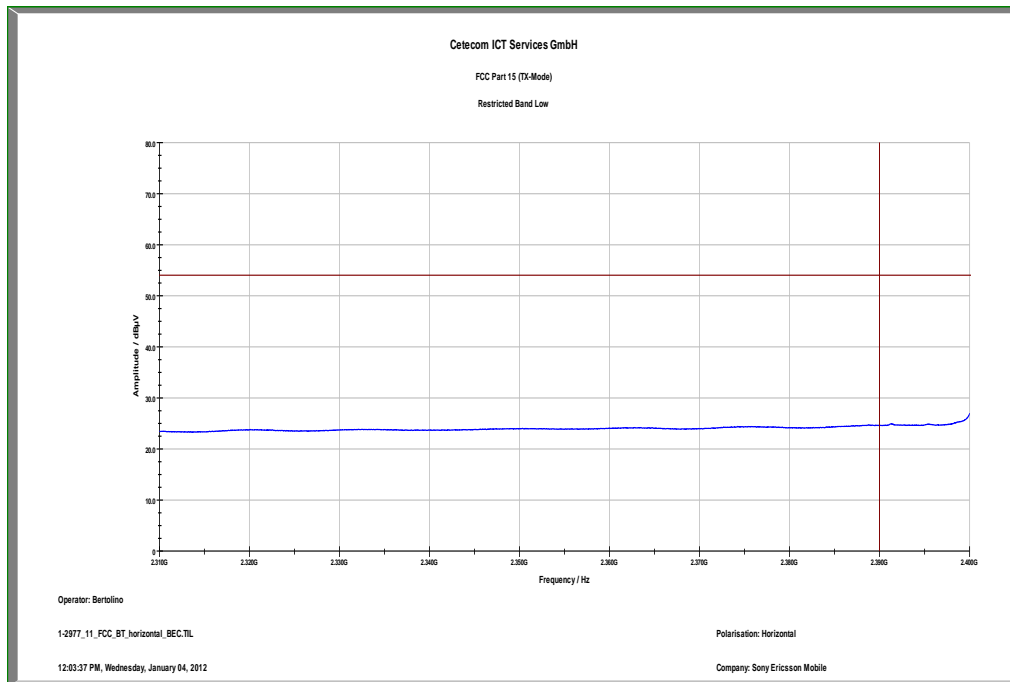

Plot 4: Upper band edge, GFSK modulation, horizontal polarization

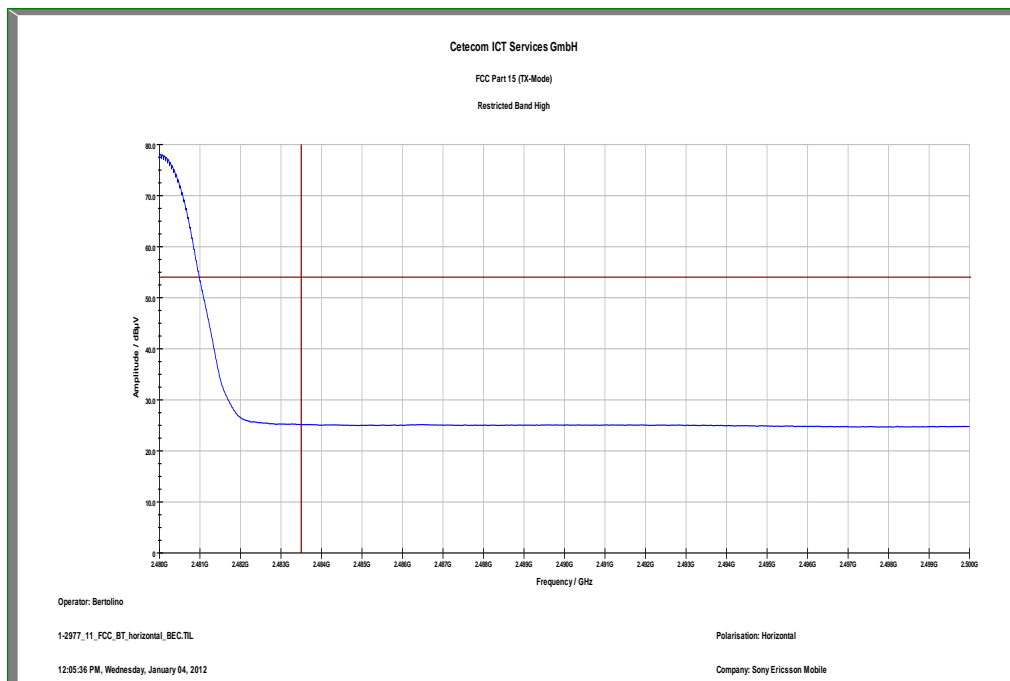

Plot 5: Lower band edge, Pi/4 DQPSK modulation, vertical polarization

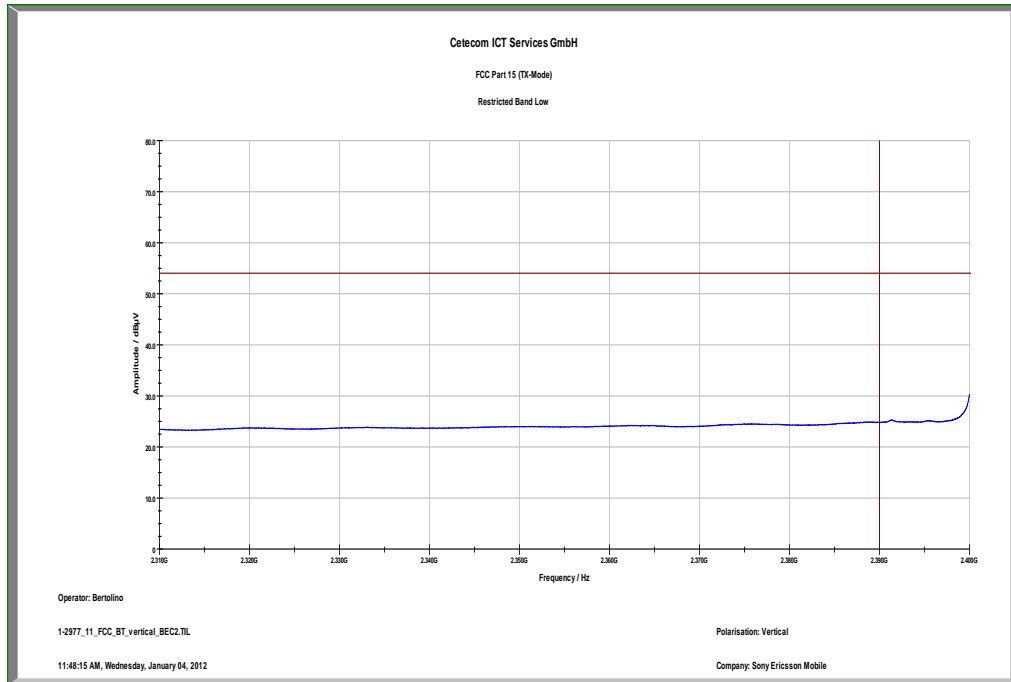

Plot 6: Upper band edge, Pi/4 DQPSK modulation, vertical polarization

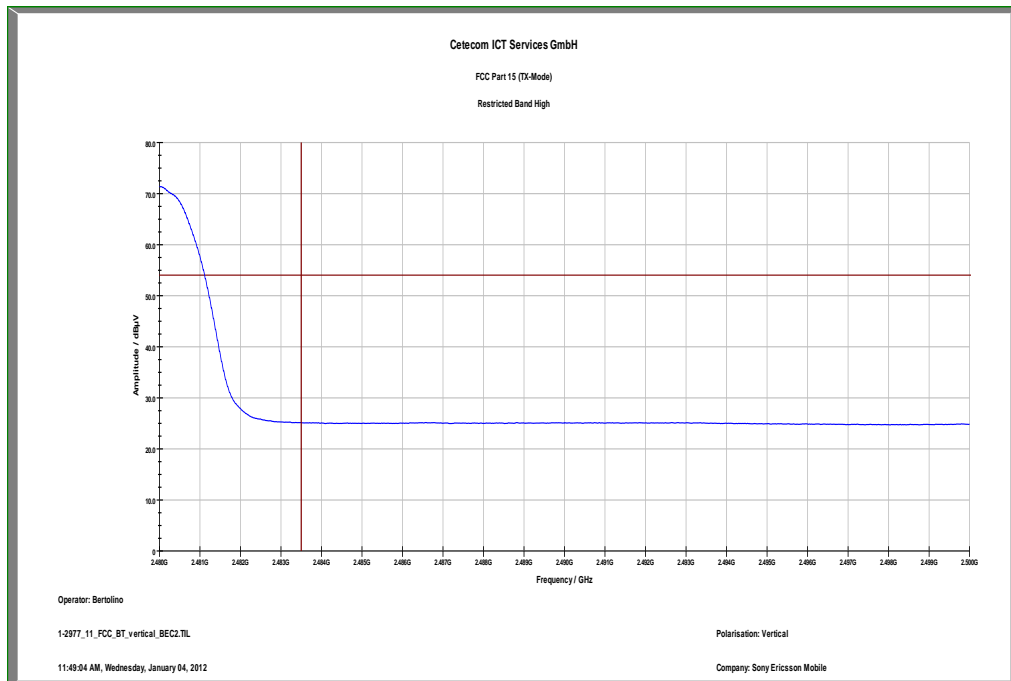

Plot 7: Lower band edge, Pi/4 DQPSK modulation, horizontal polarization

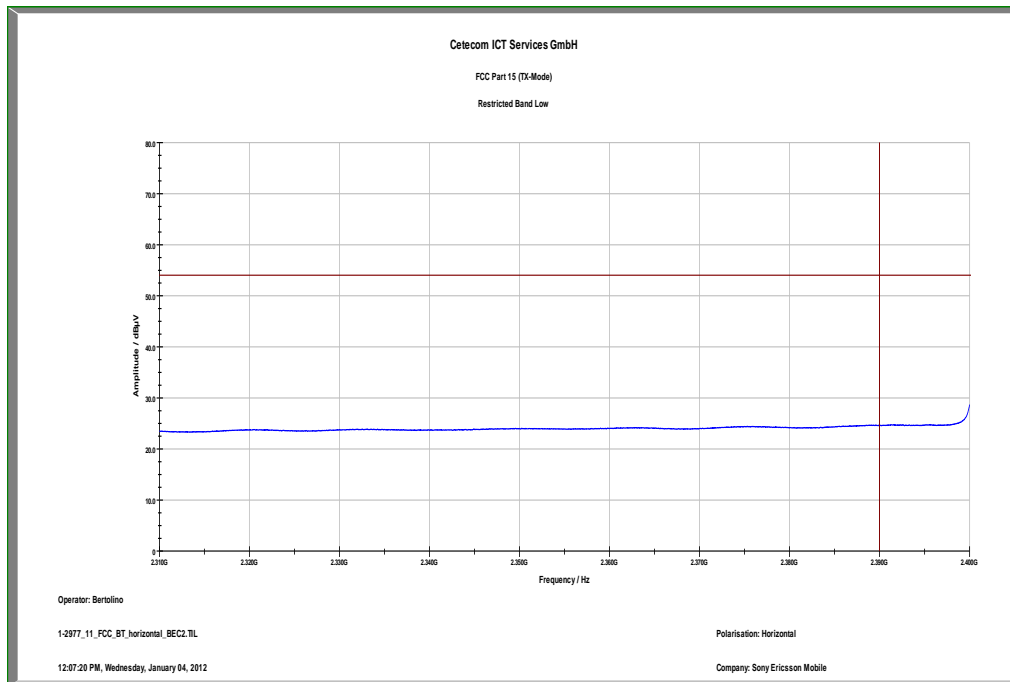

Plot 8: Upper band edge, Pi/4 DQPSK modulation, horizontal polarization

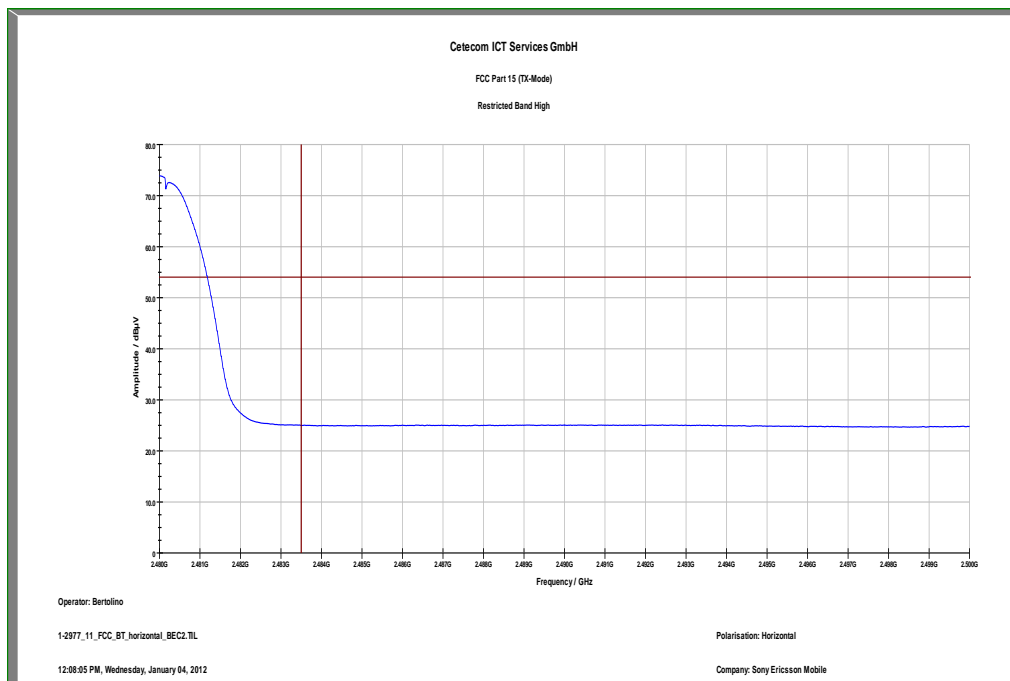

Plot 9: Lower band edge, 8 DPSK modulation, vertical polarization

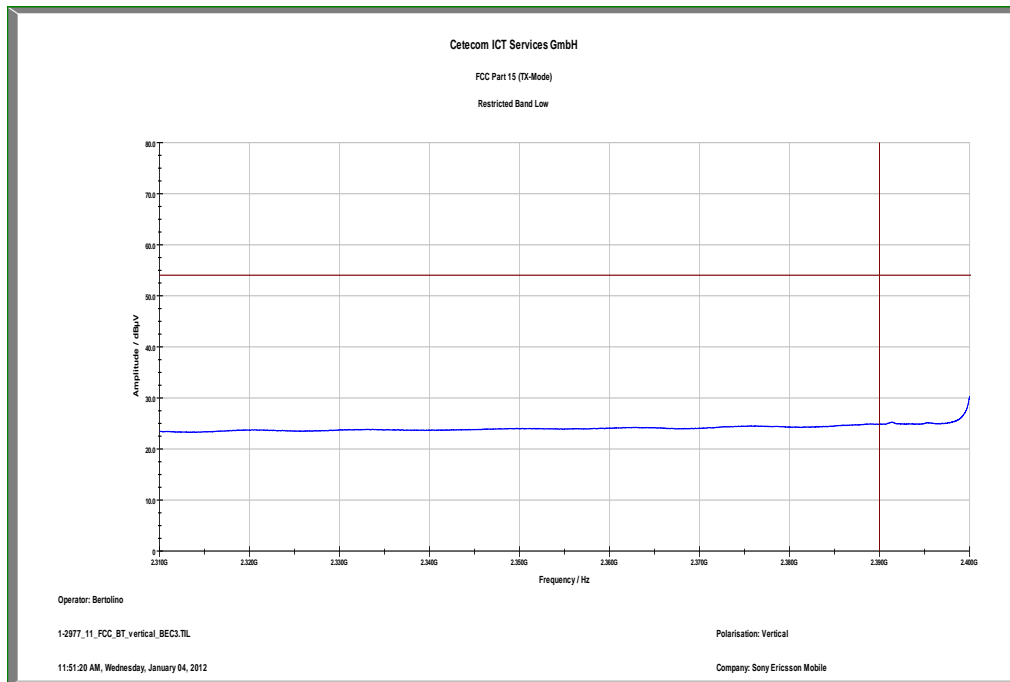

Plot 10: Upper band edge, 8 DPSK modulation, vertical polarization

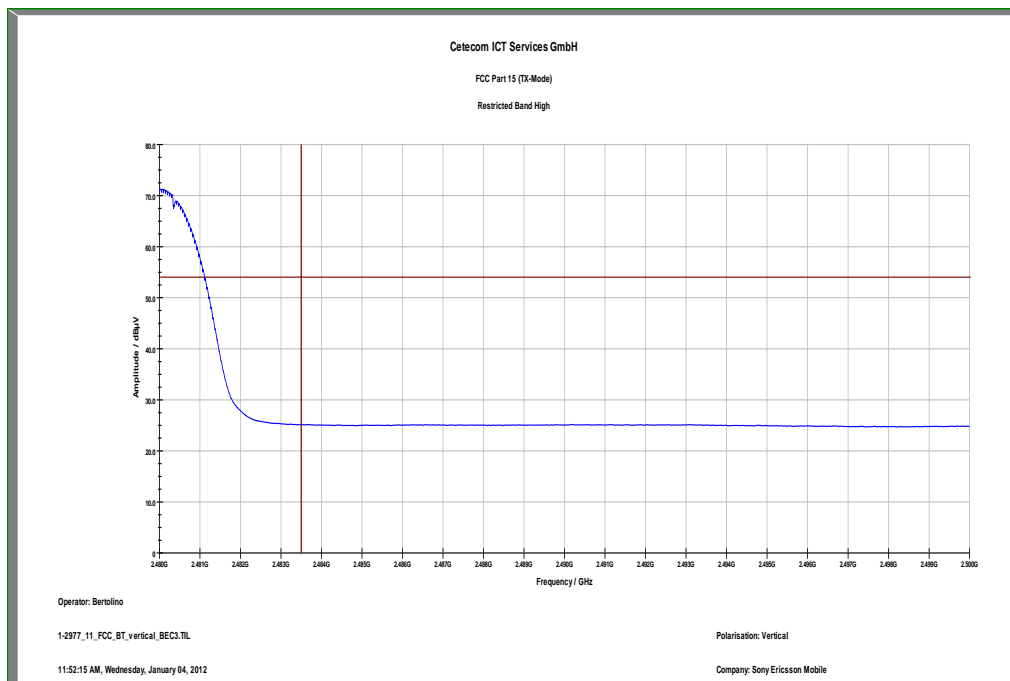

Plot 11: Lower band edge, 8 DPSK modulation, horizontal polarization

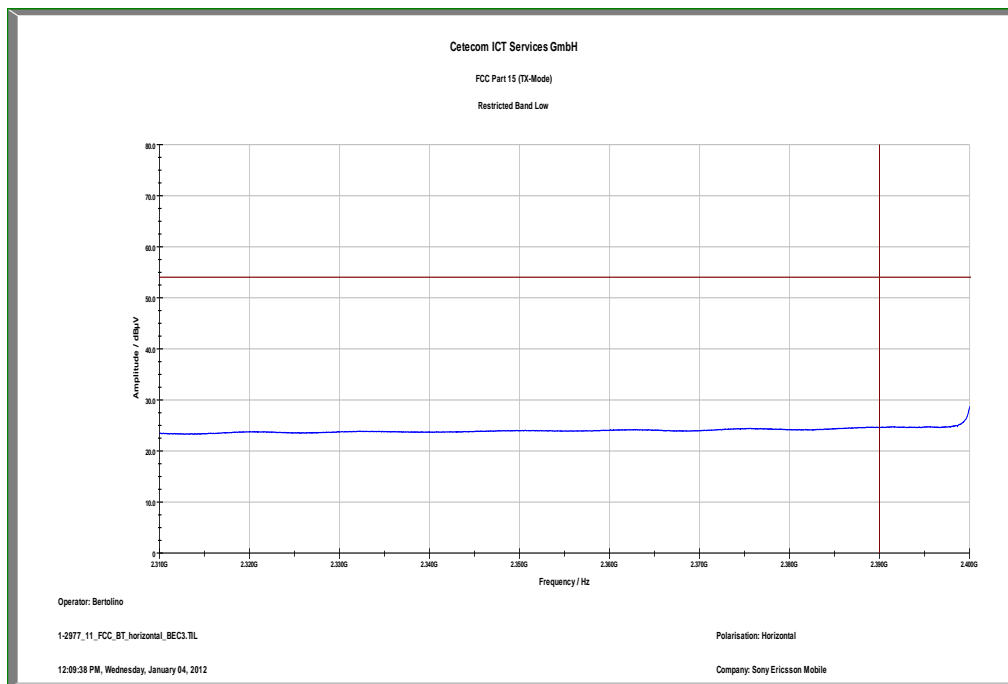

Plot 12: Upper band edge, 8 DPSK modulation, horizontal polarization

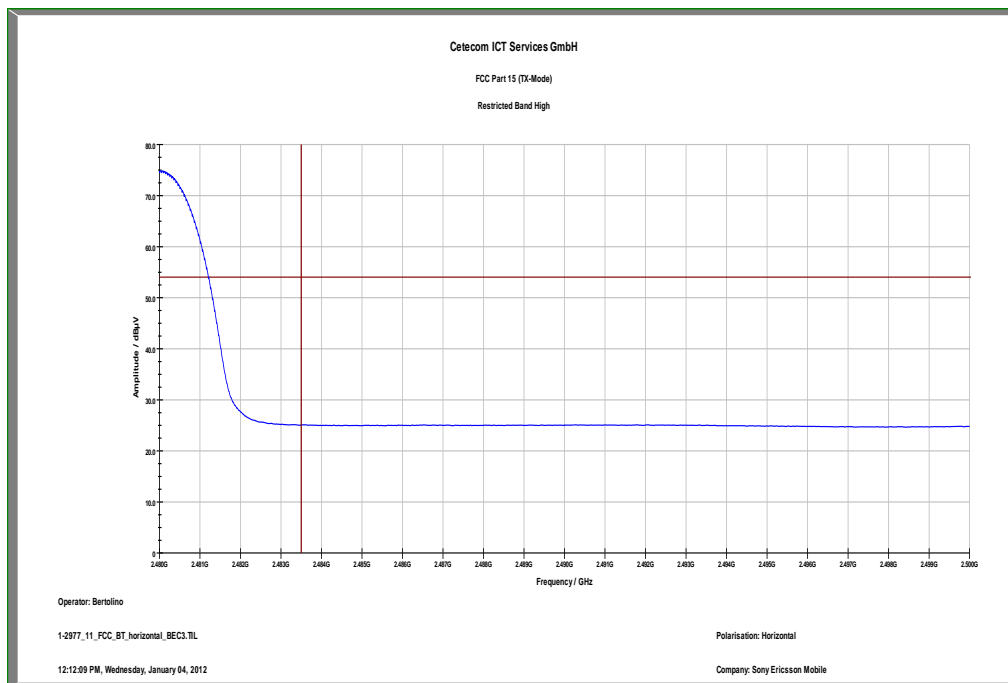

9.10 TX spurious emissions conducted

Description:

Measurement of the conducted spurious emissions in transmit mode. The EUT is set to single channel mode and the transmit channel is channel 00, channel 39 and channel 78. The measurement is repeated for all modulations.

Measurement:

Measurement parameter	
Detector:	Peak
Sweep time:	Auto
Video bandwidth:	F < 1 GHz: 500 kHz F > 1 GHz: 500 kHz
Resolution bandwidth:	F < 1 GHz: 100 kHz F > 1 GHz: 100 kHz
Span:	9 kHz to 25 GHz
Trace-Mode:	Max Hold

Limits:

FCC	IC
CFR Part 15.247(d)	RSS 210, Issue 8, A 8.5
TX spurious emissions conducted	
<p>In any 100 kHz bandwidth outside the frequency band in which the spread spectrum or digitally modulated intentional radiator is operating, the radio frequency power that is produced by the intentional radiator shall be at least 20 dB below that in the 100 kHz bandwidth within the band that contains the highest level of the desired power, based on either an RF conducted or a radiated measurement. Attenuation below the general limits specified in Section 15.209(a) is not required</p>	

Results:

TX spurious emissions conducted					
GFSK - mode					
f [MHz]		amplitude of emission [dBm]	limit max. allowed emission power	actual attenuation below frequency of operation [dB]	results
2402		6.38	30 dBm		Operating frequency
No critical peaks detected. All detected emissions are below the 20 dBc criteria.			-20 dBc		complies
2441		7.01	30 dBm		Operating frequency
No critical peaks detected. All detected emissions are below the 20 dBc criteria.			-20 dBc		complies
2480		7.17	30 dBm		Operating frequency
No critical peaks detected. All detected emissions are below the 20 dBc criteria.			-20 dBc		complies
Measurement uncertainty		± 3 dB			

Result: The result of the measurement is passed.

Results:

TX spurious emissions conducted					
Pi/4-DQPSK - mode					
f [MHz]		amplitude of emission [dBm]	limit max. allowed emission power	actual attenuation below frequency of operation [dB]	results
2402		5.86	30 dBm		Operating frequency
No critical peaks detected. All detected emissions are below the 20 dBc criteria.			-20 dBc		complies
2441		6.56	30 dBm		Operating frequency
No critical peaks detected. All detected emissions are below the 20 dBc criteria.			-20 dBc		complies
2480		6.61	30 dBm		Operating frequency
No critical peaks detected. All detected emissions are below the 20 dBc criteria.			-20 dBc		complies
Measurement uncertainty		± 3dB			

Result: The result of the measurement is passed.

Results:

TX spurious emissions conducted					
8DPSK - mode					
f [MHz]		amplitude of emission [dBm]	limit max. allowed emission power	actual attenuation below frequency of operation [dB]	results
2402		6.07	30 dBm		Operating frequency
No critical peaks detected. All detected emissions are below the 20 dBc criteria.			-20 dBc		complies
2441		6.77	30 dBm		Operating frequency
No critical peaks detected. All detected emissions are below the 20 dBc criteria.			-20 dBc		complies
2480		6.86	30 dBm		Operating frequency
No critical peaks detected. All detected emissions are below the 20 dBc criteria.			-20 dBc		complies
Measurement uncertainty		± 3dB			

Result: The result of the measurement is passed.

Plots:

Plot 1: lowest channel – 2402 MHz, GFSK modulation

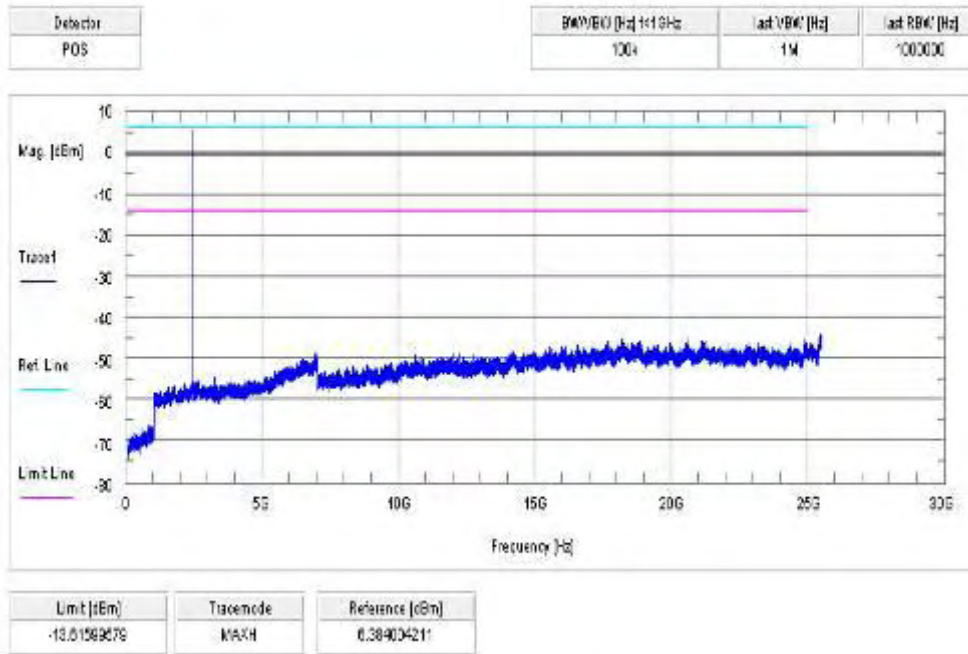

Plot 2: middle channel – 2441 MHz, GFSK modulation

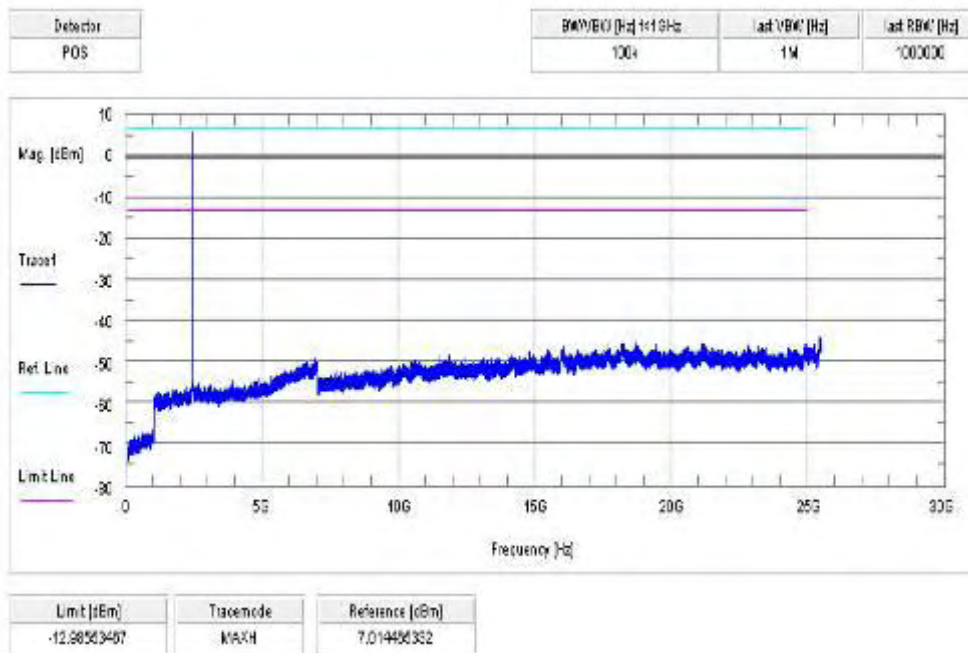

Plot 3: highest channel – 2480 MHz, GFSK modulation

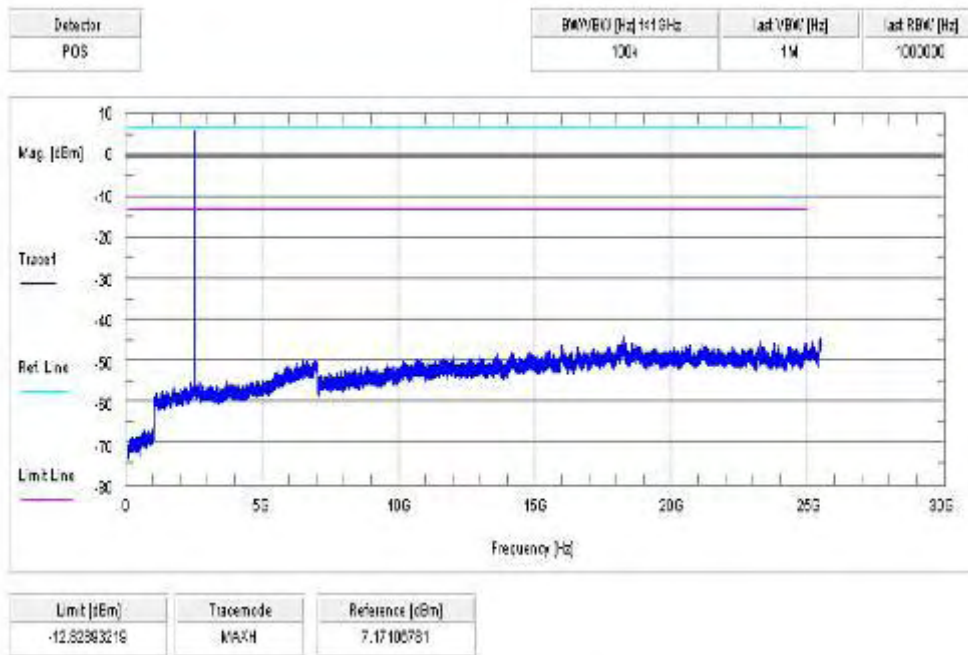

Plot 4: lowest channel – 2402 MHz, Pi / DQPSK modulation

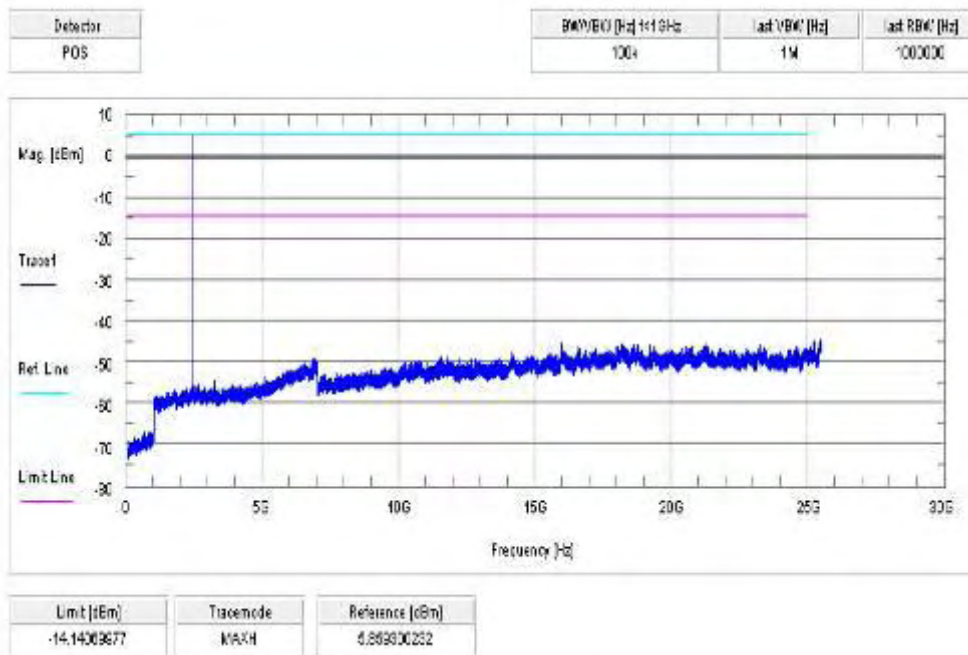

Plot 5: middle channel – 2441 MHz, Pi / DQPSK modulation

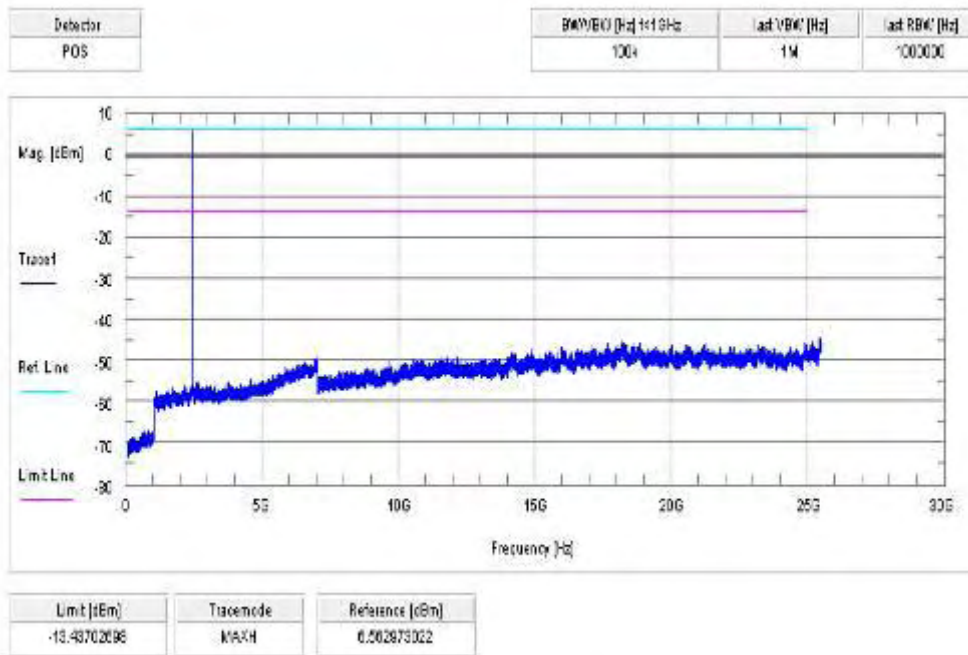

Plot 6: highest channel – 2480 MHz, Pi / DQPSK modulation

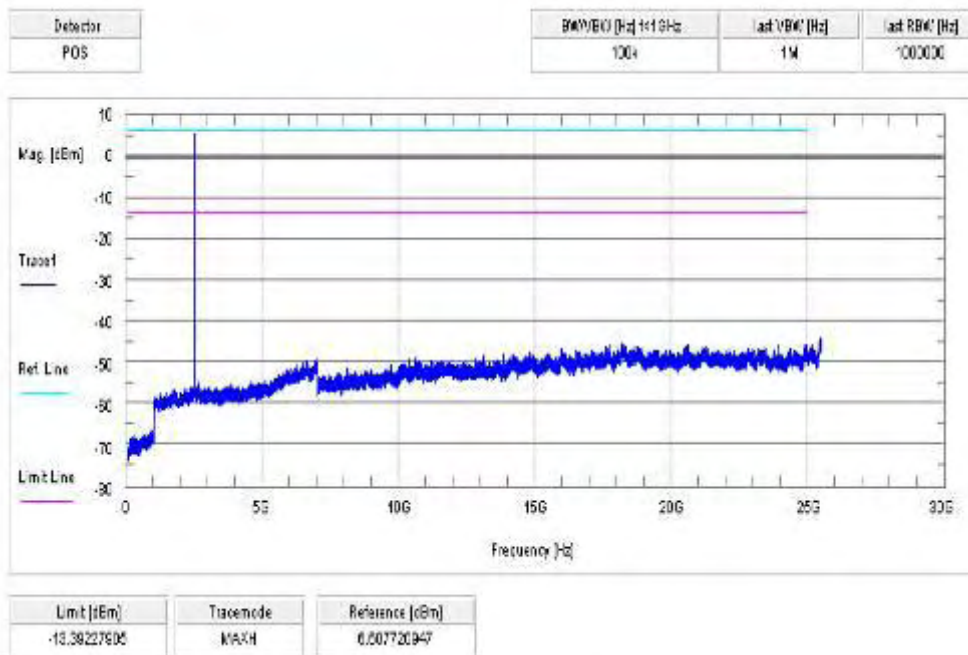

Plot 7: lowest channel – 2402 MHz, 8 DPSK modulation

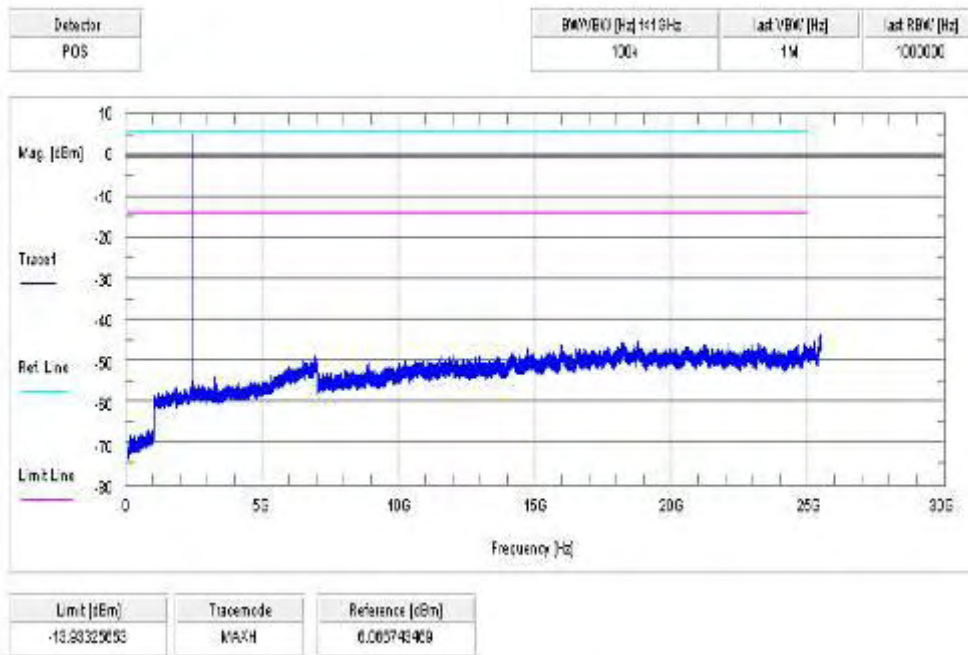

Plot 8: middle channel – 2441 MHz, 8 DPSK modulation

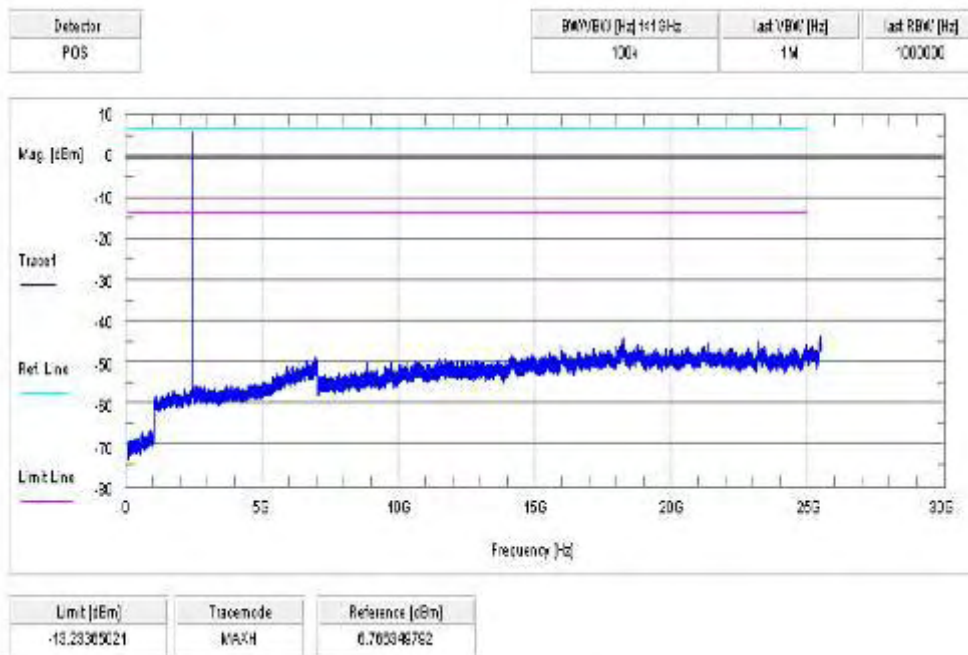

Plot 9: highest channel – 2480 MHz, 8 DPSK modulation

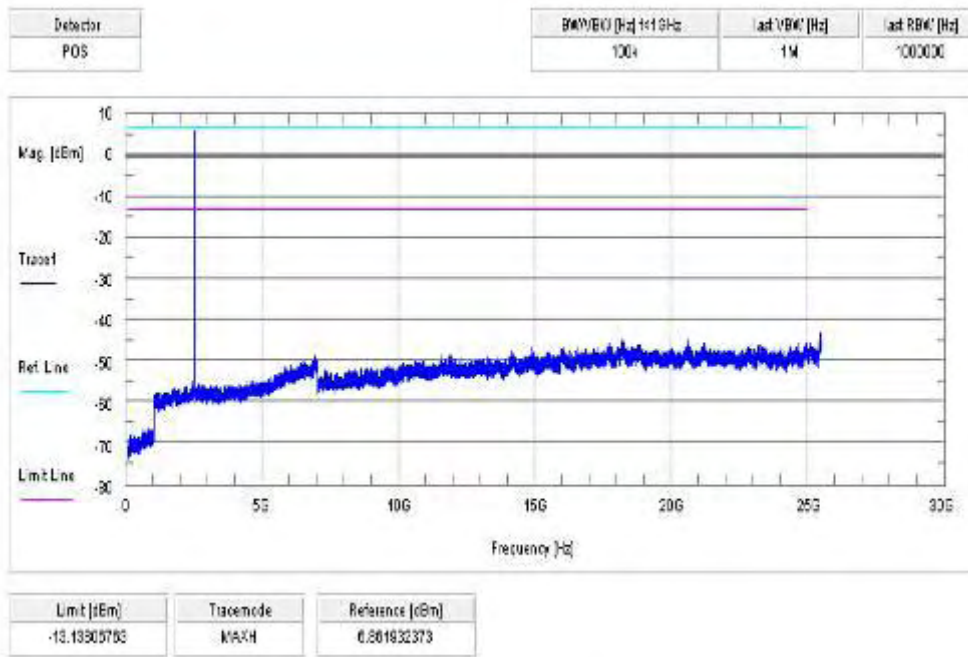

9.11 TX spurious emissions radiated

Description:

Measurement of the radiated spurious emissions in transmit mode. The EUT is set to single channel mode and the transmit channel is channel 00, channel 39 and channel 78. The measurement is performed in the mode with the highest output power.

Measurement:

Measurement parameter	
Detector:	Peak / Quasi Peak
Sweep time:	Auto
Video bandwidth:	Sweep: 100 kHz Remeasurement: 10 Hz
Resolution bandwidth:	F < 1 GHz: 100 kHz F > 1 GHz: 1 MHz
Span:	30 MHz to 25 GHz
Trace-Mode:	Max Hold
Measured Modulation:	<input type="checkbox"/> GFSK <input type="checkbox"/> Pi/4 DQPSK <input checked="" type="checkbox"/> 8DPSK

The modulation with the highest output power was used to perform the transmitter spurious emissions. If spurious were detected a re-measurement was performed on the detected frequency with each modulation.

Limits:

FCC		IC	
CFR Part 15.247(d)		RSS 210, Issue 8, A 8.5	
TX spurious emissions radiated			
<p>In any 100 kHz bandwidth outside the frequency band in which the spread spectrum or digitally modulated intentional radiator is operating, the radio frequency power that is produced by the intentional radiator shall be at least 20 dB below that in the 100 kHz bandwidth within the band that contains the highest level of the desired power, based on either an RF conducted or a radiated measurement. Attenuation below the general limits specified in Section 15.209(a) is not required. In addition, radiated emissions which fall in the restricted bands, as defined in §15.205(a), must also comply with the radiated emission limits specified in §15.209(a) (see §15.205(c)).</p>			
§15.209			
Frequency (MHz)	Field strength (dBµV/m)	Measurement distance	
30 - 88	30.0	10	
88 – 216	33.5	10	
216 – 960	36.0	10	
Above 960	54.0	3	

Results:

TX spurious emissions radiated [dB μ V/m]								
2402 MHz			2441 MHz			2480 MHz		
F [MHz]	Detector	Level [dB μ V/m]	F [MHz]	Detector	Level [dB μ V/m]	F [MHz]	Detector	Level [dB μ V/m]
For emissions below 1 GHz, please take a look at the table below the 1 GHz plot.			For emissions below 1 GHz, please take a look at the table below the 1 GHz plot.			For emissions below 1 GHz, please take a look at the table below the 1 GHz plot.		
No critical emissions detected between 1 GHz and 12.75 GHz.			No critical emissions detected between 1 GHz and 12.75 GHz.			No critical emissions detected between 1 GHz and 12.75 GHz.		
For emissions above 12.75 GHz, please take a look at the plots.			For emissions above 12.75 GHz, please take a look at the plots.			For emissions above 12.75 GHz, please take a look at the plots.		
Measurement uncertainty			± 3 dB					

Result: The result of the measurement is passed.

Plots:

Plot 1: 30 MHz to 1 GHz, TX mode, channel 00, vertical & horizontal polarization

Common Information

EUT: AAD-3880132-BV
 Serial Number: sample radiated 02
 Test Description: FCC part 15 class B @ 10 m
 Operating Conditions: charging + BT CH0
 Operator Name: Wolsdorfer
 Comment: AC: 115 V / 60 Hz;

Scan Setup: STAN_Fin [EMI radiated]

Hardware Setup: Electric Field (NOS)
 Receiver: [ESCI 3]
 Level Unit: dBµV/m
 Subrange: 30 MHz - 2 GHz Step Size: 60 kHz Detectors: QPK IF BW: 120 kHz Meas. Time: 1 s Preamp: 20 dB

FCC_10m(B)_3

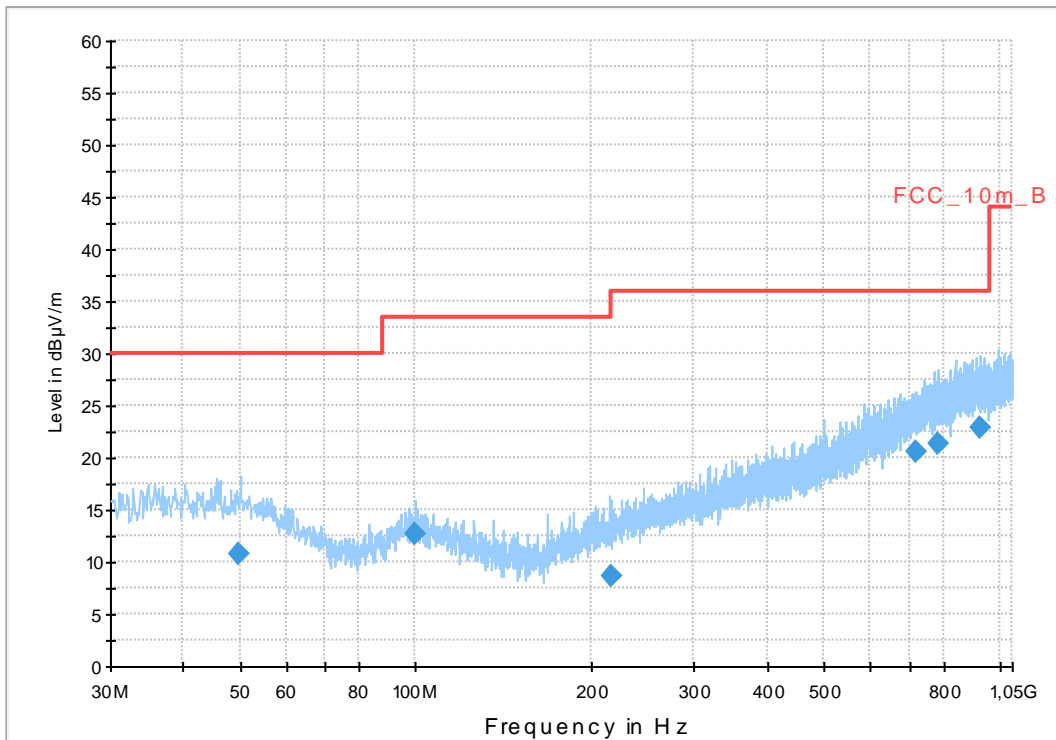

Final Result 1

Frequency (MHz)	QuasiPeak (dBµV/m)	Meas. Time (ms)	Bandwidth (kHz)	Height (cm)	Polarization	Azimuth (deg)	Corr. (dB)	Margin (dB)	Limit (dBµV/m)	Comment
49.802700	10.7	1000.0	120.000	155.0	V	8.0	13.4	19.3	30.0	
100.021650	12.8	1000.0	120.000	105.0	V	8.0	11.9	20.7	33.5	
215.590350	8.6	1000.0	120.000	170.0	H	106.0	12.2	24.9	33.5	
718.294650	20.6	1000.0	120.000	120.0	V	8.0	22.9	15.4	36.0	
782.906400	21.4	1000.0	120.000	170.0	H	261.0	23.8	14.6	36.0	
923.284950	22.8	1000.0	120.000	98.0	V	80.0	25.3	13.2	36.0	

Hardware Setup: EMI radiated\Electric Field (NOS) - [EMI radiated]

Subrange 1	
Frequency Range:	30 MHz - 2 GHz
Receiver:	Receiver [ESCI 3] @ GPIB0 (ADR 20), SN 100083/003, FW 4.42
Signal Path:	without Notch FW 1.0
Antenna:	VULB 9163 SN 9163-295, FW --- Correction Table (vertical): VULP6113 Correction Table (horizontal): VULP6113
Antenna Tower:	Correction Table: Cable_EN_1GHz (1005) Tower [EMCO 2090 Antenna Tower] @ GPIB0 (ADR 8), FW REV 3.12
Turntable:	Turntable [EMCO Turntable] @ GPIB0 (ADR 9), FW REV 3.12

EMC 32 Version 8.10.00

Plot 2: 1 GHz to 12.75 GHz, TX mode, channel 00, vertical polarization

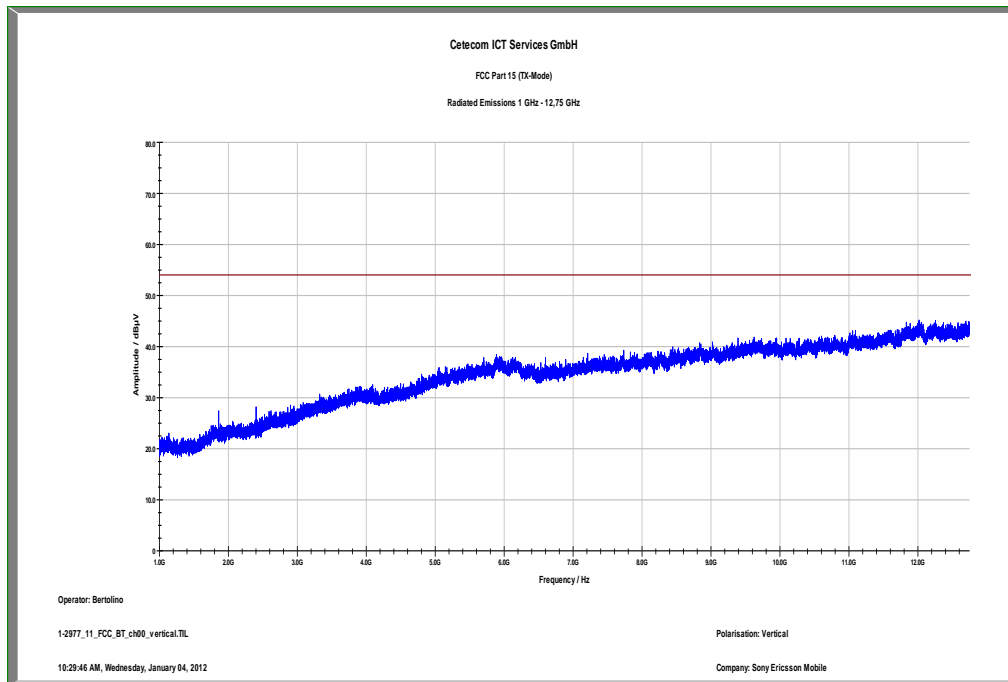

The carrier signal is notched with a 2.4 GHz band rejection filter.

Plot 3: 1 GHz to 12.75 GHz, TX mode, channel 00, horizontal polarization

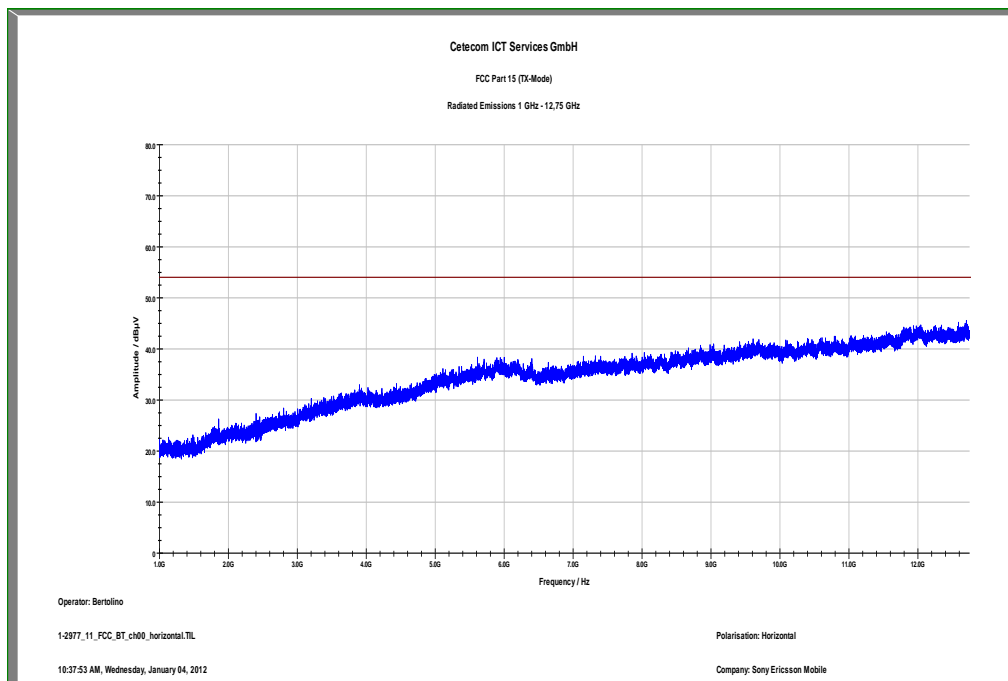

The carrier signal is notched with a 2.4 GHz band rejection filter.

Plot 4: 12.75 GHz to 18 GHz, TX mode, channel 00, vertical & horizontal polarization

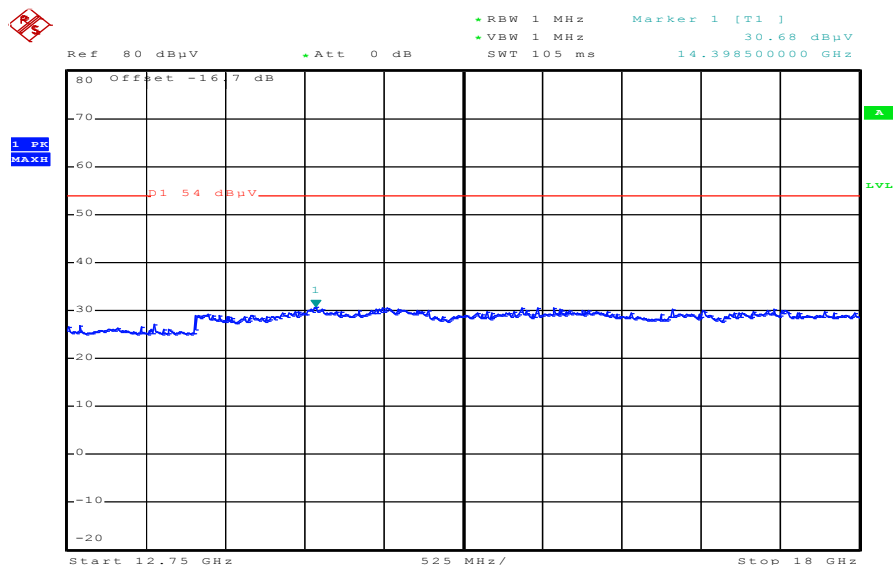

Date: 4.JAN.2012 14:39:21

Plot 5: 18 GHz to 26 GHz, TX mode, channel 00, vertical & horizontal polarization

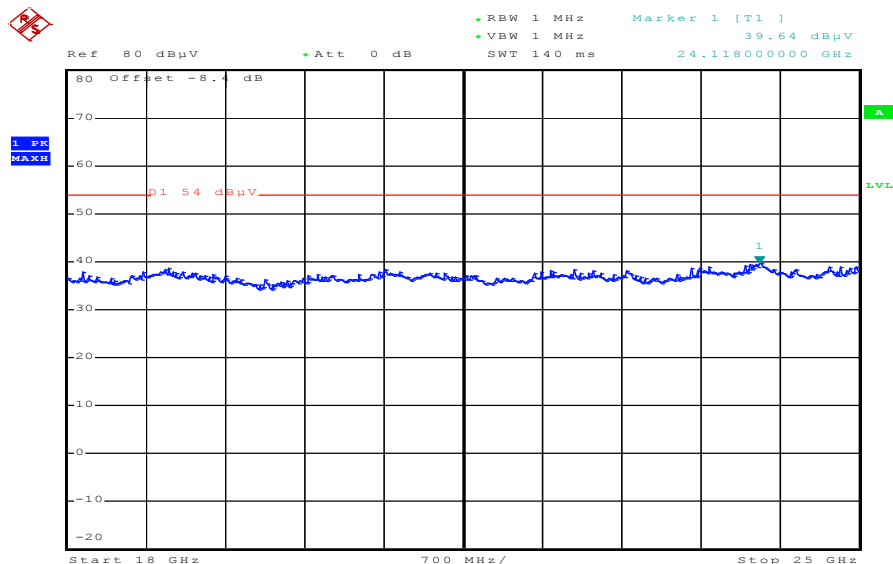

Date: 4.JAN.2012 15:08:46

Plot 6: 30 MHz to 1 GHz, TX mode, channel 39, vertical & horizontal polarization

Common Information

EUT: AAD-3880132-BV
 Serial Number: sample radiated 02
 Test Description: FCC part 15 class B @ 10 m
 Operating Conditions: charging + BT CH39
 Operator Name: Wolsdorfer
 Comment: AC: 115 V / 60 Hz;

Scan Setup: STAN_Fin [EMI radiated]

Hardware Setup: Electric Field (NOS)
 Receiver: [ESCI 3]
 Level Unit: dBµV/m

Subrange	Step Size	Detectors	IF BW	Meas. Time	Preamp
30 MHz - 2 GHz	60 kHz	QPK	120 kHz	1 s	20 dB

FCC_10m(B)_3

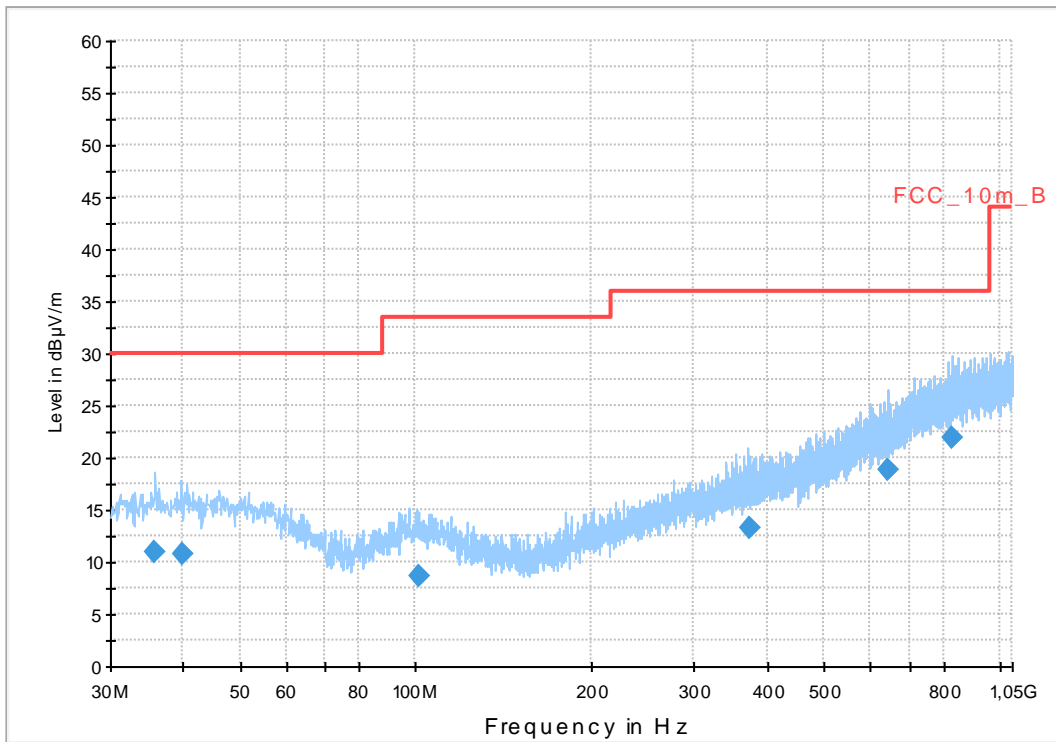

Final Result 1

Frequency (MHz)	QuasiPeak (dBµV/m)	Meas. Time (ms)	Bandwidth (kHz)	Height (cm)	Polarization	Azimuth (deg)	Corr. (dB)	Margin (dB)	Limit (dBµV/m)	Comment
35.593050	10.9	1000.0	120.000	170.0	V	76.0	13.1	19.1	30.0	
39.906450	10.8	1000.0	120.000	170.0	V	91.0	13.4	19.2	30.0	
101.133450	8.6	1000.0	120.000	170.0	H	283.0	11.8	24.9	33.5	
373.390500	13.3	1000.0	120.000	170.0	V	260.0	16.5	22.7	36.0	
644.611500	18.8	1000.0	120.000	170.0	H	102.0	21.1	17.2	36.0	
829.817250	22.0	1000.0	120.000	170.0	V	182.0	24.3	14.0	36.0	

Hardware Setup: EMI radiated\Electric Field (NOS) - [EMI radiated]

Subrange 1	
Frequency Range:	30 MHz - 2 GHz
Receiver:	Receiver [ESCI 3] @ GPIB0 (ADR 20), SN 100083/003, FW 4.42
Signal Path:	without Notch FW 1.0
Antenna:	VULB 9163 SN 9163-295, FW --- Correction Table (vertical): VULP6113 Correction Table (horizontal): VULP6113
Antenna Tower:	Correction Table: Cable_EN_1GHz (1005) Tower [EMCO 2090 Antenna Tower] @ GPIB0 (ADR 8), FW REV 3.12
Turntable:	Turntable [EMCO Turntable] @ GPIB0 (ADR 9), FW REV 3.12

EMC 32 Version 8.10.00

Plot 7: 1 GHz to 12.75 GHz, TX mode, channel 39, vertical polarization

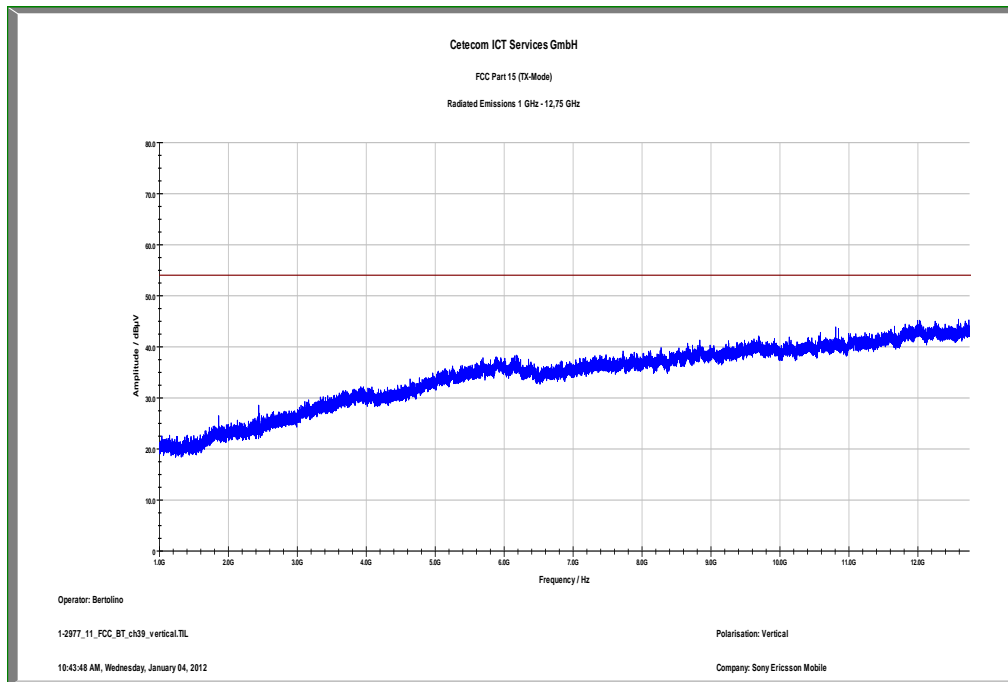

The carrier signal is notched with a 2.4 GHz band rejection filter.

Plot 8: 1 GHz to 12.75 GHz, TX mode, channel 39, horizontal polarization

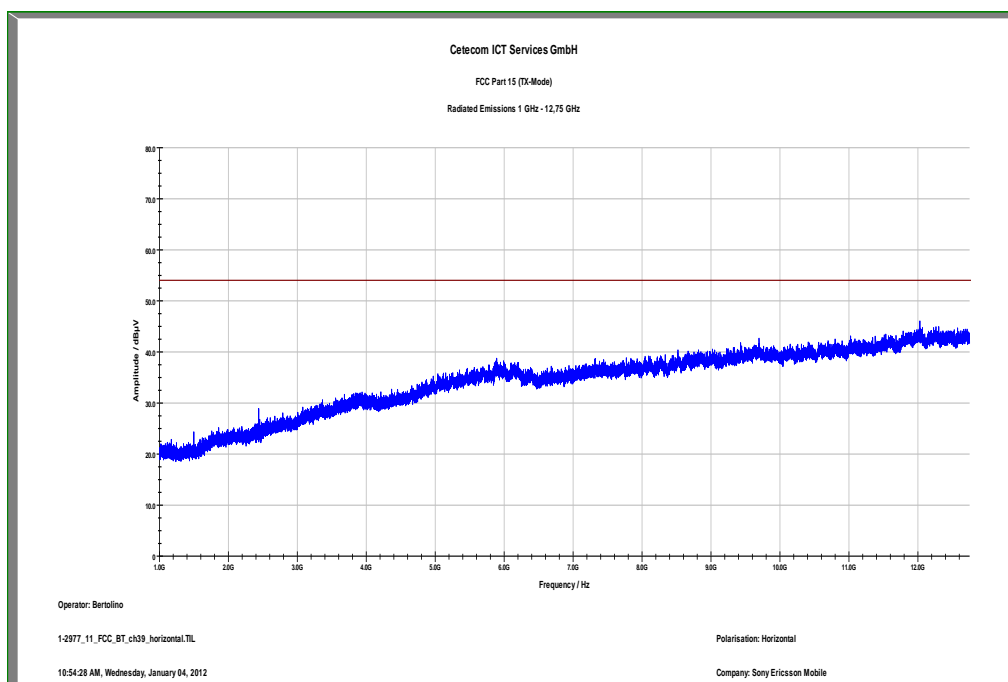

The carrier signal is notched with a 2.4 GHz band rejection filter.

Plot 9: 12.75 GHz to 18 GHz, TX mode, channel 39, vertical & horizontal polarization

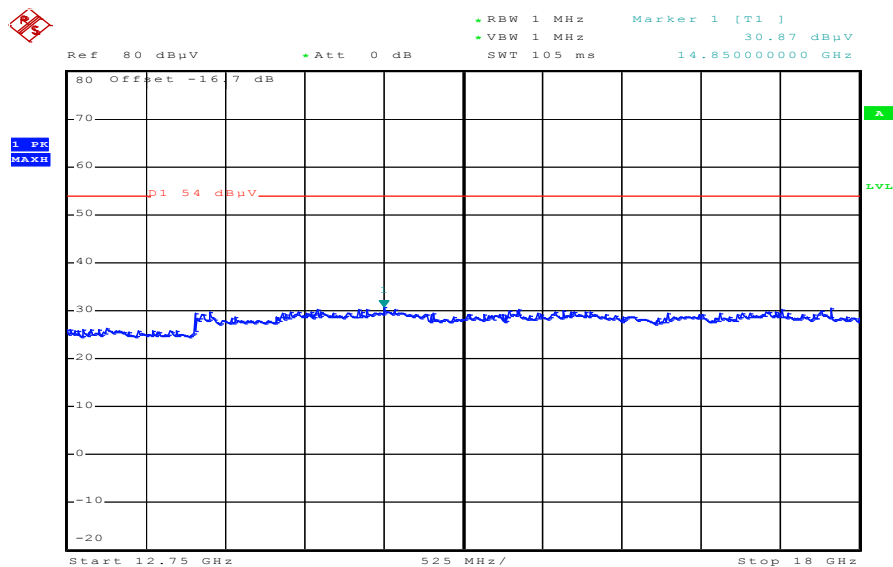

Date: 4.JAN.2012 14:40:22

Plot 10: 18 GHz to 26 GHz, TX mode, channel 39, vertical & horizontal polarization

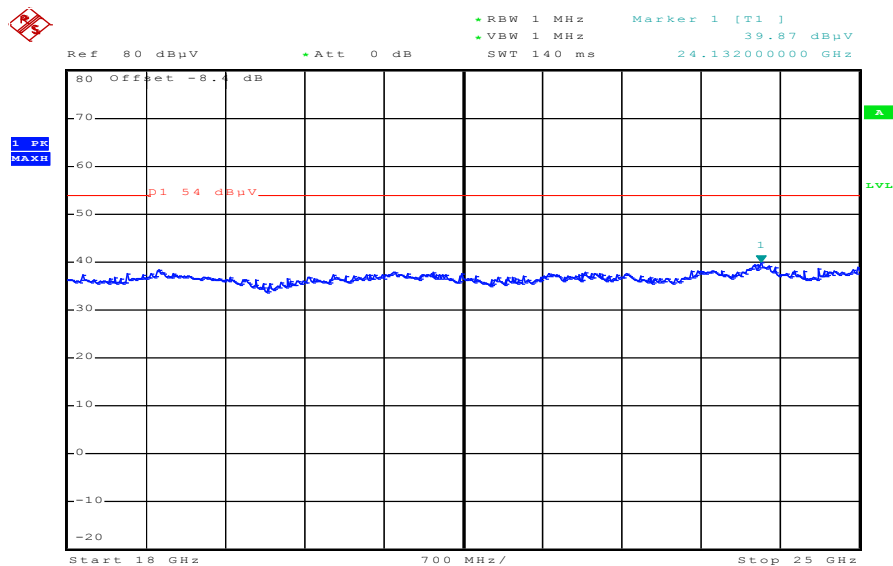

Date: 4.JAN.2012 15:11:06

Plot 11: 30 MHz to 1 GHz, TX mode, channel 78, vertical & horizontal polarization

Common Information

EUT: AAD-3880132-BV
 Serial Number: sample radiated 02
 Test Description: FCC part 15 class B @ 10 m
 Operating Conditions: charging + BT CH78
 Operator Name: Wolsdorfer
 Comment: AC: 115 V / 60 Hz;

Scan Setup: STAN_Fin [EMI radiated]

Hardware Setup: Electric Field (NOS)
 Receiver: [ESCI 3]
 Level Unit: dBµV/m
Subrange **Step Size** **Detectors** **IF BW** **Meas. Time** **Preamp**
 30 MHz - 2 GHz 60 kHz QPK 120 kHz 1 s 20 dB

FCC_10m(B)_3

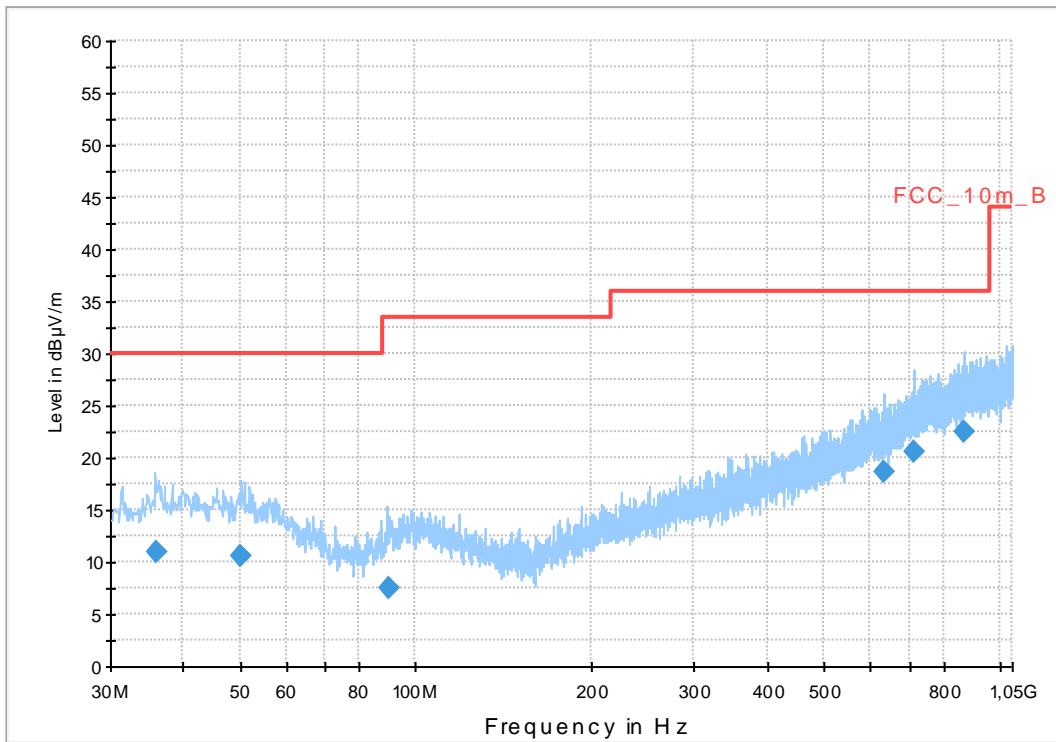

Final Result 1

Frequency (MHz)	QuasiPeak (dBµV/m)	Meas. Time (ms)	Bandwidth (kHz)	Height (cm)	Polarization	Azimuth (deg)	Corr. (dB)	Margin (dB)	Limit (dBµV/m)	Comment
35.904000	11.0	1000.0	120.000	146.0	V	78.0	13.1	19.0	30.0	
49.994400	10.5	1000.0	120.000	136.0	V	172.0	13.4	19.5	30.0	
90.171300	7.5	1000.0	120.000	170.0	H	269.0	10.6	26.0	33.5	
631.306350	18.6	1000.0	120.000	170.0	V	284.0	21.0	17.4	36.0	
713.791950	20.5	1000.0	120.000	120.0	H	196.0	22.8	15.5	36.0	
869.525250	22.6	1000.0	120.000	136.0	H	82.0	24.8	13.4	36.0	

Hardware Setup: EMI radiated\Electric Field (NOS) - [EMI radiated]

Subrange 1	
Frequency Range:	30 MHz - 2 GHz
Receiver:	Receiver [ESCI 3] @ GPIB0 (ADR 20), SN 100083/003, FW 4.42
Signal Path:	without Notch FW 1.0
Antenna:	VULB 9163 SN 9163-295, FW --- Correction Table (vertical): VULP6113 Correction Table (horizontal): VULP6113
Antenna Tower:	Correction Table: Cable_EN_1GHz (1005) Tower [EMCO 2090 Antenna Tower] @ GPIB0 (ADR 8), FW REV 3.12
Turntable:	Turntable [EMCO Turntable] @ GPIB0 (ADR 9), FW REV 3.12

EMC 32 Version 8.10.00

Plot 12: 1 GHz to 12.75 GHz, TX mode, channel 78, vertical polarization

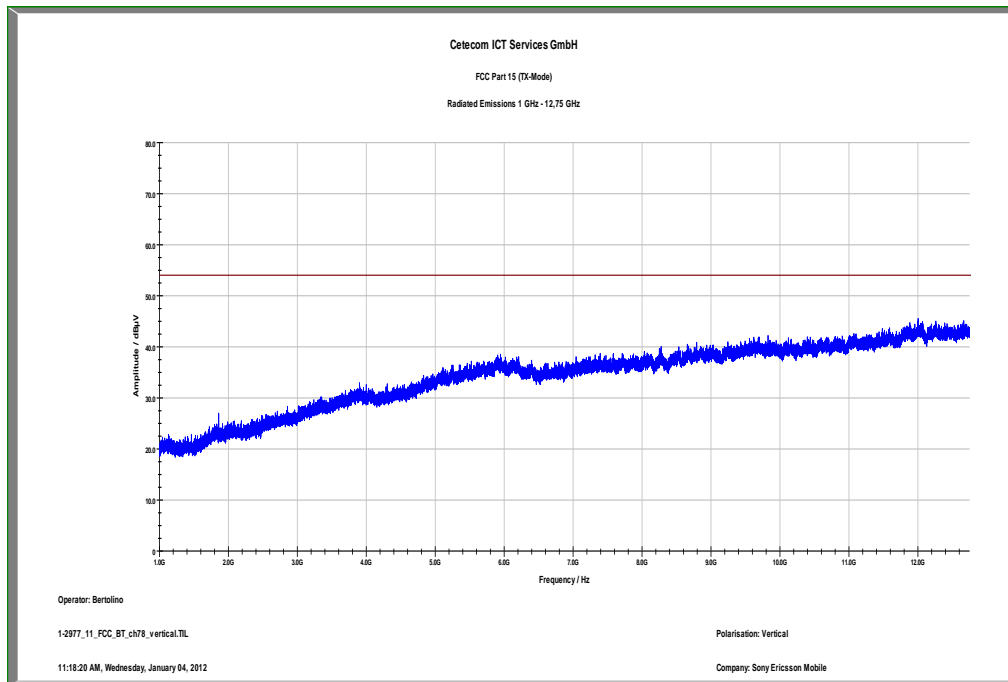

The carrier signal is notched with a 2.4 GHz band rejection filter.

Plot 13: 1 GHz to 12.75 GHz, TX mode, channel 78, horizontal polarization

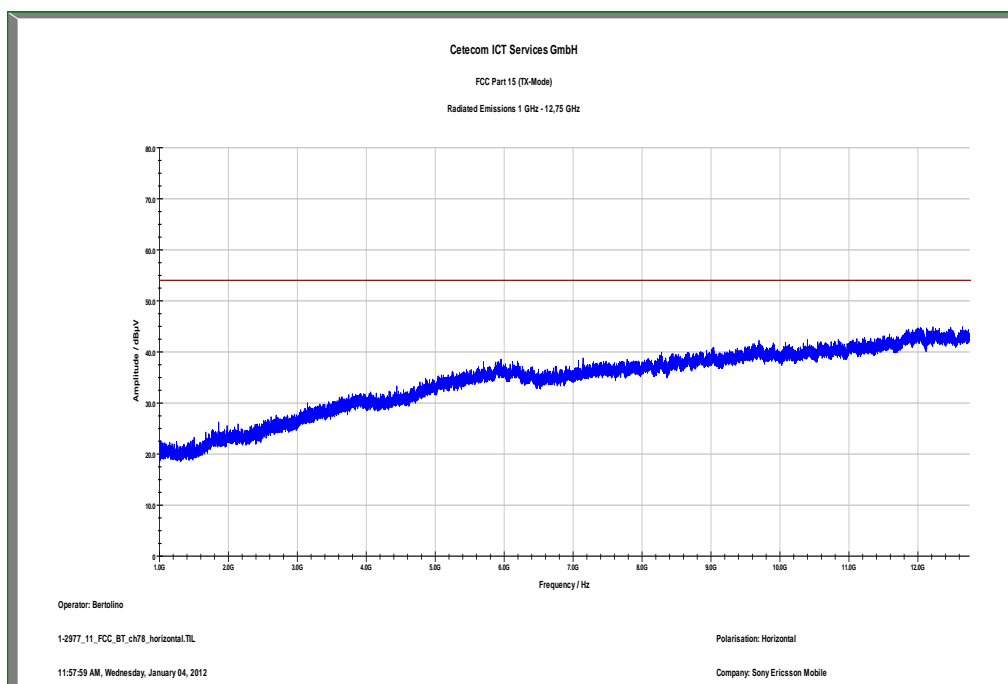

The carrier signal is notched with a 2.4 GHz band rejection filter.

Plot 14: 12.75 GHz to 18 GHz, TX mode, channel 78, vertical & horizontal polarization

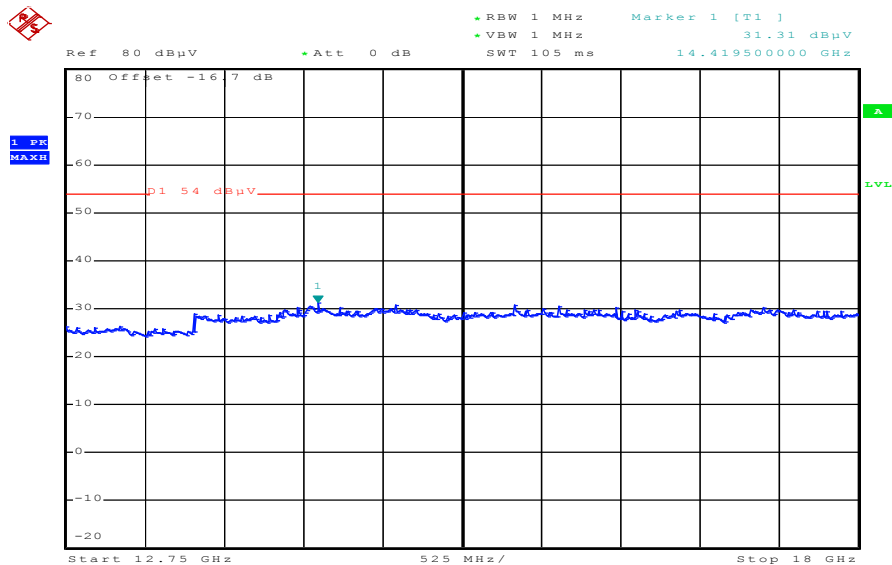

Date: 4.JAN.2012 14:41:20

Plot 15: 18 GHz to 26 GHz, TX mode, channel 78, vertical & horizontal polarization

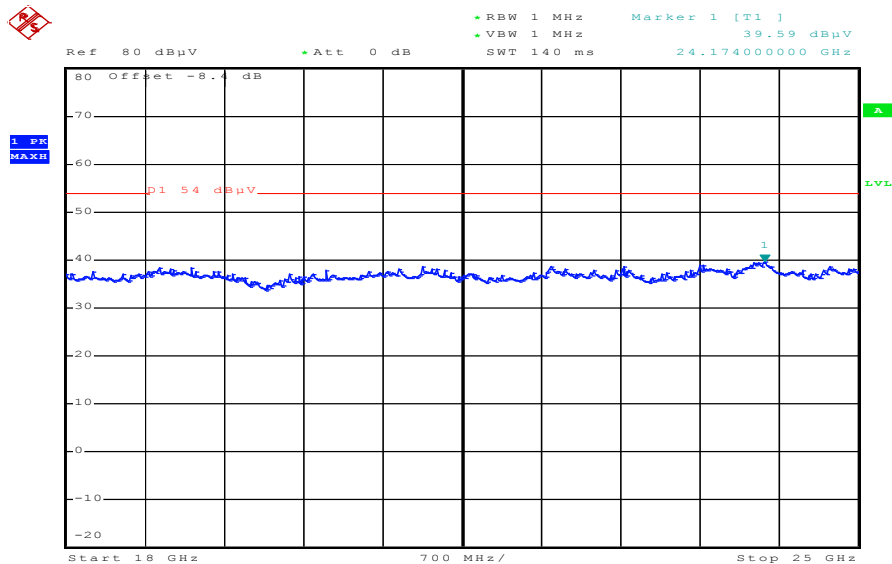

Date: 4.JAN.2012 15:12:51

9.12 RX spurious emissions radiated

Description:

Measurement of the radiated spurious emissions in idle/receive mode. The EUT is detached so all oscillators are active.

Measurement:

Measurement parameter	
Detector:	Peak / Quasi peak
Sweep time:	Auto
Video bandwidth:	Sweep: 100 kHz Remeasurement: 10 Hz
Resolution bandwidth:	F < 1 GHz: 100 kHz F > 1 GHz: 1 MHz
Span:	30 MHz to 25 GHz
Trace-Mode:	Max Hold

Limits:

FCC		IC	
CFR Part 15.109		RSS Gen, Issue 2, 4.10	
RX Spurious Emissions Radiated			
Frequency (MHz)	Field strength (dB μ V/m)	Measurement distance	
30 - 88	30.0	10	
88 - 216	33.5	10	
216 - 960	36.0	10	
Above 960	54.0	3	

Results:

RX spurious emissions radiated [dB μ V/m]		
F [MHz]	Detector	Level [dB μ V/m]
For emissions below 1 GHz, please take a look at the table below the 1 GHz plot.		
No critical emissions detected between 1 GHz and 12.75 GHz.		
For emissions above 12.75 GHz, please take a look at the plots.		
Measurement uncertainty	±3 dB	

Result: The result of the measurement is passed.

Plot 1: 30 MHz to 1 GHz, RX mode, vertical & horizontal polarization

Common Information

EUT: AAD-3880132-BV
 Serial Number: sample radiated 02
 Test Description: FCC part 15 class B @ 10 m
 Operating Conditions: charging + BT detached
 Operator Name: Wolsdorfer
 Comment: AC: 115 V / 60 Hz

Scan Setup: STAN_Fin [EMI radiated]

Hardware Setup: Electric Field (NOS)
 Receiver: [ESCI 3]
 Level Unit: dBµV/m
Subrange **Step Size** **Detectors** **IF BW** **Meas. Time** **Preamp**
 30 MHz - 2 GHz 60 kHz QPK 120 kHz 1 s 20 dB

FCC_10m(B)_3

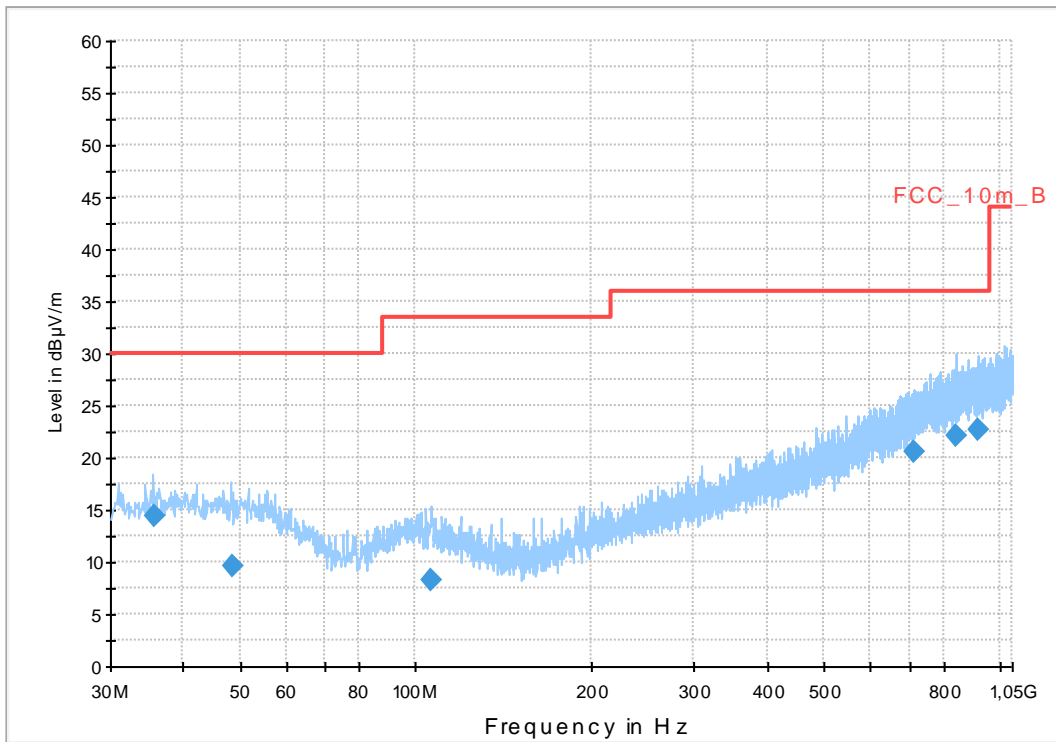

Final Result 1

Frequency (MHz)	QuasiPeak (dBµV/m)	Meas. Time (ms)	Bandwidth (kHz)	Height (cm)	Polarization	Azimuth (deg)	Corr. (dB)	Margin (dB)	Limit (dBµV/m)	Comment
35.732850	14.5	1000.0	120.000	106.0	V	259.0	13.1	15.5	30.0	
48.503250	9.7	1000.0	120.000	170.0	V	-7.0	13.3	20.3	30.0	
106.243650	8.2	1000.0	120.000	105.0	H	187.0	11.3	25.3	33.5	
711.159450	20.5	1000.0	120.000	170.0	V	95.0	22.8	15.5	36.0	
844.725300	22.2	1000.0	120.000	106.0	H	284.0	24.5	13.8	36.0	
915.663150	22.7	1000.0	120.000	98.0	V	80.0	25.2	13.3	36.0	

Hardware Setup: EMI radiated\Electric Field (NOS) - [EMI radiated]

Subrange 1	
Frequency Range:	30 MHz - 2 GHz
Receiver:	Receiver [ESCI 3] @ GPIB0 (ADR 20), SN 100083/003, FW 4.42
Signal Path:	without Notch FW 1.0
Antenna:	VULB 9163 SN 9163-295, FW --- Correction Table (vertical): VULP6113 Correction Table (horizontal): VULP6113
Antenna Tower:	Correction Table: Cable_EN_1GHz (1005) Tower [EMCO 2090 Antenna Tower] @ GPIB0 (ADR 8), FW REV 3.12
Turntable:	Turntable [EMCO Turntable] @ GPIB0 (ADR 9), FW REV 3.12

EMC 32 Version 8.10.00

Plot 2: 1 GHz to 12.75 GHz, RX mode, vertical polarization

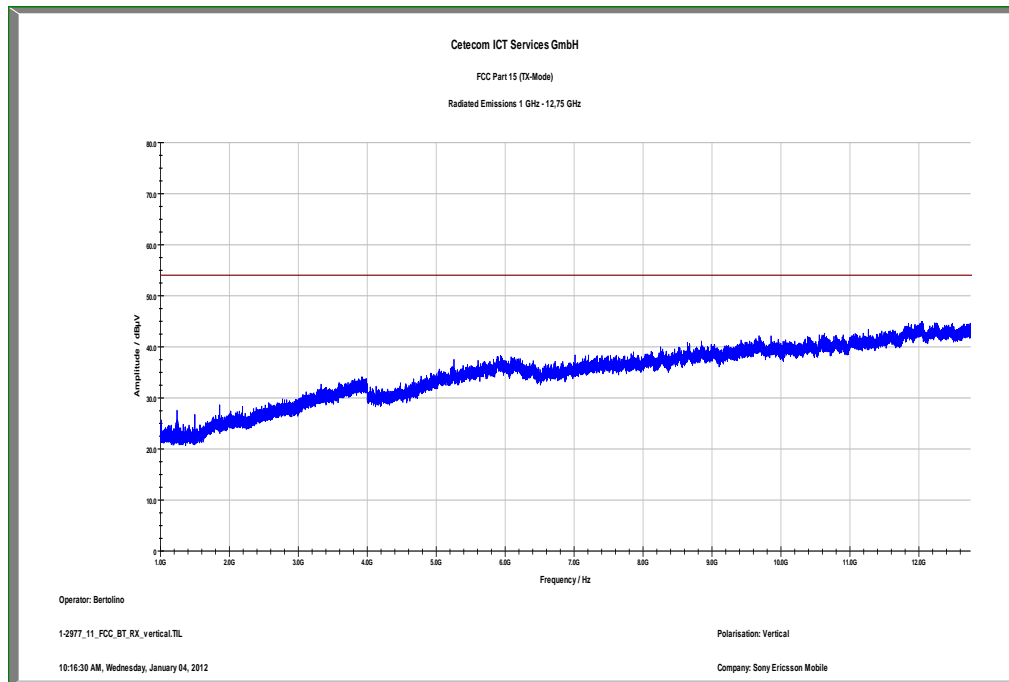

Plot 3: 1 GHz to 12.75 GHz, RX mode, horizontal polarization

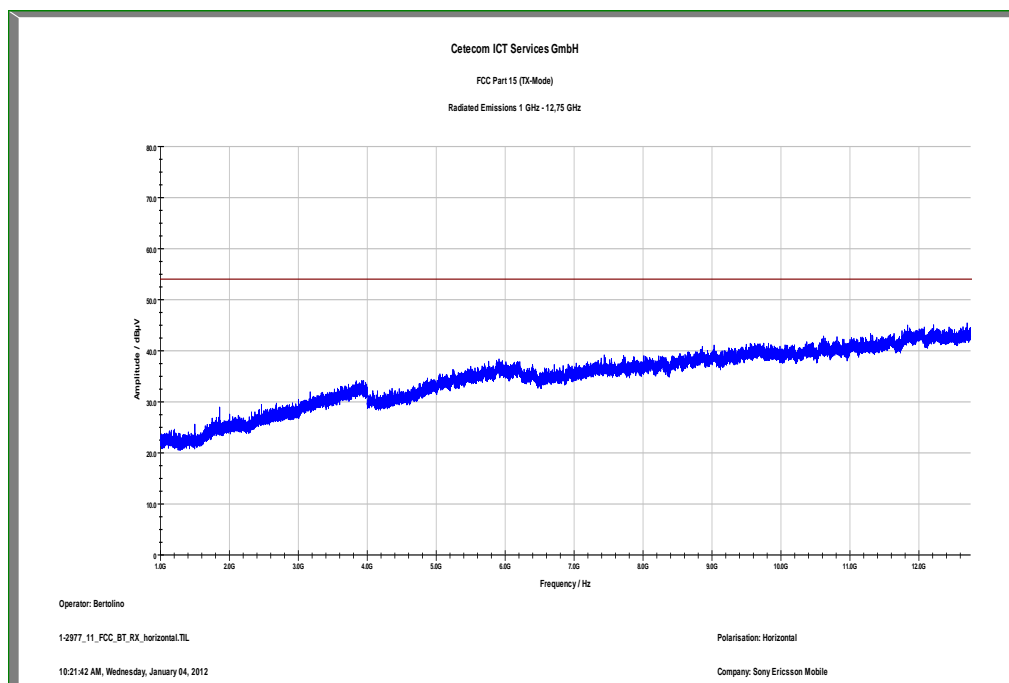

Plot 4: 12.75 GHz to 18 GHz, RX mode, vertical & horizontal polarization

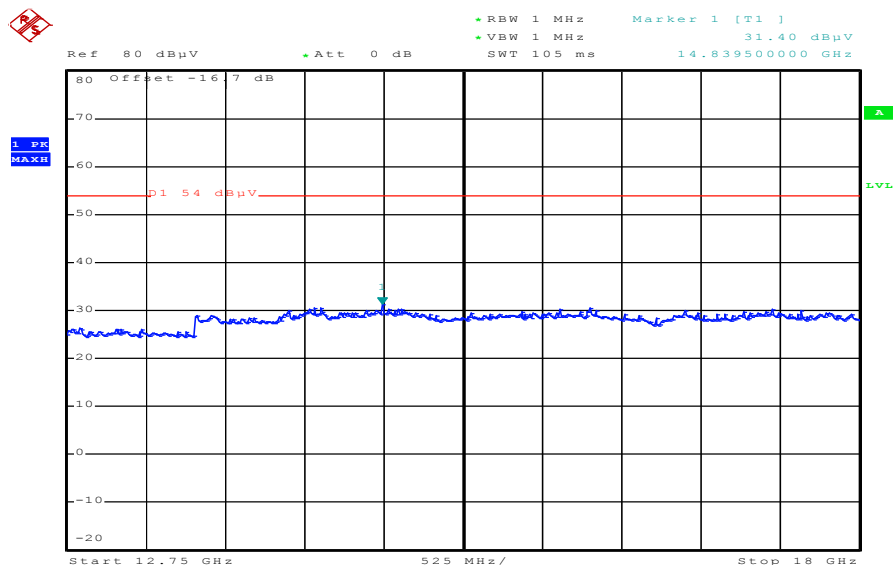

Date: 4.JAN.2012 14:42:20

Plot 5: 18 GHz to 26 GHz, RX mode, vertical & horizontal polarization

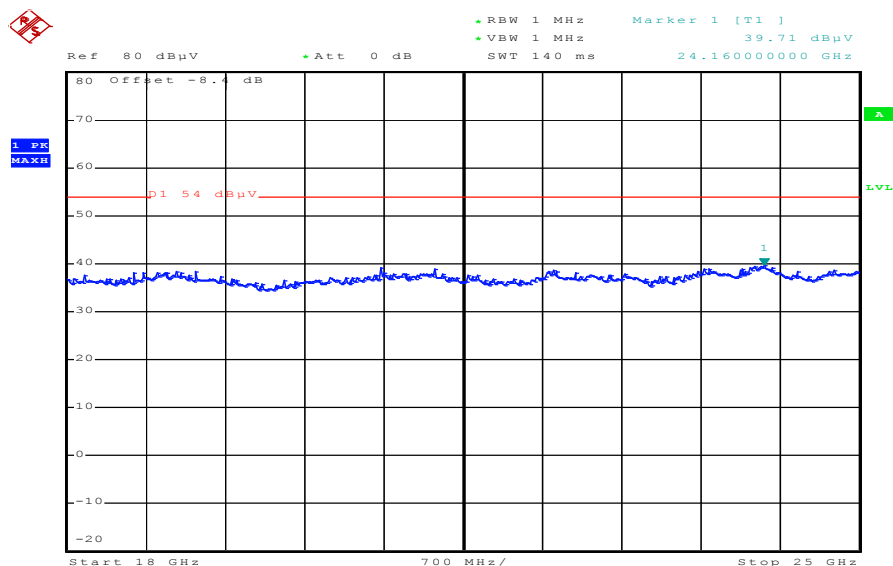

Date: 4.JAN.2012 15:07:18

9.13 TX spurious emissions radiated < 30 MHz

Description:

Measurement of the radiated spurious emissions in transmit mode below 30 MHz. The EUT is set to single channel mode and the transmit channel is channel 39. This measurement is representative for all channels and modes. If critical peaks are found channel 00 and channel 78 will be measured too. The measurement is performed in the mode with the highest output power. The limits are recalculated to a measurement distance of 3 m with 40 dB/decade according CFR Part 2.

Measurement:

Measurement parameter	
Detector:	Peak / Quasi peak
Sweep time:	Auto
Video bandwidth:	F < 150 kHz: 200 Hz F > 150 kHz: 9 kHz
Resolution bandwidth:	F < 150 kHz: 1 kHz F > 150 kHz: 100 kHz
Span:	9 kHz to 30 MHz
Trace-Mode:	Max Hold

Limits:

FCC		IC	
CFR Part 15.209(a)		RSS 210, Issue 8, 2.2	
TX spurious emissions radiated < 30 MHz			
Frequency (MHz)	Field strength (dBµV/m)	Measurement distance	
0.009 – 0.490	2400/F(kHz)	300	
0.490 – 1.705	24000/F(kHz)	30	
1.705 – 30.0	30	30	

Results:

TX spurious emissions radiated < 30 MHz [dBµV/m]		
F [MHz]	Detector	Level [dBµV/m]
No critical peaks detected.		
Measurement uncertainty	± 3 dB	

Result: The result of the measurement is passed.

Plots:

Plot 1: 9 kHz to 30 MHz, TX mode, channel 00

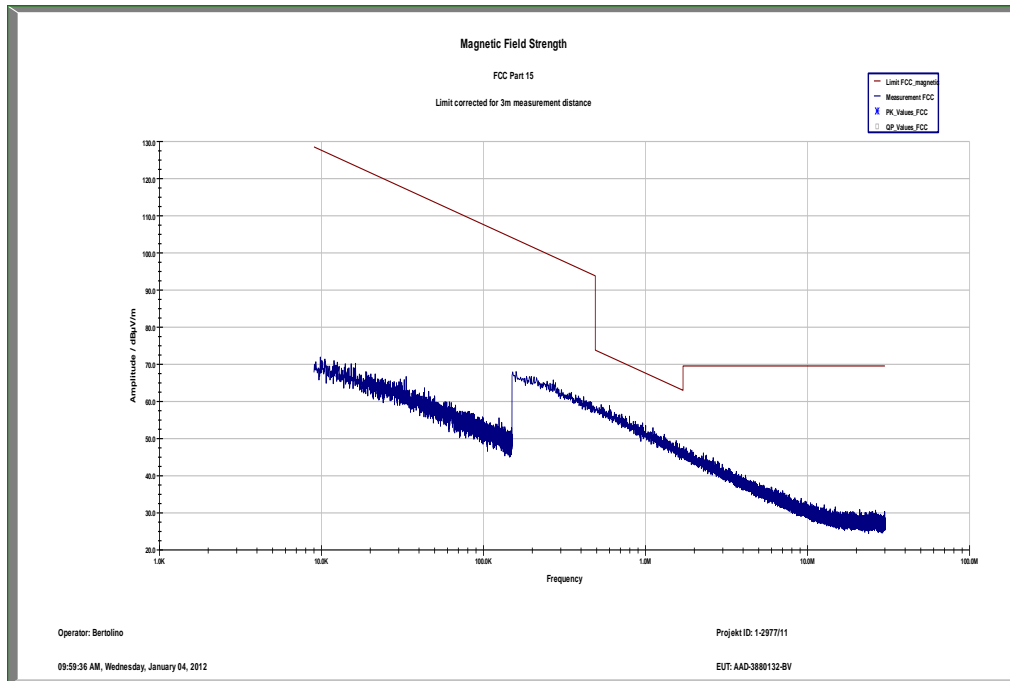

Plot 2: 9 kHz to 30 MHz, TX mode, channel 39

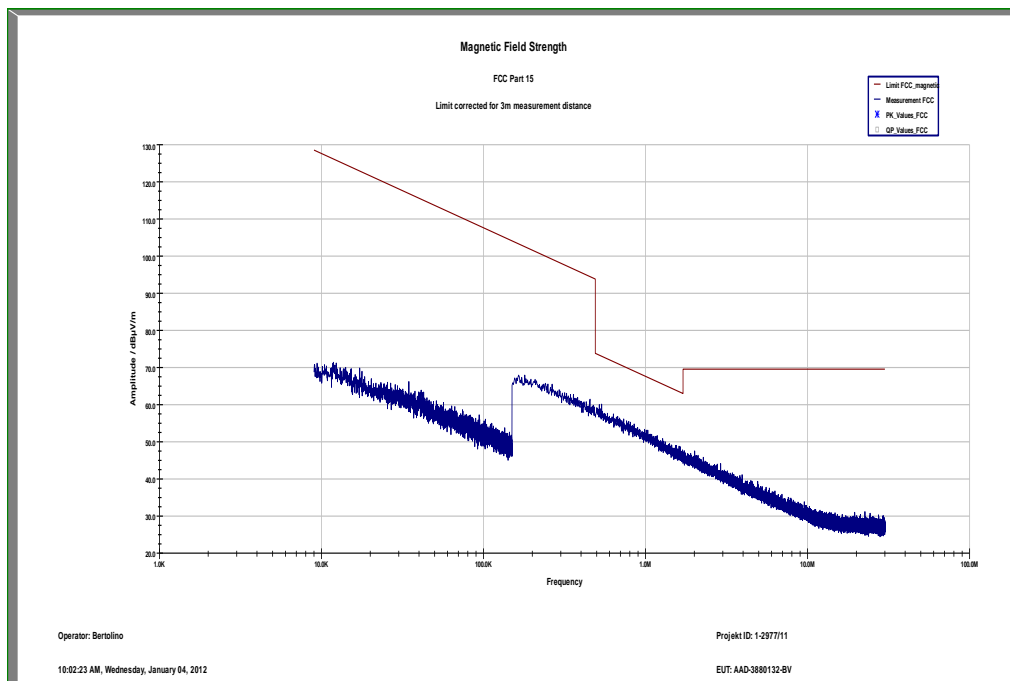

Plot 3: 9 kHz to 30 MHz, TX mode, channel 78

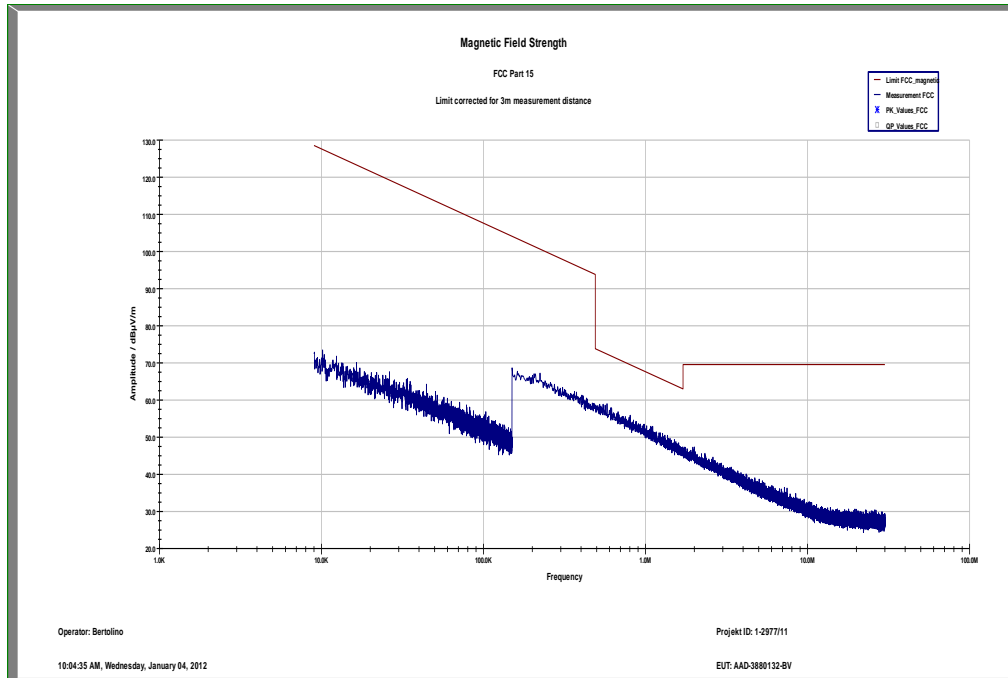

Plot 4: 9 kHz to 30 MHz, RX mode

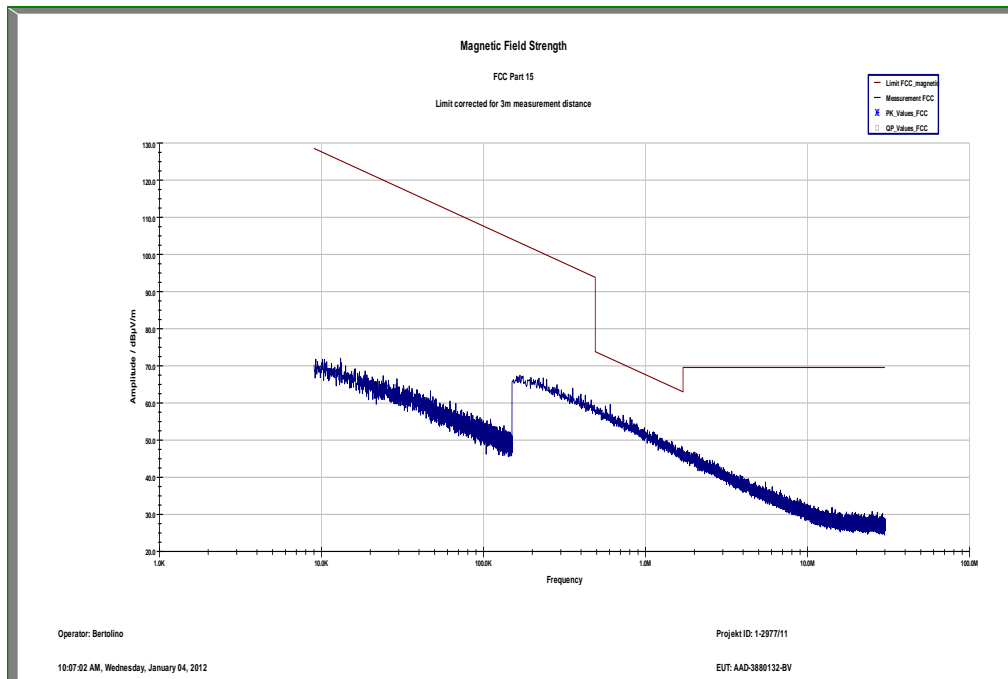

9.14 TX spurious emissions conducted < 30 MHz

Description:

Measurement of the conducted spurious emissions in transmit mode below 30 MHz. The EUT is set to single channel mode and the transmit channel is channel 39. This measurement is representative for all channels and modes. If critical peaks are found channel 00 and channel 78 will be measured too. The measurement is performed in the mode with the highest output power. Both power lines, phase and neutral line, are measured. Found peaks are remeasured with average and quasi peak detection to show compliance to the limits.

Measurement:

Measurement parameter	
Detector:	Peak - Quasi peak / average
Sweep time:	Auto
Video bandwidth:	F < 150 kHz: 200 Hz F > 150 kHz: 9 kHz
Resolution bandwidth:	F < 150 kHz: 1 kHz F > 150 kHz: 100 kHz
Span:	9 kHz to 30 MHz
Trace-Mode:	Max Hold

Limits:

FCC		IC	
CFR Part 15.107(a)		ICES-003, Issue 4	
TX spurious emissions conducted < 30 MHz			
Frequency (MHz)	Quasi-peak (dBµV/m)	Average (dBµV/m)	
0.15 – 0.5	66 to 56*	56 to 46*	
0.5 – 5	56	46	
5 – 30.0	60	50	

*Decreases with the logarithm of the frequency

Results:

TX spurious emissions conducted < 30 MHz [dBµV/m]		
F [MHz]	Detector	Level [dBµV/m]
No critical peaks detected		
Measurement uncertainty	± 3 dB	

Result: The result of the measurement is passed.

Plots:

Plot 1: 9 kHz to 30 MHz, TX mode, phase line

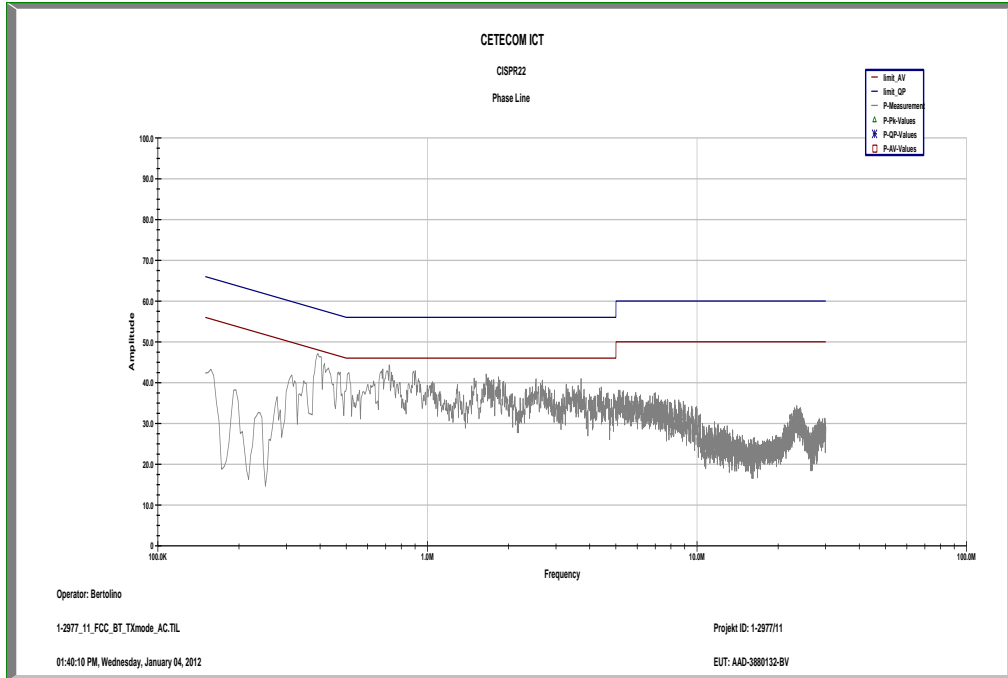

Plot 2: 9 kHz to 30 MHz, TX mode, neutral line

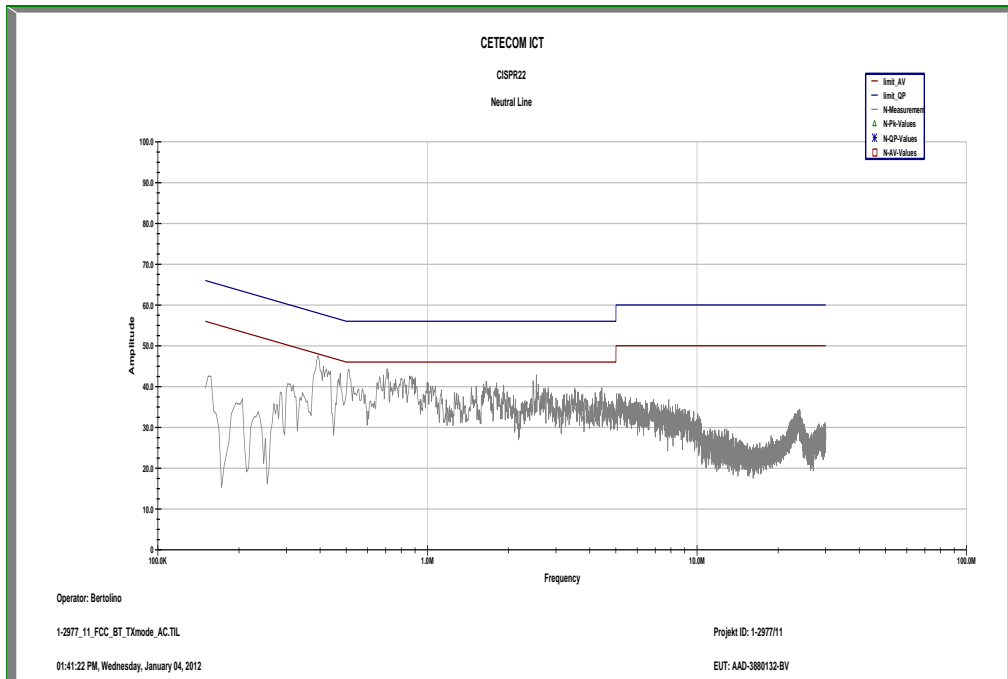

Plot 3: 9 kHz to 30 MHz, RX mode, phase line

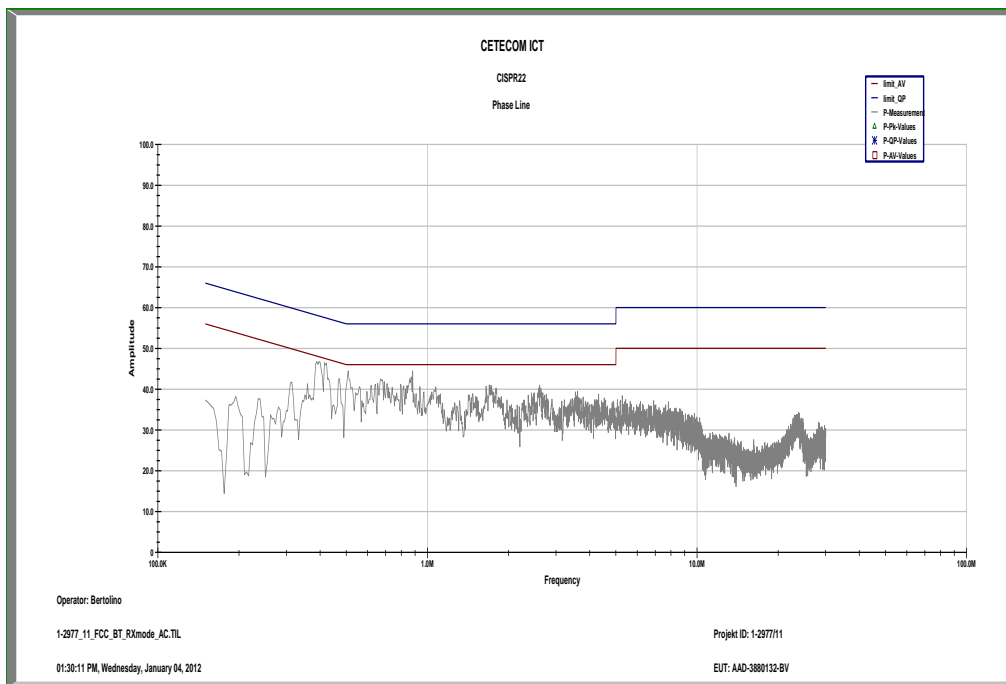

Plot 4: 9 kHz to 30 MHz, RX mode, neutral line

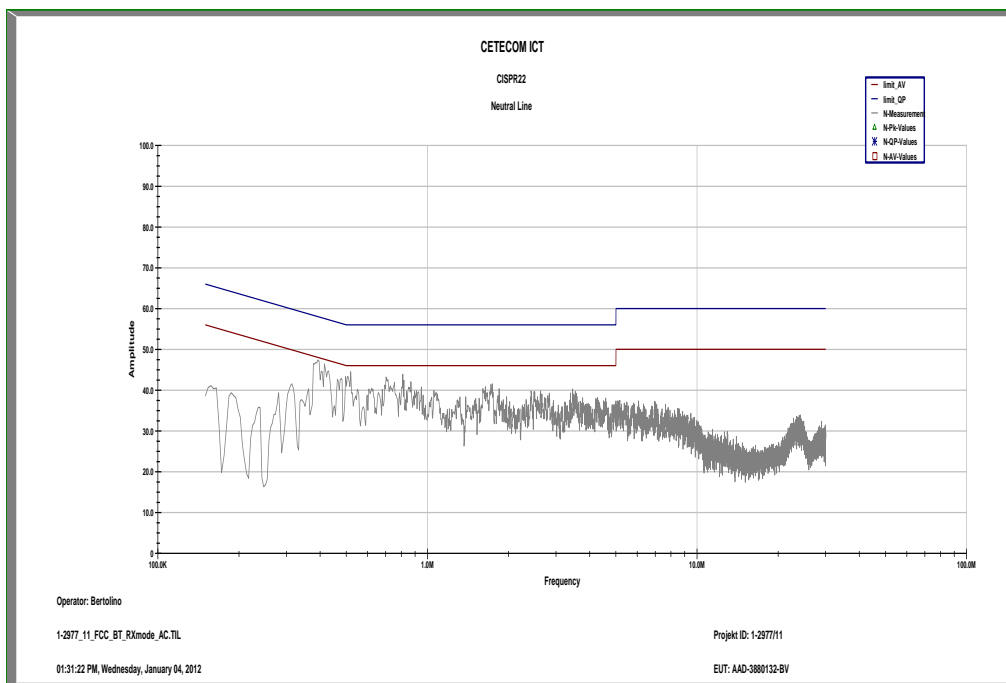

10 Test equipment and ancillaries used for tests

Typically, the calibrations of the test apparatus are commissioned to and performed by an accredited calibration laboratory. The calibration intervals are determined in accordance with the DIN EN ISO/IEC 17025. In addition to the external calibrations, the laboratory executes comparison measurements with other calibrated test systems or effective verifications. Weekly chamber inspections and range calibrations are performed. Where possible, rf-generating and signalling equipment as well as measuring receivers and analyzers are connected to an external high-precision 10 MHz reference (GPS-based or rubidium frequency standard).

In order to simplify the identification of the equipment used at some special tests, some items of test equipment and ancillaries can be provided with an identifier or number in the equipment list below (Labor/Item).

No.	Lab / Item	Equipment	Type	Manufact.	Serial No.	INV. No Cetecom	Kind of Calibration	Last Calibration	Next Calibration
1	n. a.	Double-Ridged Waveguide Horn Antenna 1-18.0GHz	3115	EMCO	8812-3088	300001032	vIKI!	11.05.2011	11.05.2013
2	n. a.	Anechoic chamber	FAC 3/5m	MWB / TDK	87400/02	300000996		23.03.2009	
3	n. a.	Relais Matrix	3488A	HP Meßtechnik	2719A15013	300001156	ne		
4	n. a.	Three-Way Power Splitter, 50 Ohm	11850C	HP Meßtechnik		300000997	ne		
5	n. a.	Switch / Control Unit	3488A	HP	2605e08770	300001443	ne		
6	n. a.	Amplifier	js42-00502650-28-5a	Parzich GMBH	928979	300003143	ne		
7	n. a.	Band Reject filter	WRCG2400/2483-2375/2505-50/10SS	Wainwright	11	300003351	ev		
8	n. a.	TILE-Software Emission	Quantum Change, Modell TILE-ICS/FULL	EMCO	none	300003451	ne		
9	n. a.	PSA Spectrum Analyzer 3 Hz - 26.5 GHz	E4440A	Agilent Technologies	MY48250080	300003812	k	08.09.2010	08.09.2012
10	n. a.	RF Filter Section 9kHz - 1GHz	N9039A	Agilent Technologies	MY48260003	300003825	vIKI!	08.09.2010	08.09.2012
11	n. a.	TRILOG Broadband Test-Antenna 30 MHz - 3 GHz	VULB9163	Schwarzbeck	371	300003854	vIKI!	14.10.2011	14.10.2014
12	n. a.	Switch / Control Unit	3488A	HP Meßtechnik		300001691	ne		
13	n. a.	Power Supply DC	NGPE 40/40	R&S	388	400000078	vIKI!	13.09.2010	13.09.2012
14	n. a.	Power Sensor 50 Ohms, 10 MHz - 18 GHz, 1 nW - 20 mW	NRV-Z1	R&S	833894/011	300002681-0010	k	09.09.2010	09.09.2012
15	n. a.	Hygro-Thermometer	-/, 5-45°C, 20-100%rF	Thies Klima	-/	400000080	k	04.08.2011	04.08.2012
16	n. a.	Dual Channel Power Meter	NRVD	R&S	835430/044	300002681-0004	k	13.09.2010	13.09.2012
17	n. a.	Signal Analyzer 20Hz-26,5GHz-150 to + 30 DBM	FSIQ26	R&S	835540/018	300002681-0005	k	07.01.2010	07.01.2012
18	n. a.	Frequency Standard (Rubidium Frequency Standard)	MFS (Rubidium)	R&S (Datum)	002	300002681-0009	Ve	13.09.2010	13.09.2012
19	n. a.	Directional Coupler	101020010	Krytar	70215	300002840	ev		
20	n. a.	DC-Blocker	8143	Inmet Corp.	none	300002842	ne		

21	n. a.	Powersplitter	6005-3	Inmet Corp.		300002841	ev		
22	n. a.	Temperature Test Chamber	VT 4002	Heraeus Voetsch	58566046820010	300003019	Ve	20.09.2011	20.09.2013
23	n. a.	CBT (Bluetooth Tester + EDR Signalling)	CBT 1153.9000K35	R&S	100185	300003416	vIKI!	13.09.2010	13.09.2012
24	n. a.	Spectrum Analyzer 9kHz to 30GHz - 140..+30dBm	FSP30	R&S	100886	300003575	k	07.09.2010	07.09.2012
25	n. a.	Power Supply 0-20V; 0-5A	6632B	HP	US37478366	400000117	k	09.09.2010	09.09.2012

Agenda: Kind of Calibration

k	calibration / calibrated	EK	limited calibration
ne	not required (k, ev, izw, zw not required)	zw	cyclical maintenance (external cyclical maintenance)
ev	periodic self verification	izw	internal cyclical maintenance
Ve	long-term stability recognized	g	blocked for accredited testing
vIkI!	Attention: extended calibration interval	*	next calibration ordered / currently in progress
NK!	Attention: not calibrated		

11 Observations

No observations exceeding those reported with the single test cases have been made.