

TEST REPORT

Test report no.: 1-2977-09-02/11



Testing laboratory

CETECOM ICT Services GmbH
Untertuerkheimer Straße 6 – 10
66117 Saarbruecken / Germany
Phone: + 49 681 5 98 - 0
Fax: + 49 681 5 98 - 9075
Internet: <http://www.cetecom.com>
e-mail: ict@cetecom.com

Accredited test laboratory:

The test laboratory (area of testing) is accredited according to DIN EN ISO/IEC 17025
DAR registration number: DGA-PL-176/94-D1

Area of Testing: Radio/Satellite Communications

Applicant

Sony Ericsson Mobile Communications AB
Nya Vattentornet
22188 Lund / Sweden
Phone: +46 46 19 30 00
Fax: +46 46 19 32 95
Contact: Johan Wedin
e-mail: johan.wedin@sonyericsson.com
Phone: +46 70 71 95 73 6

Manufacturer

Sony Ericsson Mobile Communications AB
Nya Vattentornet
22188 Lund / Sweden

Test standard/s

47 CFR Part 22	Title 47 of the Code of Federal Regulations; Chapter I Part 22 - Public mobile services
47 CFR Part 24	Title 47 of the Code of Federal Regulations; Chapter I Part 24 - Personal communications services
RSS - 132 Issue 2	Spectrum Management and Telecommunications Policy - Radio Standards Specifications Cellular Telephones Employing New Technologies Operating in the Bands 824-849 MHz and 869-894 MHz

For further applied test standards please refer to section 3 of this test report.

Test item

Kind of test item:	Mobile Phone GSM/EDGE 850,900,1800,1900; UMTS FDD1,FDD2,FDD5,FDD6; BT EDR, WLAN, A-GPS
Model name:	AAD-3880087-BV
FCC ID:	PY7A3880087
IC:	4170B-A3880087
Frequency [MHz]:	824.2 – 848.8 MHz, 1850.2 – 1909.8 MHz
Power supply:	3.60V DC by Li-Polymer Battery (BST-41) and Power Supply
Temperature range:	-30 °C to 60 °C

Test performed:

2011-02-18 Jakob Reschke

Test report authorised:

2011-02-18 Stefan Bös

1 Table of contents	
1	Table of contents2
2	General information4
2.1	Notes.....4
2.2	Application details.....4
3	Test standard/s4
4	Test environment.....4
5	Test item5
6	Test laboratories sub-contracted5
7	Summary of measurement results6
7.1	GSM 850.....6
7.2	PCS 19006
7.3	UMTS band II.....7
7.4	UMTS band V.....7
7.5	Receiver.....7
8	RF measurement testing.....8
8.1	Description of test setup8
8.1.1	Radiated measurements.....8
8.1.2	Conducted measurements.....9
8.2	RSP100 test report cover sheet / performance test data10
8.3	Results GSM 85011
8.3.1	RF output power11
8.3.2	Frequency stability.....13
8.3.3	Spurious emissions radiated16
8.3.4	Spurious emissions conducted.....20
8.3.5	Block edge compliance.....24
8.3.6	Occupied bandwidth27
8.4	Results PCS 190035
8.4.1	RF output power35
8.4.2	Frequency stability.....37
8.4.3	Spurious emissions radiated40
8.4.4	Spurious emissions conducted.....44
8.4.5	Block edge compliance.....48
8.4.6	Occupied bandwidth51
8.5	Results UMTS band II.....59
8.5.1	RF output power59
8.5.2	Frequency stability.....61
8.5.3	Spurious emissions radiated64
8.5.4	Spurious emissions conducted.....68
8.5.5	Block edge compliance.....72
8.5.6	Occupied bandwidth74
8.6	Results UMTS band V79
8.6.1	RF output power79
8.6.2	Frequency stability.....81
8.6.3	Spurious emissions radiated84
8.6.4	Spurious emissions conducted.....88
8.6.5	Block edge compliance.....92
8.6.6	Occupied bandwidth94

8.7	Results receiver mode	99
8.7.1	Spurious emissions radiated – receiver mode	99
9	Test equipment and ancillaries used for tests	104
Annex A	Document history	106
Annex B	Further information.....	106

2 General information

2.1 Notes

The test results of this test report relate exclusively to the test item specified in this test report. CETECOM ICT Services GmbH does not assume responsibility for any conclusions and generalisations drawn from the test results with regard to other specimens or samples of the type of the equipment represented by the test item. The test report may only be reproduced or published in full. Reproduction or publication of extracts from the report requires the prior written approval of CETECOM ICT Services GmbH.

2.2 Application details

Date of receipt of order:	2011-02-01
Date of receipt of test item:	2011-02-01
Start of test:	2011-02-01
End of test:	2011-02-17
Person(s) present during the test:	-/-

3 Test standard/s

Test standard	Version	Test standard description
47 CFR Part 22	2009-10	Title 47 of the Code of Federal Regulations; Chapter I Part 22 - Public mobile services
47 CFR Part 24	2009-10	Title 47 of the Code of Federal Regulations; Chapter I Part 24 - Personal communications services
RSS - 132 Issue 2	2005-09	Spectrum Management and Telecommunications Policy - Radio Standards Specifications Cellular Telephones Employing New Technologies Operating in the Bands 824-849 MHz and 869-894 MHz
RSS - 133 Issue 5	2009-02	Spectrum Management and Telecommunications Policy - Radio Standards Specifications 2 GHz Personal Communication Services

4 Test environment

Temperature:	T_{nom}	23 °C during room temperature tests
	T_{max}	60 °C during high temperature test
	T_{min}	-30 °C during low temperature test
Relative humidity content:		40 %
Air pressure:		not relevant for this kind of testing
Power supply:	V_{nom}	3.60 V DC by Li-Polymer Battery (BST-41) and Power Supply
	V_{max}	4.40 V
	V_{min}	3.30 V

5 Test item

Kind of test item	:	Mobile Phone GSM/EDGE 850,900,1800,1900; UMTS FDD1,FDD2,FDD5,FDD6; BT EDR, WLAN, A-GPS
Type identification	:	AAD-3880087-BV
S/N serial number	:	Rad. CB5A1CGKT0, CB5A1CGKSS Cond. CB5A1CGKRE
HW hardware status	:	AP2
SW software status	:	3.0.A.1.79
Frequency band [MHz]	:	824.2 – 848.8 MHz, 1850.2 – 1909.8 MHz
Type of modulation	:	GMSK; 8-PSK; QPSK; 16QAM
Antenna	:	Integrated antenna
Power supply	:	3.60 V DC by Li-Polymer Battery (BST-41) and Power Supply
Temperature range	:	-30°C to 60 °C

6 Test laboratories sub-contracted

None

7 Summary of measurement results

- No deviations from the technical specifications were ascertained
- There were deviations from the technical specifications ascertained

TC identifier	Description	verdict	date	Remark
RF-Testing	CFR Part 22, 24 RSS 132, 133	passed	2011-02-18	-/-

7.1 GSM 850

Test Case	temperature conditions	power source voltages	Pass	Fail	NA	NP	Remark
RF Output Power	Nominal	Nominal	<input checked="" type="checkbox"/>	<input type="checkbox"/>	<input type="checkbox"/>	<input type="checkbox"/>	
Frequency Stability	Nominal	Nominal	<input checked="" type="checkbox"/>	<input type="checkbox"/>	<input type="checkbox"/>	<input type="checkbox"/>	
Spurious Emissions Radiated	Nominal	Nominal	<input checked="" type="checkbox"/>	<input type="checkbox"/>	<input type="checkbox"/>	<input type="checkbox"/>	
Spurious Emissions Conducted	Nominal	Nominal	<input checked="" type="checkbox"/>	<input type="checkbox"/>	<input type="checkbox"/>	<input type="checkbox"/>	
Block Edge Compliance	Nominal	Nominal	<input checked="" type="checkbox"/>	<input type="checkbox"/>	<input type="checkbox"/>	<input type="checkbox"/>	
Occupied Bandwidth	Nominal	Nominal	<input checked="" type="checkbox"/>	<input type="checkbox"/>	<input type="checkbox"/>	<input type="checkbox"/>	

Note:

NA = Not applicable; NP = Not performed

7.2 PCS 1900

Test Case	temperature conditions	power source voltages	Pass	Fail	NA	NP	Remark
RF Output Power	Nominal	Nominal	<input checked="" type="checkbox"/>	<input type="checkbox"/>	<input type="checkbox"/>	<input type="checkbox"/>	
Frequency Stability	Nominal	Nominal	<input checked="" type="checkbox"/>	<input type="checkbox"/>	<input type="checkbox"/>	<input type="checkbox"/>	
Spurious Emissions Radiated	Nominal	Nominal	<input checked="" type="checkbox"/>	<input type="checkbox"/>	<input type="checkbox"/>	<input type="checkbox"/>	
Spurious Emissions Conducted	Nominal	Nominal	<input checked="" type="checkbox"/>	<input type="checkbox"/>	<input type="checkbox"/>	<input type="checkbox"/>	
Block Edge Compliance	Nominal	Nominal	<input checked="" type="checkbox"/>	<input type="checkbox"/>	<input type="checkbox"/>	<input type="checkbox"/>	
Occupied Bandwidth	Nominal	Nominal	<input checked="" type="checkbox"/>	<input type="checkbox"/>	<input type="checkbox"/>	<input type="checkbox"/>	

Note:

NA = Not applicable; NP = Not performed

7.3 UMTS band II

Test Case	temperature conditions	power source voltages	Pass	Fail	NA	NP	Remark
RF Output Power	Nominal	Nominal	<input checked="" type="checkbox"/>	<input type="checkbox"/>	<input type="checkbox"/>	<input type="checkbox"/>	
Frequency Stability	Nominal	Nominal	<input checked="" type="checkbox"/>	<input type="checkbox"/>	<input type="checkbox"/>	<input type="checkbox"/>	
Spurious Emissions Radiated	Nominal	Nominal	<input checked="" type="checkbox"/>	<input type="checkbox"/>	<input type="checkbox"/>	<input type="checkbox"/>	
Spurious Emissions Conducted	Nominal	Nominal	<input checked="" type="checkbox"/>	<input type="checkbox"/>	<input type="checkbox"/>	<input type="checkbox"/>	
Block Edge Compliance	Nominal	Nominal	<input checked="" type="checkbox"/>	<input type="checkbox"/>	<input type="checkbox"/>	<input type="checkbox"/>	
Occupied Bandwidth	Nominal	Nominal	<input checked="" type="checkbox"/>	<input type="checkbox"/>	<input type="checkbox"/>	<input type="checkbox"/>	

Note:

NA = Not applicable; NP = Not performed

7.4 UMTS band V

Test Case	temperature conditions	power source voltages	Pass	Fail	NA	NP	Remark
RF Output Power	Nominal	Nominal	<input checked="" type="checkbox"/>	<input type="checkbox"/>	<input type="checkbox"/>	<input type="checkbox"/>	
Frequency Stability	Nominal	Nominal	<input checked="" type="checkbox"/>	<input type="checkbox"/>	<input type="checkbox"/>	<input type="checkbox"/>	
Spurious Emissions Radiated	Nominal	Nominal	<input checked="" type="checkbox"/>	<input type="checkbox"/>	<input type="checkbox"/>	<input type="checkbox"/>	
Spurious Emissions Conducted	Nominal	Nominal	<input checked="" type="checkbox"/>	<input type="checkbox"/>	<input type="checkbox"/>	<input type="checkbox"/>	
Block Edge Compliance	Nominal	Nominal	<input checked="" type="checkbox"/>	<input type="checkbox"/>	<input type="checkbox"/>	<input type="checkbox"/>	
Occupied Bandwidth	Nominal	Nominal	<input checked="" type="checkbox"/>	<input type="checkbox"/>	<input type="checkbox"/>	<input type="checkbox"/>	

Note:

NA = Not applicable; NP = Not performed

7.5 Receiver

Test Case	temperature conditions	power source voltages	Pass	Fail	NA	NP	Remark
Spurious Emissions Radiated	Nominal	Nominal	<input checked="" type="checkbox"/>	<input type="checkbox"/>	<input type="checkbox"/>	<input type="checkbox"/>	

Note:

NA = Not applicable; NP = Not performed

8 RF measurement testing

8.1 Description of test setup

For the spurious measurements we use the substitution method according TIA/EIA 603.

8.1.1 Radiated measurements

The radiated emissions from the EUT are performed in a semi anechoic chamber. The EUT is placed on a conductive turntable and powered with nominal voltage. The signalling is performed either from outside the chamber with a signalling unit (AP or other) by air link using a signalling antenna or directly by special test software from the customer.

Semi anechoic chamber

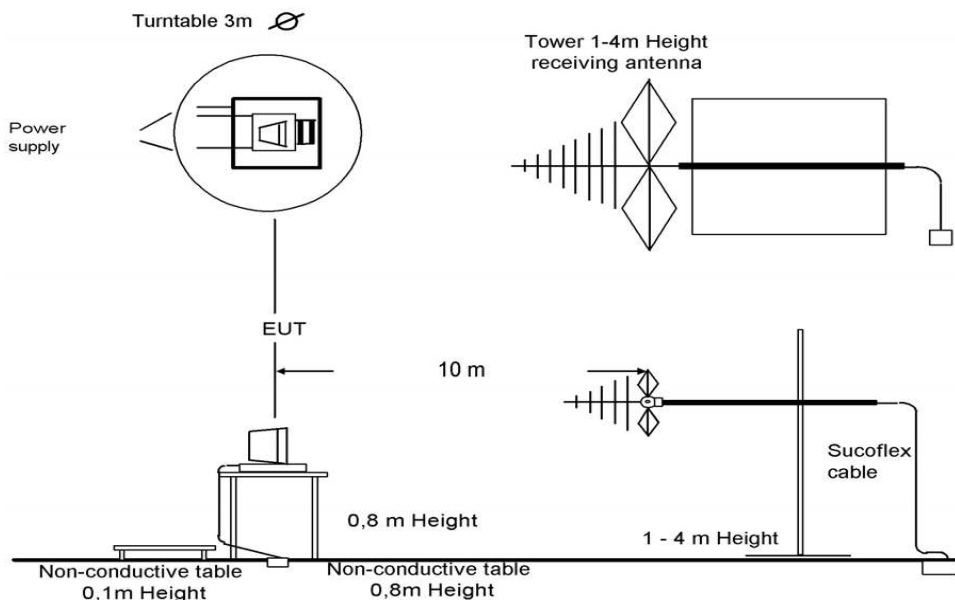

Picture 1: Diagram radiated measurements

9 kHz - 30 MHz:	active loop antenna
30 MHz – 1 GHz:	tri-log antenna
> 1 GHz:	horn antenna

8.1.2 Conducted measurements

The EUT's RF signal is coupled out by the antenna connector which is supplied by the manufacturer. The signal is first 10dB attenuated before it is power divided (~6dB loss per branch). One of the signal paths is connected to the signalling unit (AP or other), the other one is connected to the spectrum analyzer. The specific losses for both signal paths are first checked within a calibration. The measurement readings on the signalling unit/spectrum analyzer are corrected by the specific test set-up loss. The attenuator, power divider, signalling unit and the spectrum analyzer are impedance matched on 50 Ohm. If special software is used, there is no power divider necessary.

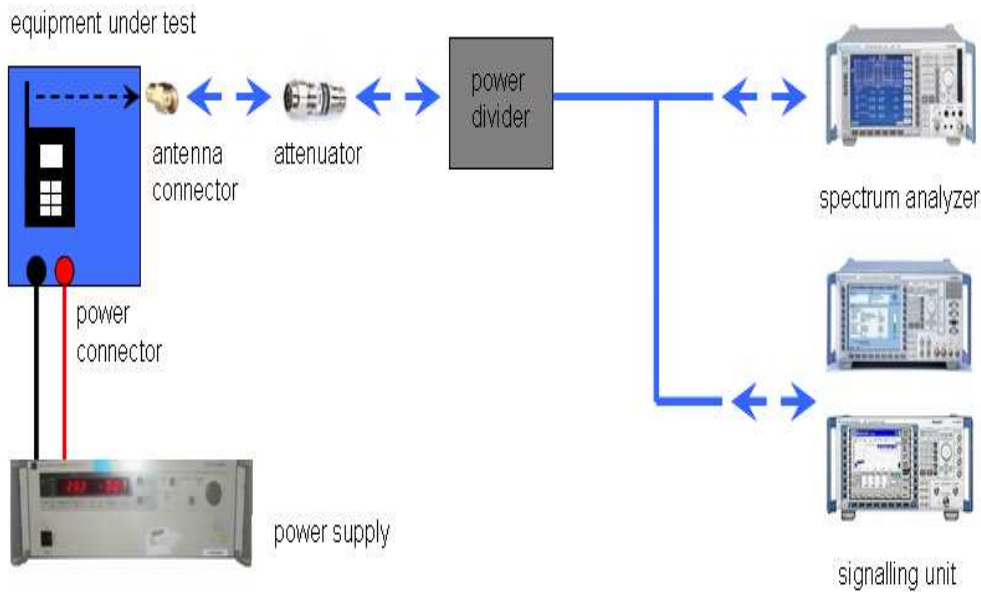

Picture 2: Diagram conducted measurements

The term measuring receiver refers to either a selective voltmeter or a spectrum analyser.

Frequency being measured f	Measuring receiver bandwidth 6 dB	Spectrum analyser bandwidth 3dB
$f < 150 \text{ kHz}$	200 Hz or	300 Hz
$150 \text{ kHz} \leq f < 25 \text{ MHz}$	9 kHz or	10 kHz
$25 \text{ MHz} \leq f < 1000 \text{ MHz}$	120 kHz or	100 kHz
$1000 \text{ MHz} \leq f$		1 MHz
NOTE: Specific requirements in CEPT/ERC/Recommendation 70-03 [2] shall be applied where applicable.		

8.2 RSP100 test report cover sheet / performance test data

Test Report Number	:	1-2977-09-02/11			
Equipment Model Number	:	AAD-3880087-BV			
Certification Number	:	4170B-A3880087			
Manufacturer (complete Address)	:	Sony Ericsson Mobile Communications AB Nya Vattentornet 22188 Lund / Sweden			
Tested to radio standards specification no.	:	RSS 210, Issue 8, Annex 8			
Open Area Test Site IC No.	:	IC 3462C-1			
Frequency Range	:	824.2 – 848.8 MHz, 1850.2 – 1909.8 MHz			
GPS receiver turned	:	On			
RF-power [W] (max.)	:	Band	Conducted	ERP / EIRP	Mode
		GSM850	32.32 dBm	29.80 dBm	GMSK
			26.15 dBm	23.73 dBm	8-PSK
		GSM1900	29.90 dBm	31.85 dBm	GMSK
			26.59 dBm	28.60 dBm	8-PSK
		WDCMA 850	24.43 dBm	21.94 dBm	QPSK
WDCMA 1900	24.10 dBm	26.02 dBm	QPSK		
Occupied bandwidth (99%-BW) [kHz]	:	GSM850	279		GMSK
			279		8-PSK
		GSM1900	275		GMSK
			281		8-PSK
		WDCMA 850	4545		QPSK
		WDCMA 1900	4569		QPSK
Type of modulation	:	GMSK; 8-PSK; QPSK; 16QAM			
Emission Designator (TRC-43)	:	GSM850	279KGXW		GMSK
			279KG7W		8-PSK
		GSM1900	275KGXW		GMSK
			281KG7W		8-PSK
		WDCMA 850	4M54F9W		QPSK
		WDCMA 1900	4M56F9W		QPSK
Antenna Information	:	integrated antenna			
Transmitter Spurious (worst case) [dBm]	:	-24.53 dBm @ 5729.40 MHz			
Receiver Spurious (worst case) [µV/m @ 3m]:	:	100 µV/m (noise floor)			

ATTESTATION:

DECLARATION OF COMPLIANCE:

I attest that the testing was performed or supervised by me; that the test measurements were made in accordance with the above-mentioned Industry Canada standard(s); and that the equipment identified in this application has been subjected to all the applicable test conditions specified in the Industry Canada standards and all of the requirements of the standard have been met.

Laboratory Manager:

2011-02-18
Date

Jakob Reschke
Name

Signature

8.3 Results GSM 850

All GSM-band measurements are done in GSM mode only (circuit switched).

All relevant tests have been repeated using 8-PSK modulation if EDGE mode is supported. All tests were performed with one timeslot in uplink activated and one timeslot in downlink activated. For each mode the highest output power was determined and used.

8.3.1 RF output power

Description:

This paragraph contains average power, peak output power and ERP measurements for the mobile station. In all cases, the peak output power is within the required mask (this mask is specified in the JTC standards, TIA PN3389 Vol. 1 Chap 7, and is no FCC requirement).

Measurement:

The mobile was set up for the maximum output power with pseudo random data modulation.

Measurement parameters	
Detector:	Peak and RMS (Power in Burst)
Sweep time:	Auto
Video bandwidth:	1 MHz
Resolution bandwidth:	1 MHz
Span:	Zero Span
Trace-Mode:	Max Hold

Limits:

FCC	IC
CFR Part 22.9.1.3 CFR Part 2.1046	RSS 132, Issue 2, Section 4.4 and 6.4
Nominal Peak Output Power	
+38.45 dBm	
In measuring transmissions in this band using an average power technique, the peak-to-average ratio (PAR) of the transmission may not exceed 13 dB.	

Results:

Output Power (conducted) GMSK mode		
Frequency (MHz)	Average Output Power (dBm)	Peak to Average Ratio (dB)
824.2	32.32	0.27
836.4	31.99	0.30
848.8	32.02	0.31
Measurement uncertainty	± 0.5 dB	

Output Power (conducted) 8-PSK mode		
Frequency (MHz)	Average Output Power (dBm)	Peak to Average Ratio (dB)
824.2	25.99	3.34
836.4	26.15	3.18
848.8	25.95	3.22
Measurement uncertainty	± 0.5 dB	

Output Power (radiated) GMSK mode	
Frequency (MHz)	Average Output Power (dBm) - ERP
824.2	29.40
836.4	29.44
848.8	29.80
Measurement uncertainty	± 2.0 dB

Output Power (radiated) 8-PSK mode	
Frequency (MHz)	Average Output Power (dBm) - ERP
824.2	23.07
836.4	23.60
848.8	23.73
Measurement uncertainty	± 2.0 dB

Result: The result of the measurement is passed.

8.3.2 Frequency stability

Description:

In order to measure the carrier frequency under the condition of AFC lock, it is necessary to make measurements with the mobile station in a “call mode”. This is accomplished with the use of a R&S CMU200 DIGITAL RADIOCOMMUNICATION TESTER.

1. Measure the carrier frequency at room temperature.
2. Subject the mobile station to overnight soak at -30 C.
3. With the mobile station, powered with V_{nom} , connected to the CMU200 and in a simulated call on channel 189 (centre channel), measure the carrier frequency. These measurements should be made within two minutes of powering up the mobile station, to prevent significant self warming.
4. Repeat the above measurements at 10°C increments from -30°C to +60°C. Allow at least 1.5 hours at each temperature, unpowered, before making measurements.
5. Remeasure carrier frequency at room temperature with V_{nom} . Vary supply voltage from V_{min} to V_{max} , in 0.1 Volt steps remeasuring carrier frequency at each voltage. Pause at V_{nom} for 1.5 hours unpowered, to allow any self heating to stabilize, before continuing.
6. At all temperature levels hold the temperature to +/- 0.5°C during the measurement procedure.

Measurement:

Measurement parameters	
Detector:	Measured with CMU200
Sweep time:	
Video bandwidth:	
Resolution bandwidth:	
Span:	
Trace-Mode:	

Limits:

FCC	IC
CFR Part 22.355 CFR Part 2.1055	RSS 132, Issue 2, Section 4.3 and 6.3
Frequency Stability	
± 0.1 ppm	

Results:**AFC FREQ ERROR versus VOLTAGE**

Voltage (V)	Frequency Error (Hz)	Frequency Error (%)	Frequency Error (ppm)
3.3	-22	-0,00000263	-0,0263
3.4	-21	-0,00000251	-0,0251
3.5	-20	-0,00000239	-0,0239
3.6	-18	-0,00000215	-0,0215
3.7	-17	-0,00000203	-0,0203
3.8	-19	-0,00000227	-0,0227
3.9	-20	-0,00000239	-0,0239
4.0	-21	-0,00000251	-0,0251
4.1	-22	-0,00000263	-0,0263
4.2	-23	-0,00000275	-0,0275
4.3	-21	-0,00000251	-0,0251
4.4	-22	-0,00000263	-0,0263

AFC FREQ ERROR versus TEMPERATURE

Temperature (°C)	Frequency Error (Hz)	Frequency Error (%)	Frequency Error (ppm)
-30	-19	-0,00000227	-0,0227
-20	-20	-0,00000239	-0,0239
-10	-20	-0,00000239	-0,0239
± 0	-21	-0,00000251	-0,0251
10	-29	-0,00000347	-0,0347
20	-17	-0,00000203	-0,0203
30	-18	-0,00000215	-0,0215
40	-20	-0,00000239	-0,0239
50	-21	-0,00000251	-0,0251
60	-19	-0,00000227	-0,0227

Frequency Error vs. Voltage

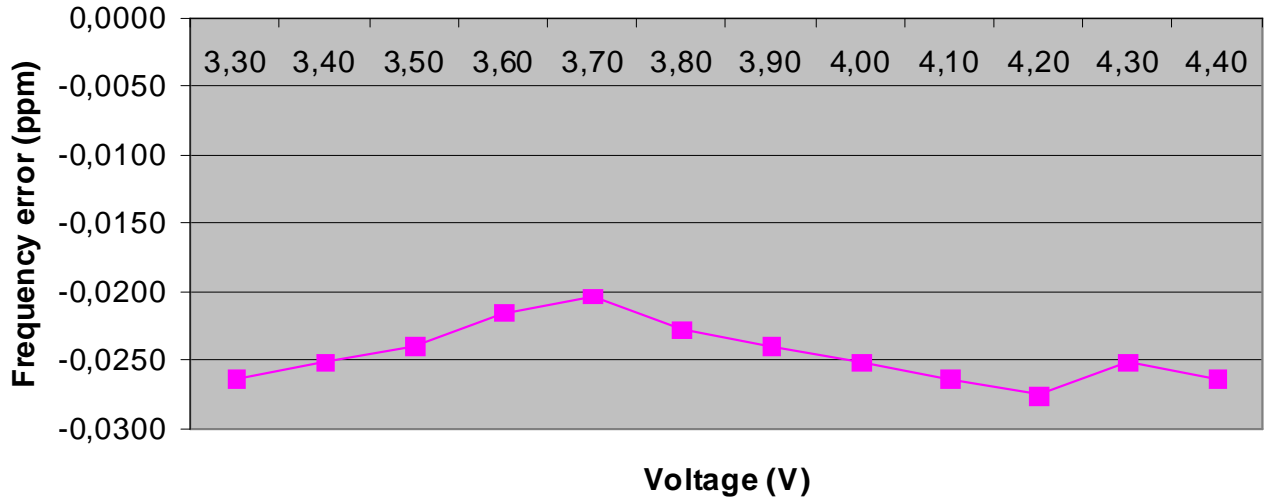

Frequency Error vs. Temperature

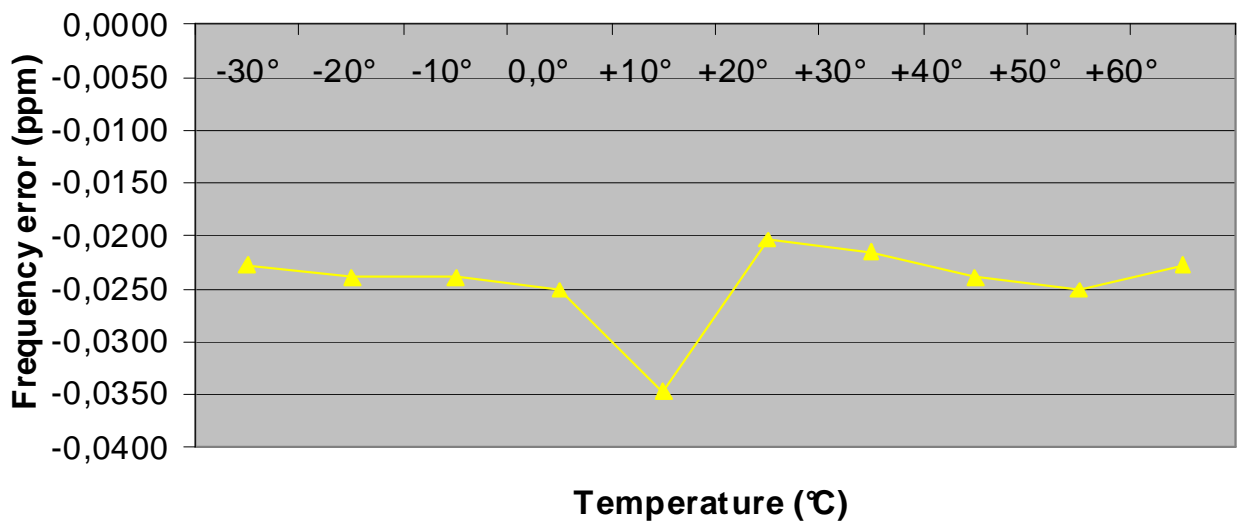

Result: The result of the measurement is passed.

8.3.3 Spurious emissions radiated

Description:

The following steps outline the procedure used to measure the radiated emissions from the mobile station. The site is constructed in accordance with ANSI C63.4:2009 requirements and is recognized by the FCC to be in compliance for a 3 and a 10 meter site. The spectrum was scanned from 30 MHz to the 10th harmonic of the highest frequency generated within the equipment, which is the transmitted carrier that can be as high as 848.8 MHz. This was rounded up to 12 GHz. The resolution bandwidth is set as outlined in Part 22.917. The spectrum was scanned with the mobile station transmitting at carrier frequencies that pertain to low, mid and high channels of the GSM-850 band.

The final open field emission (here 10m semi-anechoic chamber listed by FCC) test procedure is as follows:

- a) The test item was placed on a 0.8 meter high non-conductive stand at a 3 meter test distance from the receive antenna.
- b) The antenna output was terminated in a 50 ohm load (if possible).
- c) A double ridged wave guide antenna was placed on an adjustable height antenna mast 3 meters from the test item for emission measurements.
- d) Detected emissions were maximized at each frequency by rotating the test item and adjusting the receive antenna height and polarization. The maximum meter reading was recorded. The radiated emission measurements of the harmonics of the transmit frequency through the 10th harmonic were measured with peak detector and 1 MHz bandwidth. If the harmonic could not be detected above the noise floor, the ambient level was recorded. The equivalent power into a dipole antenna was calculated from the field intensity levels measured at 3 meters.
- e) Now each detected emissions were substituted by the substitution method, in accordance with the TIA/EIA 603 .

Measurement:

Measurement parameters	
Detector:	Peak
Sweep time:	2 sec.
Video bandwidth:	Below 1 GHz: 120 kHz Above 1 GHz: 1 MHz
Resolution bandwidth:	Below 1 GHz: 120 kHz Above 1 GHz: 1 MHz
Span:	100 MHz Steps
Trace-Mode:	Max Hold

Limits:

FCC	IC
CFR Part 22.917 CFR Part 2.1053	RSS 132, Issue 2, Section 4.5 and 6.5
Spurious Emissions Radiated	
Attenuation $\geq 43 + 10\log(P)$ (P, Power in Watts)	
-13 dBm	

Results:

Radiated emissions measurements were made only at the upper, center, and lower carrier frequencies of the GSM-850 band (824.2 MHz, 836.4 MHz and 848.8 MHz). It was decided that measurements at these three carrier frequencies would be sufficient to demonstrate compliance with emissions limits because it was seen that all the significant spurs occur well outside the band and no radiation was seen from a carrier in one block of the GSM-850 band into any of the other blocks. The equipment must still, however, meet emissions requirements with the carrier at all frequencies over which it is capable of operating and it is the manufacturer's responsibility to verify this.

The final open field radiated levels are presented on the next pages.

All measurements were done in horizontal and vertical polarization; the plots show the worst case.

The plots show only the middle channel. If spurious were detected, the lowest and highest channel were checked too. The found values are stated in the table below.

As can be seen from this data, the emissions from the test item were within the specification limit.

Spurious Emission Level (dBm)								
Harmonic	Ch. 128 Freq. (MHz)	Level [dBm]	Harmonic	Ch. 189 Freq. (MHz)	Level [dBm]	Harmonic	Ch. 251 Freq. (MHz)	Level [dBm]
2	1648.4	-47.05	2	1672.8	-45.80	2	1697.6	-46.20
3	2472.6	-34.50	3	2509.2	-34.50	3	2546.4	-32.10
4	3296.8	-	4	3345.6	-	4	3395.2	-
5	4121.0	-	5	4182.0	-	5	4244.0	-
6	4945.2	-	6	5018.4	-	6	5092.8	-
7	5769.4	-	7	5854.8	-	7	5941.6	-
8	6593.6	-	8	6691.2	-	8	6790.4	-
9	7417.8	-	9	7527.6	-	9	7639.2	-
10	8242.0	-	10	8364.0	-	10	8488.0	-
Measurement uncertainty					± 3dB			

Result: The result of the measurement is passed.

Plot 1: Channel 189 (Traffic mode up to 30 MHz)

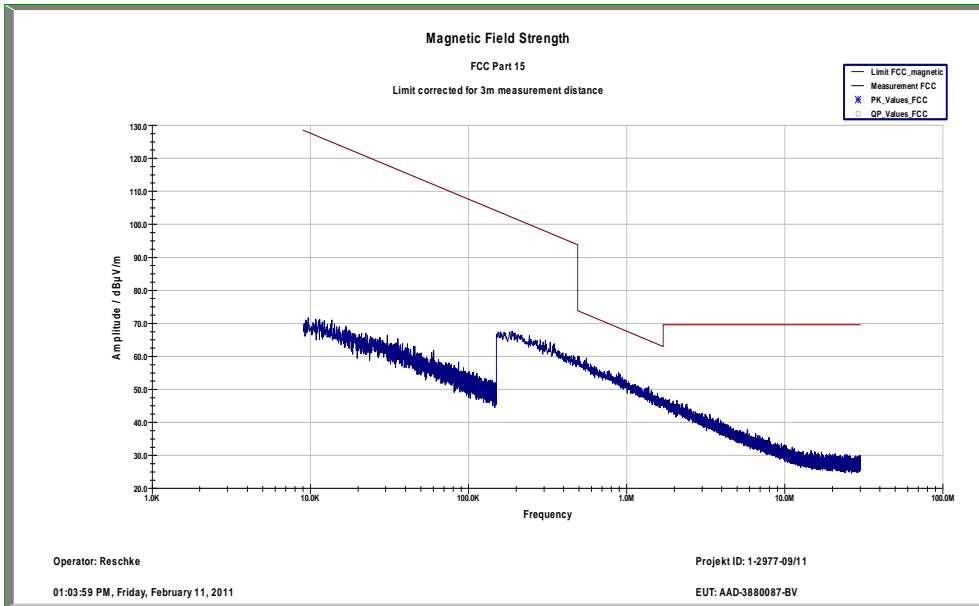

Plot 2: Channel 189 (30 MHz - 1 GHz)

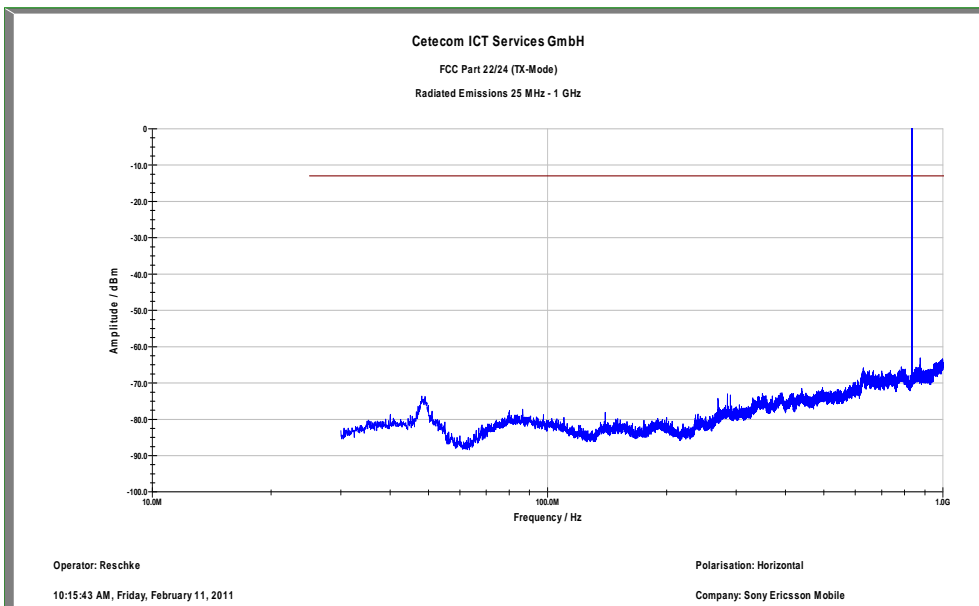

Plot 3: Channel 189 (1 GHz – 12.75 GHz)

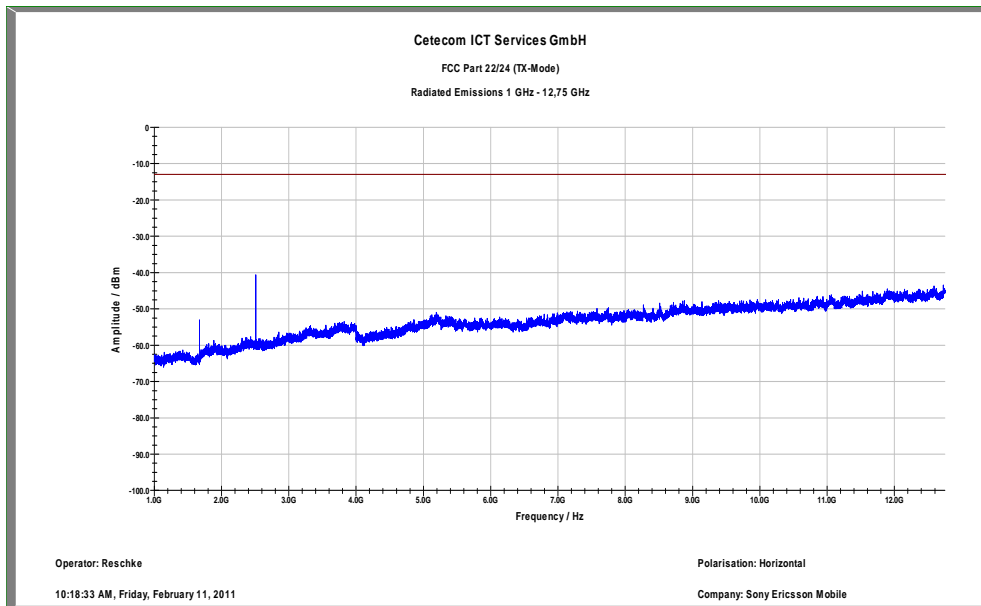

8.3.4 Spurious emissions conducted

Description:

The following steps outline the procedure used to measure the conducted emissions from the mobile station.

1. Determine frequency range for measurements: From CFR 2.1057 the spectrum should be investigated from the lowest radio frequency generated in the equipment up to at least the 10th harmonic of the carrier frequency. For the mobile station equipment tested, this equates to a frequency range of 13 MHz to 9 GHz, data taken from 10 MHz to 12 GHz.
2. Determine mobile station transmits frequencies: below outlines the band edge frequencies pertinent to conducted emissions testing.

GSM-850 Transmitter Channel Frequency

128 824.2 MHz

189 836.4 MHz

251 848.8 MHz

Measurement:

Measurement parameters	
Detector:	Peak
Sweep time:	Auto
Video bandwidth:	Pre-measurement with 1 MHz On spurious detection re-measurement below 1 GHz with 100 kHz Above 1 GHz with 1 MHz
Resolution bandwidth:	Pre-measurement with 1 MHz On spurious detection re-measurement below 1 GHz with 100 kHz Above 1 GHz with 1 MHz
Span:	30 MHz – 25 GHz
Trace-Mode:	Max Hold

Limits:

FCC	IC
CFR Part 22.917 CFR Part 2.1051	RSS 132, Issue 2, Section 4.5 and 6.5
Spurious Emissions Conducted	
Attenuation $\geq 43 + 10\log(P)$ (P, Power in Watts)	
-13 dBm	

Results:

Spurious Emission Level (dBm)								
Harmonic	Ch. 128 Freq. (MHz)	Level [dBm]	Harmonic	Ch. 189 Freq. (MHz)	Level [dBm]	Harmonic	Ch. 251 Freq. (MHz)	Level [dBm]
2	1648.4	-	2	1672.8	-	2	1697.6	-
3	2472.6	-	3	2509.2	-	3	2546.4	-
4	3296.8	-	4	3345.6	-	4	3395.2	-
5	4121.0	-	5	4182.0	-	5	4244.0	-
6	4945.2	-	6	5018.4	-	6	5092.8	-
7	5769.4	-	7	5854.8	-	7	5941.6	-
8	6593.6	-	8	6691.2	-	8	6790.4	-
9	7417.8	-	9	7527.6	-	9	7639.2	-
10	8242.0	-	10	8364.0	-	10	8488.0	-
Measurement uncertainty					± 3dB			

Result: The result of the measurement is passed.

Plot 1: Channel 128 (30 MHz - 25 GHz)

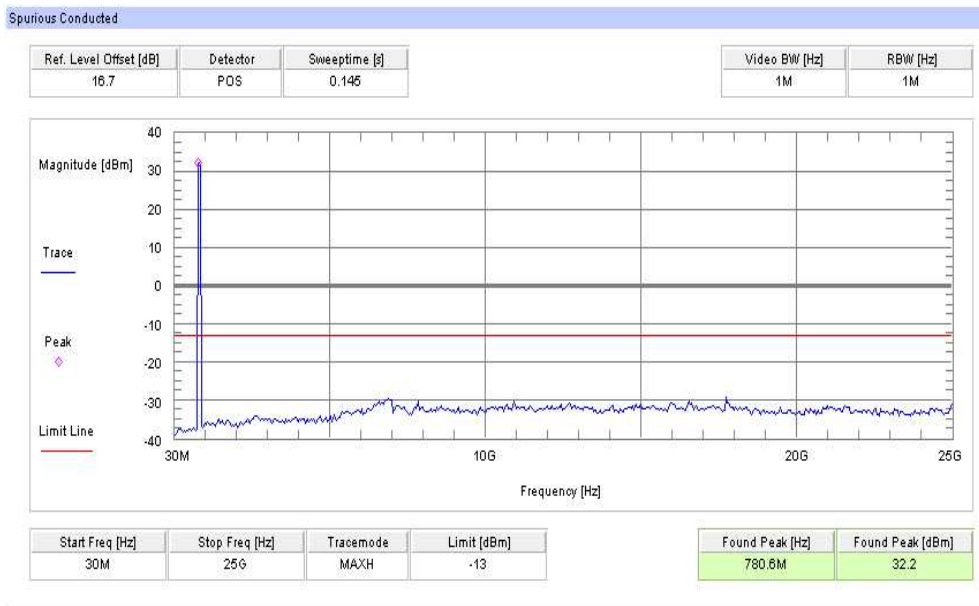

Plot 2: Channel 189 (30 MHz - 25 GHz)

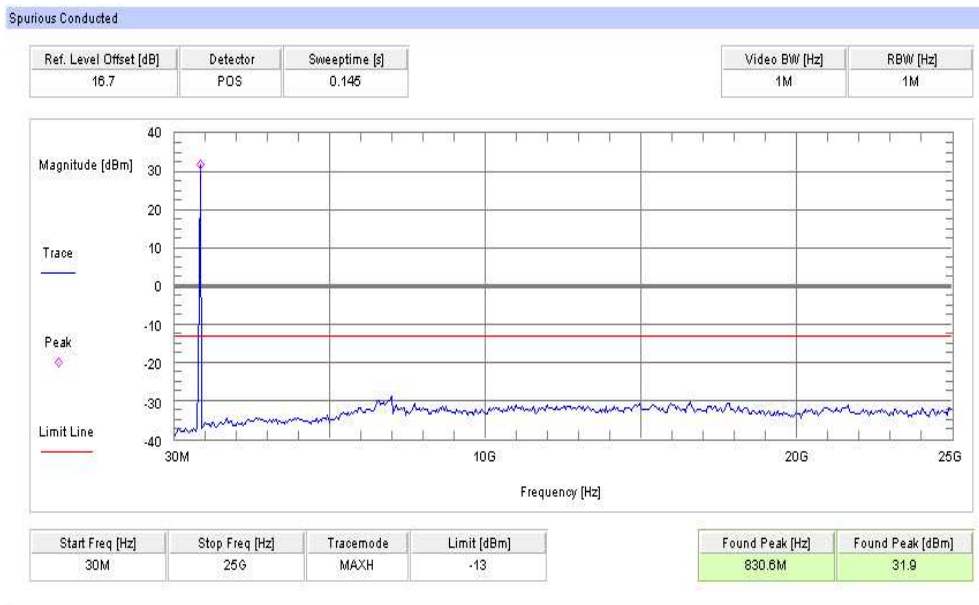

Plot 3: Channel 251 (30 MHz - 25 GHz)

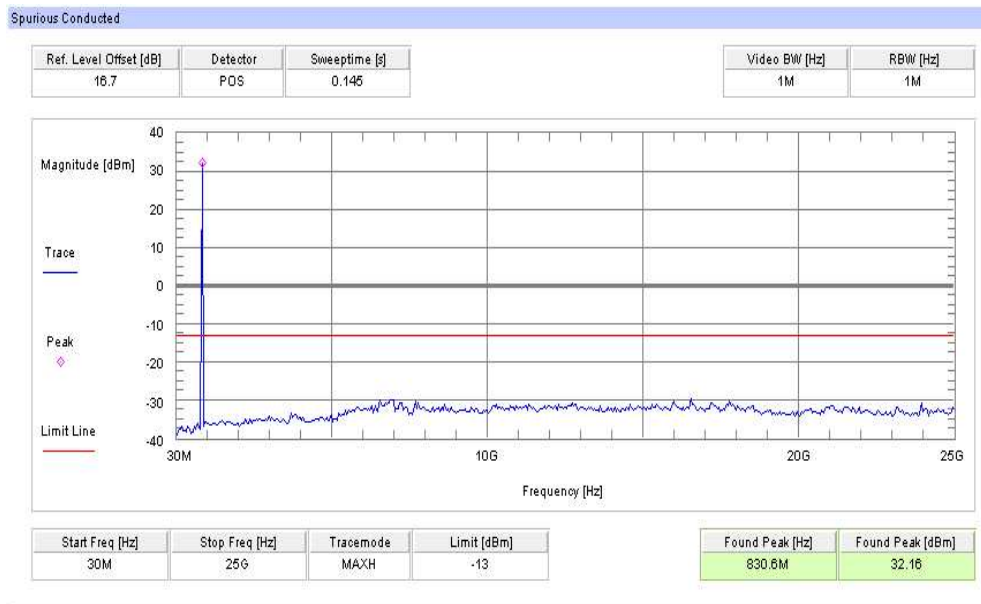

8.3.5 Block edge compliance

Description:

The spectrum at the band edges must comply with the spurious emissions limits.

Measurement:

Measurement parameters	
Detector:	RMS
Sweep time:	Auto
Video bandwidth:	3 kHz
Resolution bandwidth:	3 kHz
Span:	1 MHz
Trace-Mode:	Max Hold

Limits:

FCC	IC
CFR Part 22.917 CFR Part 2.1051	RSS 132, Issue 2, Section 6.5
Block Edge Compliance	
Attenuation $\geq 43 + 10\log(P)$ (P, Power in Watts)	
-13 dBm	

Results:

Plot 1: Channel 128 (GSM-mode)

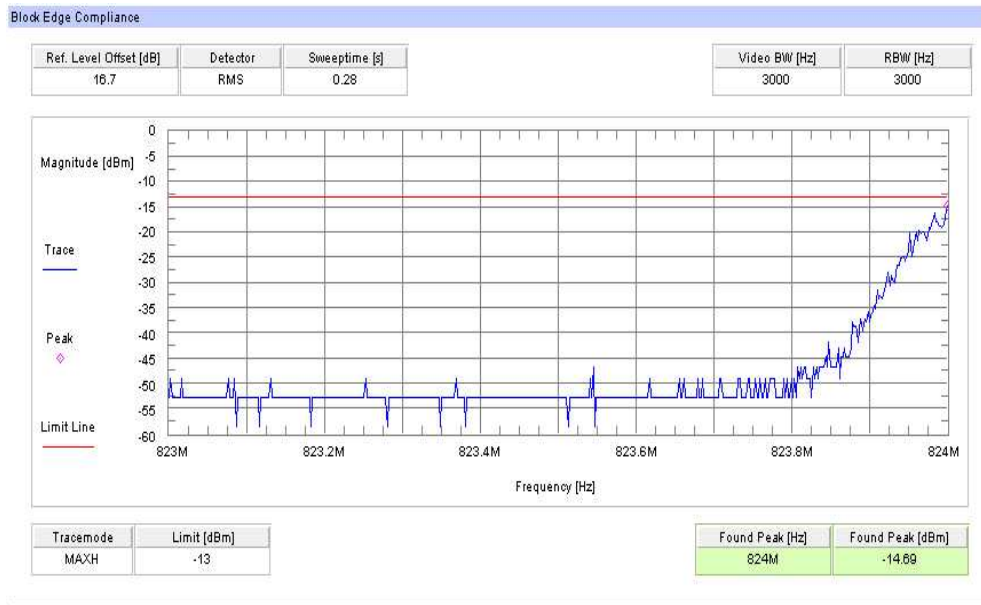

Plot 2: Channel 251 (GSM-mode)



Plot 3: Channel 128 (EDGE-mode)

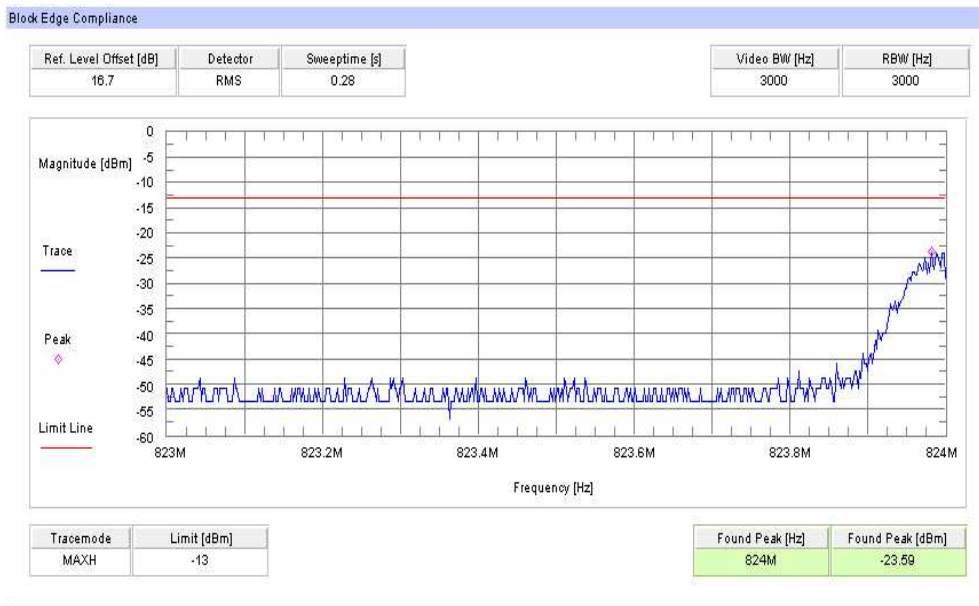

Plot 4: Channel 251 (EDGE-mode)

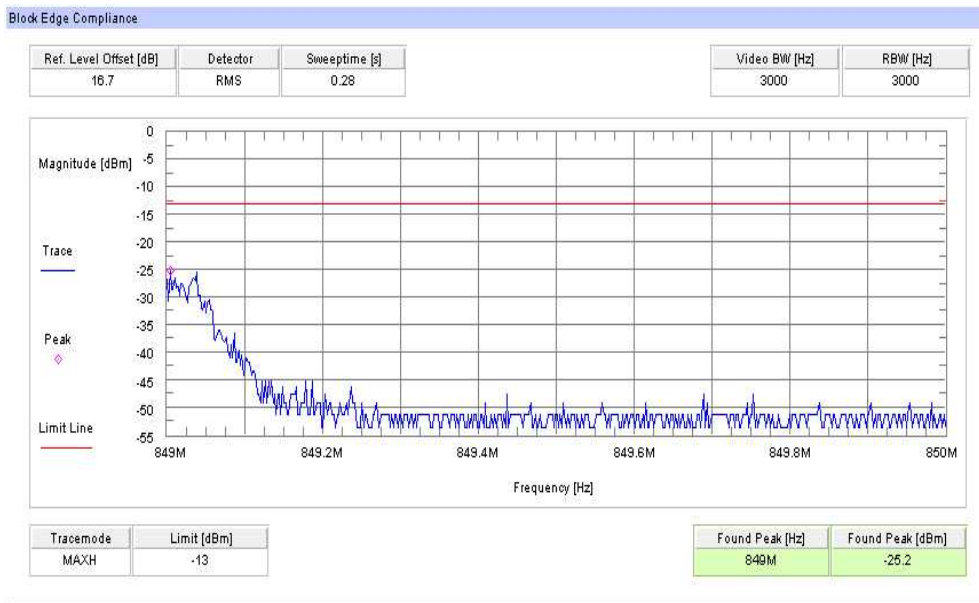

Result: The result of the measurement is passed.

8.3.6 Occupied bandwidth

Description:

Measurement of the occupied bandwidth of the transmitted signal.

Measurement:

Similar to conducted emissions, occupied bandwidth measurements are only provided for selected frequencies in order to reduce the amount of submitted data. Data were taken at the extreme and mid frequencies of the GSM-850 frequency band. The table below lists the measured 99% power and -26dBc occupied bandwidths. Spectrum analyzer plots are included on the following pages.

Part 22.917 requires a measurement bandwidth of at least 1% of the occupied bandwidth. For ca. 300 kHz, this equates to a resolution bandwidth of at least 3 kHz. For this testing, a resolution bandwidth 3.0 kHz was used.

Measurement parameters	
Detector:	Peak
Sweep time:	Auto
Video bandwidth:	3 kHz
Resolution bandwidth:	3 kHz
Span:	1 MHz
Trace-Mode:	Max Hold

Limits:

FCC	IC
CFR Part 22.917 CFR Part 2.1049	RSS 132, Issue 2, Section 4.5.1
Occupied Bandwidth	
Spectrum must fall completely in the specified band	

Results:

Occupied Bandwidth - GMSK mode		
Frequency (MHz)	99% OBW (kHz)	-26 dBc BW (kHz)
824.2	279	311
836.4	279	315
848.8	275	313
Measurement uncertainty	± 3 kHz	

Occupied Bandwidth - EDGE mode		
Frequency (MHz)	99% OBW (kHz)	-26 dBc BW (kHz)
824.2	279	303
836.4	277	303
848.8	279	301
Measurement uncertainty	± 3 kHz	

Result: [The result of the measurement is passed.](#)

Plot 1: Channel 128 (99% - OBW)



Plot 2: Channel 128 (-26 dBc BW)



Plot 3: Channel 189 (99% - OBW)

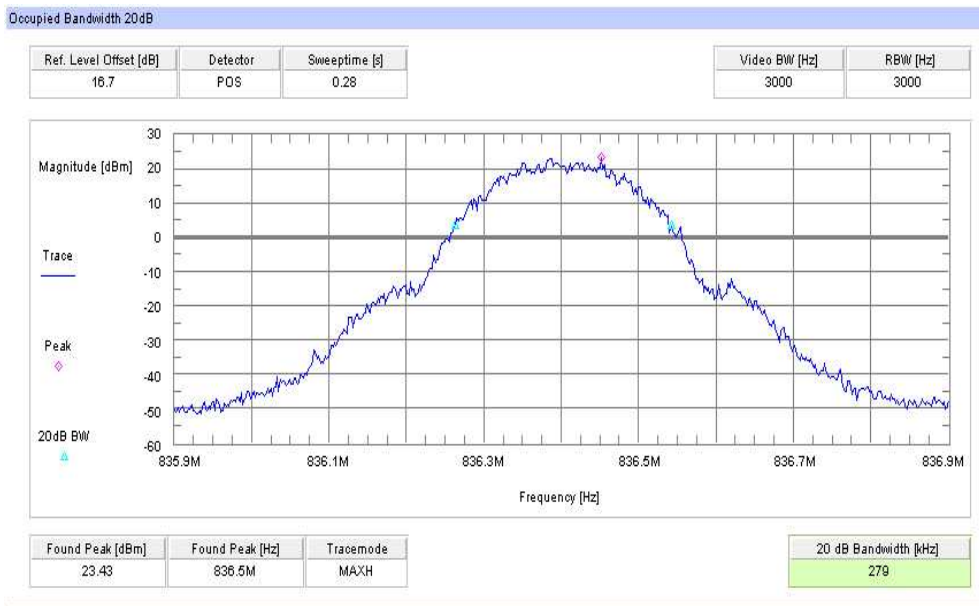

Plot 4: Channel 189 (-26 dBc BW)



Plot 5: Channel 251 (99% - OBW)

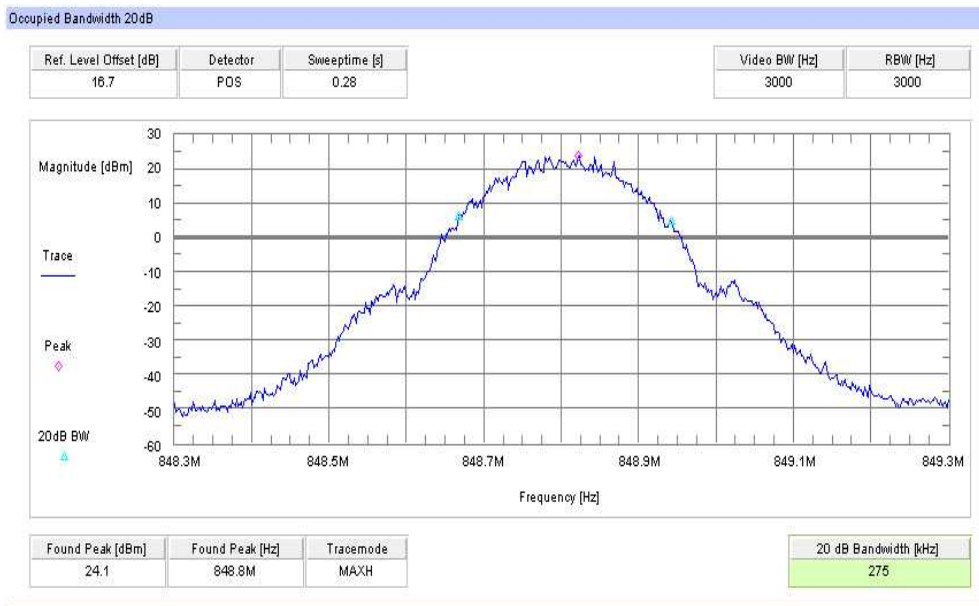

Plot 6: Channel 251 (-26 dBc BW)

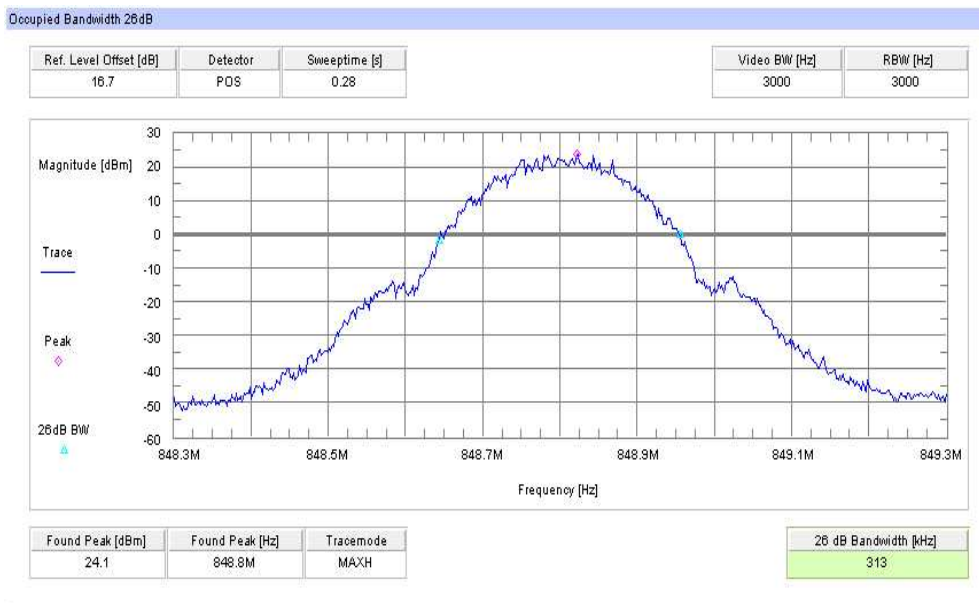

Plot 7: Channel 128 (99% - OBW) - EDGE



Plot 8: Channel 128 (-26 dBc BW) - EDGE

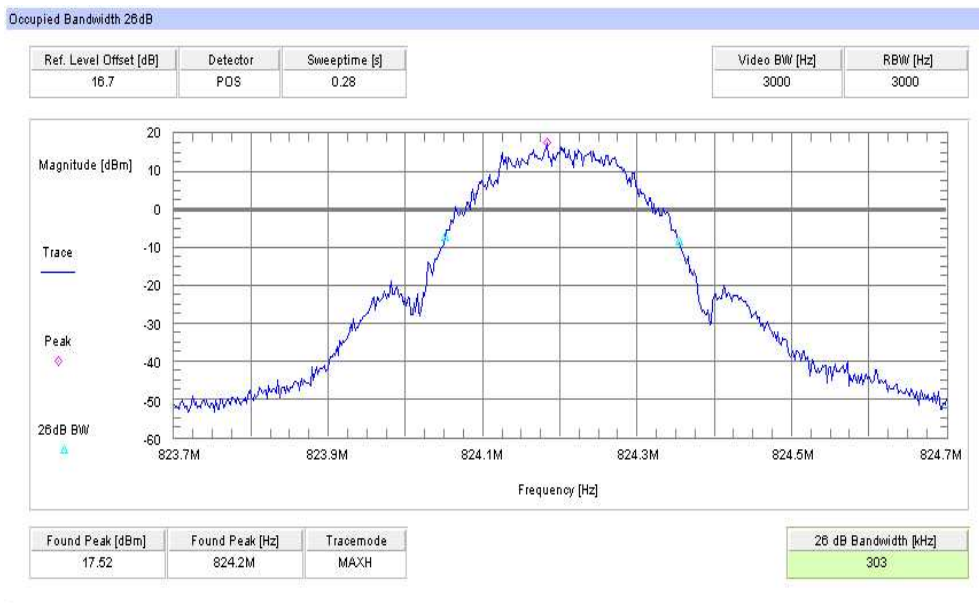

Plot 9: Channel 189 (99% - OBW) - EDGE

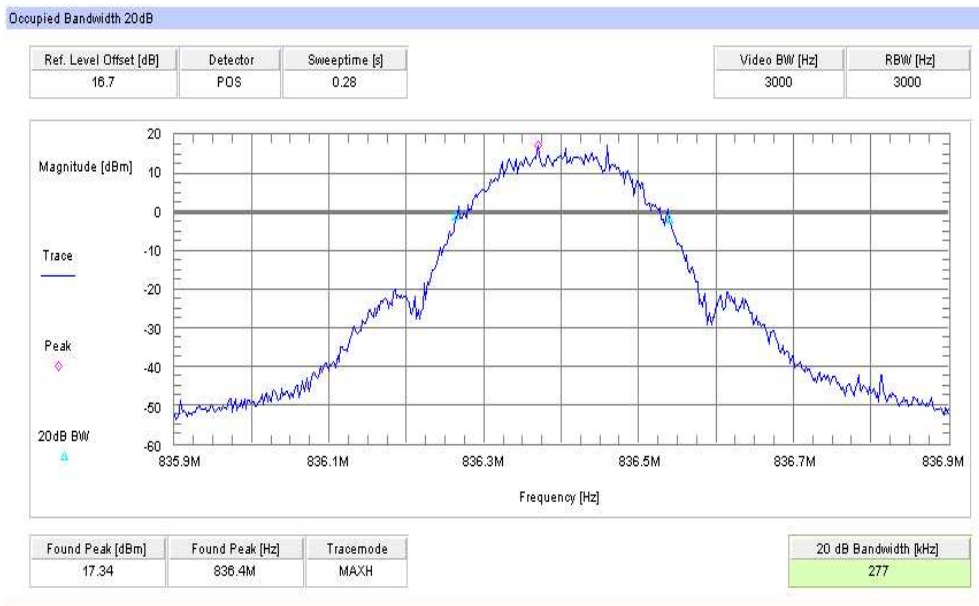

Plot 10: Channel 189 (-26 dBc BW) - EDGE

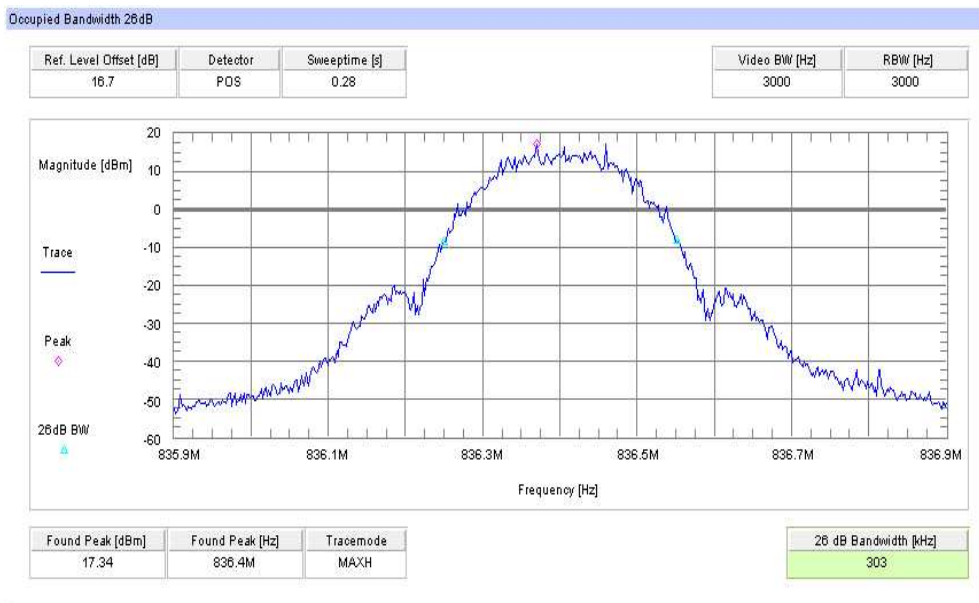

Plot 11: Channel 251 (99% - OBW) - EDGE

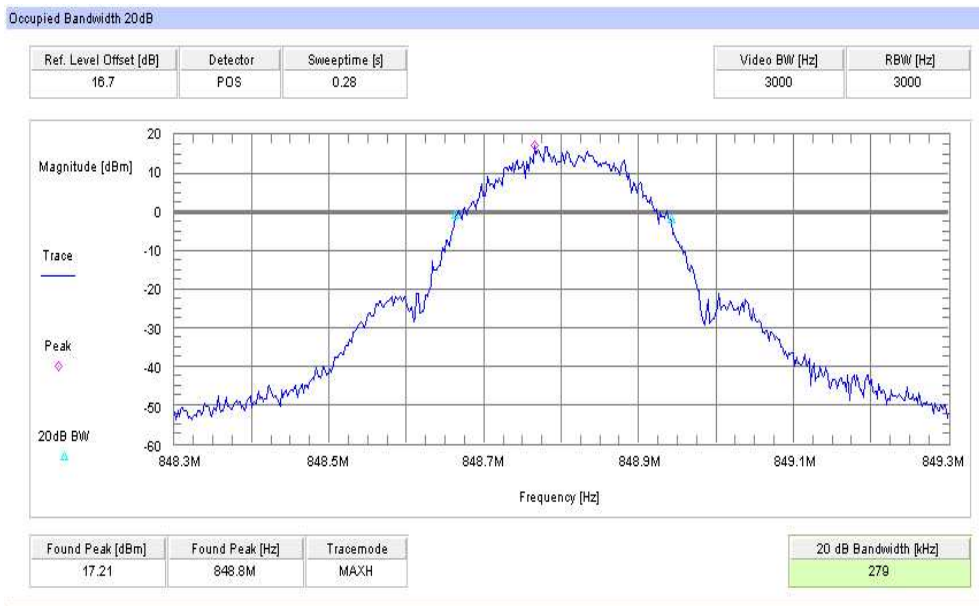

Plot 12: Channel 251 (-26 dBc BW) - EDGE

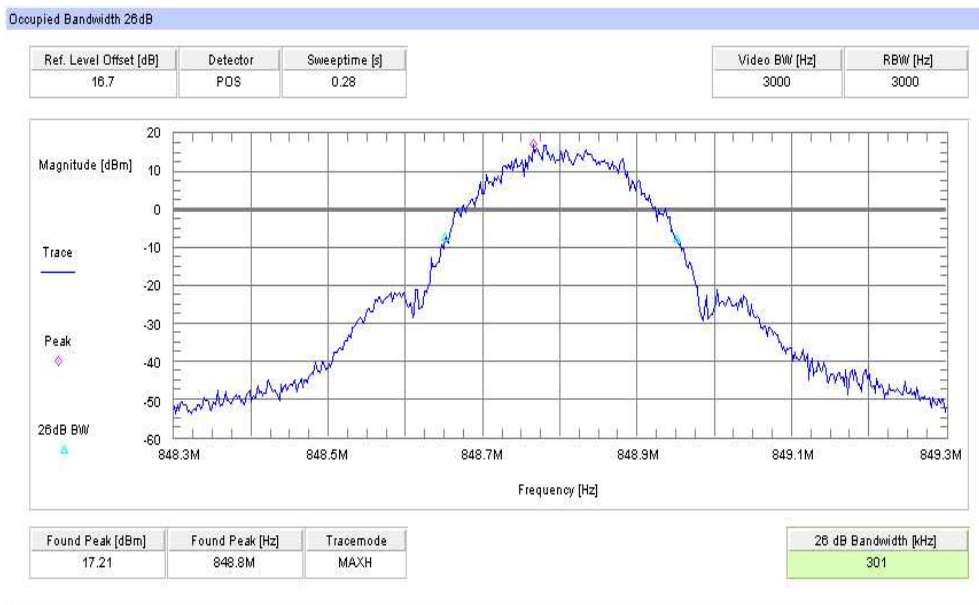

8.4 Results PCS 1900

All GSM-band measurements are done in GSM mode only (circuit switched).

All relevant tests have been repeated using 8-PSK modulation if EDGE mode is supported. All tests were performed with one timeslot in uplink activated and one timeslot in downlink activated. For each mode the highest output power was determined and used.

8.4.1 RF output power

Description:

This paragraph contains average power, peak output power and EIRP measurements for the mobile station. In all cases, the peak output power is within the required mask (this mask is specified in the JTC standards, TIA PN3389 Vol. 1 Chap 7, and is no FCC requirement).

Measurement:

The mobile was set up for the maximum output power with pseudo random data modulation.

Measurement parameters	
Detector:	Peak and RMS (Power in Burst)
Sweep time:	Auto
Video bandwidth:	1 MHz
Resolution bandwidth:	1 MHz
Span:	Zero Span
Trace-Mode:	Max Hold

Limits:

FCC	IC
CFR Part 24.232 CFR Part 2.1046	RSS 133, Issue 5, Section 6.4
Nominal Peak Output Power	
+33.00 dBm	
In measuring transmissions in this band using an average power technique, the peak-to-average ratio (PAR) of the transmission may not exceed 13 dB.	

Results:

Output Power (conducted) GMSK mode		
Frequency (MHz)	Average Output Power (dBm)	Peak to Average Ratio (dB)
1850.2	29.73	0.07
1880.0	29.84	0.07
1909.8	29.90	0.09
Measurement uncertainty	± 0.5 dB	

Output Power (conducted) 8-PSK mode		
Frequency (MHz)	Average Output Power (dBm)	Peak to Average Ratio (dB)
1850.2	26.42	3.09
1880.0	26.59	2.88
1909.8	26.14	3.07
Measurement uncertainty	± 0.5 dB	

Output Power (radiated) GMSK mode	
Frequency (MHz)	Average Output Power (dBm) - EIRP
1850.2	31.65
1880.0	31.85
1909.8	31.70
Measurement uncertainty	± 2.0 dB

Output Power (radiated) 8-PSK mode	
Frequency (MHz)	Average Output Power (dBm) - EIRP
1850.2	28.34
1880.0	28.60
1909.8	27.94
Measurement uncertainty	± 2.0 dB

Result: The result of the measurement is passed.

8.4.2 Frequency stability

Description:

In order to measure the carrier frequency under the condition of AFC lock, it is necessary to make measurements with the mobile station in a “call mode”. This is accomplished with the use of a R&S CMU200 DIGITAL RADIOCOMMUNICATION TESTER.

1. Measure the carrier frequency at room temperature.
2. Subject the mobile station to overnight soak at -30 C.
3. With the mobile station, powered with V_{nom} , connected to the CMU200 and in a simulated call on channel 661 (centre channel), measure the carrier frequency. These measurements should be made within two minutes of powering up the mobile station, to prevent significant self warming.
4. Repeat the above measurements at 10°C increments from -30°C to +60°C. Allow at least 1.5 hours at each temperature, unpowered, before making measurements.
5. Remeasure carrier frequency at room temperature with V_{nom} . Vary supply voltage from V_{min} to V_{max} , in 0.1 Volt steps remeasuring carrier frequency at each voltage. Pause at V_{nom} for 1.5 hours unpowered, to allow any self heating to stabilize, before continuing.
6. At all temperature levels hold the temperature to +/- 0.5°C during the measurement procedure.

Measurement:

Measurement parameters	
Detector:	Measured with CMU200
Sweep time:	
Video bandwidth:	
Resolution bandwidth:	
Span:	
Trace-Mode:	

Limits:

FCC	IC
CFR Part 24.235 CFR Part 2.1055	RSS 133, Issue 5, Section 6.3
Frequency Stability	
± 0.1 ppm	

Results:**AFC FREQ ERROR versus VOLTAGE**

Voltage (V)	Frequency Error (Hz)	Frequency Error (%)	Frequency Error (ppm)
3.3	6	0,00000032	0,0032
3.4	7	0,00000037	0,0037
3.5	8	0,00000043	0,0043
3.6	7	0,00000037	0,0037
3.7	5	0,00000027	0,0027
3.8	6	0,00000032	0,0032
3.9	7	0,00000037	0,0037
4.0	9	0,00000048	0,0048
4.1	10	0,00000053	0,0053
4.2	11	0,00000059	0,0059
4.3	9	0,00000048	0,0048
4.4	8	0,00000043	0,0043

AFC FREQ ERROR versus TEMPERATURE

Temperature (°C)	Frequency Error (Hz)	Frequency Error (%)	Frequency Error (ppm)
-30	10	0,00000053	0,0053
-20	9	0,00000048	0,0048
-10	11	0,00000059	0,0059
± 0	10	0,00000053	0,0053
10	8	0,00000043	0,0043
20	7	0,00000037	0,0037
30	9	0,00000048	0,0048
40	11	0,00000059	0,0059
50	10	0,00000053	0,0053
60	11	0,00000059	0,0059

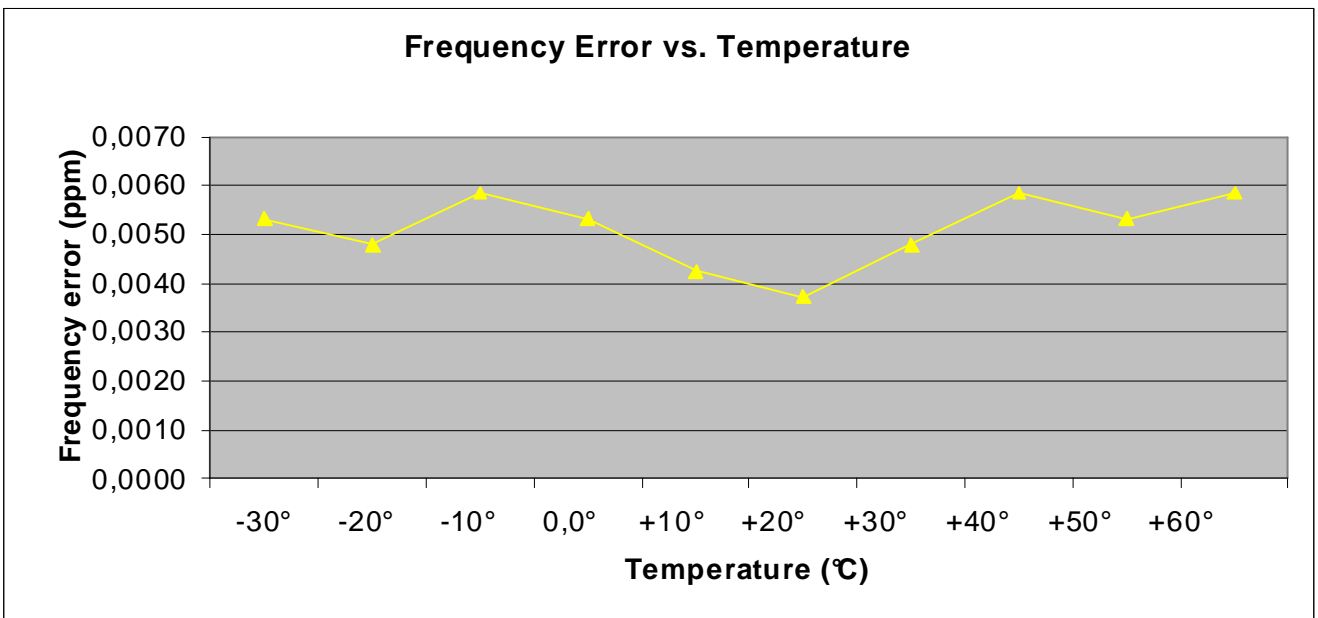
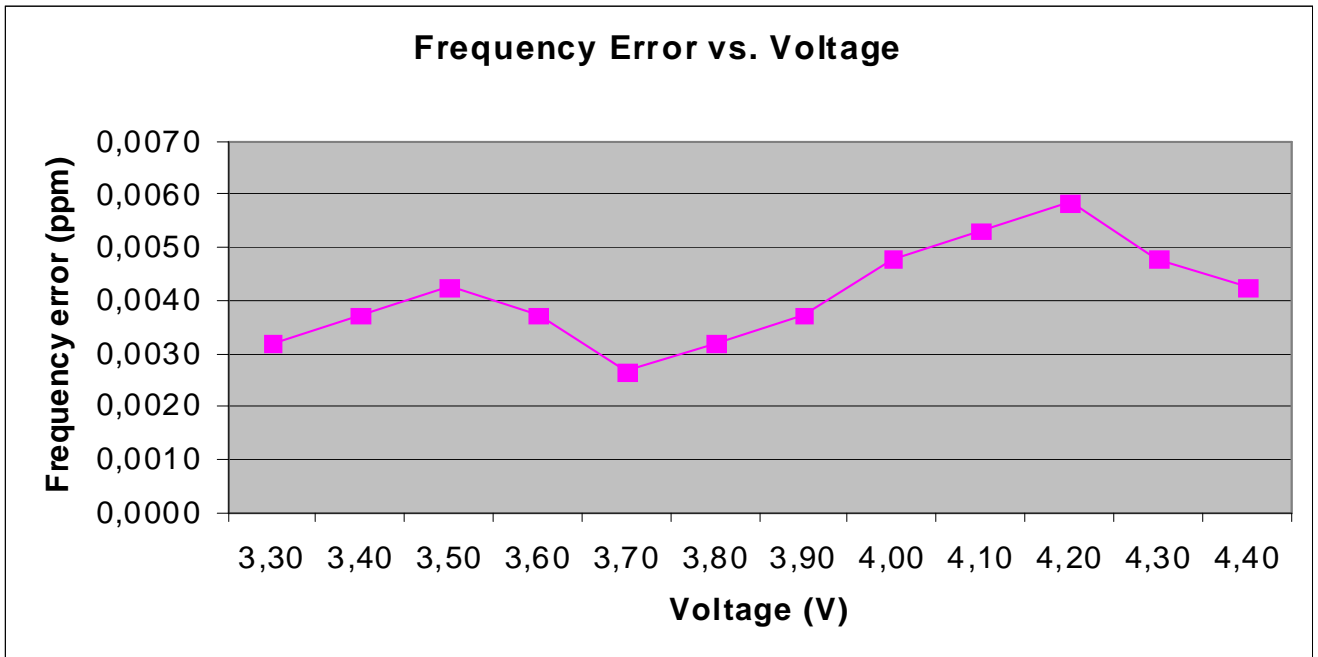

Result: The result of the measurement is passed.

8.4.3 Spurious emissions radiated

Description:

The following steps outline the procedure used to measure the radiated emissions from the mobile station. The site is constructed in accordance with ANSI C63.4:2009 requirements and is recognized by the FCC to be in compliance for a 3 and a 10 meter site. The spectrum was scanned from 30 MHz to the 10th harmonic of the highest frequency generated within the equipment, which is the transmitted carrier that can be as high as 1910 MHz. This was rounded up to 20 GHz. The resolution bandwidth is set as outlined in Part 24.238. The spectrum was scanned with the mobile station transmitting at carrier frequencies that pertain to low, mid and high channels of the PCS1900 band.

The final open field emission (here 10m semi-anechoic chamber listed by FCC) test procedure is as follows:

- a) The test item was placed on a 0.8 meter high non-conductive stand at a 3 meter test distance from the receive antenna.
- b) The antenna output was terminated in a 50 ohm load (if possible).
- c) A double ridged wave guide antenna was placed on an adjustable height antenna mast 3 meters from the test item for emission measurements.
- d) Detected emissions were maximized at each frequency by rotating the test item and adjusting the receive antenna height and polarization. The maximum meter reading was recorded. The radiated emission measurements of the harmonics of the transmit frequency through the 10th harmonic were measured with peak detector and 1 MHz bandwidth. If the harmonic could not be detected above the noise floor, the ambient level was recorded. The equivalent power into a dipole antenna was calculated from the field intensity levels measured at 3 meters.
- e) Now each detected emissions were substituted by the substitution method, in accordance with the TIA/EIA 603 .

Measurement:

Measurement parameters	
Detector:	Peak
Sweep time:	2 sec.
Video bandwidth:	Below 1 GHz: 120 kHz Above 1 GHz: 1 MHz
Resolution bandwidth:	Below 1 GHz: 120 kHz Above 1 GHz: 1 MHz
Span:	100 MHz Steps
Trace-Mode:	Max Hold

Limits:

FCC	IC
CFR Part 24.238 CFR Part 2.1053	RSS 133, Issue 5, Section 6.5
Spurious Emissions Radiated	
Attenuation $\geq 43 + 10\log(P)$ (P, Power in Watts)	
-13 dBm	

Results:

Radiated emissions measurements were made only at the upper, center, and lower carrier frequencies of the PCS1900 band (1850.2 MHz, 1880.0 MHz and 1909.8 MHz). It was decided that measurements at these three carrier frequencies would be sufficient to demonstrate compliance with emissions limits because it was seen that all the significant spurs occur well outside the band and no radiation was seen from a carrier in one block of the PCS1900 band into any of the other blocks. The equipment must still, however, meet emissions requirements with the carrier at all frequencies over which it is capable of operating and it is the manufacturer's responsibility to verify this.

The final open field radiated levels are presented on the next pages. All measurements were done in horizontal and vertical polarization; the plots show the worst case. The plots show only the middle channel. If spurious were detected, the lowest and highest channel were checked too. The found values are stated in the table below.

As can be seen from this data, the emissions from the test item were within the specification limit.

Spurious Emission Level (dBm)								
Harmonic	Ch. 512 Freq. (MHz)	Level [dBm]	Harmonic	Ch. 661 Freq. (MHz)	Level [dBm]	Harmonic	Ch. 810 Freq. (MHz)	Level [dBm]
2	3700.4	-	2	3760.0	-	2	3819.6	-
3	5550.6	-41.35	3	5640.0	-35.00	3	5729.4	-24.53
4	7400.8	-	4	7520.0	-	4	7639.2	-
5	9251.0	-	5	9400.0	-	5	9549.0	-
6	11101.2	-	6	11280.0	-	6	11458.8	-
7	12951.4	-	7	13160.0	-	7	13368.6	-
8	14801.6	-	8	15040.0	-	8	15278.4	-
9	16651.8	-	9	16920.0	-	9	17188.2	-
10	18502.0	-	10	18800.0	-	10	19098.0	-
Measurement uncertainty					± 3dB			

Result: The result of the measurement is passed.

Plot 1: Channel 661 (Traffic mode up to 30 MHz)

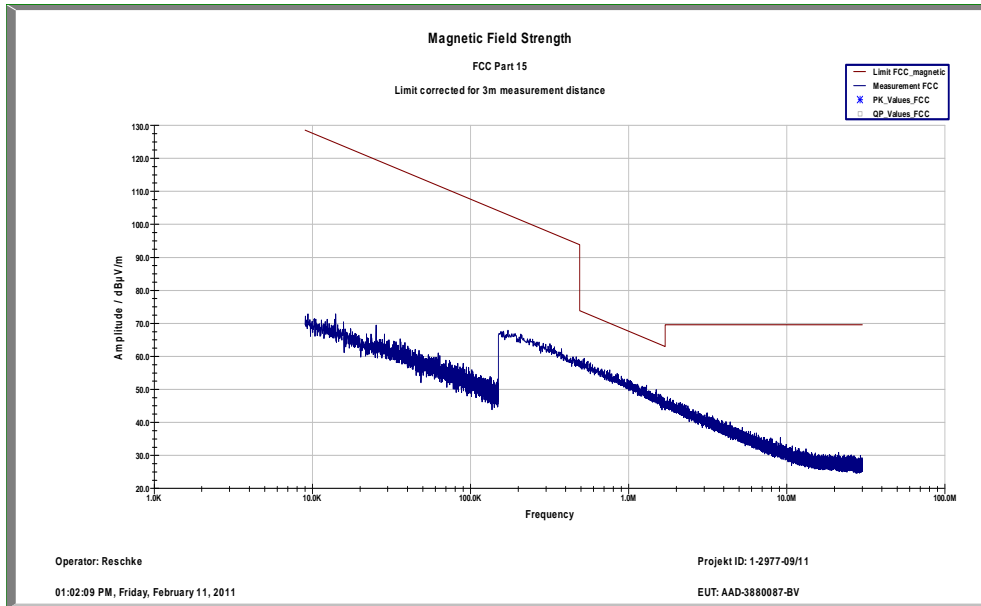

Plot 2: Channel 661 (30 MHz - 1 GHz)

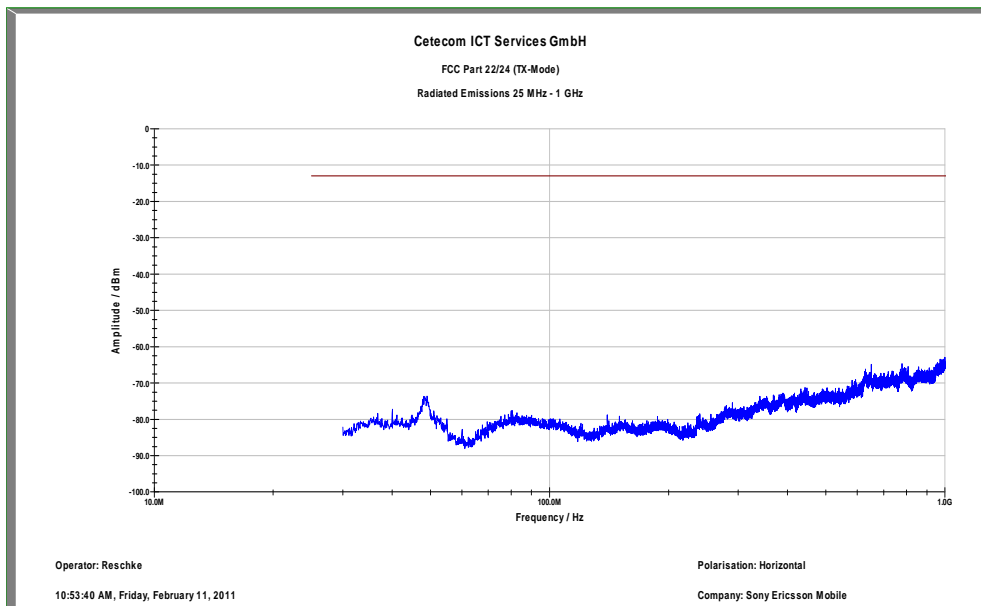

Plot 3: Channel 661 (1 GHz – 12.75 GHz)

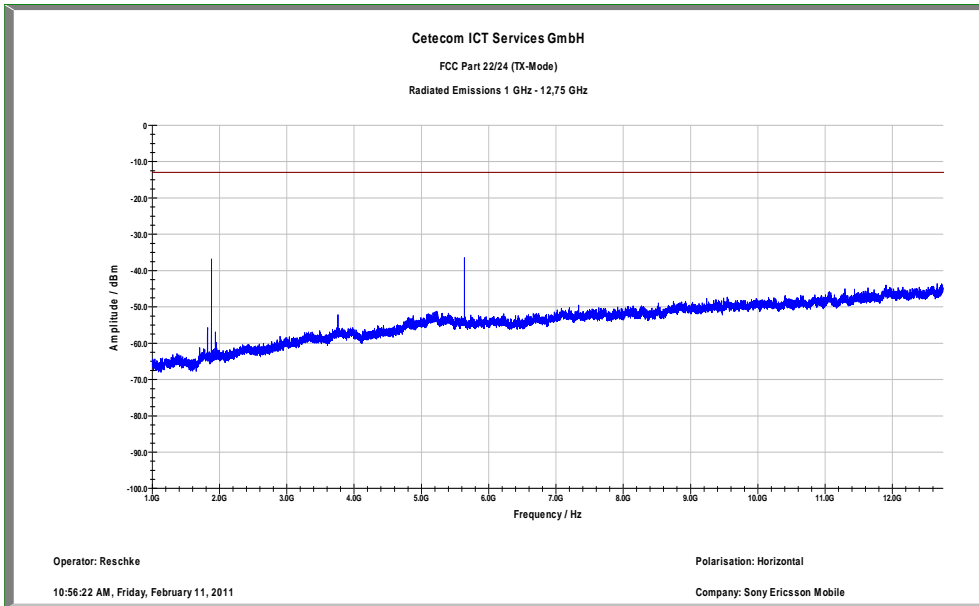

Carrier notched with 1.9 GHz rejection filter

Plot 4: Channel 661 (12 GHz - 25 GHz)

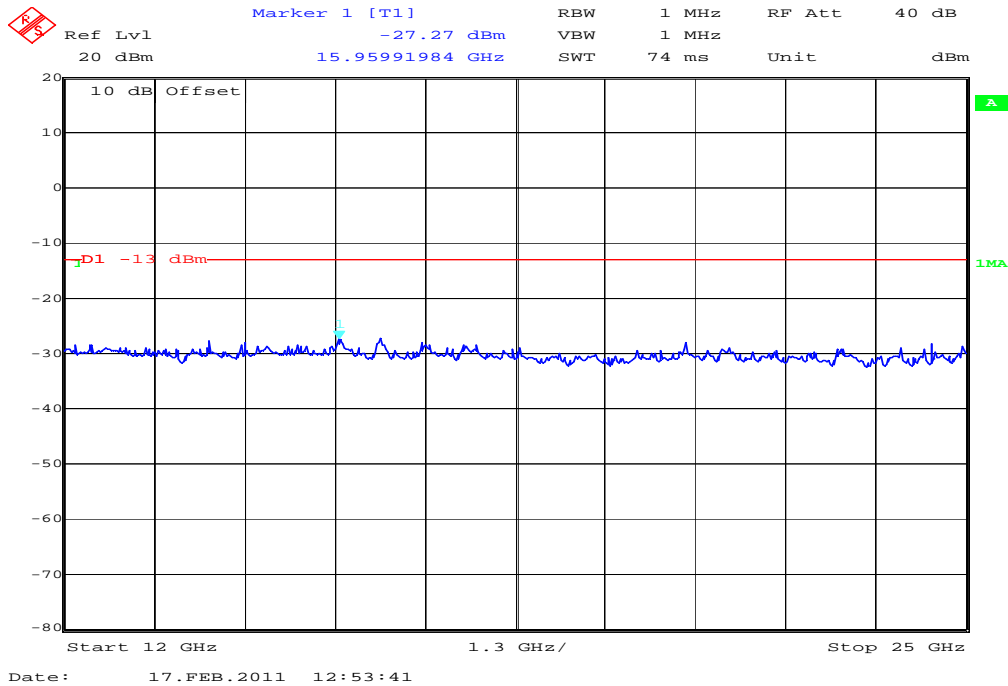

8.4.4 Spurious emissions conducted

Description:

The following steps outline the procedure used to measure the conducted emissions from the mobile station.

1. Determine frequency range for measurements: From CFR 2.1057 the spectrum should be investigated from the lowest radio frequency generated in the equipment up to at least the 10th harmonic of the carrier frequency. For the mobile station equipment tested, this equates to a frequency range of 13 MHz to 19.1 GHz, data taken from 10 MHz to 20 GHz.
2. Determine mobile station transmits frequencies: below outlines the band edge frequencies pertinent to conducted emissions testing.

PCS1900 Transmitter Channel Frequency

512 1850.2 MHz

661 1880.0 MHz

810 1909.8 MHz

Measurement:

Measurement parameters	
Detector:	Peak
Sweep time:	Auto
Video bandwidth:	Pre-measurement with 1 MHz On spurious detection re-measurement below 1 GHz with 100 kHz Above 1 GHz with 1 MHz
Resolution bandwidth:	Pre-measurement with 1 MHz On spurious detection re-measurement below 1 GHz with 100 kHz Above 1 GHz with 1 MHz
Span:	30 MHz – 25 GHz
Trace-Mode:	Max Hold

Limits:

FCC	IC
CFR Part 24.238 CFR Part 2.1051	RSS 133, Issue 5, Section 6.5
Spurious Emissions Conducted	
Attenuation $\geq 43 + 10\log(P)$ (P, Power in Watts)	
-13 dBm	

Results:

Spurious Emission Level (dBm)								
Harmonic	Ch. 512 Freq. (MHz)	Level [dBm]	Harmonic	Ch. 661 Freq. (MHz)	Level [dBm]	Harmonic	Ch. 810 Freq. (MHz)	Level [dBm]
2	3700.4	-	2	3760.0	-	2	3819.6	-
3	5550.6	-	3	5640.0	-	3	5729.4	-
4	7400.8	-	4	7520.0	-	4	7639.2	-
5	9251.0	-	5	9400.0	-	5	9549.0	-
6	11101.2	-	6	11280.0	-	6	11458.8	-
7	12951.4	-	7	13160.0	-	7	13368.6	-
8	14801.6	-	8	15040.0	-	8	15278.4	-
9	16651.8	-	9	16920.0	-	9	17188.2	-
10	18502.0	-	10	18800.0	-	10	19098.0	-
Measurement uncertainty					± 3dB			

Result: The result of the measurement is passed.

Plot 1: Channel 512 (30 MHz - 25 GHz)

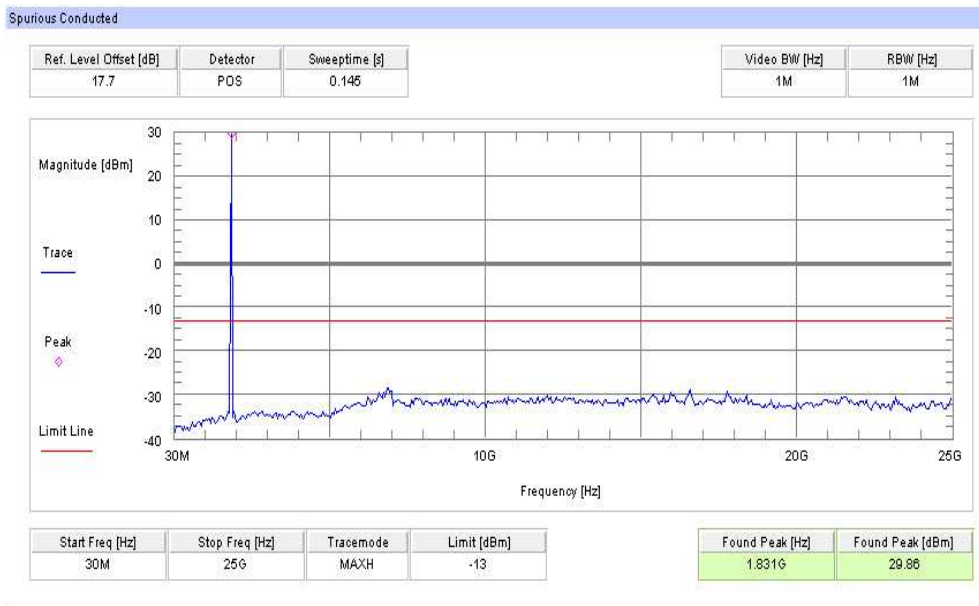

Plot 2: Channel 661 (30 MHz - 25 GHz)

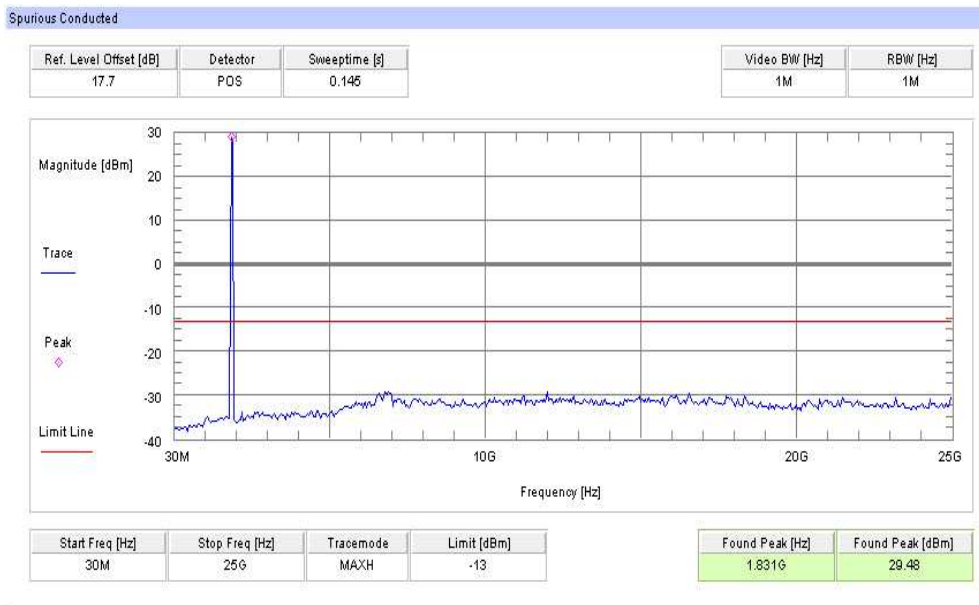

Plot 3: Channel 810 (30 MHz - 25 GHz)

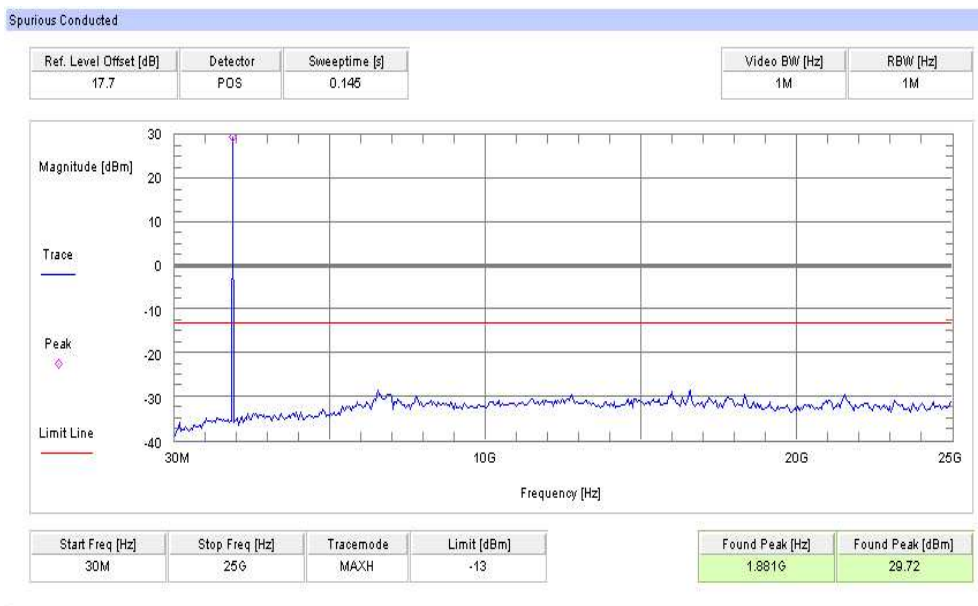

8.4.5 Block edge compliance

Description:

The spectrum at the band edges must comply with the spurious emissions limits.

Measurement:

Measurement parameters	
Detector:	RMS
Sweep time:	Auto
Video bandwidth:	3 kHz
Resolution bandwidth:	3 kHz
Span:	1 MHz
Trace-Mode:	Max Hold

Limits:

FCC	IC
CFR Part 24.238 CFR Part 2.1051	RSS 133, Issue 5, Section 6.5
Block Edge Compliance	
Attenuation $\geq 43 + 10\log(P)$ (P, Power in Watts)	
-13 dBm	

Results:

Plot 1: Channel 512 (GSM-mode)

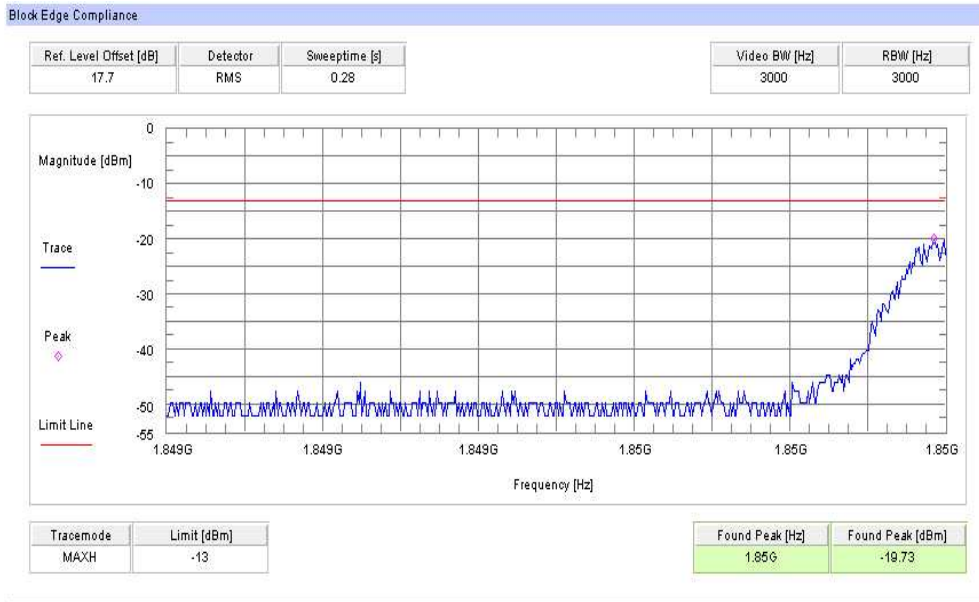

Plot 2: Channel 810 (GSM-mode)

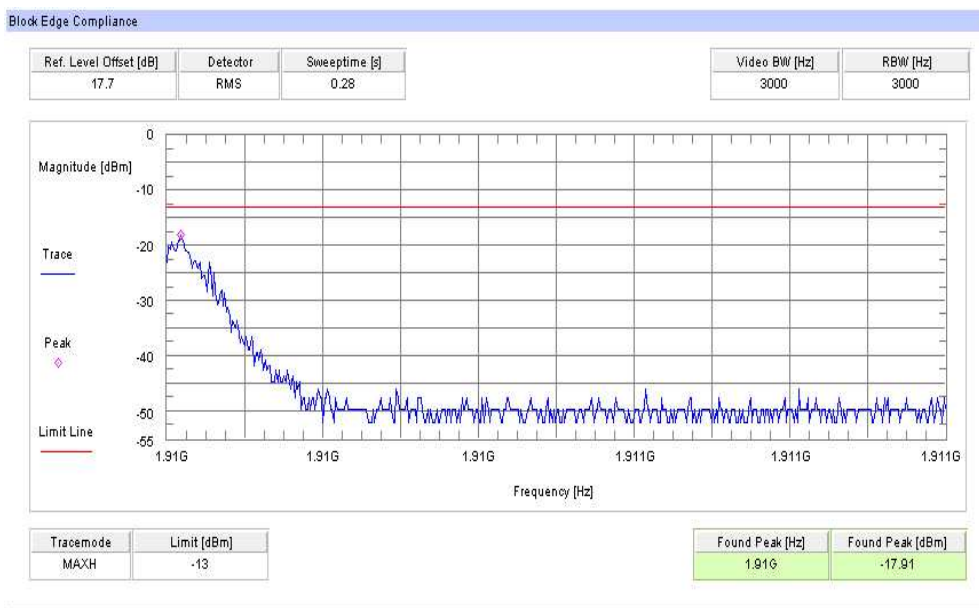

Plot 3: Channel 512 (EDGE-mode)

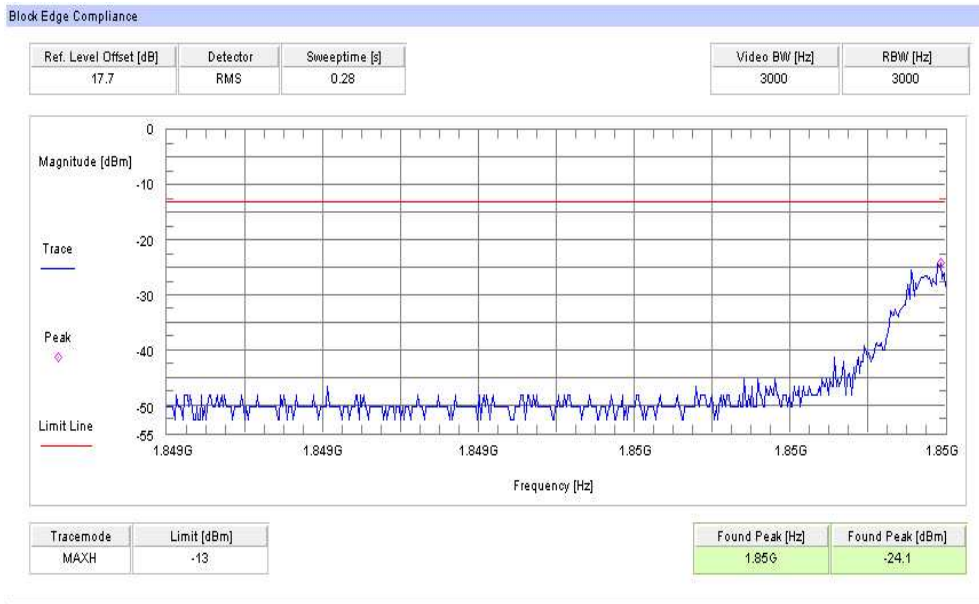

Plot 4: Channel 810 (EDGE-mode)

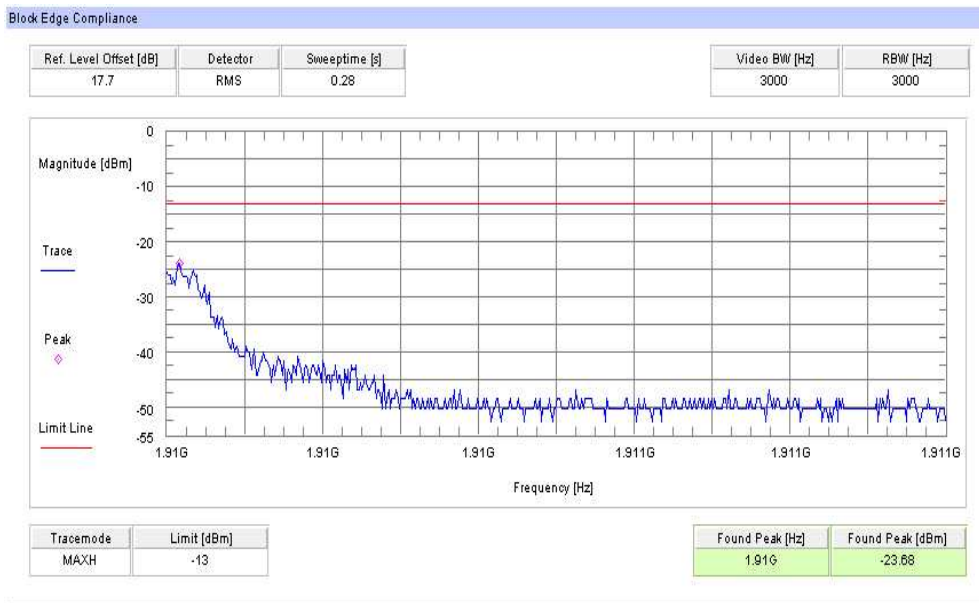

Result: The result of the measurement is passed.

8.4.6 Occupied bandwidth

Description:

Measurement of the occupied bandwidth of the transmitted signal.

Measurement:

Similar to conducted emissions, occupied bandwidth measurements are only provided for selected frequencies in order to reduce the amount of submitted data. Data were taken at the extreme and mid frequencies of the PCS1900 frequency band. The table below lists the measured 99% power and -26dBc occupied bandwidths. Spectrum analyzer plots are included on the following pages.

Part 24.238 requires a measurement bandwidth of at least 1% of the occupied bandwidth. For ca. 300 kHz, this equates to a resolution bandwidth of at least 3.0 kHz. For this testing, a resolution bandwidth 3.0 kHz was used.

Measurement parameters	
Detector:	Peak
Sweep time:	Auto
Video bandwidth:	3 kHz
Resolution bandwidth:	3 kHz
Span:	1 MHz
Trace-Mode:	Max Hold

Limits:

FCC	IC
CFR Part 24.238 CFR Part 2.1049	RSS 133, Issue 5, Section 6.5
Occupied Bandwidth	
Spectrum must fall completely in the specified band	

Results:

Occupied Bandwidth - GMSK mode		
Frequency (MHz)	99% OBW (kHz)	-26 dBc BW (kHz)
1850.2	259	309
1880.0	275	309
1909.8	271	311
Measurement uncertainty	± 3 kHz	

Occupied Bandwidth - EDGE mode		
Frequency (MHz)	99% OBW (kHz)	-26 dBc BW (kHz)
1850.2	271	309
1880.0	281	303
1909.8	271	301
Measurement uncertainty	± 3 kHz	

Result: [The result of the measurement is passed.](#)

Plot 1: Channel 512 (99% - OBW)

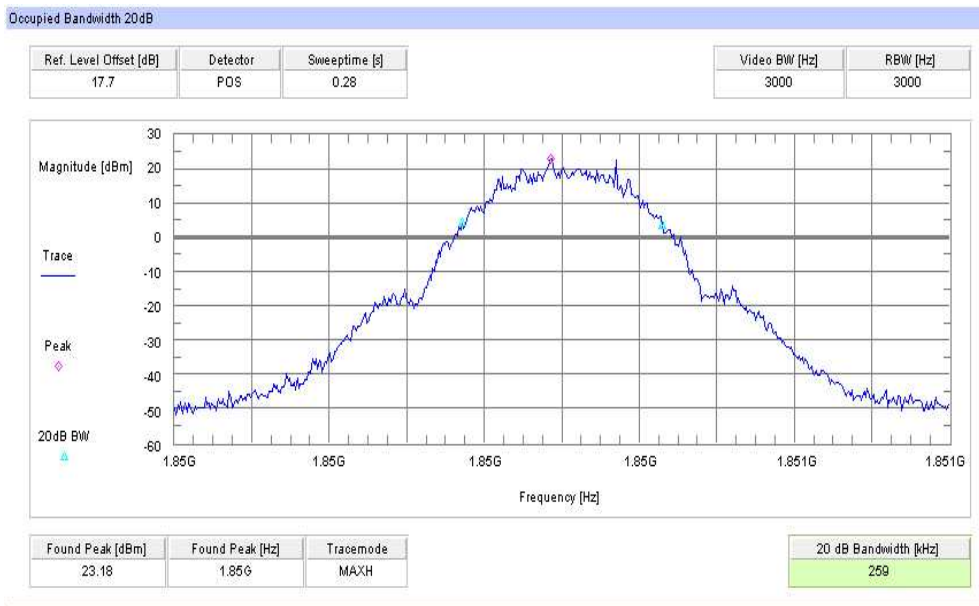

Plot 2: Channel 512 (-26 dBc BW)



Plot 3: Channel 661 (99% - OBW)

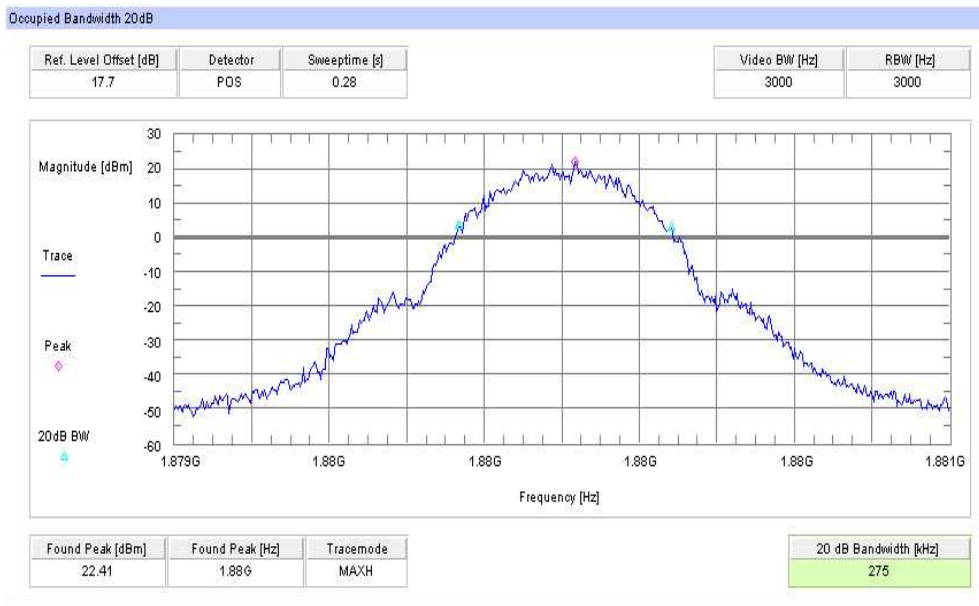

Plot 4: Channel 661 (-26 dBc BW)

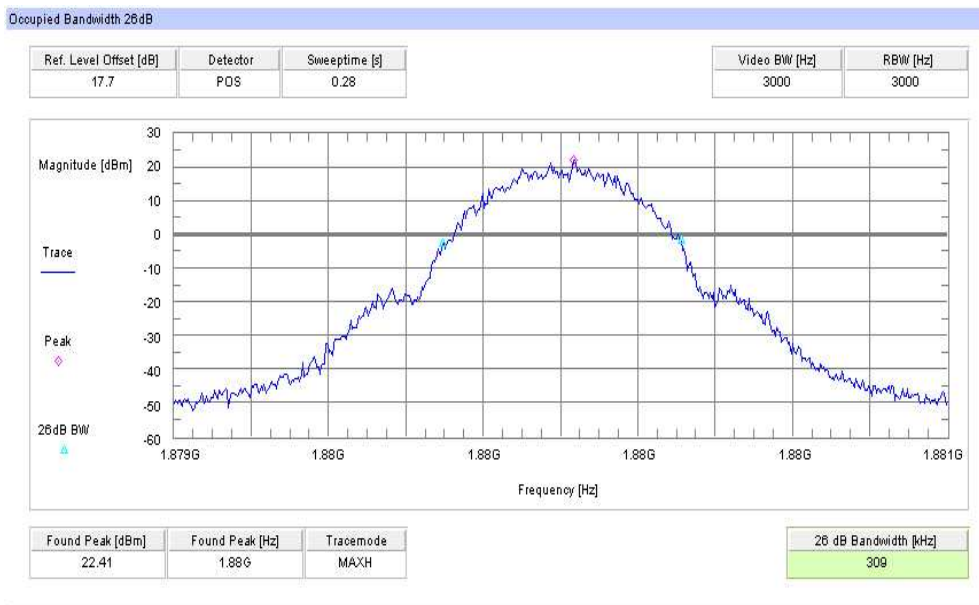

Plot 5: Channel 810 (99% - OBW)

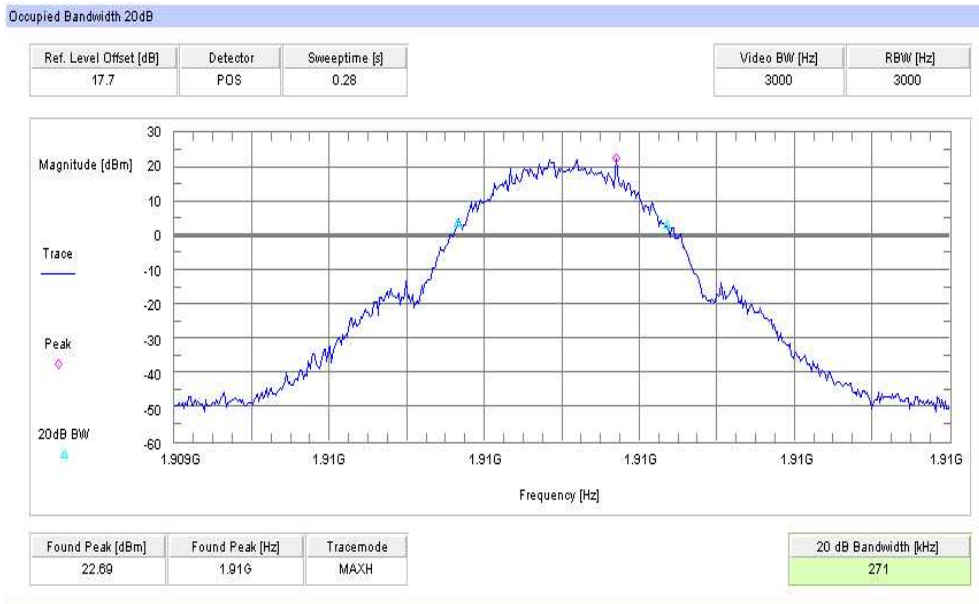

Plot 6: Channel 810 (-26 dBc BW)

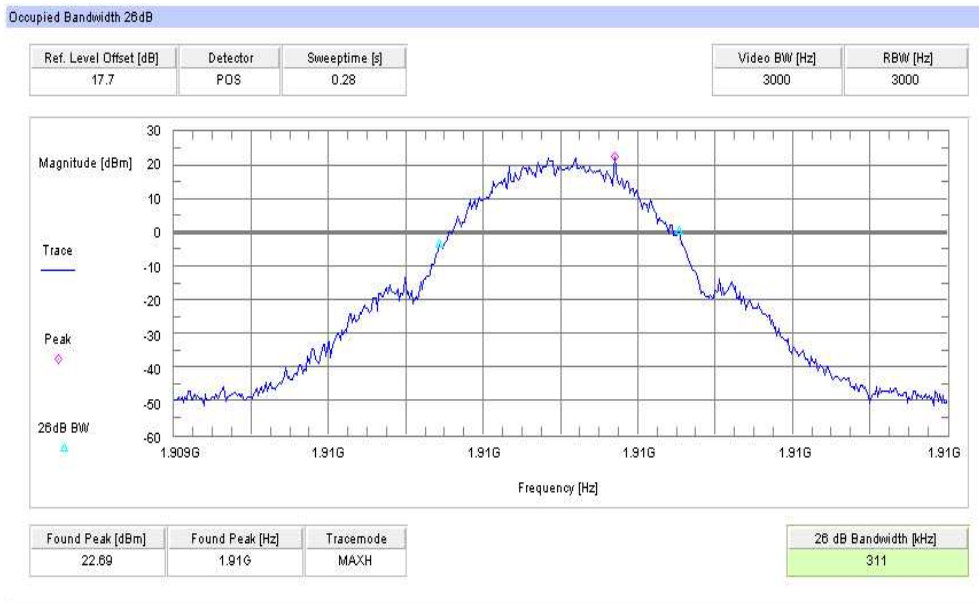

Plot 7: Channel 512 (99% - OBW) - EDGE

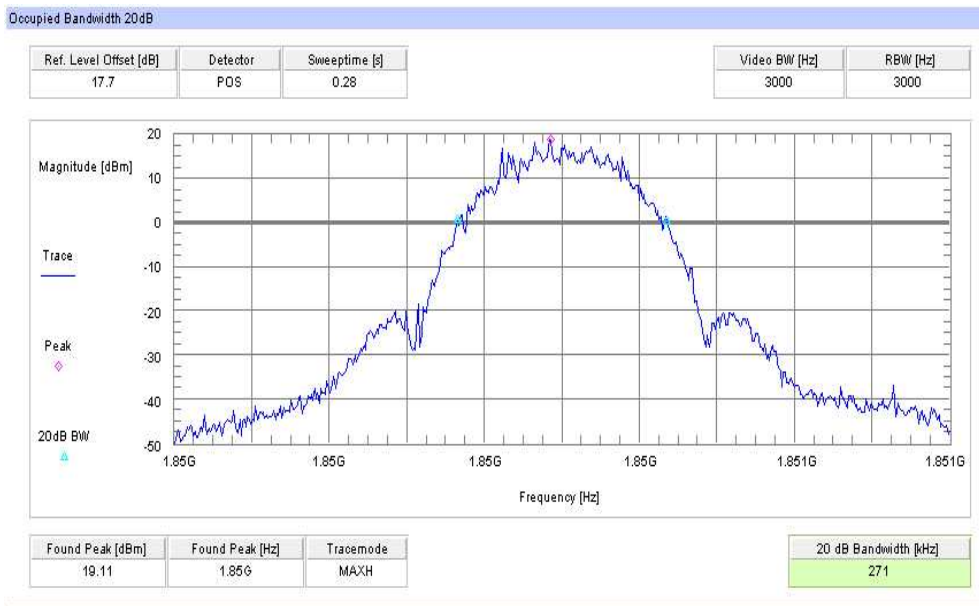

Plot 8: Channel 512 (-26 dBc BW) - EDGE

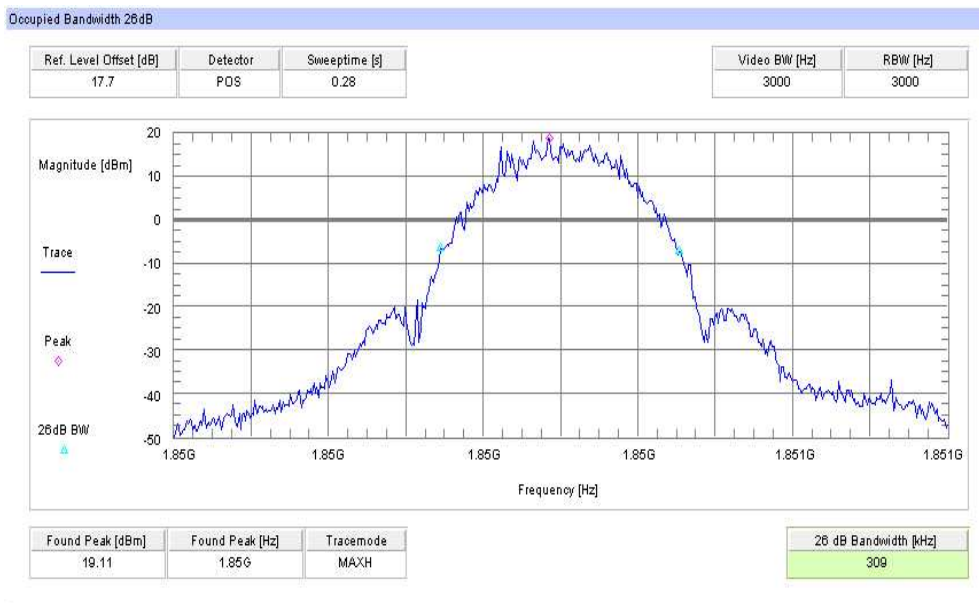

Plot 9: Channel 661 (99% - OBW) - EDGE

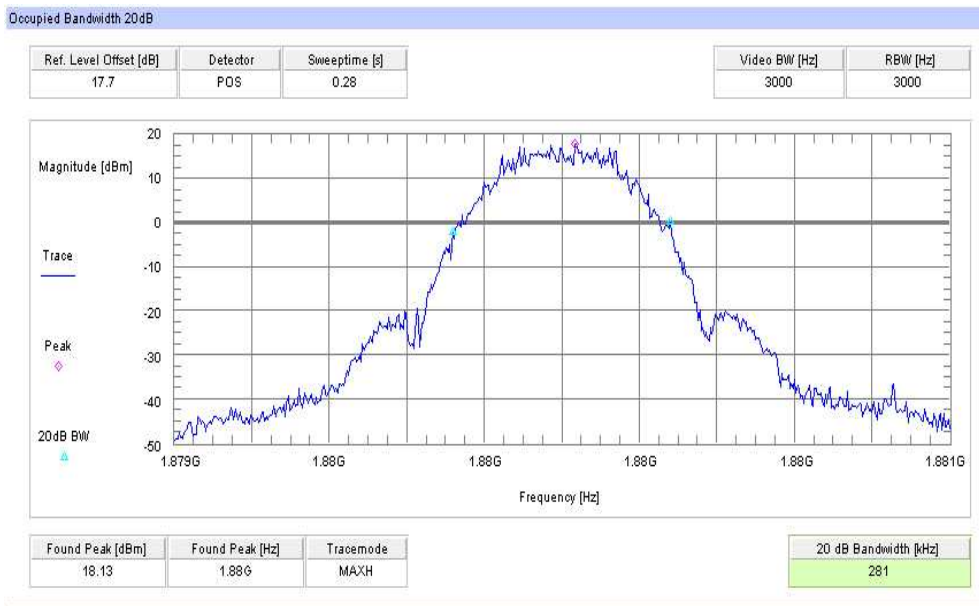

Plot 10: Channel 661 (-26 dBc BW) - EDGE

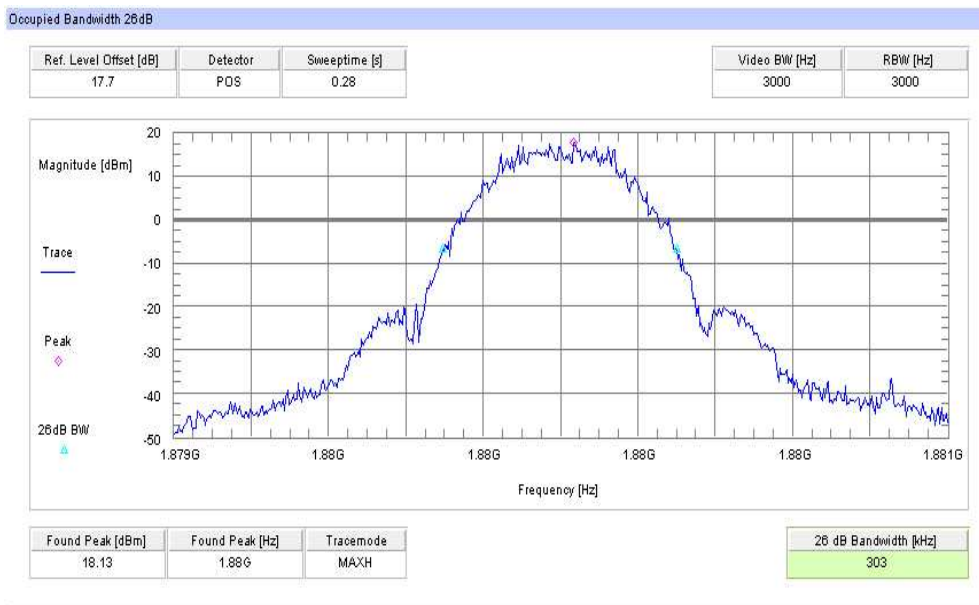

Plot 11: Channel 810 (99% - OBW) - EDGE

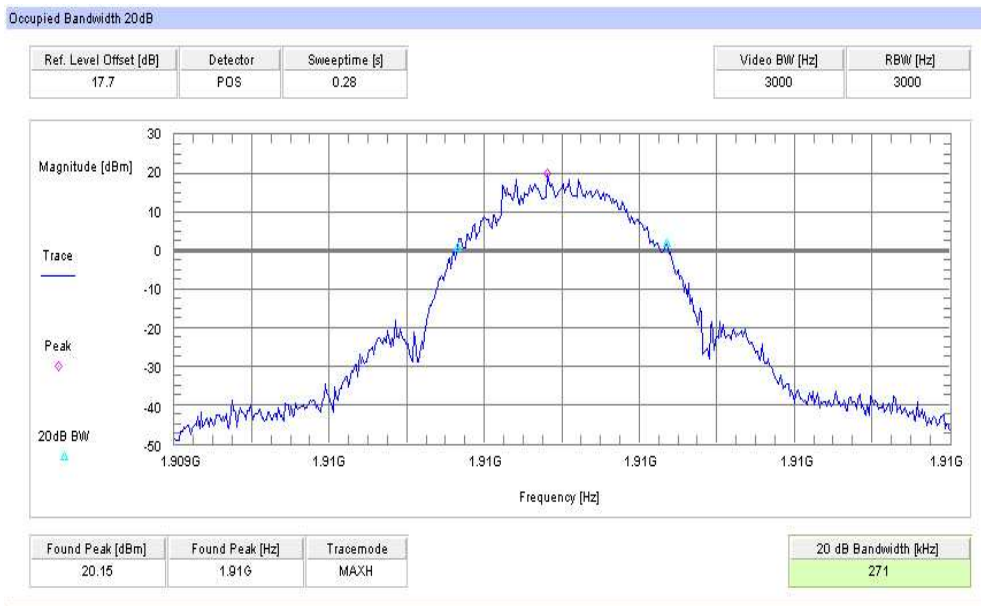

Plot 12: Channel 810 (-26 dBc BW) - EDGE

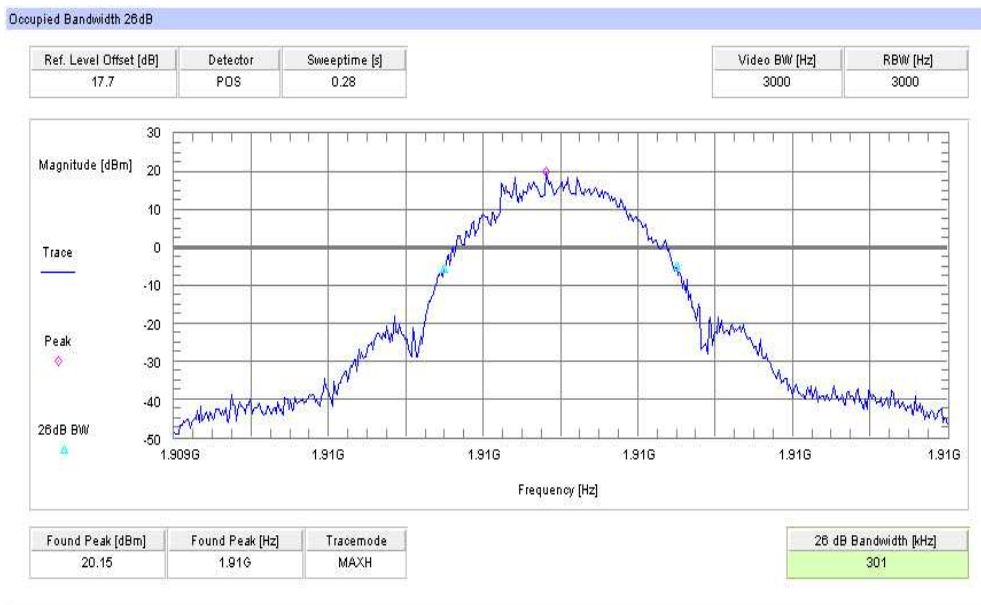

8.5 Results UMTS band II

All UMTS-band measurements are done in WCDMA mode only.

The connection was established with the following setup: WCDMA CS-RMC, Max Power (All Bit up)

8.5.1 RF output power

Description:

This paragraph contains average power, peak output power and EIRP measurements for the mobile station. In all cases, the peak output power is within the required mask (this mask is specified in the JTC standards, TIA PN3389 Vol. 1 Chap 7, and is no FCC requirement).

Measurement:

The mobile was set up for the maximum output power with pseudo random data modulation.

To determine the Peak-To-Average Power Ratio (PAPR) the measurement was performed with the Power Complementary Cumulative Distribution Function (CCDF).

Measurement parameters	
Detector:	Peak and RMS (Power in Burst)
Sweep time:	Auto
Video bandwidth:	10 MHz
Resolution bandwidth:	10 MHz
Span:	Zero Span
Trace-Mode:	Max Hold

Limits:

FCC	IC
CFR Part 24.232 CFR Part 2.1046	RSS 133, Issue 5, Section 6.4
Nominal Peak Output Power	
+33.00 dBm	
In measuring transmissions in this band using an average power technique, the peak-to-average ratio (PAR) of the transmission may not exceed 13 dB.	

Results:

Output Power (conducted) WCDMA mode		
Frequency (MHz)	Average Output Power (dBm)	Peak to Average Ratio (dB)
1852.4	24.10	3.37
1880.0	23.85	3.44
1907.6	23.83	3.24
Measurement uncertainty	± 0.5 dB	

Output Power (radiated) WCDMA mode	
Frequency (MHz)	Average Output Power (dBm) - EIRP
1852.4	26.02
1880.0	25.86
1907.6	25.63
Measurement uncertainty	± 2.0 dB

Result: The result of the measurement is passed.

8.5.2 Frequency stability

Description:

In order to measure the carrier frequency under the condition of AFC lock, it is necessary to make measurements with the mobile station in a “call mode”. This is accomplished with the use of a R&S CMU200 DIGITAL RADIOCOMMUNICATION TESTER.

1. Measure the carrier frequency at room temperature.
2. Subject the mobile station to overnight soak at -30 C.
3. With the mobile station, powered with V_{nom} , connected to the CMU200 and in a simulated call on channel 9400 (centre channel), measure the carrier frequency. These measurements should be made within two minutes of powering up the mobile station, to prevent significant self warming.
4. Repeat the above measurements at 10°C increments from -30°C to +60°C. Allow at least 1.5 hours at each temperature, unpowered, before making measurements.
5. Remeasure carrier frequency at room temperature with V_{nom} . Vary supply voltage from V_{min} to V_{max} , in 0.1 Volt steps remeasuring carrier frequency at each voltage. Pause at V_{nom} for 1.5 hours unpowered, to allow any self heating to stabilize, before continuing.
6. At all temperature levels hold the temperature to +/- 0.5°C during the measurement procedure.

Measurement:

Measurement parameters	
Detector:	Measured with CMU200
Sweep time:	
Video bandwidth:	
Resolution bandwidth:	
Span:	
Trace-Mode:	

Limits:

FCC	IC
CFR Part 24.235 CFR Part 2.1055	RSS 133, Issue 5, Section 6.3
Frequency Stability	
± 0.1 ppm	

Results:**AFC FREQ ERROR versus VOLTAGE**

Voltage (V)	Frequency Error (Hz)	Frequency Error (%)	Frequency Error (ppm)
3.3	30	0,00000160	0,0160
3.4	32	0,00000170	0,0170
3.5	31	0,00000165	0,0165
3.6	30	0,00000160	0,0160
3.7	28	0,00000149	0,0149
3.8	29	0,00000154	0,0154
3.9	27	0,00000144	0,0144
4.0	29	0,00000154	0,0154
4.1	30	0,00000160	0,0160
4.2	29	0,00000154	0,0154
4.3	27	0,00000144	0,0144
4.4	28	0,00000149	0,0149

AFC FREQ ERROR versus TEMPERATURE

Temperature (°C)	Frequency Error (Hz)	Frequency Error (%)	Frequency Error (ppm)
-30	28	0,00000149	0,0149
-20	29	0,00000154	0,0154
-10	31	0,00000165	0,0165
± 0	31	0,00000165	0,0165
10	30	0,00000160	0,0160
20	28	0,00000149	0,0149
30	27	0,00000144	0,0144
40	26	0,00000138	0,0138
50	28	0,00000149	0,0149
60	29	0,00000154	0,0154

Frequency Error vs. Voltage

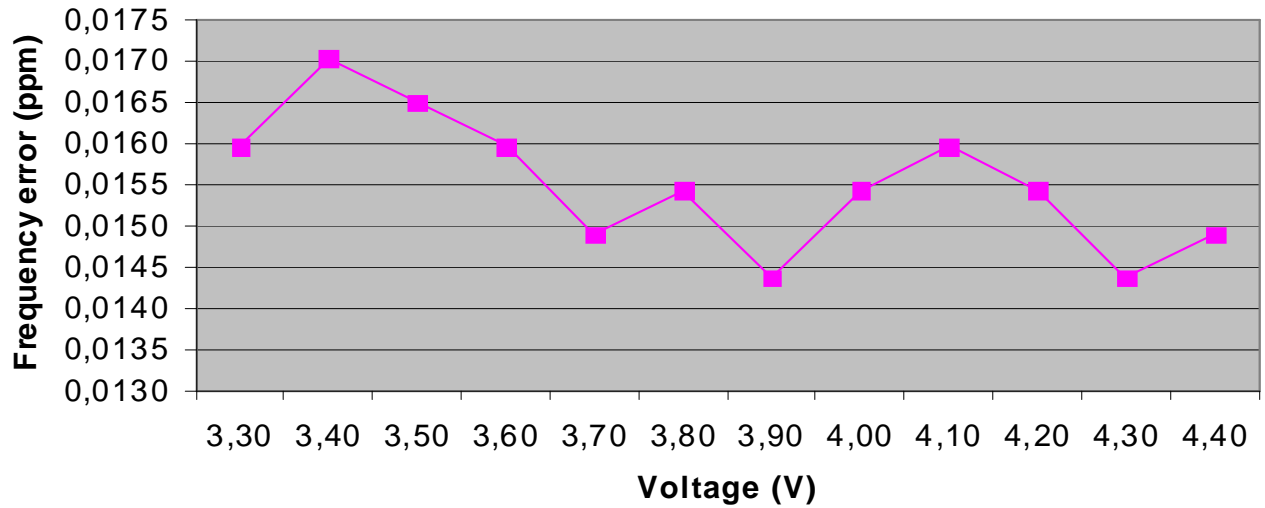

Frequency Error vs. Temperature

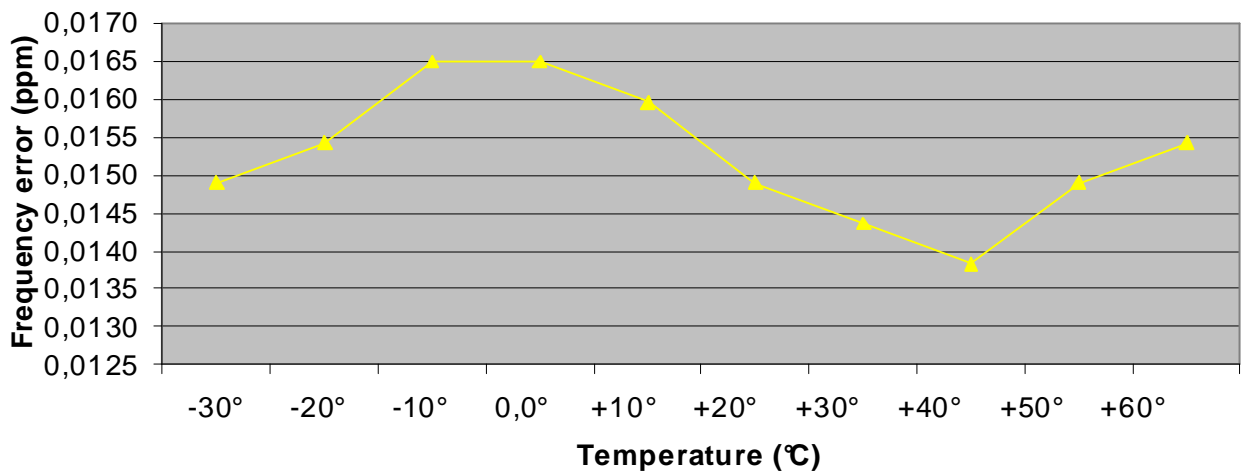

Result: The result of the measurement is passed.

8.5.3 Spurious emissions radiated

Description:

The following steps outline the procedure used to measure the radiated emissions from the mobile station. The site is constructed in accordance with ANSI C63.4:2009 requirements and is recognized by the FCC to be in compliance for a 3 and a 10 meter site. The spectrum was scanned from 30 MHz to the 10th harmonic of the highest frequency generated within the equipment, which is the transmitted carrier that can be as high as 1910 MHz. This was rounded up to 20 GHz. The resolution bandwidth is set as outlined in Part 24.238. The spectrum was scanned with the mobile station transmitting at carrier frequencies that pertain to low, mid and high channels of the UMTS band II.

The final open field emission (here 10m semi-anechoic chamber listed by FCC) test procedure is as follows:

- a) The test item was placed on a 0.8 meter high non-conductive stand at a 3 meter test distance from the receive antenna.
- b) The antenna output was terminated in a 50 ohm load (if possible).
- c) A double ridged wave guide antenna was placed on an adjustable height antenna mast 3 meters from the test item for emission measurements.
- d) Detected emissions were maximized at each frequency by rotating the test item and adjusting the receive antenna height and polarization. The maximum meter reading was recorded. The radiated emission measurements of the harmonics of the transmit frequency through the 10th harmonic were measured with peak detector and 1 MHz bandwidth. If the harmonic could not be detected above the noise floor, the ambient level was recorded. The equivalent power into a dipole antenna was calculated from the field intensity levels measured at 3 meters.
- e) Now each detected emissions were substituted by the substitution method, in accordance with the TIA/EIA 603 .

Measurement:

Measurement parameters	
Detector:	Peak
Sweep time:	2 sec.
Video bandwidth:	Below 1 GHz: 120 kHz Above 1 GHz: 1 MHz
Resolution bandwidth:	Below 1 GHz: 120 kHz Above 1 GHz: 1 MHz
Span:	100 MHz Steps
Trace-Mode:	Max Hold

Limits:

FCC	IC
CFR Part 24.238 CFR Part 2.1053	RSS 133, Issue 5, Section 6.5
Spurious Emissions Radiated	
Attenuation $\geq 43 + 10\log(P)$ (P, Power in Watts)	
-13 dBm	

Results:

Radiated emissions measurements were made only at the upper, center, and lower carrier frequencies of the UMTS band II (1852.4 MHz, 1880.0 MHz and 1907.6 MHz). It was decided that measurements at these three carrier frequencies would be sufficient to demonstrate compliance with emissions limits because it was seen that all the significant spurs occur well outside the band and no radiation was seen from a carrier in one block of the UMTS band II into any of the other blocks. The equipment must still, however, meet emissions requirements with the carrier at all frequencies over which it is capable of operating and it is the manufacturer's responsibility to verify this.

The final open field radiated levels are presented on the next pages.

All measurements were done in horizontal and vertical polarization; the plots show the worst case.

The plots show only the middle channel. If spurious were detected, the lowest and highest channel were checked too. The found values are stated in the table below.

As can be seen from this data, the emissions from the test item were within the specification limit.

Spurious Emission Level (dBm)								
Harmonic	Ch. 9262 Freq. (MHz)	Level [dBm]	Harmonic	Ch. 9400 Freq. (MHz)	Level [dBm]	Harmonic	Ch. 9538 Freq. (MHz)	Level [dBm]
2	3704.8	-	2	3760.0	-	2	3815.2	-
3	5557.2	-	3	5640.0	-	3	5722.8	-
4	7409.6	-	4	7520.0	-	4	7630.4	-
5	9262.0	-	5	9400.0	-	5	9538.0	-
6	11114.4	-	6	11280.0	-	6	11445.6	-
7	12966.8	-	7	13160.0	-	7	13353.2	-
8	14819.2	-	8	15040.0	-	8	15260.8	-
9	16671.6	-	9	16920.0	-	9	17168.4	-
10	18524.0	-	10	18800.0	-	10	19076.0	-
Measurement uncertainty					± 3dB			

Result: The result of the measurement is passed.

Plot 1: Channel 9400 (Traffic mode up to 30 MHz)

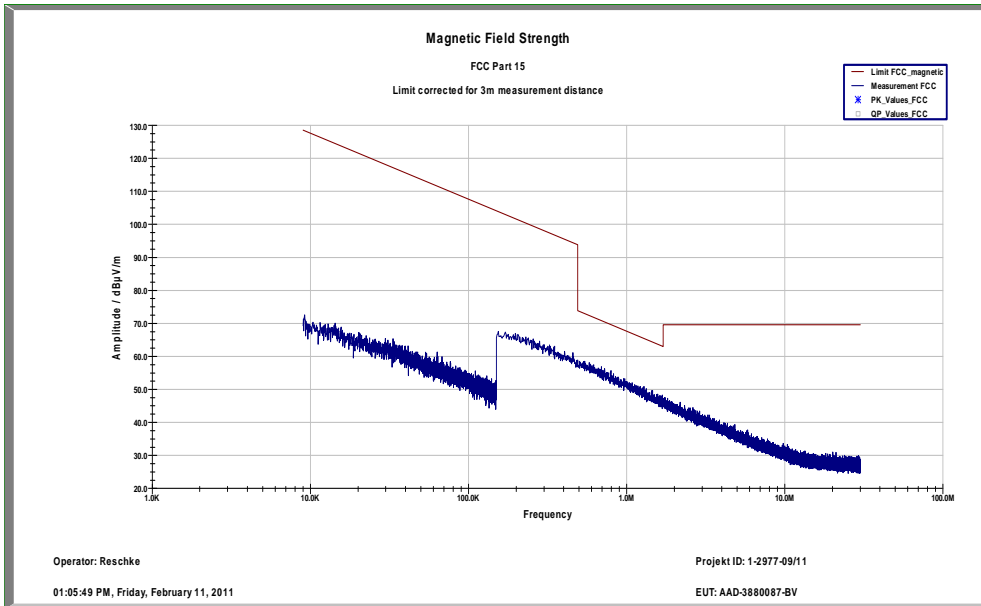

Plot 2: Channel 9400 (30 MHz - 1 GHz)

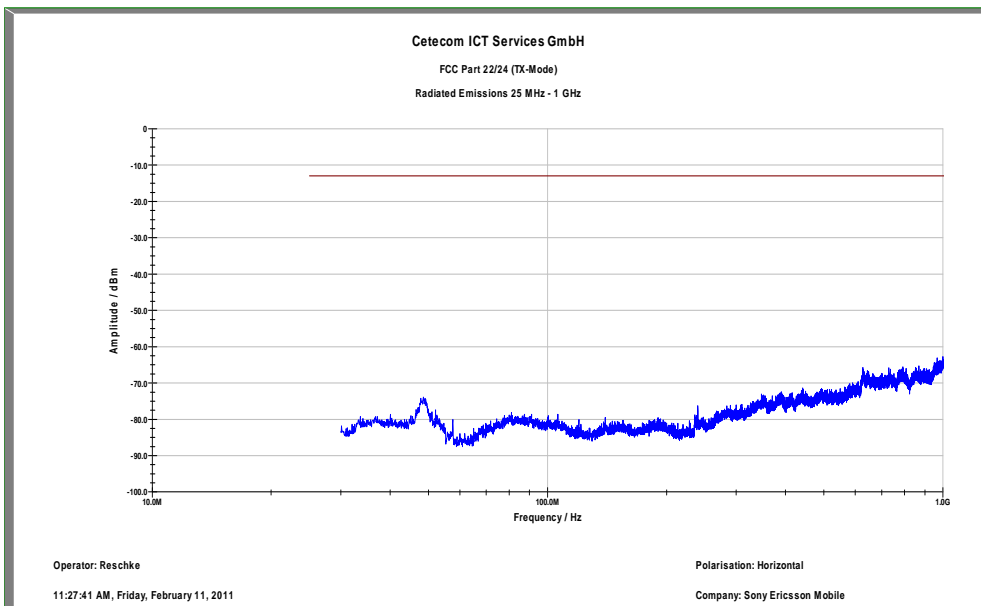

Plot 3: Channel 9400 (1 GHz – 12.75 GHz)

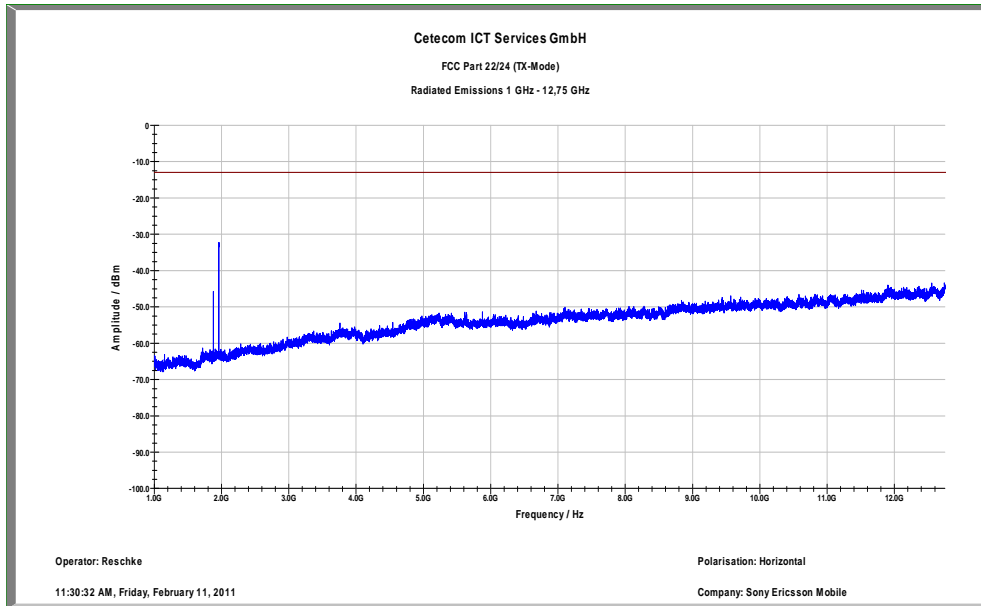

Carrier notched with 1.9 GHz rejection filter

Plot 4: Channel 9400 (12 GHz - 25 GHz)

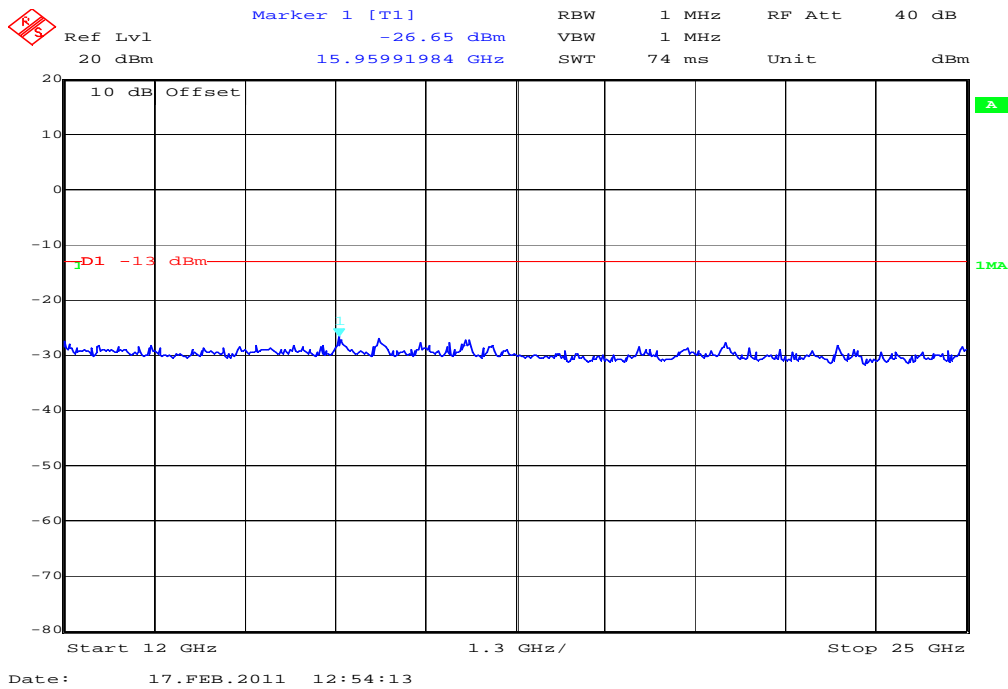

8.5.4 Spurious emissions conducted

Description:

The following steps outline the procedure used to measure the conducted emissions from the mobile station.

1. Determine frequency range for measurements: From CFR 2.1057 the spectrum should be investigated from the lowest radio frequency generated in the equipment up to at least the 10th harmonic of the carrier frequency. For the mobile station equipment tested, this equates to a frequency range of 13 MHz to 19.1 GHz, data taken from 10 MHz to 20 GHz.
2. Determine mobile station transmits frequencies: below outlines the band edge frequencies pertinent to conducted emissions testing.

UMTS band II Transmitter Channel Frequency

9262 1852.4 MHz

9400 1880.0 MHz

9538 1907.6 MHz

Measurement:

Measurement parameters	
Detector:	Peak
Sweep time:	Auto
Video bandwidth:	Pre-measurement with 1 MHz On spurious detection re-measurement below 1 GHz with 100 kHz Above 1 GHz with 1 MHz
Resolution bandwidth:	Pre-measurement with 1 MHz On spurious detection re-measurement below 1 GHz with 100 kHz Above 1 GHz with 1 MHz
Span:	30 MHz – 25 GHz
Trace-Mode:	Max Hold

Limits:

FCC	IC
CFR Part 24.238 CFR Part 2.1051	RSS 133, Issue 5, Section 6.5
Spurious Emissions Conducted	
Attenuation $\geq 43 + 10\log(P)$ (P, Power in Watts)	
-13 dBm	

Results:

Spurious Emission Level (dBm)								
Harmonic	Ch. 9262 Freq. (MHz)	Level [dBm]	Harmonic	Ch. 9400 Freq. (MHz)	Level [dBm]	Harmonic	Ch. 9538 Freq. (MHz)	Level [dBm]
2	3704.8	-	2	3760.0	-	2	3815.2	-
3	5557.2	-	3	5640.0	-	3	5722.8	-
4	7409.6	-	4	7520.0	-	4	7630.4	-
5	9262.0	-	5	9400.0	-	5	9538.0	-
6	11114.4	-	6	11280.0	-	6	11445.6	-
7	12966.8	-	7	13160.0	-	7	13353.2	-
8	14819.2	-	8	15040.0	-	8	15260.8	-
9	16671.6	-	9	16920.0	-	9	17168.4	-
10	18524.0	-	10	18800.0	-	10	19076.0	-
Measurement uncertainty					± 3dB			

Result: The result of the measurement is passed.

Plot 1: Channel 9262 (30 MHz - 25 GHz)

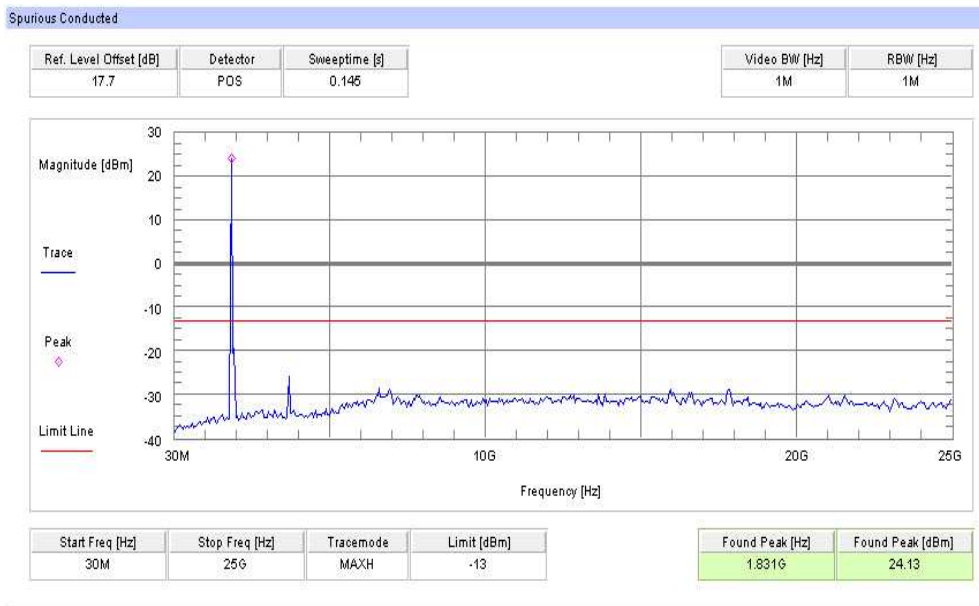

Plot 2: Channel 9400 (30 MHz - 25 GHz)

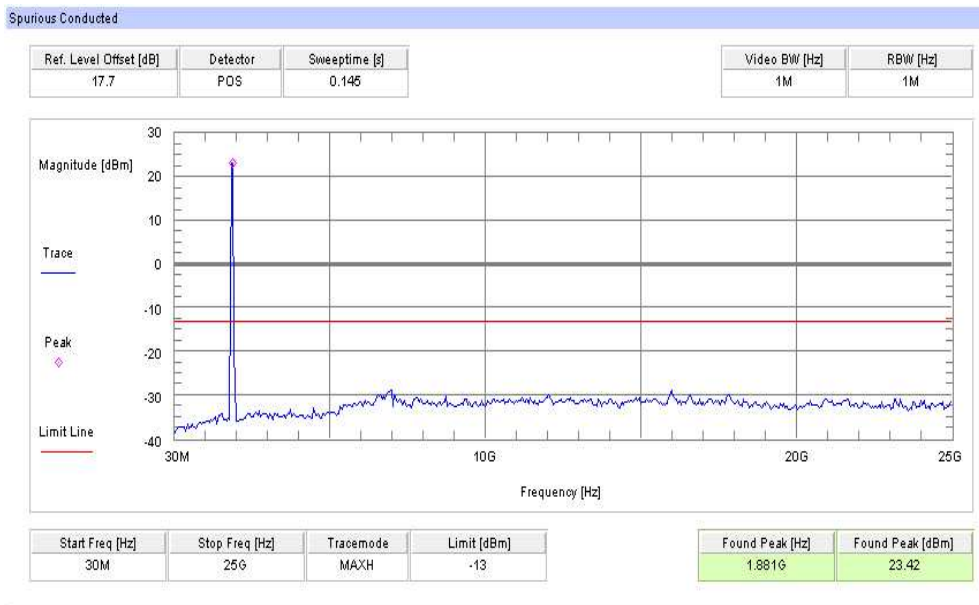

Plot 3: Channel 9538 (30 MHz - 25 GHz)

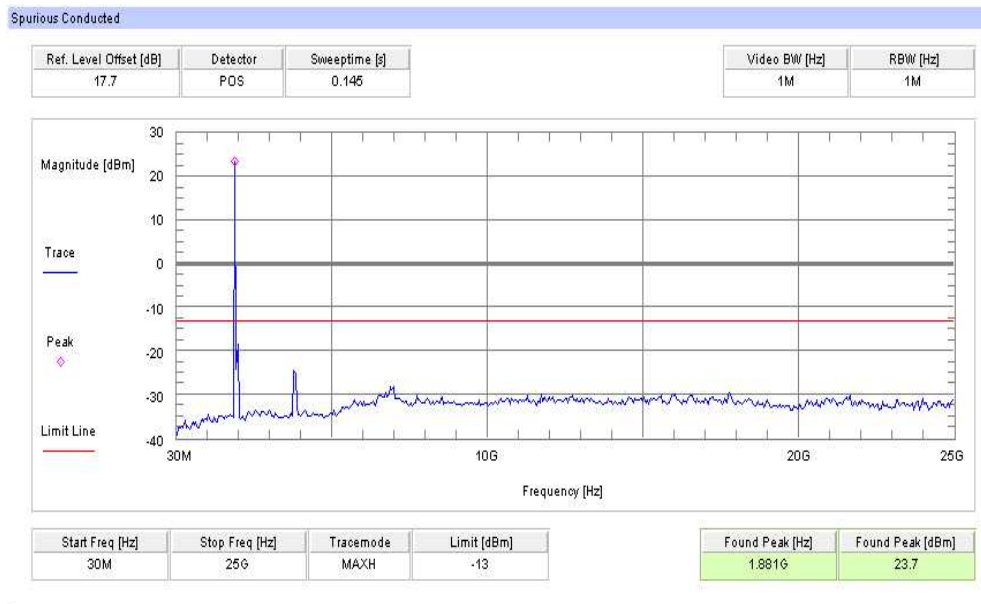

8.5.5 Block edge compliance

Description:

The spectrum at the band edges must comply with the spurious emissions limits.

Measurement:

Measurement parameters	
Detector:	RMS
Sweep time:	20 sec.
Video bandwidth:	30 kHz
Resolution bandwidth:	30 kHz
Span:	1 MHz
Trace-Mode:	Max Hold

Limits:

FCC	IC
CFR Part 24.238 CFR Part 2.1051	RSS 133, Issue 5, Section 6.5
Block Edge Compliance	
<p>Part 24.238 specifies that “the power of any emission outside of the authorized operating frequency ranges must be attenuated below the transmitting power (P) by a factor of at least 43 + 10 log(P) dB.”</p> <p>However, in publication number 890810, The FCC Office of Engineering and Technology specified the following correction to the limits when a resolution bandwidth smaller than 1% of the emission bandwidth is used:</p> <p>“An alternative is to add an additional correction factor of 10 Log (RBW1/ RBW2) to the 43 +10 Log (P) limit. RBW1 is the narrower measurement resolution bandwidth and RBW2 is either the 1% emissions bandwidth or 1 MHz.”</p> <p>When using a 30 kHz bandwidth, this yields a -2.2185 adjustment to the limit [10log(30kHz/50kHz) = -2.2185]. When this adjustment is applied to the limit, the limit becomes -15.2185.</p>	
-15.22 dBm	

Results:

Plot 1: Channel 9262

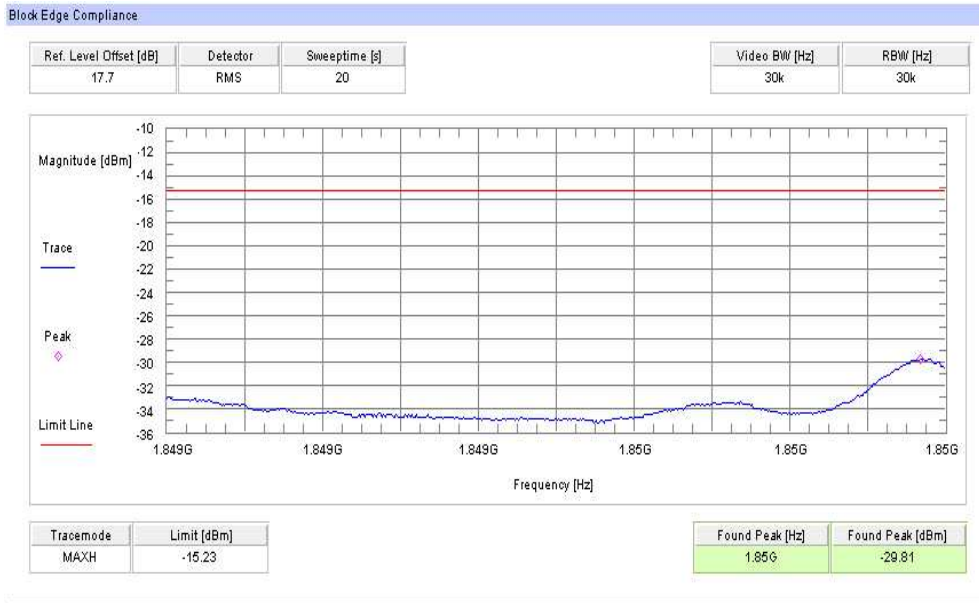

Plot 2: Channel 9538

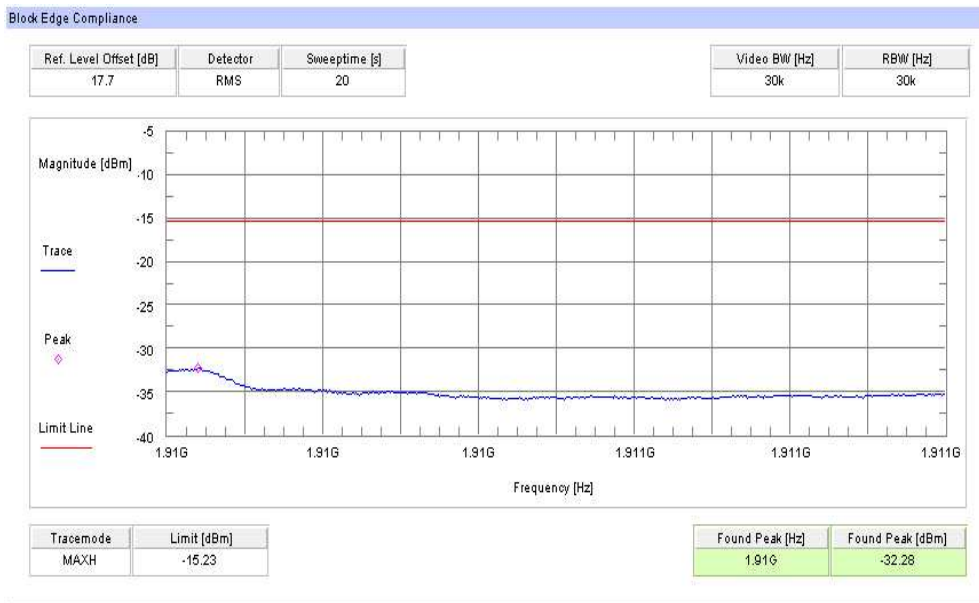

Result: The result of the measurement is passed.

8.5.6 Occupied bandwidth

Description:

Measurement of the occupied bandwidth of the transmitted signal.

Measurement:

Similar to conducted emissions, occupied bandwidth measurements are only provided for selected frequencies in order to reduce the amount of submitted data. Data were taken at the extreme and mid frequencies of the UMTS band II frequency band. The table below lists the measured 99% power and -26dBc occupied bandwidths. Spectrum analyzer plots are included on the following pages.

Part 24.238 requires a measurement bandwidth of at least 1% of the occupied bandwidth. For ca. 4700 kHz, this equates to a resolution bandwidth of at least 50 kHz. For this testing, a resolution bandwidth 100 kHz was used.

Measurement parameters	
Detector:	Peak
Sweep time:	Auto
Video bandwidth:	100 kHz
Resolution bandwidth:	100 kHz
Span:	6 MHz
Trace-Mode:	Max Hold

Limits:

FCC	IC
CFR Part 24.238 CFR Part 2.1049	RSS 133, Issue 5, Section 6.5
Occupied Bandwidth	
Spectrum must fall completely in the specified band	

Results:

Occupied Bandwidth		
Frequency (MHz)	99% OBW (kHz)	-26 dBc BW (kHz)
1852.4	4545	4677
1880.0	4569	4677
1907.6	4545	4653
Measurement uncertainty	± 100 kHz	

Result: [The result of the measurement is passed.](#)

Plot 1: Channel 9262 (99% - OBW)



Plot 2: Channel 9262 (-26 dBc BW)

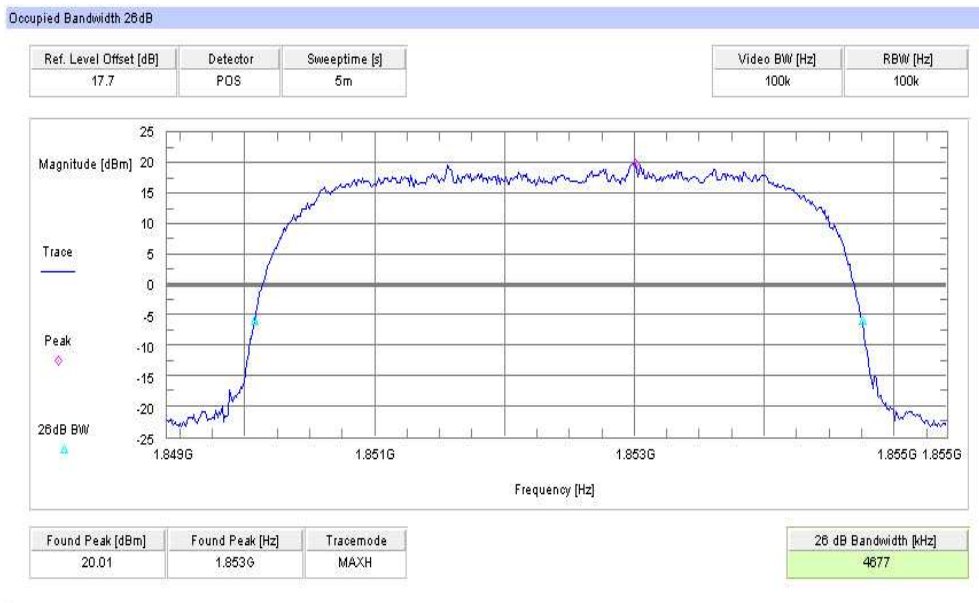

Plot 3: Channel 9400 (99% - OBW)

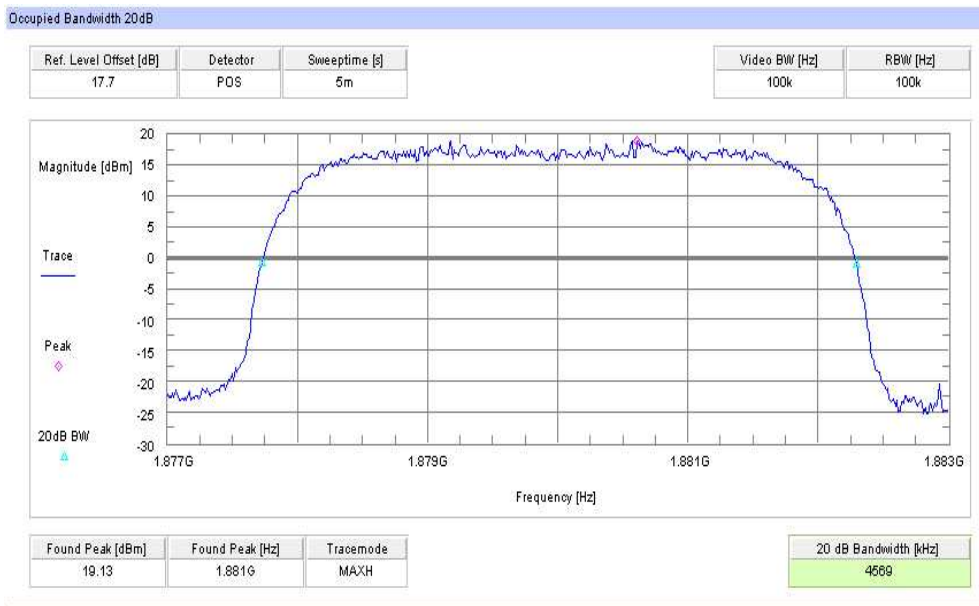

Plot 4: Channel 9400 (-26 dBc BW)

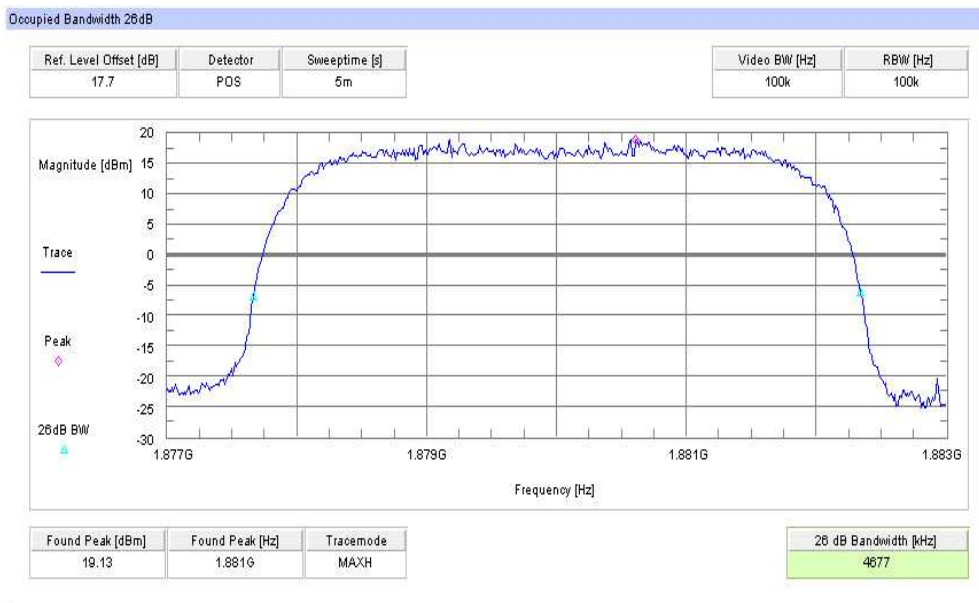

Plot 5: Channel 9538 (99% - OBW)

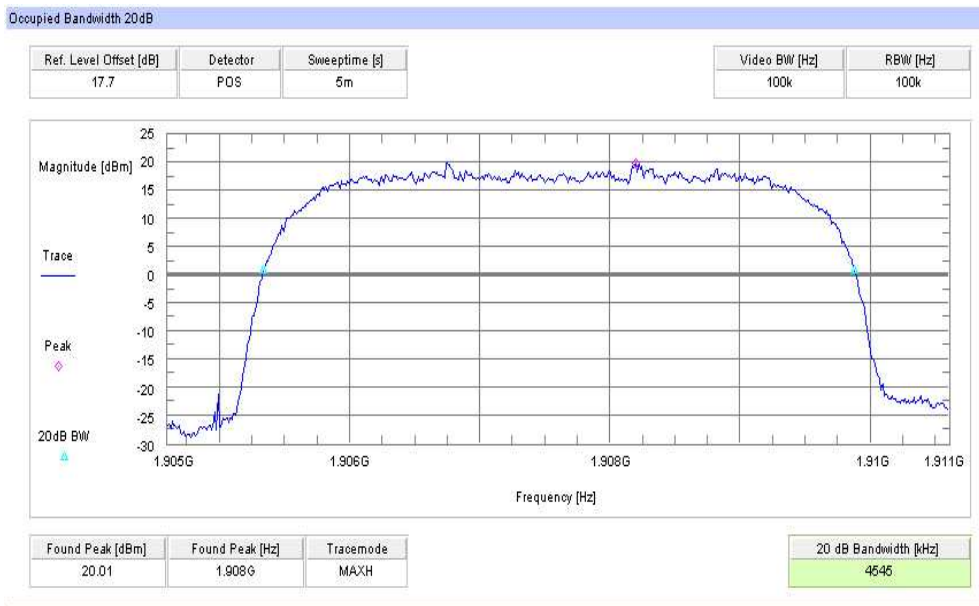

Plot 6: Channel 9538 (-26 dBc BW)

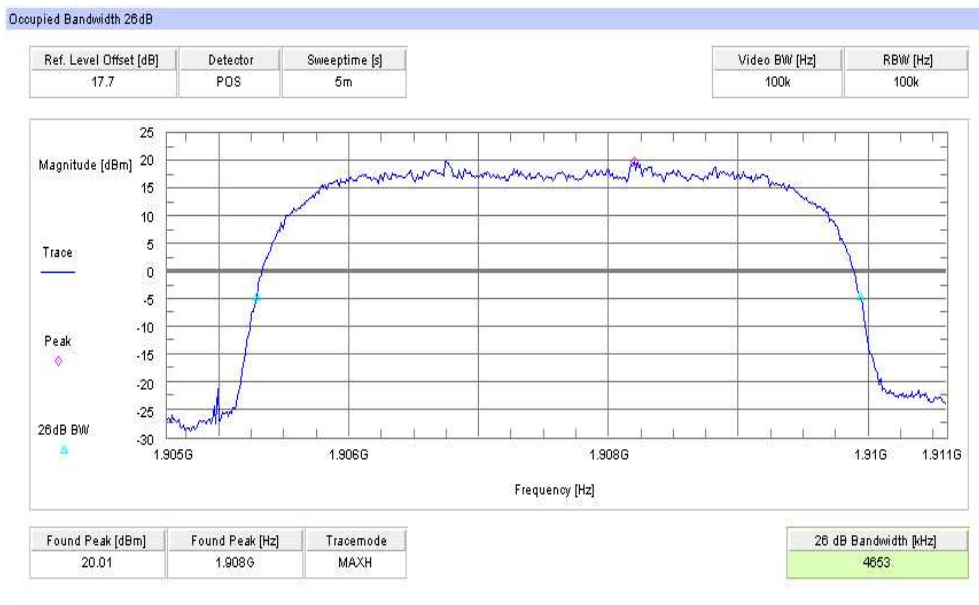

8.6 Results UMTS band V

All UMTS-band measurements are done in WCDMA mode only.

The connection was established with the following setup: WCDMA CS-RMC, Max Power (All Bit up)

8.6.1 RF output power

Description:

This paragraph contains average power, peak output power and ERP measurements for the mobile station. In all cases, the peak output power is within the required mask (this mask is specified in the JTC standards, TIA PN3389 Vol. 1 Chap 7, and is no FCC requirement).

Measurement:

The mobile was set up for the maximum output power with pseudo random data modulation.

To determine the Peak-To-Average Power Ratio (PAPR) the measurement was performed with the Power Complementary Cumulative Distribution Function (CCDF).

Measurement parameters	
Detector:	Peak and RMS (Power in Burst)
Sweep time:	Auto
Video bandwidth:	10 MHz
Resolution bandwidth:	10 MHz
Span:	Zero Span
Trace-Mode:	Max Hold

Limits:

FCC	IC
CFR Part 22.9.1.3 CFR Part 2.1046	RSS 132, Issue 2, Section 4.4 and 6.4
Nominal Peak Output Power	
+38.45 dBm	
In measuring transmissions in this band using an average power technique, the peak-to-average ratio (PAR) of the transmission may not exceed 13 dB.	

Results:

Output Power (conducted) WCDMA mode		
Frequency (MHz)	Average Output Power (dBm)	Peak to Average Ratio (dB)
826.4	24.43	3.78
836.0	24.27	3.63
846.6	24.16	3.52
Measurement uncertainty	± 0.5 dB	

Output Power (radiated) WCDMA mode	
Frequency (MHz)	Average Output Power (dBm) - ERP
826.4	21.51
836.0	21.72
846.6	21.94
Measurement uncertainty	± 2.0 dB

Result: The result of the measurement is passed.

8.6.2 Frequency stability

Description:

In order to measure the carrier frequency under the condition of AFC lock, it is necessary to make measurements with the mobile station in a “call mode”. This is accomplished with the use of a R&S CMU200 DIGITAL RADIOCOMMUNICATION TESTER.

1. Measure the carrier frequency at room temperature.
2. Subject the mobile station to overnight soak at -30 C.
3. With the mobile station, powered with V_{nom} , connected to the CMU200 and in a simulated call on channel 4180 (centre channel), measure the carrier frequency. These measurements should be made within two minutes of powering up the mobile station, to prevent significant self warming.
4. Repeat the above measurements at 10°C increments from -30°C to +60°C. Allow at least 1.5 hours at each temperature, unpowered, before making measurements.
5. Remeasure carrier frequency at room temperature with V_{nom} . Vary supply voltage from V_{min} to V_{max} , in 0.1 Volt steps remeasuring carrier frequency at each voltage. Pause at V_{nom} for 1.5 hours unpowered, to allow any self heating to stabilize, before continuing.
6. At all temperature levels hold the temperature to +/- 0.5°C during the measurement procedure.

Measurement:

Measurement parameters	
Detector:	Measured with CMU200
Sweep time:	
Video bandwidth:	
Resolution bandwidth:	
Span:	
Trace-Mode:	

Limits:

FCC	IC
CFR Part 22.355 CFR Part 2.1055	RSS 132, Issue 2, Section 4.3 and 6.3
Frequency Stability	
± 0.1 ppm	

Results:**AFC FREQ ERROR versus VOLTAGE**

Voltage (V)	Frequency Error (Hz)	Frequency Error (%)	Frequency Error (ppm)
3.3	-10	-0,00000120	-0,0120
3.4	-9	-0,00000108	-0,0108
3.5	-11	-0,00000132	-0,0132
3.6	-10	-0,00000120	-0,0120
3.7	-9	-0,00000108	-0,0108
3.8	-10	-0,00000120	-0,0120
3.9	-10	-0,00000120	-0,0120
4.0	-9	-0,00000108	-0,0108
4.1	-11	-0,00000132	-0,0132
4.2	-13	-0,00000156	-0,0156
4.3	-12	-0,00000144	-0,0144
4.4	-12	-0,00000144	-0,0144

AFC FREQ ERROR versus TEMPERATURE

Temperature (°C)	Frequency Error (Hz)	Frequency Error (%)	Frequency Error (ppm)
-30	-14	-0,00000167	-0,0167
-20	-12	-0,00000144	-0,0144
-10	-11	-0,00000132	-0,0132
± 0	-10	-0,00000120	-0,0120
10	-11	-0,00000132	-0,0132
20	-9	-0,00000108	-0,0108
30	-12	-0,00000144	-0,0144
40	-11	-0,00000132	-0,0132
50	-10	-0,00000120	-0,0120
60	-12	-0,00000144	-0,0144

Frequency Error vs. Voltage

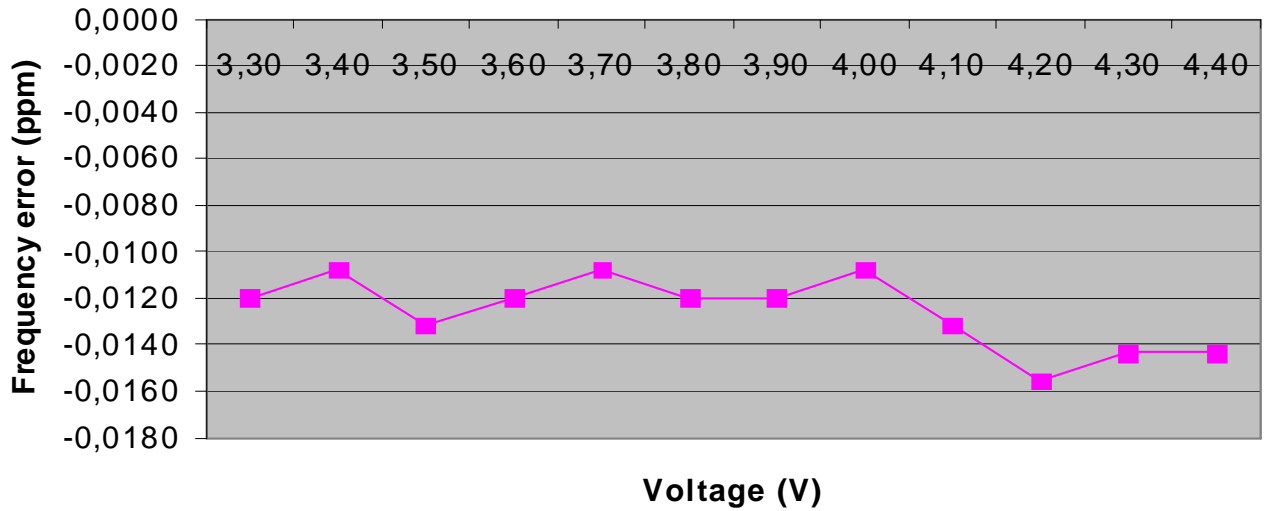

Frequency Error vs. Temperature

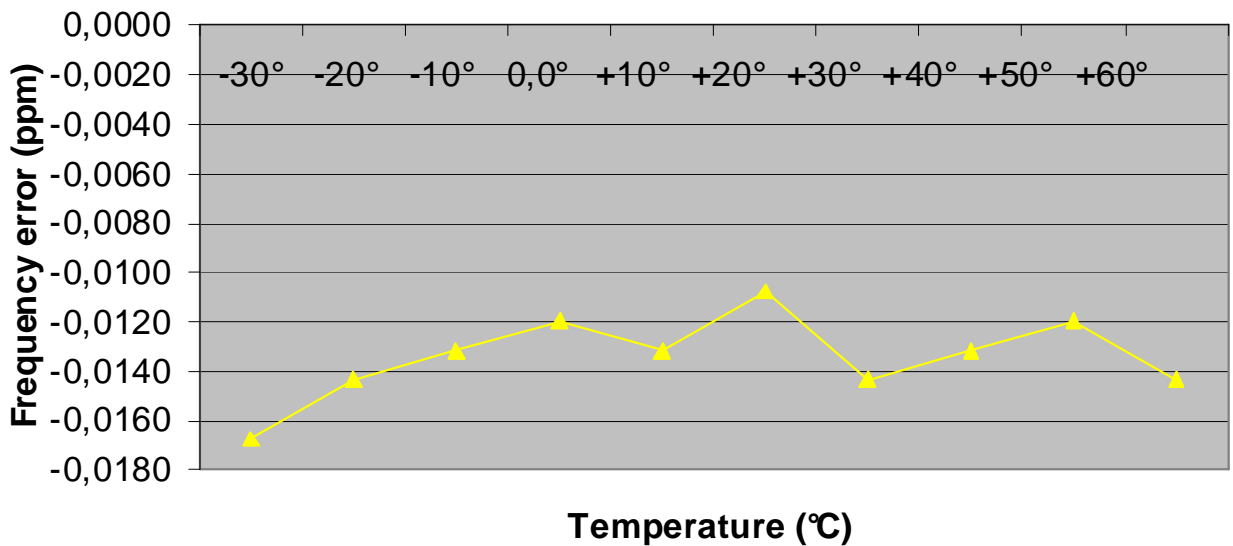

Result: The result of the measurement is passed.

8.6.3 Spurious emissions radiated

Description:

The following steps outline the procedure used to measure the radiated emissions from the mobile station. The site is constructed in accordance with ANSI C63.4:2009 requirements and is recognized by the FCC to be in compliance for a 3 and a 10 meter site. The spectrum was scanned from 30 MHz to the 10th harmonic of the highest frequency generated within the equipment, which is the transmitted carrier that can be as high as 846.6 MHz. This was rounded up to 12 GHz. The resolution bandwidth is set as outlined in Part 22.917. The spectrum was scanned with the mobile station transmitting at carrier frequencies that pertain to low, mid and high channels of the UMTS band V.

The final open field emission (here 10m semi-anechoic chamber listed by FCC) test procedure is as follows:

- a) The test item was placed on a 0.8 meter high non-conductive stand at a 3 meter test distance from the receive antenna.
- b) The antenna output was terminated in a 50 ohm load (if possible).
- c) A double ridged wave guide antenna was placed on an adjustable height antenna mast 3 meters from the test item for emission measurements.
- d) Detected emissions were maximized at each frequency by rotating the test item and adjusting the receive antenna height and polarization. The maximum meter reading was recorded. The radiated emission measurements of the harmonics of the transmit frequency through the 10th harmonic were measured with peak detector and 1 MHz bandwidth. If the harmonic could not be detected above the noise floor, the ambient level was recorded. The equivalent power into a dipole antenna was calculated from the field intensity levels measured at 3 meters.
- e) Now each detected emissions were substituted by the substitution method, in accordance with the TIA/EIA 603 .

Measurement:

Measurement parameters	
Detector:	Peak
Sweep time:	2 sec.
Video bandwidth:	Below 1 GHz: 120 kHz Above 1 GHz: 1 MHz
Resolution bandwidth:	Below 1 GHz: 120 kHz Above 1 GHz: 1 MHz
Span:	100 MHz Steps
Trace-Mode:	Max Hold

Limits:

FCC	IC
CFR Part 22.917 CFR Part 2.1053	RSS 132, Issue 2, Section 4.5 and 6.5
Spurious Emissions Radiated	
Attenuation $\geq 43 + 10\log(P)$ (P, Power in Watts)	
-13 dBm	

Results:

Radiated emissions measurements were made only at the upper, center, and lower carrier frequencies of the UMTS band V (826.4 MHz, 836.0 MHz and 846.6 MHz). It was decided that measurements at these three carrier frequencies would be sufficient to demonstrate compliance with emissions limits because it was seen that all the significant spurs occur well outside the band and no radiation was seen from a carrier in one block of the UMTS band V into any of the other blocks. The equipment must still, however, meet emissions requirements with the carrier at all frequencies over which it is capable of operating and it is the manufacturer's responsibility to verify this.

The final open field radiated levels are presented on the next pages. All measurements were done in horizontal and vertical polarization; the plots show the worst case. The plots show only the middle channel. If spurious were detected, the lowest and highest channel were checked too. The found values are stated in the table below.

As can be seen from this data, the emissions from the test item were within the specification limit.

Spurious Emission Level (dBm)								
Harmonic	Ch. 4132 Freq. (MHz)	Level [dBm]	Harmonic	Ch. 4180 Freq. (MHz)	Level [dBm]	Harmonic	Ch. 4233 Freq. (MHz)	Level [dBm]
2	1652.8	-	2	1672.0	-	2	1693.2	-
3	2479.2	-	3	2508.0	-	3	2539.8	-
4	3305.6	-	4	3344.0	-	4	3386.4	-
5	4132.0	-	5	4180.0	-	5	4233.0	-
6	4958.4	-	6	5016.0	-	6	5079.6	-
7	5784.8	-	7	5852.0	-	7	5926.2	-
8	6611.2	-	8	6688.0	-	8	6772.8	-
9	7437.6	-	9	7524.0	-	9	7619.4	-
10	8264.0	-	10	8360.0	-	10	8466.0	-
Measurement uncertainty					± 3dB			

Result: The result of the measurement is passed.

Plot 1: Channel 4180 (Traffic mode up to 30 MHz)

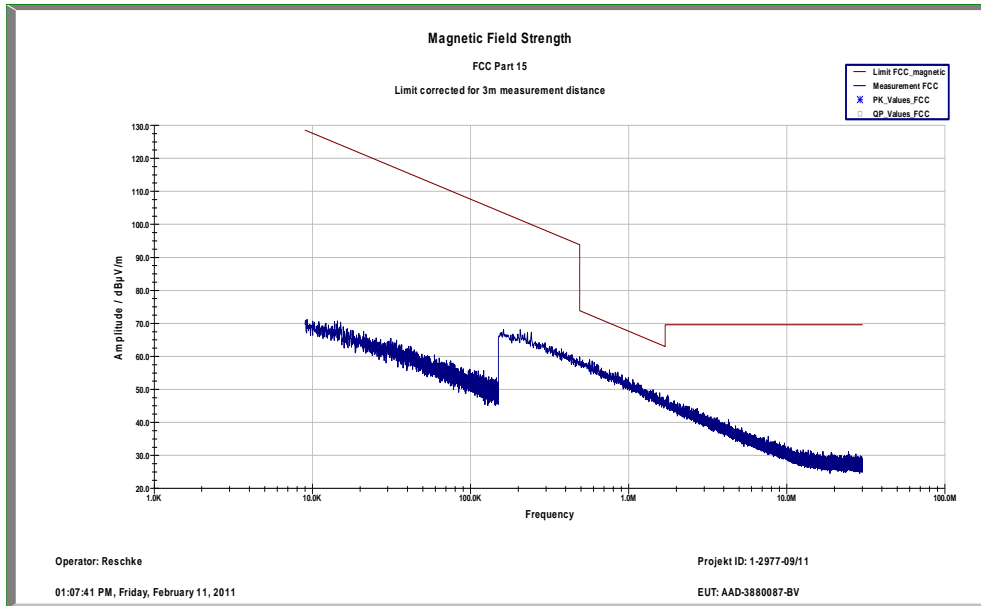

Plot 2: Channel 4180 (30 MHz - 1 GHz)

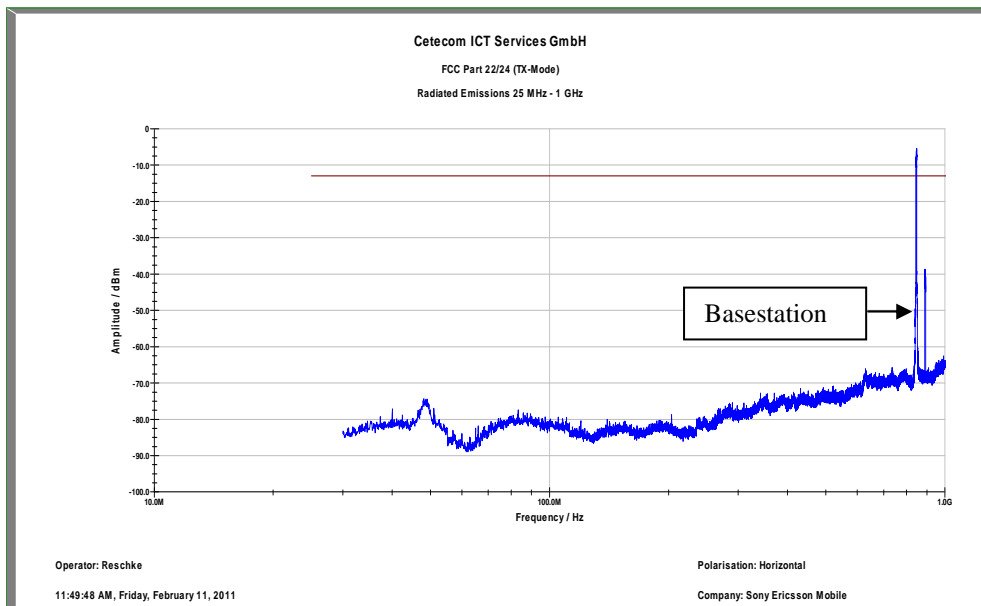

Plot 3: Channel 4180 (1 GHz – 12.75 GHz)

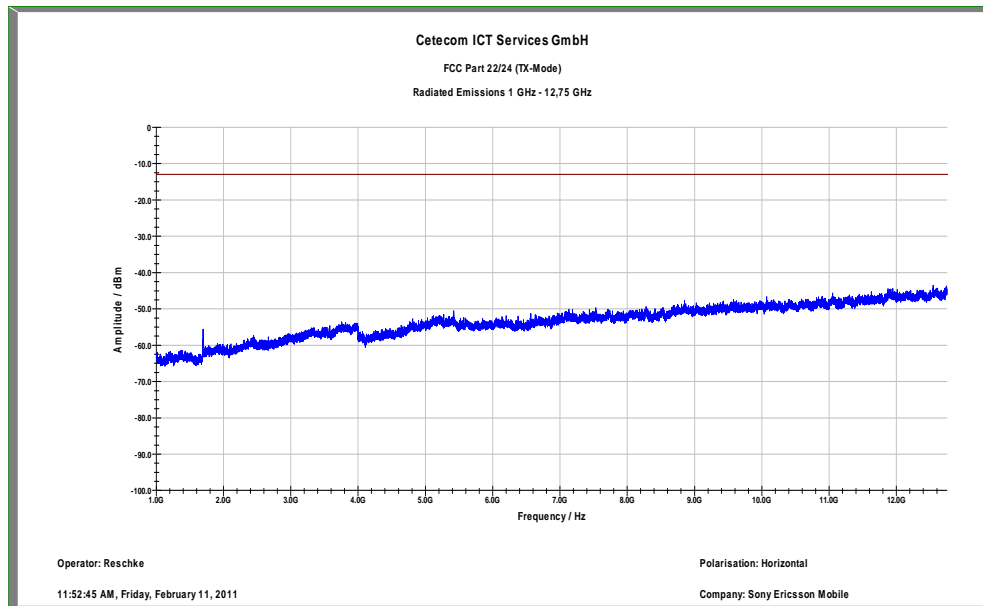

8.6.4 Spurious emissions conducted

Description:

The following steps outline the procedure used to measure the conducted emissions from the mobile station.

1. Determine frequency range for measurements: From CFR 2.1057 the spectrum should be investigated from the lowest radio frequency generated in the equipment up to at least the 10th harmonic of the carrier frequency. For the mobile station equipment tested, this equates to a frequency range of 13 MHz to 9 GHz, data taken from 10 MHz to 12 GHz.
2. Determine mobile station transmits frequencies: below outlines the band edge frequencies pertinent to conducted emissions testing.

UMTS band V Transmitter Channel Frequency

4132 826.4 MHz

4180 836.0 MHz

4233 846.6 MHz

Measurement:

Measurement parameters	
Detector:	Peak
Sweep time:	Auto
Video bandwidth:	Pre-measurement with 1 MHz On spurious detection re-measurement below 1 GHz with 100 kHz Above 1 GHz with 1 MHz
Resolution bandwidth:	Pre-measurement with 1 MHz On spurious detection re-measurement below 1 GHz with 100 kHz Above 1 GHz with 1 MHz
Span:	30 MHz – 25 GHz
Trace-Mode:	Max Hold

Limits:

FCC	IC
CFR Part 22.917 CFR Part 2.1051	RSS 132, Issue 2, Section 4.5 and 6.5
Spurious Emissions Conducted	
Attenuation $\geq 43 + 10\log(P)$ (P, Power in Watts)	
-13 dBm	

Results:

Spurious Emission Level (dBm)								
Harmonic	Ch. 4132 Freq. (MHz)	Level [dBm]	Harmonic	Ch. 4180 Freq. (MHz)	Level [dBm]	Harmonic	Ch. 4233 Freq. (MHz)	Level [dBm]
2	1652.8	-	2	1672.0	-	2	1693.2	-
3	2479.2	-	3	2508.0	-	3	2539.8	-
4	3305.6	-	4	3344.0	-	4	3386.4	-
5	4132.0	-	5	4180.0	-	5	4233.0	-
6	4958.4	-	6	5016.0	-	6	5079.6	-
7	5784.8	-	7	5852.0	-	7	5926.2	-
8	6611.2	-	8	6688.0	-	8	6772.8	-
9	7437.6	-	9	7524.0	-	9	7619.4	-
10	8264.0	-	10	8360.0	-	10	8466.0	-
Measurement uncertainty					± 3dB			

Result: The result of the measurement is passed.

Plot 1: Channel 4132 (30 MHz - 25 GHz)

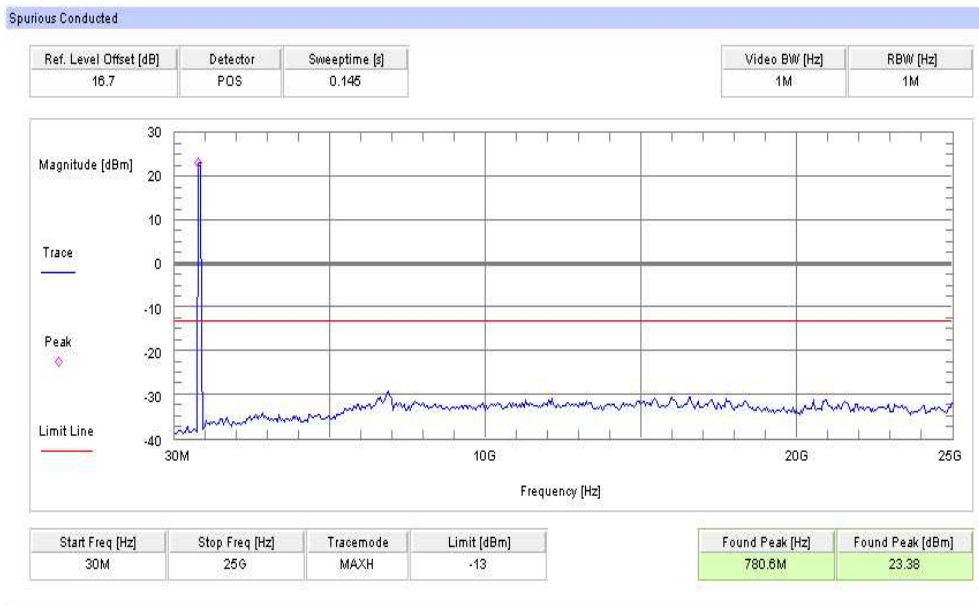

Plot 2: Channel 4180 (30 MHz - 25 GHz)

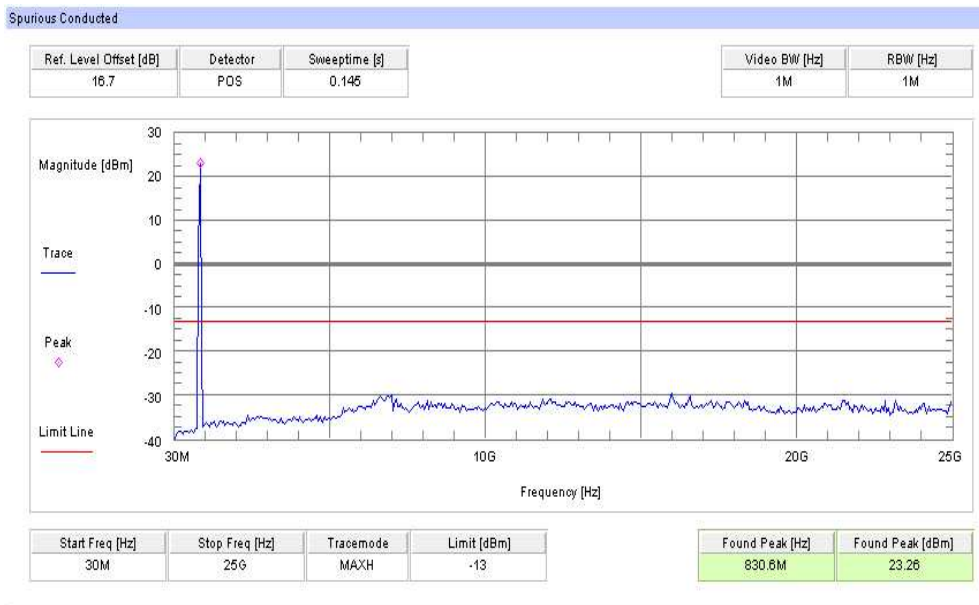

Plot 3: Channel 4233 (30 MHz - 25 GHz)

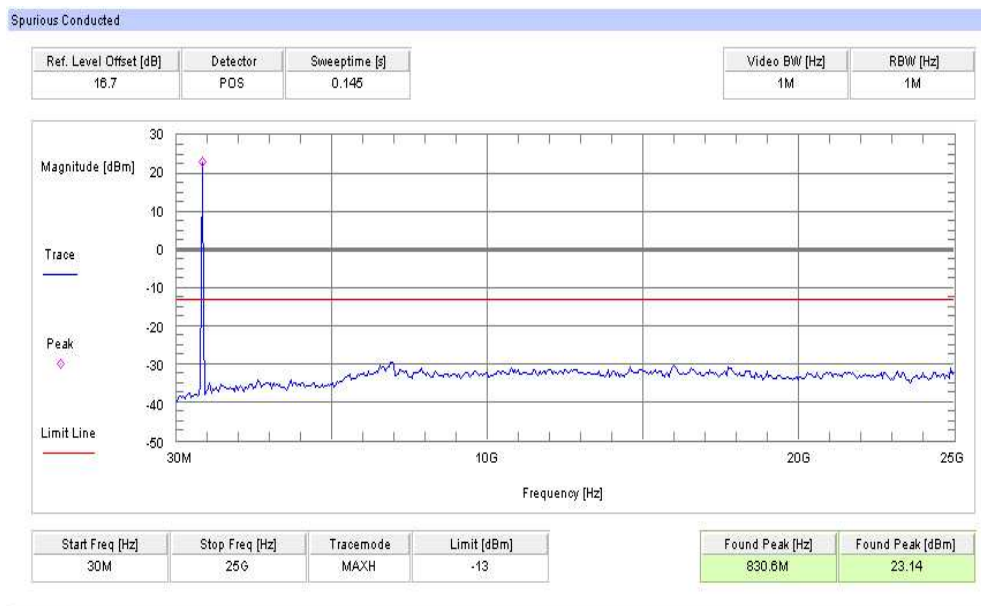

8.6.5 Block edge compliance

Description:

The spectrum at the band edges must comply with the spurious emissions limits.

Measurement:

Measurement parameters	
Detector:	RMS
Sweep time:	20 sec.
Video bandwidth:	30 kHz
Resolution bandwidth:	30 kHz
Span:	1 MHz
Trace-Mode:	Max Hold

Limits:

FCC	IC
CFR Part 22.917 CFR Part 2.1051	RSS 132, Issue 2, Section 6.5
Block Edge Compliance	
<p>Part 22.917 specifies that “the power of any emission outside of the authorized operating frequency ranges must be attenuated below the transmitting power (P) by a factor of at least 43 + 10 log(P) dB.”</p> <p>However, in publication number 890810, The FCC Office of Engineering and Technology specified the following correction to the limits when a resolution bandwidth smaller than 1% of the emission bandwidth is used:</p> <p>“An alternative is to add an additional correction factor of 10 Log (RBW1/ RBW2) to the 43 +10 log(P) limit. RBW1 is the narrower measurement resolution bandwidth and RBW2 is either the 1% emissions bandwidth or 1 MHz.”</p> <p>When using a 30 kHz bandwidth, this yields a -2.2185 adjustment to the limit [10 log(30kHz/50kHz) = -2.2185]. When this adjustment is applied to the limit, the limit becomes -15.2185.</p>	
-15.22 dBm	

Results:

Plot 1: Channel 4132

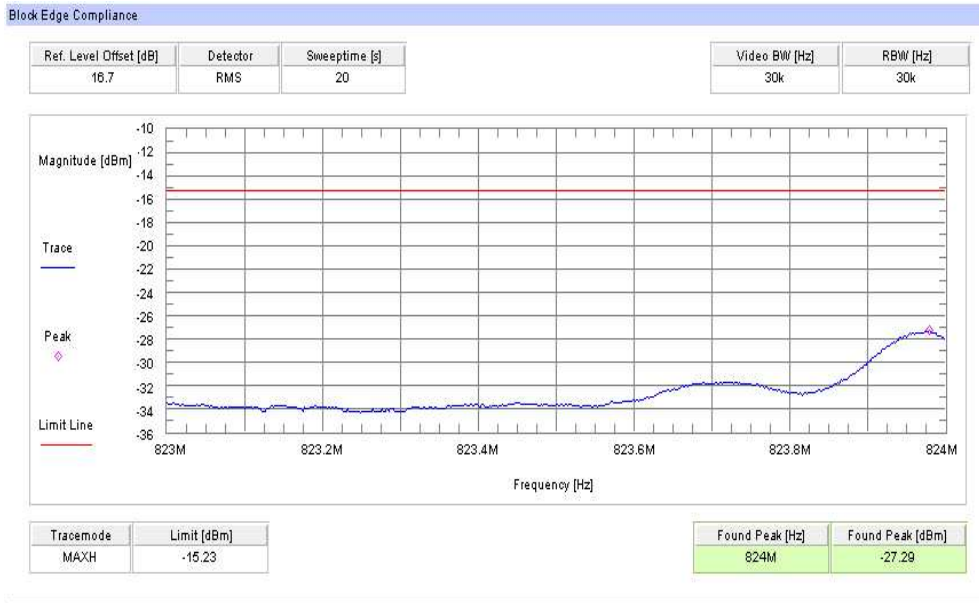

Plot 2: Channel 4233

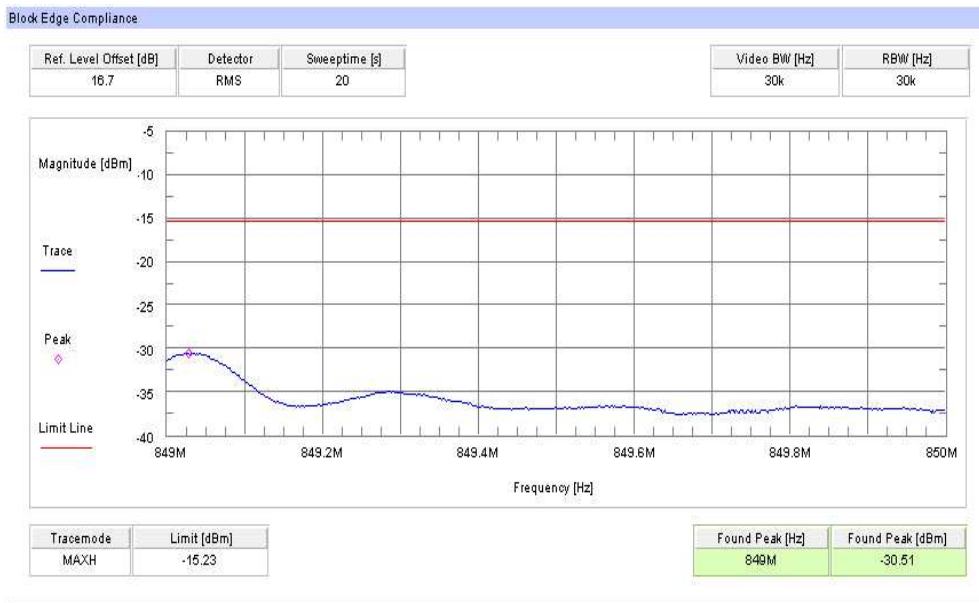

Result: The result of the measurement is passed.

8.6.6 Occupied bandwidth

Description:

Measurement of the occupied bandwidth of the transmitted signal.

Measurement:

Similar to conducted emissions, occupied bandwidth measurements are only provided for selected frequencies in order to reduce the amount of submitted data. Data were taken at the extreme and mid frequencies of the UMTS band V. The table below lists the measured 99% power and -26dBc occupied bandwidths. Spectrum analyzer plots are included on the following pages.

Part 22.917 requires a measurement bandwidth of at least 1% of the occupied bandwidth. For ca. 4700 kHz, this equates to a resolution bandwidth of at least 50 kHz. For this testing, a resolution bandwidth 100 kHz was used.

Measurement parameters	
Detector:	Peak
Sweep time:	Auto
Video bandwidth:	100 kHz
Resolution bandwidth:	100 kHz
Span:	6 MHz
Trace-Mode:	Max Hold

Limits:

FCC	IC
CFR Part 22.917 CFR Part 2.1049	RSS 132, Issue 2, Section 4.5.1
Occupied Bandwidth	
Spectrum must fall completely in the specified band	

Results:

Occupied Bandwidth		
Frequency (MHz)	99% OBW (kHz)	-26 dBc BW (kHz)
826.4	4533	4653
836.0	4545	4653
846.6	4533	4665
Measurement uncertainty	± 100 kHz	

Result: [The result of the measurement is passed.](#)

Plot 1: Channel 4132 (99% - OBW)

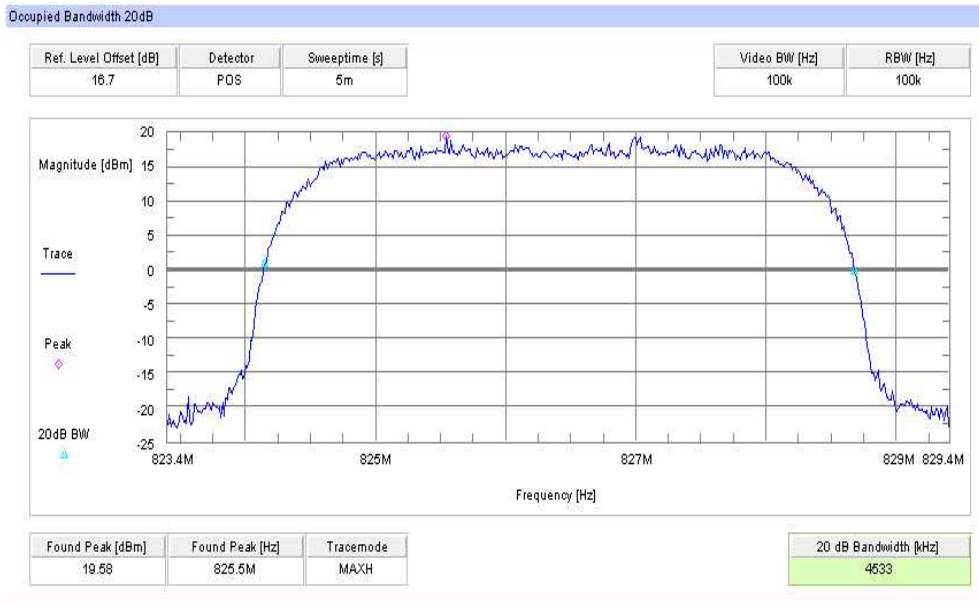

Plot 2: Channel 4132 (-26 dBc BW)

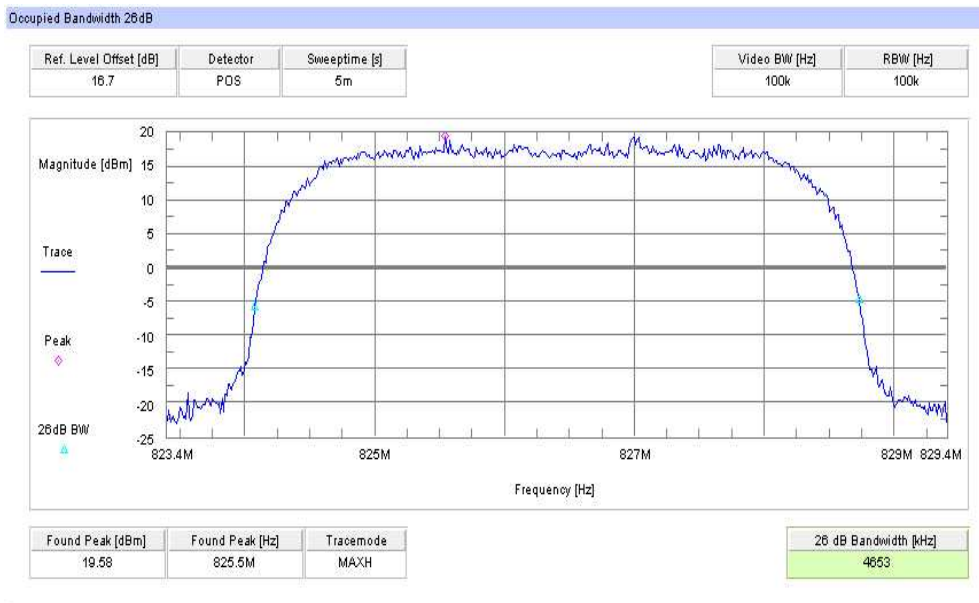

Plot 3: Channel 4180 (99% - OBW)

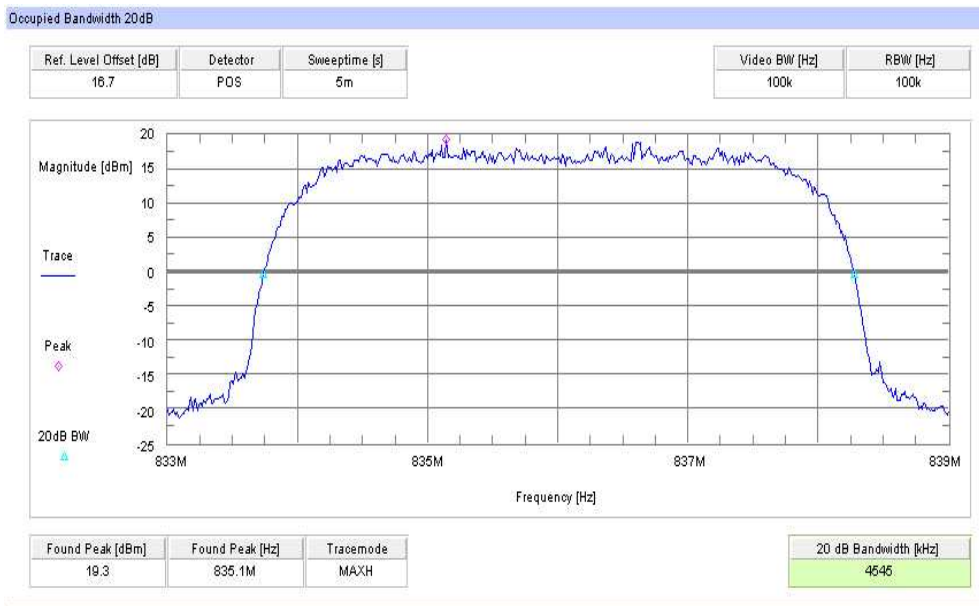

Plot 4: Channel 4180 (-26 dBc BW)

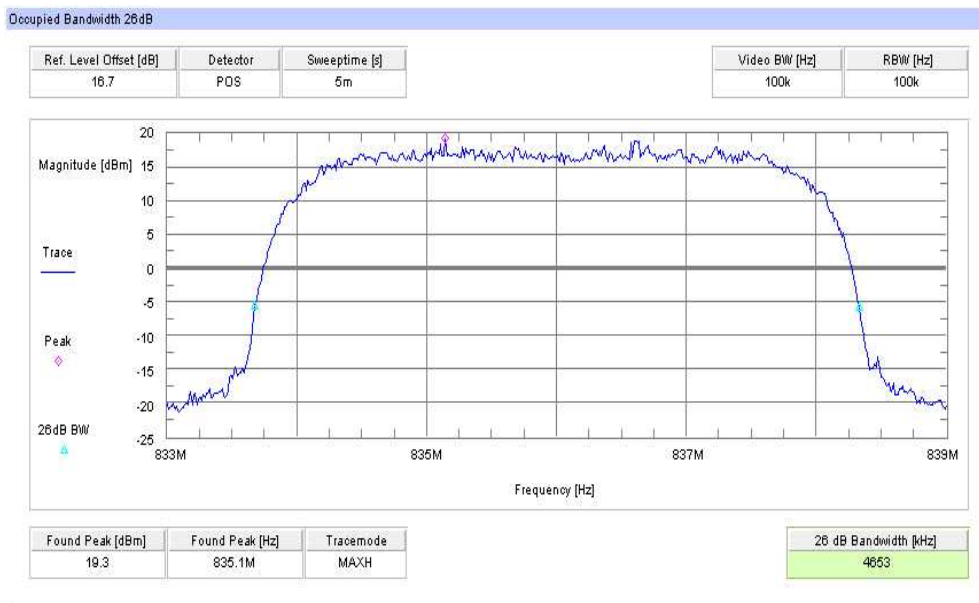

Plot 5: Channel 4233 (99% - OBW)

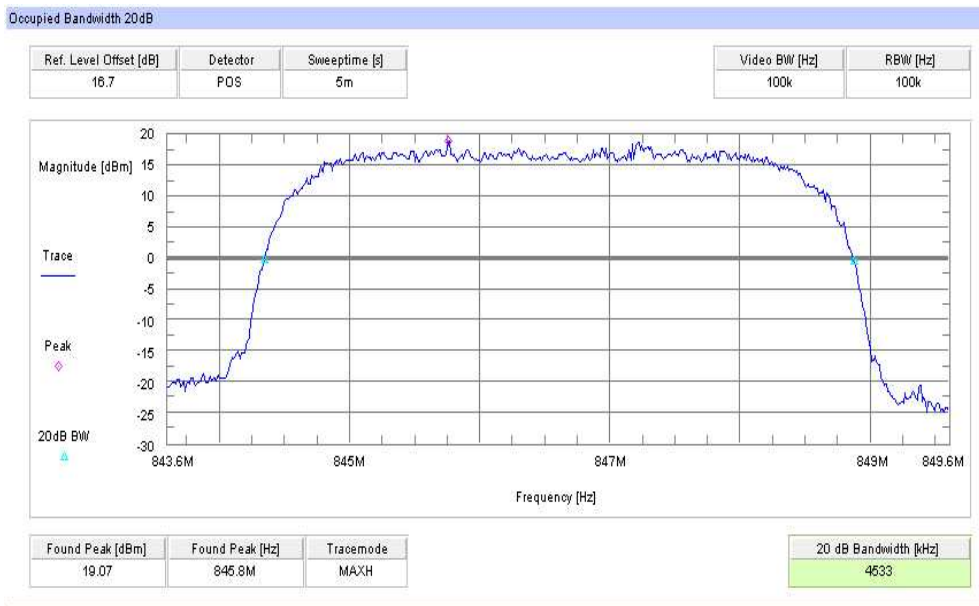

Plot 6: Channel 4233 (-26 dBc BW)

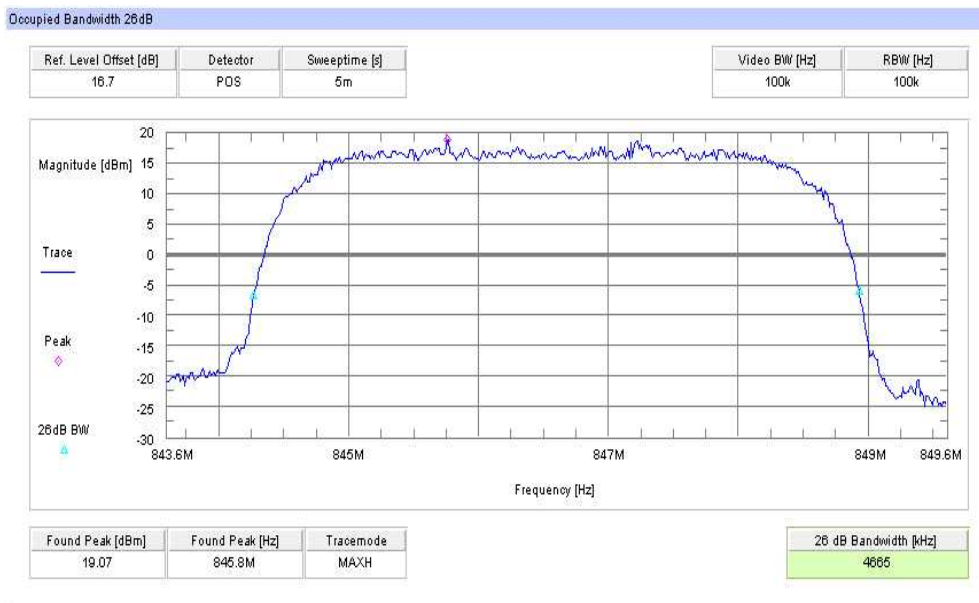

8.7 Results receiver mode

8.7.1 Spurious emissions radiated – receiver mode

Description:

The measurement was performed in worst case. The EUT was not connected to the CMU 200. So the EUT performs a network search. In this mode all oscillators are active.

Measurement:

Measurement parameters	
Detector:	Below 1 GHz Peak / QuasiPeak Above 1 GHz Peak / Average
Sweep time:	2 sec
Video bandwidth:	Below 1 GHz 100 kHz Above 1 GHz 1 MHz
Resolution bandwidth:	1 MHz
Span:	100 MHz Steps
Trace-Mode:	Max Hold

Limits:

FCC		IC	
CFR Part 15.109 CFR Part 2.1053		RSS Gen, Issue 2, Section 4.10	
Spurious Emissions Radiated – Receiver Mode			
Frequency (MHz)	Field Strength (dB μ V/m)	Measurement distance (m)	
30 – 88	30.0	10	
88 - 216	33.5	10	
216 – 960	36.0	10	
Above 960	54.0	3	

Results:

Spurious Emission Level (dB μ V/m)		
Frequency (MHz)	Detector	Level (dB μ V/m)
No critical peaks found		
Measurement uncertainty		± 3dB

Result: [The result of the measurement is passed.](#)

Plot 1: Receiver mode up to 30 MHz

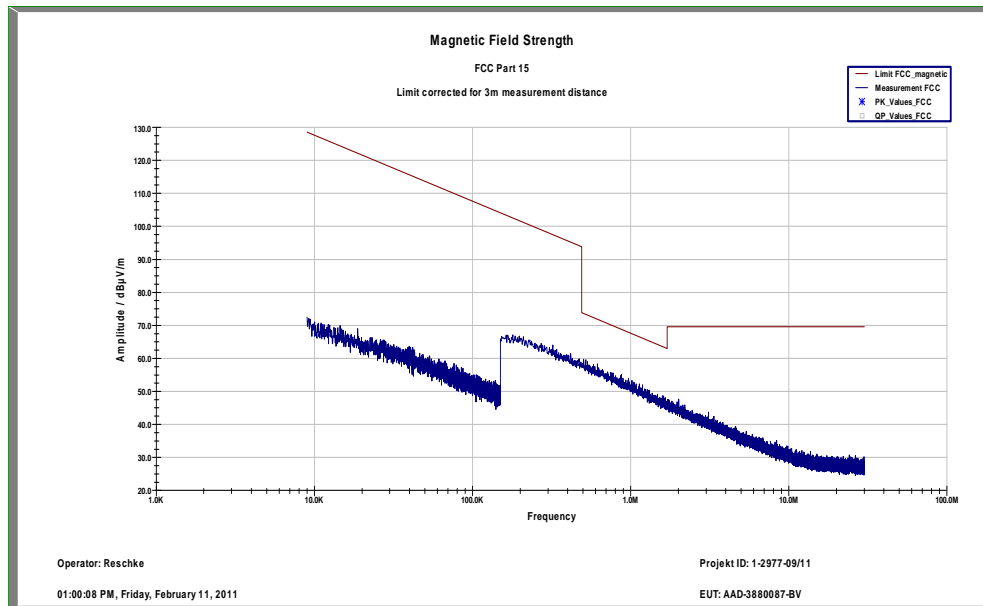

Plot 2: Receiver mode (30 MHz - 1 GHz)

Common Information

EUT: AAD-3880087-BV
 Serial Number: CB5A1CGKT0 (IMEI: 004402142159387)
 Test Description: FCC part 15 B class B @ 10 m
 Operating Conditions: GSM idle + GPS active + charging
 Operator Name: Hennemann
 Comment: AC: 115 V / 60 Hz

Scan Setup: STAN_Fin [EMI radiated]

Hardware Setup: Electric Field (NOS)
 Level Unit: dBµV/m

Subrange	Detectors	IF Bandwidth	Meas. Time	Receiver
30 MHz - 1,05 GHz	QuasiPeak	120 kHz	15 s	Receiver

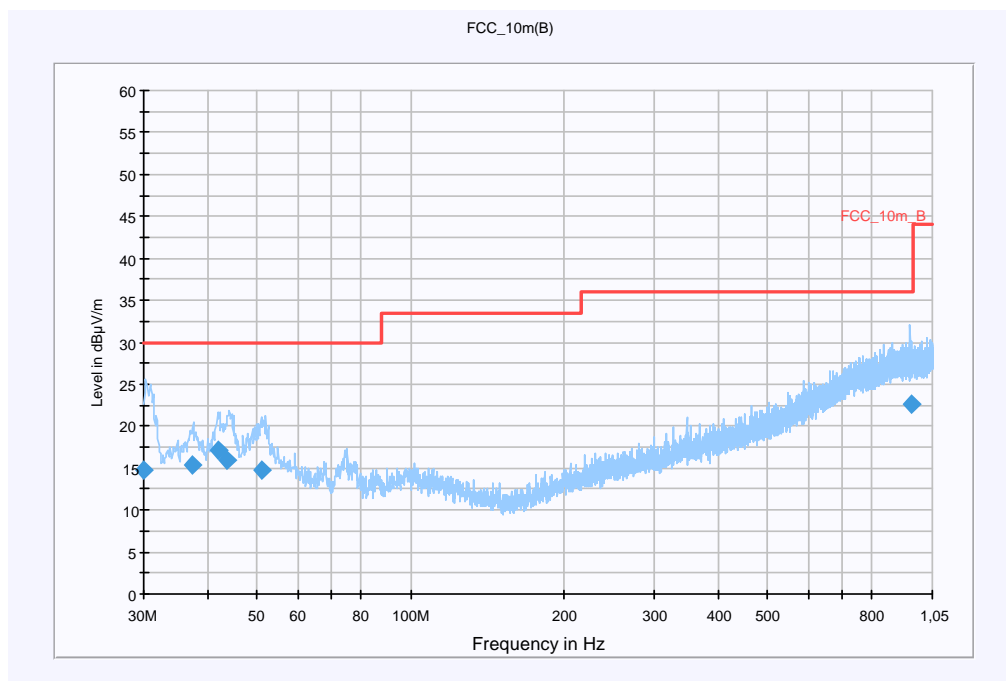

Final Result 1

Frequency (MHz)	QuasiPeak (dBµV/m)	Meas. Time (ms)	Bandwidth (kHz)	Antenna height (cm)	Polarity	Turntable position (deg)	Corr. (dB)	Margin (dB)	Limit (dBµV/m)	Comment
30.041681	14.8	15000.000	120.000	119.0	V	150.0	12.5	15.2	30.0	
37.338600	15.3	15000.000	120.000	134.0	V	236.0	13.2	14.7	30.0	
42.016500	17.1	15000.000	120.000	198.0	V	146.0	13.4	12.9	30.0	
43.779450	15.9	15000.000	120.000	198.0	V	293.0	13.3	14.1	30.0	
51.137100	14.8	15000.000	120.000	134.0	V	191.0	13.3	15.2	30.0	
952.561950	22.5	15000.000	120.000	284.0	V	272.0	25.4	13.5	36.0	

Plot 3: Receiver mode (1 GHz – 12.75 GHz)

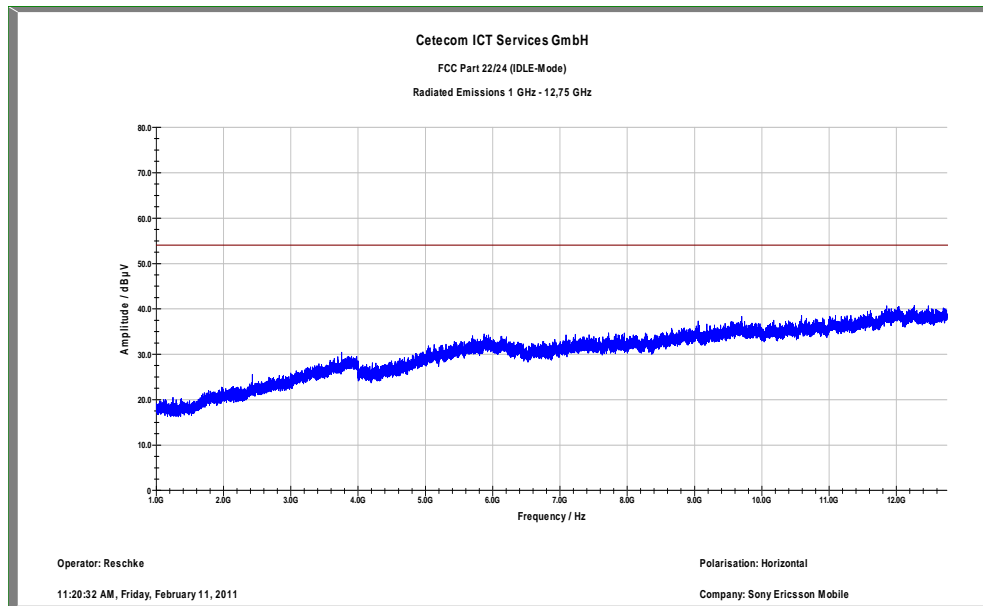

9 Test equipment and ancillaries used for tests

Typically, the calibrations of the test apparatus are commissioned to and performed by an accredited calibration laboratory. The calibration intervals are determined in accordance with the DIN EN ISO/IEC 17025. In addition to the external calibrations, the laboratory executes comparison measurements with other calibrated test systems or effective verifications. Weekly chamber inspections and range calibrations are performed. Where possible, rf-generating and signalling equipment as well as measuring receivers and analyzers are connected to an external high-precision 10 MHz reference (GPS-based or rubidium frequency standard).

In order to simplify the identification of the equipment used at some special tests, some items of test equipment and ancillaries can be provided with an identifier or number in the equipment list below (Labor/Item).

No.	Lab / Item	Equipment	Type	Manufact.	Serial No.	INV. No Cetecom	Kind of Calibration	Last Calibration	Next Calibration
1	n. a.	Isolating Transformer	RT5A	Grundig	8041	300001626	g		
2	n. a.	DC power supply, 60Vdc, 50A, 1200 W	6032A	HP Meßtechnik	2818A03450	300001040	Ve	08.01.2009	08.01.2012
3	n. a.	PowerAttenuator	8325	Byrd	1530	300001595	ev		
4	n. a.	Double-Ridged Waveguide Horn Antenna 1-18.0GHz	3115	EMCO	8812-3088	300001032	viKI!	05.03.2009	05.03.2011
5	n. a.	Active Loop Antenna	6502	EMCO	2210	300001015	ne		
6	n. a.	Anechoic chamber	FAC 3/5m	MWB / TDK	87400/02	300000996		23.03.2009	
7	Spec.A. 2_2e	System rack for EMI measurement solution	85900	HP I.V.	*	300000222	ne		
8	9	Artificial Mains 9 kHz to 30 MHz	ESH3-Z5	R&S	828576/020	300001210	Ve	06.01.2010	06.01.2012
9	n. a.	Relais Matrix	3488A	HP Meßtechnik	2719A15013	300001156	ne		
10	n. a.	Relais Matrix	PSU	R&S	890167/024	300001168	ne		
11	n. a.	Isolating Transformer	RT5A	Grundig	9242	300001263	ne		
12	n. a.	Three-Way Power Splitter, 50 Ohm	11850C	HP Meßtechnik		300000997	ne		
13	n. a.	Switch / Control Unit	3488A	HP	2605e08770	300001443	ne		
14	n. a.	Amplifier	js42-00502650-28-5a	Parzich GMBH	928979	300003143	ne		
15	n. a.	Band Reject filter	WRCG1855/1910-1835/1925-40/8SS	Wainwright	7	300003350	ev		
16	n. a.	Band Reject filter	WRCG2400/2483-2375/2505-50/10SS	Wainwright	11	300003351	ev		
17	n. a.	TILE-Software Emission	Quantum Change, Modell TILE-ICS/FULL	EMCO	none	300003451	ne		
18	n. a.	Highpass Filter	WHKX2.9/18G-12SS	Wainwright	1	300003492	ev		
19	n. a.	Highpass Filter	WHK1.1/15G-10SS	Wainwright	3	300003255	ev		
20	n. a.	Highpass Filter	WHKX7.0/18G-8SS	Wainwright	18	300003789	ne		
21	n. a.	PSA Spectrum Analyzer 3 Hz - 26.5 GHz	E4440A	Agilent Technologies	MY48250080	300003812	k	08.09.2010	08.09.2012
22	n. a.	MXG Microwave Analog Signal Generator	N5183A	Agilent Technologies	MY47420220	300003813	k	13.09.2010	13.09.2012
23	n. a.	RF Filter Section 9kHz - 1GHz	N9039A	Agilent Technologies	MY48260003	300003825	viKI!	08.09.2010	08.09.2012
24	n. a.	TRILOG Broadband Test-Antenna 30 MHz - 3 GHz	VULB9163	Schwarzbeck	371	300003854	viKI!	17.12.2008	17.12.2011
25	n. a.	Universal Communication	CMU200	R&S	103992	300003231	viKI!	30.06.2010	30.06.2012

		Tester							
26	19	Double-Ridged Waveguide Horn Antenna 1-18.0GHz	3115	EMCO	9107-3697	300001605	Ve	19.10.2010	19.10.2012
27	n. a.	DC power supply, 60Vdc, 50A, 1200 W	6032A	HP Meßtechnik	2920A04590	300001041	Ve	08.01.2009	08.01.2012
28	n. a.	Temperature Test Chamber	VT 4002	Heraeus Voetsch	521/83761	300002326	Ve	28.05.2009	28.05.2011
29	n. a.	Signal Analyzer 20Hz-26,5GHz-150 to + 30 DBM	FSIQ26	R&S	835111/0004	300002678	Ve	04.11.2010	04.11.2012
30	45	Switch-Unit	3488A	HP Meßtechnik	2719A14505	300000368	g		
31	n. a.	software	SPS_PHE 1.4f	Spitzberger & Spieß	B5981; 5D1081;B5979	300000210	ne		
32	n. a.	EMI Test Receiver	ESCI 1166.5950.03	R&S	100083	300003312	k	08.01.2010	08.01.2012
33	n. a.	Amplifier	JS42-00502650-28-5A	MITEQ	1084532	300003379	ev		
34	n. a.	Antenna Tower	Model 2175	ETS-LINDGREN	64762	300003745	izw		
35	n. a.	Positioning Controller	Model 2090	ETS-LINDGREN	64672	300003746	izw		
36	n. a.	Turntable Interface-Box	Model 105637	ETS-LINDGREN	44583	300003747	izw		
37	n. a.	TRILOG Broadband Test-Antenna 30 MHz - 3 GHz	VULB9163	Schwarzbeck	295	300003787	k	01.04.2010	01.04.2012
38	n. a.	Spectrum-Analyzer	FSU26	R&S	200809	300003874	k	08.01.2010	08.01.2012

Agenda: Kind of Calibration

- | | | | |
|------|--------------------------------------------|-----|------------------------------------------------------|
| k | calibration / calibrated | EK | limited calibration |
| ne | not required (k, ev, izw, zw not required) | zw | cyclical maintenance (external cyclical maintenance) |
| ev | periodic self verification | izw | internal cyclical maintenance |
| Ve | long-term stability recognized | g | blocked for accredited testing |
| vkl! | Attention: extended calibration interval | *) | next calibration ordered / currently in progress |
| NK! | Attention: not calibrated | | |

Annex A Document history

Version	Applied changes	Date of release
1.0	Initial release	2011-02-18

Annex B Further information**Glossary**

DUT	-	Device under Test
EMC	-	Electromagnetic Compatibility
EUT	-	Equipment under Test
FCC	-	Federal Communication Commission
FCC ID	-	Company Identifier at FCC
HW	-	Hardware
IC	-	Industry Canada
Inv. No.	-	Inventory number
N/A	-	not applicable
S/N	-	Serial Number
SW	-	Software