



## Accredited testing laboratory

DAR registration number: DAT-P-176/94-D1

**Test report no.** : 1-1065-14-05/09  
**Type identification** : AAD-3880008-BV  
**Test specification** : IEEE 1528-2003  
**FCC-ID** : PY7A3880008  
**IC-ID** : 4170B-A3880008

**Table of Contents**

1	General Information.....	3
1.1	Notes.....	3
1.1.1	Statement of Compliance.....	3
1.2	Testing laboratory.....	4
1.3	Details of applicant.....	4
1.4	Application details.....	4
1.5	Test item.....	5
1.6	Test specification(s).....	6
1.6.1	RF exposure limits.....	6
2	Technical test.....	7
2.1	Summary of test results.....	7
2.2	Test environment.....	7
2.3	Measurement and test set-up.....	7
2.4	Measurement system.....	8
2.4.1	System Description.....	8
2.4.2	Test environment.....	9
2.4.3	Probe description.....	9
2.4.4	Phantom description.....	10
2.4.5	Device holder description.....	10
2.4.6	Scanning procedure.....	11
2.4.7	Spatial Peak SAR Evaluation.....	12
2.4.8	Data Storage and Evaluation.....	13
2.4.9	Test equipment utilized.....	15
2.4.10	Tissue simulating liquids: dielectric properties.....	16
2.4.11	Tissue simulating liquids: parameters.....	17
2.4.12	Measurement uncertainty evaluation for SAR test.....	18
2.4.13	Measurement uncertainty evaluation for system validation.....	19
2.4.14	System validation.....	20
2.4.15	Validation procedure.....	21
2.5	Test Results.....	22
2.5.1	Conducted power measurements.....	22
2.5.2	Conducted power measurements GSM 850 MHz.....	22
2.5.3	Conducted power measurements GSM 1900 MHz.....	23
2.5.4	Justification of SAR measurements in GSM mode.....	23
2.5.5	Conducted power measurements WCDMA FDD V (850 MHz).....	24
2.5.6	Conducted power measurements WCDMA FDD II (1900 MHz).....	25
2.5.7	Test-set-up information for WCDMA / HSPDA / HSUPA.....	26
2.5.8	HSUPA test procedure :.....	29
2.5.9	Multiple Transmitter Information.....	30
2.6	Test results (Head and Body SAR).....	32
2.6.1	General description of test procedures.....	35
Annex 1	System performance verification.....	36
Annex 2	Measurement results (printout from DASY TM).....	42
Annex 2.1	PCS 850 MHz head.....	42
Annex 2.2	PCS 850 MHz body.....	54
Annex 2.3	PCS 1900 MHz head.....	61
Annex 2.4	PCS 1900 MHz body.....	73
Annex 2.5	UMTS (WCDMA) FDD II 1900 MHz head.....	80
Annex 2.6	UMTS (WCDMA) FDD II 1900 MHz body.....	92
Annex 2.7	UMTS (WCDMA) FDD V 850 MHz head.....	98
Annex 2.8	UMTS (WCDMA) FDD V 850 MHz body.....	110
Annex 2.9	Z-axis scans.....	116
Annex 3	Photo documentation.....	120
Annex 3.1	Liquid depth.....	131
Annex 4	RF Technical Brief Cover Sheet acc. to RSS-102.....	133
Annex 4.1	Declaration of RF Exposure Compliance.....	133
Annex 5	Calibration parameters.....	134

## 1 General Information

### 1.1 Notes

The test results of this test report relate exclusively to the test item specified in 1.5. The CETECOM ICT Services GmbH does not assume responsibility for any conclusions and generalisations drawn from the test results with regard to other specimens or samples of the type of the equipment represented by the test item. The test report may only be reproduced or published in full. Reproduction or publication of extracts from the report requires the prior written approval of the CETECOM ICT Services GmbH.

#### 1.1.1 Statement of Compliance

The SAR values found for the AAD-3880008-BV **Mobile Phone** are below the maximum recommended levels of 1.6 W/Kg as averaged over any 1 g tissue according to the FCC rule §2.1093, the ANSI/IEEE C 95.1:1999, the NCRP Report Number 86 for uncontrolled environment, according to the Health Canada's Safety Code 6 and the Industry Canada Radio Standards Specification RSS-102 for General Population/Uncontrolled exposure.

For body worn operation, this device has been tested and meets FCC RF exposure guidelines when used with any accessory that contains no metal and that positions the handset a minimum of 15 mm from the body. Use of other accessories may not ensure compliance with FCC RF exposure guidelines.

The measurement together with the test system set-up is described in chapter 2.3 of this test report. A detailed description of the equipment under test can be found in chapter 1.5.

### Test engineer:

2009-04-07

Oleksandr Hnatovskiy



Date

Name

Signature

### Technical responsibility for area of testing:

2009-04-07

Thomas Vogler



Date

Name

Signature

## 1.2 Testing laboratory

CETECOM ICT Services GmbH  
Untertuerkheimer Straße 6-10,  
66117 Saarbruecken  
Germany  
Telephone: + 49 681 598 - 0  
Fax: + 49 681 598 - 8475

e-mail: [info@ict.cetecom.de](mailto:info@ict.cetecom.de)  
Internet: <http://www.cetecom-ict.de>

State of accreditation: The Test laboratory (area of testing) is accredited according to DIN EN ISO/IEC 17025. DAR registration number: DAT-P-176/94-D1

Test location, if different from CETECOM ICT Services GmbH

Name: ---  
Street: ---  
Town: ---  
Country: ---  
Phone: ---  
Fax: ---

## 1.3 Details of applicant

Name: Sony Ericsson Mobile Communications AB  
Street: Mobilvägen 10  
Town: 22188 Lund  
Country: Sweden  
Contact: Mr. Peter Lindeborg  
Telephone: +46-10-802-43 68

## 1.4 Application details

Date of receipt of application: 2009-02-26  
Date of receipt of test item: 2009-03-20  
Start/Date of test: 2009-03-22  
End of test: 2009-04-03

Person(s) present during the test: ---

Test report no.: 1-1065-14-05/09

**1.5 Test item**

Description of the test item: Mobile Phone  
 Type identification: AAD-3880008-BV  
 FCC-ID : PY7A3880008  
 IC-ID : 4170B-A3880008  
 Serial number: T261F007CD

Manufacturer:  
 Name: Sony Ericsson Mobile Communications AB  
 Street: Mobilvägen 10  
 Town: 22188 Lund  
 Country: Sweden

additional information on the DUT:		
device type :	portable device	
IMEI No :	00440107-746195-8	
exposure category:	uncontrolled environment / general population	
test device production information	production unit	
device operating configurations :		
operating mode(s)	GSM, DCS, PCS, UMTS/WCDMA, Bluetooth	
modulation	GMSK, 8-PSK, QPSK(dl), 2*BPSK/HPSK(ul)	
GPRS mobile station class :	B	
GPRS multislot class :	10	voice mode : ---
EGPRS multislot class	10	voice mode : ---
maximum no. of timeslots in uplink:	2	
operating frequency range(s)	transmitter frequency range	receiver frequency range
PCS 1900 (tested):	1850.2 MHz ~ 1909.8 MHz	1930.2 MHz ~ 1989.8 MHz
PCS 850 (tested):	824.2 MHz ~ 848.8 MHz	869.2 MHz ~ 893.8 MHz
DCS 1800	1710 MHz ~ 1785 MHz	1805 MHz ~ 1880 MHz
GSM 900	880 MHz ~ 915 MHz	925 MHz ~ 960 MHz
FDD I	1922.4 MHz ~ 1977.6 MHz	2112.4 MHz ~ 2167.6 MHz
FDD II (tested)	1852.4 MHz ~ 1907.6 MHz	1932.4 MHz ~ 1987.6 MHz
FDD V (tested)	826.4 MHz ~ 846.6 MHz	871.4 MHz ~ 891.6 MHz
Power class :	1, tested with power level 0 (1900 MHz band) 4, tested with power level 5 ( 850 MHz band) 3; (FDD II band); (FDD V)	
measured peak output power (conducted):	850 MHz band: 32.4 dBm (GMSK); 27.9 dBm (8-PSK) 1900 MHz band: 30.7 dBm (GMSK); 26.1 dBm (8-PSK) FDD II band: 22.1 dBm; FDD V: 22.7 dBm (average max.)	
test channels (low-mid-high) :	128-190-251 (850 MHz band) 512-661-810 (1900 MHz band) 9262-9400-9538 (FDD II band) 4132-4182-4233 (FDD V band)	
hardware version :	AP2	
software version :	R1EA024	
antenna type :	Integrated antenna	
accessories/body-worn configurations:	Stereo headset	
battery options :	Sony Ericsson Standard Battery BST-33 / 3.6V / 950mAh	

**1.6 Test specification(s)**

**Supplement C (Edition 01-01) to OET Bulletin 65 (Edition 97-01)**

**IEEE 1528-2003 (April 21, 2003)**

**RSS-102: Radio Frequency Exposure Compliance of Radiocommunication Apparatus (All Frequency Bands (Issue 2 of November 2005))**

**Canada’s Safety Code 6: Limits of Human Exposure to Radiofrequency Electromagnetic Fields in the Frequency Range from 3 kHz to 300 GHz (99-EHD-237)**

**IEEE Std C95.3 – 1991, IEEE Recommended Practice for the Measurement of Potentially Hazardous Electromagnetic Fields – RF and Microwave.**

**IEEE Std C95.1 – 1999, IEEE Standard for Safety Levels with Respect to Human Exposure to Radio Frequency Electromagnetic Fields, 3 kHz – 300 GHz.**

**1.6.1 RF exposure limits**

<b>Human Exposure</b>	<b>Uncontrolled Environment General Population</b>	<b>Controlled Environment Occupational</b>
<b>Spatial Peak SAR*</b> (Brain)	<b>1.60 mW/g</b>	8.00 mW/g
<b>Spatial Average SAR**</b> (Whole Body)	0.08 mW/g	0.40 mW/g
<b>Spatial Peak SAR***</b> (Hands/Feet/Ankle/Wrist)	4.00 mW/g	20.00 mW/g

Table 1: RF exposure limits

The limit applied in this test report is shown in **bold** letters

**Notes:**

\* The Spatial Peak value of the SAR averaged over any 1 gram of tissue (defined as a tissue volume in the shape of a cube) and over the appropriate averaging time

\*\* The Spatial Average value of the SAR averaged over the whole body.

\*\*\* The Spatial Peak value of the SAR averaged over any 10 grams of tissue (defined as a tissue volume in the shape of a cube) and over the appropriate averaging time.

**Uncontrolled Environments** are defined as locations where there is the exposure of individuals who have no knowledge or control of their exposure.

**Controlled Environments** are defined as locations where there is exposure that may be incurred by persons who are aware of the potential for exposure, (i.e. as a result of employment or occupation).

## 2 Technical test

### 2.1 Summary of test results

No deviations from the technical specification(s) were ascertained in the course of the tests performed.	<input checked="" type="checkbox"/>
The deviations as specified in 2.5 were ascertained in the course of the tests performed.	<input type="checkbox"/>

### 2.2 Test environment

General Environment conditions in the test area are as follows:

Ambient temperature: 20°C – 24°C  
 Tissue simulating liquid: 20°C – 24°C  
 Humidity: 40% – 50%

Exact temperature values for each test are shown in the table(s) under 2.5. and/or on the measurement plots.

### 2.3 Measurement and test set-up

The measurement system is described in chapter 2.4.

The test setup for the system validation can be found in chapter 2.4.14.

A description of positioning and test signal control can be found in chapter 2.5 together with the test results.

## 2.4 Measurement system

### 2.4.1 System Description

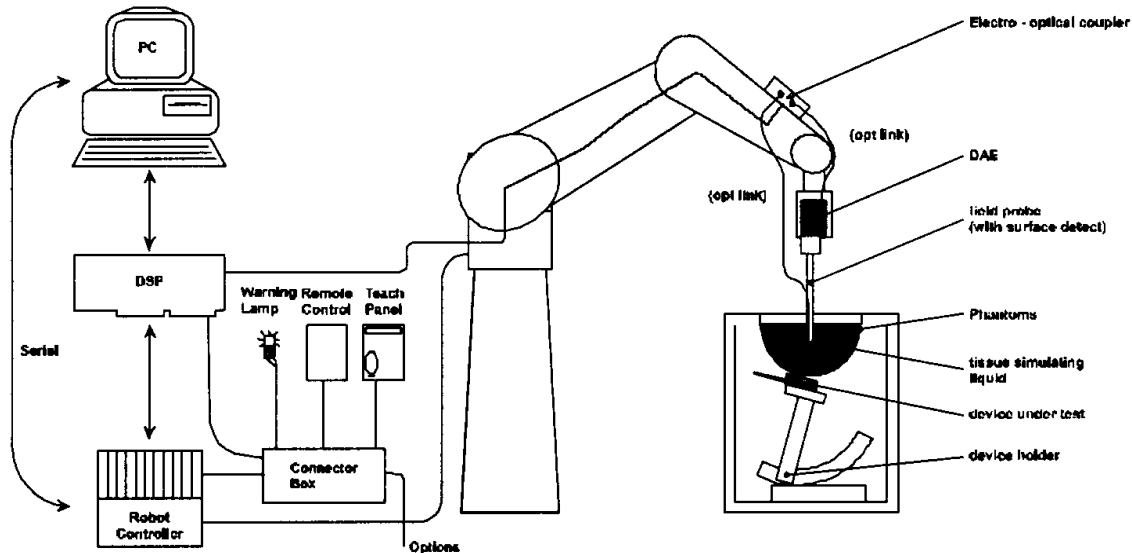

The DAS4 system for performing compliance tests consists of the following items:

- A standard high precision 6-axis robot (Stäubli RX family) with controller and software. An arm extension for accommodating the data acquisition electronics (DAE).
- A dosimetric probe, i.e. an isotropic E-field probe optimized and calibrated for usage in tissue simulating liquid. The probe is equipped with an optical surface detector system.
- A data acquisition electronic (DAE) which performs the signal amplification, signal multiplexing, AD-conversion, offset measurements, mechanical surface detection, collision detection, etc. The unit is battery powered with standard or rechargeable batteries. The signal is optically transmitted to the EOC.
- A unit to operate the optical surface detector which is connected to the EOC.
- The Electro-Optical Coupler (EOC) performs the conversion from the optical into a digital electric signal of the DAE. The EOC is connected to the DAS4 measurement server.
- The DAS4 measurement server, which performs all real-time data evaluation for field measurements and surface detection, controls robot movements and handles safety operation. A computer operating Windows 2000
- DAS4 software and SEMCAD data evaluation software.
- Remote control with teach panel and additional circuitry for robot safety such as warning lamps, etc.
- The generic twin phantom enabling the testing of left-hand and right-hand usage.
- The device holder for handheld mobile phones.
- Tissue simulating liquid mixed according to the given recipes.
- System validation dipoles allowing to validate the proper functioning of the system.



**2.4.2 Test environment**

The DASY4 measurement system is placed at the head end of a room with dimensions: 5 x 2.5 x 3 m<sup>3</sup>, the SAM phantom is placed in a distance of 75 cm from the side walls and 1.1m from the rear wall. Above the test system a 1.5 x 1.5 m<sup>2</sup> array of pyramid absorbers is installed to reduce reflections from the ceiling.

Picture 1 of the photo documentation shows a complete view of the test environment.

The system allows the measurement of SAR values larger than 0.005 mW/g.

**2.4.3 Probe description**

Isotropic E-Field Probe ET3DV6 for Dosimetric Measurements

<b>Technical data according to manufacturer information</b>	
Construction	Symmetrical design with triangular core Built-in optical fiber for surface detection system Built-in shielding against static charges PEEK enclosure material (resistant to organic solvents, e.g., glycoether)
Calibration	In air from 10 MHz to 2.5 GHz In head tissue simulating liquid (HSL) at 900 (800-1000) MHz and 1.8 GHz (1700-1910 MHz) (accuracy ± 9.5%; k=2) Calibration for other liquids and frequencies upon request
Frequency	10 MHz to 3 GHz (dosimetry); Linearity: ± 0.2 dB (30 MHz to 3 GHz)
Directivity	± 0.2 dB in HSL (rotation around probe axis) ± 0.4 dB in HSL (rotation normal to probe axis)
Dynamic range	5 µW/g to > 100 mW/g; Linearity: ± 0.2 dB
Optical Surface Detection	± 0.2 mm repeatability in air and clear liquids over diffuse reflecting surfaces (ET3DV6 only)
Dimensions	Overall length: 330 mm Tip length: 16 mm Body diameter: 12 mm Tip diameter: 6.8 mm Distance from probe tip to dipole centers: 2.7 mm
Application	General dosimetry up to 3 GHz Compliance tests of mobile phones Fast automatic scanning in arbitrary phantoms (ET3DV6)

**2.4.4 Phantom description**

The used SAM Phantom meets the requirements specified in Edition 01-01 of Supplement C to OET Bulletin 65 for Specific Absorption Rate (SAR) measurements.

The phantom consists of a fibreglass shell integrated in a wooden table. It allows left-hand and right-hand head as well as body-worn measurements with a maximum liquid depth of 18 cm in head position and 22 cm in planar position (body measurements). The thickness of the Phantom shell is 2 mm +/- 0.1 mm.

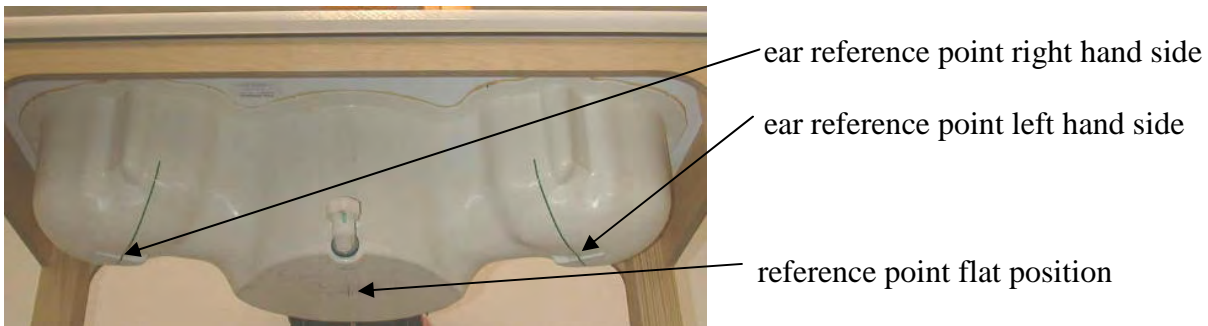

**2.4.5 Device holder description**

The DASY4 device holder has two scales for device rotation (with respect to the body axis) and the device inclination (with respect to the line between the ear openings). The plane between the ear openings and the mouth tip has a rotation angle of 65°. The bottom plate contains three pair of bolts for locking the device holder. The device holder positions are adjusted to the standard measurement positions in the three sections. This device holder is used for standard mobile phones or PDA's only. If necessary an additional support of polystyrene material is used.



Larger DUT's (e.g. notebooks) cannot be tested using this device holder. Instead a support of bigger polystyrene cubes and thin polystyrene plates is used to position the DUT in all relevant positions to find and measure spots with maximum SAR values.

Therefore those devices are normally only tested at the flat part of the SAM.

#### 2.4.6 Scanning procedure

The DASY4 installation includes predefined files with recommended procedures for measurements and validation. They are read-only document files and destined as fully defined but unmeasured masks. All test positions (head or body-worn) are tested with the same configuration of test steps differing only in the grid definition for the different test positions.

- The „reference“ and „drift“ measurements are located at the beginning and end of the batch process. They measure the field drift at one single point in the liquid over the complete procedure. The indicated drift is mainly the variation of the DUT's output power and should vary max. +/- 5 %.
- The „surface check“ measurement tests the optical surface detection system of the DASY4 system by repeatedly detecting the surface with the optical and mechanical surface detector and comparing the results. The output gives the detecting heights of both systems, the difference between the two systems and the standard deviation of the detection repeatability. Air bubbles or refraction in the liquid due to separation of the sugar-water mixture gives poor repeatability (above  $\pm 0.1\text{mm}$ ). To prevent wrong results tests are only executed when the liquid is free of air bubbles. The difference between the optical surface detection and the actual surface depends on the probe and is specified with each probe. (It does not depend on the surface reflectivity or the probe angle to the surface within  $\pm 30^\circ$ .)
- The „area scan“ measures the SAR above the DUT or verification dipole on a parallel plane to the surface. It is used to locate the approximate location of the peak SAR with 2D spline interpolation. The robot performs a stepped movement along one grid axis while the local electrical field strength is measured by the probe. The probe is touching the surface of the SAM during acquisition of measurement values. The standard scan uses large grid spacing for faster measurement. Standard grid spacing for head measurements is 15 mm in x- and y- dimension. If a finer resolution is needed, the grid spacing can be reduced. Grid spacing and orientation have no influence on the SAR result. For special applications where the standard scan method does not find the peak SAR within the grid, e.g. mobile phones with flip cover, the grid can be adapted in orientation. Results of this coarse scan are shown in annex 2.
- A „7x7x7 zoom scan“ measures the field in a volume around the 2D peak SAR value acquired in the previous „coarse“ scan. This is a fine 7x7 grid where the robot additionally moves the probe in 7 steps along the z-axis away from the bottom of the Phantom. Grid spacing for the cube measurement is 5 mm in x and y-direction and 5 mm in z-direction. DASY4 is also able to perform repeated zoom scans if more than 1 peak is found during area scan. In this document, the evaluated peak 1g and 10g averaged SAR values are shown in the 2D-graphics in annex 2. Test results relevant for the specified standard (see chapter 1.6.) are shown in table form in chapter 2.5.
- A Z-axis scan measures the total SAR value at the x-and y-position of the maximum SAR value found during the cube 7x7x7 scan. The probe is moved away in z-direction from the bottom of the SAM phantom in 2mm steps. This measurement shows the continuity of the liquid and can - depending in the field strength – also show the liquid depth. A z-axis scan of the measurement with maximum SAR value is shown in annex 2.

### 2.4.7 Spatial Peak SAR Evaluation

The spatial peak SAR - value for 1 and 10 g is evaluated after the Cube measurements have been done. The basis of the evaluation are the SAR values measured at the points of the fine cube grid consisting of 7 x 7 x 7 points. The algorithm that finds the maximal averaged volume is separated into three different stages.

- The data between the dipole center of the probe and the surface of the phantom are extrapolated. This data cannot be measured since the center of the dipole is 2.7 mm away from the tip of the probe and the distance between the surface and the lowest measuring point is about 1 mm (see probe calibration sheet). The extrapolated data from a cube measurement can be visualized by selecting 'Graph Evaluated'.
- The maximum interpolated value is searched with a straight-forward algorithm. Around this maximum the SAR - values averaged over the spatial volumes (1g or 10 g) are computed using the 3d-spline interpolation algorithm. If the volume cannot be evaluated (i.e., if a part of the grid was cut off by the boundary of the measurement area) the evaluation will be started on the corners of the bottom plane of the cube.
- All neighboring volumes are evaluated until no neighboring volume with a higher average value is found.

#### Extrapolation

The extrapolation is based on a least square algorithm [W. Gander, Computermathematik, p.168-180]. Through the points in the first 3 cm along the z-axis, polynomials of order four are calculated. These polynomials are then used to evaluate the points between the surface and the probe tip. The points, calculated from the surface, have a distance of 1 mm from each other.

#### Interpolation

The interpolation of the points is done with a 3d-Spline. The 3d-Spline is composed of three one-dimensional splines with the "Not a knot"-condition [W. Gander, Computermathematik, p.141-150] (x, y and z -direction) [Numerical Recipes in C, Second Edition, p.123ff ].

#### Volume Averaging

At First the size of the cube is calculated. Then the volume is integrated with the trapezoidal algorithm. 8000 points (20x20x20) are interpolated to calculate the average.

#### Advanced Extrapolation

DASY4 uses the advanced extrapolation option which is able to compensate boundary effects on E-field probes.

**2.4.8 Data Storage and Evaluation**

Data Storage

The DASY4 software stores the acquired data from the data acquisition electronics as raw data (in microvolt readings from the probe sensors), together with all necessary software parameters for the data evaluation (probe calibration data, liquid parameters and device frequency and modulation data) in measurement files with the extension ".DA4". The software evaluates the desired unit and format for output each time the data is visualized or exported. This allows verification of the complete software setup even after the measurement and allows correction of incorrect parameter settings. For example, if a measurement has been performed with a wrong crest factor parameter in the device setup, the parameter can be corrected afterwards and the data can be re-evaluated.

The measured data can be visualized or exported in different units or formats, depending on the selected probe type ([V/m], [A/m], [°C], [mW/g], [mW/cm<sup>2</sup>], [dBrel], etc.). Some of these units are not available in certain situations or show meaningless results, e.g., a SAR output in a lossless media will always be zero. Raw data can also be exported to perform the evaluation with other software packages.

Data Evaluation by SEMCAD

The SEMCAD software automatically executes the following procedures to calculate the field units from the microvolt readings at the probe connector. The parameters used in the evaluation are stored in the configuration modules of the software:

Probe parameters:	- Sensitivity	Norm <sub>i</sub> , a <sub>i0</sub> , a <sub>i1</sub> , a <sub>i2</sub>
	- Conversion factor	ConvF <sub>i</sub>
	- Diode compression point	Dcpi
Device parameters:	- Frequency	f
	- Crest factor	cf
Media parameters:	- Conductivity	σ
	- Density	ρ

These parameters must be set correctly in the software. They can be found in the component documents or they can be imported into the software from the configuration files issued for the DASY4 components. In the direct measuring mode of the multimeter option, the parameters of the actual system setup are used. In the scan visualization and export modes, the parameters stored in the corresponding document files are used.

The first step of the evaluation is a linearization of the filtered input signal to account for the compression characteristics of the detector diode. The compensation depends on the input signal, the diode type and the DC-transmission factor from the diode to the evaluation electronics.

If the exciting field is pulsed, the crest factor of the signal must be known to correctly compensate for peak power. The formula for each channel can be given as:

$$V_i = U_i + U_i^2 \cdot cf/dcp_i$$

with  $V_i$  = compensated signal of channel i (i = x, y, z)  
 $U_i$  = input signal of channel i (i = x, y, z)  
 cf = crest factor of exciting field (DASY parameter)  
 $dcp_i$  = diode compression point (DASY parameter)

From the compensated input signals the primary field data for each channel can be evaluated:

E-field probes:  $E_i = (V_i / Norm_i \cdot ConvF)^{1/2}$

H-field probes:  $H_i = (V_i)^{1/2} \cdot (a_{i0} + a_{i1}f + a_{i2}f^2)/f$

with  $V_i$  = compensated signal of channel i (i = x, y, z)  
 $Norm_i$  = sensor sensitivity of channel i (i = x, y, z)  
 [mV/(V/m)<sup>2</sup>] for E-field Probes  
 $ConvF$  = sensitivity enhancement in solution  
 $a_{ij}$  = sensor sensitivity factors for H-field probes  
 f = carrier frequency [GHz]  
 $E_i$  = electric field strength of channel i in V/m  
 $H_i$  = magnetic field strength of channel i in A/m

The RSS value of the field components gives the total field strength (Hermitian magnitude):

$$E_{tot} = (E_x^2 + E_y^2 + E_z^2)^{1/2}$$

The primary field data are used to calculate the derived field units.

$$SAR = (E_{tot}^2 \cdot \sigma) / (\rho \cdot 1000)$$

with SAR = local specific absorption rate in mW/g  
 $E_{tot}$  = total field strength in V/m  
 $\sigma$  = conductivity in [mho/m] or [Siemens/m]  
 $\rho$  = equivalent tissue density in g/cm<sup>3</sup>

Note that the density is normally set to 1 (or 1.06), to account for actual brain density rather than the density of the simulation liquid. The power flow density is calculated assuming the excitation field to be a free space field.

$$P_{pwe} = E_{tot}^2 / 3770 \quad \text{or} \quad P_{pwe} = H_{tot}^2 \cdot 37.7$$

with  $P_{pwe}$  = equivalent power density of a plane wave in mW/cm<sup>2</sup>  
 $E_{tot}$  = total electric field strength in V/m  
 $H_{tot}$  = total magnetic field strength in A/m

**2.4.9 Test equipment utilized**

This table gives a complete overview of the SAR measurement equipment

Devices used during the test described in chapter 2.5. are marked ☒

	Manufacturer	Device	Type	Serial number	Date of last calibration )*
☒	Schmid & Partner Engineering AG	Dosimetric E-Field Probe	ET3DV6	1558	August 15, 2008
☐	Schmid & Partner Engineering AG	Dosimetric E-Field Probe	ET3DV6	1559	January 14, 2009
☒	Schmid & Partner Engineering AG	900 MHz System Validation Dipole	D900V2	102	August 18, 2008
☐	Schmid & Partner Engineering AG	1800 MHz System Validation Dipole	D1800V2	287	August 19, 2008
☒	Schmid & Partner Engineering AG	1900 MHz System Validation Dipole	D1900V2	531	May 14, 2008
☐	Schmid & Partner Engineering AG	2450 MHz System Validation Dipole	D2450V2	710	August 20, 2008
☒	Schmid & Partner Engineering AG	Data acquisition electronics	DAE3V1	413	January 8, 2009
☐	Schmid & Partner Engineering AG	Data acquisition electronics	DAE3V1	477	May 14, 2008
☒	Schmid & Partner Engineering AG	Software	DASY 4 V4.5	---	N/A
☒	Schmid & Partner Engineering AG	Phantom	SAM	---	N/A
☒	Rohde & Schwarz	Universal Radio Communication Tester	CMU 200	106826	January 15, 2009
☒	Hewlett Packard)*	Network Analyser 300 kHz to 6 GHz	8753C	2937U00269	January 9, 2009
☒	Hewlett Packard)*	Network Analyser 300 kHz to 6 GHz	85047A	2936A00872	January 9, 2009
☒	Hewlett Packard	Dielectric Probe Kit	85070C	US99360146	N/A
☒	Hewlett Packard	Signal Generator	8665A	2833A00112	January 8, 2009
☒	Amplifier Reasearch	Amplifier	25S1G4 (25 Watt)	20452	N/A
☒	Rohde & Schwarz	Power Meter	NRP	101367	January 9, 2009
☒	Rohde & Schwarz	Power Meter Sensor	NRP Z22	100227	January 9, 2009
☒	Rohde & Schwarz	Power Meter Sensor	NRP Z22	100234	January 9, 2009

)\* : Network analyzer probe calibration against air, distilled water and a shorting block performed before measuring liquid parameters.

**2.4.10 Tissue simulating liquids: dielectric properties**

The following materials are used for producing the tissue-equivalent materials.

(liquids used for tests described in chapter 2.5. are marked with ☒) :

Ingredients (% of weight)	Frequency (MHz)					
	<input type="checkbox"/> 450	<input checked="" type="checkbox"/> 835	<input type="checkbox"/> 900	<input type="checkbox"/> 1800	<input checked="" type="checkbox"/> 1900	<input type="checkbox"/> 2450
frequency band	<input type="checkbox"/> 450	<input checked="" type="checkbox"/> 835	<input type="checkbox"/> 900	<input type="checkbox"/> 1800	<input checked="" type="checkbox"/> 1900	<input type="checkbox"/> 2450
Tissue Type	Head	Head	Head	Head	Head	Head
Water	38.56	41.45	40.92	52.64	54.9	62.7
Salt (NaCl)	3.95	1.45	1.48	0.36	0.18	0.5
Sugar	56.32	56.0	56.5	0.0	0.0	0.0
HEC	0.98	1.0	1.0	0.0	0.0	0.0
Bactericide	0.19	0.1	0.1	0.0	0.0	0.0
Triton X-100	0.0	0.0	0.0	0.0	0.0	36.8
DGBE	0.0	0.0	0.0	47.0	44.92	0.0

Table 2: Head tissue dielectric properties

Ingredients (% of weight)	Frequency (MHz)					
	<input type="checkbox"/> 450	<input checked="" type="checkbox"/> 835	<input type="checkbox"/> 900	<input type="checkbox"/> 1800	<input checked="" type="checkbox"/> 1900	<input type="checkbox"/> 2450
frequency band	<input type="checkbox"/> 450	<input checked="" type="checkbox"/> 835	<input type="checkbox"/> 900	<input type="checkbox"/> 1800	<input checked="" type="checkbox"/> 1900	<input type="checkbox"/> 2450
Tissue Type	Body	Body	Body	Body	Body	Body
Water	51.16	52.4	56.0	69.91	69.91	73.2
Salt (NaCl)	1.49	1.40	0.76	0.13	0.13	0.04
Sugar	46.78	45.0	41.76	0.0	0.0	0.0
HEC	0.52	1.0	1.21	0.0	0.0	0.0
Bactericide	0.05	0.1	0.27	0.0	0.0	0.0
Triton X-100	0.0	0.0	0.0	0.0	0.0	0.0
DGBE	0.0	0.0	0.0	29.96	29.96	26.7

Table 3: Body tissue dielectric properties

Salt: 99+% Pure Sodium Chloride

Sugar: 98+% Pure Sucrose

Water: De-ionized, 16MΩ+ resistivity

HEC: Hydroxyethyl Cellulose

DGBE: 99+% Di(ethylene glycol) butyl ether, [2-(2-butoxyethoxy)ethanol]

Triton X-100(ultra pure): Polyethylene glycol mono [4-(1,1,3,3-tetramethylbutyl)phenyl]ether

Note : Due to their availability body tissue simulating liquids as defined by FCC OET

Bulletin 65 Supplement C are generally used for body worn SAR testing according to European standards.



**2.4.11 Tissue simulating liquids: parameters**

Used Target Frequency [MHz]	Target Head Tissue		Measured Head Tissue		Measured Date
	Permittivity	Conductivity [S/m]	Permittivity	Conductivity [S/m]	
835	41.5	0.90	42.3	0.93	2009-03-22
900	41.5	0.97	41.4	1.00	2009-03-22
835	41.5	0.90	42.3	0.93	2009-04-03
900	41.5	0.97	41.4	1.00	2009-04-03
1900	40.0	1.40	40.4	1.39	2009-03-23

Table 4: Parameter of the head tissue simulating liquid

Used Target Frequency [MHz]	Target Body Tissue		Measured Body Tissue		Measured Date
	Permittivity	Conductivity [S/m]	Permittivity	Conductivity [S/m]	
835	55.2	0.97	54.3	0.99	2009-04-02
900	55.0	1.05	53.6	1.06	2009-04-02
1900	53.3	1.52	53.1	1.48	2009-03-25

Table 5: Parameter of the body tissue simulating liquid

Note: The dielectric properties have been measured using the contact probe method at 22°C.

**2.4.12 Measurement uncertainty evaluation for SAR test**

The overall combined measurement uncertainty of the measurement system is  $\pm 10,3\%$  ( $K=1$ ).

The expanded uncertainty ( $k=2$ ) is assessed to be  $\pm 20.6\%$

This measurement uncertainty budget is suggested by IEEE P1528 and determined by Schmid & Partner Engineering AG. The breakdown of the individual uncertainties is as follows:

Error Sources	Uncertainty Value	Probability Distribution	Divisor	$c_i$ 1g	$c_i$ 10g	Standard Uncertainty 1g	Standard Uncertainty 10g	$v_i^2$ or $v_{eff}$
<b>Measurement System</b>								
Probe calibration	$\pm 4.8\%$	Normal	1	1	1	$\pm 4.8\%$	$\pm 4.8\%$	$\infty$
Axial isotropy	$\pm 4.7\%$	Rectangular	$\sqrt{3}$	0.7	0.7	$\pm 1.9\%$	$\pm 1.9\%$	$\infty$
Hemispherical isotropy	$\pm 9.6\%$	Rectangular	$\sqrt{3}$	0.7	0.7	$\pm 3.9\%$	$\pm 3.9\%$	$\infty$
Spatial resolution	$\pm 0.0\%$	Rectangular	$\sqrt{3}$	1	1	$\pm 0.0\%$	$\pm 0.0\%$	$\infty$
Boundary effects	$\pm 1.0\%$	Rectangular	$\sqrt{3}$	1	1	$\pm 0.6\%$	$\pm 0.6\%$	$\infty$
Probe linearity	$\pm 4.7\%$	Rectangular	$\sqrt{3}$	1	1	$\pm 2.7\%$	$\pm 2.7\%$	$\infty$
System detection limits	$\pm 1.0\%$	Rectangular	$\sqrt{3}$	1	1	$\pm 0.6\%$	$\pm 0.6\%$	$\infty$
Readout electronics	$\pm 1.0\%$	Normal	1	1	1	$\pm 1.0\%$	$\pm 1.0\%$	$\infty$
Response time	$\pm 0.8\%$	Rectangular	$\sqrt{3}$	1	1	$\pm 0.5\%$	$\pm 0.5\%$	$\infty$
Integration time	$\pm 2.6\%$	Rectangular	$\sqrt{3}$	1	1	$\pm 1.5\%$	$\pm 1.5\%$	$\infty$
RF ambient conditions	$\pm 3.0\%$	Rectangular	$\sqrt{3}$	1	1	$\pm 1.7\%$	$\pm 1.7\%$	$\infty$
Probe positioner	$\pm 0.4\%$	Rectangular	$\sqrt{3}$	1	1	$\pm 0.2\%$	$\pm 0.2\%$	$\infty$
Probe positioning	$\pm 2.9\%$	Rectangular	$\sqrt{3}$	1	1	$\pm 1.7\%$	$\pm 1.7\%$	$\infty$
Max. SAR evaluation	$\pm 1.0\%$	Rectangular	$\sqrt{3}$	1	1	$\pm 0.6\%$	$\pm 0.6\%$	$\infty$
<b>Test Sample Related</b>								
Device positioning	$\pm 2.9\%$	Normal	1	1	1	$\pm 2.9\%$	$\pm 2.9\%$	145
Device holder uncertainty	$\pm 3.6\%$	Normal	1	1	1	$\pm 3.6\%$	$\pm 3.6\%$	5
Power drift	$\pm 5.0\%$	Rectangular	$\sqrt{3}$	1	1	$\pm 2.9\%$	$\pm 2.9\%$	$\infty$
<b>Phantom and Set-up</b>								
Phantom uncertainty	$\pm 4.0\%$	Rectangular	$\sqrt{3}$	1	1	$\pm 2.3\%$	$\pm 2.3\%$	$\infty$
Liquid conductivity (target)	$\pm 5.0\%$	Rectangular	$\sqrt{3}$	0.64	0.43	$\pm 1.8\%$	$\pm 1.2\%$	$\infty$
Liquid conductivity (meas.)	$\pm 2.5\%$	Normal	1	0.64	0.43	$\pm 1.6\%$	$\pm 1.1\%$	$\infty$
Liquid permittivity (target)	$\pm 5.0\%$	Rectangular	$\sqrt{3}$	0.6	0.49	$\pm 1.7\%$	$\pm 1.4\%$	$\infty$
Liquid permittivity (meas.)	$\pm 2.5\%$	Normal	1	0.6	0.49	$\pm 1.5\%$	$\pm 1.2\%$	$\infty$
<b>Combined Uncertainty</b>						$\pm 10.3\%$	$\pm 10.0\%$	330
<b>Expanded Std. Uncertainty</b>						$\pm 20.6\%$	$\pm 20.1\%$	

Table 6: Measurement uncertainties

**2.4.13 Measurement uncertainty evaluation for system validation**

The overall combined measurement uncertainty of the measurement system is  $\pm 8.4\%$  ( $K=1$ ).

The expanded uncertainty ( $k=2$ ) is assessed to be  $\pm 16.8\%$

This measurement uncertainty budget is suggested by IEEE P1528 and determined by Schmid & Partner Engineering AG. The breakdown of the individual uncertainties is as follows:

Error Sources	Uncertainty Value	Probability Distribution	Divisor	$c_i$ 1g	$c_i$ 10g	Standard Uncertainty 1g	Standard Uncertainty 10g	$v_i^2$ or $v_{eff}$
<b>Measurement System</b>								
Probe calibration	$\pm 4.8\%$	Normal	1	1	1	$\pm 4.8\%$	$\pm 4.8\%$	$\infty$
Axial isotropy	$\pm 4.7\%$	Rectangular	$\sqrt{3}$	0.7	0.7	$\pm 1.9\%$	$\pm 1.9\%$	$\infty$
Hemispherical isotropy	$\pm 0.0\%$	Rectangular	$\sqrt{3}$	0.7	0.7	$\pm 0.0\%$	$\pm 3.9\%$	$\infty$
Boundary effects	$\pm 1.0\%$	Rectangular	$\sqrt{3}$	1	1	$\pm 0.6\%$	$\pm 0.6\%$	$\infty$
Probe linearity	$\pm 4.7\%$	Rectangular	$\sqrt{3}$	1	1	$\pm 2.7\%$	$\pm 2.7\%$	$\infty$
System detection limits	$\pm 1.0\%$	Rectangular	$\sqrt{3}$	1	1	$\pm 0.6\%$	$\pm 0.6\%$	$\infty$
Readout electronics	$\pm 1.0\%$	Normal	1	1	1	$\pm 1.0\%$	$\pm 1.0\%$	$\infty$
Response time	$\pm 0.0\%$	Rectangular	$\sqrt{3}$	1	1	$\pm 0.0\%$	$\pm 0.0\%$	$\infty$
Integration time	$\pm 0.0\%$	Rectangular	$\sqrt{3}$	1	1	$\pm 0.0\%$	$\pm 0.0\%$	$\infty$
RF ambient conditions	$\pm 3.0\%$	Rectangular	$\sqrt{3}$	1	1	$\pm 1.7\%$	$\pm 1.7\%$	$\infty$
Probe positioner	$\pm 0.4\%$	Rectangular	$\sqrt{3}$	1	1	$\pm 0.2\%$	$\pm 0.2\%$	$\infty$
Probe positioning	$\pm 2.9\%$	Rectangular	$\sqrt{3}$	1	1	$\pm 1.7\%$	$\pm 1.7\%$	$\infty$
Max. SAR evaluation	$\pm 1.0\%$	Rectangular	$\sqrt{3}$	1	1	$\pm 0.6\%$	$\pm 0.6\%$	$\infty$
<b>Test Sample Related</b>								
Dipole axis to liquid distance	$\pm 2.0\%$	Normal	1	1	1	$\pm 1.2\%$	$\pm 1.2\%$	$\infty$
Power drift	$\pm 4.7\%$	Rectangular	$\sqrt{3}$	1	1	$\pm 2.7\%$	$\pm 2.7\%$	$\infty$
<b>Phantom and Set-up</b>								
Phantom uncertainty	$\pm 4.0\%$	Rectangular	$\sqrt{3}$	1	1	$\pm 2.3\%$	$\pm 2.3\%$	$\infty$
Liquid conductivity (target)	$\pm 5.0\%$	Rectangular	$\sqrt{3}$	0.64	0.43	$\pm 1.8\%$	$\pm 1.2\%$	$\infty$
Liquid conductivity (meas.)	$\pm 2.5\%$	Normal	1	0.64	0.43	$\pm 1.6\%$	$\pm 1.1\%$	$\infty$
Liquid permittivity (target)	$\pm 5.0\%$	Rectangular	$\sqrt{3}$	0.6	0.49	$\pm 1.7\%$	$\pm 1.4\%$	$\infty$
Liquid permittivity (meas.)	$\pm 2.5\%$	Normal	1	0.6	0.49	$\pm 1.5\%$	$\pm 1.2\%$	$\infty$
<b>Combined Uncertainty</b>						<b><math>\pm 8.4\%</math></b>	<b><math>\pm 8.1\%</math></b>	
<b>Expanded Std. Uncertainty</b>						<b><math>\pm 16.8\%</math></b>	<b><math>\pm 16.2\%</math></b>	

Table 7: Measurement uncertainties

**2.4.14 System validation**

The system validation is performed for verifying the accuracy of the complete measurement system and performance of the software. The system validation is performed with tissue equivalent material according to IEEE P1528 (described above). The following table shows validation results for all frequency bands and tissue liquids used during the tests of the test item described in chapter 1.5. (graphic plot(s) see annex 1).

Validation Kit	Frequency	Target Peak SAR (1000 mW) (+/- 10%)	Target SAR <sub>1g</sub> (1000 mW) (+/- 10%)	Measured Peak SAR (1000 mW)	Measured SAR <sub>1g</sub> (1000 mW)	Measured date
D900V2 S/N: 102	900 MHz head	15.4 mW/g	10.5 mW/g	16.2 mW/g	10.7 mW/g	2009-03-22
D900V2 S/N: 102	900 MHz head	15.4 mW/g	10.5 mW/g	16.8 mW/g	11.3 mW/g	2009-04-03
D900V2 S/N: 102	900 MHz body	16.4 mW/g	10.8 mW/g	16.3 mW/g	11.2 mW/g	2009-04-02
D1900V2 S/N: 531	1900 MHz head	71.6 mW/g	37.6 mW/g	72.8 mW/g	39.0 mW/g	2009-03-23
D1900V2 S/N: 531	1900 MHz head	71.6 mW/g	37.6 mW/g	72.8 mW/g	39.1 mW/g	2009-03-24
D1900V2 S/N: 531	1900 MHz body	69.6 mW/g	38.3 mW/g	75.1 mW/g	40.4 mW/g	2009-03-25

Table 8: Results system validation

Note : 900 MHz probe/dipole calibration is valid +/-100 MHz and fully covers the 850 MHz band.

### 2.4.15 Validation procedure

The validation is performed by using a validation dipole which is positioned parallel to the planar part of the SAM phantom at the reference point. The distance of the dipole to the SAM phantom is determined by a plexiglass spacer. The dipole is connected to the signal source consisting of signal generator and amplifier via a directional coupler, N-connector cable and adaption to SMA. It is fed with a power of 1000 mW. To adjust this power a power meter is used. The power sensor is connected to the cable before the validation to measure the power at this point and do adjustments at the signal generator. At the outputs of the directional coupler both return loss as well as forward power are controlled during the validation to make sure that emitted power at the dipole is kept constant. This can also be checked by the power drift measurement after the test (result on plot).

Validation results have to be equal or near the values determined during dipole calibration (target SAR in table above) with the relevant liquids and test system.

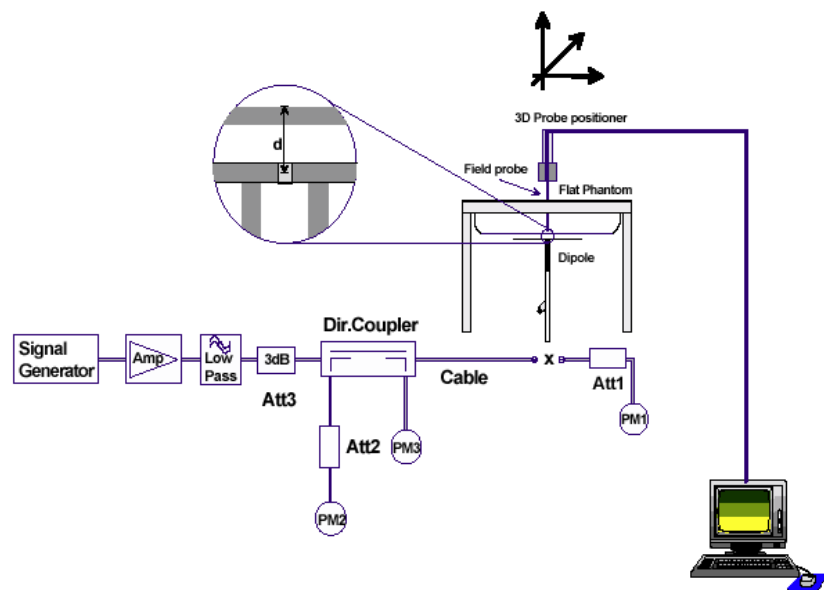

**2.5 Test Results**

**2.5.1 Conducted power measurements**

For the measurements a Rohde & Schwarz Radio Communication Tester CMU 200 was used. The output power was measured using an integrated RF connector and attached RF cable. The conducted output power was also checked before and after each SAR measurement. The resulting power values were within a 0.2 dB tolerance of the values shown below.

Note : CMU200 measures GSM peak and average output power for active timeslots.  
For SAR the timebased average power is relevant. The difference inbetween depends on the duty cycle of the TDMA signal :

No. of timeslots	1	2	3	4
Duty Cycle	1 : 8	1: 4	1 : 2.66	1 : 2
timebased avg. power compared to slotted avg. power	- 9 dB	- 6 dB	- 4.25 dB	- 3 dB

The signalling modes differ as follows :

mode	coding scheme	modulation
GPRS	CS1 to CS4	GMSK
EGPRS (EDGE)	MCS1 to MCS4	GMSK
EGPRS (EDGE)	MCS5 to MCS9	8PSK

Apart from modulation change (GMSK/8PSK) coding schemes differ in code rate without influence on the RF signal. Therefore one coding scheme per mode was selected for conducted power measurements.

**2.5.2 Conducted power measurements GSM 850 MHz**

Channel / frequency	modulation	timeslots	slotted avg. power	timebased avg. power (calculated)
128 / 824.2 MHz	GMSK	1	32.4dBm	23.4dBm
190 / 836.6 MHz	GMSK	1	32.1dBm	23.1dBm
251 / 848.0 MHz	GMSK	1	32.0dBm	23.0dBm
128 / 824.2 MHz	GMSK	2	30.4dBm	<b>24.4dBm</b>
190 / 836.6 MHz	GMSK	2	30.3dBm	<b>24.3dBm</b>
251 / 848.0 MHz	GMSK	2	30.3dBm	<b>24.3dBm</b>
128 / 824.2 MHz	8PSK	2	27.9dBm	21.9dBm
190 / 836.6 MHz	8PSK	2	27.6dBm	21.6dBm
251 / 848.0 MHz	8PSK	2	27.9dBm	21.9dBm

Table 9: Test results conducted power measurement GSM 850 MHz

**2.5.3 Conducted power measurements GSM 1900 MHz**

Channel / frequency	modulation	timeslots	slotted avg. power	timebased avg. power (calculated)
512 / 1850.2 MHz	GMSK	1	30.7dBm	21.7dBm
661 / 1880.0 MHz	GMSK	1	30.5dBm	21.5dBm
810 / 1909.8 MHz	GMSK	1	30.7dBm	21.7dBm
512 / 1850.2 MHz	GMSK	2	28.8dBm	<b>22.8dBm</b>
661 / 1880.0 MHz	GMSK	2	28.7dBm	<b>22.7dBm</b>
810 / 1909.8 MHz	GMSK	2	28.7dBm	<b>22.7dBm</b>
512 / 1850.2 MHz	8PSK	2	26.1dBm	20.1dBm
661 / 1880.0 MHz	8PSK	2	26.2dBm	20.2dBm
810 / 1909.8 MHz	8PSK	2	26.2dBm	20.2dBm

Table 10: Test results conducted power measurement GSM 1900 MHz

**2.5.4 Justification of SAR measurements in GSM mode**

SAR measurements were performed in GPRS mode with 2 active timeslots because highest timebased averaged output power was calculated for that configuration.

For comparison an additional delta measurement was performed with 1 timeslot in speech mode. In EDGE mode no delta measurement was performed.

**2.5.5 Conducted power measurements WCDMA FDD V (850 MHz)**

<b>Max. RMS output power 850 MHz (FDD V) / dBm</b>			
mode	Channel / frequency		
	4132 / 826.4 MHz	4182 / 836.6 MHz	4233 / 846.6 MHz
<b>RMC 12.2 kbit/s</b>	<b>22.43</b>	<b>22.44</b>	<b>22.55</b>
RMC 64 kbit/s	22.45	22.48	22.61
RMC 144 kbit/s	22.45	22.50	22.62
RMC 384 kbit/s	22.44	22.48	22.60
AMR 4,75 kbit/s	22.34	22.31	22.48
AMR 5,15 kbit/s	22.35	22.33	22.49
AMR 5,9 kbit/s	22.31	22.30	22.47
AMR 6,7 kbit/s	22.36	22.36	22.50
AMR7,4 kbit/s	22.34	22.35	22.46
AMR 7,95 kbit/s	22.34	22.35	22.49
AMR 10,2 kbit/s	22.33	22.36	22.47
AMR 12,2 kbit/s	22.32	22.34	22.47
<b>HSDPA Sub test 1</b>	<b>22.58</b>	<b>22.63</b>	<b>22.67</b>
HSDPA Sub test 2	20.40	20.55	20.74
HSDPA Sub test 3	18.95	19.16	19.31
HSDPA Sub test 4	18.82	18.90	19.02
HSUPA Sub test 1	22.28	22.23	22.42
HSUPA Sub test 2	19.51	19.45	19.58
HSUPA Sub test 3	21.13	21.10	21.22
HSUPA Sub test 4	20.32	20.28	20.36
<b>HSUPA Sub test 5</b>	<b>22.37</b>	<b>22.33</b>	<b>22.48</b>

Table 11: Test results conducted power measurement WCDMA 850



**2.5.6 Conducted power measurements WCDMA FDD II (1900 MHz)**

<b>Max. RMS output power 1900 MHz (FDD II) / dBm</b>			
mode	Channel / frequency		
	9262 / 1852.4 MHz	9400 / 1880.0 MHz	9538 / 1907.6 MHz
<b>RMC 12.2 kbit/s</b>	<b>22.04</b>	<b>22.19</b>	<b>21.96</b>
RMC 64 kbit/s	22.03	22.20	21.96
RMC 144 kbit/s	22.05	22.20	21.96
RMC 384 kbit/s	22.02	22.19	21.96
AMR 4,75 kbit/s	21.98	22.14	21.92
AMR 5,15 kbit/s	21.96	22.11	21.94
AMR 5,9 kbit/s	21.97	22.12	21.95
AMR 6,7 kbit/s	22.00	22.09	21.90
AMR7,4 kbit/s	21.92	22.10	21.89
AMR 7,95 kbit/s	21.94	22.13	21.91
AMR 10,2 kbit/s	21.99	22.15	21.88
AMR 12,2 kbit/s	21.93	22.14	21.87
<b>HSDPA Sub test 1</b>	<b>21.91</b>	<b>21.91</b>	<b>22.07</b>
HSDPA Sub test 2	20.01	19.91	20.03
HSDPA Sub test 3	18.61	18.45	18.68
HSDPA Sub test 4	18.28	18.29	18.21
HSUPA Sub test 1	22.09	22.12	21.93
HSUPA Sub test 2	18.87	18.92	18.81
HSUPA Sub test 3	20.41	20.46	20.34
HSUPA Sub test 4	19.91	19.92	19.86
<b>HSUPA Sub test 5</b>	<b>22.10</b>	<b>22.14</b>	<b>21.96</b>

Table 12: Test results conducted power measurement WCDMA 1900

Remark : None of the HSDPA/HSUPA settings leads to conducted power values exceeding the conducted power in RMC mode by more than 0.25 dB.

Therefore no additional SAR measurements were performed in HSDPA/HSUPA mode.

**2.5.7 Test-set-up information for WCDMA / HSPDA / HSUPA**

a) RMC

In RMC (reference measurement channel) mode the conducted power at 4 different bit rates was measured. They correspond with the used spreading factors as follows :

Bit rate	12.2 kbit/s	64 kbit/s	144 kbit/s	384 kbit/s
Spreading factor (SF)	64	16	8	4

In RMC mode only DPCCH and DPDCH are active. As bit rate changes do not influence the relative power of any code channel the measured RMS output power remains on the same level which is set to maximum by TPC (Transmit power control) pattern type 'All 1'.

b) HSDPA

HSDPA adds the HS-DPCCH in uplink as a control channel for high speed data transfer in downlink. In HSDPA mode 4 sub-tests are defined by 3GPP 34.121 according to the following table:

Sub-test	$\beta_c$	$\beta_d$	$\beta_d$ (SF)	$\beta_c/\beta_d$	$\beta_{hs}^{(1)}$	CM(dB) <sup>(2)</sup>
1	2/15	15/15	64	2/15	4/15	0.0
2	12/15 <sup>(3)</sup>	15/15 <sup>(3)</sup>	64	12/15 <sup>(3)</sup>	24/15	1.0
3	15/15	8/15	64	15/8	30/15	1.5
4	15/15	4/15	64	15/4	30/15	1.5

Note 1:  $\Delta_{ACK}, \Delta_{NACK}, \Delta_{CQI} = 8 \iff A_{hs} = \beta_{hs}/\beta_c = 30/15 \iff \beta_{hs} = 30/15 * \beta_c$

Note 2 : CM = 1 for  $\beta_c/\beta_d = 12/15, \beta_{hs}/\beta_c = 24/15$

Note 3 : For subtest 2 the  $\beta_c/\beta_d$  ratio of 12/15 for the TFC during the measurement period (TF1, TF0) is achieved by setting the signalled gain factors for the reference TFC (TF1,TF1) to  $\beta_c = 11/15$  and  $\beta_d = 15/15$

Table 13: Sub-tests for UMTS Release 5 HSDPA

The  $\beta_c$  and  $\beta_d$  gain factors for DPCCH and DPDCH were set according to the values in the above table,  $\beta_{hs}$  for HS-DPCCH is set automatically to the correct value when  $\Delta_{ACK}, \Delta_{NACK}, \Delta_{CQI} = 8$ . The variation of the  $\beta_c/\beta_d$  ratio causes a power reduction at sub-tests 2 - 4.

The measurements were performed with a Fixed Reference Channel(FRC) and H-Set 1 QPSK.

Parameter	Value
Nominal average inf. bit rate	534 kbit/s
Inter-TTI Distance	3 TTI's
Number of HARQ Processes	2 Processes
Information Bit Payload	3202 Bits
MAC-d PDU size	336 Bits
Number Code Blocks	1 Block
Binary Channel Bits Per TTI	4800 Bits
Total Available SMLs in UE	19200 SMLs
Number of SMLs per HARQ Process	9600 SMLs
Coding Rate	0.67
Number of Physical Channel Codes	5

Table 14: settings of required H-Set 1 QPSK acc. to 3GPP 34.121

c) HSUPA

In HSUPA mode additional code channels (E-DPCCH, E-DPDCHn) are added for data transfer in uplink at higher bit rates.

5 sub-tests are defined by 3GPP 34.121 according to the following table :

Sub-test	$\beta_c$	$\beta_a$	$\beta_a$ (SF)	$\beta_c/\beta_a$	$\beta_{hs}^{(1)}$	$\beta_{ec}$	$\beta_{ed}$	$\beta_{ec}$ (SF)	$\beta_{ed}$ (code)	CM <sup>(2)</sup> (dB)	MPR (dB)	AG <sup>(4)</sup> Index	E-TFCI
1	11/15 <sup>(3)</sup>	15/15 <sup>(3)</sup>	64	11/15 <sup>(3)</sup>	22/15	209/225	1039/225	4	1	1.0	0.0	20	75
2	6/15	15/15	64	6/15	12/15	12/15	94/75	4	1	3.0	2.0	12	67
3	15/15	9/15	64	15/9	30/15	30/15	$\beta_{ed1}:47/15$ $\beta_{ed2}:47/15$	4	2	2.0	1.0	15	92
4	2/15	15/15	64	2/15	4/15	2/15	56/75	4	1	3.0	2.0	17	71
5	15/15 <sup>(4)</sup>	15/15 <sup>(4)</sup>	64	15/15 <sup>(4)</sup>	30/15	24/15	134/15	4	1	1.0	0.0	21	81

Note 1 :  $\Delta_{ACK}, \Delta_{NACK}, \Delta_{CQI} = 8 \iff A_{hs} = \beta_{hs}/\beta_c = 30/15 \iff \beta_{hs} = 30/15 * \beta_c$   
 Note 2 : CM = 1 for  $\beta_c/\beta_a = 12/15, \beta_{hs}/\beta_c = 24/15$ . For all other combinations of DPDCH, DPCCH, HS-DPCCH, E-DPDCH and E-DPCCH the MPR is based on the relative CM difference  
 Note 3 : For subtest 1 the  $\beta_c/\beta_a$  ratio of 11/15 for the TFC during the measurement period (TF1, TF0) is achieved by setting the signalled gain factors for the reference TFC (TF1,TF1) to  $\beta_c = 10/15$  and  $\beta_a = 15/15$   
 Note 4 : For subtest 5 the  $\beta_c/\beta_a$  ratio of 15/15 for the TFC during the measurement period (TF1, TF0) is achieved by setting the signalled gain factors for the reference TFC (TF1,TF1) to  $\beta_c = 14/15$  and  $\beta_a = 15/15$   
 Note 5 : Testing UE using E-DPDCH Physical Layer category 1 Sub-test 3 is not required according to TS 25.306 Table 5.1g  
 Note 6 :  $\beta_{ed}$  can not be set directly; it is set by Absolute Grant Value

Table 15: Subtests for UMTS Release 6 HSUPA

To achieve the settings above some additional procedures were defined by 3GPP 34.121. Those have been included in an application note for the CMU200 and were exactly followed :

- Test mode connection (BS signal tab) :  
RMC 12.2 kbit/s + HSPA 34.108 with loop mode 1
- HS-DSCH settings (BS signal tab):
  - FRC with H-set 1 QPSK
  - ACK-NACK repetition factor = 3
  - CQI feedback cycle = 4ms
  - CQI repetition factor = 2
- HSUPA-specific signalling settings (UE signal tab) :
  - E-TFCI table index = 0
  - E-DCH minimum set E-TFCI = 9
  - Puncturing limit non-max = 0.84
  - max. number of channelisation codes = 2x SF4
  - Initial Serving Grant Value = Off
- HSDPA and HSUPA Gain factors (UE signal tab)

Sub-test	$\beta_c$	$\beta_d$	$\Delta_{ACK}, \Delta_{NACK}, \Delta_{CQI}$	$\Delta E-DPCCH$ )*
1	10	15	8	6
2	6	15	8	8
3	15	9	8	8
4	2	15	8	5
5	14	15	8	7

)\* :  $\beta_{ec}$  and  $\beta_{ed}$  ratios (relative to  $\beta_c$  and  $\beta_d$ ) are set by  $\Delta E-DPCCH$

- HSUPA Reference E-TFCIs (UE signal tab > HSUPA gain factors) :

Sub-test	1, 2, 4, 5				
Number of E-TFCIs	5				
Reference E-TFCI	11	67	71	75	81
Reference E-TFCI power offset	4	18	23	26	27

Sub-test	3	
Number of E-TFCIs	2	
Reference E-TFCI	11	92
Reference E-TFCI power offset	4	18

- HSUPA-specific generator parameters (BS Signal tab > HSUPA > E-AGCH > AG Pattern)

Sub-test	Absolute Grant Value (AG Index)
1	20
2	12
3	15
4	17
5	21

- Power Level settings (BS Signal tab > Node B-settings):
  - Level reference : Output Channel Power (lor)
  - Output Channel Power (lor) : -86 dBm
  
- Downlink Physical Channel Settings (BS signal tab)
  - P-CPICH : -10 dB
  - S-CPICH : Off
  - P-SCH : -15 dB
  - S-SCH : -15 dB
  - P-CCPCH : -12 dB
  - S-CCPCH : -12 dB
  - PICH : -15 dB
  - AICH : -12 dB
  - DPDCH : -10 dB
  - HS-SCCH : -8 dB
  - HS-PDSCH : -3 dB
  - E-AGCH : -20 dB
  - E-RGCH/E-HICH - 20 dB
  - E-RGCH Active : Off

The settings above were stored once for each sub-test and recalled before the measurement.

### 2.5.8 HSUPA test procedure :

To reach maximum output power in HSUPA mode the following procedures were followed:

3 different TPC patterns were defined :

Set 1 : Closed loop with target power 10 dBm

Set 2 : Single Pattern+Alternating with binary pattern '11111' for 1 dB steps 'up'

Set 3 : Single Pattern+Alternating with binary pattern '00000' for 1 dB steps 'down'

After recalling a certain HSUPA sub-test the HSUPA E-AGCH graph with E-TFCI event counter is displayed. After starting with the closed loop command the power is increased in 1 dB steps by activating pattern set 2 until the UE decreases the transmitted E-TFCI.

At this point set 3 is activated once to reduce the output power to the value at which the original E-TFCI, which is required for the sub-test, appears again.

For conducted power measurements the same steps are repeated in the power menu to read out the corresponding maximum RMS output power with the target E-TFCI.

For SAR measurements it is useful to switch to Code Domain Power vs. Time display.

Here the CMU200 shows relative power values (max. and min.) of each code channel which should roughly correspond to the numerators of the gain factors e.g. :

Sub-test	$\beta_c$	$\beta_d$	$\beta_{hs}$	$\beta_{ec}$	$\beta_{ed}$
5	15	15	30	24	134

By this way a surveillance of signalling conditions is possible to make sure that HSUPA code channels are active during the complete SAR measurement.

**2.5.9 Multiple Transmitter Information**

The following tables list information which is relevant for the decision if a simultaneous transmit evaluation is necessary according to KDB 648474.

important abbreviations :

SPLSR : Antenna pair SAR to Peak Location Separation Ratio  $(SAR_x + SAR_y)/d_{xy}$

$P_{ref}$  : 12 mW at 2.4 GHz

a) head position

Tx No.	Communcation system and frequency band	$P_{avg}$ (mW)	single SAR (W/kg) (see ch. 2.6)	remarks
1a	GSM 850 MHz	250	1.45	routine evaluation
1b	GSM 1900 MHz	125	1.30	routine evaluation
1c	FDD V 850 MHz	250	1.26	routine evaluation
1d	FDD II 1900 MHz	250	1.34	routine evaluation
2	Bluetooth 2450 MHz	5	:=0	$P_2 < P_{ref}$
Sum of all 1g-SAR values			n/a	

Table 16: Communication systems and SAR values in head position

antenna pair (x,y)	antenna distance $d_{xy}$ (cm)	$L_{xy}$ (cm)	SPLSR <sub>xy</sub>	sim.-Tx SAR	remarks
(1a,2)	> 5 cm	n/a	< 0.29	N	SPLSR <sub>xy</sub> < 0.3
(1b,2)	> 5 cm	n/a	< 0.26	N	SPLSR <sub>xy</sub> < 0.3
(1c,2)	> 5 cm	n/a	< 0.252	N	SPLSR <sub>xy</sub> < 0.3
(1d,2)	> 5 cm	n/a	< 0.268	N	SPLSR <sub>xy</sub> < 0.3

Table 17: Antenna distances and SPLSR evaluation in head position

a) body position

Tx No.	Communcation system and frequency band	$P_{avg}$ (mW)	single SAR (W/kg) (see ch. 2.6)	remarks
1a	GSM 850 MHz	500	0.991	routine evaluation
1b	GSM 1900 MHz	250	0.653	routine evaluation
1c	FDD V 850 MHz	250	0.767	routine evaluation
1d	FDD II 1900 MHz	250	0.538	routine evaluation
2	Bluetooth 2450 MHz	5	:=0	$P_2 < P_{ref}$
Sum of all 1g-SAR values			n/a	

Table 18: Communication systems and SAR values in body position

antenna pair (x,y)	antenna distance $d_{xy}$ (cm)	$L_{xy}$ (cm)	SPLSR <sub>xy</sub>	sim.-Tx SAR	remarks
(1a,2)	> 5 cm	n/a	< 0.198	N	SPLSR <sub>xy</sub> < 0.3
(1b,2)	> 5 cm	n/a	< 0.13	N	SPLSR <sub>xy</sub> < 0.3
(1c,2)	> 5 cm	n/a	< 0.153	N	SPLSR <sub>xy</sub> < 0.3
(1d,2)	> 5 cm	n/a	< 0.108	N	SPLSR <sub>xy</sub> < 0.3

Table 19: Antenna distances and SPLSR evaluation in body position

In simple words :

The distance of the GSM/UMTS antenna at the bottom end of the DUT to the Bluetooth antenna at the top end of the DUT is > 5 cm and the sum of the SAR values is < 1.6 W/kg :

No simultaneous transmission SAR evaluation is necessary with GSM/UMTS.

The Bluetooth output power is below  $P_{ref}$ . So standalone SAR for BT is not necessary.

**2.6 Test results (Head and Body SAR)**

The table contains the measured SAR values averaged over a mass of 1 g					
Channel / frequency	Position	Left hand position	Right hand position	Limit	Liquid temperature
128 / 824.2 MHz	cheek	0.915 W/kg	0.887 W/kg	1.6 W/kg	21.6/21.7 °C
190 / 836.6 MHz	cheek	1.120 W/kg	1.060 W/kg	1.6 W/kg	21.6/21.7 °C
251 / 848.8 MHz	cheek	<b>1.450 W/kg</b>	1.380 W/kg	1.6 W/kg	21.6/21.7 °C
128 / 824.2 MHz	tilted 15°	0.409 W/kg	0.443 W/kg	1.6 W/kg	21.8/21.5 °C
190 / 836.6 MHz	tilted 15°	0.476 W/kg	0.497 W/kg	1.6 W/kg	21.8/21.5 °C
251 / 848.8 MHz	tilted 15°	0.597 W/kg	0.617 W/kg	1.6 W/kg	21.8/21.5 °C

Table 20: Test results (Head SAR PCS 850 MHz)

The table contains the measured SAR values averaged over a mass of 1 g				
Channel / frequency	Position	Body worn	Limit	Liquid temperature
128 / 824.2 MHz	front	0.662 W/kg	1.6 W/kg	21.5 °C
190 / 836.6 MHz	front	0.813 W/kg	1.6 W/kg	21.5 °C
251 / 848.8 MHz	front	<b>0.991 W/kg</b>	1.6 W/kg	21.5 °C
128 / 824.2 MHz	rear	0.577 W/kg	1.6 W/kg	21.6 °C
190 / 836.6 MHz	rear	0.724 W/kg	1.6 W/kg	21.6 °C
251 / 848.8 MHz	rear	0.887 W/kg	1.6 W/kg	21.6 °C
251 / 848.8 MHz	front 1TS	0.797 W/kg	1.6 W/kg	21.5 °C

Table 21: Test results (Body SAR PCS 850 MHz)

Note: The SAR test shall be performed at the high, middle and low frequency channels of each operating mode. If the SAR measured at mid-band channel for each test configuration is at least 3.0 dB lower than the SAR limit (< 0.8 W/kg), testing at the high and low channels is optional.

Tests in body position were performed with 15 mm air gap between DUT and SAM to simulate the use of a non-metallic belt-clip or holster.

The addition body test was performed at worst case with 1 time slot in uplink in accordance with Sony Ericsson.



The table contains the measured SAR values averaged over a mass of 1 g

Channel / frequency	Position	Left hand position	Right hand position	Limit	Liquid temperature
512 / 1850.2 MHz	cheek	1.150 W/kg	<b>1.300 W/kg</b>	1.6 W/kg	21.1/21.2 °C
661 / 1880.0 MHz	cheek	1.090 W/kg	1.180 W/kg	1.6 W/kg	21.1/21.2 °C
810 / 1909.8 MHz	cheek	0.971 W/kg	1.040 W/kg	1.6 W/kg	21.1/21.2 °C
512 / 1850.2 MHz	tilted 15°	0.372 W/kg	0.438 W/kg	1.6 W/kg	21.1/21.2 °C
661 / 1880.0 MHz	tilted 15°	0.358 W/kg	0.401 W/kg	1.6 W/kg	21.1/21.2 °C
810 / 1909.8 MHz	tilted 15°	0.336 W/kg	0.351 W/kg	1.6 W/kg	21.1/21.2 °C

Table 22: Test results (Head SAR PCS 1900 MHz)

The table contains the measured SAR values averaged over a mass of 1 g

Channel / frequency	Position	Body worn	Limit	Liquid temperature
512 / 1850.2 MHz	front	0.423 W/kg	1.6 W/kg	21.3 °C
661 / 1880.0 MHz	front	0.400 W/kg	1.6 W/kg	21.3 °C
810 / 1909.8 MHz	front	0.348 W/kg	1.6 W/kg	21.3 °C
512 / 1850.2 MHz	rear	<b>0.653 W/kg</b>	1.6 W/kg	21.3 °C
661 / 1880.0 MHz	rear	0.646 W/kg	1.6 W/kg	21.3 °C
810 / 1909.8 MHz	rear	0.555 W/kg	1.6 W/kg	21.3 °C
512 / 1850.2 MHz	rear 1TS	0.436 W/kg	1.6 W/kg	21.3 °C

Table 23: Test results (Body SAR PCS 1900 MHz)

Note: The SAR test shall be performed at the high, middle and low frequency channels of each operating mode. If the SAR measured at mid-band channel for each test configuration is at least 3.0 dB lower than the SAR limit (< 0.8 W/kg), testing at the high and low channels is optional.

Tests in body position were performed with 15 mm air gap between DUT and SAM to simulate the use of a non-metallic belt-clip or holster.

The addition body test was performed at worst case with 1 time slot in uplink in accordance with Sony Ericsson.

The table contains the measured SAR values averaged over a mass of 1 g

Channel / frequency	Position	Left hand position	Right hand position	Limit	Liquid temperature
4133 / 824.2 MHz	cheek	1.140 W/kg	1.130 W/kg	1.6 W/kg	22.3/22.2 °C
4182 / 836.6 MHz	cheek	<b>1.260 W/kg</b>	1.240 W/kg	1.6 W/kg	22.3/22.2 °C
4233 / 848.8 MHz	cheek	1.240 W/kg	1.220 W/kg	1.6 W/kg	22.3/22.2 °C
4133 / 824.2 MHz	tilted 15°	0.491 W/kg	0.490 W/kg	1.6 W/kg	22.2/22.2 °C
4182 / 836.6 MHz	tilted 15°	0.527 W/kg	0.516 W/kg	1.6 W/kg	22.2/22.2 °C
4233 / 848.8 MHz	tilted 15°	0.518 W/kg	0.499 W/kg	1.6 W/kg	22.2/22.2 °C

Table 24: Test results (Head SAR WCDMA FDD V 850 MHz)

The table contains the measured SAR values averaged over a mass of 1 g

Channel / frequency	Position	Body worn	Limit	Liquid temperature
4133 / 824.2 MHz	front	0.666 W/kg	1.6 W/kg	21.5 °C
4182 / 836.6 MHz	front	<b>0.767 W/kg</b>	1.6 W/kg	21.5 °C
4233 / 848.8 MHz	front	0.691 W/kg	1.6 W/kg	21.5 °C
4133 / 824.2 MHz	rear	0.600 W/kg	1.6 W/kg	21.6 °C
4182 / 836.6 MHz	rear	0.673 W/kg	1.6 W/kg	21.6 °C
4233 / 848.8 MHz	rear	0.617 W/kg	1.6 W/kg	21.6 °C

Table 25: Test results (Body SAR WCDMA FDD V 850 MHz)

Note: The SAR test shall be performed at the high, middle and low frequency channels of each operating mode. If the SAR measured at mid-band channel for each test configuration is at least 3.0 dB lower than the SAR limit (< 0.8 W/kg), testing at the high and low channels is optional.

Tests in body position were performed with 15 mm air gap between DUT and SAM to simulate the use of a non-metallic belt-clip or holster.

The table contains the measured SAR values averaged over a mass of 1 g					
Channel / frequency	Position	Left hand position	Right hand position	Limit	Liquid temperature
9262 / 1850.2 MHz	cheek	1.220 W/kg	1.320 W/kg	1.6 W/kg	22.0/22.0 °C
9400 / 1880.0 MHz	cheek	1.180 W/kg	1.230 W/kg	1.6 W/kg	22.0/22.0 °C
9538 / 1909.8 MHz	cheek	1.300 W/kg	<b>1.340 W/kg</b>	1.6 W/kg	22.0/22.0 °C
9262 / 1850.2 MHz	tilted 15°	0.413 W/kg	0.496 W/kg	1.6 W/kg	22.0/22.0 °C
9400 / 1880.0 MHz	tilted 15°	0.400 W/kg	0.463 W/kg	1.6 W/kg	22.0/22.0 °C
9538 / 1909.8 MHz	tilted 15°	0.479 W/kg	0.512 W/kg	1.6 W/kg	22.0/22.0 °C

Table 26: Test results (Head SAR WCDMA FDD II 1850 MHz)

The table contains the measured SAR values averaged over a mass of 1 g				
Channel / frequency	Position	Body worn	Limit	Liquid temperature
9262 / 1850.2 MHz	front	0.317 W/kg	1.6 W/kg	21.4 °C
9400 / 1880.0 MHz	front	0.314 W/kg	1.6 W/kg	21.4 °C
9538 / 1909.8 MHz	front	0.367 W/kg	1.6 W/kg	21.4 °C
9262 / 1850.2 MHz	rear	0.480 W/kg	1.6 W/kg	21.4 °C
9400 / 1880.0 MHz	rear	0.485 W/kg	1.6 W/kg	21.4 °C
9538 / 1909.8 MHz	rear	<b>0.538 W/kg</b>	1.6 W/kg	21.4 °C

Table 27: Test results (Body SAR WCDMA FDD II 1850 MHz)

Note: The SAR test shall be performed at the high, middle and low frequency channels of each operating mode. If the SAR measured at mid-band channel for each test configuration is at least 3.0 dB lower than the SAR limit (< 0.8 W/kg), testing at the high and low channels is optional.

Tests in body position were performed with 15 mm air gap between DUT and SAM to simulate the use of a non-metallic belt-clip or holster.

### 2.6.1 General description of test procedures

The DUT is tested using a CMU 200 communications tester as controller unit to set test channels and maximum output power to the DUT, as well as for measuring the conducted peak power.

Test positions as described in the tables above are in accordance with the specified test standard.

Tests in body position are performed with the maximum number of timeslots in uplink.

Tests in head position are performed in voice mode with 1 timeslot unless GPRS/EGPRS function allows parallel voice and data traffic on 2 or more timeslots (see chapter 1.5 for details).

Conducted output power was measured using an integrated RF connector and attached RF cable.

**Annex 1 System performance verification**

Date/Time: 2009-03-22 11:32:34 Date/Time: 2009-03-22 11:36:23

**System Performance Check-D900-850 head 2009-03-22**

**DUT: Dipole 900 MHz; Type: D900V2; Serial: 102**

Communication System: CW; Frequency: 900 MHz; Duty Cycle: 1:1

Medium: HSL850 Medium parameters used:  $f = 900 \text{ MHz}$ ;  $\sigma = 1 \text{ mho/m}$ ;  $\epsilon_r = 41.4$ ;  $\rho = 1000 \text{ kg/m}^3$

Phantom section: Flat Section

DASY4 Configuration:

- Probe: ET3DV6 - SN1558; ConvF(5.99, 5.99, 5.99); Calibrated: 2008-08-15
- Sensor-Surface: 4mm (Mechanical And Optical Surface Detection)
- Electronics: DAE3 Sn413; Calibrated: 2009-01-08
- Phantom: SAM 12; Type: SAM; Serial: 1043
- Measurement SW: DASY4, V4.5 Build 19; Postprocessing SW: SEMCAD, V1.8 Build 146

**d=15mm, Pin=1000mW/Area Scan (51x51x1):** Measurement grid: dx=15mm, dy=15mm  
 Maximum value of SAR (interpolated) = 11.5 mW/g

**d=15mm, Pin=1000mW/Zoom Scan (7x7x7) (7x7x7)/Cube 0:** Measurement grid: dx=5mm, dy=5mm, dz=5mm  
 Reference Value = 81.5 V/m; Power Drift = 2.72 dB  
 Peak SAR (extrapolated) = 16.2 W/kg  
**SAR(1 g) = 10.7 mW/g; SAR(10 g) = 6.89 mW/g**  
 Maximum value of SAR (measured) = 11.7 mW/g

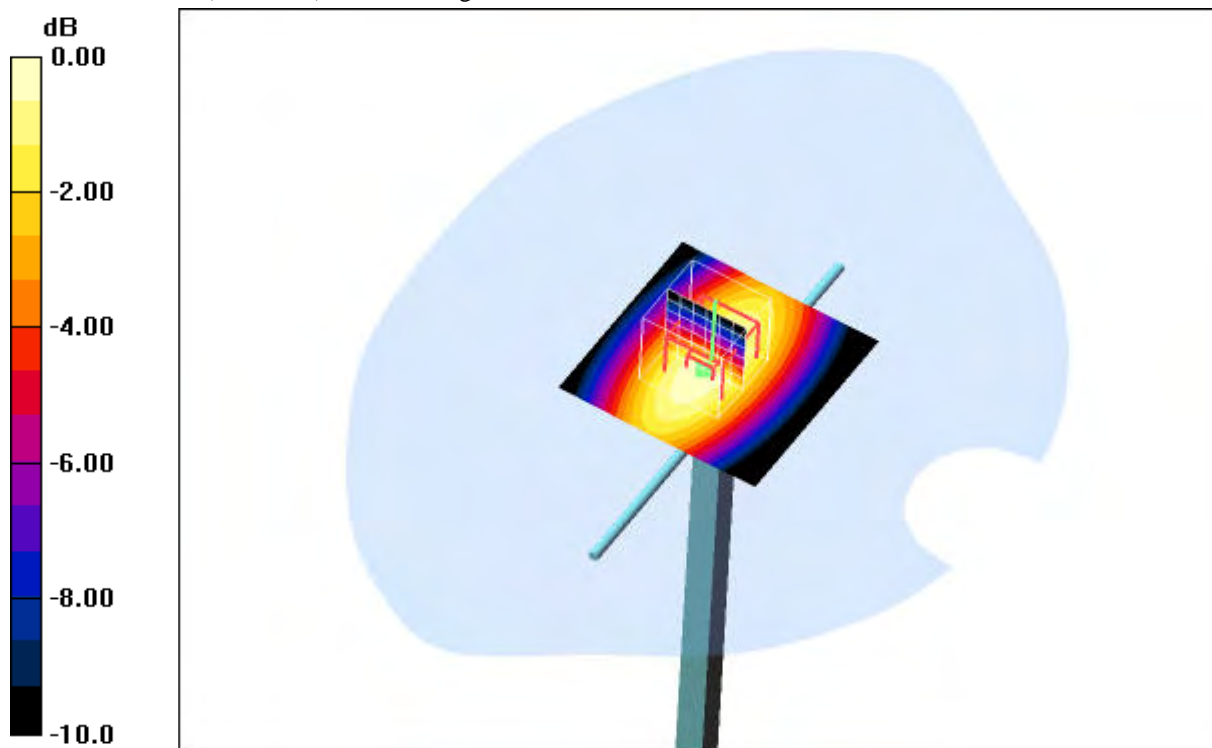

0 dB = 11.7mW/g

**Additional information:**

position or distance of DUT to SAM (if not standard head positions) :  
 ambient temperature: 21.9 °C; liquid temperature: 21.6 °C

Date/Time: 2009-04-03 08:39:11 Date/Time: 2009-04-03 08:42:54

**System Performance Check-D900-850 head 2009-04-03**

**DUT: Dipole 900 MHz; Type: D900V2; Serial: 102**

Communication System: CW; Frequency: 900 MHz; Duty Cycle: 1:1

Medium: HSL850 Medium parameters used:  $f = 900 \text{ MHz}$ ;  $\sigma = 1 \text{ mho/m}$ ;  $\epsilon_r = 41.4$ ;  $\rho = 1000 \text{ kg/m}^3$

Phantom section: Flat Section

DASY4 Configuration:

- Probe: ET3DV6 - SN1558; ConvF(5.99, 5.99, 5.99); Calibrated: 2008-08-15
- Sensor-Surface: 4mm (Mechanical And Optical Surface Detection)
- Electronics: DAE3 Sn413; Calibrated: 2009-01-08
- Phantom: SAM 12; Type: SAM; Serial: 1043
- Measurement SW: DASY4, V4.5 Build 19; Postprocessing SW: SEMCAD, V1.8 Build 146

**d=15mm, Pin=1000mW/Area Scan (51x51x1):** Measurement grid: dx=15mm, dy=15mm

Maximum value of SAR (interpolated) = 12.0 mW/g

**d=15mm, Pin=1000mW/Zoom Scan (7x7x7) (7x7x7)/Cube 0:** Measurement grid: dx=5mm, dy=5mm, dz=5mm

Reference Value = 115.1 V/m; Power Drift = -0.00 dB

Peak SAR (extrapolated) = 16.8 W/kg

**SAR(1 g) = 11.3 mW/g; SAR(10 g) = 7.27 mW/g**

Maximum value of SAR (measured) = 12.3 mW/g

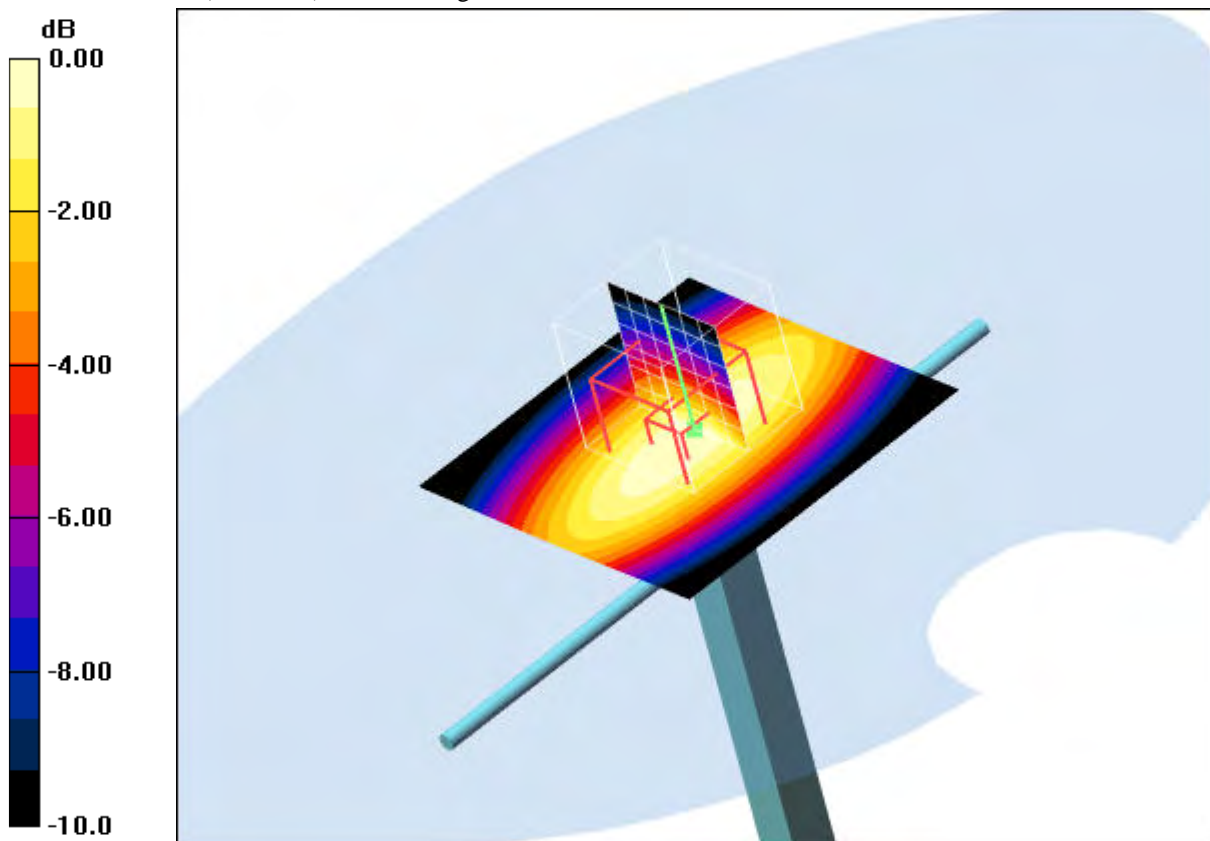

0 dB = 12.3mW/g

**Additional information:**

position or distance of DUT to SAM (if not standard head positions) :

ambient temperature: 22.7°C; liquid temperature: 22.3°C

Date/Time: 2009-04-02 08:50:23 Date/Time: 2009-04-02 08:54:02

**System Performance Check-D900 body 2009-04-02**

**DUT: Dipole 900 MHz; Type: D900V2; Serial: 102**

Communication System: CW; Frequency: 900 MHz; Duty Cycle: 1:1

Medium: M900 Medium parameters used:  $f = 900 \text{ MHz}$ ;  $\sigma = 1.06 \text{ mho/m}$ ;  $\epsilon_r = 53.6$ ;  $\rho = 1000 \text{ kg/m}^3$

Phantom section: Flat Section

DASY4 Configuration:

- Probe: ET3DV6 - SN1558; ConvF(5.8, 5.8, 5.8); Calibrated: 2008-08-15
- Sensor-Surface: 4mm (Mechanical And Optical Surface Detection)
- Electronics: DAE3 Sn413; Calibrated: 2009-01-08
- Phantom: SAM 12; Type: SAM; Serial: 1043
- Measurement SW: DASY4, V4.5 Build 19; Postprocessing SW: SEMCAD, V1.8 Build 146

**d=15mm, Pin=1000mW/Area Scan (51x51x1):** Measurement grid: dx=15mm, dy=15mm

Maximum value of SAR (interpolated) = 12.1 mW/g

**d=15mm, Pin=1000mW/Zoom Scan (7x7x7) (7x7x7)/Cube 0:** Measurement grid: dx=5mm, dy=5mm,

dz=5mm

Reference Value = 112.0 V/m; Power Drift = -0.048 dB

Peak SAR (extrapolated) = 16.3 W/kg

**SAR(1 g) = 11.2 mW/g; SAR(10 g) = 7.27 mW/g**

Maximum value of SAR (measured) = 12.1 mW/g

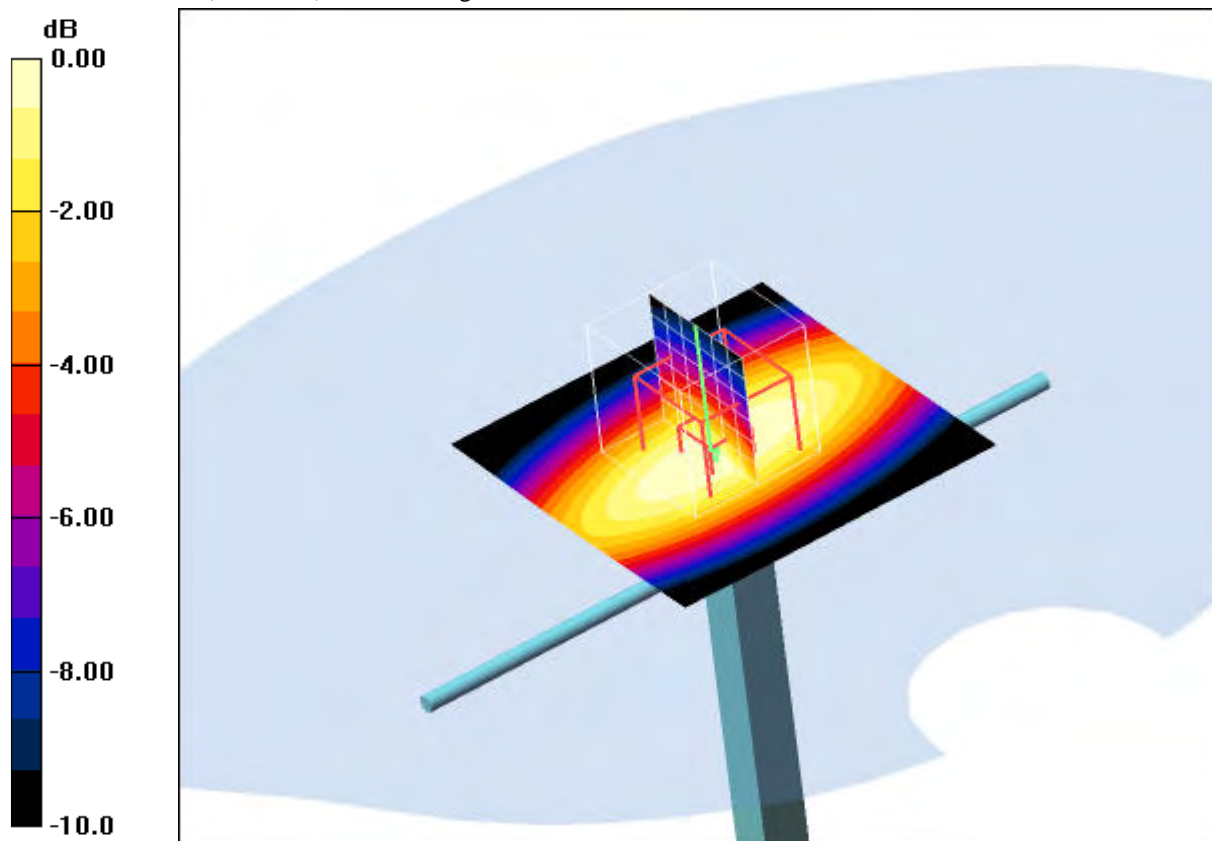

0 dB = 12.1mW/g

**Additional information:**

position or distance of DUT to SAM (if not standard head positions) :

ambient temperature: 22.6°C; liquid temperature: 22.2°C

Date/Time: 2009-03-23 16:01:15 Date/Time: 2009-03-23 16:04:54

**System Performance Check-D1900 head 2009-03-23**

**DUT: Dipole 1900 MHz; Type: D1900V2; Serial: D1900V2 - SN:531**

Communication System: CW; Frequency: 1900 MHz; Duty Cycle: 1:1

Medium: HSL1900 Medium parameters used (interpolated):  $f = 1900 \text{ MHz}$ ;  $\sigma = 1.39 \text{ mho/m}$ ;  $\epsilon_r = 40.4$ ;  $\rho = 1000 \text{ kg/m}^3$

Phantom section: Flat Section

DASY4 Configuration:

- Probe: ET3DV6 - SN1558; ConvF(4.96, 4.96, 4.96); Calibrated: 2008-08-15
- Sensor-Surface: 4mm (Mechanical And Optical Surface Detection)
- Electronics: DAE3 Sn413; Calibrated: 2009-01-08
- Phantom: SAM 12; Type: SAM; Serial: 1043
- Measurement SW: DASY4, V4.5 Build 19; Postprocessing SW: SEMCAD, V1.8 Build 146

**d=10mm, Pin=1000mW/Area Scan (51x51x1):** Measurement grid: dx=15mm, dy=15mm

Maximum value of SAR (interpolated) = 51.7 mW/g

**d=10mm, Pin=1000mW/Zoom Scan (7x7x7) (7x7x7)/Cube 0:** Measurement grid: dx=5mm, dy=5mm, dz=5mm

Reference Value = 183.7 V/m; Power Drift = -0.077 dB

Peak SAR (extrapolated) = 72.8 W/kg

**SAR(1 g) = 39 mW/g; SAR(10 g) = 20.3 mW/g**

Maximum value of SAR (measured) = 43.6 mW/g

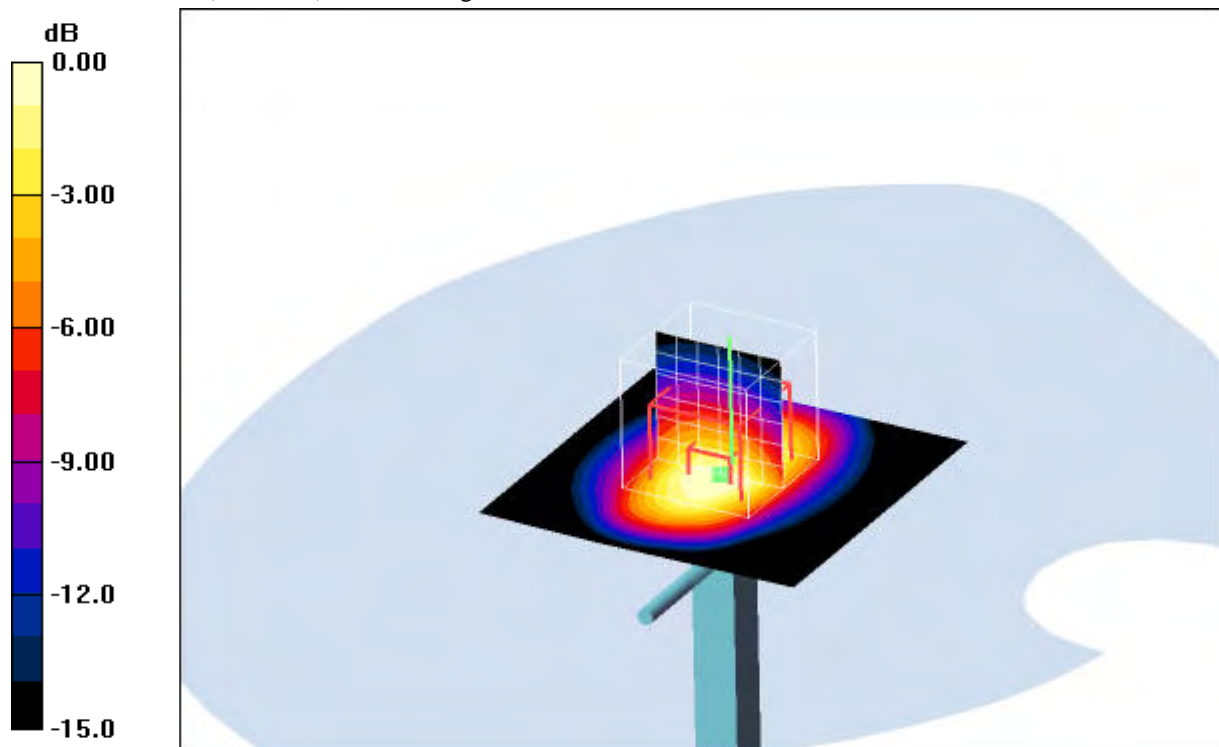

0 dB = 43.6mW/g

**Additional information:**

position or distance of DUT to SAM (if not standard head positions) :

ambient temperature: 22.9°C; liquid temperature: 22.0°C

Date/Time: 2009-03-24 08:40:56 Date/Time: 2009-03-24 08:44:34

**System Performance Check-D1900 head 2009-03-24**

**DUT: Dipole 1900 MHz; Type: D1900V2; Serial: D1900V2 - SN:531**

Communication System: CW; Frequency: 1900 MHz; Duty Cycle: 1:1

Medium: HSL1900 Medium parameters used (interpolated):  $f = 1900 \text{ MHz}$ ;  $\sigma = 1.39 \text{ mho/m}$ ;  $\epsilon_r = 40.4$ ;  $\rho = 1000 \text{ kg/m}^3$

Phantom section: Flat Section

DASY4 Configuration:

- Probe: ET3DV6 - SN1558; ConvF(4.96, 4.96, 4.96); Calibrated: 2008-08-15
- Sensor-Surface: 4mm (Mechanical And Optical Surface Detection)
- Electronics: DAE3 Sn413; Calibrated: 2009-01-08
- Phantom: SAM 12; Type: SAM; Serial: 1043
- Measurement SW: DASY4, V4.5 Build 19; Postprocessing SW: SEMCAD, V1.8 Build 146

**d=10mm, Pin=1000mW/Area Scan (51x51x1):** Measurement grid: dx=15mm, dy=15mm  
 Maximum value of SAR (interpolated) = 51.9 mW/g

**d=10mm, Pin=1000mW/Zoom Scan (7x7x7) (7x7x7)/Cube 0:** Measurement grid: dx=5mm, dy=5mm, dz=5mm  
 Reference Value = 184.8 V/m; Power Drift = -0.017 dB  
 Peak SAR (extrapolated) = 72.8 W/kg  
**SAR(1 g) = 39.1 mW/g; SAR(10 g) = 20.4 mW/g**  
 Maximum value of SAR (measured) = 43.9 mW/g

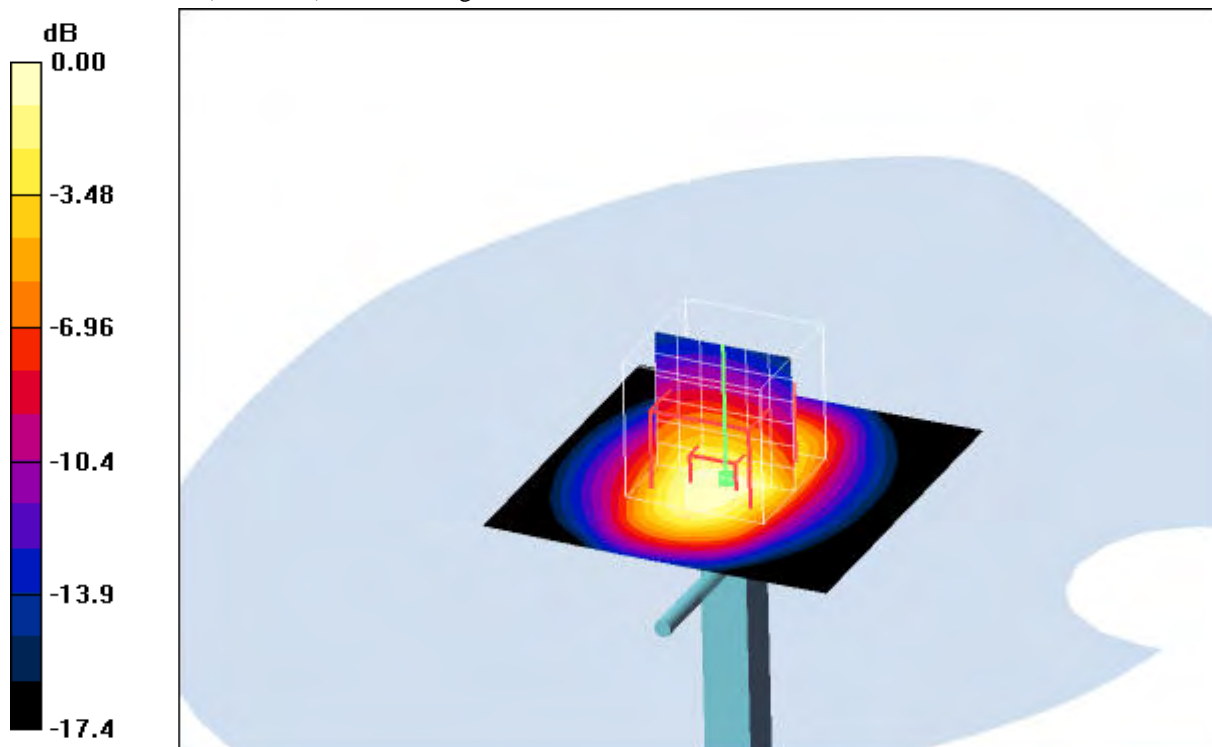

0 dB = 43.9mW/g

**Additional information:**

position or distance of DUT to SAM (if not standard head positions) :  
 ambient temperature: 22.5°C; liquid temperature: 21.1°C



Date/Time: 2009-03-25 08:57:42 Date/Time: 2009-03-25 09:01:20

**System Performance Check-D1900 body 2009-03-25**

**DUT: Dipole 1900 MHz; Type: D1900V2; Serial: D1900V2 - SN:531**

Communication System: CW; Frequency: 1900 MHz; Duty Cycle: 1:1

Medium: M1900 Medium parameters used (interpolated):  $f = 1900 \text{ MHz}$ ;  $\sigma = 1.48 \text{ mho/m}$ ;  $\epsilon_r = 53.1$ ;  $\rho = 1000 \text{ kg/m}^3$

Phantom section: Flat Section

DASY4 Configuration:

- Probe: ET3DV6 - SN1558; ConvF(4.39, 4.39, 4.39); Calibrated: 2008-08-15
- Sensor-Surface: 4mm (Mechanical And Optical Surface Detection)
- Electronics: DAE3 Sn413; Calibrated: 2009-01-08
- Phantom: SAM 12; Type: SAM; Serial: 1043
- Measurement SW: DASY4, V4.5 Build 19; Postprocessing SW: SEMCAD, V1.8 Build 146

**d=10mm, Pin=1000mW/Area Scan (51x51x1):** Measurement grid: dx=15mm, dy=15mm

Maximum value of SAR (interpolated) = 57.9 mW/g

**d=10mm, Pin=1000mW/Zoom Scan (7x7x7) (7x7x7)/Cube 0:** Measurement grid: dx=5mm, dy=5mm, dz=5mm

Reference Value = 183.8 V/m; Power Drift = -0.103 dB

Peak SAR (extrapolated) = 75.1 W/kg

**SAR(1 g) = 40.4 mW/g; SAR(10 g) = 21.3 mW/g**

Maximum value of SAR (measured) = 45.4 mW/g

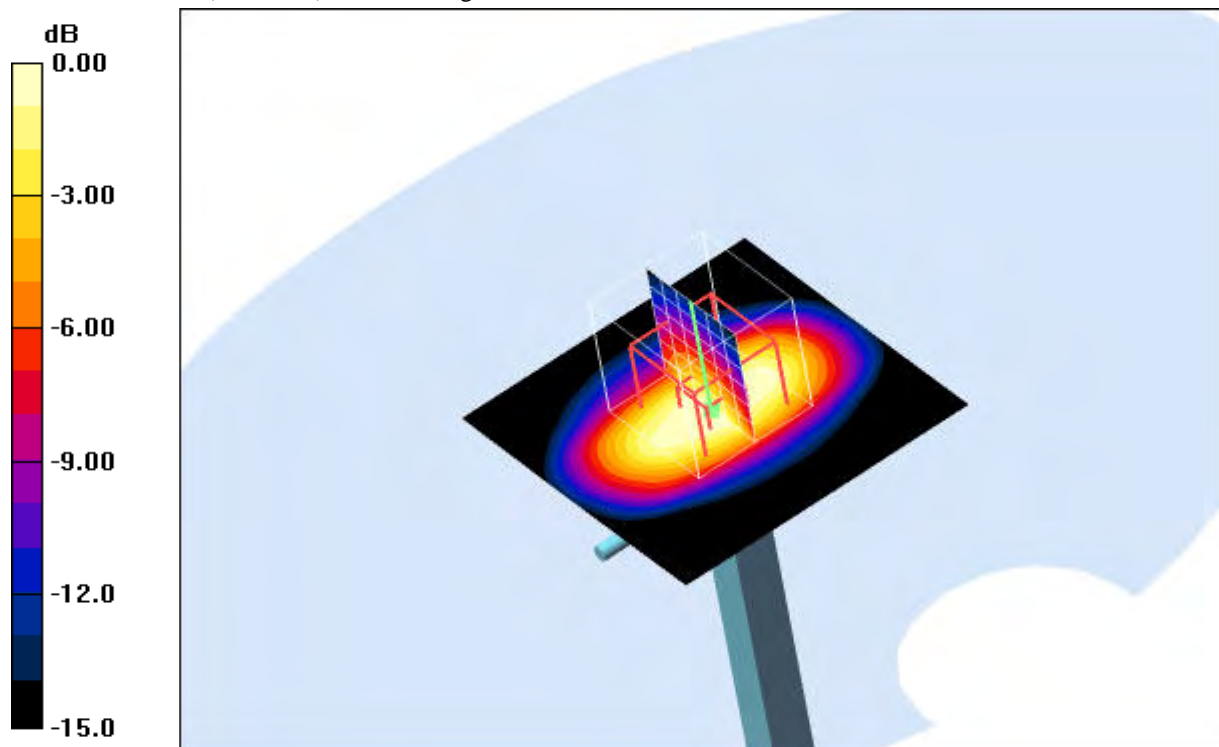

0 dB = 45.4mW/g

**Additional information:**

position or distance of DUT to SAM (if not standard head positions) :

ambient temperature: 21.9°C; liquid temperature: 21.3°C

**Annex 2 Measurement results (printout from DASY TM)**

**Remark: results of conducted power measurements: see chapter 2.5/2.6 (if applicable)**

**Annex 2.1 PCS 850 MHz head**

Date/Time: 2009-03-22 12:05:39 Date/Time: 2009-03-22 12:12:14

**P1528\_OET65-LeftHandSide-GSM850**

**DUT: Sony Ericsson; Type: AAD-3880008-BV; Serial: T261F007CD**

Communication System: PCS 850; Frequency: 824.2 MHz; Duty Cycle: 1:8

Medium: HSL850 Medium parameters used:  $f = 824.2 \text{ MHz}$ ;  $\sigma = 0.93 \text{ mho/m}$ ;  $\epsilon_r = 42.3$ ;  $\rho = 1000 \text{ kg/m}^3$

Phantom section: Left Section

DASY4 Configuration:

- Probe: ET3DV6 - SN1558; ConvF(6.19, 6.19, 6.19); Calibrated: 2008-08-15
- Sensor-Surface: 4mm (Mechanical And Optical Surface Detection)
- Electronics: DAE3 Sn413; Calibrated: 2009-01-08
- Phantom: SAM 12; Type: SAM; Serial: 1043
- Measurement SW: DASY4, V4.5 Build 19; Postprocessing SW: SEMCAD, V1.8 Build 146

**Touch position - Low/Area Scan (51x91x1):** Measurement grid:  $dx=15\text{mm}$ ,  $dy=15\text{mm}$

Maximum value of SAR (interpolated) = 1.06 mW/g

**Touch position - Low/Zoom Scan (7x7x7) (7x7x7)/Cube 0:** Measurement grid:  $dx=5\text{mm}$ ,  $dy=5\text{mm}$ ,  $dz=5\text{mm}$

Reference Value = 33.2 V/m; Power Drift = 0.00 dB

Peak SAR (extrapolated) = 1.38 W/kg

**SAR(1 g) = 0.915 mW/g; SAR(10 g) = 0.633 mW/g**

Maximum value of SAR (measured) = 0.965 mW/g

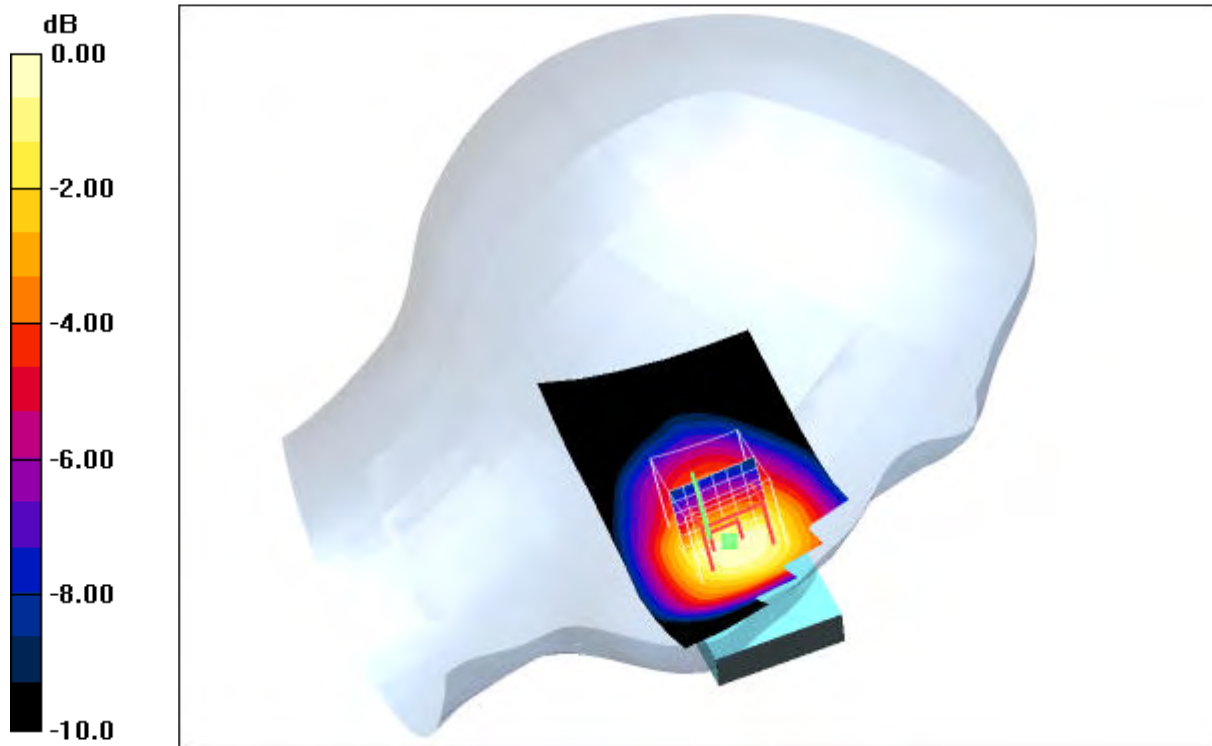

0 dB = 0.965mW/g

**Additional information:**

position or distance of DUT to SAM (if not standard head positions) :

ambient temperature: 21.9 °C; liquid temperature: 21.6 °C

Date/Time: 2009-03-22 12:27:49 Date/Time: 2009-03-22 12:36:13

**P1528\_OET65-LeftHandSide-GSM850**

**DUT: Sony Ericsson; Type: AAD-3880008-BV; Serial: T261F007CD**

Communication System: PCS 850; Frequency: 836.6 MHz; Duty Cycle: 1:8

Medium: HSL850 Medium parameters used:  $f = 836.6 \text{ MHz}$ ;  $\sigma = 0.93 \text{ mho/m}$ ;  $\epsilon_r = 42.3$ ;  $\rho = 1000 \text{ kg/m}^3$

Phantom section: Left Section

DASY4 Configuration:

- Probe: ET3DV6 - SN1558; ConvF(6.19, 6.19, 6.19); Calibrated: 2008-08-15
- Sensor-Surface: 4mm (Mechanical And Optical Surface Detection)
- Electronics: DAE3 Sn413; Calibrated: 2009-01-08
- Phantom: SAM 12; Type: SAM; Serial: 1043
- Measurement SW: DASY4, V4.5 Build 19; Postprocessing SW: SEMCAD, V1.8 Build 146

**Touch position - Middle/Area Scan (51x91x1):** Measurement grid:  $dx=15\text{mm}$ ,  $dy=15\text{mm}$   
 Maximum value of SAR (interpolated) = 1.30 mW/g

**Touch position - Middle/Zoom Scan (7x7x7) (7x7x7)/Cube 0:** Measurement grid:  $dx=5\text{mm}$ ,  $dy=5\text{mm}$ ,  $dz=5\text{mm}$

Reference Value = 36.6 V/m; Power Drift = 0.058 dB

Peak SAR (extrapolated) = 1.76 W/kg

**SAR(1 g) = 1.12 mW/g; SAR(10 g) = 0.770 mW/g**

Maximum value of SAR (measured) = 1.17 mW/g

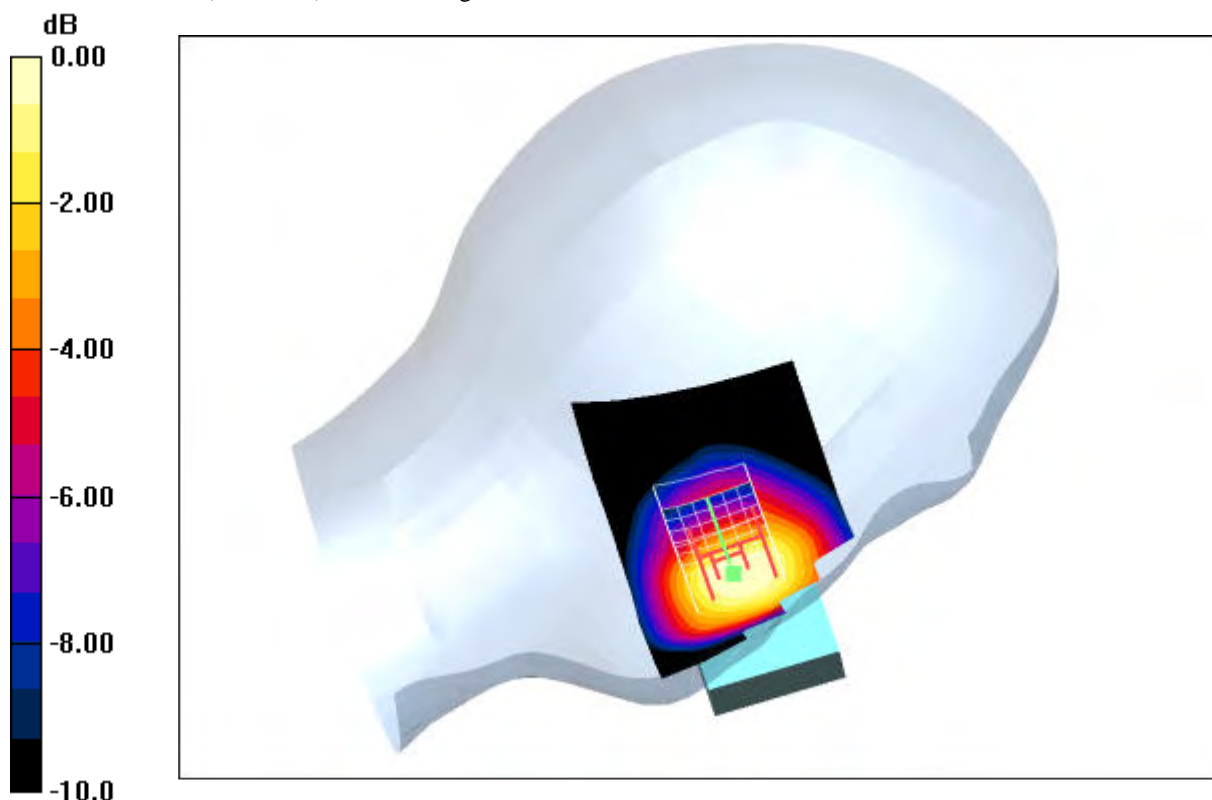

0 dB = 1.17mW/g

**Additional information:**

position or distance of DUT to SAM (if not standard head positions) :

ambient temperature: 21.9 °C; liquid temperature: 21.6 °C

Date/Time: 2009-03-22 12:54:42 Date/Time: 2009-03-22 13:01:53

**P1528\_OET65-LeftHandSide-GSM850**

**DUT: Sony Ericsson; Type: AAD-3880008-BV; Serial: T261F007CD**

Communication System: PCS 850; Frequency: 848.8 MHz; Duty Cycle: 1:8

Medium: HSL850 Medium parameters used:  $f = 848.8 \text{ MHz}$ ;  $\sigma = 0.93 \text{ mho/m}$ ;  $\epsilon_r = 42.3$ ;  $\rho = 1000 \text{ kg/m}^3$

Phantom section: Left Section

DASY4 Configuration:

- Probe: ET3DV6 - SN1558; ConvF(6.19, 6.19, 6.19); Calibrated: 2008-08-15
- Sensor-Surface: 4mm (Mechanical And Optical Surface Detection)
- Electronics: DAE3 Sn413; Calibrated: 2009-01-08
- Phantom: SAM 12; Type: SAM; Serial: 1043
- Measurement SW: DASY4, V4.5 Build 19; Postprocessing SW: SEMCAD, V1.8 Build 146

**Touch position - High/Area Scan (51x91x1):** Measurement grid:  $dx=15\text{mm}$ ,  $dy=15\text{mm}$

Maximum value of SAR (interpolated) = 1.73 mW/g

**Touch position - High/Zoom Scan (7x7x7) (7x7x7)/Cube 0:** Measurement grid:  $dx=5\text{mm}$ ,  $dy=5\text{mm}$ ,  $dz=5\text{mm}$

Reference Value = 42.2 V/m; Power Drift = -0.034 dB

Peak SAR (extrapolated) = 2.22 W/kg

**SAR(1 g) = 1.45 mW/g; SAR(10 g) = 1.01 mW/g**

Maximum value of SAR (measured) = 1.52 mW/g

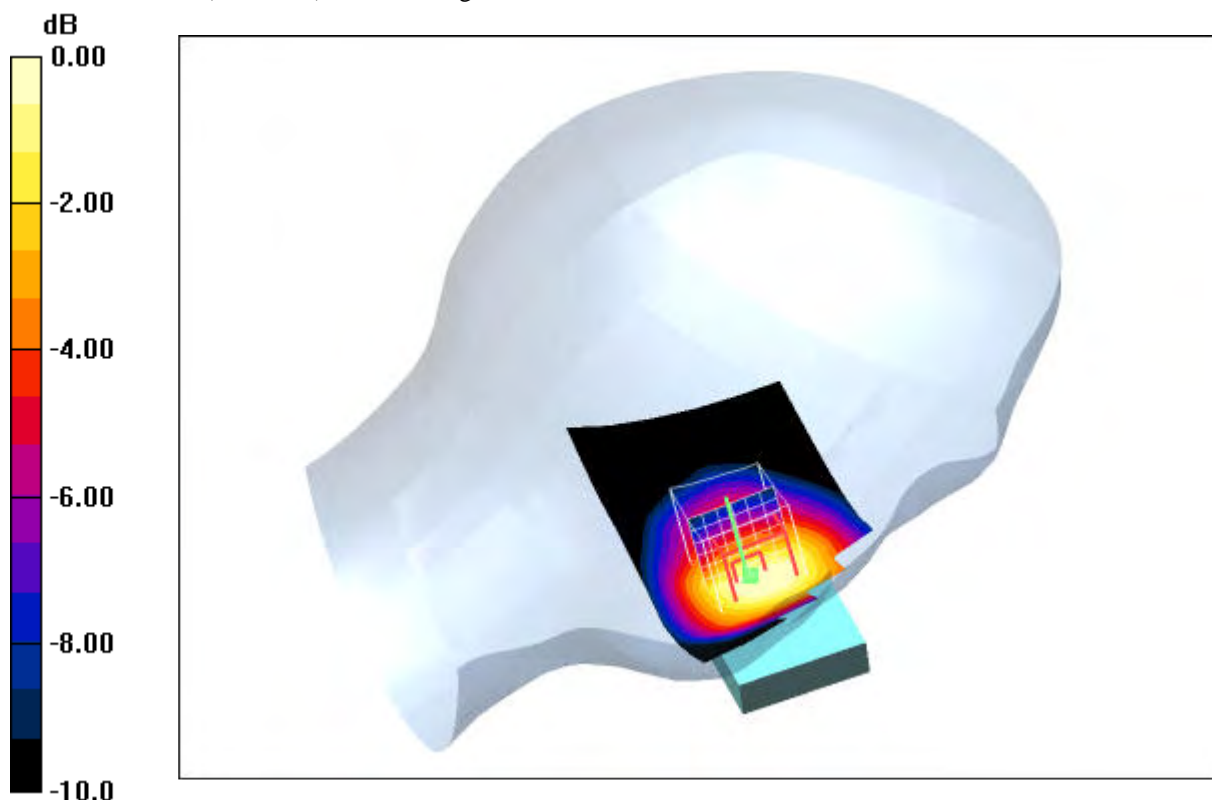

0 dB = 1.52mW/g

**Additional information:**

position or distance of DUT to SAM (if not standard head positions) :

ambient temperature: 21.9 °C; liquid temperature: 21.6 °C

Date/Time: 2009-03-22 14:37:55 Date/Time: 2009-03-22 14:45:49 Date/Time: 2009-03-22 14:58:29

**P1528\_OET65-LeftHandSide-GSM850**

**DUT: Sony Ericsson; Type: AAD-3880008-BV; Serial: T261F007CD**

Communication System: PCS 850; Frequency: 824.2 MHz; Duty Cycle: 1:8

Medium: HSL850 Medium parameters used:  $f = 824.2 \text{ MHz}$ ;  $\sigma = 0.93 \text{ mho/m}$ ;  $\epsilon_r = 42.3$ ;  $\rho = 1000 \text{ kg/m}^3$

Phantom section: Left Section

DASY4 Configuration:

- Probe: ET3DV6 - SN1558; ConvF(6.19, 6.19, 6.19); Calibrated: 2008-08-15
- Sensor-Surface: 4mm (Mechanical And Optical Surface Detection)
- Electronics: DAE3 Sn413; Calibrated: 2009-01-08
- Phantom: SAM 12; Type: SAM; Serial: 1043
- Measurement SW: DASY4, V4.5 Build 19; Postprocessing SW: SEMCAD, V1.8 Build 146

**Tilt position - Low/Area Scan (51x91x1):** Measurement grid:  $dx=15\text{mm}$ ,  $dy=15\text{mm}$   
 Maximum value of SAR (interpolated) = 0.428 mW/g

**Tilt position - Low/Zoom Scan (7x7x7) (7x7x7)/Cube 0:** Measurement grid:  $dx=5\text{mm}$ ,  $dy=5\text{mm}$ ,  $dz=5\text{mm}$

Reference Value = 21.8 V/m; Power Drift = -0.022 dB

Peak SAR (extrapolated) = 0.524 W/kg

**SAR(1 g) = 0.409 mW/g; SAR(10 g) = 0.300 mW/g**

Maximum value of SAR (measured) = 0.432 mW/g

**Tilt position - Low/Zoom Scan (7x7x7) (7x7x7)/Cube 1:** Measurement grid:  $dx=5\text{mm}$ ,  $dy=5\text{mm}$ ,  $dz=5\text{mm}$

Reference Value = 21.8 V/m; Power Drift = -0.022 dB

Peak SAR (extrapolated) = 0.427 W/kg

**SAR(1 g) = 0.291 mW/g; SAR(10 g) = 0.188 mW/g**

Maximum value of SAR (measured) = 0.352 mW/g

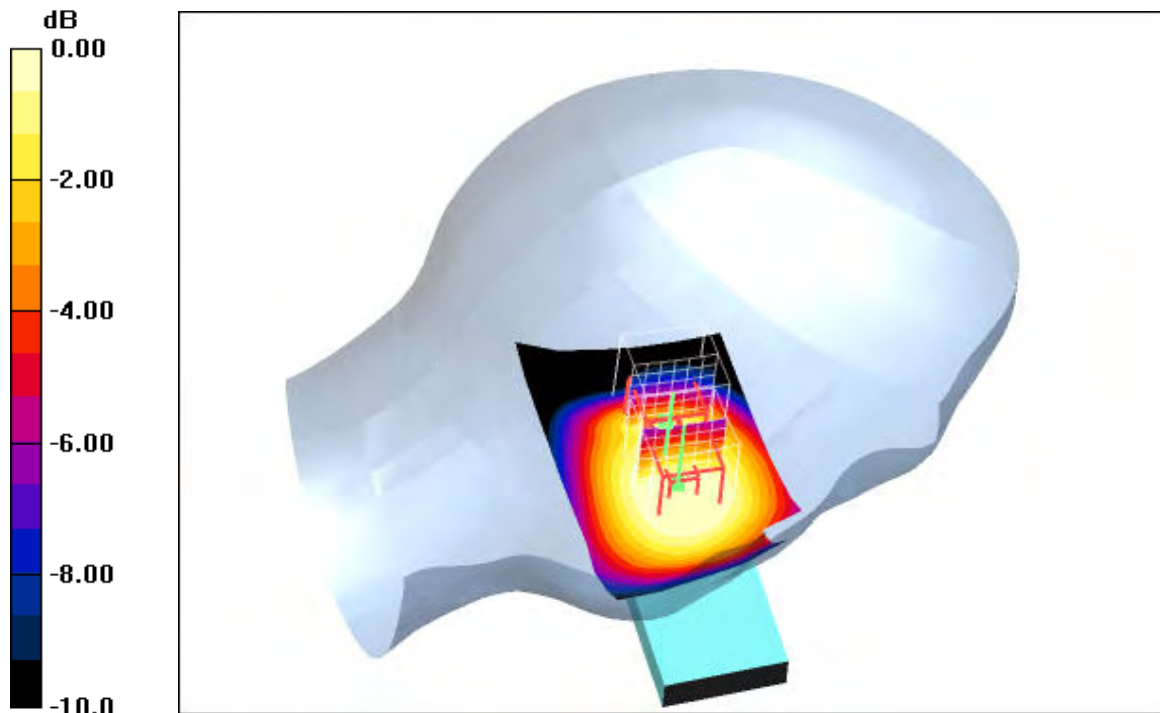

0 dB = 0.352mW/g

**Additional information:**

position or distance of DUT to SAM (if not standard head positions) :

ambient temperature: 22.6 °C; liquid temperature: 21.8 °C

Date/Time: 2009-03-22 13:58:26 Date/Time: 2009-03-22 14:05:57 Date/Time: 2009-03-22 14:20:35

**P1528\_OET65-LeftHandSide-GSM850**

**DUT: Sony Ericsson; Type: AAD-3880008-BV; Serial: T261F007CD**

Communication System: PCS 850; Frequency: 836.6 MHz; Duty Cycle: 1:8

Medium: HSL850 Medium parameters used:  $f = 836.6 \text{ MHz}$ ;  $\sigma = 0.93 \text{ mho/m}$ ;  $\epsilon_r = 42.3$ ;  $\rho = 1000 \text{ kg/m}^3$

Phantom section: Left Section

DASY4 Configuration:

- Probe: ET3DV6 - SN1558; ConvF(6.19, 6.19, 6.19); Calibrated: 2008-08-15
- Sensor-Surface: 4mm (Mechanical And Optical Surface Detection)
- Electronics: DAE3 Sn413; Calibrated: 2009-01-08
- Phantom: SAM 12; Type: SAM; Serial: 1043
- Measurement SW: DASY4, V4.5 Build 19; Postprocessing SW: SEMCAD, V1.8 Build 146

**Tilt position - Middle/Area Scan (51x91x1):** Measurement grid:  $dx=15\text{mm}$ ,  $dy=15\text{mm}$

Maximum value of SAR (interpolated) = 0.493 mW/g

**Tilt position - Middle/Zoom Scan (7x7x7) (7x7x7)/Cube 0:** Measurement grid:  $dx=5\text{mm}$ ,  $dy=5\text{mm}$ ,  $dz=5\text{mm}$

Reference Value = 23.5 V/m; Power Drift = -0.054 dB

Peak SAR (extrapolated) = 0.607 W/kg

**SAR(1 g) = 0.476 mW/g; SAR(10 g) = 0.347 mW/g**

Maximum value of SAR (measured) = 0.503 mW/g

**Tilt position - Middle/Zoom Scan (7x7x7) (7x7x7)/Cube 1:** Measurement grid:  $dx=5\text{mm}$ ,  $dy=5\text{mm}$ ,  $dz=5\text{mm}$

Reference Value = 23.5 V/m; Power Drift = -0.054 dB

Peak SAR (extrapolated) = 0.530 W/kg

**SAR(1 g) = 0.358 mW/g; SAR(10 g) = 0.229 mW/g**

Maximum value of SAR (measured) = 0.427 mW/g

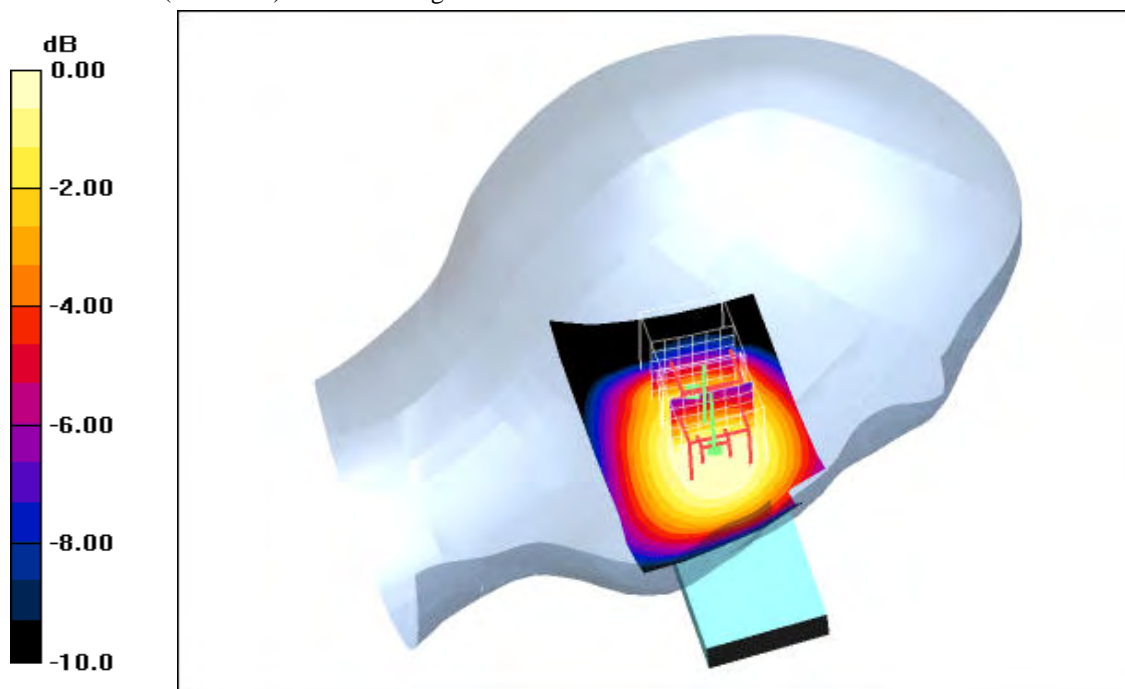

0 dB = 0.427mW/g

**Additional information:**

position or distance of DUT to SAM (if not standard head positions) :

ambient temperature: 22.6 °C; liquid temperature: 21.8 °C

Date/Time: 2009-03-22 13:17:31 Date/Time: 2009-03-22 13:25:35 Date/Time: 2009-03-22 13:38:27

**P1528\_OET65-LeftHandSide-GSM850**

**DUT: Sony Ericsson; Type: AAD-3880008-BV; Serial: T261F007CD**

Communication System: PCS 850; Frequency: 848.8 MHz; Duty Cycle: 1:8

Medium: HSL850 Medium parameters used:  $f = 848.8 \text{ MHz}$ ;  $\sigma = 0.93 \text{ mho/m}$ ;  $\epsilon_r = 42.3$ ;  $\rho = 1000 \text{ kg/m}^3$

Phantom section: Left Section

DASY4 Configuration:

- Probe: ET3DV6 - SN1558; ConvF(6.19, 6.19, 6.19); Calibrated: 2008-08-15
- Sensor-Surface: 4mm (Mechanical And Optical Surface Detection)
- Electronics: DAE3 Sn413; Calibrated: 2009-01-08
- Phantom: SAM 12; Type: SAM; Serial: 1043
- Measurement SW: DASY4, V4.5 Build 19; Postprocessing SW: SEMCAD, V1.8 Build 146

**Tilt position - High/Area Scan (51x91x1):** Measurement grid:  $dx=15\text{mm}$ ,  $dy=15\text{mm}$

Maximum value of SAR (interpolated) = 0.623 mW/g

**Tilt position - High/Zoom Scan (7x7x7) (7x7x7)/Cube 0:** Measurement grid:  $dx=5\text{mm}$ ,  $dy=5\text{mm}$ ,  $dz=5\text{mm}$

Reference Value = 26.4 V/m; Power Drift = -0.015 dB

Peak SAR (extrapolated) = 0.767 W/kg

**SAR(1 g) = 0.597 mW/g; SAR(10 g) = 0.433 mW/g**

Maximum value of SAR (measured) = 0.631 mW/g

**Tilt position - High/Zoom Scan (7x7x7) (7x7x7)/Cube 1:** Measurement grid:  $dx=5\text{mm}$ ,  $dy=5\text{mm}$ ,  $dz=5\text{mm}$

Reference Value = 26.4 V/m; Power Drift = -0.015 dB

Peak SAR (extrapolated) = 0.629 W/kg

**SAR(1 g) = 0.424 mW/g; SAR(10 g) = 0.272 mW/g**

Maximum value of SAR (measured) = 0.512 mW/g

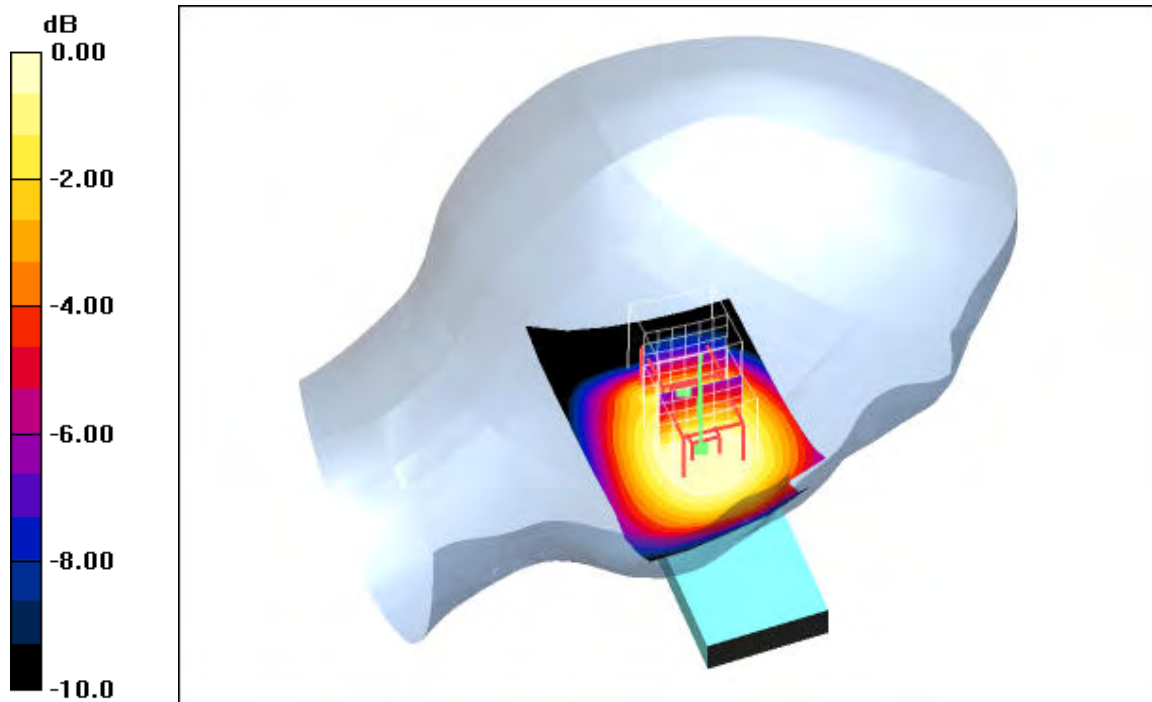

0 dB = 0.512mW/g

**Additional information:**

position or distance of DUT to SAM (if not standard head positions) :

ambient temperature: 22.6 °C; liquid temperature: 21.8 °C

Date/Time: 2009-03-22 15:16:01 Date/Time: 2009-03-22 15:23:52

**P1528\_OET65-RightHandSide-GSM850**

**DUT: Sony Ericsson; Type: AAD-3880008-BV; Serial: T261F007CD**

Communication System: PCS 850; Frequency: 824.2 MHz; Duty Cycle: 1:8

Medium: HSL850 Medium parameters used:  $f = 824.2 \text{ MHz}$ ;  $\sigma = 0.93 \text{ mho/m}$ ;  $\epsilon_r = 42.3$ ;  $\rho = 1000 \text{ kg/m}^3$

Phantom section: Right Section

DASY4 Configuration:

- Probe: ET3DV6 - SN1558; ConvF(6.19, 6.19, 6.19); Calibrated: 2008-08-15
- Sensor-Surface: 4mm (Mechanical And Optical Surface Detection)
- Electronics: DAE3 Sn413; Calibrated: 2009-01-08
- Phantom: SAM 12; Type: SAM; Serial: 1043
- Measurement SW: DASY4, V4.5 Build 19; Postprocessing SW: SEMCAD, V1.8 Build 146

**Touch position - Low/Area Scan (51x91x1):** Measurement grid:  $dx=15\text{mm}$ ,  $dy=15\text{mm}$

Maximum value of SAR (interpolated) = 0.941 mW/g

**Touch position - Low/Zoom Scan (7x7x7) (7x7x7)/Cube 0:** Measurement grid:  $dx=5\text{mm}$ ,  $dy=5\text{mm}$ ,  $dz=5\text{mm}$

Reference Value = 32.8 V/m; Power Drift = 0.061 dB

Peak SAR (extrapolated) = 1.33 W/kg

**SAR(1 g) = 0.887 mW/g; SAR(10 g) = 0.592 mW/g**

Maximum value of SAR (measured) = 0.940 mW/g

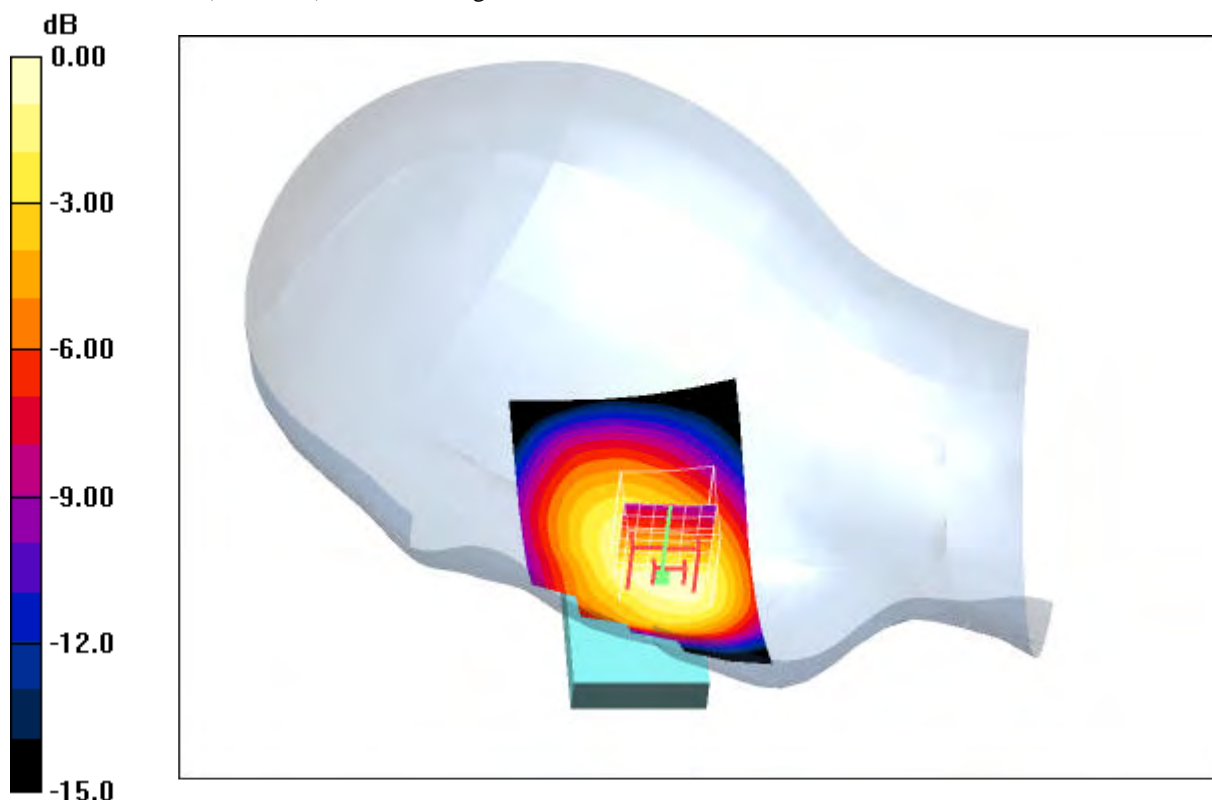

0 dB = 0.940mW/g

**Additional information:**

position or distance of DUT to SAM (if not standard head positions) :

ambient temperature: 22.0 °C; liquid temperature: 21.1 °C



Date/Time: 2009-03-22 15:38:40 Date/Time: 2009-03-22 15:46:04

**P1528\_OET65-RightHandSide-GSM850**

**DUT: Sony Ericsson; Type: AAD-3880008-BV; Serial: T261F007CD**

Communication System: PCS 850; Frequency: 836.6 MHz; Duty Cycle: 1:8

Medium: HSL850 Medium parameters used:  $f = 836.6 \text{ MHz}$ ;  $\sigma = 0.93 \text{ mho/m}$ ;  $\epsilon_r = 42.3$ ;  $\rho = 1000 \text{ kg/m}^3$

Phantom section: Right Section

DASY4 Configuration:

- Probe: ET3DV6 - SN1558; ConvF(6.19, 6.19, 6.19); Calibrated: 2008-08-15
- Sensor-Surface: 4mm (Mechanical And Optical Surface Detection)
- Electronics: DAE3 Sn413; Calibrated: 2009-01-08
- Phantom: SAM 12; Type: SAM; Serial: 1043
- Measurement SW: DASY4, V4.5 Build 19; Postprocessing SW: SEMCAD, V1.8 Build 146

**Touch position - Middle/Area Scan (51x91x1):** Measurement grid:  $dx=15\text{mm}$ ,  $dy=15\text{mm}$

Maximum value of SAR (interpolated) = 1.12 mW/g

**Touch position - Middle/Zoom Scan (7x7x7) (7x7x7)/Cube 0:** Measurement grid:  $dx=5\text{mm}$ ,  $dy=5\text{mm}$ ,

$dz=5\text{mm}$

Reference Value = 35.8 V/m; Power Drift = 0.042 dB

Peak SAR (extrapolated) = 1.62 W/kg

**SAR(1 g) = 1.06 mW/g; SAR(10 g) = 0.700 mW/g**

Maximum value of SAR (measured) = 1.12 mW/g

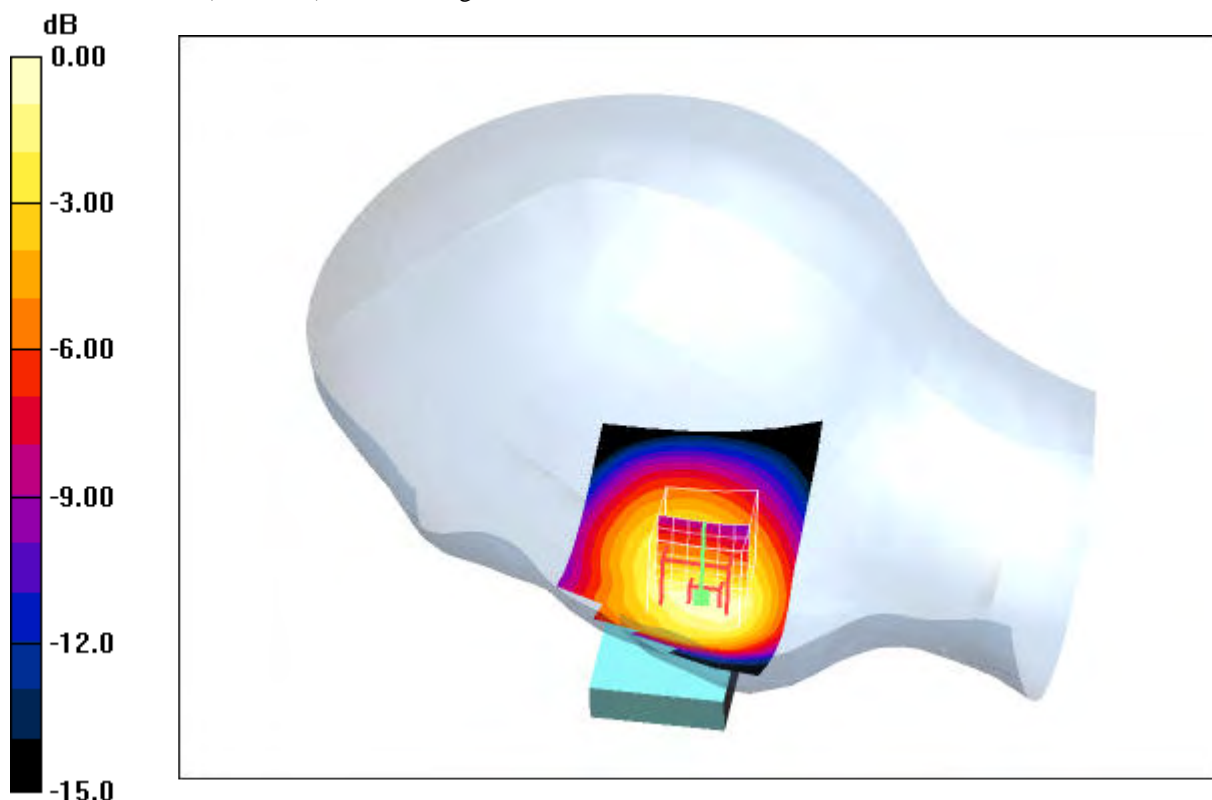

0 dB = 1.12mW/g

**Additional information:**

position or distance of DUT to SAM (if not standard head positions) :

ambient temperature: 22.0 °C; liquid temperature: 21.7 °C

Date/Time: 2009-03-22 16:01:35 Date/Time: 2009-03-22 16:07:55

**P1528\_OET65-RightHandSide-GSM850**

**DUT: Sony Ericsson; Type: AAD-3880008-BV; Serial: T261F007CD**

Communication System: PCS 850; Frequency: 848.8 MHz; Duty Cycle: 1:8

Medium: HSL850 Medium parameters used:  $f = 848.8 \text{ MHz}$ ;  $\sigma = 0.93 \text{ mho/m}$ ;  $\epsilon_r = 42.3$ ;  $\rho = 1000 \text{ kg/m}^3$

Phantom section: Right Section

DASY4 Configuration:

- Probe: ET3DV6 - SN1558; ConvF(6.19, 6.19, 6.19); Calibrated: 2008-08-15
- Sensor-Surface: 4mm (Mechanical And Optical Surface Detection)
- Electronics: DAE3 Sn413; Calibrated: 2009-01-08
- Phantom: SAM 12; Type: SAM; Serial: 1043
- Measurement SW: DASY4, V4.5 Build 19; Postprocessing SW: SEMCAD, V1.8 Build 146

**Touch position - High/Area Scan (51x91x1):** Measurement grid:  $dx=15\text{mm}$ ,  $dy=15\text{mm}$

Maximum value of SAR (interpolated) = 1.47 mW/g

**Touch position - High/Zoom Scan (7x7x7) (7x7x7)/Cube 0:** Measurement grid:  $dx=5\text{mm}$ ,  $dy=5\text{mm}$ ,  $dz=5\text{mm}$

Reference Value = 41.2 V/m; Power Drift = 0.00 dB

Peak SAR (extrapolated) = 2.15 W/kg

**SAR(1 g) = 1.38 mW/g; SAR(10 g) = 0.919 mW/g**

Maximum value of SAR (measured) = 1.46 mW/g

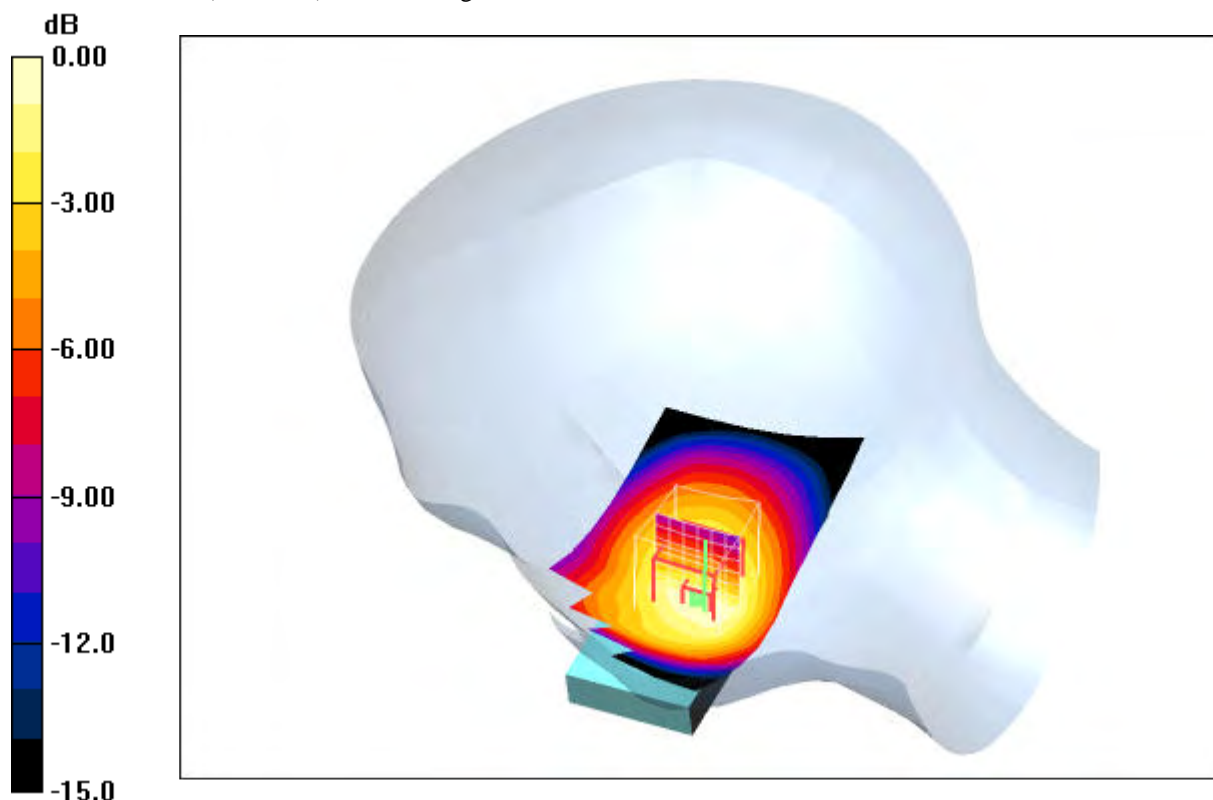

0 dB = 1.46mW/g

**Additional information:**

position or distance of DUT to SAM (if not standard head positions) :

ambient temperature: 22.0 °C; liquid temperature: 21.7 °C

Date/Time: 2009-03-22 16:26:16 Date/Time: 2009-03-22 16:32:49 Date/Time: 2009-03-22 16:44:56

**P1528\_OET65-RightHandSide-GSM850**

**DUT: Sony Ericsson; Type: AAD-3880008-BV; Serial: T261F007CD**

Communication System: PCS 850; Frequency: 824.2 MHz; Duty Cycle: 1:8

Medium: HSL850 Medium parameters used:  $f = 824.2 \text{ MHz}$ ;  $\sigma = 0.93 \text{ mho/m}$ ;  $\epsilon_r = 42.3$ ;  $\rho = 1000 \text{ kg/m}^3$

Phantom section: Right Section

DASY4 Configuration:

- Probe: ET3DV6 - SN1558; ConvF(6.19, 6.19, 6.19); Calibrated: 2008-08-15
- Sensor-Surface: 4mm (Mechanical And Optical Surface Detection)
- Electronics: DAE3 Sn413; Calibrated: 2009-01-08
- Phantom: SAM 12; Type: SAM; Serial: 1043
- Measurement SW: DASY4, V4.5 Build 19; Postprocessing SW: SEMCAD, V1.8 Build 146

**Tilt position - Low/Area Scan (51x91x1):** Measurement grid:  $dx=15\text{mm}$ ,  $dy=15\text{mm}$   
 Maximum value of SAR (interpolated) = 0.466 mW/g

**Tilt position - Low/Zoom Scan (7x7x7) (7x7x7)/Cube 0:** Measurement grid:  $dx=5\text{mm}$ ,  $dy=5\text{mm}$ ,  $dz=5\text{mm}$   
 Reference Value = 22.6 V/m; Power Drift = 0.044 dB  
 Peak SAR (extrapolated) = 0.573 W/kg  
**SAR(1 g) = 0.443 mW/g; SAR(10 g) = 0.321 mW/g**  
 Maximum value of SAR (measured) = 0.469 mW/g

**Tilt position - Low/Zoom Scan (7x7x7) (7x7x7)/Cube 1:** Measurement grid:  $dx=5\text{mm}$ ,  $dy=5\text{mm}$ ,  $dz=5\text{mm}$   
 Reference Value = 22.6 V/m; Power Drift = 0.044 dB  
 Peak SAR (extrapolated) = 0.458 W/kg  
**SAR(1 g) = 0.305 mW/g; SAR(10 g) = 0.194 mW/g**  
 Maximum value of SAR (measured) = 0.366 mW/g

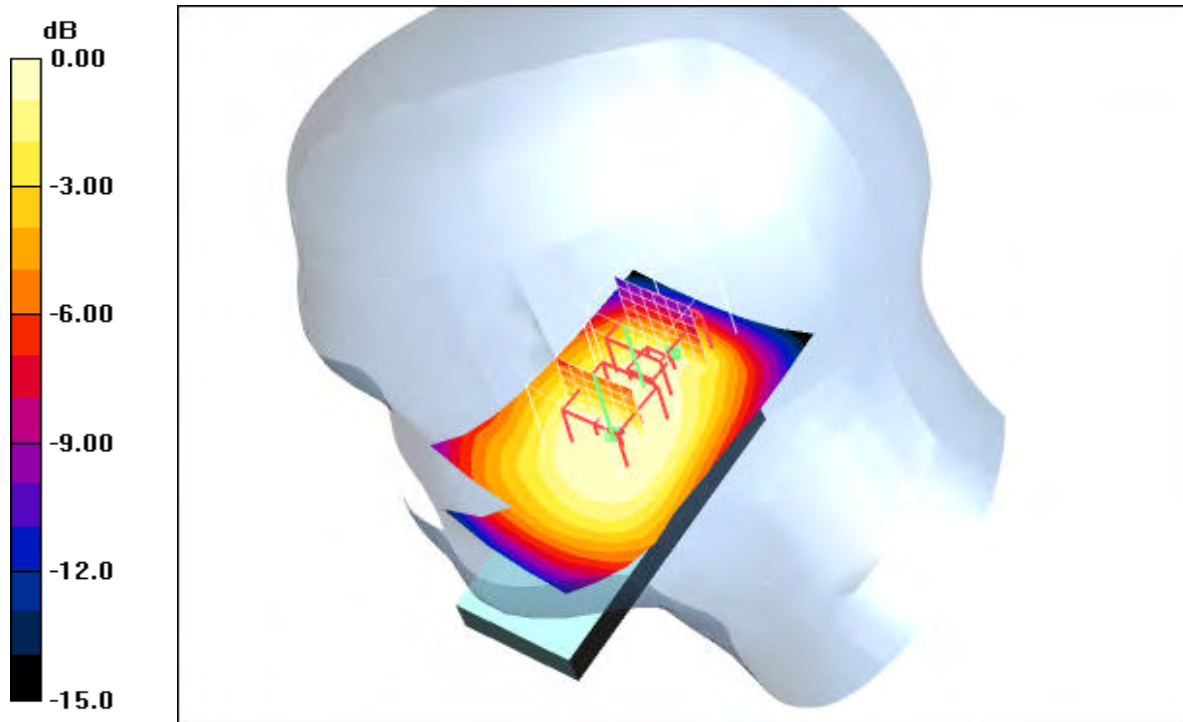

0 dB = 0.366mW/g

**Additional information:**

position or distance of DUT to SAM (if not standard head positions) :  
 ambient temperature: 22.0°C; liquid temperature: 21.5°C

Date/Time: 2009-03-22 16:58:46 Date/Time: 2009-03-22 17:05:25 Date/Time: 2009-03-22 17:17:24

**P1528\_OET65-RightHandSide-GSM850**

**DUT: Sony Ericsson; Type: AAD-3880008-BV; Serial: T261F007CD**

Communication System: PCS 850; Frequency: 836.6 MHz; Cycle: 1:8

Medium: HSL850 Medium parameters used:  $f = 836.6 \text{ MHz}$ ;  $\sigma = 0.93 \text{ mho/m}$ ;  $\epsilon_r = 42.3$ ;  $\rho = 1000 \text{ kg/m}^3$

Phantom section: Right Section

DASY4 Configuration:

- Probe: ET3DV6 - SN1558; ConvF(6.19, 6.19, 6.19); Calibrated: 2008-08-15
- Sensor-Surface: 4mm (Mechanical And Optical Surface Detection)
- Electronics: DAE3 Sn413; Calibrated: 2009-01-08
- Phantom: SAM 12; Type: SAM; Serial: 1043
- Measurement SW: DASY4, V4.5 Build 19; Postprocessing SW: SEMCAD, V1.8 Build 146

**Tilt position - Middle/Area Scan (51x91x1):** Measurement grid:  $dx=15\text{mm}$ ,  $dy=15\text{mm}$

Maximum value of SAR (interpolated) = 0.523 mW/g

**Tilt position - Middle/Zoom Scan (7x7x7) (7x7x7)/Cube 0:** Measurement grid:  $dx=5\text{mm}$ ,  $dy=5\text{mm}$ ,  $dz=5\text{mm}$

Reference Value = 23.8 V/m; Power Drift = 0.00 dB

Peak SAR (extrapolated) = 0.635 W/kg

**SAR(1 g) = 0.497 mW/g; SAR(10 g) = 0.361 mW/g**

Maximum value of SAR (measured) = 0.530 mW/g

**Tilt position - Middle/Zoom Scan (7x7x7) (7x7x7)/Cube 1:** Measurement grid:  $dx=5\text{mm}$ ,  $dy=5\text{mm}$ ,  $dz=5\text{mm}$

Reference Value = 23.8 V/m; Power Drift = 0.00 dB

Peak SAR (extrapolated) = 0.512 W/kg

**SAR(1 g) = 0.345 mW/g; SAR(10 g) = 0.223 mW/g**

Maximum value of SAR (measured) = 0.413 mW/g

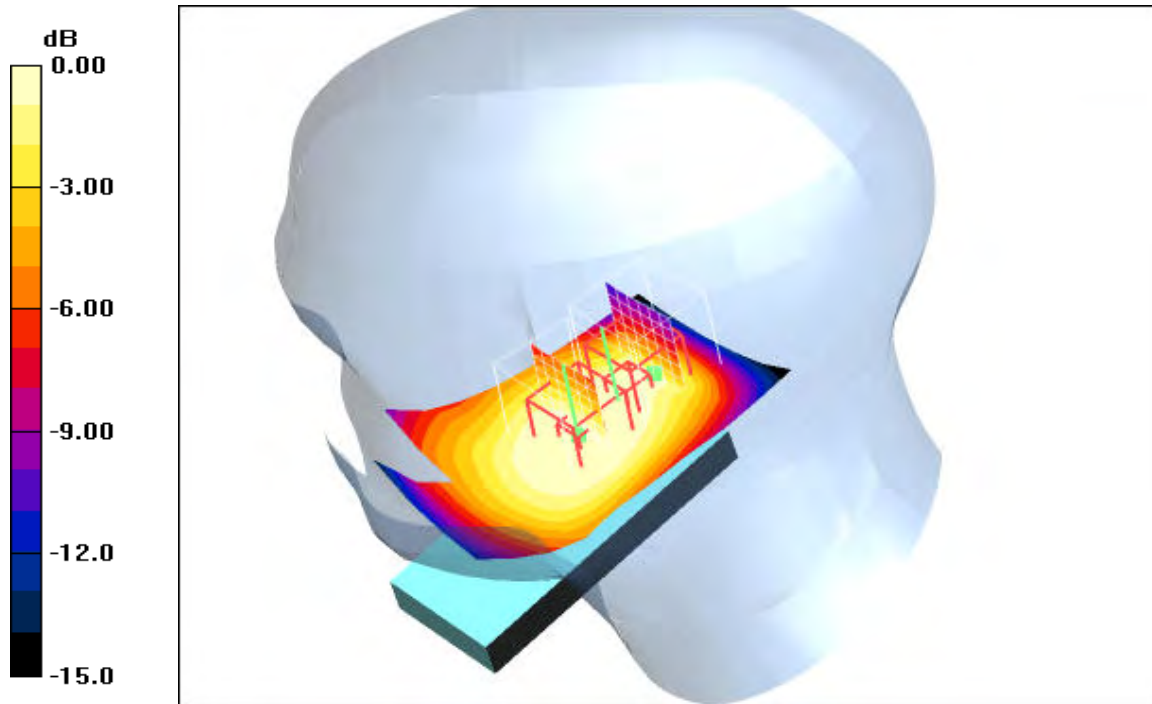

0 dB = 0.413mW/g

**Additional information:**

position or distance of DUT to SAM (if not standard head positions) :

ambient temperature: 22.0°C; liquid temperature: 21.5°C

Date/Time: 2009-03-22 17:31:38 Date/Time: 2009-03-22 17:38:35 Date/Time: 2009-03-22 17:50:47

**P1528\_OET65-RightHandSide-GSM850**

**DUT: Sony Ericsson; Type: AAD-3880008-BV; Serial: T261F007CD**

Communication System: PCS 850; Frequency: 848.8 MHz; Duty Cycle: 1:8

Medium: HSL850 Medium parameters used:  $f = 848.8 \text{ MHz}$ ;  $\sigma = 0.93 \text{ mho/m}$ ;  $\epsilon_r = 42.3$ ;  $\rho = 1000 \text{ kg/m}^3$

Phantom section: Right Section

DASY4 Configuration:

- Probe: ET3DV6 - SN1558; ConvF(6.19, 6.19, 6.19); Calibrated: 2008-08-15
- Sensor-Surface: 4mm (Mechanical And Optical Surface Detection)
- Electronics: DAE3 Sn413; Calibrated: 2009-01-08
- Phantom: SAM 12; Type: SAM; Serial: 1043
- Measurement SW: DASY4, V4.5 Build 19; Postprocessing SW: SEMCAD, V1.8 Build 146

**Tilt position - High/Area Scan (51x91x1):** Measurement grid:  $dx=15\text{mm}$ ,  $dy=15\text{mm}$

Maximum value of SAR (interpolated) = 0.656 mW/g

**Tilt position - High/Zoom Scan (7x7x7) (7x7x7)/Cube 0:** Measurement grid:  $dx=5\text{mm}$ ,  $dy=5\text{mm}$ ,  $dz=5\text{mm}$

Reference Value = 26.8 V/m; Power Drift = -0.022 dB

Peak SAR (extrapolated) = 0.799 W/kg

**SAR(1 g) = 0.617 mW/g; SAR(10 g) = 0.445 mW/g**

Maximum value of SAR (measured) = 0.659 mW/g

**Tilt position - High/Zoom Scan (7x7x7) (7x7x7)/Cube 1:** Measurement grid:  $dx=5\text{mm}$ ,  $dy=5\text{mm}$ ,  $dz=5\text{mm}$

Reference Value = 26.8 V/m; Power Drift = -0.022 dB

Peak SAR (extrapolated) = 0.628 W/kg

**SAR(1 g) = 0.426 mW/g; SAR(10 g) = 0.275 mW/g**

Maximum value of SAR (measured) = 0.506 mW/g

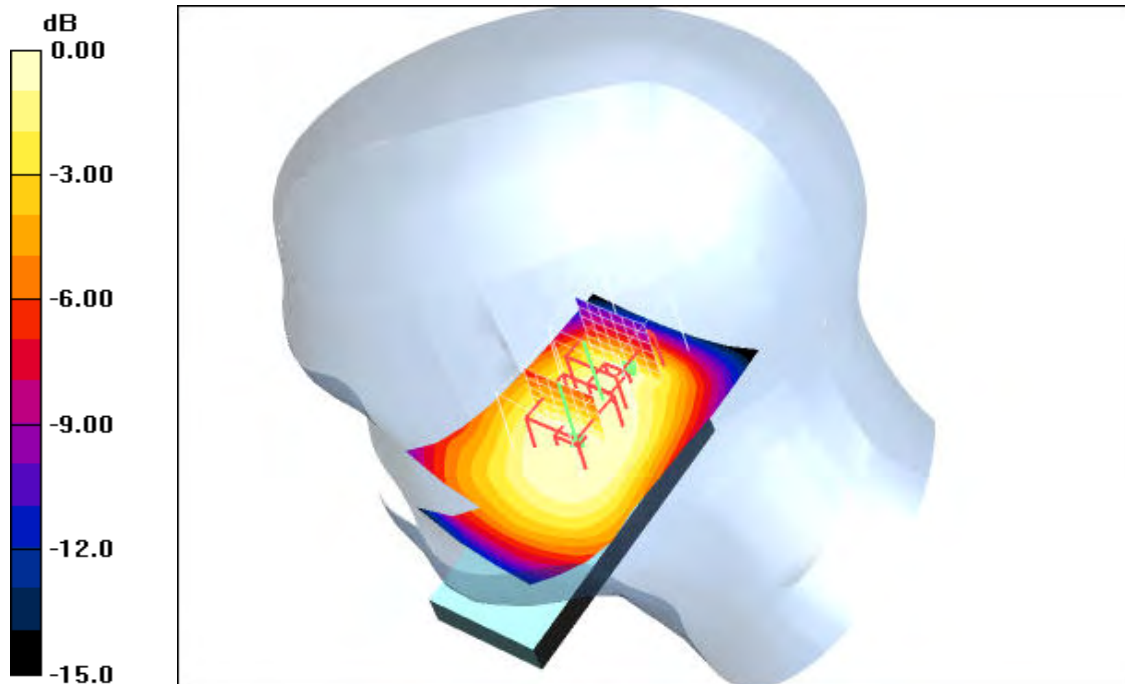

0 dB = 0.506mW/g

**Additional information:**

position or distance of DUT to SAM (if not standard head positions) :

ambient temperature: 22.0°C; liquid temperature: 21.5°C

**Annex 2.2 PCS 850 MHz body**

Date/Time: 2009-04-02 14:38:17 Date/Time: 2009-04-02 14:44:22

**P1528\_OET65-Body-GSM850 GPRS 2TS**

**DUT: Sony Ericsson; Type: AAD-3880008-BV; Serial: T261F007CD**

Communication System: PCS 850 GPRS 2TS; Frequency: 824.2 MHz; Duty Cycle: 1:4

Medium: M850 Medium parameters used:  $f = 824.2 \text{ MHz}$ ;  $\sigma = 0.99 \text{ mho/m}$ ;  $\epsilon_r = 54.3$ ;  $\rho = 1000 \text{ kg/m}^3$

Phantom section: Flat Section

DASY4 Configuration:

- Probe: ET3DV6 - SN1558; ConvF(5.96, 5.96, 5.96); Calibrated: 2008-08-15
- Sensor-Surface: 4mm (Mechanical And Optical Surface Detection)
- Electronics: DAE3 Sn413; Calibrated: 2009-01-08
- Phantom: SAM 12; Type: SAM; Serial: 1043
- Measurement SW: DASY4, V4.5 Build 19; Postprocessing SW: SEMCAD, V1.8 Build 146

**Front position - Low/Area Scan (51x81x1):** Measurement grid:  $dx=15\text{mm}$ ,  $dy=15\text{mm}$

Maximum value of SAR (interpolated) = 0.696 mW/g

**Front position - Low/Zoom Scan (7x7x7) (7x7x7)/Cube 0:** Measurement grid:  $dx=5\text{mm}$ ,  $dy=5\text{mm}$ ,  $dz=5\text{mm}$

Reference Value = 27.4 V/m; Power Drift = 0.023 dB

Peak SAR (extrapolated) = 0.894 W/kg

**SAR(1 g) = 0.662 mW/g; SAR(10 g) = 0.478 mW/g**

Maximum value of SAR (measured) = 0.701 mW/g

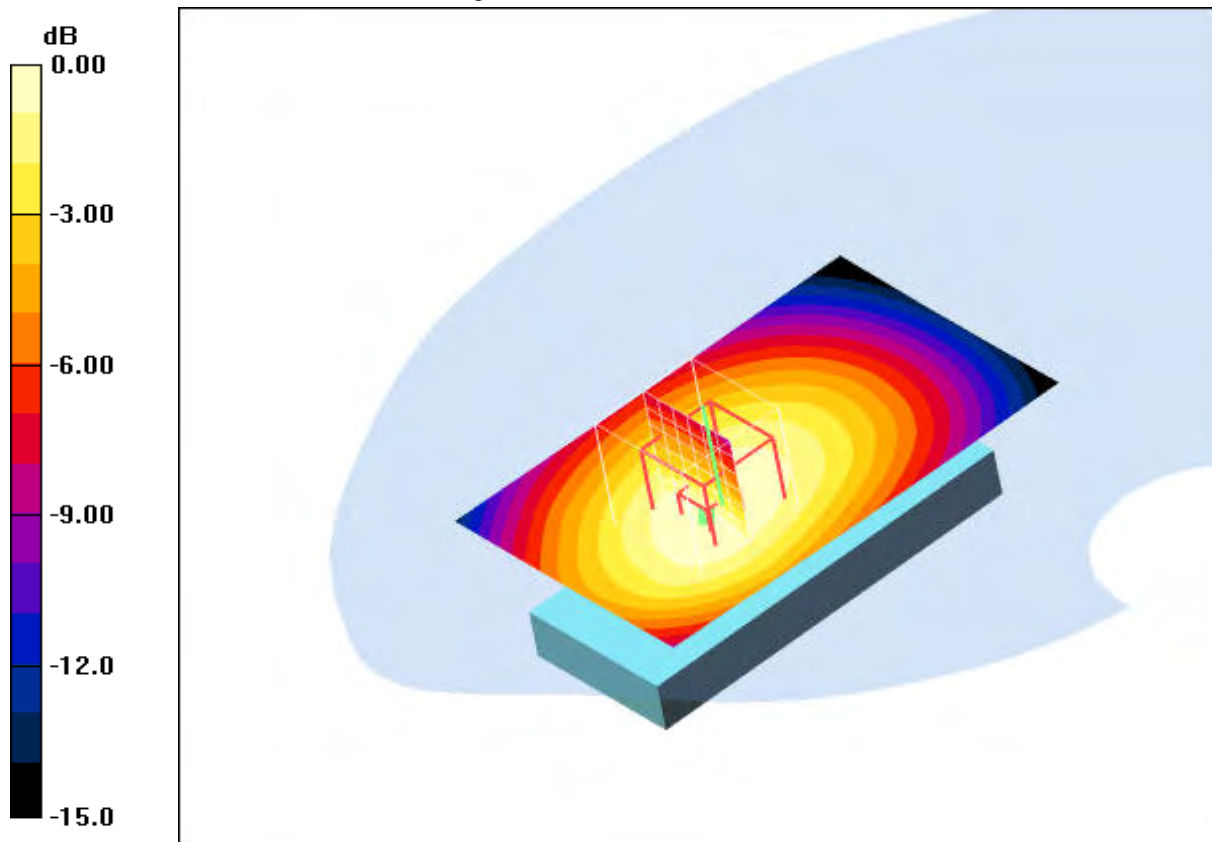

0 dB = 0.701mW/g

**Additional information:**

position or distance of DUT to SAM : 15 mm

ambient temperature: 22.6°C; liquid temperature: 21.5°C

Date/Time: 2009-04-02 14:17:30 Date/Time: 2009-04-02 14:23:35

**P1528\_OET65-Body-GSM850 GPRS 2TS**

**DUT: Sony Ericsson; Type: AAD-3880008-BV; Serial: T261F007CD**

Communication System: PCS 850 GPRS 2TS; Frequency: 836.6 MHz; Duty Cycle: 1:4

Medium: M850 Medium parameters used:  $f = 836.6 \text{ MHz}$ ;  $\sigma = 0.99 \text{ mho/m}$ ;  $\epsilon_r = 54.3$ ;  $\rho = 1000 \text{ kg/m}^3$

Phantom section: Flat Section

DASY4 Configuration:

- Probe: ET3DV6 - SN1558; ConvF(5.96, 5.96, 5.96); Calibrated: 2008-08-15
- Sensor-Surface: 4mm (Mechanical And Optical Surface Detection)
- Electronics: DAE3 Sn413; Calibrated: 2009-01-08
- Phantom: SAM 12; Type: SAM; Serial: 1043
- Measurement SW: DASY4, V4.5 Build 19; Postprocessing SW: SEMCAD, V1.8 Build 146

**Front position - Middle/Area Scan (51x81x1):** Measurement grid:  $dx=15\text{mm}$ ,  $dy=15\text{mm}$

Maximum value of SAR (interpolated) = 0.859 mW/g

**Front position - Middle/Zoom Scan (7x7x7) (7x7x7)/Cube 0:** Measurement grid:  $dx=5\text{mm}$ ,  $dy=5\text{mm}$ ,  $dz=5\text{mm}$

Reference Value = 30.5 V/m; Power Drift = 0.021 dB

Peak SAR (extrapolated) = 1.09 W/kg

SAR(1 g) = 0.813 mW/g; SAR(10 g) = 0.585 mW/g

Maximum value of SAR (measured) = 0.863 mW/g

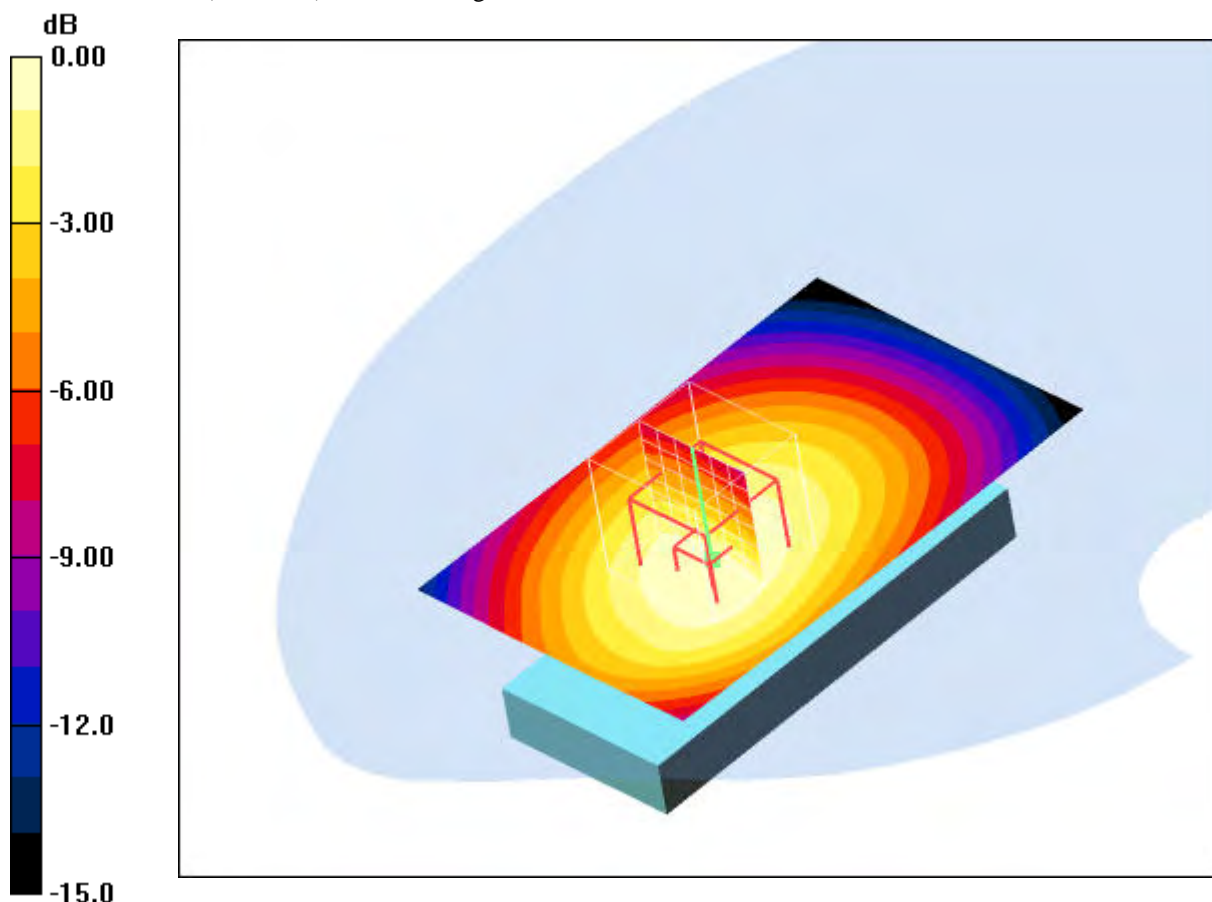

0 dB = 0.863mW/g

**Additional information:**

position or distance of DUT to SAM : 15 mm

ambient temperature: 22.6°C; liquid temperature: 21.5°C

Date/Time: 2009-04-02 13:39:24 Date/Time: 2009-04-02 14:03:10

**P1528\_OET65-Body-GSM850 GPRS 2TS**

**DUT: Sony Ericsson; Type: AAD-3880008-BV; Serial: T261F007CD**

Communication System: PCS 850 GPRS 2TS; Frequency: 848.8 MHz; Duty Cycle: 1:4

Medium: M850 Medium parameters used:  $f = 848.8 \text{ MHz}$ ;  $\sigma = 0.99 \text{ mho/m}$ ;  $\epsilon_r = 54.3$ ;  $\rho = 1000 \text{ kg/m}^3$

Phantom section: Flat Section

DASY4 Configuration:

- Probe: ET3DV6 - SN1558; ConvF(5.96, 5.96, 5.96); Calibrated: 2008-08-15
- Sensor-Surface: 4mm (Mechanical And Optical Surface Detection)
- Electronics: DAE3 Sn413; Calibrated: 2009-01-08
- Phantom: SAM 12; Type: SAM; Serial: 1043
- Measurement SW: DASY4, V4.5 Build 19; Postprocessing SW: SEMCAD, V1.8 Build 146

**Front position - High/Area Scan (51x81x1):** Measurement grid:  $dx=15\text{mm}$ ,  $dy=15\text{mm}$

Maximum value of SAR (interpolated) = 1.04 mW/g

**Front position - High/Zoom Scan (7x7x7) (7x7x7)/Cube 0:** Measurement grid:  $dx=5\text{mm}$ ,  $dy=5\text{mm}$ ,  $dz=5\text{mm}$

Reference Value = 33.6 V/m; Power Drift = 0.075 dB

Peak SAR (extrapolated) = 1.32 W/kg

**SAR(1 g) = 0.991 mW/g; SAR(10 g) = 0.713 mW/g**

Maximum value of SAR (measured) = 1.06 mW/g

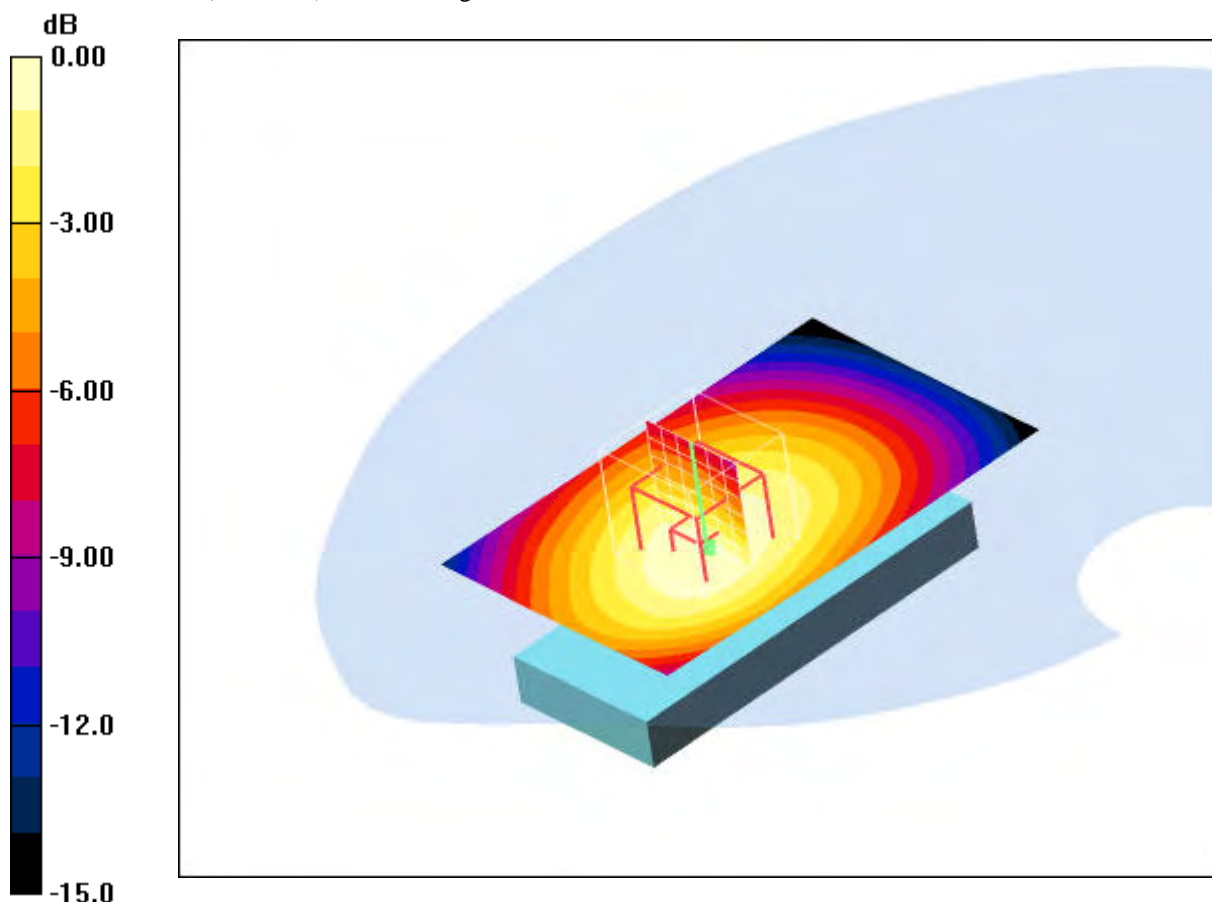

0 dB = 1.06mW/g

**Additional information:**

position or distance of DUT to SAM : 15 mm

ambient temperature: 22.6°C; liquid temperature: 21.5°C



Date/Time: 2009-04-02 12:50:58 Date/Time: 2009-04-02 12:56:47

**P1528\_OET65-Body-GSM850 GPRS 2TS**

**DUT: Sony Ericsson; Type: AAD-3880008-BV; Serial: T261F007CD**

Communication System: PCS 850 GPRS 2TS; Frequency: 824.2 MHz; Duty Cycle: 1:4

Medium: M850 Medium parameters used:  $f = 824.2 \text{ MHz}$ ;  $\sigma = 0.99 \text{ mho/m}$ ;  $\epsilon_r = 54.3$ ;  $\rho = 1000 \text{ kg/m}^3$

Phantom section: Flat Section

DASY4 Configuration:

- Probe: ET3DV6 - SN1558; ConvF(5.96, 5.96, 5.96); Calibrated: 2008-08-15
- Sensor-Surface: 4mm (Mechanical And Optical Surface Detection)
- Electronics: DAE3 Sn413; Calibrated: 2009-01-08
- Phantom: SAM 12; Type: SAM; Serial: 1043
- Measurement SW: DASY4, V4.5 Build 19; Postprocessing SW: SEMCAD, V1.8 Build 146

**Rear position - Low/Area Scan (51x81x1):** Measurement grid:  $dx=15\text{mm}$ ,  $dy=15\text{mm}$

Maximum value of SAR (interpolated) = 0.606 mW/g

**Rear position - Low/Zoom Scan (7x7x7) (7x7x7)/Cube 0:** Measurement grid:  $dx=5\text{mm}$ ,  $dy=5\text{mm}$ ,  $dz=5\text{mm}$

Reference Value = 25.7 V/m; Power Drift = -0.019 dB

Peak SAR (extrapolated) = 0.749 W/kg

**SAR(1 g) = 0.577 mW/g; SAR(10 g) = 0.417 mW/g**

Maximum value of SAR (measured) = 0.613 mW/g

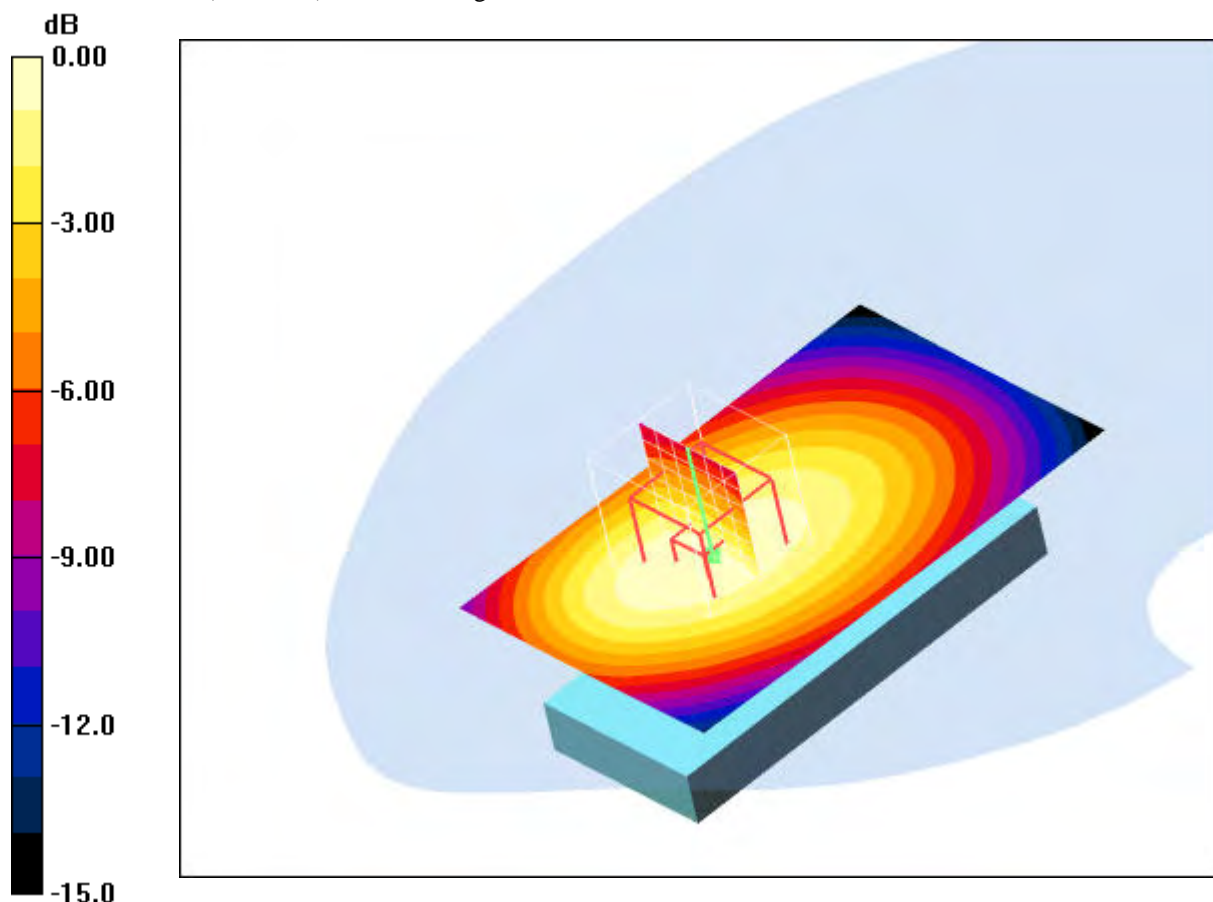

0 dB = 0.613mW/g

**Additional information:**

position or distance of DUT to SAM : 15 mm

ambient temperature: 22.9°C; liquid temperature: 21.6°C

Date/Time: 2009-04-02 12:29:31 Date/Time: 2009-04-02 12:35:21

**P1528\_OET65-Body-GSM850 GPRS 2TS**

**DUT: Sony Ericsson; Type: AAD-3880008-BV; Serial: T261F007CD**

Communication System: PCS 850 GPRS 2TS; Frequency: 836.6 MHz; Duty Cycle: 1:4

Medium: M850 Medium parameters used:  $f = 836.6 \text{ MHz}$ ;  $\sigma = 0.99 \text{ mho/m}$ ;  $\epsilon_r = 54.3$ ;  $\rho = 1000 \text{ kg/m}^3$

Phantom section: Flat Section

DASY4 Configuration:

- Probe: ET3DV6 - SN1558; ConvF(5.96, 5.96, 5.96); Calibrated: 2008-08-15
- Sensor-Surface: 4mm (Mechanical And Optical Surface Detection)
- Electronics: DAE3 Sn413; Calibrated: 2009-01-08
- Phantom: SAM 12; Type: SAM; Serial: 1043
- Measurement SW: DASY4, V4.5 Build 19; Postprocessing SW: SEMCAD, V1.8 Build 146

**Rear position - Middle/Area Scan (51x81x1):** Measurement grid:  $dx=15\text{mm}$ ,  $dy=15\text{mm}$

Maximum value of SAR (interpolated) = 0.756 mW/g

**Rear position - Middle/Zoom Scan (7x7x7) (7x7x7)/Cube 0:** Measurement grid:  $dx=5\text{mm}$ ,  $dy=5\text{mm}$ ,

$dz=5\text{mm}$

Reference Value = 28.8 V/m; Power Drift = 0.00 dB

Peak SAR (extrapolated) = 0.961 W/kg

**SAR(1 g) = 0.724 mW/g; SAR(10 g) = 0.521 mW/g**

Maximum value of SAR (measured) = 0.768 mW/g

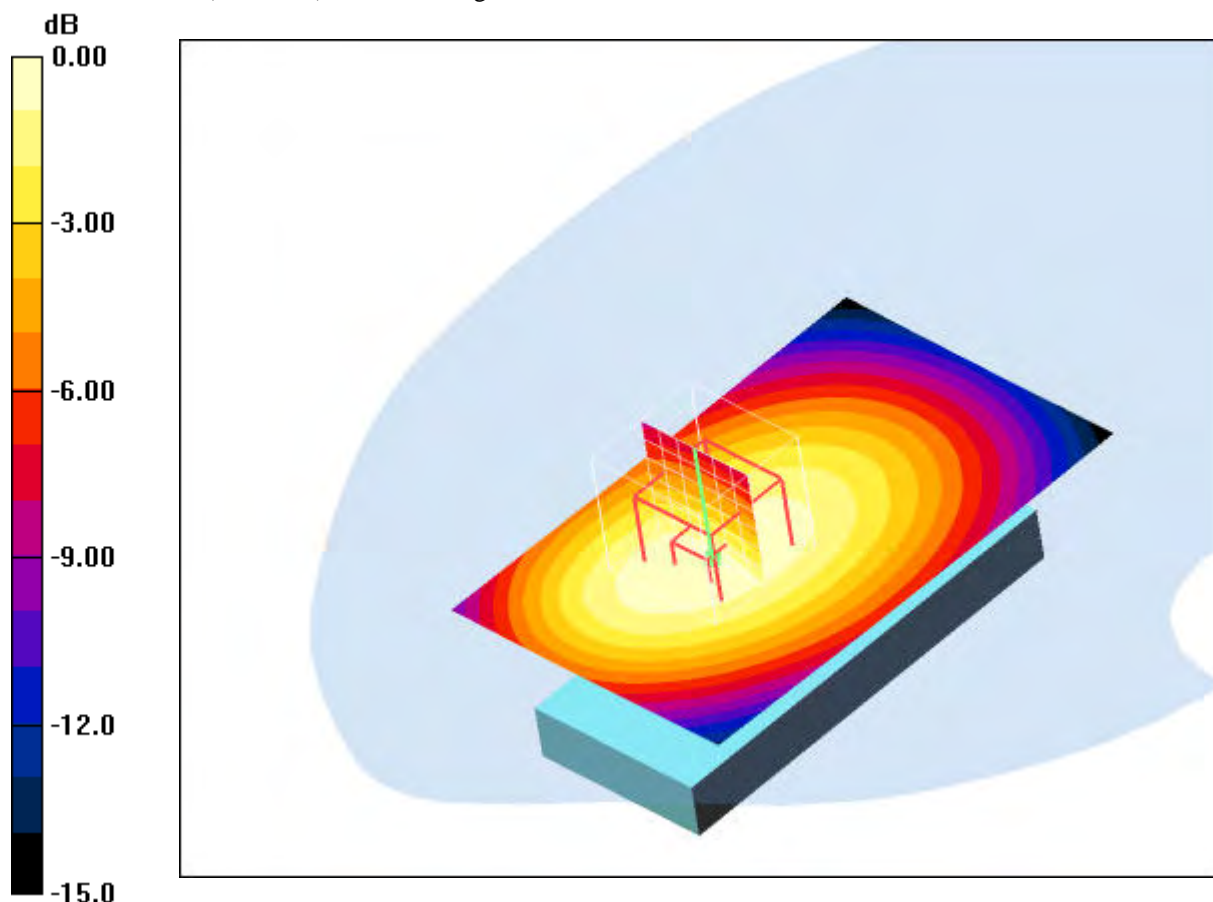

0 dB = 0.768mW/g

**Additional information:**

position or distance of DUT to SAM : 15 mm

ambient temperature: 22.9°C; liquid temperature: 21.6°C

Date/Time: 2009-04-02 13:12:45 Date/Time: 2009-04-02 13:18:36

**P1528\_OET65-Body-GSM850 GPRS 2TS**

**DUT: Sony Ericsson; Type: AAD-3880008-BV; Serial: T261F007CD**

Communication System: PCS 850 GPRS 2TS; Frequency: 848.8 MHz; Duty Cycle: 1:4

Medium: M850 Medium parameters used:  $f = 848.8 \text{ MHz}$ ;  $\sigma = 0.99 \text{ mho/m}$ ;  $\epsilon_r = 54.3$ ;  $\rho = 1000 \text{ kg/m}^3$

Phantom section: Flat Section

DASY4 Configuration:

- Probe: ET3DV6 - SN1558; ConvF(5.96, 5.96, 5.96); Calibrated: 2008-08-15
- Sensor-Surface: 4mm (Mechanical And Optical Surface Detection)
- Electronics: DAE3 Sn413; Calibrated: 2009-01-08
- Phantom: SAM 12; Type: SAM; Serial: 1043
- Measurement SW: DASY4, V4.5 Build 19; Postprocessing SW: SEMCAD, V1.8 Build 146

**Rear position - High/Area Scan (51x81x1):** Measurement grid: dx=15mm, dy=15mm

Maximum value of SAR (interpolated) = 0.940 mW/g

**Rear position - High/Zoom Scan (7x7x7) (7x7x7)/Cube 0:** Measurement grid: dx=5mm, dy=5mm, dz=5mm

Reference Value = 32.0 V/m; Power Drift = -0.048 dB

Peak SAR (extrapolated) = 1.15 W/kg

SAR(1 g) = 0.887 mW/g; SAR(10 g) = 0.642 mW/g

Maximum value of SAR (measured) = 0.938 mW/g

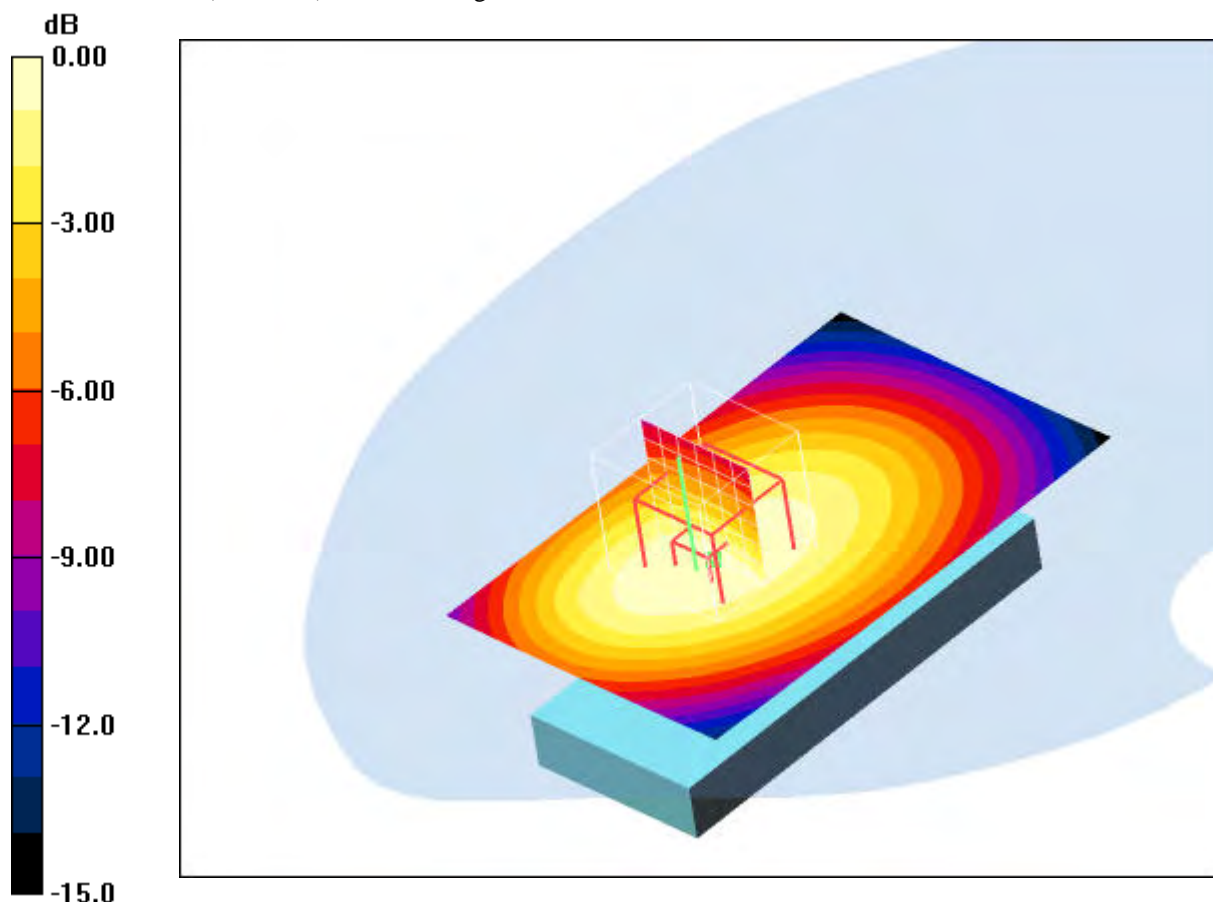

0 dB = 0.938mW/g

**Additional information:**

position or distance of DUT to SAM : 15 mm

ambient temperature: 22.9°C; liquid temperature: 21.6°C

Date/Time: 2009-04-02 15:01:42 Date/Time: 2009-04-02 15:07:32

**P1528\_OET65-Body-GSM850 GPRS 1TS**

**DUT: Sony Ericsson; Type: AAD-3880008-BV; Serial: T261F007CD**

Communication System: PCS 850; Frequency: 848.8 MHz; Duty Cycle: 1:8

Medium: M850 Medium parameters used:  $f = 848.8 \text{ MHz}$ ;  $\sigma = 0.99 \text{ mho/m}$ ;  $\epsilon_r = 54.3$ ;  $\rho = 1000 \text{ kg/m}^3$

Phantom section: Flat Section

DASY4 Configuration:

- Probe: ET3DV6 - SN1558; ConvF(5.96, 5.96, 5.96); Calibrated: 2008-08-15
- Sensor-Surface: 4mm (Mechanical And Optical Surface Detection)
- Electronics: DAE3 Sn413; Calibrated: 2009-01-08
- Phantom: SAM 12; Type: SAM; Serial: 1043
- Measurement SW: DASY4, V4.5 Build 19; Postprocessing SW: SEMCAD, V1.8 Build 146

**Front position - High/Area Scan (51x81x1):** Measurement grid:  $dx=15\text{mm}$ ,  $dy=15\text{mm}$

Maximum value of SAR (interpolated) = 0.846 mW/g

**Front position - High/Zoom Scan (7x7x7) (7x7x7)/Cube 0:** Measurement grid:  $dx=5\text{mm}$ ,  $dy=5\text{mm}$ ,  $dz=5\text{mm}$

Reference Value = 30.3 V/m; Power Drift = 0.00 dB

Peak SAR (extrapolated) = 1.07 W/kg

**SAR(1 g) = 0.797 mW/g; SAR(10 g) = 0.573 mW/g**

Maximum value of SAR (measured) = 0.853 mW/g

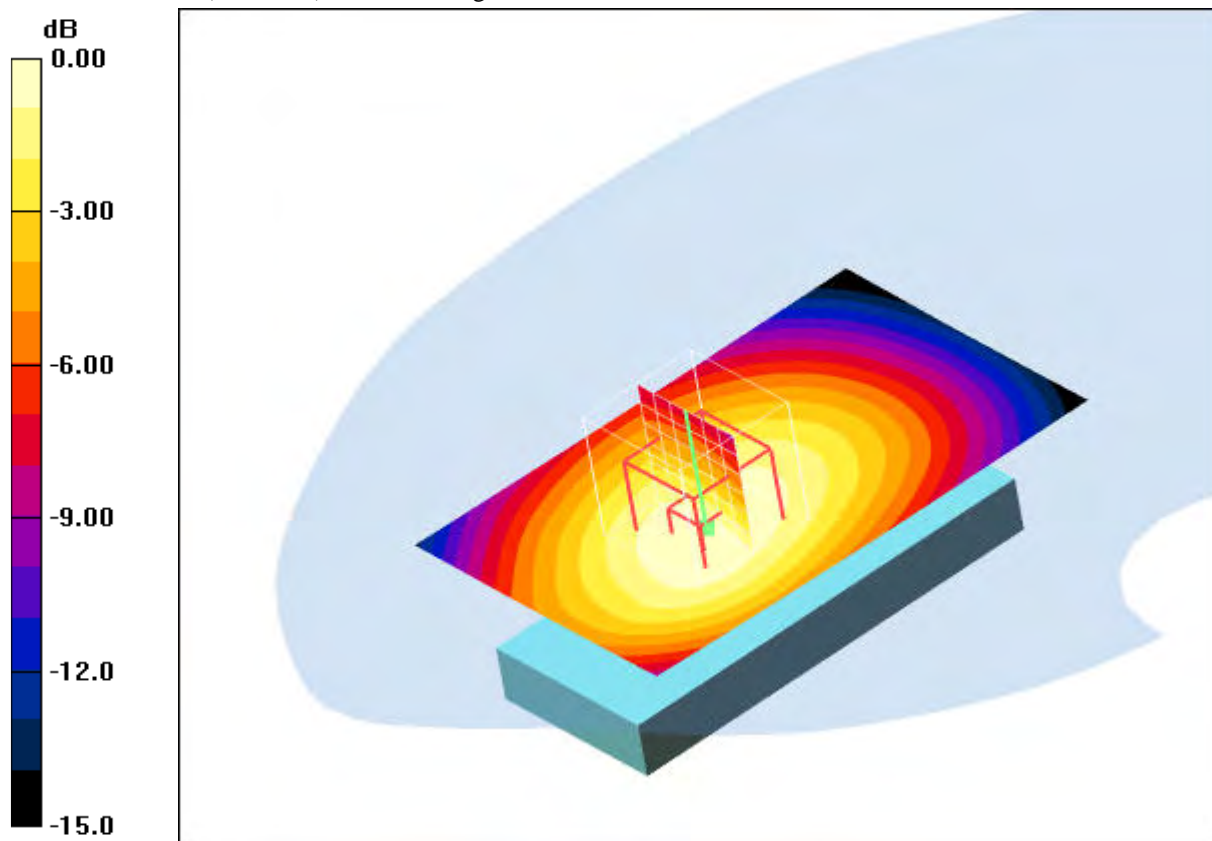

0 dB = 0.853mW/g

**Additional information:**

position or distance of DUT to SAM : 15 mm

ambient temperature: 22.6°C; liquid temperature: 21.5°C

**Annex 2.3 PCS 1900 MHz head**

Date/Time: 2009-03-24 09:01:23 Date/Time: 2009-03-24 09:07:38

**P1528\_OET65-LeftHandSide-GSM1900**

**DUT: Sony Ericsson; Type: AAD-3880008-BV; Serial: T261F007CD**

Communication System: PCS 1900; Frequency: 1850.2 MHz; Duty Cycle: 1:8

Medium: HSL1900 Medium parameters used:  $f = 1850.2 \text{ MHz}$ ;  $\sigma = 1.39 \text{ mho/m}$ ;  $\epsilon_r = 40.4$ ;  $\rho = 1000 \text{ kg/m}^3$

Phantom section: Left Section

DASY4 Configuration:

- Probe: ET3DV6 - SN1558; ConvF(4.96, 4.96, 4.96); Calibrated: 2008-08-15
- Sensor-Surface: 4mm (Mechanical And Optical Surface Detection)
- Electronics: DAE3 Sn413; Calibrated: 2009-01-08
- Phantom: SAM 12; Type: SAM; Serial: 1043
- Measurement SW: DASY4, V4.5 Build 19; Postprocessing SW: SEMCAD, V1.8 Build 146

**Touch position - Low/Area Scan (51x91x1):** Measurement grid:  $dx=15\text{mm}$ ,  $dy=15\text{mm}$

Maximum value of SAR (interpolated) = 1.35 mW/g

**Touch position - Low/Zoom Scan (7x7x7) (7x7x7)/Cube 0:** Measurement grid:  $dx=5\text{mm}$ ,  $dy=5\text{mm}$ ,  $dz=5\text{mm}$

Reference Value = 30.6 V/m; Power Drift = -0.024 dB

Peak SAR (extrapolated) = 1.58 W/kg

**SAR(1 g) = 1.15 mW/g; SAR(10 g) = 0.693 mW/g**

Maximum value of SAR (measured) = 1.22 mW/g

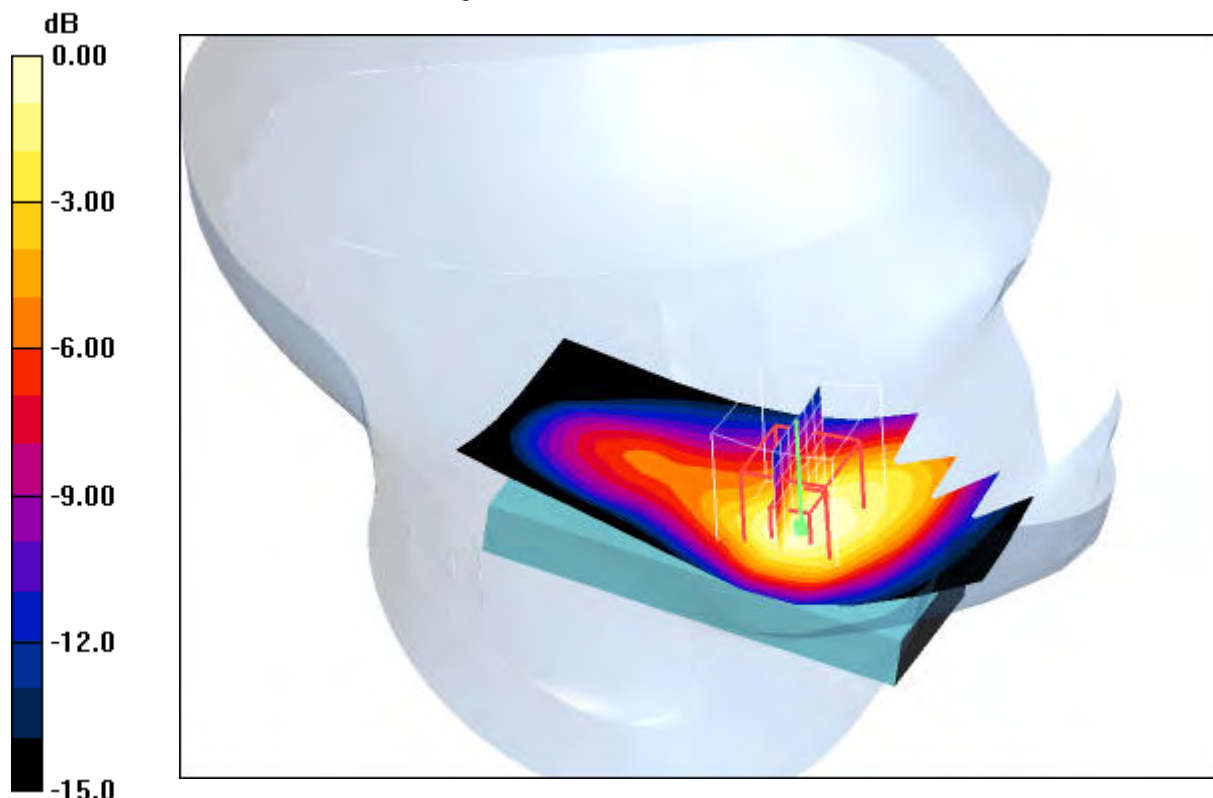

0 dB = 1.22mW/g

**Additional information:**

position or distance of DUT to SAM (if not standard head positions) :

ambient temperature: 22.5°C; liquid temperature: 21.1°C

Date/Time: 2009-03-24 09:23:17 Date/Time: 2009-03-24 09:29:34

**P1528\_OET65-LeftHandSide-GSM1900**

**DUT: Sony Ericsson; Type: AAD-3880008-BV; Serial: T261F007CD**

Communication System: PCS 1900; Frequency: 1880 MHz; Duty Cycle: 1:8

Medium: HSL1900 Medium parameters used:  $f = 1880 \text{ MHz}$ ;  $\sigma = 1.39 \text{ mho/m}$ ;  $\epsilon_r = 40.4$ ;  $\rho = 1000 \text{ kg/m}^3$

Phantom section: Left Section

DASY4 Configuration:

- Probe: ET3DV6 - SN1558; ConvF(4.96, 4.96, 4.96); Calibrated: 2008-08-15
- Sensor-Surface: 4mm (Mechanical And Optical Surface Detection)
- Electronics: DAE3 Sn413; Calibrated: 2009-01-08
- Phantom: SAM 12; Type: SAM; Serial: 1043
- Measurement SW: DASY4, V4.5 Build 19; Postprocessing SW: SEMCAD, V1.8 Build 146

**Touch position - Middle/Area Scan (51x91x1):** Measurement grid:  $dx=15\text{mm}$ ,  $dy=15\text{mm}$

Maximum value of SAR (interpolated) = 1.26 mW/g

**Touch position - Middle/Zoom Scan (7x7x7) (7x7x7)/Cube 0:** Measurement grid:  $dx=5\text{mm}$ ,  $dy=5\text{mm}$ ,

$dz=5\text{mm}$

Reference Value = 29.8 V/m; Power Drift = 0.019 dB

Peak SAR (extrapolated) = 1.52 W/kg

**SAR(1 g) = 1.09 mW/g; SAR(10 g) = 0.651 mW/g**

Maximum value of SAR (measured) = 1.16 mW/g

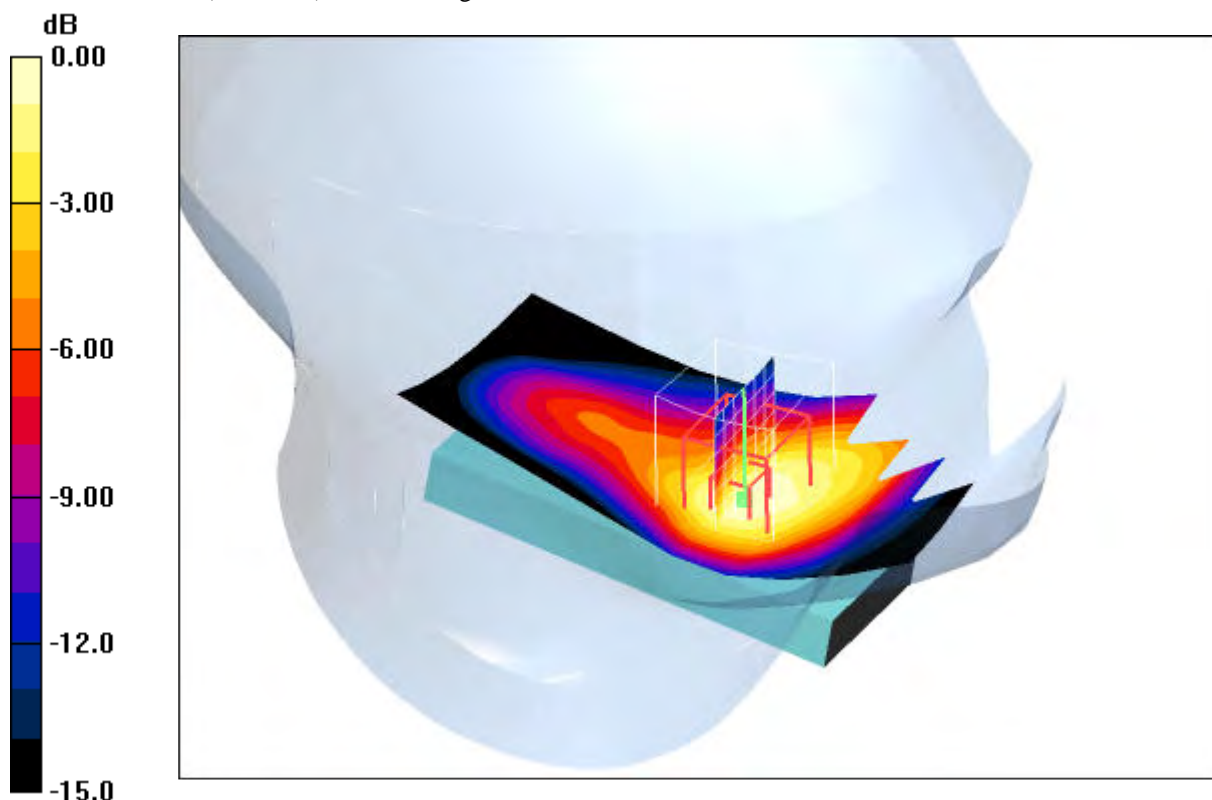

0 dB = 1.16mW/g

**Additional information:**

position or distance of DUT to SAM (if not standard head positions) :

ambient temperature: 22.5°C; liquid temperature: 21.1°C

Date/Time: 2009-03-24 09:44:48 Date/Time: 2009-03-24 09:51:04

**P1528\_OET65-LeftHandSide-GSM1900**

**DUT: Sony Ericsson; Type: AAD-3880008-BV; Serial: T261F007CD**

Communication System: PCS 1900; Frequency: 1909.8 MHz; Duty Cycle: 1:8

Medium: HSL1900 Medium parameters used:  $f = 1909.8 \text{ MHz}$ ;  $\sigma = 1.39 \text{ mho/m}$ ;  $\epsilon_r = 40.4$ ;  $\rho = 1000 \text{ kg/m}^3$

Phantom section: Left Section

DASY4 Configuration:

- Probe: ET3DV6 - SN1558; ConvF(4.96, 4.96, 4.96); Calibrated: 2008-08-15
- Sensor-Surface: 4mm (Mechanical And Optical Surface Detection)
- Electronics: DAE3 Sn413; Calibrated: 2009-01-08
- Phantom: SAM 12; Type: SAM; Serial: 1043
- Measurement SW: DASY4, V4.5 Build 19; Postprocessing SW: SEMCAD, V1.8 Build 146

**Touch position - High/Area Scan (51x91x1):** Measurement grid:  $dx=15\text{mm}$ ,  $dy=15\text{mm}$

Maximum value of SAR (interpolated) = 1.13 mW/g

**Touch position - High/Zoom Scan (7x7x7) (7x7x7)/Cube 0:** Measurement grid:  $dx=5\text{mm}$ ,  $dy=5\text{mm}$ ,  $dz=5\text{mm}$

Reference Value = 28.4 V/m; Power Drift = -0.028 dB

Peak SAR (extrapolated) = 1.38 W/kg

**SAR(1 g) = 0.971 mW/g; SAR(10 g) = 0.576 mW/g**

Maximum value of SAR (measured) = 1.04 mW/g

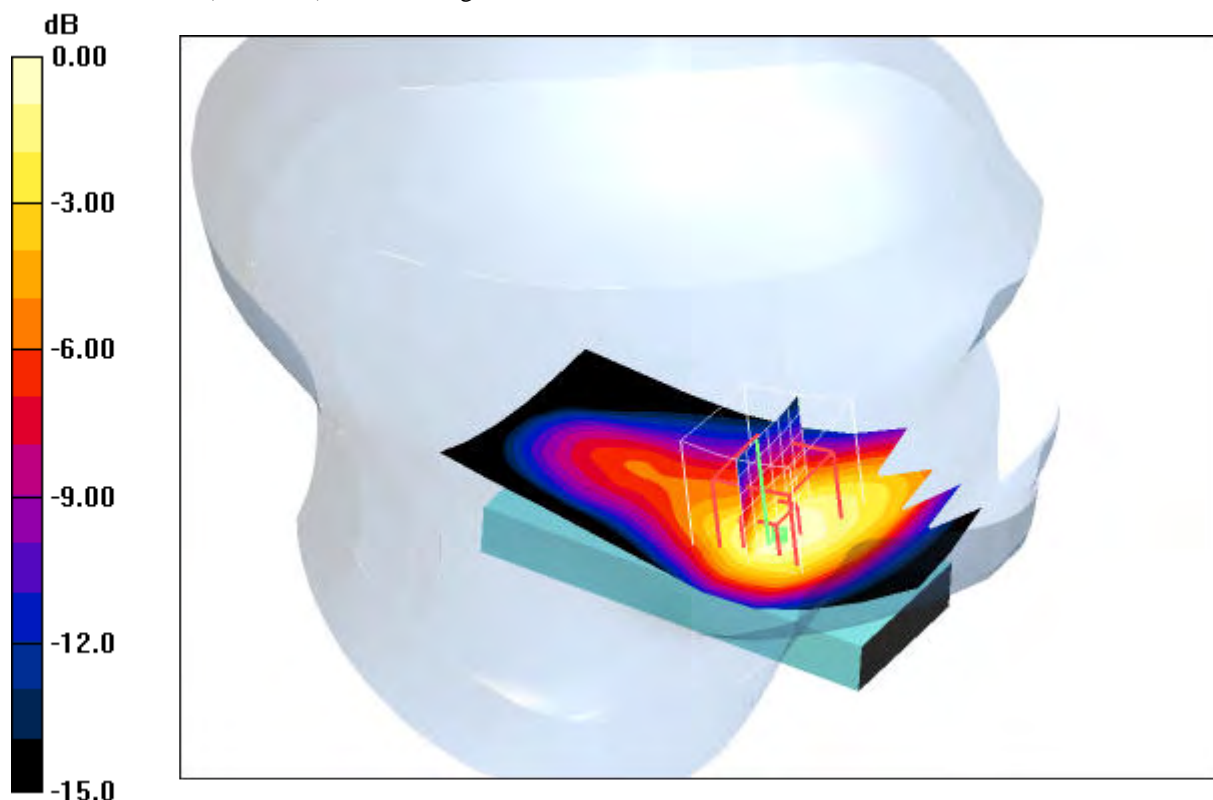

0 dB = 1.04mW/g

**Additional information:**

position or distance of DUT to SAM (if not standard head positions) :

ambient temperature: 22.5°C; liquid temperature: 21.1°C

Date/Time: 2009-03-24 10:46:34 Date/Time: 2009-03-24 10:53:12

**P1528\_OET65-LeftHandSide-GSM1900**

**DUT: Sony Ericsson; Type: AAD-3880008-BV; Serial: T261F007CD**

Communication System: PCS 1900; Frequency: 1850.2 MHz; Duty Cycle: 1:8

Medium: HSL1900 Medium parameters used:  $f = 1850.2 \text{ MHz}$ ;  $\sigma = 1.39 \text{ mho/m}$ ;  $\epsilon_r = 40.4$ ;  $\rho = 1000 \text{ kg/m}^3$

Phantom section: Left Section

DASY4 Configuration:

- Probe: ET3DV6 - SN1558; ConvF(4.96, 4.96, 4.96); Calibrated: 2008-08-15
- Sensor-Surface: 4mm (Mechanical And Optical Surface Detection)
- Electronics: DAE3 Sn413; Calibrated: 2009-01-08
- Phantom: SAM 12; Type: SAM; Serial: 1043
- Measurement SW: DASY4, V4.5 Build 19; Postprocessing SW: SEMCAD, V1.8 Build 146

**Tilt position - Low/Area Scan (51x91x1):** Measurement grid:  $dx=15\text{mm}$ ,  $dy=15\text{mm}$

Maximum value of SAR (interpolated) = 0.445 mW/g

**Tilt position - Low/Zoom Scan (7x7x7) (7x7x7)/Cube 0:** Measurement grid:  $dx=5\text{mm}$ ,  $dy=5\text{mm}$ ,  $dz=5\text{mm}$

Reference Value = 17.1 V/m; Power Drift = 0.013 dB

Peak SAR (extrapolated) = 0.559 W/kg

**SAR(1 g) = 0.372 mW/g; SAR(10 g) = 0.234 mW/g**

Maximum value of SAR (measured) = 0.399 mW/g

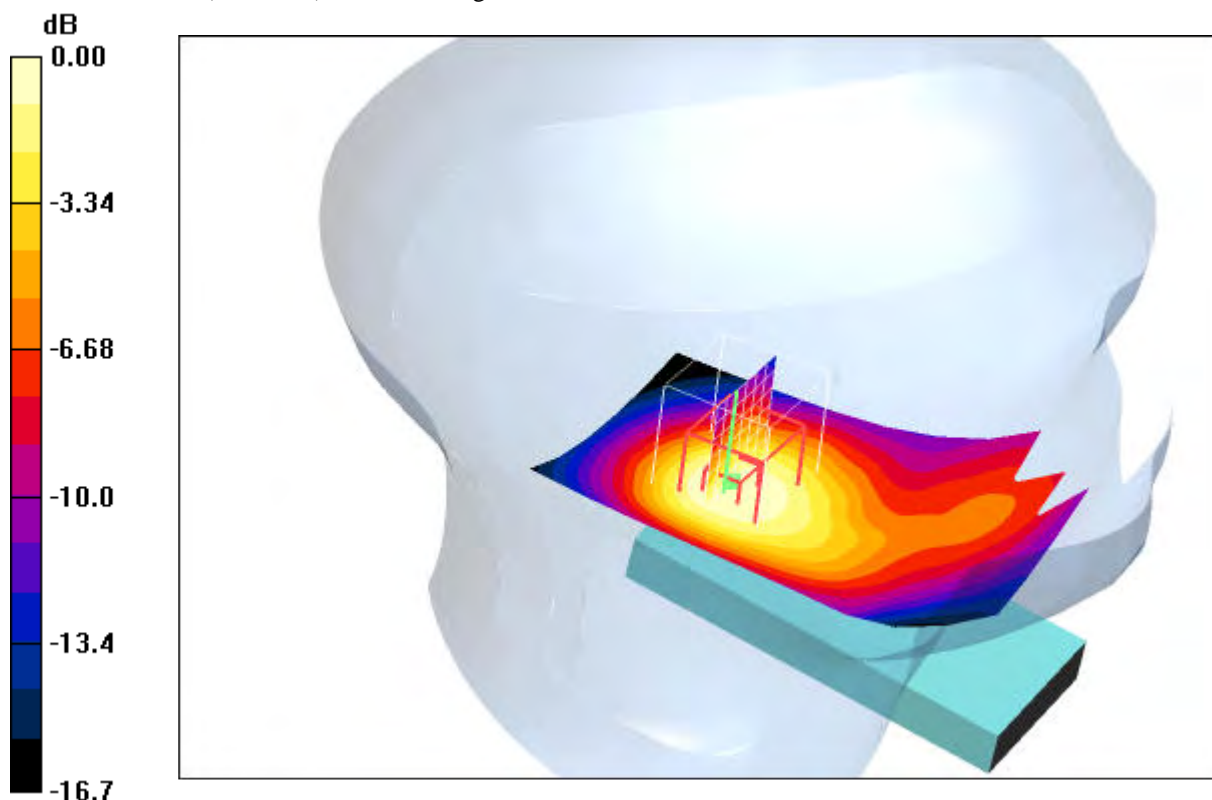

0 dB = 0.399mW/g

**Additional information:**

position or distance of DUT to SAM (if not standard head positions) :

ambient temperature: 22.5°C; liquid temperature: 21.1°C



**P1528\_OET65-LeftHandSide-GSM1900**

**DUT: Sony Ericsson; Type: AAD-3880008-BV; Serial: T261F007CD**

Communication System: PCS 1900; Frequency: 1880 MHz; Duty Cycle: 1:8

Medium: HSL1900 Medium parameters used:  $f = 1880 \text{ MHz}$ ;  $\sigma = 1.39 \text{ mho/m}$ ;  $\epsilon_r = 40.4$ ;  $\rho = 1000 \text{ kg/m}^3$

Phantom section: Left Section

DASY4 Configuration:

- Probe: ET3DV6 - SN1558; ConvF(4.96, 4.96, 4.96); Calibrated: 2008-08-15
- Sensor-Surface: 4mm (Mechanical And Optical Surface Detection)
- Electronics: DAE3 Sn413; Calibrated: 2009-01-08
- Phantom: SAM 12; Type: SAM; Serial: 1043
- Measurement SW: DASY4, V4.5 Build 19; Postprocessing SW: SEMCAD, V1.8 Build 146

**Tilt position - Middle/Area Scan (51x91x1):** Measurement grid:  $dx=15\text{mm}$ ,  $dy=15\text{mm}$

Maximum value of SAR (interpolated) = 0.434 mW/g

**Tilt position - Middle/Zoom Scan (7x7x7) (7x7x7)/Cube 0:** Measurement grid:  $dx=5\text{mm}$ ,  $dy=5\text{mm}$ ,  $dz=5\text{mm}$

Reference Value = 16.6 V/m; Power Drift = 0.022 dB

Peak SAR (extrapolated) = 0.556 W/kg

**SAR(1 g) = 0.358 mW/g; SAR(10 g) = 0.223 mW/g**

Maximum value of SAR (measured) = 0.385 mW/g

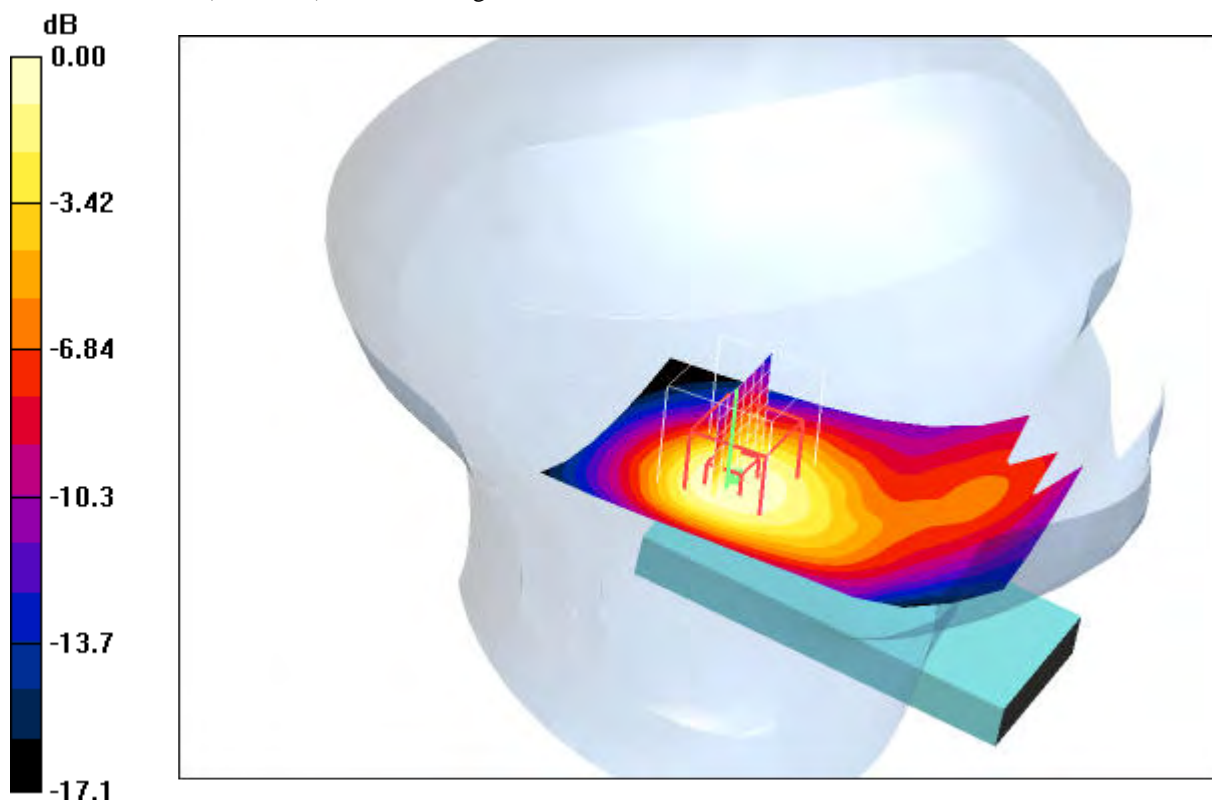

0 dB = 0.385mW/g

**Additional information:**

position or distance of DUT to SAM (if not standard head positions) :

ambient temperature: 22.5°C; liquid temperature: 21.1°C

Date/Time: 2009-03-24 10:06:38 Date/Time: 2009-03-24 10:13:11

**P1528\_OET65-LeftHandSide-GSM1900**

**DUT: Sony Ericsson; Type: AAD-3880008-BV; Serial: T261F007CD**

Communication System: PCS 1900; Frequency: 1909.8 MHz; Duty Cycle: 1:8

Medium: HSL1900 Medium parameters used:  $f = 1909.8 \text{ MHz}$ ;  $\sigma = 1.39 \text{ mho/m}$ ;  $\epsilon_r = 40.4$ ;  $\rho = 1000 \text{ kg/m}^3$

Phantom section: Left Section

DASY4 Configuration:

- Probe: ET3DV6 - SN1558; ConvF(4.96, 4.96, 4.96); Calibrated: 2008-08-15
- Sensor-Surface: 4mm (Mechanical And Optical Surface Detection)
- Electronics: DAE3 Sn413; Calibrated: 2009-01-08
- Phantom: SAM 12; Type: SAM; Serial: 1043
- Measurement SW: DASY4, V4.5 Build 19; Postprocessing SW: SEMCAD, V1.8 Build 146

**Tilt position - High/Area Scan (51x91x1):** Measurement grid:  $dx=15\text{mm}$ ,  $dy=15\text{mm}$

Maximum value of SAR (interpolated) = 0.404 mW/g

**Tilt position - High/Zoom Scan (7x7x7) (7x7x7)/Cube 0:** Measurement grid:  $dx=5\text{mm}$ ,  $dy=5\text{mm}$ ,  $dz=5\text{mm}$

Reference Value = 15.9 V/m; Power Drift = -0.043 dB

Peak SAR (extrapolated) = 0.539 W/kg

**SAR(1 g) = 0.336 mW/g; SAR(10 g) = 0.206 mW/g**

Maximum value of SAR (measured) = 0.364 mW/g

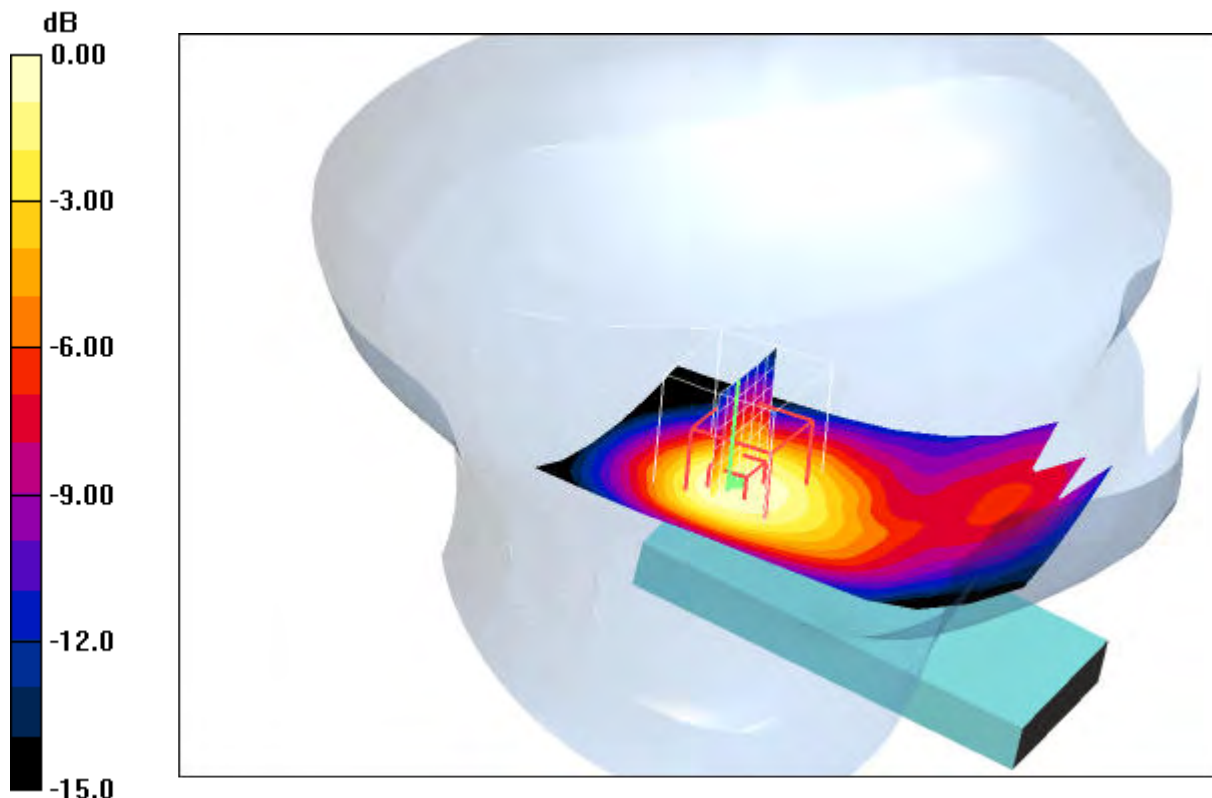

0 dB = 0.364mW/g

**Additional information:**

position or distance of DUT to SAM (if not standard head positions) :

ambient temperature: 22.5°C; liquid temperature: 21.1°C

Date/Time: 2009-03-24 12:51:48 Date/Time: 2009-03-24 12:58:05

**P1528\_OET65-RightHandSide-GSM1900**

**DUT: Sony Ericsson; Type: AAD-3880008-BV; Serial: T261F007CD**

Communication System: PCS 1900; Frequency: 1850.2 MHz; Duty Cycle: 1:8

Medium: HSL1900 Medium parameters used:  $f = 1850.2 \text{ MHz}$ ;  $\sigma = 1.39 \text{ mho/m}$ ;  $\epsilon_r = 40.4$ ;  $\rho = 1000 \text{ kg/m}^3$

Phantom section: Right Section

DASY4 Configuration:

- Probe: ET3DV6 - SN1558; ConvF(4.96, 4.96, 4.96); Calibrated: 2008-08-15
- Sensor-Surface: 4mm (Mechanical And Optical Surface Detection)
- Electronics: DAE3 Sn413; Calibrated: 2009-01-08
- Phantom: SAM 12; Type: SAM; Serial: 1043
- Measurement SW: DASY4, V4.5 Build 19; Postprocessing SW: SEMCAD, V1.8 Build 146

**Touch position - Low/Area Scan (51x91x1):** Measurement grid:  $dx=15\text{mm}$ ,  $dy=15\text{mm}$

Maximum value of SAR (interpolated) = 1.38 mW/g

**Touch position - Low/Zoom Scan (7x7x7) (7x7x7)/Cube 0:** Measurement grid:  $dx=5\text{mm}$ ,  $dy=5\text{mm}$ ,  $dz=5\text{mm}$

Reference Value = 31.9 V/m; Power Drift = -0.185 dB

Peak SAR (extrapolated) = 2.26 W/kg

**SAR(1 g) = 1.3 mW/g; SAR(10 g) = 0.707 mW/g**

Maximum value of SAR (measured) = 1.45 mW/g

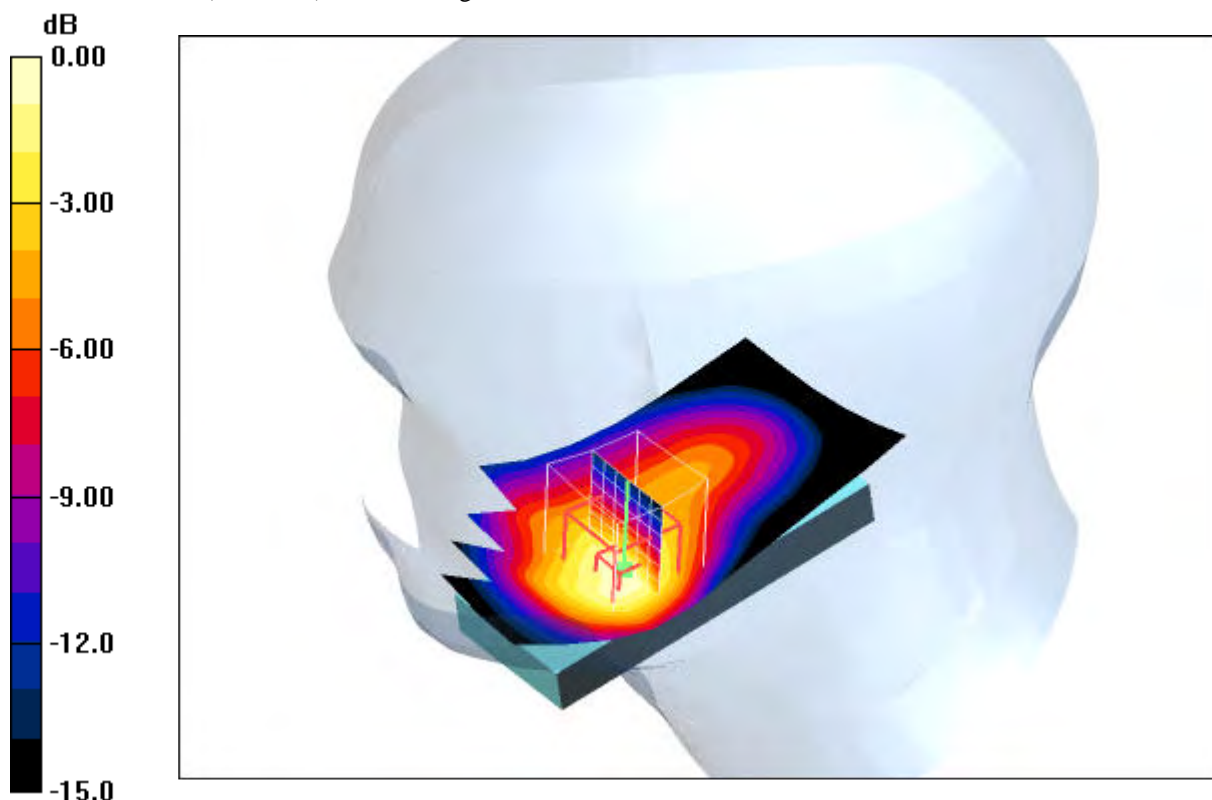

0 dB = 1.45mW/g

**Additional information:**

position or distance of DUT to SAM (if not standard head positions) :

ambient temperature: 22.6°C; liquid temperature: 21.2°C

Date/Time: 2009-03-24 12:30:39 Date/Time: 2009-03-24 12:36:53

**P1528\_OET65-RightHandSide-GSM1900**

**DUT: Sony Ericsson; Type: AAD-3880008-BV; Serial: T261F007CD**

Communication System: PCS 1900; Frequency: 1880 MHz; Duty Cycle: 1:8

Medium: HSL1900 Medium parameters used:  $f = 1880 \text{ MHz}$ ;  $\sigma = 1.39 \text{ mho/m}$ ;  $\epsilon_r = 40.4$ ;  $\rho = 1000 \text{ kg/m}^3$

Phantom section: Right Section

DASY4 Configuration:

- Probe: ET3DV6 - SN1558; ConvF(4.96, 4.96, 4.96); Calibrated: 2008-08-15
- Sensor-Surface: 4mm (Mechanical And Optical Surface Detection) Sensor-Surface: 4mm (Mechanical Surface Detection)
- Electronics: DAE3 Sn413; Calibrated: 2009-01-08
- Phantom: SAM 12; Type: SAM; Serial: 1043
- Measurement SW: DASY4, V4.5 Build 19; Postprocessing SW: SEMCAD, V1.8 Build 146

**Touch position - Middle/Area Scan (51x91x1):** Measurement grid:  $dx=15\text{mm}$ ,  $dy=15\text{mm}$

Maximum value of SAR (interpolated) = 1.25 mW/g

**Touch position - Middle/Zoom Scan (7x7x7) (7x7x7)/Cube 0:** Measurement grid:  $dx=5\text{mm}$ ,  $dy=5\text{mm}$ ,  $dz=5\text{mm}$

Reference Value = 30.3 V/m; Power Drift = -0.036 dB

Peak SAR (extrapolated) = 2.03 W/kg

**SAR(1 g) = 1.18 mW/g; SAR(10 g) = 0.631 mW/g**

Maximum value of SAR (measured) = 1.33 mW/g

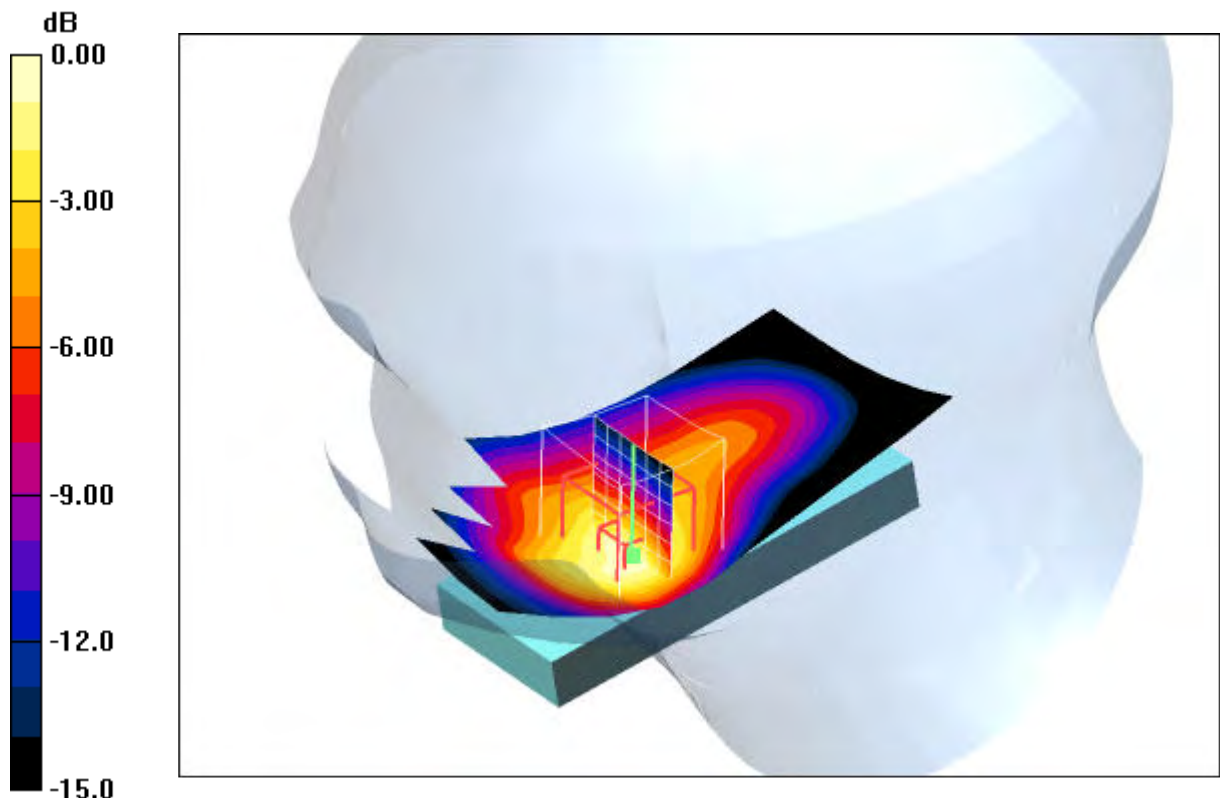

0 dB = 1.33mW/g

**Additional information:**

position or distance of DUT to SAM (if not standard head positions) :

ambient temperature: 22.6°C; liquid temperature: 21.2°C

Date/Time: 2009-03-24 12:09:17 Date/Time: 2009-03-24 12:15:32

**P1528\_OET65-RightHandSide-GSM1900**

**DUT: Sony Ericsson; Type: AAD-3880008-BV; Serial: T261F007CD**

Communication System: PCS 1900; Frequency: 1909.8 MHz; Duty Cycle: 1:8

Medium: HSL1900 Medium parameters used:  $f = 1909.8 \text{ MHz}$ ;  $\sigma = 1.39 \text{ mho/m}$ ;  $\epsilon_r = 40.4$ ;  $\rho = 1000 \text{ kg/m}^3$

Phantom section: Right Section

DASY4 Configuration:

- Probe: ET3DV6 - SN1558; ConvF(4.96, 4.96, 4.96); Calibrated: 2008-08-15
- Sensor-Surface: 4mm (Mechanical And Optical Surface Detection)
- Electronics: DAE3 Sn413; Calibrated: 2009-01-08
- Phantom: SAM 12; Type: SAM; Serial: 1043
- Measurement SW: DASY4, V4.5 Build 19; Postprocessing SW: SEMCAD, V1.8 Build 146

**Touch position - High/Area Scan (51x91x1):** Measurement grid:  $dx=15\text{mm}$ ,  $dy=15\text{mm}$

Maximum value of SAR (interpolated) = 1.06 mW/g

**Touch position - High/Zoom Scan (7x7x7) (7x7x7)/Cube 0:** Measurement grid:  $dx=5\text{mm}$ ,  $dy=5\text{mm}$ ,  $dz=5\text{mm}$

Reference Value = 28.1 V/m; Power Drift = 0.011 dB

Peak SAR (extrapolated) = 1.83 W/kg

**SAR(1 g) = 1.04 mW/g; SAR(10 g) = 0.548 mW/g**

Maximum value of SAR (measured) = 1.18 mW/g

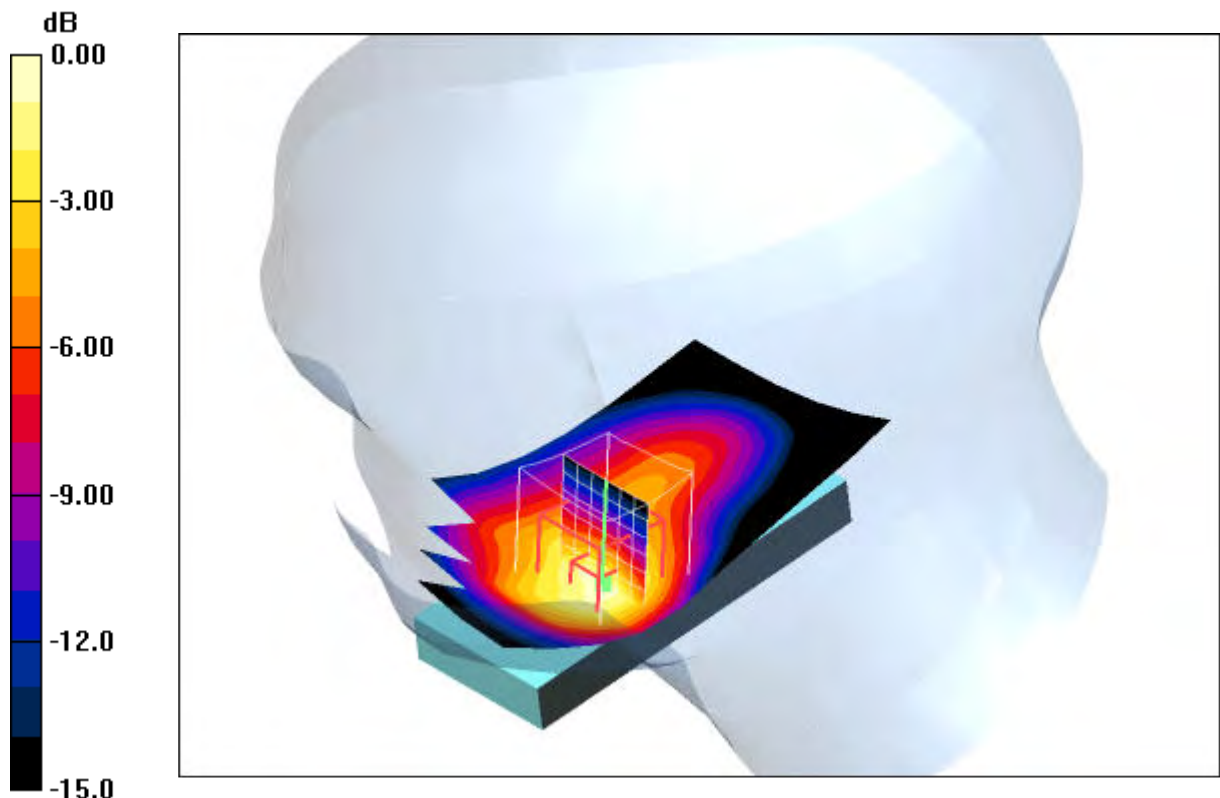

0 dB = 1.18mW/g

**Additional information:**

position or distance of DUT to SAM (if not standard head positions) :

ambient temperature: 22.6°C; liquid temperature: 21.2°C

**P1528\_OET65-RightHandSide-GSM1900**

**DUT: Sony Ericsson; Type: AAD-3880008-BV; Serial: T261F007CD**

Communication System: PCS 1900; Frequency: 1850.2 MHz; Duty Cycle: 1:8

Medium: HSL1900 Medium parameters used:  $f = 1850.2 \text{ MHz}$ ;  $\sigma = 1.39 \text{ mho/m}$ ;  $\epsilon_r = 40.4$ ;  $\rho = 1000 \text{ kg/m}^3$

Phantom section: Right Section

DASY4 Configuration:

- Probe: ET3DV6 - SN1558; ConvF(4.96, 4.96, 4.96); Calibrated: 2008-08-15
- Sensor-Surface: 4mm (Mechanical And Optical Surface Detection)
- Electronics: DAE3 Sn413; Calibrated: 2009-01-08
- Phantom: SAM 12; Type: SAM; Serial: 1043
- Measurement SW: DASY4, V4.5 Build 19; Postprocessing SW: SEMCAD, V1.8 Build 146

**Tilt position - Low/Area Scan (51x91x1):** Measurement grid:  $dx=15\text{mm}$ ,  $dy=15\text{mm}$

Maximum value of SAR (interpolated) = 0.538 mW/g

**Tilt position - Low/Zoom Scan (7x7x7) (7x7x7)/Cube 0:** Measurement grid:  $dx=5\text{mm}$ ,  $dy=5\text{mm}$ ,

$dz=5\text{mm}$

Reference Value = 18.6 V/m; Power Drift = -0.00 dB

Peak SAR (extrapolated) = 0.684 W/kg

**SAR(1 g) = 0.438 mW/g; SAR(10 g) = 0.270 mW/g**

Maximum value of SAR (measured) = 0.473 mW/g

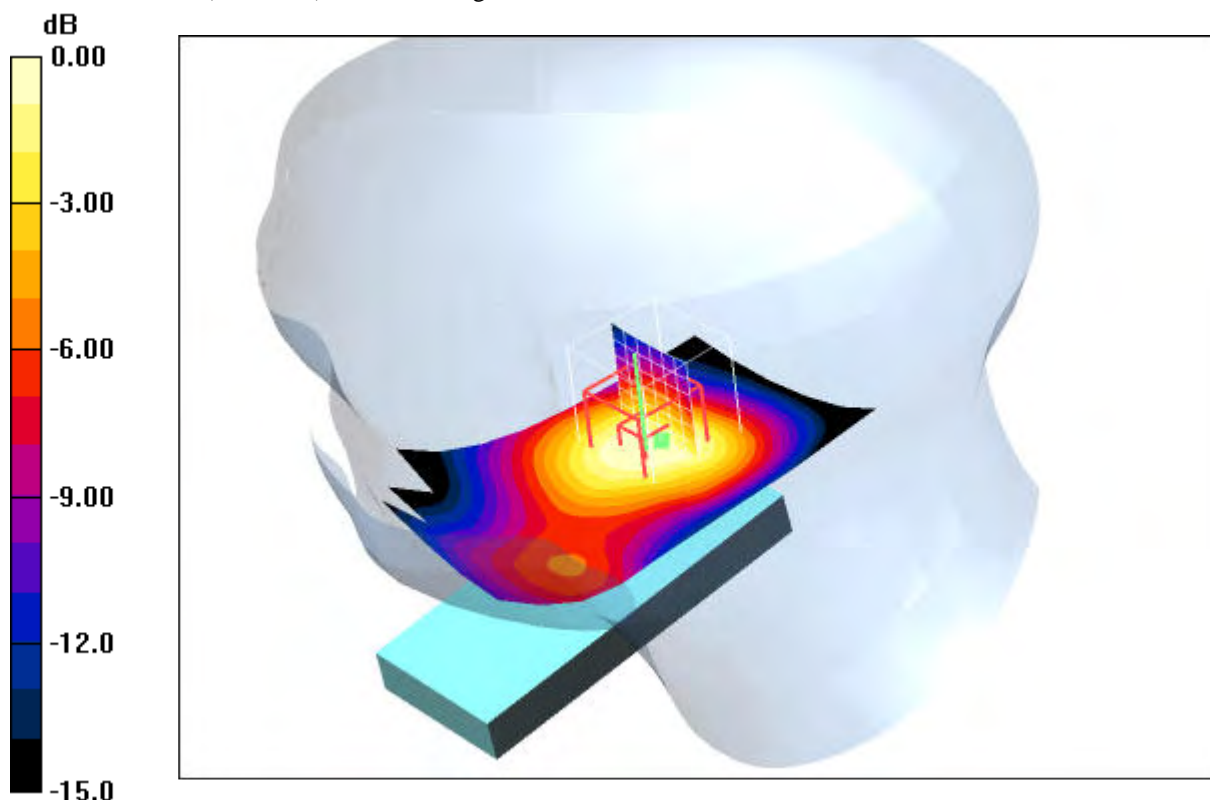

0 dB = 0.473mW/g

**Additional information:**

position or distance of DUT to SAM (if not standard head positions) :

ambient temperature: 22.6°C; liquid temperature: 21.2°C

Date/Time: 2009-03-24 11:28:16 Date/Time: 2009-03-24 11:34:38

**P1528\_OET65-RightHandSide-GSM1900**

**DUT: Sony Ericsson; Type: AAD-3880008-BV; Serial: T261F007CD**

Communication System: PCS 1900; Frequency: 1880 MHz; Duty Cycle: 1:8

Medium: HSL1900 Medium parameters used:  $f = 1880 \text{ MHz}$ ;  $\sigma = 1.39 \text{ mho/m}$ ;  $\epsilon_r = 40.4$ ;  $\rho = 1000 \text{ kg/m}^3$

Phantom section: Right Section

DASY4 Configuration:

- Probe: ET3DV6 - SN1558; ConvF(4.96, 4.96, 4.96); Calibrated: 2008-08-15
- Sensor-Surface: 4mm (Mechanical And Optical Surface Detection)
- Electronics: DAE3 Sn413; Calibrated: 2009-01-08
- Phantom: SAM 12; Type: SAM; Serial: 1043
- Measurement SW: DASY4, V4.5 Build 19; Postprocessing SW: SEMCAD, V1.8 Build 146

**Tilt position - Middle/Area Scan (51x91x1):** Measurement grid:  $dx=15\text{mm}$ ,  $dy=15\text{mm}$

Maximum value of SAR (interpolated) = 0.488 mW/g

**Tilt position - Middle/Zoom Scan (7x7x7) (7x7x7)/Cube 0:** Measurement grid:  $dx=5\text{mm}$ ,  $dy=5\text{mm}$ ,  $dz=5\text{mm}$

Reference Value = 17.7 V/m; Power Drift = -0.033 dB

Peak SAR (extrapolated) = 0.630 W/kg

**SAR(1 g) = 0.401 mW/g; SAR(10 g) = 0.245 mW/g**

Maximum value of SAR (measured) = 0.430 mW/g

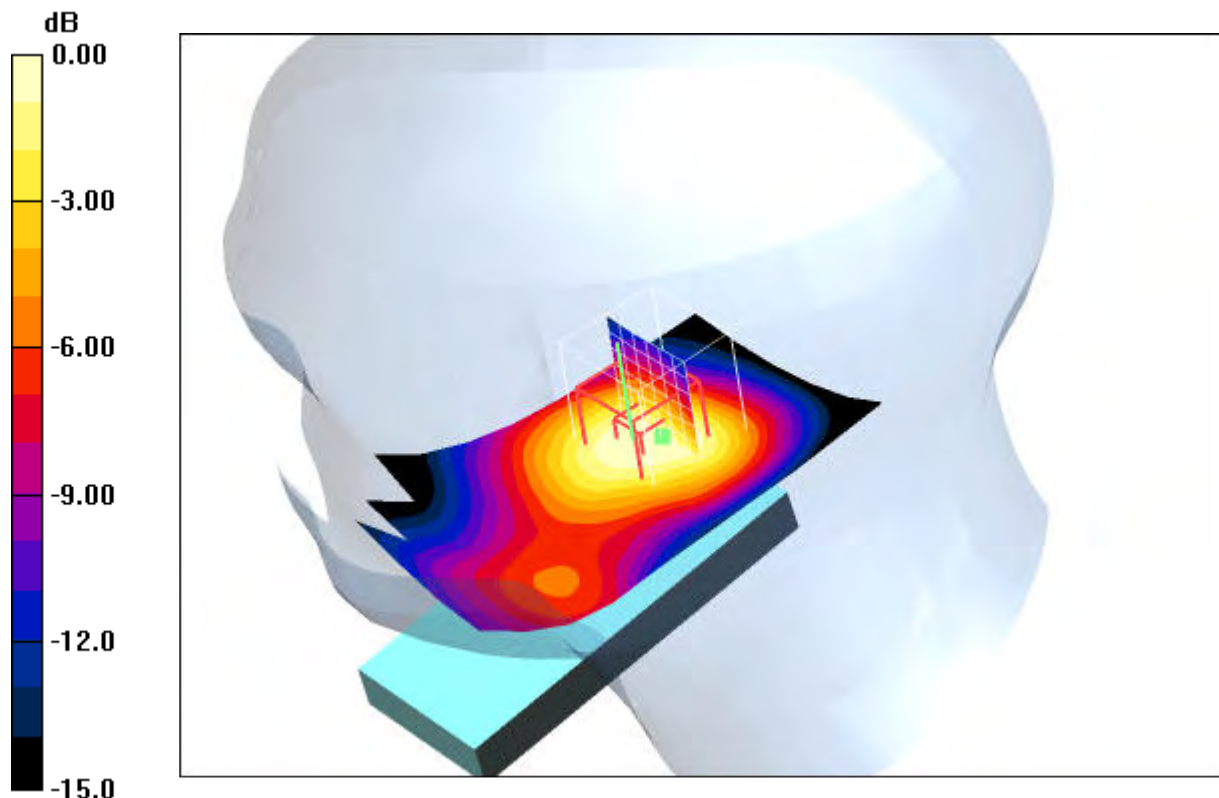

0 dB = 0.430mW/g

**Additional information:**

position or distance of DUT to SAM (if not standard head positions) :

ambient temperature: 22.6°C; liquid temperature: 21.2°C

Date/Time: 2009-03-24 11:49:27 Date/Time: 2009-03-24 11:55:52

**P1528\_OET65-RightHandSide-GSM1900**

**DUT: Sony Ericsson; Type: AAD-3880008-BV; Serial: T261F007CD**

Communication System: PCS 1900; Frequency: 1909.8 MHz; Duty Cycle: 1:8

Medium: HSL1900 Medium parameters used:  $f = 1909.8 \text{ MHz}$ ;  $\sigma = 1.39 \text{ mho/m}$ ;  $\epsilon_r = 40.4$ ;  $\rho = 1000 \text{ kg/m}^3$

Phantom section: Right Section

DASY4 Configuration:

- Probe: ET3DV6 - SN1558; ConvF(4.96, 4.96, 4.96); Calibrated: 2008-08-15
- Sensor-Surface: 4mm (Mechanical And Optical Surface Detection)
- Electronics: DAE3 Sn413; Calibrated: 2009-01-08
- Phantom: SAM 12; Type: SAM; Serial: 1043
- Measurement SW: DASY4, V4.5 Build 19; Postprocessing SW: SEMCAD, V1.8 Build 146

**Tilt position - High/Area Scan (51x91x1):** Measurement grid:  $dx=15\text{mm}$ ,  $dy=15\text{mm}$

Maximum value of SAR (interpolated) = 0.434 mW/g

**Tilt position - High/Zoom Scan (7x7x7) (7x7x7)/Cube 0:** Measurement grid:  $dx=5\text{mm}$ ,  $dy=5\text{mm}$ ,  $dz=5\text{mm}$

Reference Value = 16.4 V/m; Power Drift = 0.014 dB

Peak SAR (extrapolated) = 0.555 W/kg

**SAR(1 g) = 0.351 mW/g; SAR(10 g) = 0.214 mW/g**

Maximum value of SAR (measured) = 0.374 mW/g

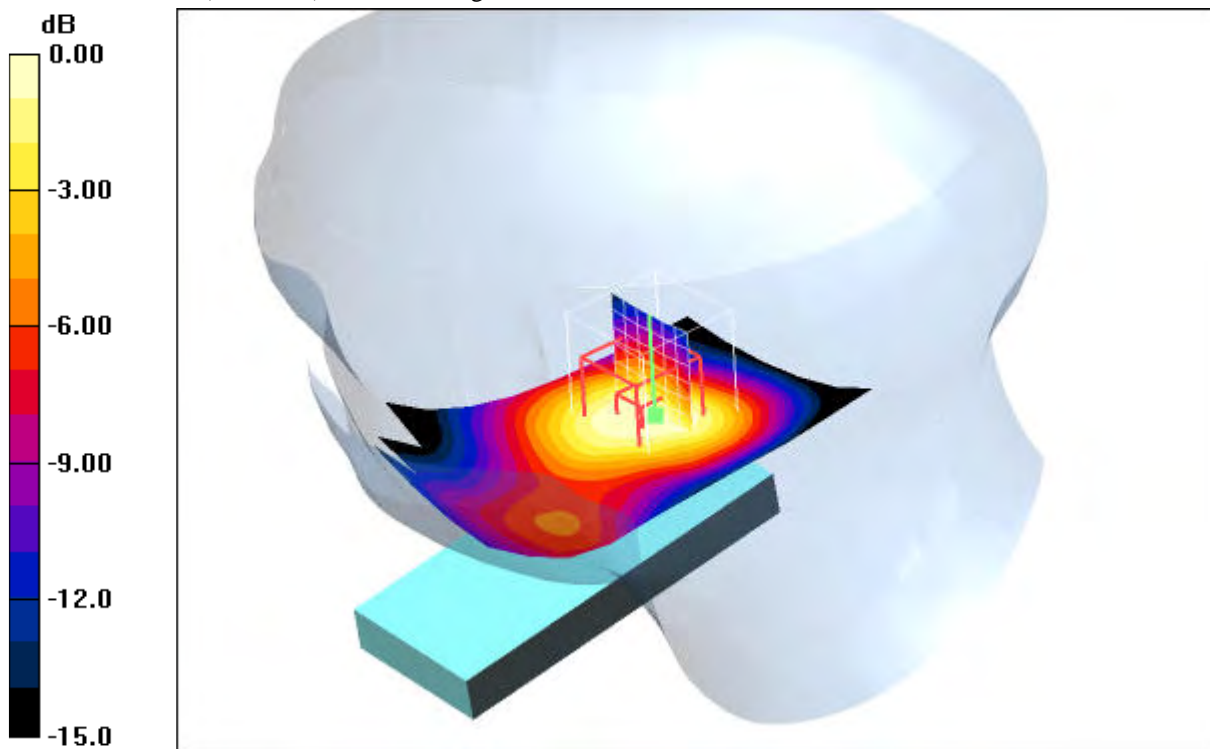

0 dB = 0.374mW/g

**Additional information:**

position or distance of DUT to SAM (if not standard head positions) :

ambient temperature: 22.6°C; liquid temperature: 21.2°C



**Annex 2.4 PCS 1900 MHz body**

Date/Time: 2009-03-25 09:29:31 Date/Time: 2009-03-25 09:57:53 Date/Time: 2009-03-25 10:09:40

**P1528\_OET65-Body-GSM1900 GPRS 2TS**

**DUT: Sony Ericsson; Type: AAD-3880008-BV; Serial: T261F007CD**

Communication System: PCS 1900 GPRS 2TS; Frequency: 1850.2 MHz; Duty Cycle: 1:4

Medium: M1900 Medium parameters used:  $f = 1850.2 \text{ MHz}$ ;  $\sigma = 1.48 \text{ mho/m}$ ;  $\epsilon_r = 53.1$ ;  $\rho = 1000 \text{ kg/m}^3$

Phantom section: Flat Section

DASY4 Configuration:

- Probe: ET3DV6 - SN1558; ConvF(4.39, 4.39, 4.39); Calibrated: 2008-08-15
- Sensor-Surface: 4mm (Mechanical And Optical Surface Detection)
- Electronics: DAE3 Sn413; Calibrated: 2009-01-08
- Phantom: SAM 12; Type: SAM; Serial: 1043
- Measurement SW: DASY4, V4.5 Build 19; Postprocessing SW: SEMCAD, V1.8 Build 146

**Front position - Low/Area Scan (51x91x1):** Measurement grid:  $dx=15\text{mm}$ ,  $dy=15\text{mm}$

Maximum value of SAR (interpolated) = 0.480 mW/g

**Front position - Low/Zoom Scan (7x7x7) (7x7x7)/Cube 0:** Measurement grid:  $dx=5\text{mm}$ ,  $dy=5\text{mm}$ ,  $dz=5\text{mm}$

Reference Value = 18.3 V/m; Power Drift = -0.152 dB

Peak SAR (extrapolated) = 0.718 W/kg

**SAR(1 g) = 0.423 mW/g; SAR(10 g) = 0.256 mW/g**

Maximum value of SAR (measured) = 0.461 mW/g

**Front position - Low/Zoom Scan (7x7x7) (7x7x7)/Cube 1:** Measurement grid:  $dx=5\text{mm}$ ,  $dy=5\text{mm}$ ,  $dz=5\text{mm}$

Reference Value = 18.3 V/m; Power Drift = -0.152 dB

Peak SAR (extrapolated) = 0.590 W/kg

**SAR(1 g) = 0.366 mW/g; SAR(10 g) = 0.238 mW/g**

Maximum value of SAR (measured) = 0.387 mW/g

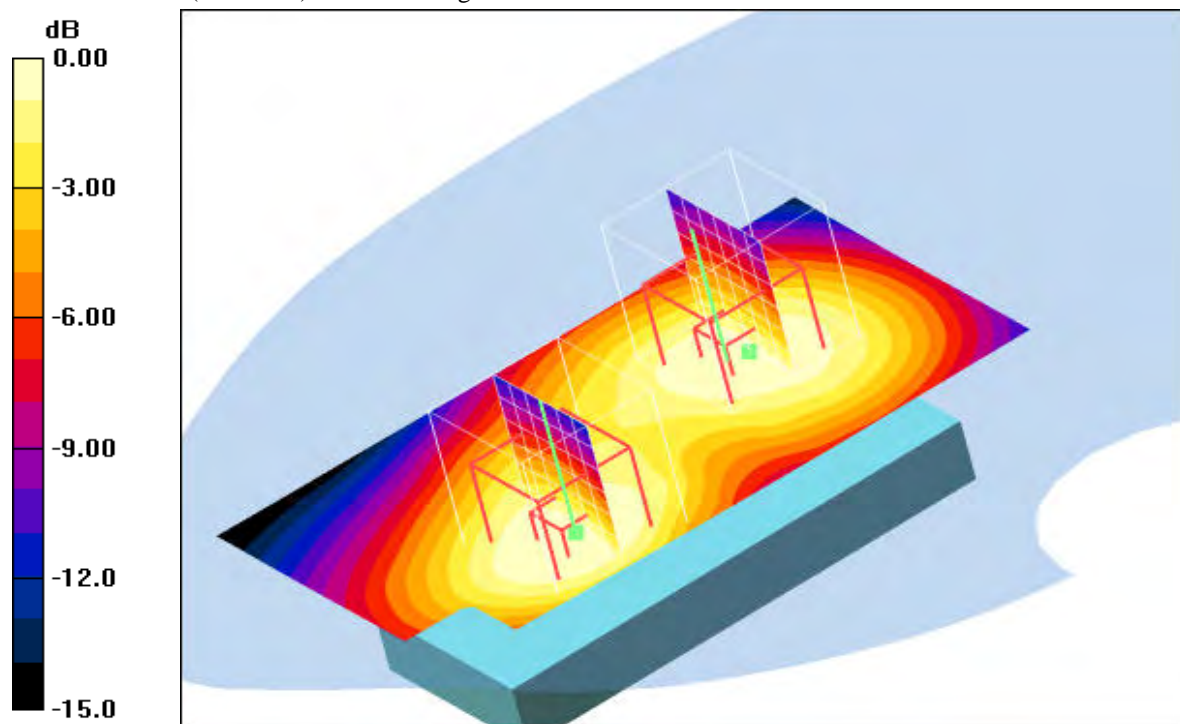

0 dB = 0.387mW/g

**Additional information:**

position or distance of DUT to SAM : 15 mm

ambient temperature: 22.5°C; liquid temperature: 21.3°C

Date/Time: 2009-03-25 10:25:57 Date/Time: 2009-03-25 10:32:16 Date/Time: 2009-03-25 10:44:42

**P1528\_OET65-Body-GSM1900 GPRS 2TS**

**DUT: Sony Ericsson; Type: AAD-3880008-BV; Serial: T261F007CD**

Communication System: PCS 1900 GPRS 2TS; Frequency: 1880 MHz; Duty Cycle: 1:4

Medium: M1900 Medium parameters used:  $f = 1880 \text{ MHz}$ ;  $\sigma = 1.48 \text{ mho/m}$ ;  $\epsilon_r = 53.1$ ;  $\rho = 1000 \text{ kg/m}^3$

Phantom section: Flat Section

DASY4 Configuration:

- Probe: ET3DV6 - SN1558; ConvF(4.39, 4.39, 4.39); Calibrated: 2008-08-15
- Sensor-Surface: 4mm (Mechanical And Optical Surface Detection)
- Electronics: DAE3 Sn413; Calibrated: 2009-01-08
- Phantom: SAM 12; Type: SAM; Serial: 1043
- Measurement SW: DASY4, V4.5 Build 19; Postprocessing SW: SEMCAD, V1.8 Build 146

**Front position - Middle/Area Scan (51x91x1):** Measurement grid:  $dx=15\text{mm}$ ,  $dy=15\text{mm}$

Maximum value of SAR (interpolated) = 0.446 mW/g

**Front position - Middle/Zoom Scan (7x7x7) (7x7x7)/Cube 0:** Measurement grid:  $dx=5\text{mm}$ ,  $dy=5\text{mm}$ ,  $dz=5\text{mm}$

Reference Value = 17.7 V/m; Power Drift = -0.045 dB

Peak SAR (extrapolated) = 0.683 W/kg

**SAR(1 g) = 0.400 mW/g; SAR(10 g) = 0.238 mW/g**

Maximum value of SAR (measured) = 0.429 mW/g

**Front position - Middle/Zoom Scan (7x7x7) (7x7x7)/Cube 1:** Measurement grid:  $dx=5\text{mm}$ ,  $dy=5\text{mm}$ ,  $dz=5\text{mm}$

Reference Value = 17.7 V/m; Power Drift = -0.045 dB

Peak SAR (extrapolated) = 0.561 W/kg

**SAR(1 g) = 0.342 mW/g; SAR(10 g) = 0.220 mW/g**

Maximum value of SAR (measured) = 0.360 mW/g

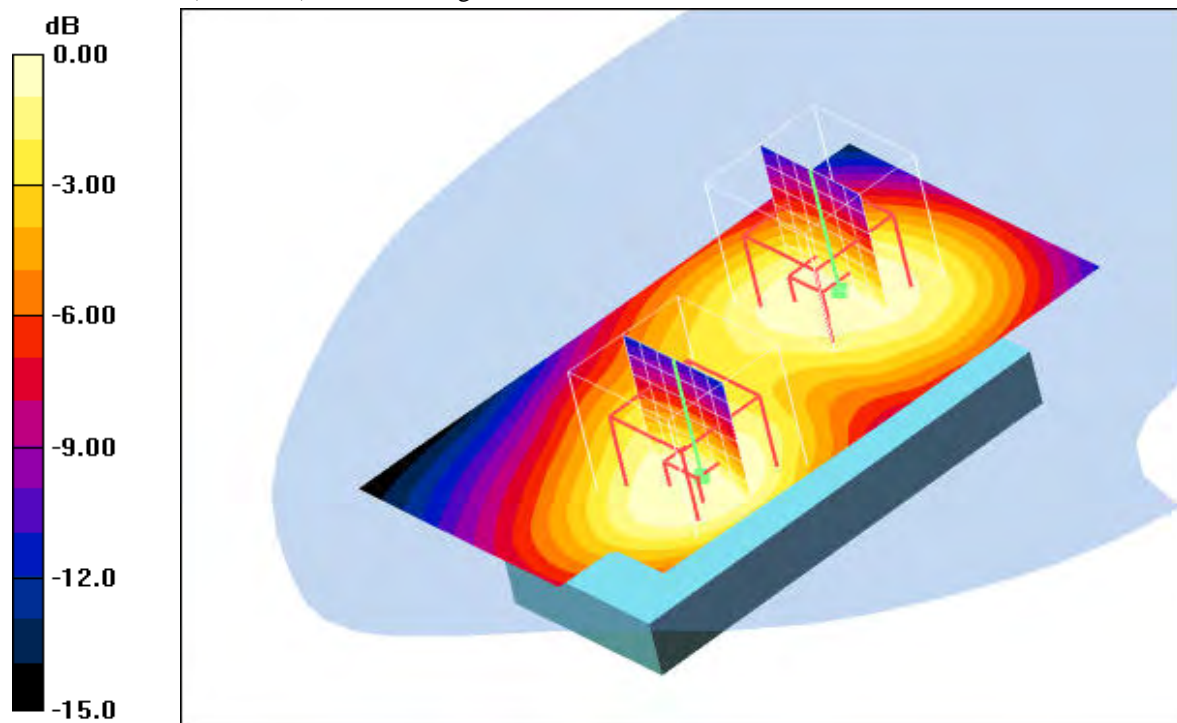

0 dB = 0.360mW/g

**Additional information:**

position or distance of DUT to SAM : 15 mm

ambient temperature: 22.5°C; liquid temperature: 21.3°C

Date/Time: 2009-03-25 11:00:34 Date/Time: 2009-03-25 11:37:47 Date/Time: 2009-03-25 11:49:41

**P1528\_OET65-Body-GSM1900 GPRS 2TS**

**DUT: Sony Ericsson; Type: AAD-3880008-BV; Serial: T261F007CD**

Communication System: PCS 1900 GPRS 2TS; Frequency: 1909.8 MHz; Duty Cycle: 1:4

Medium: M1900 Medium parameters used:  $f = 1909.8 \text{ MHz}$ ;  $\sigma = 1.48 \text{ mho/m}$ ;  $\epsilon_r = 53.1$ ;  $\rho = 1000 \text{ kg/m}^3$

Phantom section: Flat Section

DASY4 Configuration:

- Probe: ET3DV6 - SN1558; ConvF(4.39, 4.39, 4.39); Calibrated: 2008-08-15
- Sensor-Surface: 4mm (Mechanical And Optical Surface Detection)
- Electronics: DAE3 Sn413; Calibrated: 2009-01-08
- Phantom: SAM 12; Type: SAM; Serial: 1043
- Measurement SW: DASY4, V4.5 Build 19; Postprocessing SW: SEMCAD, V1.8 Build 146

**Front position - High/Area Scan (51x91x1):** Measurement grid:  $dx=15\text{mm}$ ,  $dy=15\text{mm}$

Maximum value of SAR (interpolated) = 0.383 mW/g

**Front position - High/Zoom Scan (7x7x7) (7x7x7)/Cube 0:** Measurement grid:  $dx=5\text{mm}$ ,  $dy=5\text{mm}$ ,  $dz=5\text{mm}$

Reference Value = 16.5 V/m; Power Drift = 0.027 dB

Peak SAR (extrapolated) = 0.616 W/kg

**SAR(1 g) = 0.348 mW/g; SAR(10 g) = 0.206 mW/g**

Maximum value of SAR (measured) = 0.375 mW/g

**Front position - High/Zoom Scan (7x7x7) (7x7x7)/Cube 1:** Measurement grid:  $dx=5\text{mm}$ ,  $dy=5\text{mm}$ ,  $dz=5\text{mm}$

Reference Value = 16.5 V/m; Power Drift = 0.027 dB

Peak SAR (extrapolated) = 0.478 W/kg

**SAR(1 g) = 0.287 mW/g; SAR(10 g) = 0.184 mW/g**

Maximum value of SAR (measured) = 0.302 mW/g

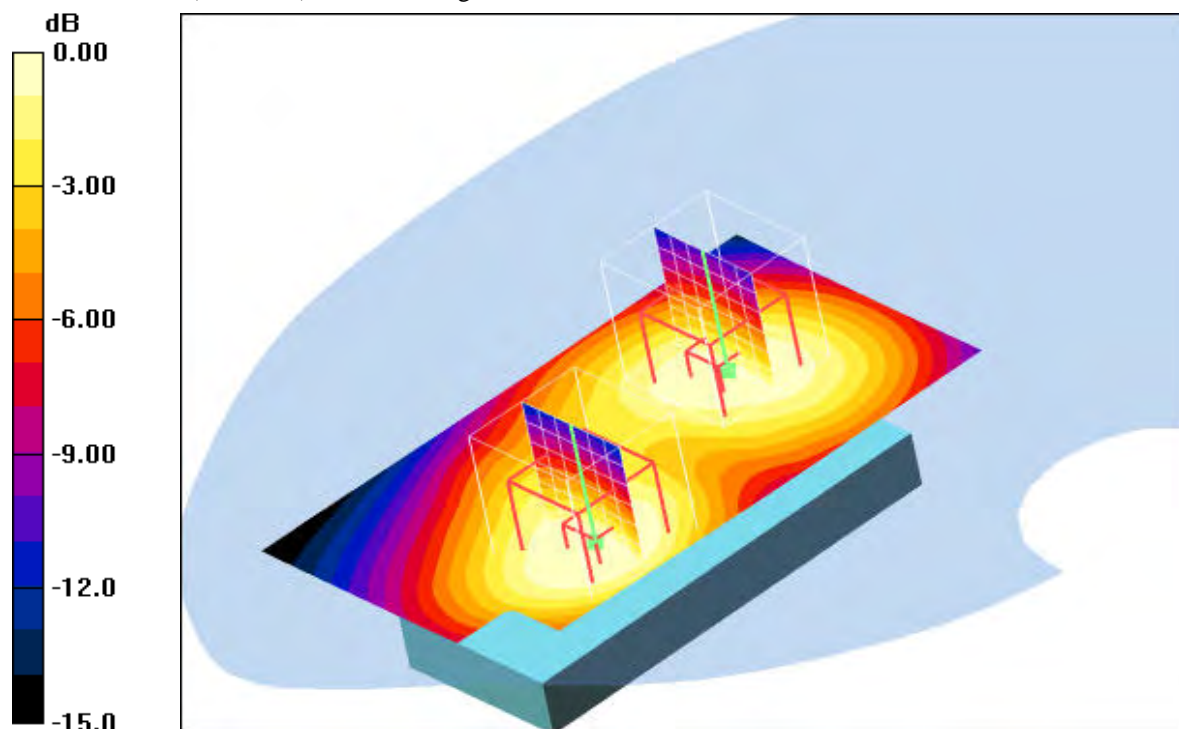

0 dB = 0.302mW/g

**Additional information:**

position or distance of DUT to SAM : 15 mm

ambient temperature: 22.5°C; liquid temperature: 21.3°C

Date/Time: 2009-03-25 12:58:00 Date/Time: 2009-03-25 13:04:36 Date/Time: 2009-03-25 13:17:46

**P1528\_OET65-Body-GSM1900 GPRS 2TS**

**DUT: Sony Ericsson; Type: AAD-3880008-BV; Serial: T261F007CD**

Communication System: PCS 1900 GPRS 2TS; Frequency: 1850.2 MHz; Duty Cycle: 1:4

Medium: M1900 Medium parameters used:  $f = 1850.2 \text{ MHz}$ ;  $\sigma = 1.48 \text{ mho/m}$ ;  $\epsilon_r = 53.1$ ;  $\rho = 1000 \text{ kg/m}^3$

Phantom section: Flat Section

DASY4 Configuration:

- Probe: ET3DV6 - SN1558; ConvF(4.39, 4.39, 4.39); Calibrated: 2008-08-15
- Sensor-Surface: 4mm (Mechanical And Optical Surface Detection)
- Electronics: DAE3 Sn413; Calibrated: 2009-01-08
- Phantom: SAM 12; Type: SAM; Serial: 1043
- Measurement SW: DASY4, V4.5 Build 19; Postprocessing SW: SEMCAD, V1.8 Build 146

**Rear position - Low/Area Scan (51x91x1):** Measurement grid:  $dx=15\text{mm}$ ,  $dy=15\text{mm}$

Maximum value of SAR (interpolated) = 0.728 mW/g

**Rear position - Low/Zoom Scan (7x7x7) (7x7x7)/Cube 0:** Measurement grid:  $dx=5\text{mm}$ ,  $dy=5\text{mm}$ ,  $dz=5\text{mm}$

Reference Value = 21.6 V/m; Power Drift = -0.017 dB

Peak SAR (extrapolated) = 1.19 W/kg

**SAR(1 g) = 0.653 mW/g; SAR(10 g) = 0.378 mW/g**

Maximum value of SAR (measured) = 0.709 mW/g

**Rear position - Low/Zoom Scan (7x7x7) (7x7x7)/Cube 1:** Measurement grid:  $dx=5\text{mm}$ ,  $dy=5\text{mm}$ ,  $dz=5\text{mm}$

Reference Value = 21.6 V/m; Power Drift = -0.017 dB

Peak SAR (extrapolated) = 0.677 W/kg

**SAR(1 g) = 0.435 mW/g; SAR(10 g) = 0.282 mW/g**

Maximum value of SAR (measured) = 0.460 mW/g

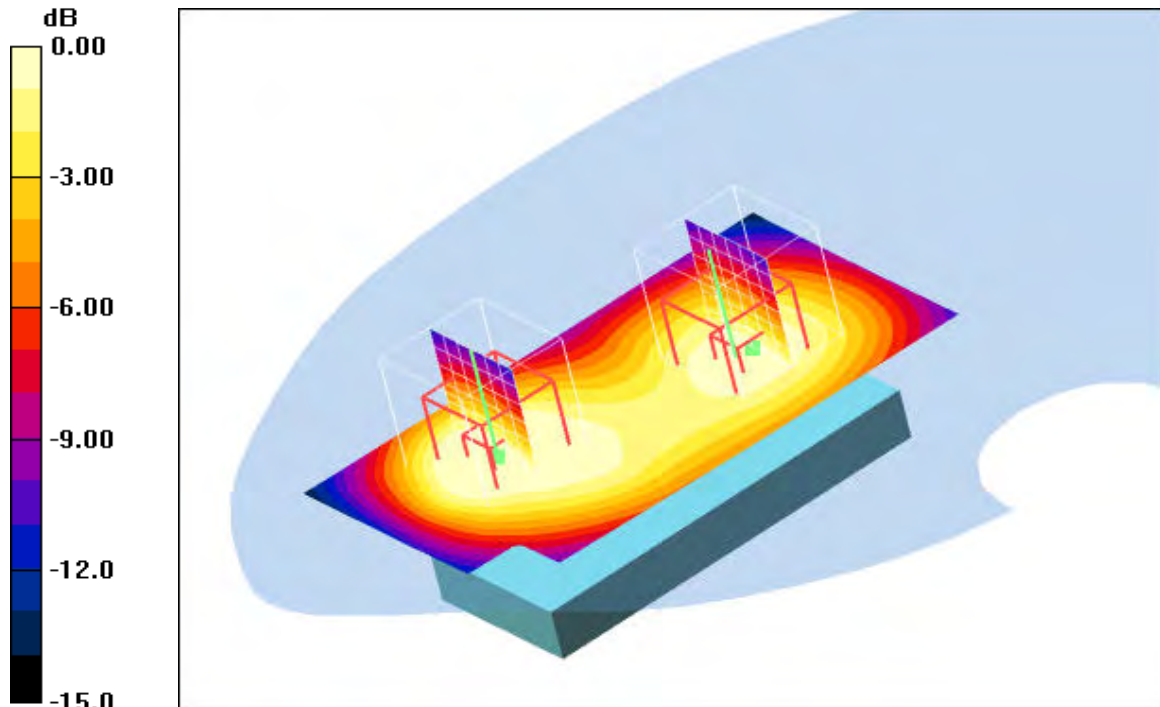

0 dB = 0.460mW/g

**Additional information:**

position or distance of DUT to SAM : 15 mm

ambient temperature: 22.5°C; liquid temperature: 21.3°C

Date/Time: 2009-03-25 12:35:11 Date/Time: 2009-03-25 12:41:58

**P1528\_OET65-Body-GSM1900 GPRS 2TS**

**DUT: Sony Ericsson; Type: AAD-3880008-BV; Serial: T261F007CD**

Communication System: PCS 1900 GPRS 2TS; Frequency: 1880 MHz; Duty Cycle: 1:4

Medium: M1900 Medium parameters used:  $f = 1880 \text{ MHz}$ ;  $\sigma = 1.48 \text{ mho/m}$ ;  $\epsilon_r = 53.1$ ;  $\rho = 1000 \text{ kg/m}^3$

Phantom section: Flat Section

DASY4 Configuration:

- Probe: ET3DV6 - SN1558; ConvF(4.39, 4.39, 4.39); Calibrated: 2008-08-15
- Sensor-Surface: 4mm (Mechanical And Optical Surface Detection)
- Electronics: DAE3 Sn413; Calibrated: 2009-01-08
- Phantom: SAM 12; Type: SAM; Serial: 1043
- Measurement SW: DASY4, V4.5 Build 19; Postprocessing SW: SEMCAD, V1.8 Build 146

**Rear position - Middle/Area Scan (51x91x1):** Measurement grid: dx=15mm, dy=15mm

Maximum value of SAR (interpolated) = 0.723 mW/g

**Rear position - Middle/Zoom Scan (7x7x7) (7x7x7)/Cube 0:** Measurement grid: dx=5mm, dy=5mm, dz=5mm

Reference Value = 21.4 V/m; Power Drift = -0.01 dB

Peak SAR (extrapolated) = 1.17 W/kg

**SAR(1 g) = 0.646 mW/g; SAR(10 g) = 0.375 mW/g**

Maximum value of SAR (measured) = 0.692 mW/g

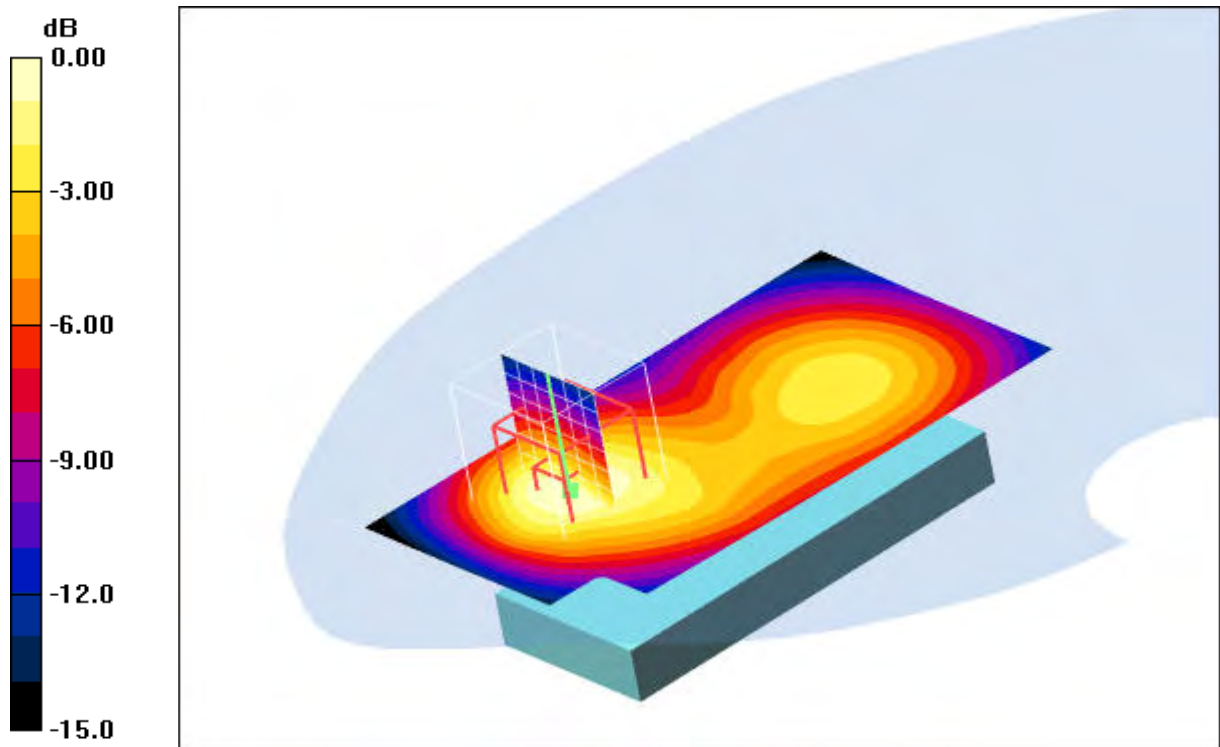

0 dB = 0.692mW/g

**Additional information:**

position or distance of DUT to SAM : 15 mm

ambient temperature: 22.5°C; liquid temperature: 21.3°C

Date/Time: 2009-03-25 12:12:11 Date/Time: 2009-03-25 12:18:46

**P1528\_OET65-Body-GSM1900 GPRS 2TS**

**DUT: Sony Ericsson; Type: AAD-3880008-BV; Serial: T261F007CD**

Communication System: PCS 1900 GPRS 2TS; Frequency: 1909.8 MHz; Duty Cycle: 1:4

Medium: M1900 Medium parameters used:  $f = 1909.8 \text{ MHz}$ ;  $\sigma = 1.48 \text{ mho/m}$ ;  $\epsilon_r = 53.1$ ;  $\rho = 1000 \text{ kg/m}^3$

Phantom section: Flat Section

DASY4 Configuration:

- Probe: ET3DV6 - SN1558; ConvF(4.39, 4.39, 4.39); Calibrated: 2008-08-15
- Sensor-Surface: 4mm (Mechanical And Optical Surface Detection)
- Electronics: DAE3 Sn413; Calibrated: 2009-01-08
- Phantom: SAM 12; Type: SAM; Serial: 1043
- Measurement SW: DASY4, V4.5 Build 19; Postprocessing SW: SEMCAD, V1.8 Build 146

**Rear position -High/Area Scan (51x91x1):** Measurement grid:  $dx=15\text{mm}$ ,  $dy=15\text{mm}$

Maximum value of SAR (interpolated) = 0.628 mW/g

**Rear position -High/Zoom Scan (7x7x7) (7x7x7)/Cube 0:** Measurement grid:  $dx=5\text{mm}$ ,  $dy=5\text{mm}$ ,  $dz=5\text{mm}$

Reference Value = 19.7 V/m; Power Drift = 0.026 dB

Peak SAR (extrapolated) = 1.02 W/kg

**SAR(1 g) = 0.555 mW/g; SAR(10 g) = 0.322 mW/g**

Maximum value of SAR (measured) = 0.598 mW/g

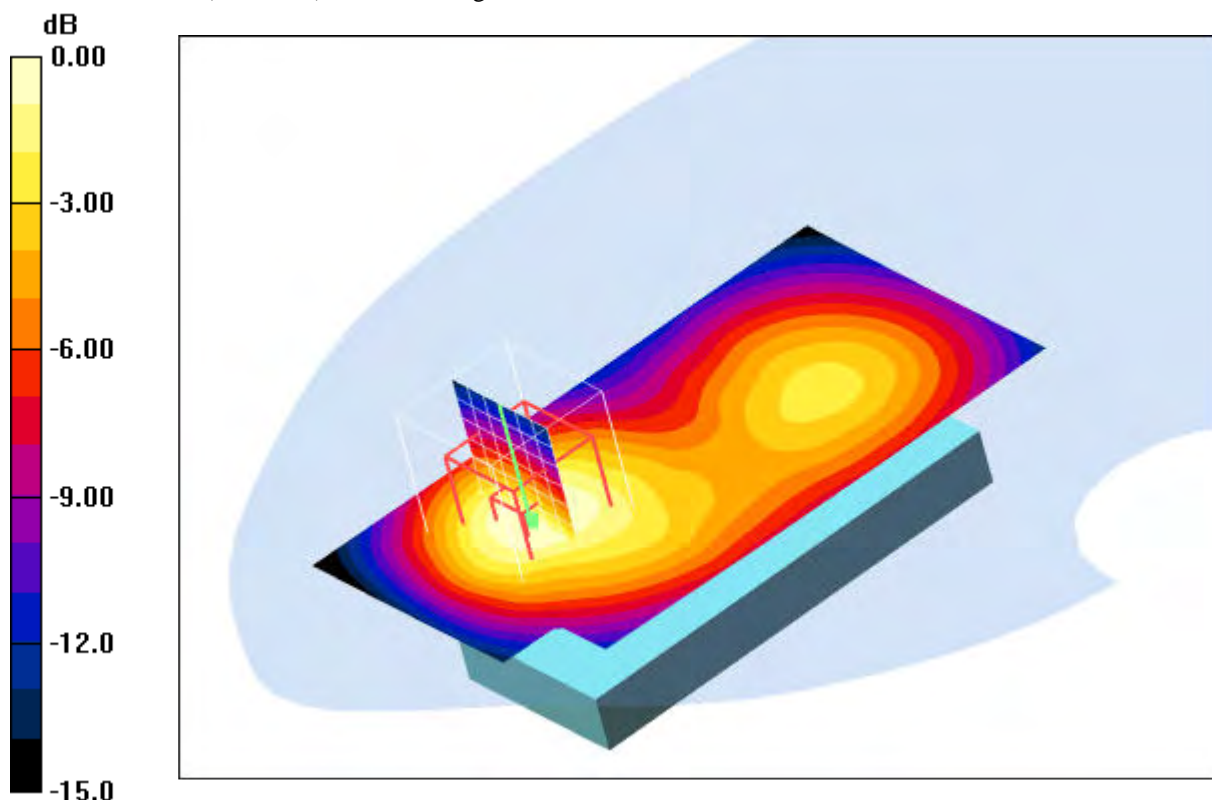

0 dB = 0.598mW/g

**Additional information:**

position or distance of DUT to SAM : 15 mm

ambient temperature: 22.5°C; liquid temperature: 21.3°C

Date/Time: 2009-03-25 13:33:41 Date/Time: 2009-03-25 13:41:16 Date/Time: 2009-03-25 13:55:03

**P1528\_OET65-Body-GSM1900 GPRS 1TS**

**DUT: Sony Ericsson; Type: AAD-3880008-BV; Serial: T261F007CD**

Communication System: PCS 1900 GPRS 1TS; Frequency: 1850.2 MHz; Duty Cycle: 1:8

Medium: M1900 Medium parameters used:  $f = 1850.2 \text{ MHz}$ ;  $\sigma = 1.48 \text{ mho/m}$ ;  $\epsilon_r = 53.1$ ;  $\rho = 1000 \text{ kg/m}^3$

Phantom section: Flat Section

DASY4 Configuration:

- Probe: ET3DV6 - SN1558; ConvF(4.39, 4.39, 4.39); Calibrated: 2008-08-15
- Sensor-Surface: 4mm (Mechanical And Optical Surface Detection)
- Electronics: DAE3 Sn413; Calibrated: 2009-01-08
- Phantom: SAM 12; Type: SAM; Serial: 1043
- Measurement SW: DASY4, V4.5 Build 19; Postprocessing SW: SEMCAD, V1.8 Build 146

**Rear position - Low/Area Scan (51x91x1):** Measurement grid:  $dx=15\text{mm}$ ,  $dy=15\text{mm}$   
 Maximum value of SAR (interpolated) = 0.491 mW/g

**Rear position - Low/Zoom Scan (7x7x7) (7x7x7)/Cube 0:** Measurement grid:  $dx=5\text{mm}$ ,  $dy=5\text{mm}$ ,  $dz=5\text{mm}$   
 Reference Value = 17.6 V/m; Power Drift = 0.040 dB  
 Peak SAR (extrapolated) = 0.789 W/kg  
**SAR(1 g) = 0.436 mW/g; SAR(10 g) = 0.254 mW/g**  
 Maximum value of SAR (measured) = 0.471 mW/g

**Rear position - Low/Zoom Scan (7x7x7) (7x7x7)/Cube 1:** Measurement grid:  $dx=5\text{mm}$ ,  $dy=5\text{mm}$ ,  $dz=5\text{mm}$   
 Reference Value = 17.6 V/m; Power Drift = 0.040 dB  
 Peak SAR (extrapolated) = 0.458 W/kg  
**SAR(1 g) = 0.293 mW/g; SAR(10 g) = 0.190 mW/g**  
 Maximum value of SAR (measured) = 0.314 mW/g

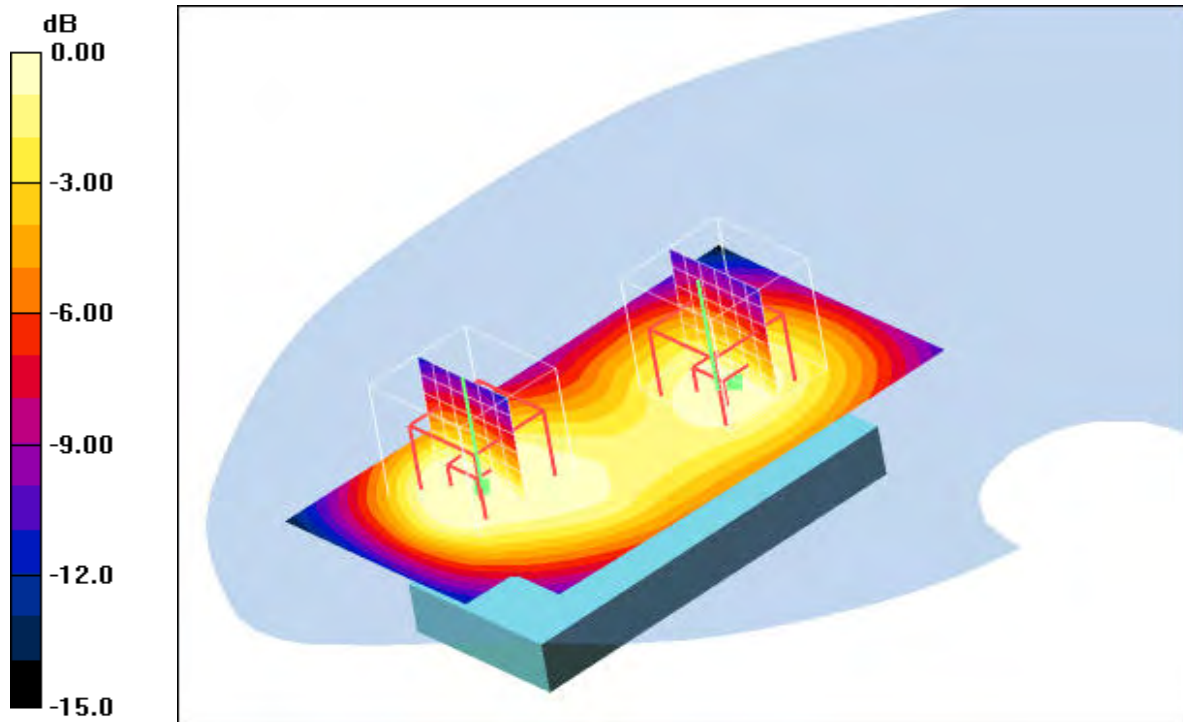

0 dB = 0.314mW/g

**Additional information:**

position or distance of DUT to SAM : 15 mm

ambient temperature: 22.5°C; liquid temperature: 21.3°C

**Annex 2.5 UMTS (WCDMA) FDD II 1900 MHz head**

Date/Time: 2009-03-23 16:46:03 Date/Time: 2009-03-23 16:52:14

**P1528\_OET65-LeftHandSide-UMTS-FDD-II**

**DUT: Sony Ericsson; Type: AAD-3880008-BV; Serial: T261F007CD**

Communication System: WCDMA FDD II; Frequency: 1852.5 MHz; Duty Cycle: 1:1

Medium: HSL1900 Medium parameters used (interpolated):  $f = 1852.5 \text{ MHz}$ ;  $\sigma = 1.39 \text{ mho/m}$ ;  $\epsilon_r = 40.4$ ;  $\rho = 1000 \text{ kg/m}^3$

Phantom section: Left Section

DASY4 Configuration:

- Probe: ET3DV6 - SN1558; ConvF(4.96, 4.96, 4.96); Calibrated: 2008-08-15
- Sensor-Surface: 4mm (Mechanical And Optical Surface Detection)
- Electronics: DAE3 Sn413; Calibrated: 2009-01-08
- Phantom: SAM 12; Type: SAM; Serial: 1043
- Measurement SW: DASY4, V4.5 Build 19; Postprocessing SW: SEMCAD, V1.8 Build 146

**Touch position - Low/Area Scan (51x91x1):** Measurement grid:  $dx=15\text{mm}$ ,  $dy=15\text{mm}$

Maximum value of SAR (interpolated) = 1.40 mW/g

**Touch position - Low/Zoom Scan (7x7x7) (7x7x7)/Cube 0:** Measurement grid:  $dx=5\text{mm}$ ,  $dy=5\text{mm}$ ,  $dz=5\text{mm}$

Reference Value = 32.0 V/m; Power Drift = 0.011 dB

Peak SAR (extrapolated) = 1.73 W/kg

**SAR(1 g) = 1.22 mW/g; SAR(10 g) = 0.721 mW/g**

Maximum value of SAR (measured) = 1.32 mW/g

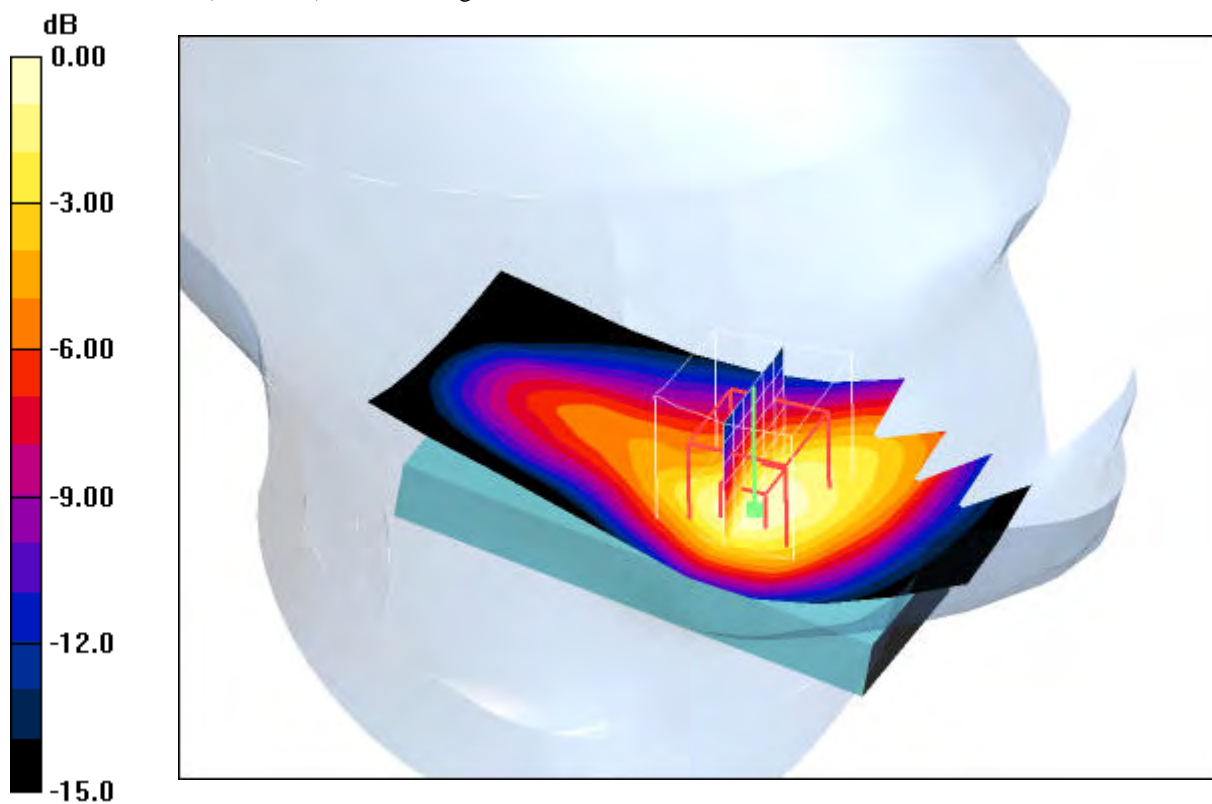

0 dB = 1.32mW/g

**Additional information:**

position or distance of DUT to SAM (if not standard head positions) :

ambient temperature: 22.9°C; liquid temperature: 22.0°C



Date/Time: 2009-03-23 16:21:52 Date/Time: 2009-03-23 16:28:08

**P1528\_OET65-LeftHandSide-UMTS-FDD-II**

**DUT: Sony Ericsson; Type: AAD-3880008-BV; Serial: T261F007CD**

Communication System: WCDMA FDD II; Frequency: 1880 MHz; Duty Cycle: 1:1

Medium: HSL1900 Medium parameters used:  $f = 1880 \text{ MHz}$ ;  $\sigma = 1.39 \text{ mho/m}$ ;  $\epsilon_r = 40.4$ ;  $\rho = 1000 \text{ kg/m}^3$

Phantom section: Left Section

DASY4 Configuration:

- Probe: ET3DV6 - SN1558; ConvF(4.96, 4.96, 4.96); Calibrated: 2008-08-15
- Sensor-Surface: 4mm (Mechanical And Optical Surface Detection)
- Electronics: DAE3 Sn413; Calibrated: 2009-01-08
- Phantom: SAM 12; Type: SAM; Serial: 1043
- Measurement SW: DASY4, V4.5 Build 19; Postprocessing SW: SEMCAD, V1.8 Build 146

**Touch position - Middle/Area Scan (51x91x1):** Measurement grid:  $dx=15\text{mm}$ ,  $dy=15\text{mm}$

Maximum value of SAR (interpolated) = 1.37 mW/g

**Touch position - Middle/Zoom Scan (7x7x7) (7x7x7)/Cube 0:** Measurement grid:  $dx=5\text{mm}$ ,  $dy=5\text{mm}$ ,  $dz=5\text{mm}$

Reference Value = 31.4 V/m; Power Drift = 0.066 dB

Peak SAR (extrapolated) = 1.70 W/kg

**SAR(1 g) = 1.18 mW/g; SAR(10 g) = 0.696 mW/g**

Maximum value of SAR (measured) = 1.26 mW/g

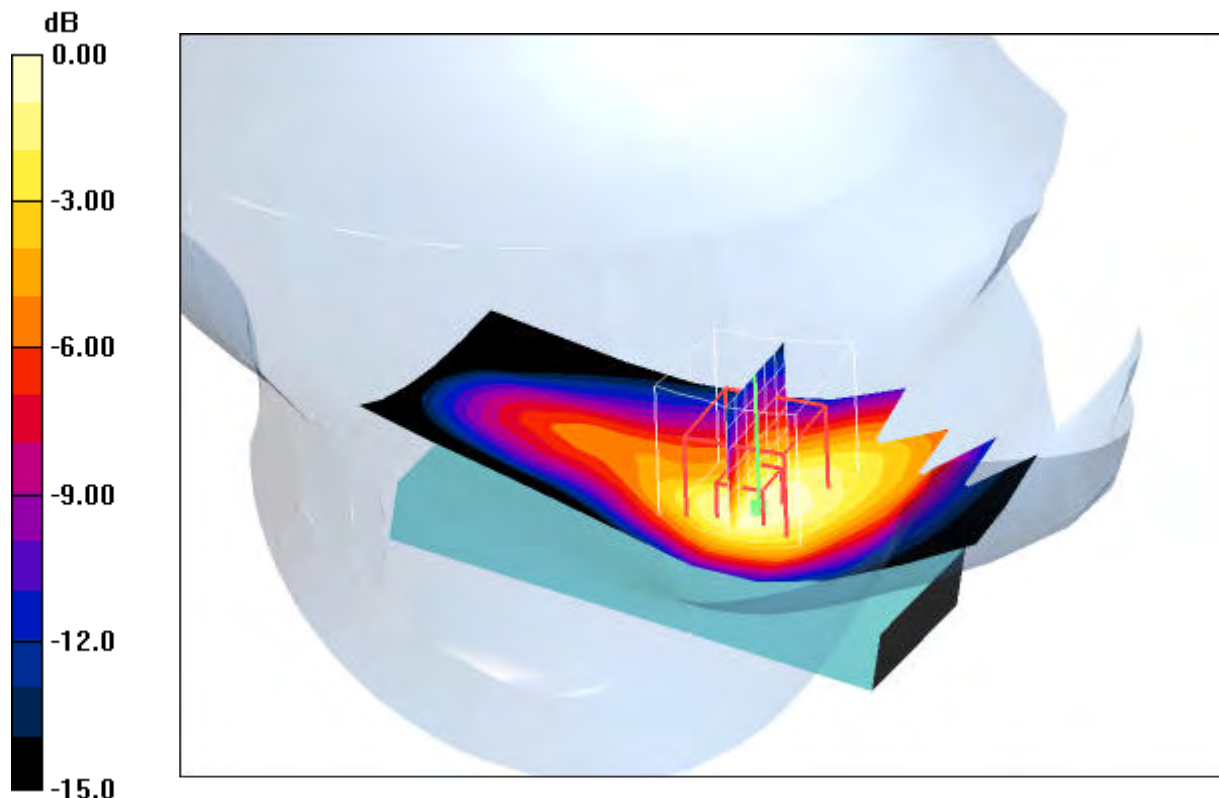

0 dB = 1.26mW/g

**Additional information:**

position or distance of DUT to SAM (if not standard head positions) :

ambient temperature: 22.9°C; liquid temperature: 22.0°C

Date/Time: 2009-03-23 17:06:53 Date/Time: 2009-03-23 17:13:07

**P1528\_OET65-LeftHandSide-UMTS-FDD-II**

**DUT: Sony Ericsson; Type: AAD-3880008-BV; Serial: T261F007CD**

Communication System: WCDMA FDD II; Frequency: 1907.6 MHz; Duty Cycle: 1:1

Medium: HSL1900 Medium parameters used (interpolated):  $f = 1907.6 \text{ MHz}$ ;  $\sigma = 1.39 \text{ mho/m}$ ;  $\epsilon_r = 40.4$ ;  $\rho = 1000 \text{ kg/m}^3$

Phantom section: Left Section

DASY4 Configuration:

- Probe: ET3DV6 - SN1558; ConvF(4.96, 4.96, 4.96); Calibrated: 2008-08-15
- Sensor-Surface: 4mm (Mechanical And Optical Surface Detection)
- Electronics: DAE3 Sn413; Calibrated: 2009-01-08
- Phantom: SAM 12; Type: SAM; Serial: 1043
- Measurement SW: DASY4, V4.5 Build 19; Postprocessing SW: SEMCAD, V1.8 Build 146

**Touch position - High/Area Scan (51x91x1):** Measurement grid:  $dx=15\text{mm}$ ,  $dy=15\text{mm}$

Maximum value of SAR (interpolated) = 1.52 mW/g

**Touch position - High/Zoom Scan (7x7x7) (7x7x7)/Cube 0:** Measurement grid:  $dx=5\text{mm}$ ,  $dy=5\text{mm}$ ,  $dz=5\text{mm}$

Reference Value = 33.4 V/m; Power Drift = 0.01 dB

Peak SAR (extrapolated) = 1.92 W/kg

**SAR(1 g) = 1.3 mW/g; SAR(10 g) = 0.759 mW/g**

Maximum value of SAR (measured) = 1.40 mW/g

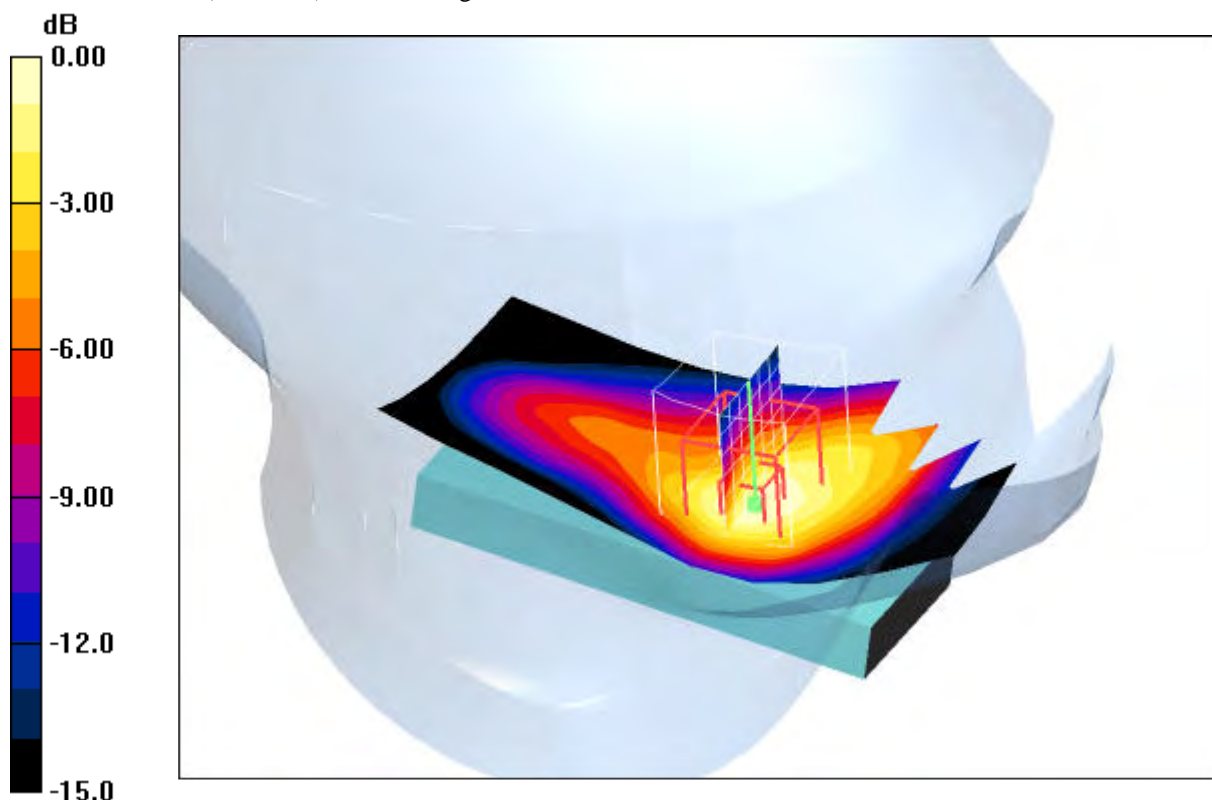

0 dB = 1.40mW/g

**Additional information:**

position or distance of DUT to SAM (if not standard head positions) :

ambient temperature: 22.9°C; liquid temperature: 22.0°C

Date/Time: 2009-03-23 20:07:27 Date/Time: 2009-03-23 20:14:03

**P1528\_OET65-LeftHandSide-UMTS-FDD-II**

**DUT: Sony Ericsson; Type: AAD-3880008-BV; Serial: T261F007CD**

Communication System: WCDMA FDD II; Frequency: 1852.5 MHz; Duty Cycle: 1:1

Medium: HSL1900 Medium parameters used (interpolated):  $f = 1852.5 \text{ MHz}$ ;  $\sigma = 1.39 \text{ mho/m}$ ;  $\epsilon_r = 40.4$ ;  $\rho = 1000 \text{ kg/m}^3$

Phantom section: Left Section

DASY4 Configuration:

- Probe: ET3DV6 - SN1558; ConvF(4.96, 4.96, 4.96); Calibrated: 2008-08-15
- Sensor-Surface: 4mm (Mechanical And Optical Surface Detection)
- Electronics: DAE3 Sn413; Calibrated: 2009-01-08
- Phantom: SAM 12; Type: SAM; Serial: 1043
- Measurement SW: DASY4, V4.5 Build 19; Postprocessing SW: SEMCAD, V1.8 Build 146

**Tilt position - Low/Area Scan (51x91x1):** Measurement grid:  $dx=15\text{mm}$ ,  $dy=15\text{mm}$

Maximum value of SAR (interpolated) = 0.470 mW/g

**Tilt position - Low/Zoom Scan (7x7x7) (7x7x7)/Cube 0:** Measurement grid:  $dx=5\text{mm}$ ,  $dy=5\text{mm}$ ,

$dz=5\text{mm}$

Reference Value = 18.3 V/m; Power Drift = -0.024 dB

Peak SAR (extrapolated) = 0.605 W/kg

**SAR(1 g) = 0.413 mW/g; SAR(10 g) = 0.261 mW/g**

Maximum value of SAR (measured) = 0.445 mW/g

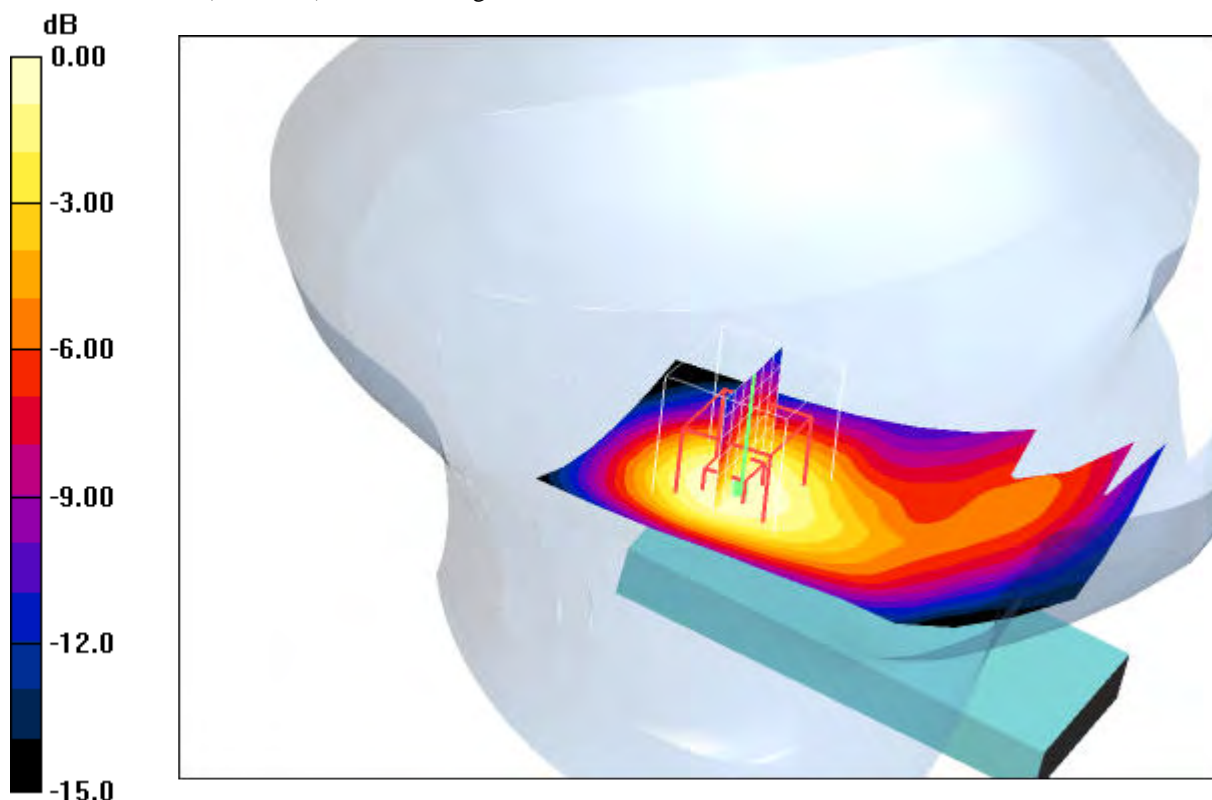

0 dB = 0.445mW/g

**Additional information:**

position or distance of DUT to SAM (if not standard head positions) :

ambient temperature: 22.7°C; liquid temperature: 22.0°C

Date/Time: 2009-03-23 20:29:36 Date/Time: 2009-03-23 20:36:22

**P1528\_OET65-LeftHandSide-UMTS-FDD-II**

**DUT: Sony Ericsson; Type: AAD-3880008-BV; Serial: T261F007CD**

Communication System: WCDMA FDD II; Frequency: 1880 MHz; Duty Cycle: 1:1

Medium: HSL1900 Medium parameters used:  $f = 1880 \text{ MHz}$ ;  $\sigma = 1.39 \text{ mho/m}$ ;  $\epsilon_r = 40.4$ ;  $\rho = 1000 \text{ kg/m}^3$

Phantom section: Left Section

DASY4 Configuration:

- Probe: ET3DV6 - SN1558; ConvF(4.96, 4.96, 4.96); Calibrated: 2008-08-15
- Sensor-Surface: 4mm (Mechanical And Optical Surface Detection)
- Electronics: DAE3 Sn413; Calibrated: 2009-01-08
- Phantom: SAM 12; Type: SAM; Serial: 1043
- Measurement SW: DASY4, V4.5 Build 19; Postprocessing SW: SEMCAD, V1.8 Build 146

**Tilt position - Middle/Area Scan (51x91x1):** Measurement grid:  $dx=15\text{mm}$ ,  $dy=15\text{mm}$

Maximum value of SAR (interpolated) = 0.453 mW/g

**Tilt position - Middle/Zoom Scan (7x7x7) (7x7x7)/Cube 0:** Measurement grid:  $dx=5\text{mm}$ ,  $dy=5\text{mm}$ ,  $dz=5\text{mm}$

Reference Value = 18.0 V/m; Power Drift = 0.01 dB

Peak SAR (extrapolated) = 0.601 W/kg

**SAR(1 g) = 0.400 mW/g; SAR(10 g) = 0.251 mW/g**

Maximum value of SAR (measured) = 0.428 mW/g

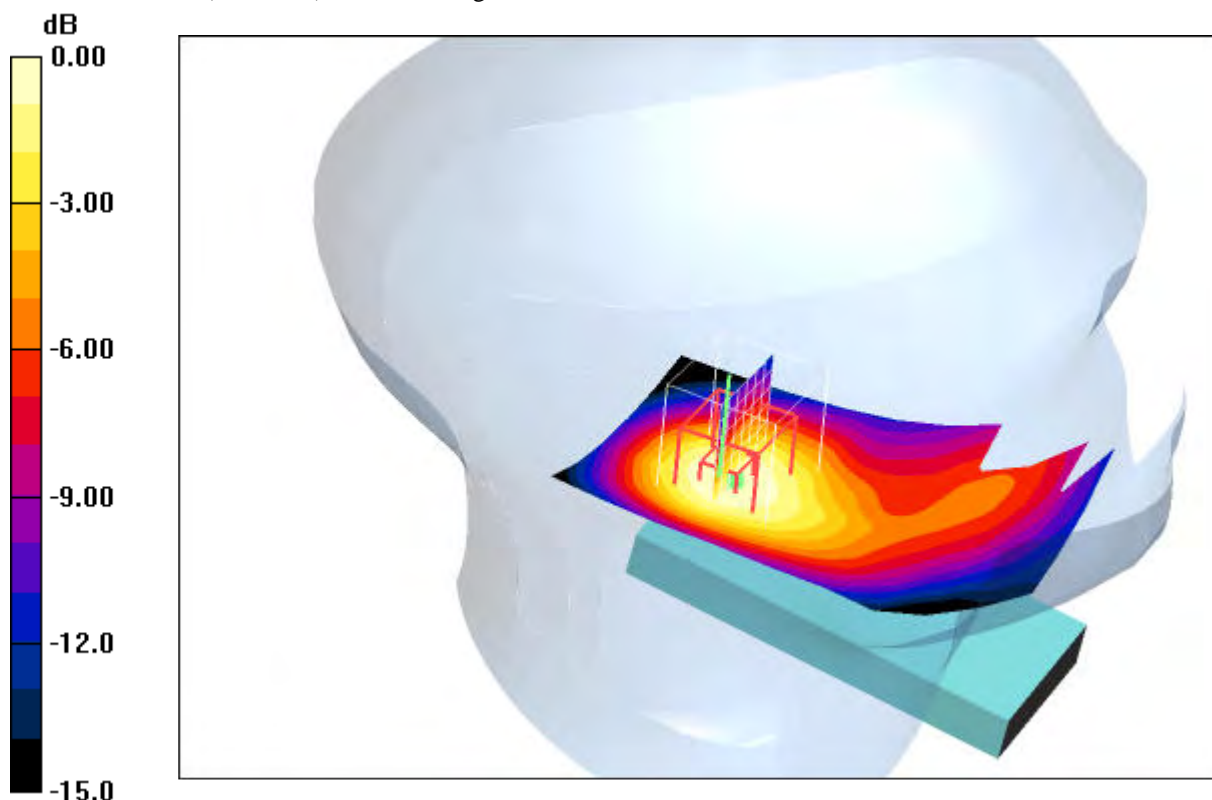

0 dB = 0.428mW/g

**Additional information:**

position or distance of DUT to SAM (if not standard head positions) :

ambient temperature: 22.7°C; liquid temperature: 22.0°C

Date/Time: 2009-03-23 20:49:21 Date/Time: 2009-03-23 20:55:55

**P1528\_OET65-LeftHandSide-UMTS-FDD-II**

**DUT: Sony Ericsson; Type: AAD-3880008-BV; Serial: T261F007CD**

Communication System: WCDMA FDD II; Frequency: 1907.6 MHz; Duty Cycle: 1:1

Medium: HSL1900 Medium parameters used (interpolated):  $f = 1907.6 \text{ MHz}$ ;  $\sigma = 1.39 \text{ mho/m}$ ;  $\epsilon_r = 40.4$ ;  $\rho = 1000 \text{ kg/m}^3$

Phantom section: Left Section

DASY4 Configuration:

- Probe: ET3DV6 - SN1558; ConvF(4.96, 4.96, 4.96); Calibrated: 2008-08-15
- Sensor-Surface: 4mm (Mechanical And Optical Surface Detection)
- Electronics: DAE3 Sn413; Calibrated: 2009-01-08
- Phantom: SAM 12; Type: SAM; Serial: 1043
- Measurement SW: DASY4, V4.5 Build 19; Postprocessing SW: SEMCAD, V1.8 Build 146

**Tilt position - High/Area Scan (51x91x1):** Measurement grid:  $dx=15\text{mm}$ ,  $dy=15\text{mm}$

Maximum value of SAR (interpolated) = 0.541 mW/g

**Tilt position - High/Zoom Scan (7x7x7) (7x7x7)/Cube 0:** Measurement grid:  $dx=5\text{mm}$ ,  $dy=5\text{mm}$ ,  $dz=5\text{mm}$

Reference Value = 19.8 V/m; Power Drift = 0.01 dB

Peak SAR (extrapolated) = 0.735 W/kg

**SAR(1 g) = 0.479 mW/g; SAR(10 g) = 0.296 mW/g**

Maximum value of SAR (measured) = 0.510 mW/g

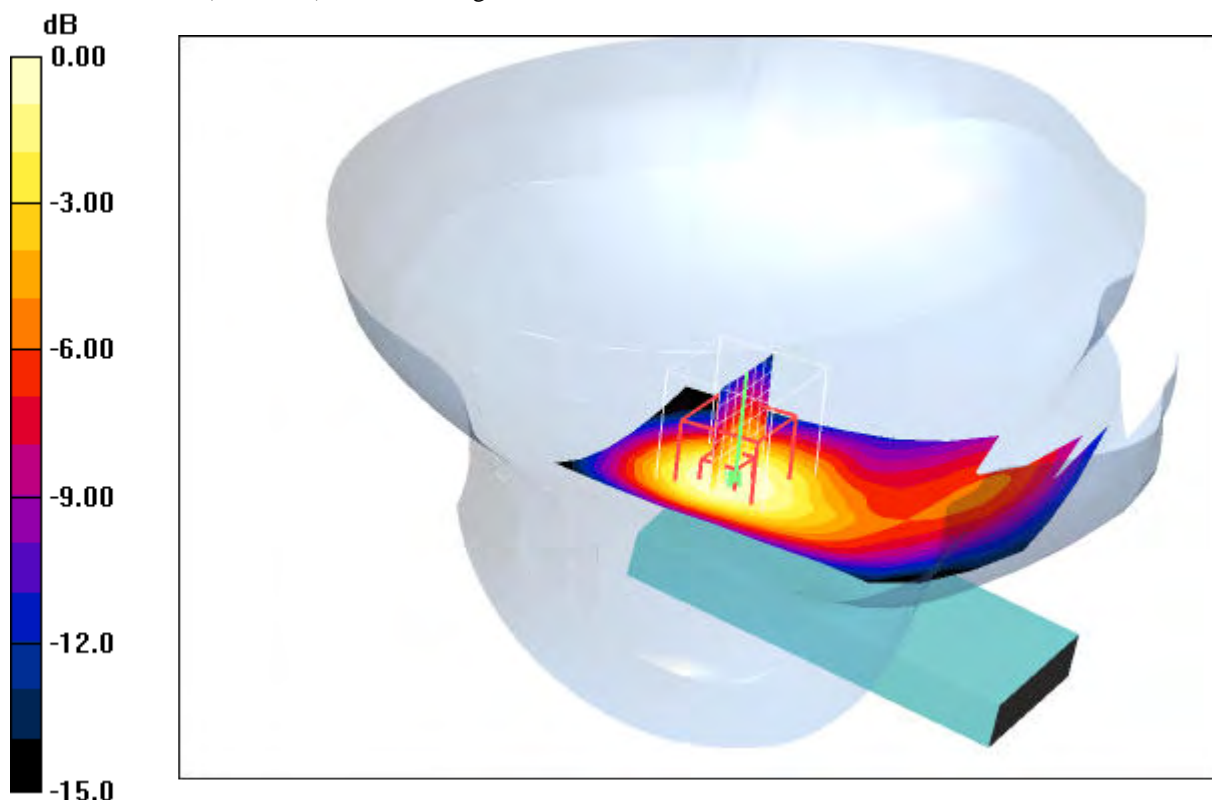

0 dB = 0.510mW/g

**Additional information:**

position or distance of DUT to SAM (if not standard head positions) :

ambient temperature: 22.7°C; liquid temperature: 22.0°C

Date/Time: 2009-03-23 18:17:37 Date/Time: 2009-03-23 18:23:48

**P1528\_OET65-RightHandSide-UMTS-FDD-II**

**DUT: Sony Ericsson; Type: AAD-3880008-BV; Serial: T261F007CD**

Communication System: WCDMA FDD II; Frequency: 1852.5 MHz; Duty Cycle: 1:1

Medium: HSL1900 Medium parameters used (interpolated):  $f = 1852.5 \text{ MHz}$ ;  $\sigma = 1.39 \text{ mho/m}$ ;  $\epsilon_r = 40.4$ ;  $\rho = 1000 \text{ kg/m}^3$

Phantom section: Right Section

DASY4 Configuration:

- Probe: ET3DV6 - SN1558; ConvF(4.96, 4.96, 4.96); Calibrated: 2008-08-15
- Sensor-Surface: 4mm (Mechanical And Optical Surface Detection)
- Electronics: DAE3 Sn413; Calibrated: 2009-01-08
- Phantom: SAM 12; Type: SAM; Serial: 1043
- Measurement SW: DASY4, V4.5 Build 19; Postprocessing SW: SEMCAD, V1.8 Build 146

**Touch position - Low/Area Scan (51x91x1):** Measurement grid:  $dx=15\text{mm}$ ,  $dy=15\text{mm}$

Maximum value of SAR (interpolated) = 1.44 mW/g

**Touch position - Low/Zoom Scan (7x7x7) (7x7x7)/Cube 0:** Measurement grid:  $dx=5\text{mm}$ ,  $dy=5\text{mm}$ ,  $dz=5\text{mm}$

Reference Value = 31.3 V/m; Power Drift = 0.104 dB

Peak SAR (extrapolated) = 2.19 W/kg

**SAR(1 g) = 1.32 mW/g; SAR(10 g) = 0.724 mW/g**

Maximum value of SAR (measured) = 1.47 mW/g

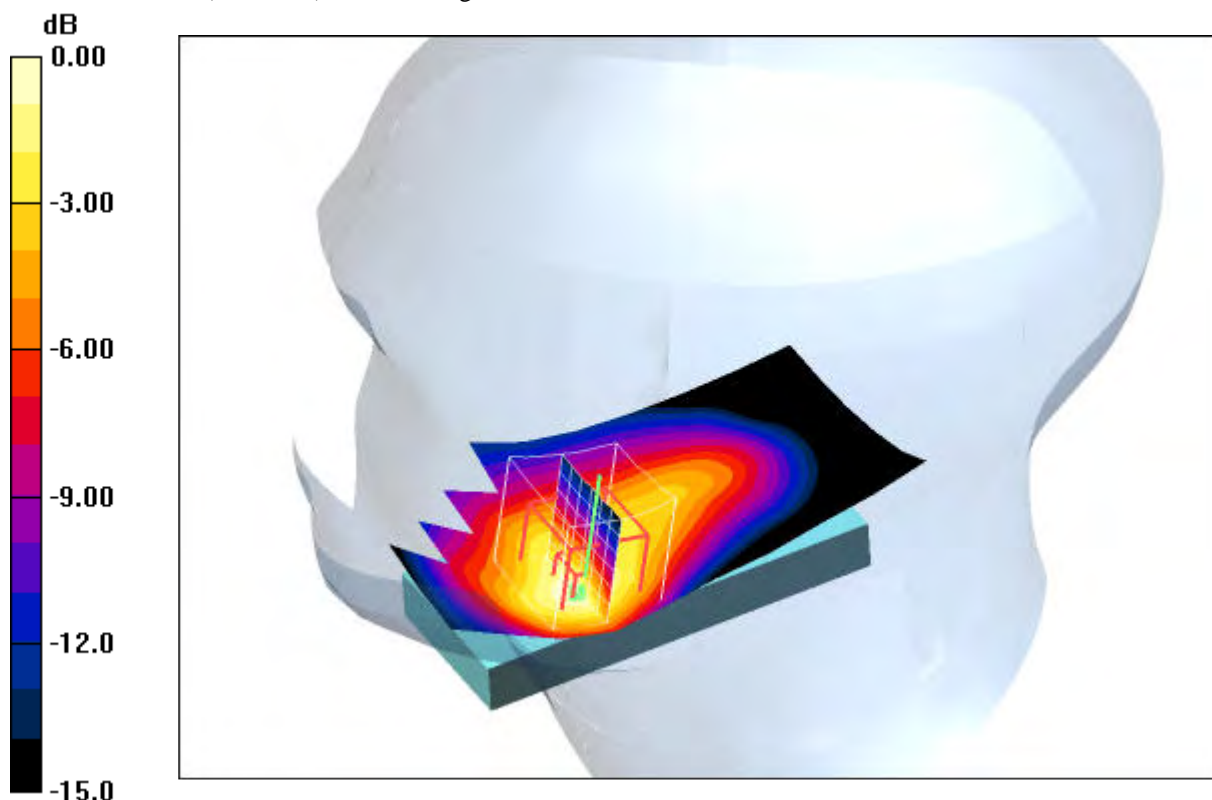

0 dB = 1.47mW/g

**Additional information:**

position or distance of DUT to SAM (if not standard head positions) :

ambient temperature: 22.9°C; liquid temperature: 22.0°C

Date/Time: 2009-03-23 17:56:52 Date/Time: 2009-03-23 18:03:02

**P1528\_OET65-RightHandSide-UMTS-FDD-II**

**DUT: Sony Ericsson; Type: AAD-3880008-BV; Serial: T261F007CD**

Communication System: WCDMA FDD II; Frequency: 1880 MHz; Duty Cycle: 1:1

Medium: HSL1900 Medium parameters used:  $f = 1880 \text{ MHz}$ ;  $\sigma = 1.39 \text{ mho/m}$ ;  $\epsilon_r = 40.4$ ;  $\rho = 1000 \text{ kg/m}^3$

Phantom section: Right Section

DASY4 Configuration:

- Probe: ET3DV6 - SN1558; ConvF(4.96, 4.96, 4.96); Calibrated: 2008-08-15
- Sensor-Surface: 4mm (Mechanical And Optical Surface Detection)
- Electronics: DAE3 Sn413; Calibrated: 2009-01-08
- Phantom: SAM 12; Type: SAM; Serial: 1043
- Measurement SW: DASY4, V4.5 Build 19; Postprocessing SW: SEMCAD, V1.8 Build 146

**Touch position - Middle/Area Scan (51x91x1):** Measurement grid:  $dx=15\text{mm}$ ,  $dy=15\text{mm}$

Maximum value of SAR (interpolated) = 1.35 mW/g

**Touch position - Middle/Zoom Scan (7x7x7) (7x7x7)/Cube 0:** Measurement grid:  $dx=5\text{mm}$ ,  $dy=5\text{mm}$ ,  $dz=5\text{mm}$

Reference Value = 30.3 V/m; Power Drift = 0.031 dB

Peak SAR (extrapolated) = 2.08 W/kg

**SAR(1 g) = 1.23 mW/g; SAR(10 g) = 0.670 mW/g**

Maximum value of SAR (measured) = 1.35 mW/g

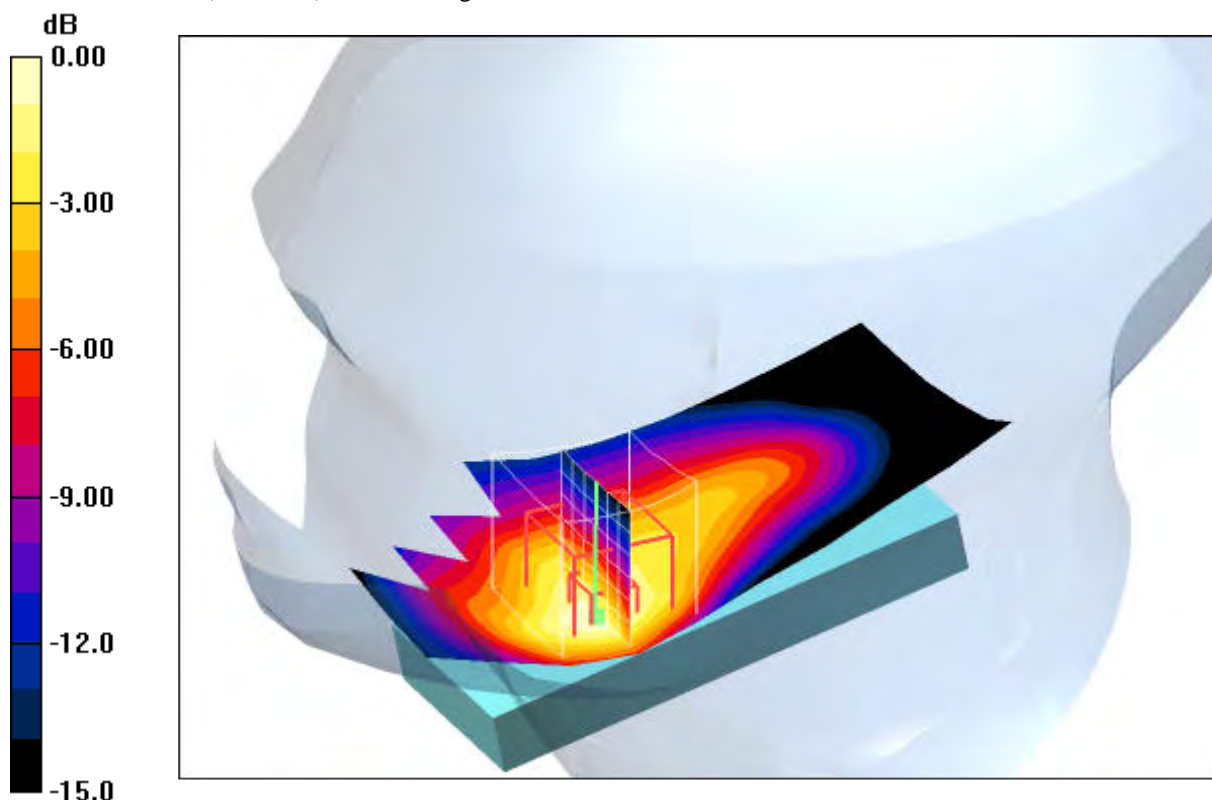

0 dB = 1.35mW/g

**Additional information:**

position or distance of DUT to SAM (if not standard head positions) :

ambient temperature: 22.9°C; liquid temperature: 22.0°C

Date/Time: 2009-03-23 17:35:58 Date/Time: 2009-03-23 17:42:04

**P1528\_OET65-RightHandSide-UMTS-FDD-II**

**DUT: Sony Ericsson; Type: AAD-3880008-BV; Serial: T261F007CD**

Communication System: WCDMA FDD II; Frequency: 1907.6 MHz; Duty Cycle: 1:1

Medium: HSL1900 Medium parameters used (interpolated):  $f = 1907.6 \text{ MHz}$ ;  $\sigma = 1.39 \text{ mho/m}$ ;  $\epsilon_r = 40.4$ ;  $\rho = 1000 \text{ kg/m}^3$

Phantom section: Right Section

DASY4 Configuration:

- Probe: ET3DV6 - SN1558; ConvF(4.96, 4.96, 4.96); Calibrated: 2008-08-15
- Sensor-Surface: 4mm (Mechanical And Optical Surface Detection)
- Electronics: DAE3 Sn413; Calibrated: 2009-01-08
- Phantom: SAM 12; Type: SAM; Serial: 1043
- Measurement SW: DASY4, V4.5 Build 19; Postprocessing SW: SEMCAD, V1.8 Build 146

**Touch position - High/Area Scan (51x91x1):** Measurement grid:  $dx=15\text{mm}$ ,  $dy=15\text{mm}$

Maximum value of SAR (interpolated) = 1.47 mW/g

**Touch position - High/Zoom Scan (7x7x7) (7x7x7)/Cube 0:** Measurement grid:  $dx=5\text{mm}$ ,  $dy=5\text{mm}$ ,  $dz=5\text{mm}$

Reference Value = 31.8 V/m; Power Drift = -0.018 dB

Peak SAR (extrapolated) = 2.29 W/kg

**SAR(1 g) = 1.34 mW/g; SAR(10 g) = 0.722 mW/g**

Maximum value of SAR (measured) = 1.48 mW/g

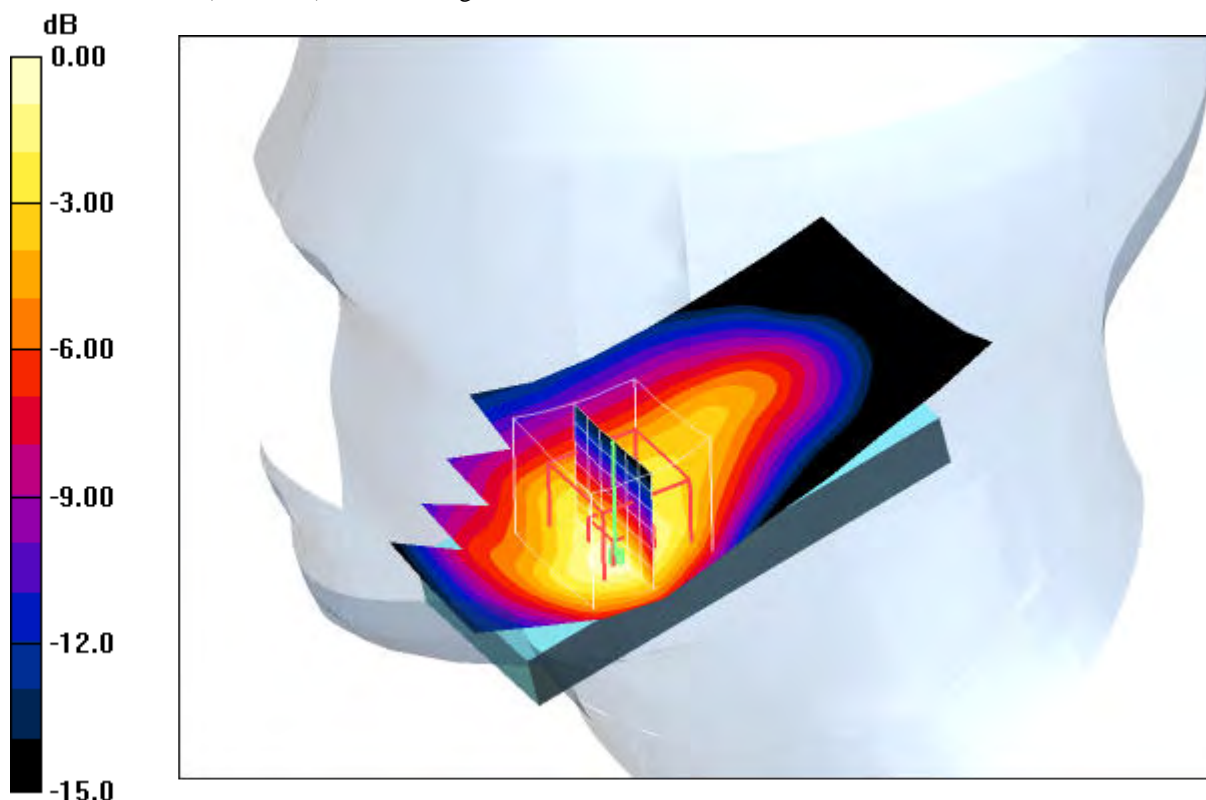

0 dB = 1.48mW/g

**Additional information:**

position or distance of DUT to SAM (if not standard head positions) :

ambient temperature: 22.9°C; liquid temperature: 22.0°C



Date/Time: 2009-03-23 19:01:03 Date/Time: 2009-03-23 19:08:57

**P1528\_OET65-RightHandSide-UMTS-FDD-II**

**DUT: Sony Ericsson; Type: AAD-3880008-BV; Serial: T261F007CD**

Communication System: WCDMA FDD II; Frequency: 1852.5 MHz; Duty Cycle: 1:1

Medium: HSL1900 Medium parameters used (interpolated):  $f = 1852.5 \text{ MHz}$ ;  $\sigma = 1.39 \text{ mho/m}$ ;  $\epsilon_r = 40.4$ ;  $\rho = 1000 \text{ kg/m}^3$

Phantom section: Right Section

DASY4 Configuration:

- Probe: ET3DV6 - SN1558; ConvF(4.96, 4.96, 4.96); Calibrated: 2008-08-15
- Sensor-Surface: 4mm (Mechanical And Optical Surface Detection)
- Electronics: DAE3 Sn413; Calibrated: 2009-01-08
- Phantom: SAM 12; Type: SAM; Serial: 1043
- Measurement SW: DASY4, V4.5 Build 19; Postprocessing SW: SEMCAD, V1.8 Build 146

**Tilt position - Low/Area Scan (51x91x1):** Measurement grid:  $dx=15\text{mm}$ ,  $dy=15\text{mm}$

Maximum value of SAR (interpolated) = 0.591 mW/g

**Tilt position - Low/Zoom Scan (7x7x7) (7x7x7)/Cube 0:** Measurement grid:  $dx=5\text{mm}$ ,  $dy=5\text{mm}$ ,  $dz=5\text{mm}$

Reference Value = 19.6 V/m; Power Drift = -0.00 dB

Peak SAR (extrapolated) = 0.763 W/kg

**SAR(1 g) = 0.496 mW/g; SAR(10 g) = 0.306 mW/g**

Maximum value of SAR (measured) = 0.530 mW/g

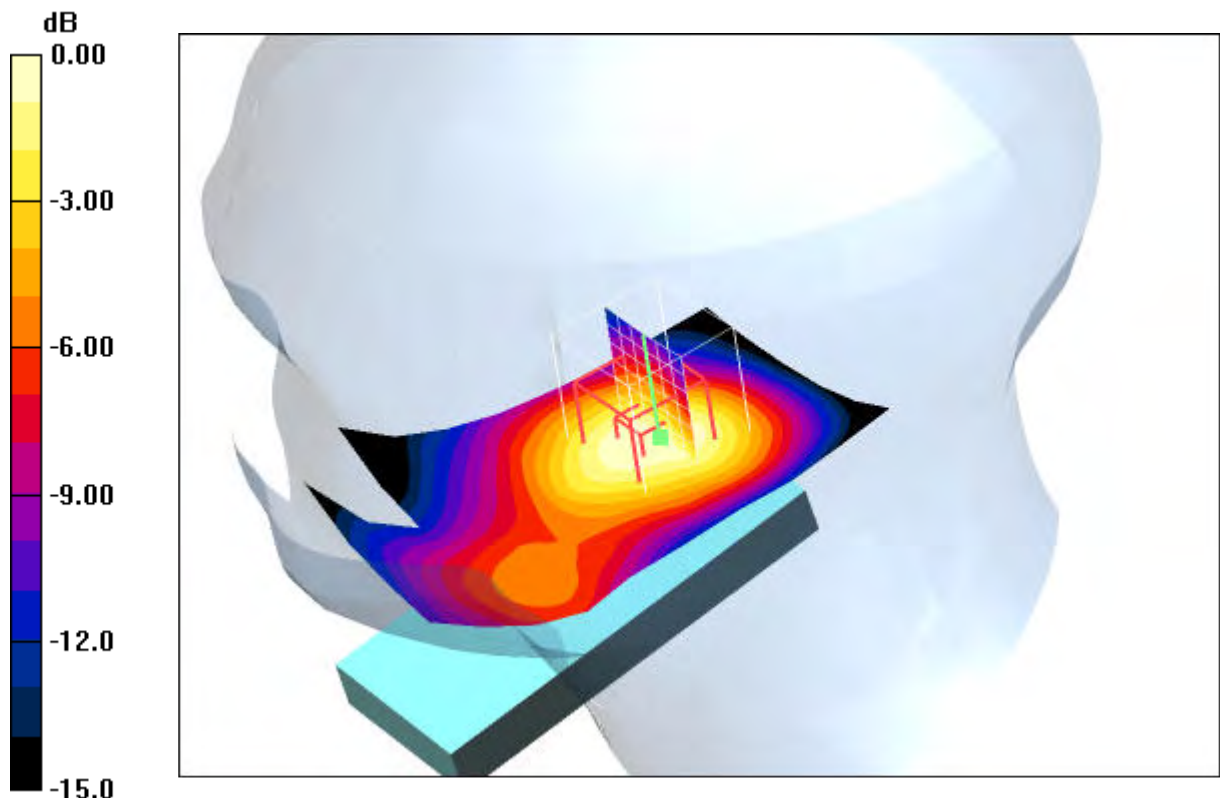

0 dB = 0.530mW/g

**Additional information:**

position or distance of DUT to SAM (if not standard head positions) :

ambient temperature: 22.7°C; liquid temperature: 22.0°C

Date/Time: 2009-03-23 19:24:15 Date/Time: 2009-03-23 19:30:45

**P1528\_OET65-RightHandSide-UMTS-FDD-II**

**DUT: Sony Ericsson; Type: AAD-3880008-BV; Serial: T261F007CD**

Communication System: WCDMA FDD II; Frequency: 1880 MHz; Duty Cycle: 1:1

Medium: HSL1900 Medium parameters used:  $f = 1880 \text{ MHz}$ ;  $\sigma = 1.39 \text{ mho/m}$ ;  $\epsilon_r = 40.4$ ;  $\rho = 1000 \text{ kg/m}^3$

Phantom section: Right Section

DASY4 Configuration:

- Probe: ET3DV6 - SN1558; ConvF(4.96, 4.96, 4.96); Calibrated: 2008-08-15
- Sensor-Surface: 4mm (Mechanical And Optical Surface Detection)
- Electronics: DAE3 Sn413; Calibrated: 2009-01-08
- Phantom: SAM 12; Type: SAM; Serial: 1043
- Measurement SW: DASY4, V4.5 Build 19; Postprocessing SW: SEMCAD, V1.8 Build 146

**Tilt position - Middle/Area Scan (51x91x1):** Measurement grid:  $dx=15\text{mm}$ ,  $dy=15\text{mm}$

Maximum value of SAR (interpolated) = 0.553 mW/g

**Tilt position - Middle/Zoom Scan (7x7x7) (7x7x7)/Cube 0:** Measurement grid:  $dx=5\text{mm}$ ,  $dy=5\text{mm}$ ,

$dz=5\text{mm}$

Reference Value = 18.9 V/m; Power Drift = 0.032 dB

Peak SAR (extrapolated) = 0.717 W/kg

**SAR(1 g) = 0.463 mW/g; SAR(10 g) = 0.284 mW/g**

Maximum value of SAR (measured) = 0.494 mW/g

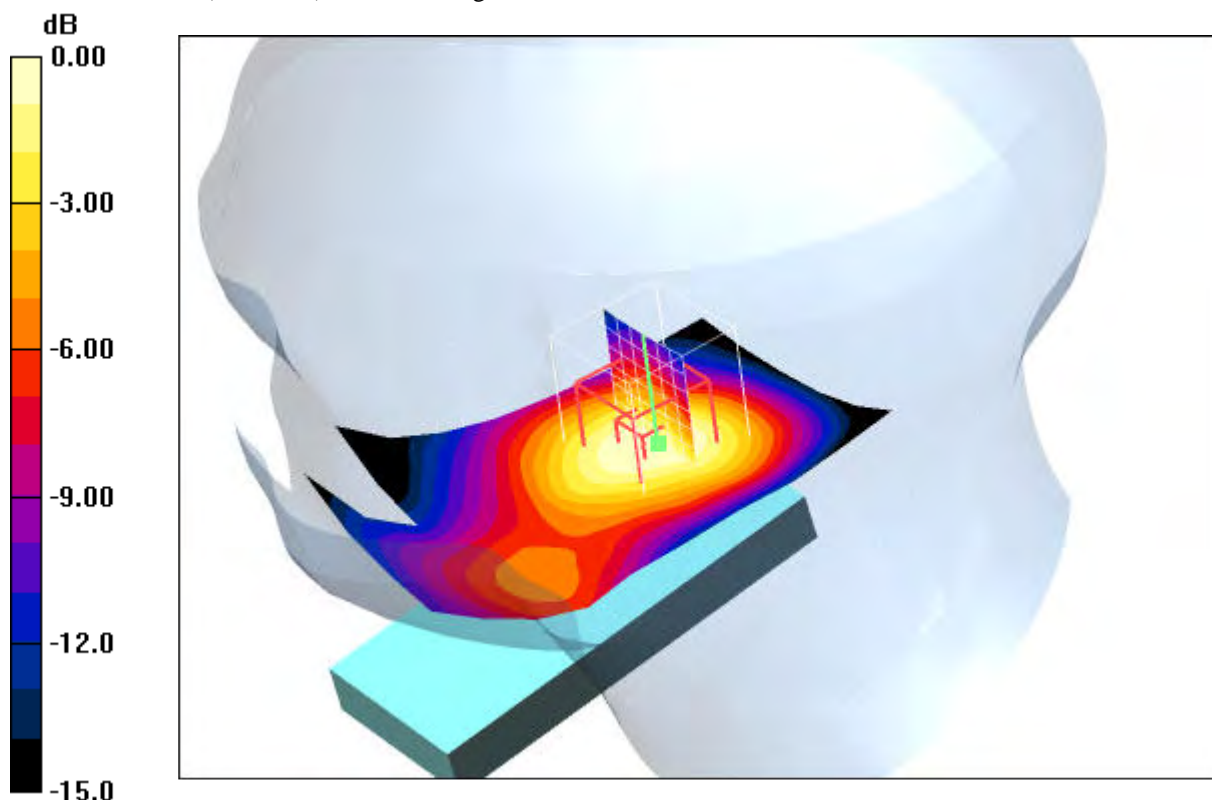

0 dB = 0.494mW/g

**Additional information:**

position or distance of DUT to SAM (if not standard head positions) :

ambient temperature: 22.7°C; liquid temperature: 22.0°C

Date/Time: 2009-03-23 19:43:57 Date/Time: 2009-03-23 19:50:27

**P1528\_OET65-RightHandSide-UMTS-FDD-II**

**DUT: Sony Ericsson; Type: AAD-3880008-BV; Serial: T261F007CD**

Communication System: WCDMA FDD II; Frequency: 1907.6 MHz; Duty Cycle: 1:1

Medium: HSL1900 Medium parameters used (interpolated):  $f = 1907.6 \text{ MHz}$ ;  $\sigma = 1.39 \text{ mho/m}$ ;  $\epsilon_r = 40.4$ ;  $\rho = 1000 \text{ kg/m}^3$

Phantom section: Right Section

DASY4 Configuration:

- Probe: ET3DV6 - SN1558; ConvF(4.96, 4.96, 4.96); Calibrated: 2008-08-15
- Sensor-Surface: 4mm (Mechanical And Optical Surface Detection)
- Electronics: DAE3 Sn413; Calibrated: 2009-01-08
- Phantom: SAM 12; Type: SAM; Serial: 1043
- Measurement SW: DASY4, V4.5 Build 19; Postprocessing SW: SEMCAD, V1.8 Build 146

**Tilt position - High/Area Scan (51x91x1):** Measurement grid:  $dx=15\text{mm}$ ,  $dy=15\text{mm}$

Maximum value of SAR (interpolated) = 0.617 mW/g

**Tilt position - High/Zoom Scan (7x7x7) (7x7x7)/Cube 0:** Measurement grid:  $dx=5\text{mm}$ ,  $dy=5\text{mm}$ ,

$dz=5\text{mm}$

Reference Value = 20.1 V/m; Power Drift = -0.028 dB

Peak SAR (extrapolated) = 0.799 W/kg

**SAR(1 g) = 0.512 mW/g; SAR(10 g) = 0.312 mW/g**

Maximum value of SAR (measured) = 0.550 mW/g

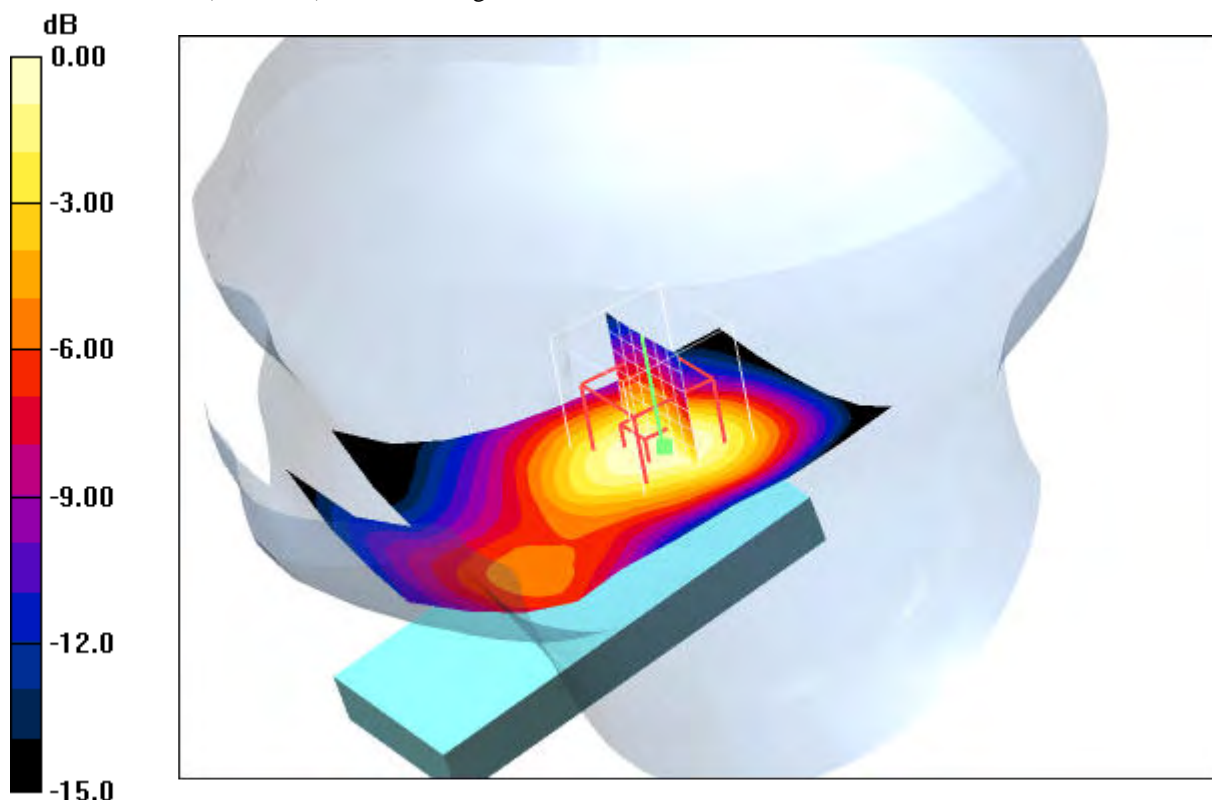

0 dB = 0.550mW/g

**Additional information:**

position or distance of DUT to SAM (if not standard head positions) :

ambient temperature: 22.7°C; liquid temperature: 22.0°C

**Annex 2.6 UMTS (WCDMA) FDD II 1900 MHz body**

Date/Time: 2009-03-25 17:12:04 Date/Time: 2009-03-25 17:18:30 Date/Time: 2009-03-25 17:30:41

**P1528\_OET65-Body-UMTS-FDD-II**

**DUT: Sony Ericsson; Type: AAD-3880008-BV; Serial: T261F007CD**

Communication System: WCDMA FDD II; Frequency: 1852.5 MHz; Duty Cycle: 1:1

Medium: M1900 Medium parameters used (interpolated):  $f = 1852.5$  MHz;  $\sigma = 1.48$  mho/m;  $\epsilon_r = 53.1$ ;  $\rho = 1000$  kg/m<sup>3</sup>

Phantom section: Flat Section

DASY4 Configuration:

- Probe: ET3DV6 - SN1558; ConvF(4.39, 4.39, 4.39); Calibrated: 2008-08-15
- Sensor-Surface: 4mm (Mechanical And Optical Surface Detection)
- Electronics: DAE3 Sn413; Calibrated: 2009-01-08
- Phantom: SAM 12; Type: SAM; Serial: 1043
- Measurement SW: DASY4, V4.5 Build 19; Postprocessing SW: SEMCAD, V1.8 Build 146

**Front position - Low/Area Scan (51x91x1):** Measurement grid: dx=15mm, dy=15mm

Maximum value of SAR (interpolated) = 0.349 mW/g

**Front position - Low/Zoom Scan (7x7x7) (7x7x7)/Cube 0:** Measurement grid: dx=5mm, dy=5mm, dz=5mm

Reference Value = 14.6 V/m; Power Drift = 0.00 dB

Peak SAR (extrapolated) = 0.545 W/kg

**SAR(1 g) = 0.317 mW/g; SAR(10 g) = 0.190 mW/g**

Maximum value of SAR (measured) = 0.344 mW/g

**Front position - Low/Zoom Scan (7x7x7) (7x7x7)/Cube 1:** Measurement grid: dx=5mm, dy=5mm, dz=5mm

Reference Value = 14.6 V/m; Power Drift = 0.00 dB

Peak SAR (extrapolated) = 0.369 W/kg

**SAR(1 g) = 0.229 mW/g; SAR(10 g) = 0.148 mW/g**

Maximum value of SAR (measured) = 0.242 mW/g

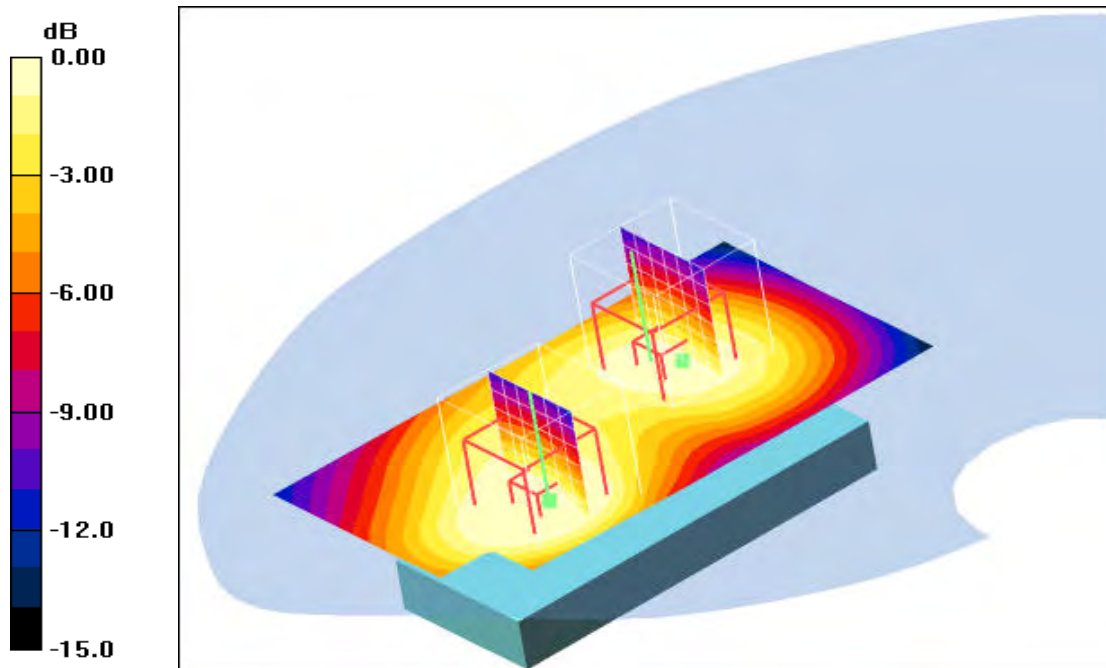

0 dB = 0.242mW/g

**Additional information:**

position or distance of DUT to SAM : 15 mm

ambient temperature: 22.8°C; liquid temperature: 21.4°C

Date/Time: 2009-03-25 17:45:18 Date/Time: 2009-03-25 17:51:53 Date/Time: 2009-03-25 18:03:40

**P1528\_OET65-Body-UMTS-FDD-II**

**DUT: Sony Ericsson; Type: AAD-3880008-BV; Serial: T261F007CD**

Communication System: WCDMA FDD II; Frequency: 1880 MHz; Duty Cycle: 1:1

Medium: M1900 Medium parameters used:  $f = 1880 \text{ MHz}$ ;  $\sigma = 1.48 \text{ mho/m}$ ;  $\epsilon_r = 53.1$ ;  $\rho = 1000 \text{ kg/m}^3$

Phantom section: Flat Section

DASY4 Configuration:

- Probe: ET3DV6 - SN1558; ConvF(4.39, 4.39, 4.39); Calibrated: 2008-08-15
- Sensor-Surface: 4mm (Mechanical And Optical Surface Detection)
- Electronics: DAE3 Sn413; Calibrated: 2009-01-08
- Phantom: SAM 12; Type: SAM; Serial: 1043
- Measurement SW: DASY4, V4.5 Build 19; Postprocessing SW: SEMCAD, V1.8 Build 146

**Front position - Middle/Area Scan (51x91x1):** Measurement grid:  $dx=15\text{mm}$ ,  $dy=15\text{mm}$

Maximum value of SAR (interpolated) = 0.344 mW/g

**Front position - Middle/Zoom Scan (7x7x7) (7x7x7)/Cube 0:** Measurement grid:  $dx=5\text{mm}$ ,  $dy=5\text{mm}$ ,  $dz=5\text{mm}$

Reference Value = 14.4 V/m; Power Drift = 0.022 dB

Peak SAR (extrapolated) = 0.550 W/kg

**SAR(1 g) = 0.314 mW/g; SAR(10 g) = 0.187 mW/g**

Maximum value of SAR (measured) = 0.341 mW/g

**Front position - Middle/Zoom Scan (7x7x7) (7x7x7)/Cube 1:** Measurement grid:  $dx=5\text{mm}$ ,  $dy=5\text{mm}$ ,  $dz=5\text{mm}$

Reference Value = 14.4 V/m; Power Drift = 0.022 dB

Peak SAR (extrapolated) = 0.373 W/kg

**SAR(1 g) = 0.228 mW/g; SAR(10 g) = 0.146 mW/g**

Maximum value of SAR (measured) = 0.240 mW/g

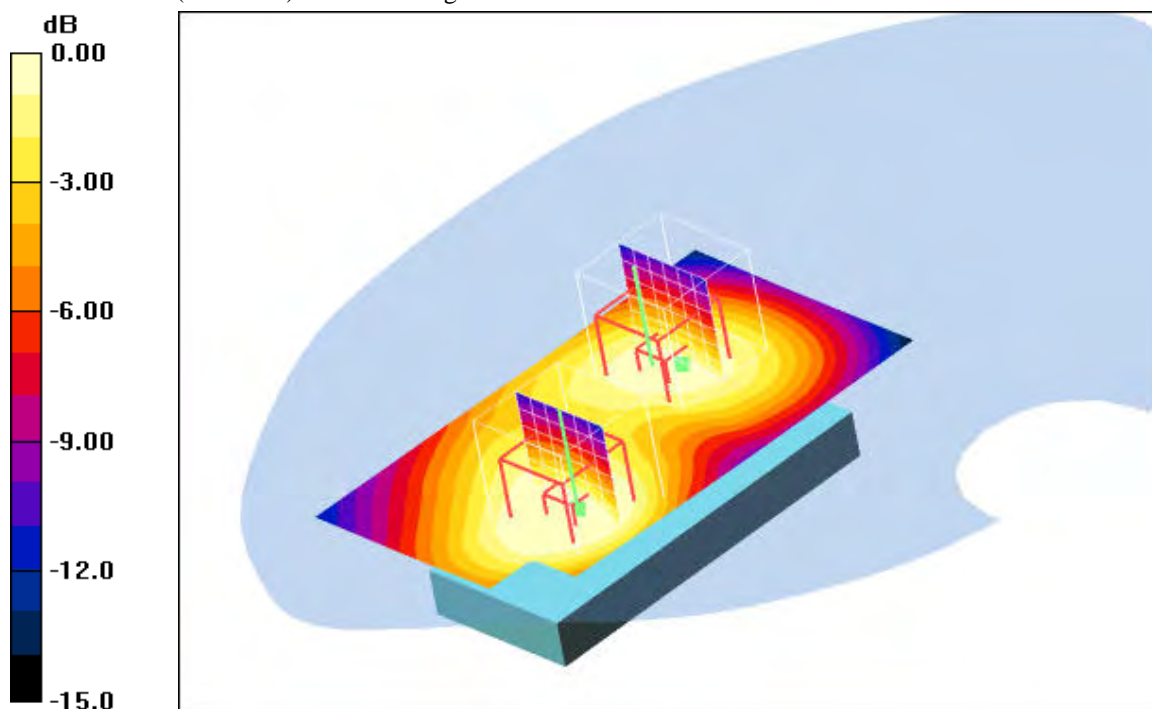

0 dB = 0.240mW/g

**Additional information:**

position or distance of DUT to SAM : 15 mm

ambient temperature: 22.8°C; liquid temperature: 21.4°C

Date/Time: 2009-03-25 18:20:50 Date/Time: 2009-03-25 18:27:19

**P1528\_OET65-Body-UMTS-FDD-II**

**DUT: Sony Ericsson; Type: AAD-3880008-BV; Serial: T261F007CD**

Communication System: WCDMA FDD II; Frequency: 1907.6 MHz; Duty Cycle: 1:1

Medium: M1900 Medium parameters used (interpolated):  $f = 1907.6 \text{ MHz}$ ;  $\sigma = 1.48 \text{ mho/m}$ ;  $\epsilon_r = 53.1$ ;  $\rho = 1000 \text{ kg/m}^3$

Phantom section: Flat Section

DASY4 Configuration:

- Probe: ET3DV6 - SN1558; ConvF(4.39, 4.39, 4.39); Calibrated: 2008-08-15
- Sensor-Surface: 4mm (Mechanical And Optical Surface Detection) Sensor-Surface: 4mm (Mechanical Surface Detection)
- Electronics: DAE3 Sn413; Calibrated: 2009-01-08
- Phantom: SAM 12; Type: SAM; Serial: 1043
- Measurement SW: DASY4, V4.5 Build 19; Postprocessing SW: SEMCAD, V1.8 Build 146

**Front position - High/Area Scan (51x91x1):** Measurement grid:  $dx=15\text{mm}$ ,  $dy=15\text{mm}$

Maximum value of SAR (interpolated) = 0.421 mW/g

**Front position - High/Zoom Scan (7x7x7) (7x7x7)/Cube 0:** Measurement grid:  $dx=5\text{mm}$ ,  $dy=5\text{mm}$ ,  $dz=5\text{mm}$

Reference Value = 16.0 V/m; Power Drift = -0.031 dB

Peak SAR (extrapolated) = 0.643 W/kg

**SAR(1 g) = 0.367 mW/g; SAR(10 g) = 0.218 mW/g**

Maximum value of SAR (measured) = 0.394 mW/g

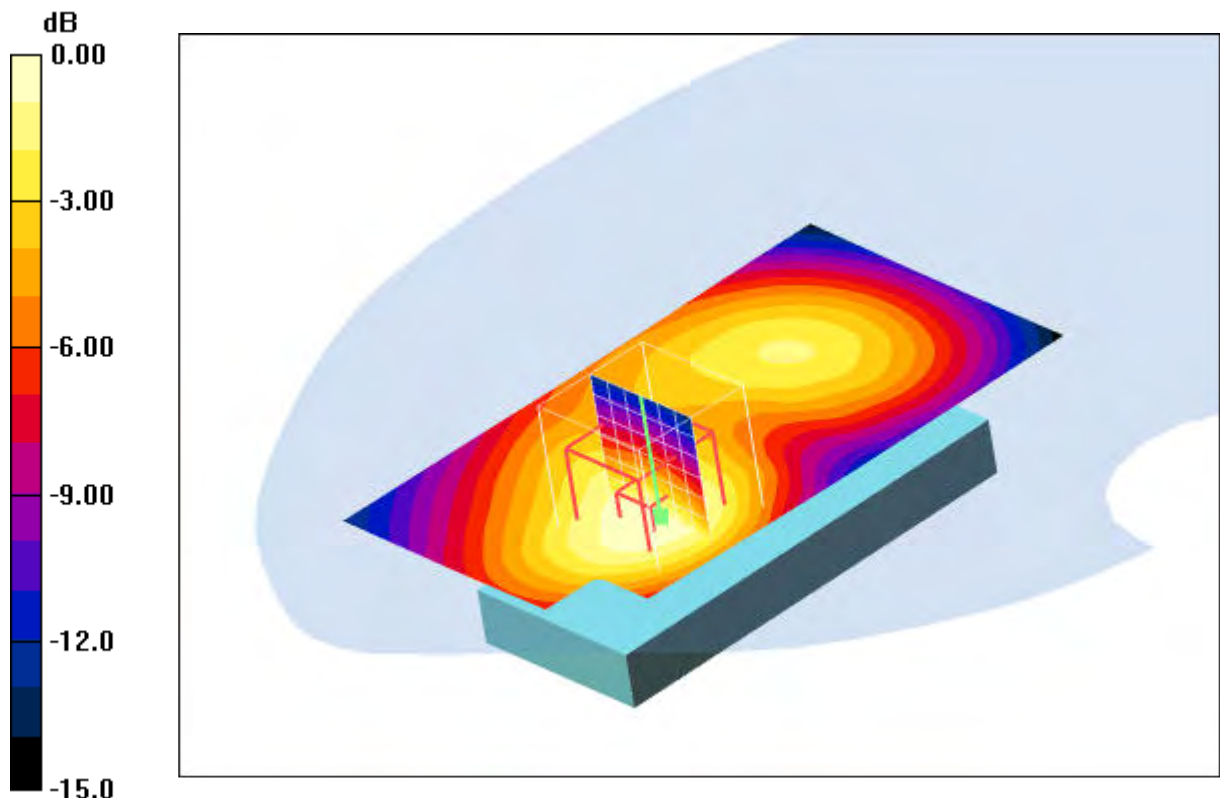

0 dB = 0.394mW/g

**Additional information:**

position or distance of DUT to SAM : 15 mm

ambient temperature: 22.8°C; liquid temperature: 21.4°C

**P1528\_OET65-Body-UMTS-FDD-II**

**DUT: Sony Ericsson; Type: AAD-3880008-BV; Serial: T261F007CD**

Communication System: WCDMA FDD II; Frequency: 1852.5 MHz; Duty Cycle: 1:1

Medium: M1900 Medium parameters used (interpolated):  $f = 1852.5 \text{ MHz}$ ;  $\sigma = 1.48 \text{ mho/m}$ ;  $\epsilon_r = 53.1$ ;  $\rho = 1000 \text{ kg/m}^3$

Phantom section: Flat Section

DASY4 Configuration:

- Probe: ET3DV6 - SN1558; ConvF(4.39, 4.39, 4.39); Calibrated: 2008-08-15
- Sensor-Surface: 4mm (Mechanical And Optical Surface Detection)
- Electronics: DAE3 Sn413; Calibrated: 2009-01-08
- Phantom: SAM 12; Type: SAM; Serial: 1043
- Measurement SW: DASY4, V4.5 Build 19; Postprocessing SW: SEMCAD, V1.8 Build 146

**Rear position - Low/Area Scan (51x91x1):** Measurement grid:  $dx=15\text{mm}$ ,  $dy=15\text{mm}$

Maximum value of SAR (interpolated) = 0.532 mW/g

**Rear position - Low/Zoom Scan (7x7x7) (7x7x7)/Cube 0:** Measurement grid:  $dx=5\text{mm}$ ,  $dy=5\text{mm}$ ,  $dz=5\text{mm}$

Reference Value = 18.6 V/m; Power Drift = 0.032 dB

Peak SAR (extrapolated) = 0.865 W/kg

**SAR(1 g) = 0.480 mW/g; SAR(10 g) = 0.280 mW/g**

Maximum value of SAR (measured) = 0.518 mW/g

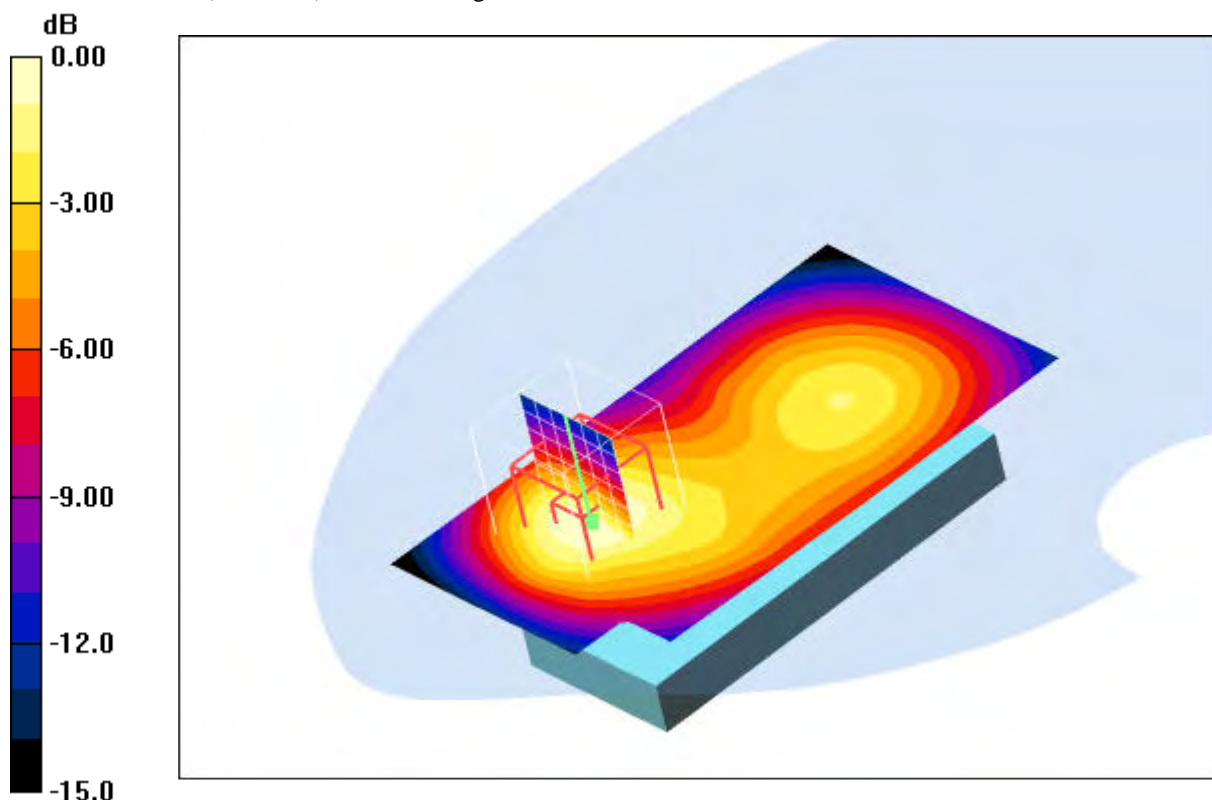

0 dB = 0.518mW/g

**Additional information:**

position or distance of DUT to SAM : 15 mm

ambient temperature: 22.7°C; liquid temperature: 21.4°C

**P1528\_OET65-Body-UMTS-FDD-II**

**DUT: Sony Ericsson; Type: AAD-3880008-BV; Serial: T261F007CD**

Communication System: WCDMA FDD II; Frequency: 1880 MHz; Duty Cycle: 1:1

Medium: M1900 Medium parameters used:  $f = 1880 \text{ MHz}$ ;  $\sigma = 1.48 \text{ mho/m}$ ;  $\epsilon_r = 53.1$ ;  $\rho = 1000 \text{ kg/m}^3$

Phantom section: Flat Section

DASY4 Configuration:

- Probe: ET3DV6 - SN1558; ConvF(4.39, 4.39, 4.39); Calibrated: 2008-08-15
- Sensor-Surface: 4mm (Mechanical And Optical Surface Detection)
- Electronics: DAE3 Sn413; Calibrated: 2009-01-08
- Phantom: SAM 12; Type: SAM; Serial: 1043
- Measurement SW: DASY4, V4.5 Build 19; Postprocessing SW: SEMCAD, V1.8 Build 146

**Rear position - Middle/Area Scan (51x91x1):** Measurement grid:  $dx=15\text{mm}$ ,  $dy=15\text{mm}$

Maximum value of SAR (interpolated) = 0.541 mW/g

**Rear position - Middle/Zoom Scan (7x7x7) (7x7x7)/Cube 0:** Measurement grid:  $dx=5\text{mm}$ ,  $dy=5\text{mm}$ ,

$dz=5\text{mm}$

Reference Value = 18.6 V/m; Power Drift = 0.046 dB

Peak SAR (extrapolated) = 0.883 W/kg

**SAR(1 g) = 0.485 mW/g; SAR(10 g) = 0.282 mW/g**

Maximum value of SAR (measured) = 0.520 mW/g

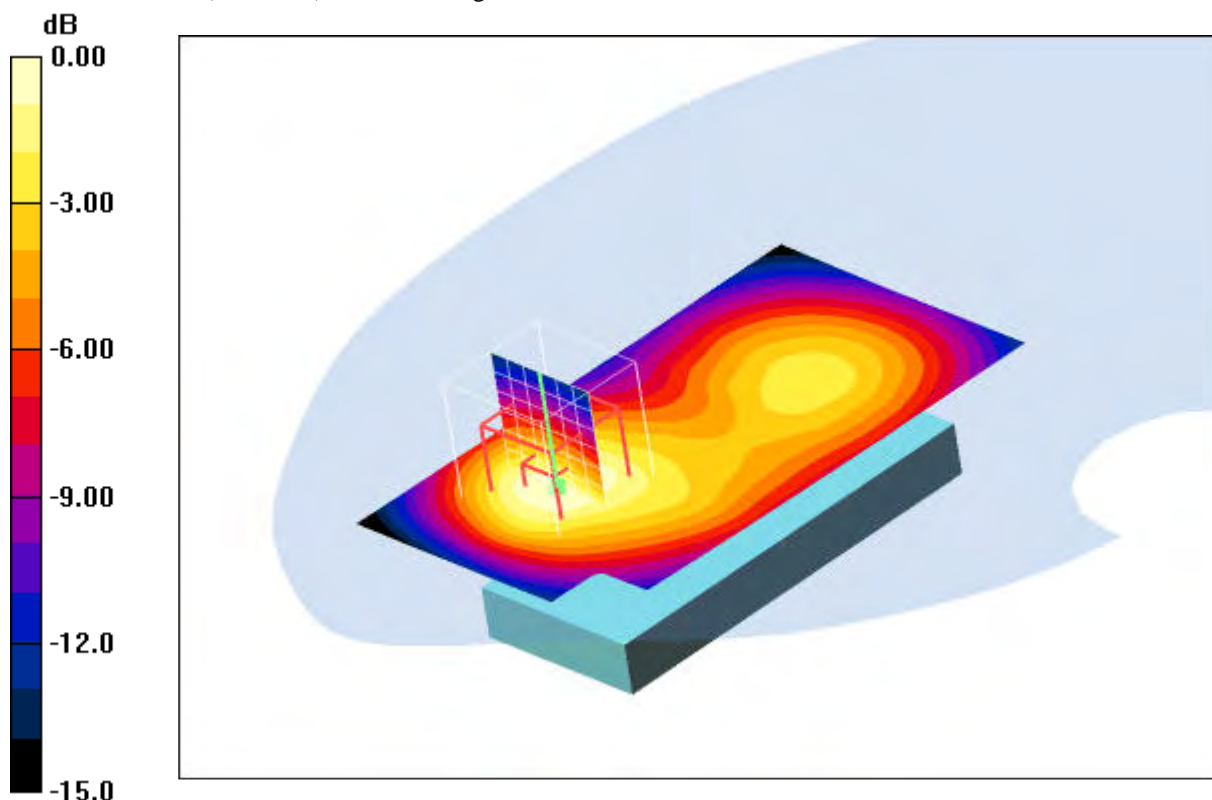

0 dB = 0.520mW/g

**Additional information:**

position or distance of DUT to SAM : 15 mm

ambient temperature: 22.7°C; liquid temperature: 21.4°C



Date/Time: 2009-03-25 16:43:59 Date/Time: 2009-03-25 16:50:18

**P1528\_OET65-Body-UMTS-FDD-II**

**DUT: Sony Ericsson; Type: AAD-3880008-BV; Serial: T261F007CD**

Communication System: WCDMA FDD II; Frequency: 1907.6 MHz; Duty Cycle: 1:1

Medium: M1900 Medium parameters used (interpolated):  $f = 1907.6 \text{ MHz}$ ;  $\sigma = 1.48 \text{ mho/m}$ ;  $\epsilon_r = 53.1$ ;  $\rho = 1000 \text{ kg/m}^3$

Phantom section: Flat Section

DASY4 Configuration:

- Probe: ET3DV6 - SN1558; ConvF(4.39, 4.39, 4.39); Calibrated: 2008-08-15
- Sensor-Surface: 4mm (Mechanical And Optical Surface Detection) Sensor-Surface: 4mm (Mechanical Surface Detection)
- Electronics: DAE3 Sn413; Calibrated: 2009-01-08
- Phantom: SAM 12; Type: SAM; Serial: 1043
- Measurement SW: DASY4, V4.5 Build 19; Postprocessing SW: SEMCAD, V1.8 Build 146

**Rear position - High/Area Scan (51x91x1):** Measurement grid:  $dx=15\text{mm}$ ,  $dy=15\text{mm}$

Maximum value of SAR (interpolated) = 0.615 mW/g

**Rear position - High/Zoom Scan (7x7x7) (7x7x7)/Cube 0:** Measurement grid:  $dx=5\text{mm}$ ,  $dy=5\text{mm}$ ,  $dz=5\text{mm}$

Reference Value = 19.9 V/m; Power Drift = 0.00 dB

Peak SAR (extrapolated) = 0.989 W/kg

**SAR(1 g) = 0.538 mW/g; SAR(10 g) = 0.312 mW/g**

Maximum value of SAR (measured) = 0.580 mW/g

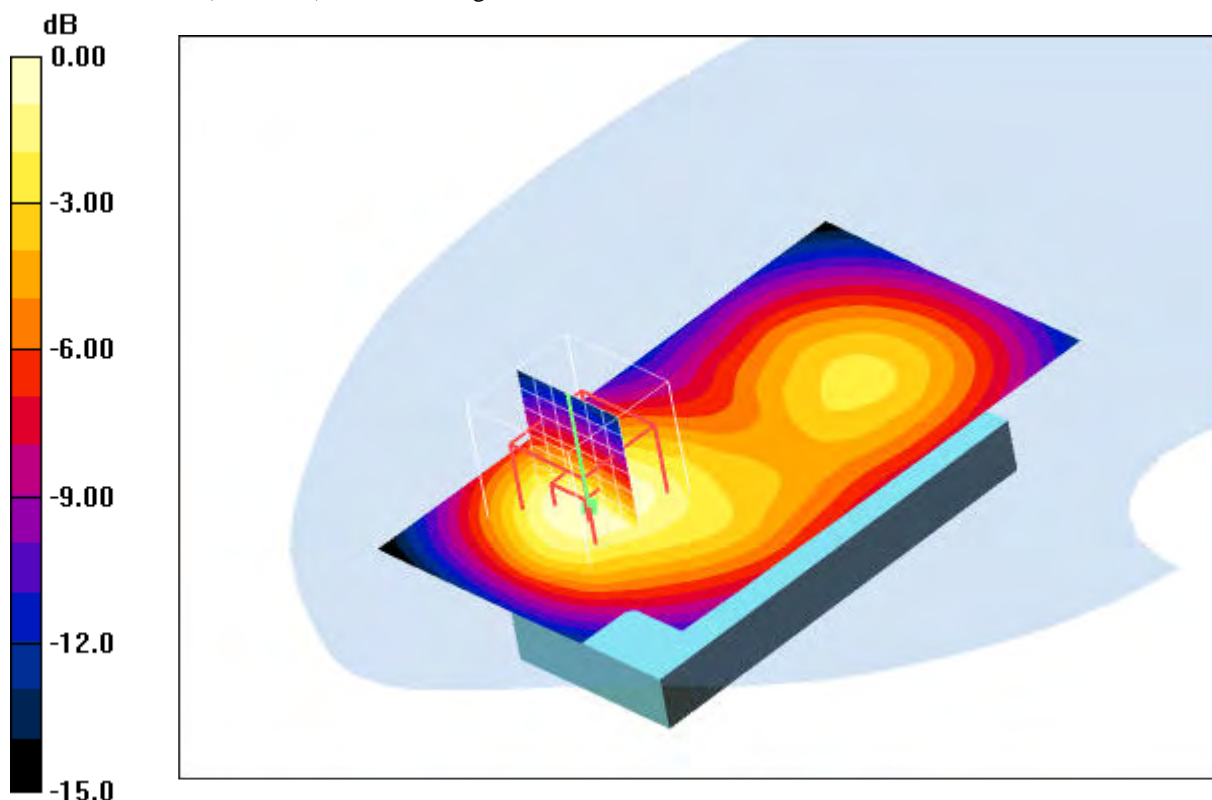

0 dB = 0.580mW/g

**Additional information:**

position or distance of DUT to SAM : 15 mm

ambient temperature: 22.7°C; liquid temperature: 21.4°C

**Annex 2.7 UMTS (WCDMA) FDD V 850 MHz head**

Date/Time: 2009-04-03 08:59:34 Date/Time: 2009-04-03 09:06:32

**P1528\_OET65-LeftHandSide-UMTS-FDD-V**

**DUT: Sony Ericsson; Type: AAD-3880008-BV; Serial: T261F007CD**

Communication System: WCDMA FDD V; Frequency: 826.4 MHz; Duty Cycle: 1:1

Medium: HSL850 Medium parameters used (interpolated):  $f = 826.4$  MHz;  $\sigma = 0.93$  mho/m;  $\epsilon_r = 42.3$ ;  $\rho = 1000$  kg/m<sup>3</sup>

Phantom section: Left Section

DASY4 Configuration:

- Probe: ET3DV6 - SN1558; ConvF(6.19, 6.19, 6.19); Calibrated: 2008-08-15
- Sensor-Surface: 4mm (Mechanical And Optical Surface Detection)
- Electronics: DAE3 Sn413; Calibrated: 2009-01-08
- Phantom: SAM 12; Type: SAM; Serial: 1043
- Measurement SW: DASY4, V4.5 Build 19; Postprocessing SW: SEMCAD, V1.8 Build 146

**Touch position - Low/Area Scan (51x91x1):** Measurement grid: dx=15mm, dy=15mm

Maximum value of SAR (interpolated) = 1.25 mW/g

**Touch position - Low/Zoom Scan (7x7x7) (7x7x7)/Cube 0:** Measurement grid: dx=5mm, dy=5mm, dz=5mm

Reference Value = 36.0 V/m; Power Drift = -0.00 dB

Peak SAR (extrapolated) = 1.49 W/kg

**SAR(1 g) = 1.14 mW/g; SAR(10 g) = 0.800 mW/g**

Maximum value of SAR (measured) = 1.20 mW/g

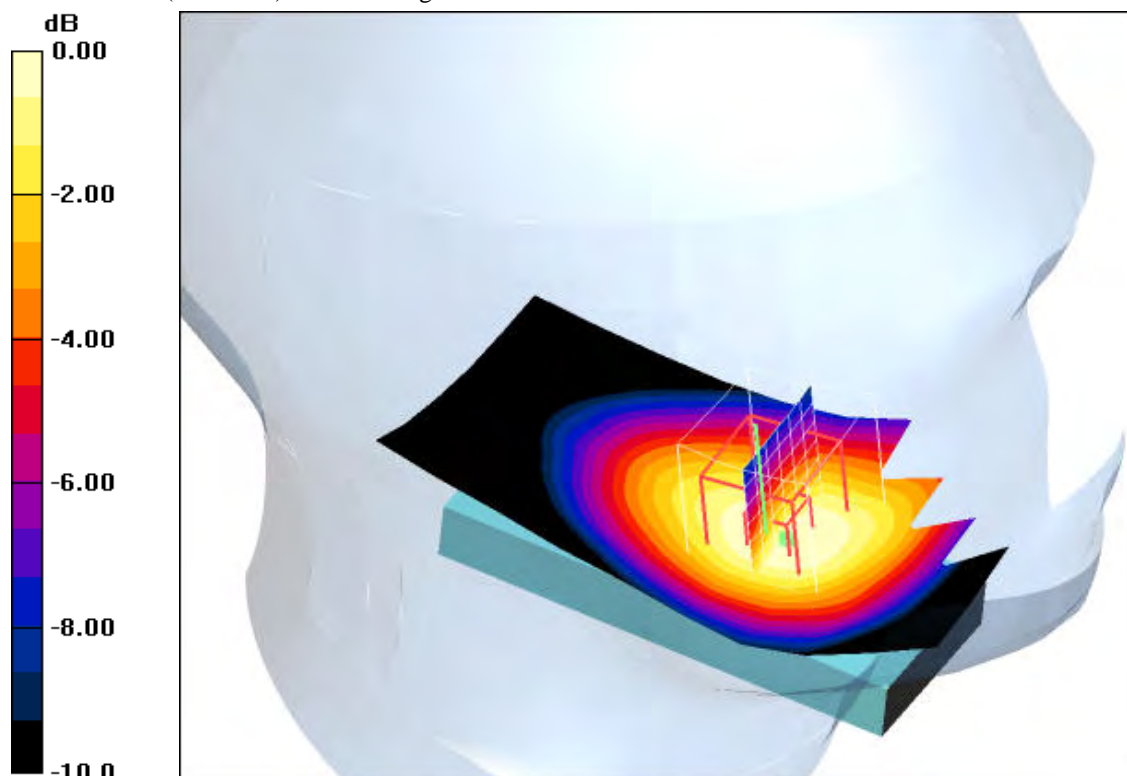

0 dB = 1.20mW/g

**Additional information:**

position or distance of DUT to SAM (if not standard head positions) :

ambient temperature: 22.8°C; liquid temperature: 22.3°C

Date/Time: 2009-04-03 09:21:23 Date/Time: 2009-04-03 09:27:38

**P1528\_OET65-LeftHandSide-UMTS-FDD-V**

**DUT: Sony Ericsson; Type: AAD-3880008-BV; Serial: T261F007CD**

Communication System: WCDMA FDD V; Frequency: 836.4 MHz; Duty Cycle: 1:1

Medium: HSL850 Medium parameters used (interpolated):  $f = 836.4 \text{ MHz}$ ;  $\sigma = 0.93 \text{ mho/m}$ ;  $\epsilon_r = 42.3$ ;  $\rho = 1000 \text{ kg/m}^3$

Phantom section: Left Section

DASY4 Configuration:

- Probe: ET3DV6 - SN1558; ConvF(6.19, 6.19, 6.19); Calibrated: 2008-08-15
- Sensor-Surface: 4mm (Mechanical And Optical Surface Detection)
- Electronics: DAE3 Sn413; Calibrated: 2009-01-08
- Phantom: SAM 12; Type: SAM; Serial: 1043
- Measurement SW: DASY4, V4.5 Build 19; Postprocessing SW: SEMCAD, V1.8 Build 146

**Touch position - Middle/Area Scan (51x91x1):** Measurement grid:  $dx=15\text{mm}$ ,  $dy=15\text{mm}$

Maximum value of SAR (interpolated) = 1.34 mW/g

**Touch position - Middle/Zoom Scan (7x7x7) (7x7x7)/Cube 0:** Measurement grid:  $dx=5\text{mm}$ ,  $dy=5\text{mm}$ ,  $dz=5\text{mm}$

Reference Value = 37.5 V/m; Power Drift = 0.046 dB

Peak SAR (extrapolated) = 1.66 W/kg

**SAR(1 g) = 1.26 mW/g; SAR(10 g) = 0.879 mW/g**

Maximum value of SAR (measured) = 1.34 mW/g

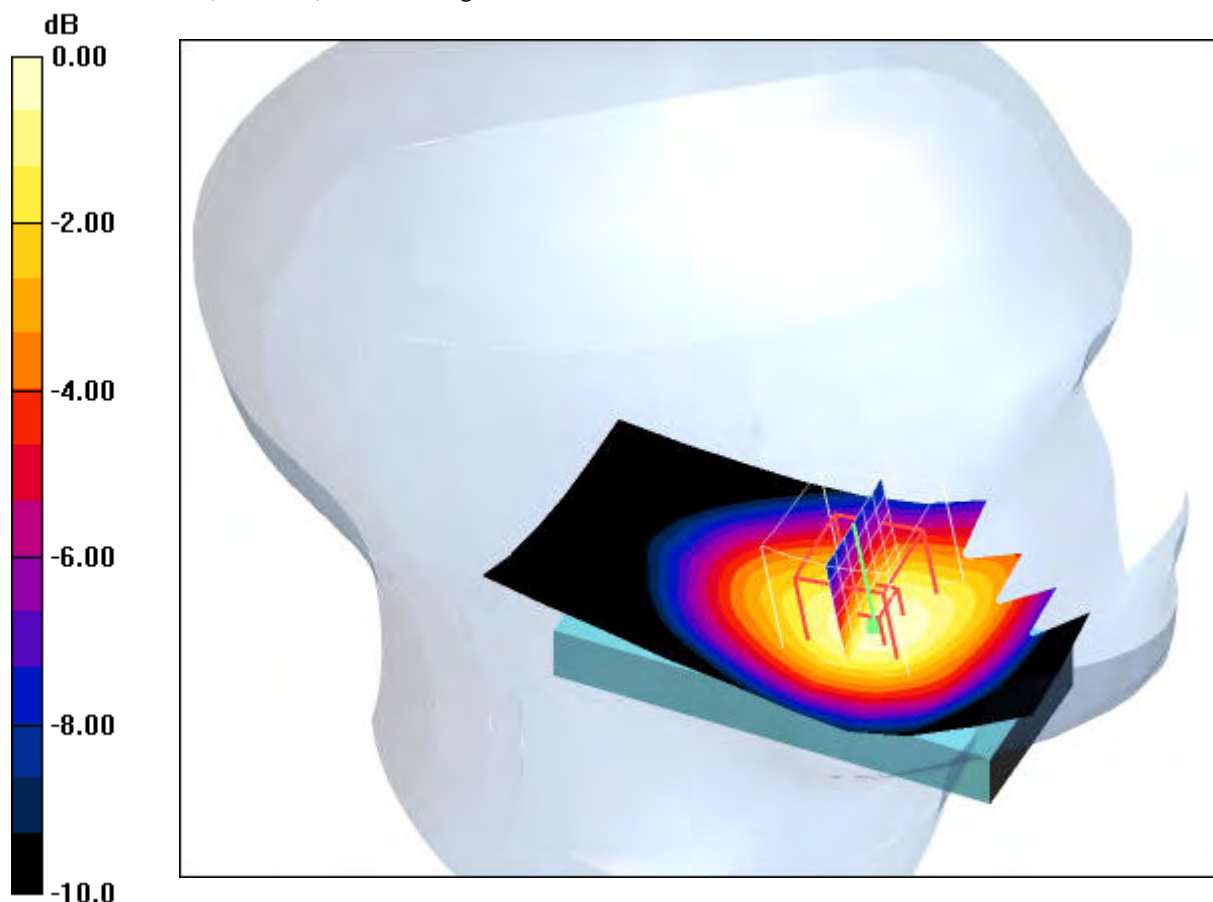

0 dB = 1.34mW/g

**Additional information:**

position or distance of DUT to SAM (if not standard head positions) :  
 ambient temperature: 22.8°C; liquid temperature: 22.3°C

Date/Time: 2009-04-03 09:42:57 Date/Time: 2009-04-03 09:49:15

**P1528\_OET65-LeftHandSide-UMTS-FDD-V**

**DUT: Sony Ericsson; Type: AAD-3880008-BV; Serial: T261F007CD**

Communication System: WCDMA FDD V; Frequency: 846.6 MHz; Duty Cycle: 1:1

Medium: HSL850 Medium parameters used (interpolated):  $f = 846.6 \text{ MHz}$ ;  $\sigma = 0.93 \text{ mho/m}$ ;  $\epsilon_r = 42.3$ ;  $\rho = 1000 \text{ kg/m}^3$

Phantom section: Left Section

DASY4 Configuration:

- Probe: ET3DV6 - SN1558; ConvF(6.19, 6.19, 6.19); Calibrated: 2008-08-15
- Sensor-Surface: 4mm (Mechanical And Optical Surface Detection)
- Electronics: DAE3 Sn413; Calibrated: 2009-01-08
- Phantom: SAM 12; Type: SAM; Serial: 1043
- Measurement SW: DASY4, V4.5 Build 19; Postprocessing SW: SEMCAD, V1.8 Build 146

**Touch position - High/Area Scan (51x91x1):** Measurement grid:  $dx=15\text{mm}$ ,  $dy=15\text{mm}$

Maximum value of SAR (interpolated) = 1.33 mW/g

**Touch position - High/Zoom Scan (7x7x7) (7x7x7)/Cube 0:** Measurement grid:  $dx=5\text{mm}$ ,  $dy=5\text{mm}$ ,  $dz=5\text{mm}$

Reference Value = 37.3 V/m; Power Drift = 0.021 dB

Peak SAR (extrapolated) = 1.67 W/kg

**SAR(1 g) = 1.24 mW/g; SAR(10 g) = 0.863 mW/g**

Maximum value of SAR (measured) = 1.33 mW/g

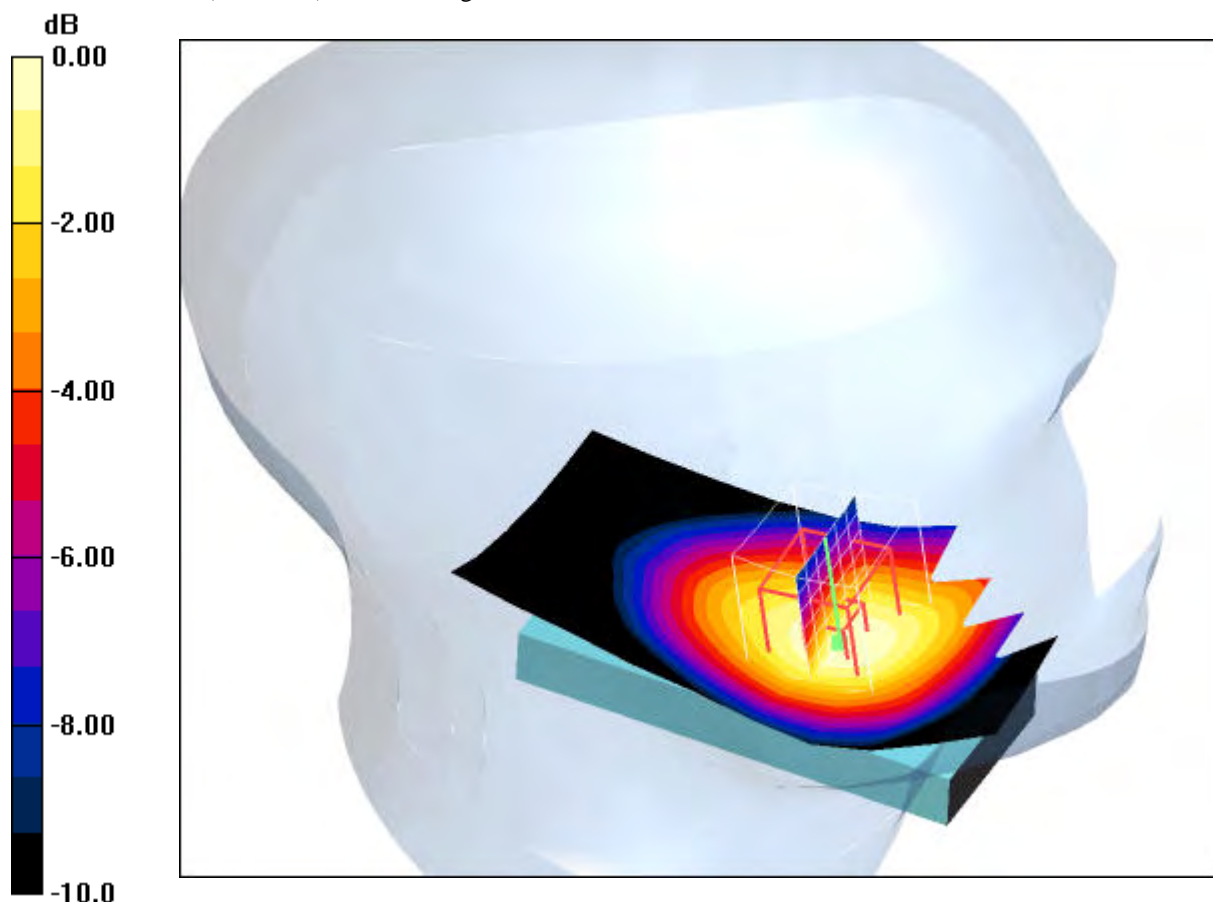

0 dB = 1.33mW/g

**Additional information:**

position or distance of DUT to SAM (if not standard head positions) :  
 ambient temperature: 22.8°C; liquid temperature: 22.3°C

Date/Time: 2009-04-03 10:48:28 Date/Time: 2009-04-03 10:55:02

**P1528\_OET65-LeftHandSide-UMTS-FDD-V**

**DUT: Sony Ericsson; Type: AAD-3880008-BV; Serial: T261F007CD**

Communication System: WCDMA FDD V; Frequency: 826.4 MHz; Duty Cycle: 1:1

Medium: HSL850 Medium parameters used (interpolated):  $f = 826.4 \text{ MHz}$ ;  $\sigma = 0.93 \text{ mho/m}$ ;  $\epsilon_r = 42.3$ ;  $\rho = 1000 \text{ kg/m}^3$

Phantom section: Left Section

DASY4 Configuration:

- Probe: ET3DV6 - SN1558; ConvF(6.19, 6.19, 6.19); Calibrated: 2008-08-15
- Sensor-Surface: 4mm (Mechanical And Optical Surface Detection)
- Electronics: DAE3 Sn413; Calibrated: 2009-01-08
- Phantom: SAM 12; Type: SAM; Serial: 1043
- Measurement SW: DASY4, V4.5 Build 19; Postprocessing SW: SEMCAD, V1.8 Build 146

**Tilt position - Low/Area Scan (51x91x1):** Measurement grid:  $dx=15\text{mm}$ ,  $dy=15\text{mm}$

Maximum value of SAR (interpolated) = 0.510 mW/g

**Tilt position - Low/Zoom Scan (7x7x7) (7x7x7)/Cube 0:** Measurement grid:  $dx=5\text{mm}$ ,  $dy=5\text{mm}$ ,  $dz=5\text{mm}$

Reference Value = 23.8 V/m; Power Drift = 0.01 dB

Peak SAR (extrapolated) = 0.620 W/kg

**SAR(1 g) = 0.491 mW/g; SAR(10 g) = 0.361 mW/g**

Maximum value of SAR (measured) = 0.516 mW/g

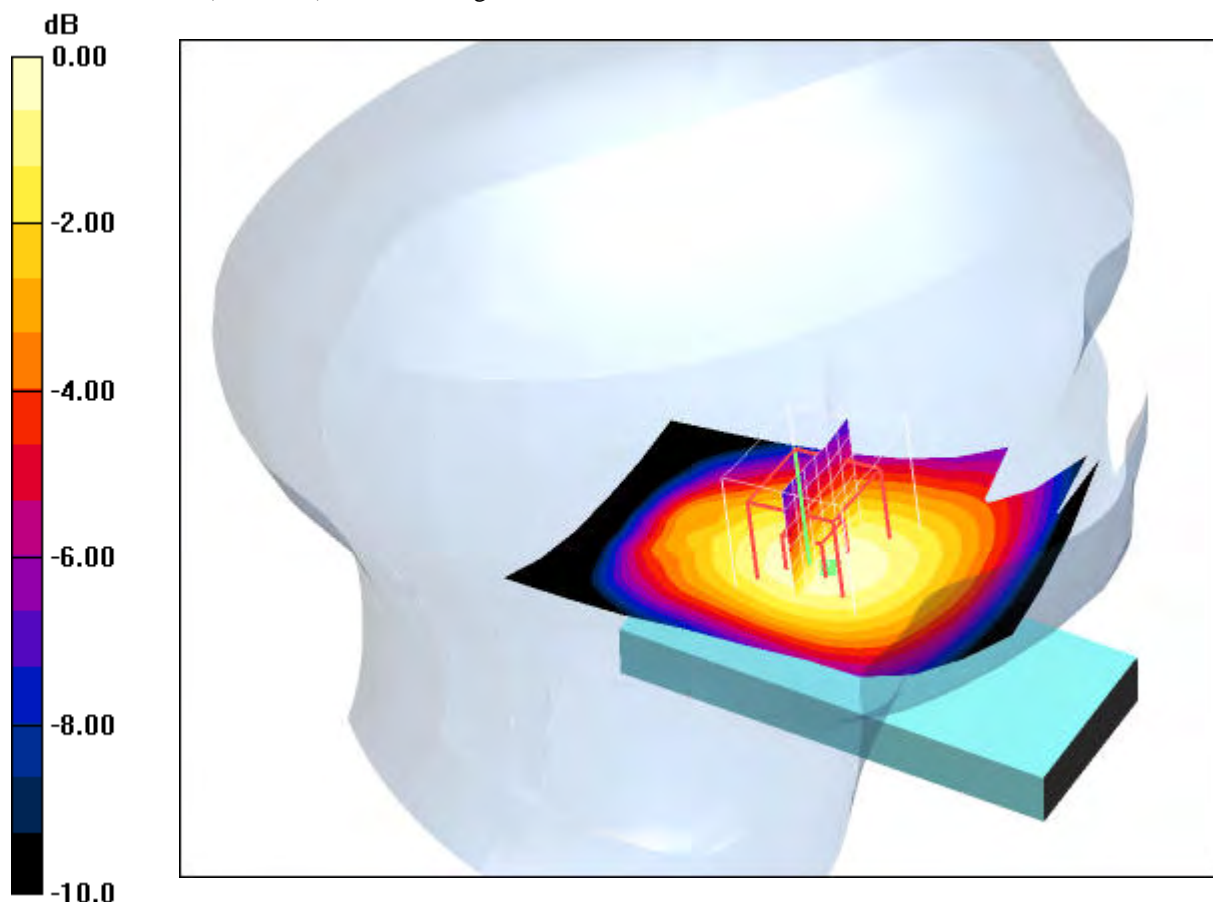

0 dB = 0.516mW/g

**Additional information:**

position or distance of DUT to SAM (if not standard head positions) :  
 ambient temperature: 22.9°C; liquid temperature: 22.2°C

Date/Time: 2009-04-03 10:28:17 Date/Time: 2009-04-03 10:34:49

**P1528\_OET65-LeftHandSide-UMTS-FDD-V**

**DUT: Sony Ericsson; Type: AAD-3880008-BV; Serial: T261F007CD**

Communication System: WCDMA FDD V; Frequency: 836.4 MHz; Duty Cycle: 1:1

Medium: HSL850 Medium parameters used (interpolated):  $f = 836.4 \text{ MHz}$ ;  $\sigma = 0.93 \text{ mho/m}$ ;  $\epsilon_r = 42.3$ ;  $\rho = 1000 \text{ kg/m}^3$

Phantom section: Left Section

DASY4 Configuration:

- Probe: ET3DV6 - SN1558; ConvF(6.19, 6.19, 6.19); Calibrated: 2008-08-15
- Sensor-Surface: 4mm (Mechanical And Optical Surface Detection)
- Electronics: DAE3 Sn413; Calibrated: 2009-01-08
- Phantom: SAM 12; Type: SAM; Serial: 1043
- Measurement SW: DASY4, V4.5 Build 19; Postprocessing SW: SEMCAD, V1.8 Build 146

**Tilt position - Middle/Area Scan (51x91x1):** Measurement grid:  $dx=15\text{mm}$ ,  $dy=15\text{mm}$

Maximum value of SAR (interpolated) = 0.548 mW/g

**Tilt position - Middle/Zoom Scan (7x7x7) (7x7x7)/Cube 0:** Measurement grid:  $dx=5\text{mm}$ ,  $dy=5\text{mm}$ ,  $dz=5\text{mm}$

Reference Value = 24.6 V/m; Power Drift = 0.01 dB

Peak SAR (extrapolated) = 0.669 W/kg

**SAR(1 g) = 0.527 mW/g; SAR(10 g) = 0.386 mW/g**

Maximum value of SAR (measured) = 0.551 mW/g

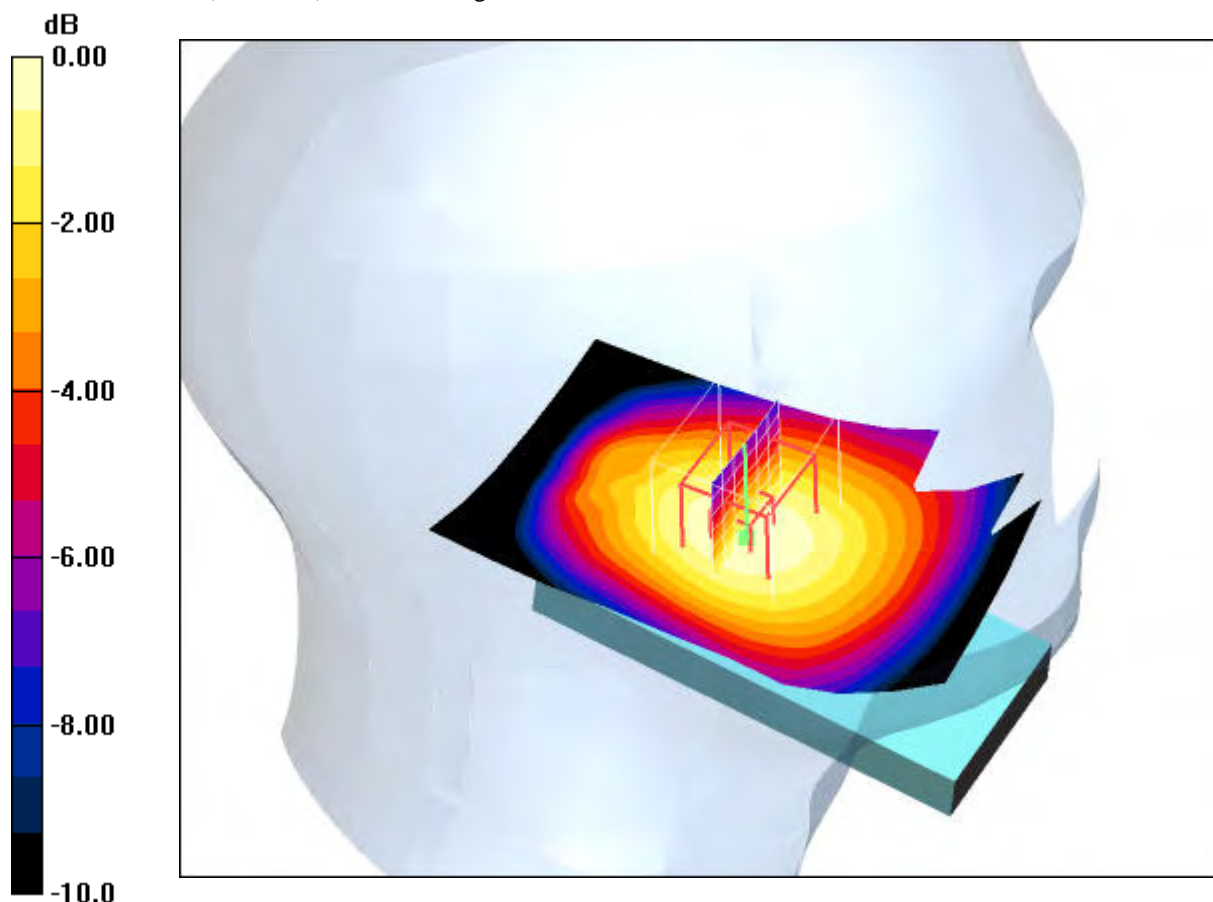

0 dB = 0.551mW/g

**Additional information:**

position or distance of DUT to SAM (if not standard head positions) :  
 ambient temperature: 22.9°C; liquid temperature: 22.2°C

Date/Time: 2009-04-03 10:07:55 Date/Time: 2009-04-03 10:14:23

**P1528\_OET65-LeftHandSide-UMTS-FDD-V**

**DUT: Sony Ericsson; Type: AAD-3880008-BV; Serial: T261F007CD**

Communication System: WCDMA FDD V; Frequency: 846.6 MHz; Duty Cycle: 1:1

Medium: HSL850 Medium parameters used (interpolated):  $f = 846.6 \text{ MHz}$ ;  $\sigma = 0.93 \text{ mho/m}$ ;  $\epsilon_r = 42.3$ ;  $\rho = 1000 \text{ kg/m}^3$

Phantom section: Left Section

DASY4 Configuration:

- Probe: ET3DV6 - SN1558; ConvF(6.19, 6.19, 6.19); Calibrated: 2008-08-15
- Sensor-Surface: 4mm (Mechanical And Optical Surface Detection)
- Electronics: DAE3 Sn413; Calibrated: 2009-01-08
- Phantom: SAM 12; Type: SAM; Serial: 1043
- Measurement SW: DASY4, V4.5 Build 19; Postprocessing SW: SEMCAD, V1.8 Build 146

**Tilt position - High/Area Scan (51x91x1):** Measurement grid:  $dx=15\text{mm}$ ,  $dy=15\text{mm}$

Maximum value of SAR (interpolated) = 0.534 mW/g

**Tilt position - High/Zoom Scan (7x7x7) (7x7x7)/Cube 0:** Measurement grid:  $dx=5\text{mm}$ ,  $dy=5\text{mm}$ ,  $dz=5\text{mm}$

Reference Value = 24.4 V/m; Power Drift = -0.01 dB

Peak SAR (extrapolated) = 0.660 W/kg

**SAR(1 g) = 0.518 mW/g; SAR(10 g) = 0.377 mW/g**

Maximum value of SAR (measured) = 0.541 mW/g

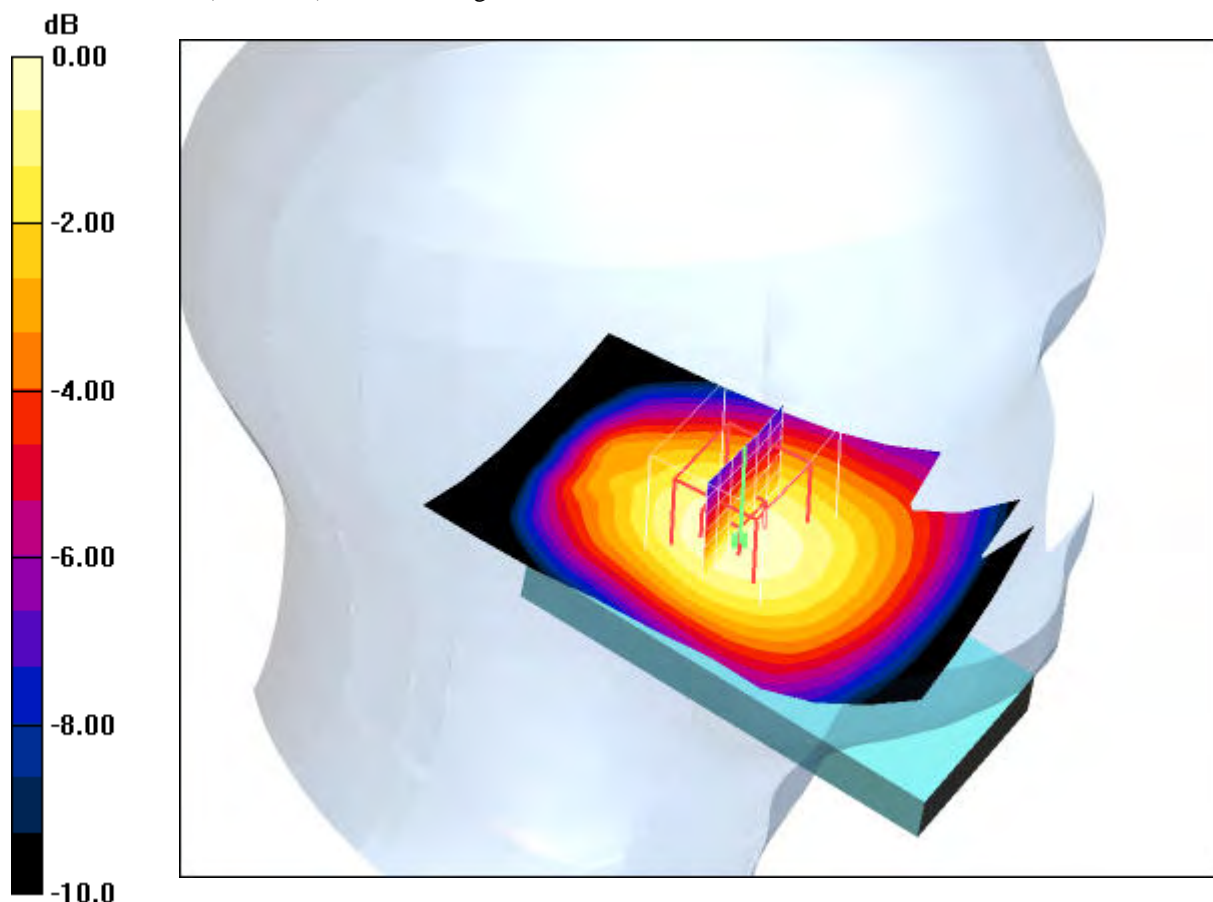

0 dB = 0.541mW/g

**Additional information:**

position or distance of DUT to SAM (if not standard head positions) :

ambient temperature: 22.9°C; liquid temperature: 22.2°C

Date/Time: 2009-04-03 13:08:09 Date/Time: 2009-04-03 13:14:32

**P1528\_OET65-RightHandSide-UMTS-FDD-V**

**DUT: Sony Ericsson; Type: AAD-3880008-BV; Serial: T261F007CD**

Communication System: WCDMA FDD V; Frequency: 826.4 MHz; Duty Cycle: 1:1

Medium: HSL850 Medium parameters used (interpolated):  $f = 826.4 \text{ MHz}$ ;  $\sigma = 0.93 \text{ mho/m}$ ;  $\epsilon_r = 42.3$ ;  $\rho = 1000 \text{ kg/m}^3$

Phantom section: Right Section

DASY4 Configuration:

- Probe: ET3DV6 - SN1558; ConvF(6.19, 6.19, 6.19); Calibrated: 2008-08-15
- Sensor-Surface: 4mm (Mechanical And Optical Surface Detection)
- Electronics: DAE3 Sn413; Calibrated: 2009-01-08
- Phantom: SAM 12; Type: SAM; Serial: 1043
- Measurement SW: DASY4, V4.5 Build 19; Postprocessing SW: SEMCAD, V1.8 Build 146

**Touch position - Low/Area Scan (51x91x1):** Measurement grid:  $dx=15\text{mm}$ ,  $dy=15\text{mm}$

Maximum value of SAR (interpolated) = 1.19 mW/g

**Touch position - Low/Zoom Scan (7x7x7) (7x7x7)/Cube 0:** Measurement grid:  $dx=5\text{mm}$ ,  $dy=5\text{mm}$ ,

$dz=5\text{mm}$

Reference Value = 37.2 V/m; Power Drift = 0.021 dB

Peak SAR (extrapolated) = 1.64 W/kg

**SAR(1 g) = 1.13 mW/g; SAR(10 g) = 0.770 mW/g**

Maximum value of SAR (measured) = 1.21 mW/g

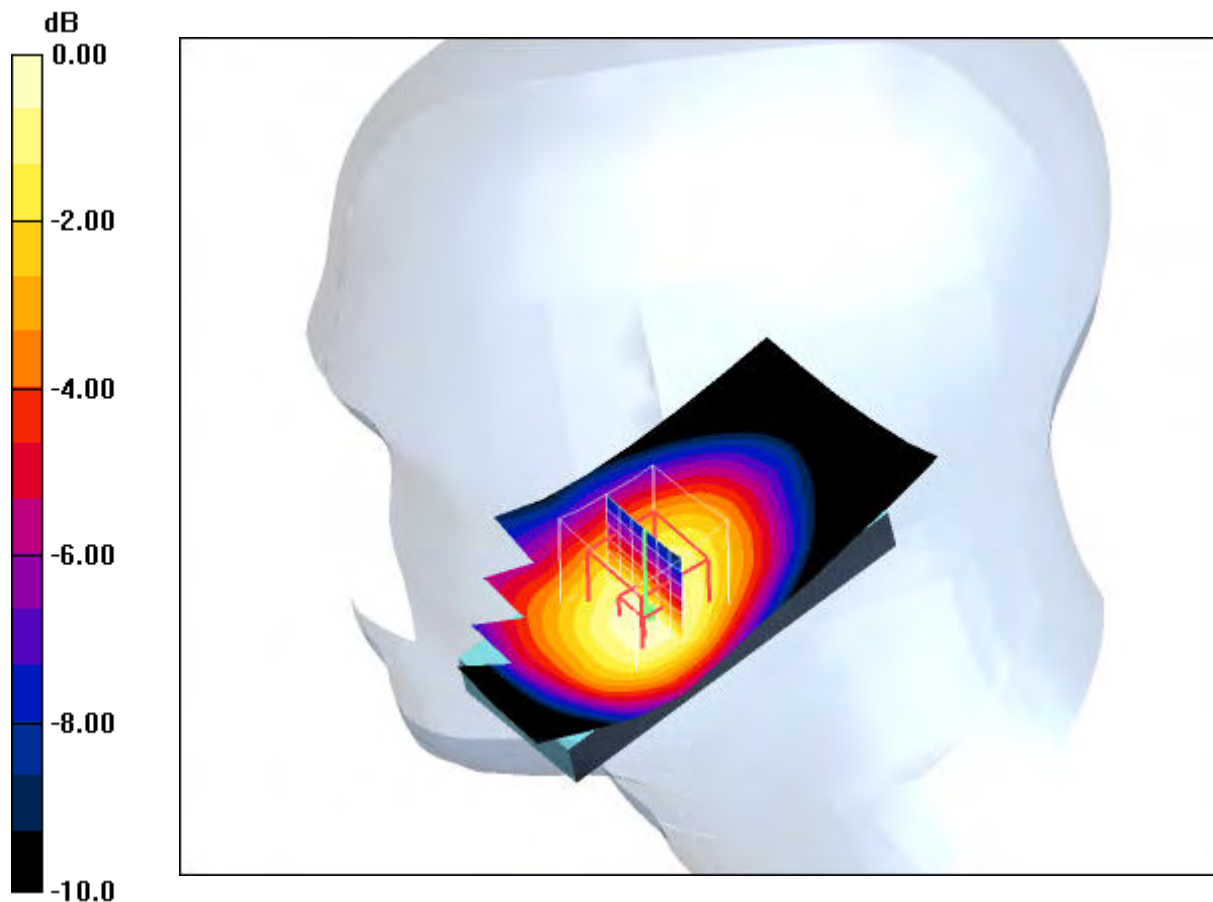

0 dB = 1.21mW/g

**Additional information:**

position or distance of DUT to SAM (if not standard head positions) :  
 ambient temperature: 23.0°C; liquid temperature: 22.2°C



Date/Time: 2009-04-03 12:46:21 Date/Time: 2009-04-03 12:52:44

**P1528\_OET65-RightHandSide-UMTS-FDD-V**

**DUT: Sony Ericsson; Type: AAD-3880008-BV; Serial: T261F007CD**

Communication System: WCDMA FDD V; Frequency: 836.4 MHz; Duty Cycle: 1:1

Medium: HSL850 Medium parameters used (interpolated):  $f = 836.4 \text{ MHz}$ ;  $\sigma = 0.93 \text{ mho/m}$ ;  $\epsilon_r = 42.3$ ;  $\rho = 1000 \text{ kg/m}^3$

Phantom section: Right Section

DASY4 Configuration:

- Probe: ET3DV6 - SN1558; ConvF(6.19, 6.19, 6.19); Calibrated: 2008-08-15
- Sensor-Surface: 4mm (Mechanical And Optical Surface Detection)
- Electronics: DAE3 Sn413; Calibrated: 2009-01-08
- Phantom: SAM 12; Type: SAM; Serial: 1043
- Measurement SW: DASY4, V4.5 Build 19; Postprocessing SW: SEMCAD, V1.8 Build 146

**Touch position - Middle/Area Scan (51x91x1):** Measurement grid:  $dx=15\text{mm}$ ,  $dy=15\text{mm}$

Maximum value of SAR (interpolated) = 1.30 mW/g

**Touch position - Middle/Zoom Scan (7x7x7) (7x7x7)/Cube 0:** Measurement grid:  $dx=5\text{mm}$ ,  $dy=5\text{mm}$ ,  $dz=5\text{mm}$

Reference Value = 39.1 V/m; Power Drift = 0.014 dB

Peak SAR (extrapolated) = 1.81 W/kg

**SAR(1 g) = 1.24 mW/g; SAR(10 g) = 0.839 mW/g**

Maximum value of SAR (measured) = 1.32 mW/g

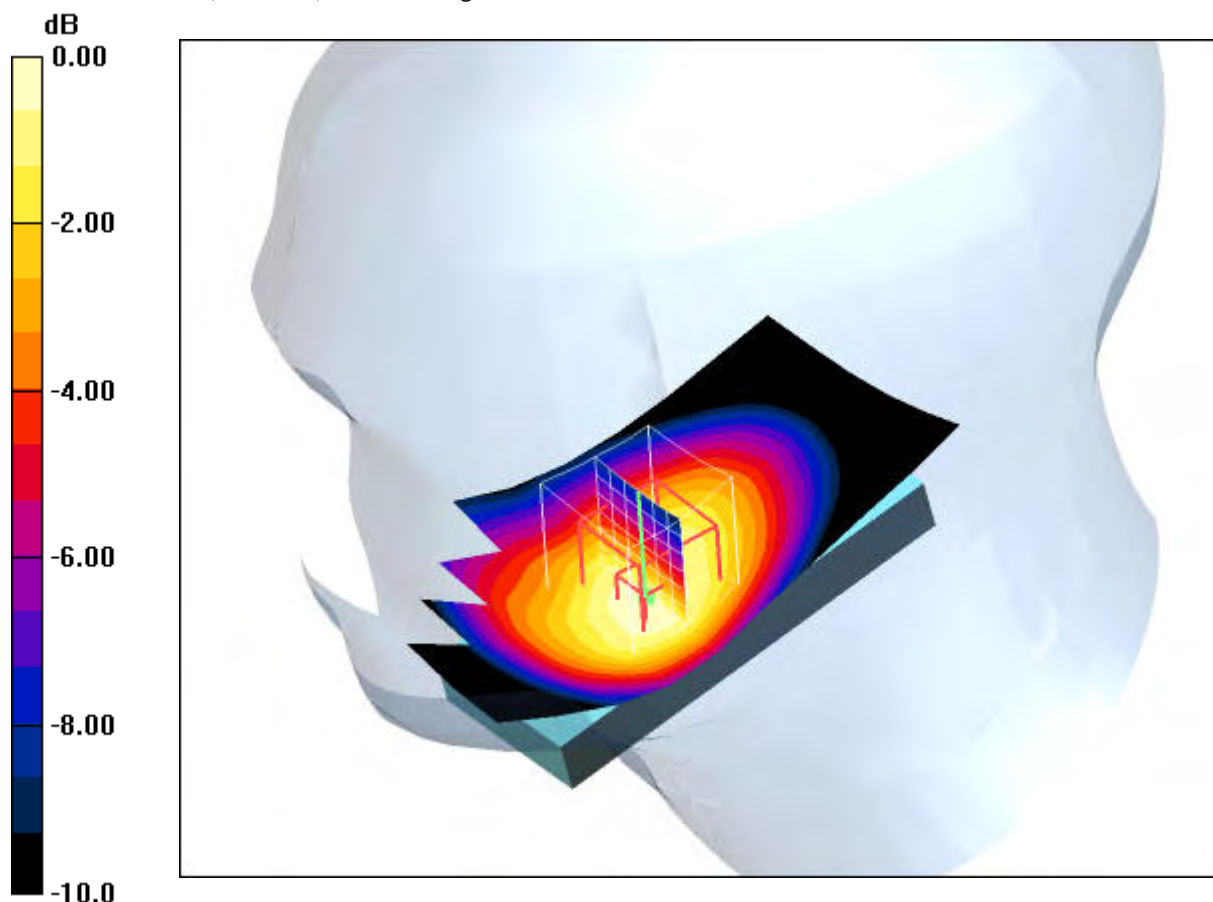

0 dB = 1.32mW/g

**Additional information:**

position or distance of DUT to SAM (if not standard head positions) :  
 ambient temperature: 23.0°C; liquid temperature: 22.2°C

Date/Time: 2009-04-03 12:23:30 Date/Time: 2009-04-03 12:31:09

**P1528\_OET65-RightHandSide-UMTS-FDD-V**

**DUT: Sony Ericsson; Type: AAD-3880008-BV; Serial: T261F007CD**

Communication System: WCDMA FDD V; Frequency: 846.6 MHz; Duty Cycle: 1:1

Medium: HSL850 Medium parameters used (interpolated):  $f = 846.6 \text{ MHz}$ ;  $\sigma = 0.93 \text{ mho/m}$ ;  $\epsilon_r = 42.3$ ;  $\rho = 1000 \text{ kg/m}^3$

Phantom section: Right Section

DASY4 Configuration:

- Probe: ET3DV6 - SN1558; ConvF(6.19, 6.19, 6.19); Calibrated: 2008-08-15
- Sensor-Surface: 4mm (Mechanical And Optical Surface Detection)
- Electronics: DAE3 Sn413; Calibrated: 2009-01-08
- Phantom: SAM 12; Type: SAM; Serial: 1043
- Measurement SW: DASY4, V4.5 Build 19; Postprocessing SW: SEMCAD, V1.8 Build 146

**Touch position - High/Area Scan (51x91x1):** Measurement grid:  $dx=15\text{mm}$ ,  $dy=15\text{mm}$

Maximum value of SAR (interpolated) = 1.29 mW/g

**Touch position - High/Zoom Scan (7x7x7) (7x7x7)/Cube 0:** Measurement grid:  $dx=5\text{mm}$ ,  $dy=5\text{mm}$ ,  $dz=5\text{mm}$

Reference Value = 38.6 V/m; Power Drift = 0.01 dB

Peak SAR (extrapolated) = 1.78 W/kg

**SAR(1 g) = 1.22 mW/g; SAR(10 g) = 0.820 mW/g**

Maximum value of SAR (measured) = 1.30 mW/g

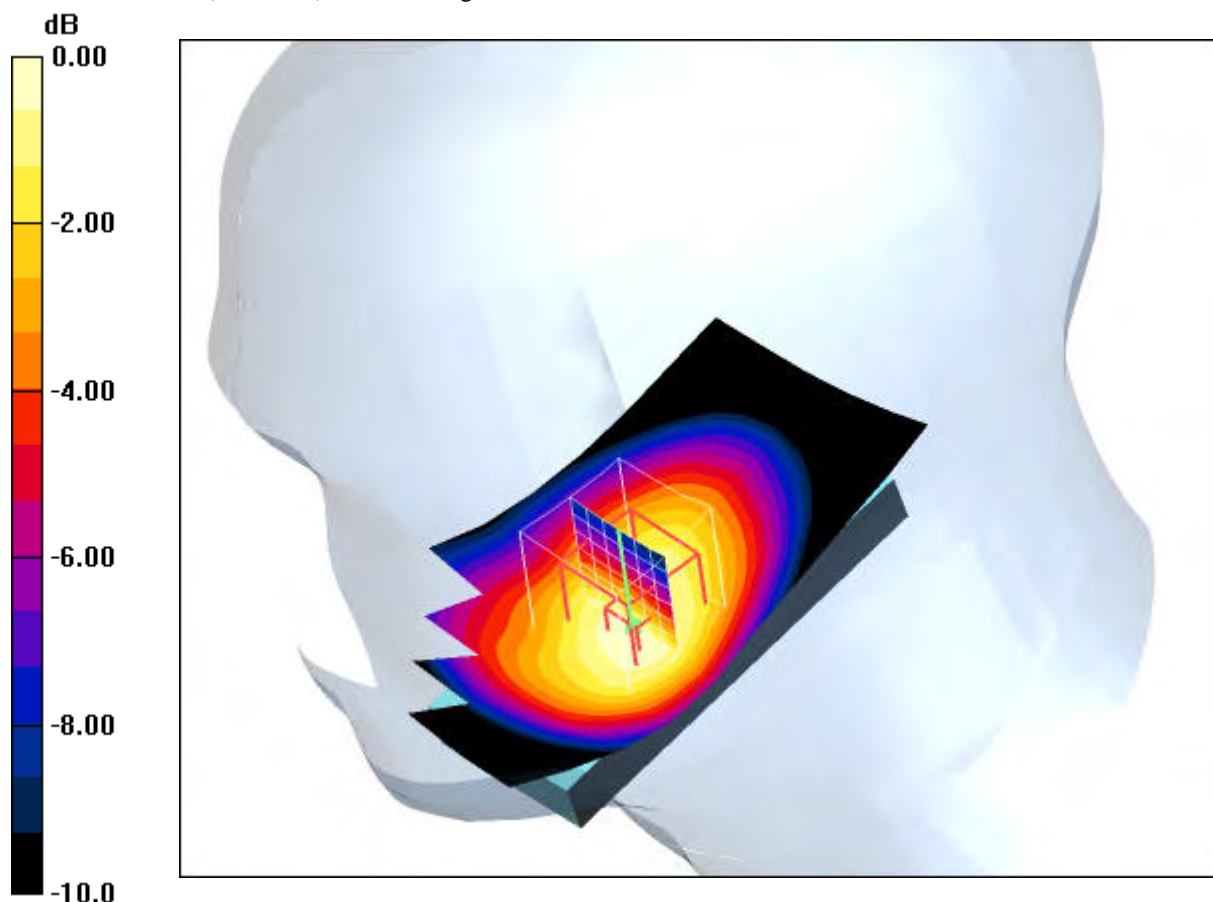

0 dB = 1.30mW/g

**Additional information:**

position or distance of DUT to SAM (if not standard head positions) :  
 ambient temperature: 23.0°C; liquid temperature: 22.2°C

Date/Time: 2009-04-03 11:13:13 Date/Time: 2009-04-03 11:21:10

**P1528\_OET65-RightHandSide-UMTS-FDD-V**

**DUT: Sony Ericsson; Type: AAD-3880008-BV; Serial: T261F007CD**

Communication System: WCDMA FDD V; Frequency: 826.4 MHz; Duty Cycle: 1:1

Medium: HSL850 Medium parameters used (interpolated):  $f = 826.4 \text{ MHz}$ ;  $\sigma = 0.93 \text{ mho/m}$ ;  $\epsilon_r = 42.3$ ;  $\rho = 1000 \text{ kg/m}^3$

Phantom section: Right Section

DASY4 Configuration:

- Probe: ET3DV6 - SN1558; ConvF(6.19, 6.19, 6.19); Calibrated: 2008-08-15
- Sensor-Surface: 4mm (Mechanical And Optical Surface Detection)
- Electronics: DAE3 Sn413; Calibrated: 2009-01-08
- Phantom: SAM 12; Type: SAM; Serial: 1043
- Measurement SW: DASY4, V4.5 Build 19; Postprocessing SW: SEMCAD, V1.8 Build 146

**Tilt position - Low/Area Scan (51x91x1):** Measurement grid:  $dx=15\text{mm}$ ,  $dy=15\text{mm}$

Maximum value of SAR (interpolated) = 0.520 mW/g

**Tilt position - Low/Zoom Scan (7x7x7) (7x7x7)/Cube 0:** Measurement grid:  $dx=5\text{mm}$ ,  $dy=5\text{mm}$ ,

$dz=5\text{mm}$

Reference Value = 23.8 V/m; Power Drift = -0.031 dB

Peak SAR (extrapolated) = 0.621 W/kg

**SAR(1 g) = 0.490 mW/g; SAR(10 g) = 0.359 mW/g**

Maximum value of SAR (measured) = 0.522 mW/g

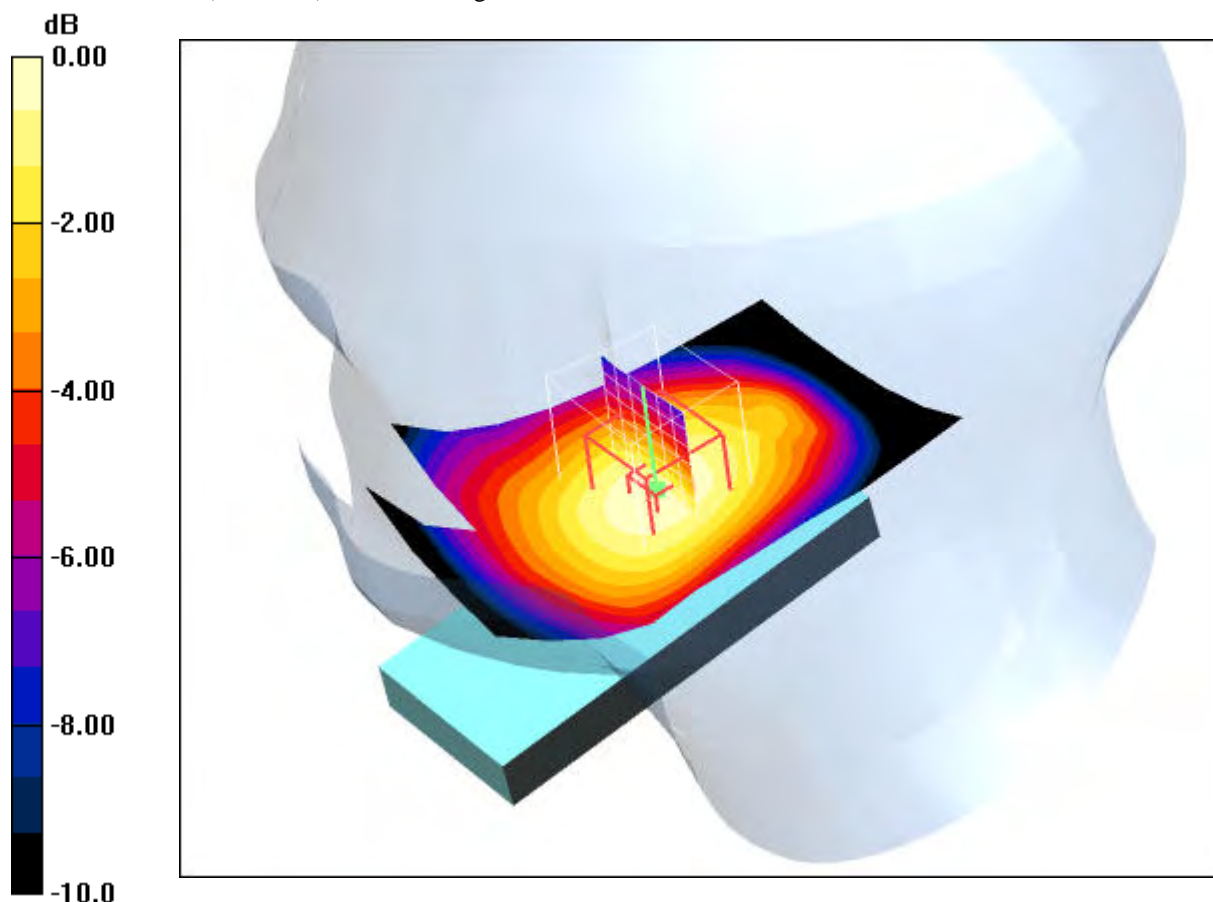

0 dB = 0.522mW/g

**Additional information:**

position or distance of DUT to SAM (if not standard head positions) :

ambient temperature: 23.0°C; liquid temperature: 22.2°C

Date/Time: 2009-04-03 11:36:50 Date/Time: 2009-04-03 11:43:12

**P1528\_OET65-RightHandSide-UMTS-FDD-V**

**DUT: Sony Ericsson; Type: AAD-3880008-BV; Serial: T261F007CD**

Communication System: WCDMA FDD V; Frequency: 836.4 MHz; Duty Cycle: 1:1

Medium: HSL850 Medium parameters used (interpolated):  $f = 836.4 \text{ MHz}$ ;  $\sigma = 0.93 \text{ mho/m}$ ;  $\epsilon_r = 42.3$ ;  $\rho = 1000 \text{ kg/m}^3$

Phantom section: Right Section

DASY4 Configuration:

- Probe: ET3DV6 - SN1558; ConvF(6.19, 6.19, 6.19); Calibrated: 2008-08-15
- Sensor-Surface: 4mm (Mechanical And Optical Surface Detection)
- Electronics: DAE3 Sn413; Calibrated: 2009-01-08
- Phantom: SAM 12; Type: SAM; Serial: 1043
- Measurement SW: DASY4, V4.5 Build 19; Postprocessing SW: SEMCAD, V1.8 Build 146

**Tilt position - Middle/Area Scan (51x91x1):** Measurement grid:  $dx=15\text{mm}$ ,  $dy=15\text{mm}$

Maximum value of SAR (interpolated) = 0.543 mW/g

**Tilt position - Middle/Zoom Scan (7x7x7) (7x7x7)/Cube 0:** Measurement grid:  $dx=5\text{mm}$ ,  $dy=5\text{mm}$ ,  $dz=5\text{mm}$

Reference Value = 24.5 V/m; Power Drift = 0.00 dB

Peak SAR (extrapolated) = 0.662 W/kg

**SAR(1 g) = 0.516 mW/g; SAR(10 g) = 0.375 mW/g**

Maximum value of SAR (measured) = 0.548 mW/g

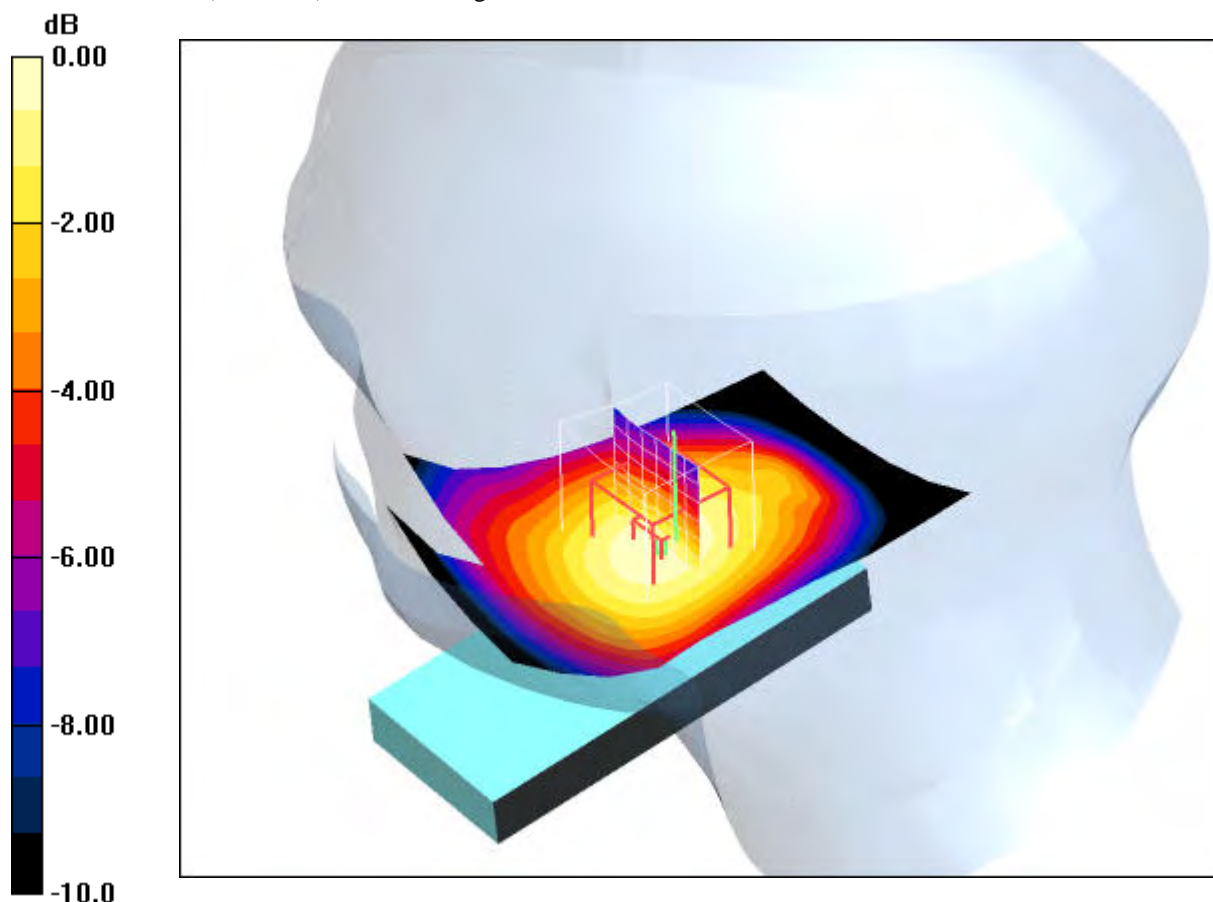

0 dB = 0.548mW/g

**Additional information:**

position or distance of DUT to SAM (if not standard head positions) :

ambient temperature: 23.0°C; liquid temperature: 22.2°C

**P1528\_OET65-RightHandSide-UMTS-FDD-V**

**DUT: Sony Ericsson; Type: AAD-3880008-BV; Serial: T261F007CD**

Communication System: WCDMA FDD V; Frequency: 846.6 MHz; Duty Cycle: 1:1

Medium: HSL850 Medium parameters used (interpolated):  $f = 846.6 \text{ MHz}$ ;  $\sigma = 0.93 \text{ mho/m}$ ;  $\epsilon_r = 42.3$ ;  $\rho = 1000 \text{ kg/m}^3$

Phantom section: Right Section

DASY4 Configuration:

- Probe: ET3DV6 - SN1558; ConvF(6.19, 6.19, 6.19); Calibrated: 2008-08-15
- Sensor-Surface: 4mm (Mechanical And Optical Surface Detection)
- Electronics: DAE3 Sn413; Calibrated: 2009-01-08
- Phantom: SAM 12; Type: SAM; Serial: 1043
- Measurement SW: DASY4, V4.5 Build 19; Postprocessing SW: SEMCAD, V1.8 Build 146

**Tilt position - High/Area Scan (51x91x1):** Measurement grid:  $dx=15\text{mm}$ ,  $dy=15\text{mm}$

Maximum value of SAR (interpolated) = 0.532 mW/g

**Tilt position - High/Zoom Scan (7x7x7) (7x7x7)/Cube 0:** Measurement grid:  $dx=5\text{mm}$ ,  $dy=5\text{mm}$ ,  $dz=5\text{mm}$

Reference Value = 24.1 V/m; Power Drift = 0.00 dB

Peak SAR (extrapolated) = 0.642 W/kg

**SAR(1 g) = 0.499 mW/g; SAR(10 g) = 0.362 mW/g**

Maximum value of SAR (measured) = 0.527 mW/g

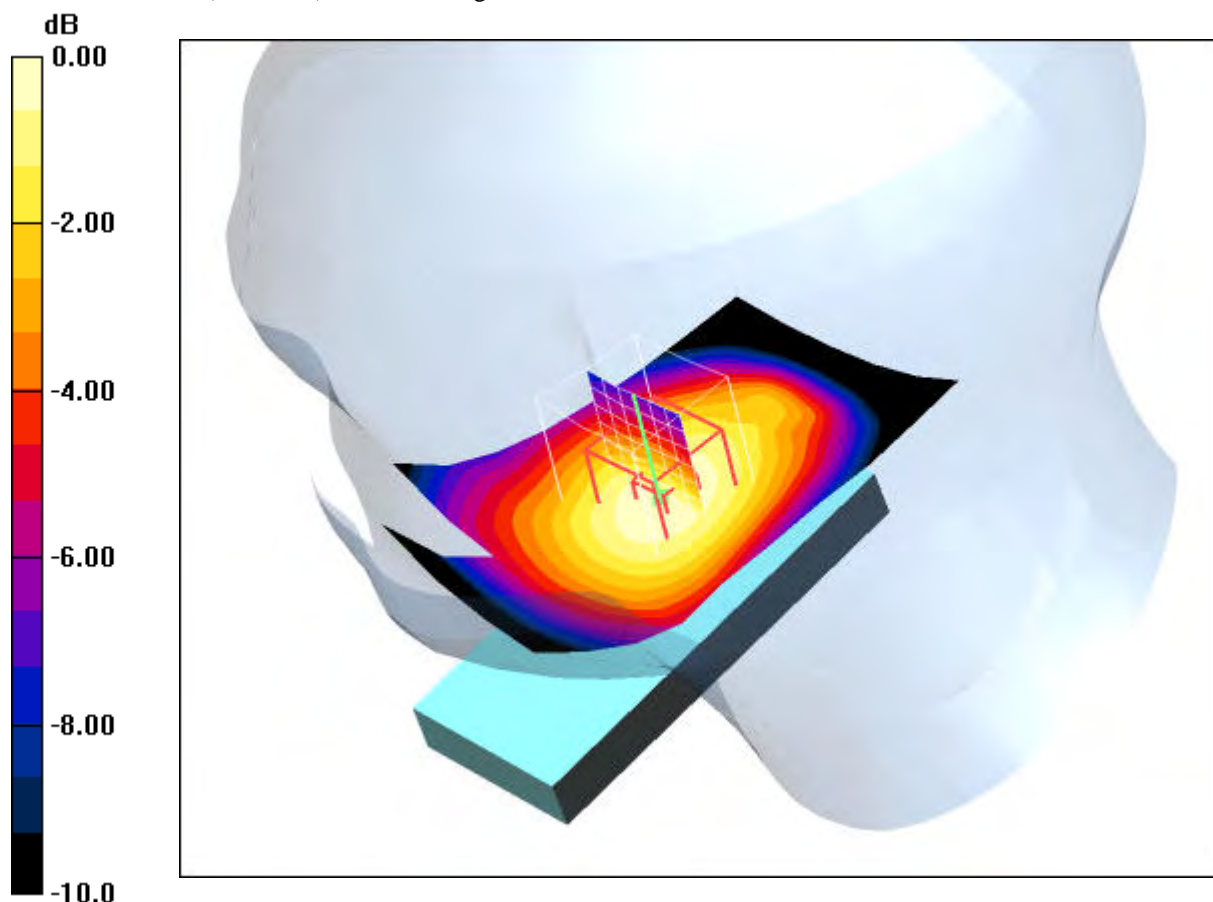

0 dB = 0.527mW/g

**Additional information:**

position or distance of DUT to SAM (if not standard head positions) :

ambient temperature: 23.0°C; liquid temperature: 22.2°C

**Annex 2.8 UMTS (WCDMA) FDD V 850 MHz body**

Date/Time: 2009-04-02 16:58:12 Date/Time: 2009-04-02 17:04:00

**P1528\_OET65-Body-UMTS-FDD-V**

**DUT: Sony Ericsson; Type: AAD-3880008-BV; Serial: T261F007CD**

Communication System: WCDMA FDD V; Frequency: 826.4 MHz; Duty Cycle: 1:1

Medium: M850 Medium parameters used (interpolated):  $f = 826.4 \text{ MHz}$ ;  $\sigma = 0.99 \text{ mho/m}$ ;  $\epsilon_r = 54.3$ ;  $\rho = 1000 \text{ kg/m}^3$

Phantom section: Flat Section

DASY4 Configuration:

- Probe: ET3DV6 - SN1558; ConvF(5.96, 5.96, 5.96); Calibrated: 2008-08-15
- Sensor-Surface: 4mm (Mechanical And Optical Surface Detection)
- Electronics: DAE3 Sn413; Calibrated: 2009-01-08
- Phantom: SAM 12; Type: SAM; Serial: 1043
- Measurement SW: DASY4, V4.5 Build 19; Postprocessing SW: SEMCAD, V1.8 Build 146

**Front position - Low/Area Scan (51x81x1):** Measurement grid:  $dx=15\text{mm}$ ,  $dy=15\text{mm}$

Maximum value of SAR (interpolated) = 0.704 mW/g

**Front position - Low/Zoom Scan (7x7x7) (7x7x7)/Cube 0:** Measurement grid:  $dx=5\text{mm}$ ,  $dy=5\text{mm}$ ,  $dz=5\text{mm}$

Reference Value = 27.6 V/m; Power Drift = 0.00 dB

Peak SAR (extrapolated) = 0.882 W/kg

**SAR(1 g) = 0.666 mW/g; SAR(10 g) = 0.481 mW/g**

Maximum value of SAR (measured) = 0.703 mW/g

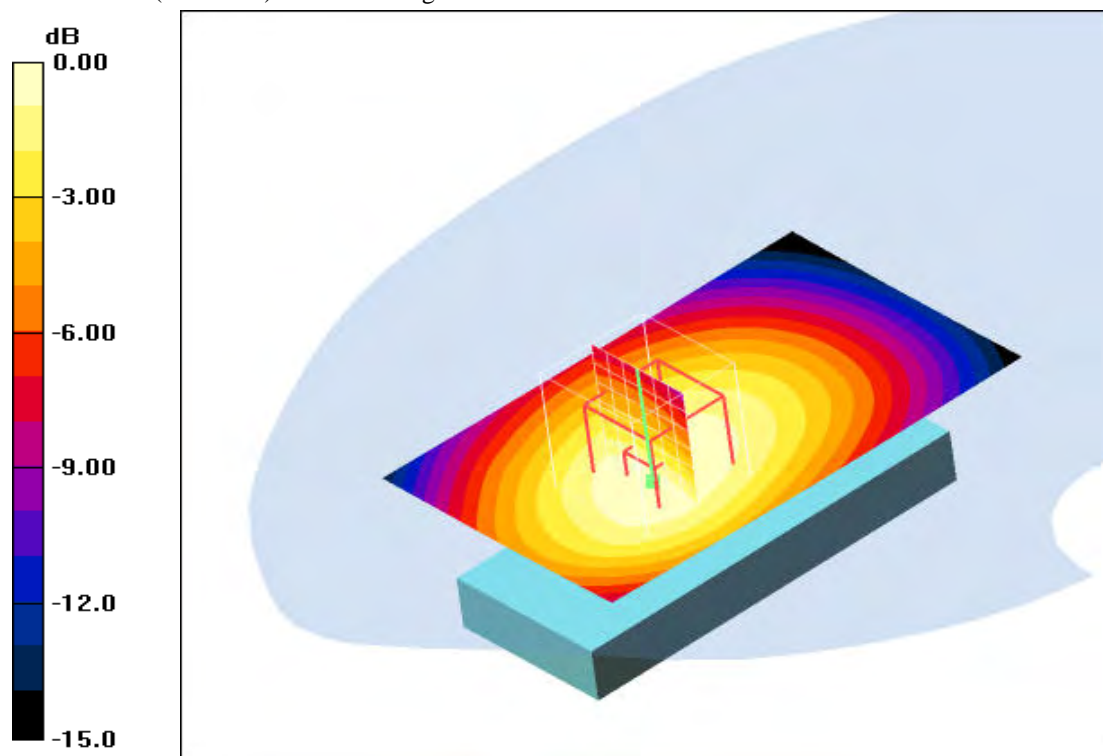

0 dB = 0.703mW/g

**Additional information:**

position or distance of DUT to SAM :15 mm

ambient temperature: 22.6°C; liquid temperature: 21.5°C

Date/Time: 2009-04-02 16:39:40 Date/Time: 2009-04-02 16:45:42

**P1528\_OET65-Body-UMTS-FDD-V**

**DUT: Sony Ericsson; Type: AAD-3880008-BV; Serial: T261F007CD**

Communication System: WCDMA FDD V; Frequency: 836.4 MHz; Duty Cycle: 1:1

Medium: M850 Medium parameters used (interpolated):  $f = 836.4 \text{ MHz}$ ;  $\sigma = 0.99 \text{ mho/m}$ ;  $\epsilon_r = 54.3$ ;  $\rho = 1000 \text{ kg/m}^3$

Phantom section: Flat Section

DASY4 Configuration:

- Probe: ET3DV6 - SN1558; ConvF(5.96, 5.96, 5.96); Calibrated: 2008-08-15
- Sensor-Surface: 4mm (Mechanical And Optical Surface Detection)
- Electronics: DAE3 Sn413; Calibrated: 2009-01-08
- Phantom: SAM 12; Type: SAM; Serial: 1043
- Measurement SW: DASY4, V4.5 Build 19; Postprocessing SW: SEMCAD, V1.8 Build 146

**Front position - Middle/Area Scan (51x81x1):** Measurement grid:  $dx=15\text{mm}$ ,  $dy=15\text{mm}$

Maximum value of SAR (interpolated) = 0.815 mW/g

**Front position - Middle/Zoom Scan (7x7x7) (7x7x7)/Cube 0:** Measurement grid:  $dx=5\text{mm}$ ,  $dy=5\text{mm}$ ,  $dz=5\text{mm}$

Reference Value = 29.8 V/m; Power Drift = -0.011 dB

Peak SAR (extrapolated) = 1.03 W/kg

**SAR(1 g) = 0.767 mW/g; SAR(10 g) = 0.552 mW/g**

Maximum value of SAR (measured) = 0.816 mW/g

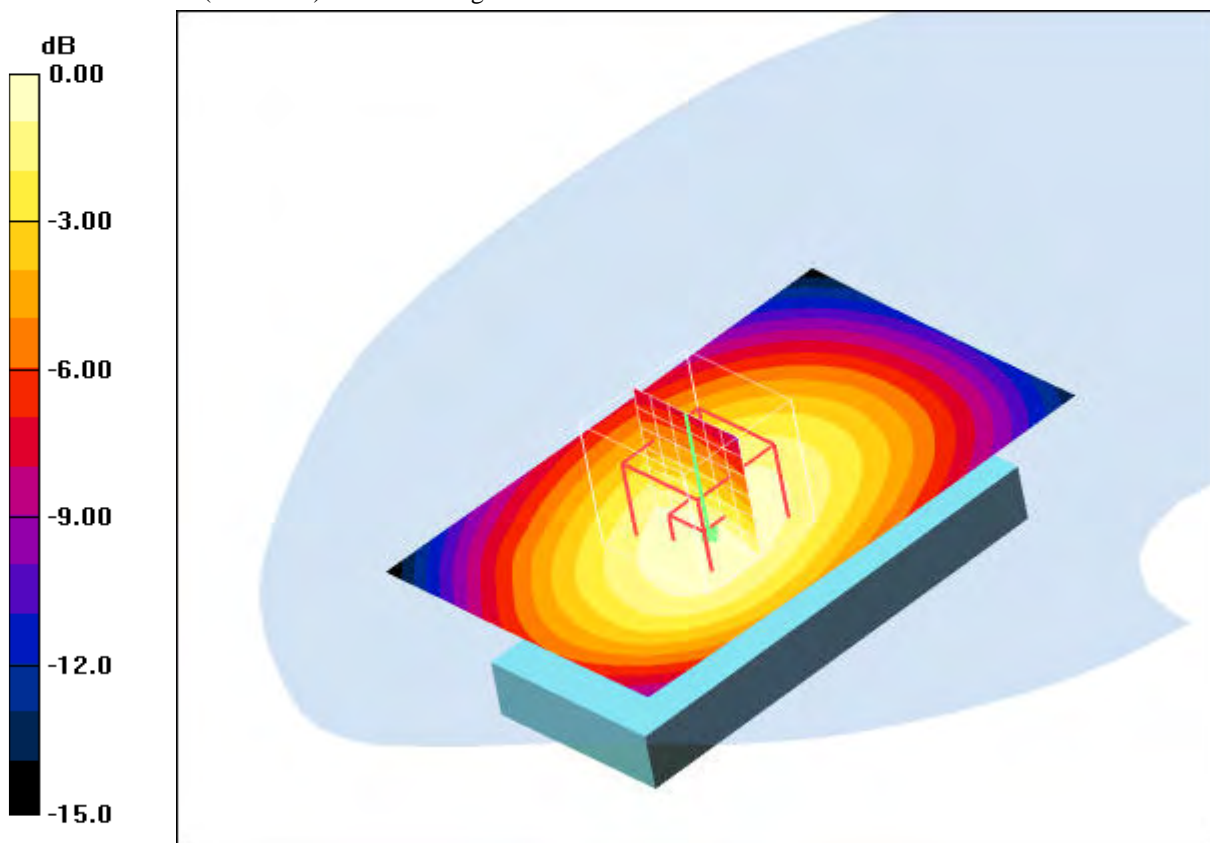

0 dB = 0.816mW/g

**Additional information:**

position or distance of DUT to SAM :15 mm

ambient temperature: 22.6°C; liquid temperature: 21.5°C

**P1528\_OET65-Body-UMTS-FDD-V**

**DUT: Sony Ericsson; Type: AAD-3880008-BV; Serial: T261F007CD**

Communication System: WCDMA FDD V; Frequency: 846.6 MHz; Duty Cycle: 1:1

Medium: M850 Medium parameters used (interpolated):  $f = 846.6 \text{ MHz}$ ;  $\sigma = 0.99 \text{ mho/m}$ ;  $\epsilon_r = 54.3$ ;  $\rho = 1000 \text{ kg/m}^3$

Phantom section: Flat Section

DASY4 Configuration:

- Probe: ET3DV6 - SN1558; ConvF(5.96, 5.96, 5.96); Calibrated: 2008-08-15
- Sensor-Surface: 4mm (Mechanical And Optical Surface Detection) Sensor-Surface: 4mm (Mechanical Surface Detection)
- Electronics: DAE3 Sn413; Calibrated: 2009-01-08
- Phantom: SAM 12; Type: SAM; Serial: 1043
- Measurement SW: DASY4, V4.5 Build 19; Postprocessing SW: SEMCAD, V1.8 Build 146

**Front position - High/Area Scan (51x81x1):** Measurement grid:  $dx=15\text{mm}$ ,  $dy=15\text{mm}$

Maximum value of SAR (interpolated) = 0.749 mW/g

**Front position - High/Zoom Scan (7x7x7) (7x7x7)/Cube 0:** Measurement grid:  $dx=5\text{mm}$ ,  $dy=5\text{mm}$ ,  $dz=5\text{mm}$

Reference Value = 28.3 V/m; Power Drift = -0.01 dB

Peak SAR (extrapolated) = 0.893 W/kg

**SAR(1 g) = 0.691 mW/g; SAR(10 g) = 0.501 mW/g**

Maximum value of SAR (measured) = 0.734 mW/g

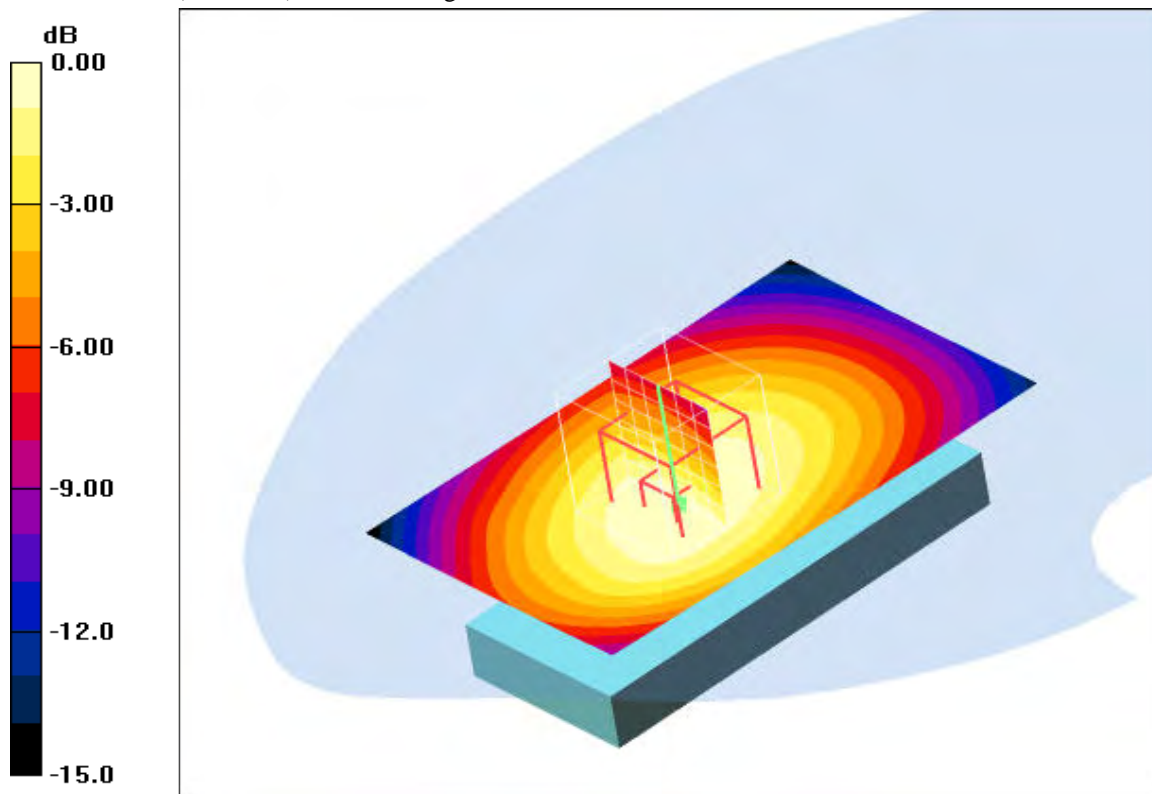

0 dB = 0.734mW/g

**Additional information:**

position or distance of DUT to SAM :15 mm

ambient temperature: 22.6°C; liquid temperature: 21.5°C



Date/Time: 2009-04-02 18:42:55 Date/Time: 2009-04-02 18:48:59

**P1528\_OET65-Body-UMTS-FDD-V**

**DUT: Sony Ericsson; Type: AAD-3880008-BV; Serial: T261F007CD**

Communication System: WCDMA FDD V; Frequency: 826.4 MHz; Duty Cycle: 1:1

Medium: M850 Medium parameters used (interpolated):  $f = 826.4 \text{ MHz}$ ;  $\sigma = 0.99 \text{ mho/m}$ ;  $\epsilon_r = 54.3$ ;  $\rho = 1000 \text{ kg/m}^3$

Phantom section: Flat Section

DASY4 Configuration:

- Probe: ET3DV6 - SN1558; ConvF(5.96, 5.96, 5.96); Calibrated: 2008-08-15
- Sensor-Surface: 4mm (Mechanical And Optical Surface Detection)
- Electronics: DAE3 Sn413; Calibrated: 2009-01-08
- Phantom: SAM 12; Type: SAM; Serial: 1043
- Measurement SW: DASY4, V4.5 Build 19; Postprocessing SW: SEMCAD, V1.8 Build 146

**Rear position - Low/Area Scan (51x81x1):** Measurement grid:  $dx=15\text{mm}$ ,  $dy=15\text{mm}$

Maximum value of SAR (interpolated) = 0.639 mW/g

**Rear position - Low/Zoom Scan (7x7x7) (7x7x7)/Cube 0:** Measurement grid:  $dx=5\text{mm}$ ,  $dy=5\text{mm}$ ,  $dz=5\text{mm}$

Reference Value = 25.9 V/m; Power Drift = 0.01 dB

Peak SAR (extrapolated) = 0.784 W/kg

**SAR(1 g) = 0.600 mW/g; SAR(10 g) = 0.433 mW/g**

Maximum value of SAR (measured) = 0.634 mW/g

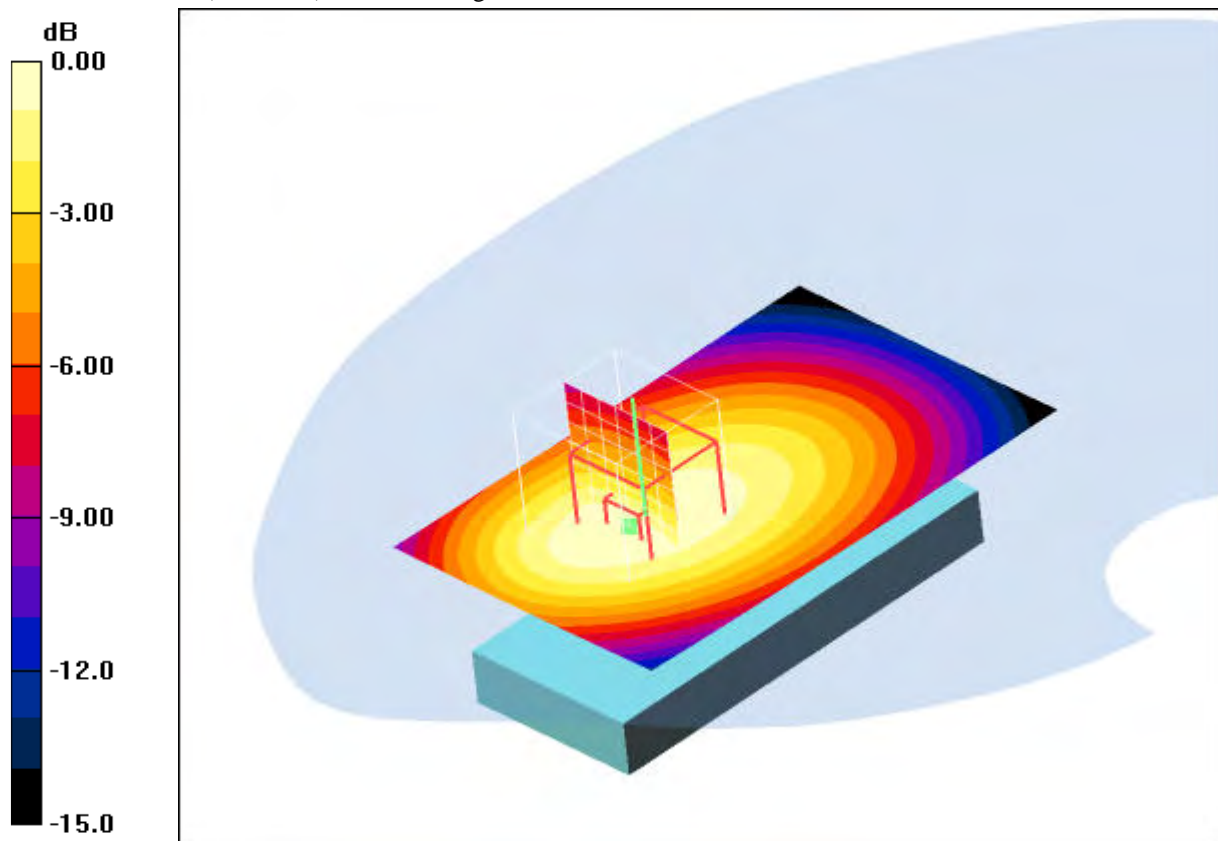

0 dB = 0.634mW/g

**Additional information:**

position or distance of DUT to SAM : 15 mm

ambient temperature: 22.8°C; liquid temperature: 21.6°C

Date/Time: 2009-04-02 18:22:50 Date/Time: 2009-04-02 18:29:18

**P1528\_OET65-Body-UMTS-FDD-V**

**DUT: Sony Ericsson; Type: AAD-3880008-BV; Serial: T261F007CD**

Communication System: WCDMA FDD V; Frequency: 836.4 MHz; Duty Cycle: 1:1

Medium: M850 Medium parameters used (interpolated):  $f = 836.4 \text{ MHz}$ ;  $\sigma = 0.99 \text{ mho/m}$ ;  $\epsilon_r = 54.3$ ;  $\rho = 1000 \text{ kg/m}^3$

Phantom section: Flat Section

DASY4 Configuration:

- Probe: ET3DV6 - SN1558; ConvF(5.96, 5.96, 5.96); Calibrated: 2008-08-15
- Sensor-Surface: 4mm (Mechanical And Optical Surface Detection)
- Electronics: DAE3 Sn413; Calibrated: 2009-01-08
- Phantom: SAM 12; Type: SAM; Serial: 1043
- Measurement SW: DASY4, V4.5 Build 19; Postprocessing SW: SEMCAD, V1.8 Build 146

**Rear position - Middle/Area Scan (51x81x1):** Measurement grid:  $dx=15\text{mm}$ ,  $dy=15\text{mm}$

Maximum value of SAR (interpolated) = 0.718 mW/g

**Rear position - Middle/Zoom Scan (7x7x7) (7x7x7)/Cube 0:** Measurement grid:  $dx=5\text{mm}$ ,  $dy=5\text{mm}$ ,  $dz=5\text{mm}$

Reference Value = 27.3 V/m; Power Drift = 0.015 dB

Peak SAR (extrapolated) = 0.887 W/kg

**SAR(1 g) = 0.673 mW/g; SAR(10 g) = 0.484 mW/g**

Maximum value of SAR (measured) = 0.718 mW/g

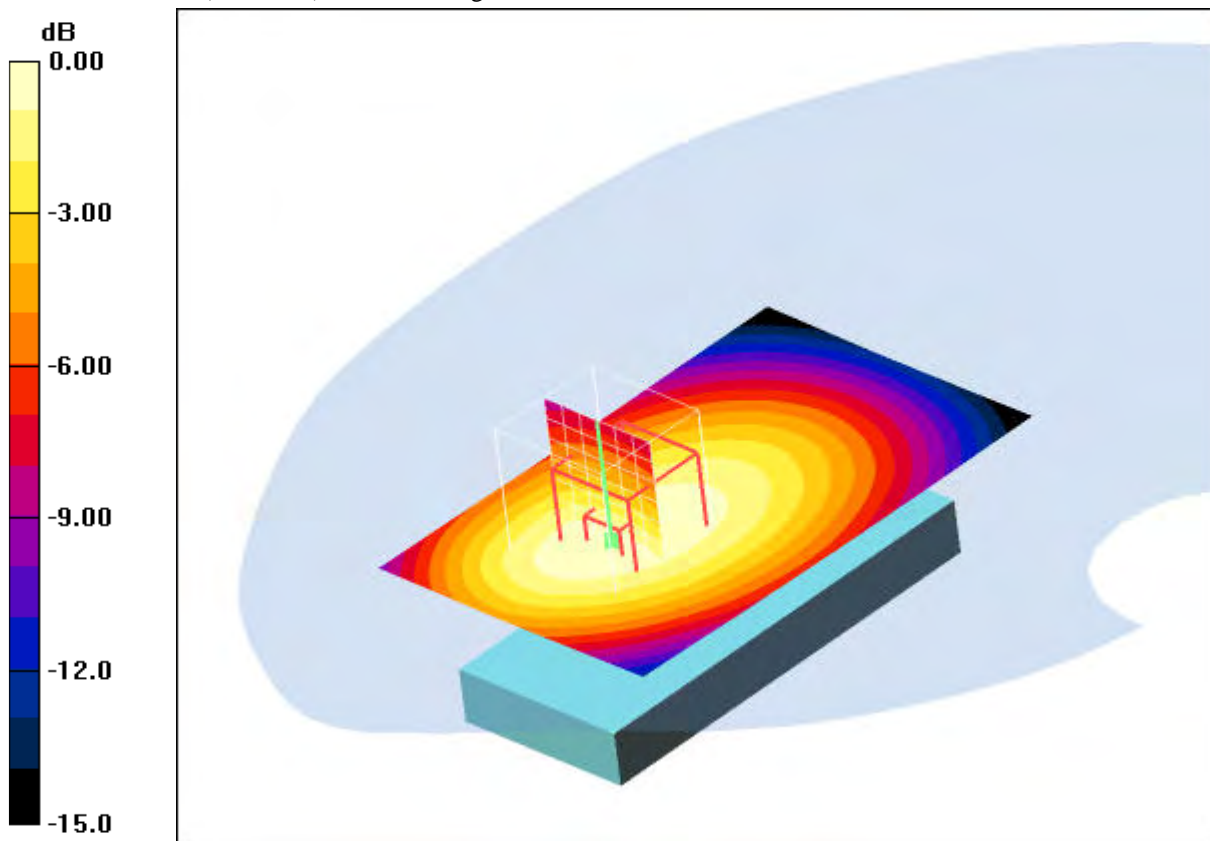

0 dB = 0.718mW/g

**Additional information:**

position or distance of DUT to SAM : 15 mm

ambient temperature: 22.8°C; liquid temperature: 21.6°C

Date/Time: 2009-04-02 18:03:11 Date/Time: 2009-04-02 18:09:07

**P1528\_OET65-Body-UMTS-FDD-V**

**DUT: Sony Ericsson; Type: AAD-3880008-BV; Serial: T261F007CD**

Communication System: WCDMA FDD V; Frequency: 846.6 MHz; Duty Cycle: 1:1

Medium: M850 Medium parameters used (interpolated):  $f = 846.6 \text{ MHz}$ ;  $\sigma = 0.99 \text{ mho/m}$ ;  $\epsilon_r = 54.3$ ;  $\rho = 1000 \text{ kg/m}^3$

Phantom section: Flat Section

DASY4 Configuration:

- Probe: ET3DV6 - SN1558; ConvF(5.96, 5.96, 5.96); Calibrated: 2008-08-15
- Sensor-Surface: 4mm (Mechanical And Optical Surface Detection) Sensor-Surface: 4mm (Mechanical Surface Detection)
- Electronics: DAE3 Sn413; Calibrated: 2009-01-08
- Phantom: SAM 12; Type: SAM; Serial: 1043
- Measurement SW: DASY4, V4.5 Build 19; Postprocessing SW: SEMCAD, V1.8 Build 146

**Rear position - High/Area Scan (51x81x1):** Measurement grid:  $dx=15\text{mm}$ ,  $dy=15\text{mm}$

Maximum value of SAR (interpolated) = 0.672 mW/g

**Rear position - High/Zoom Scan (7x7x7) (7x7x7)/Cube 0:** Measurement grid:  $dx=5\text{mm}$ ,  $dy=5\text{mm}$ ,  $dz=5\text{mm}$

Reference Value = 26.5 V/m; Power Drift = 0.017 dB

Peak SAR (extrapolated) = 0.802 W/kg

**SAR(1 g) = 0.617 mW/g; SAR(10 g) = 0.445 mW/g**

Maximum value of SAR (measured) = 0.655 mW/g

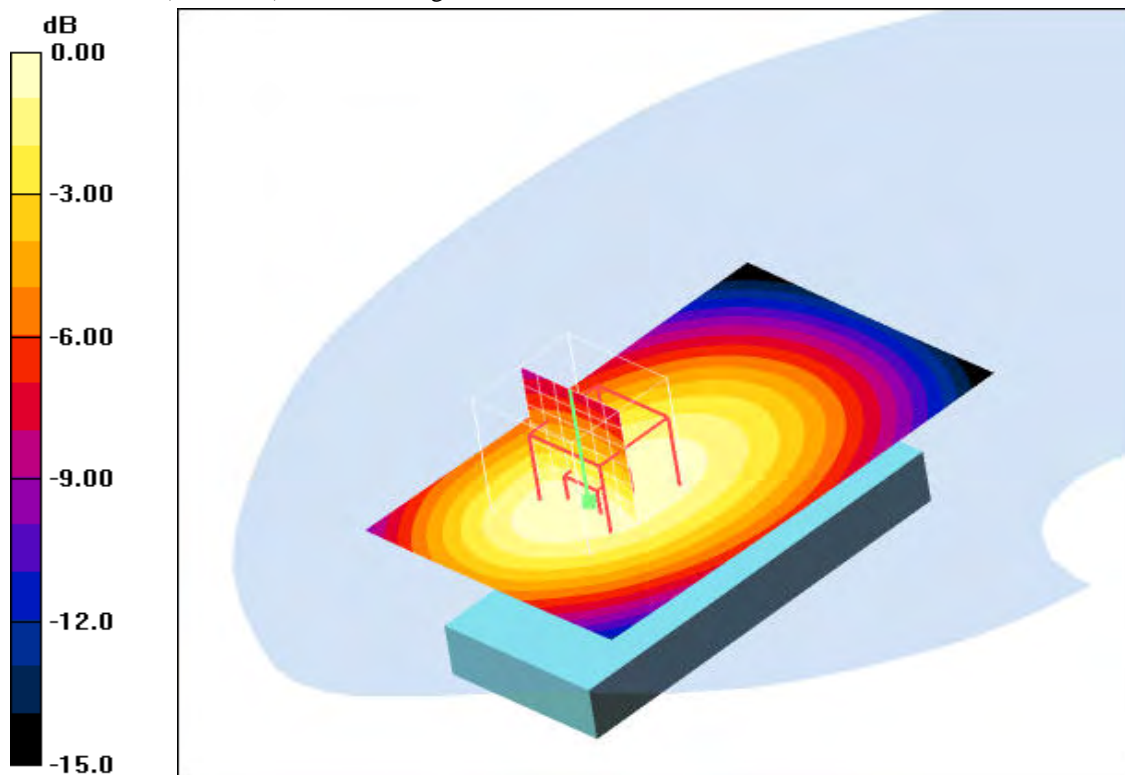

0 dB = 0.655mW/g

**Additional information:**

position or distance of DUT to SAM : 15 mm

ambient temperature: 22.8°C; liquid temperature: 21.6°C

**Annex 2.9 Z-axis scans**

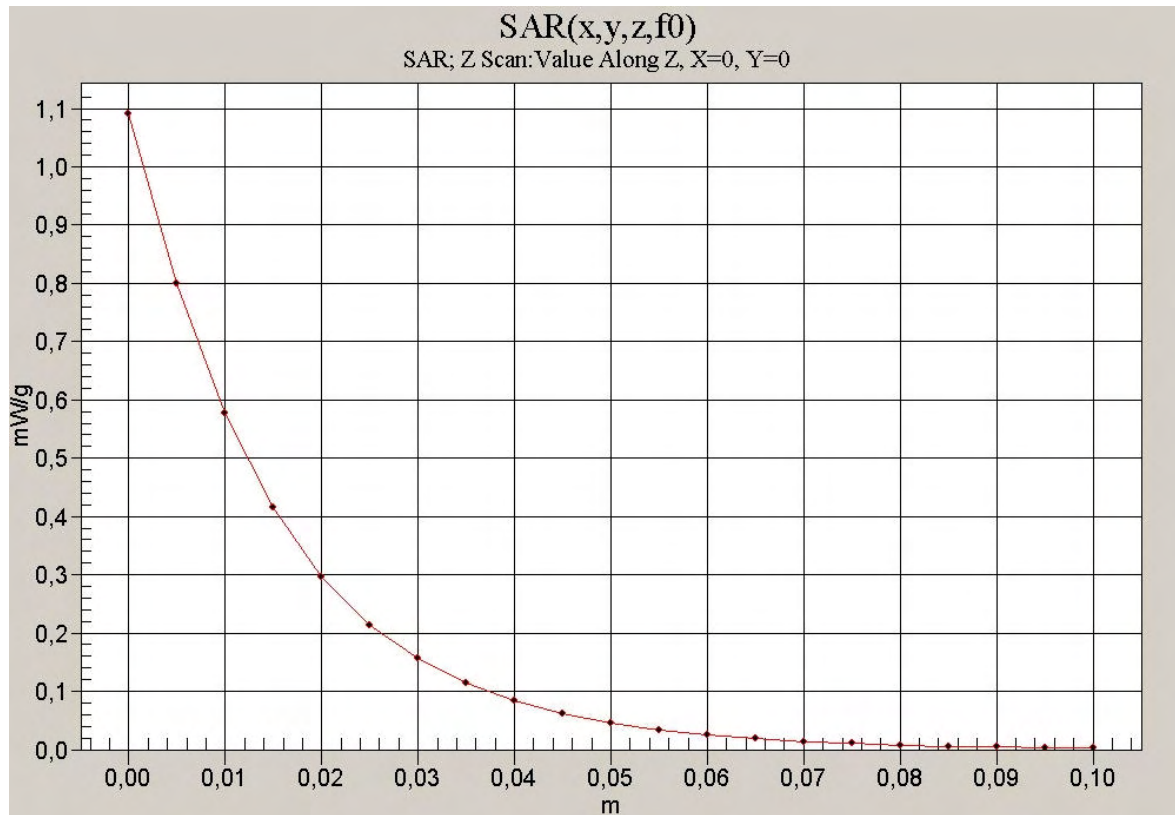

850 head

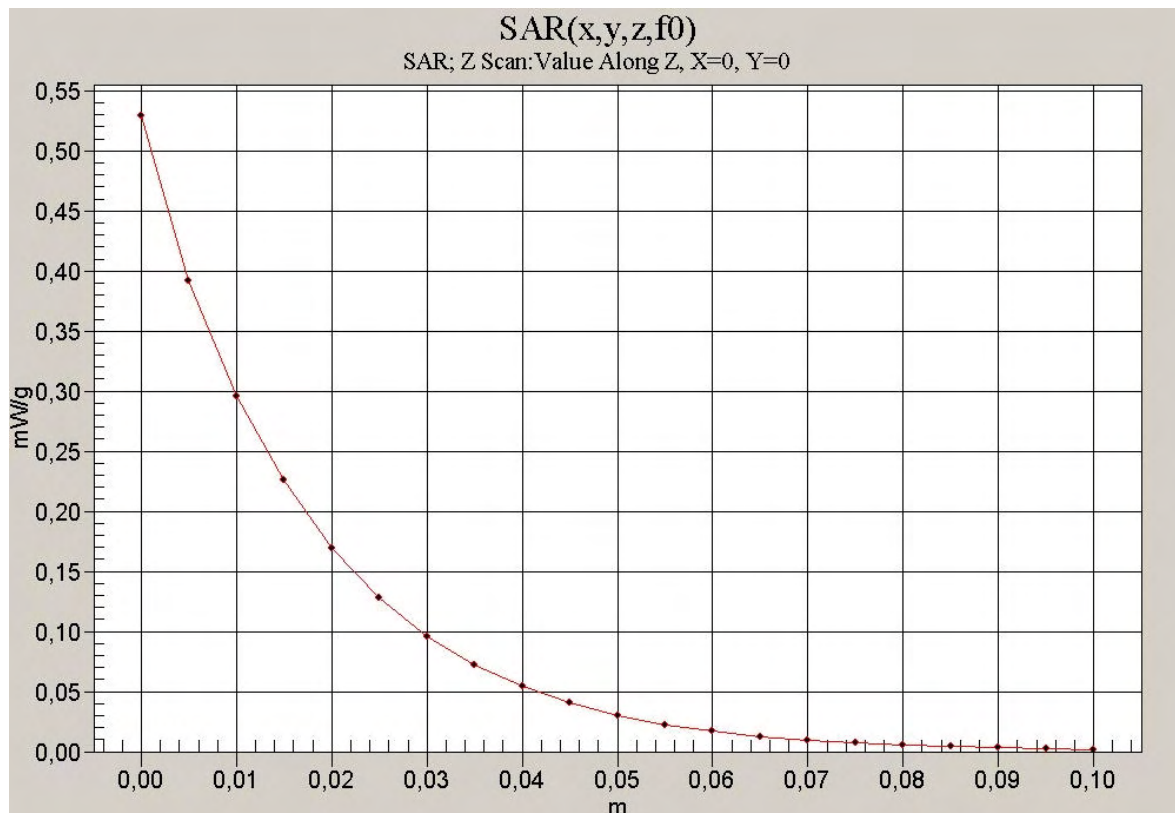

850 body

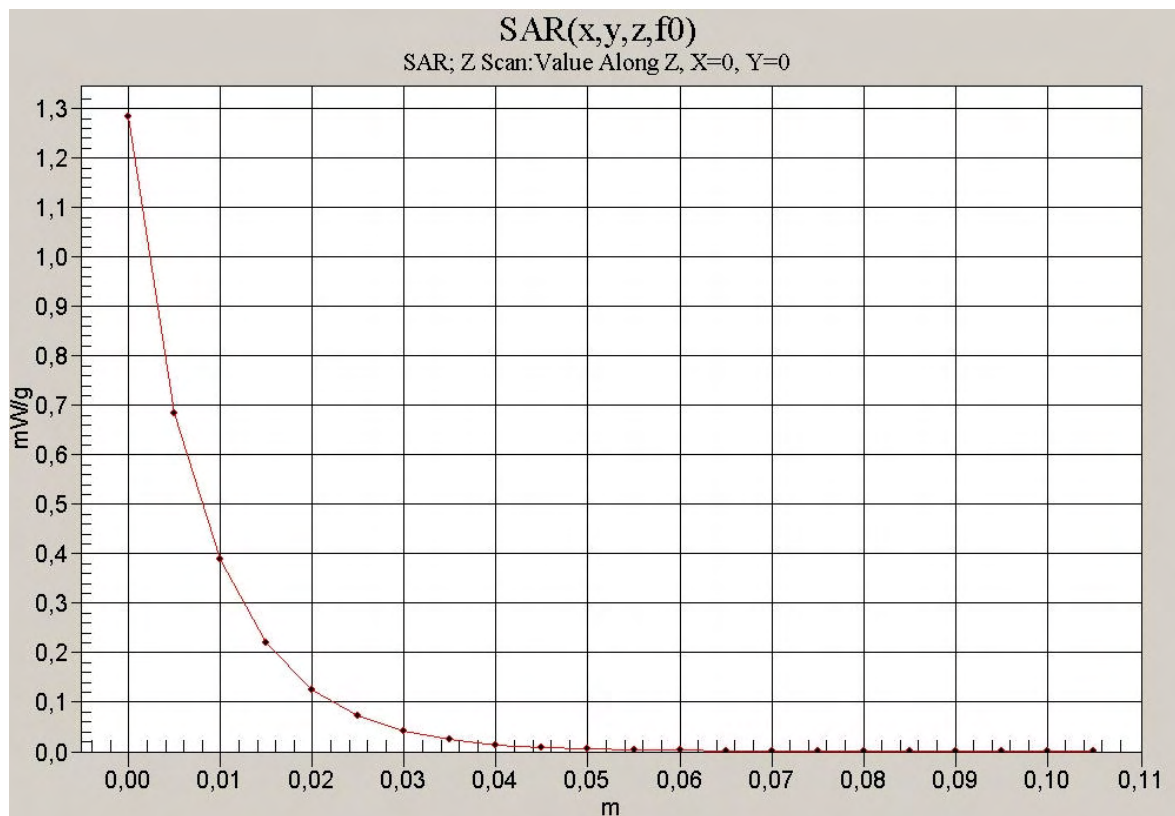

1900 head

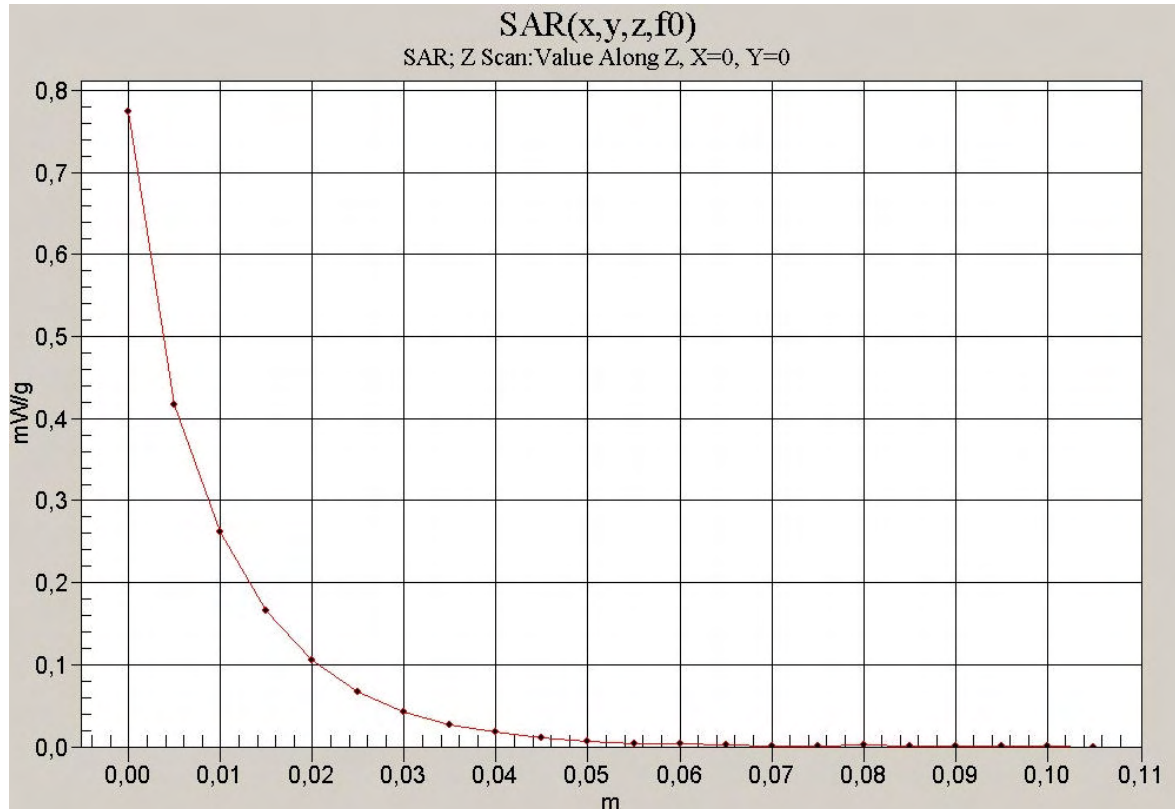

1900 body

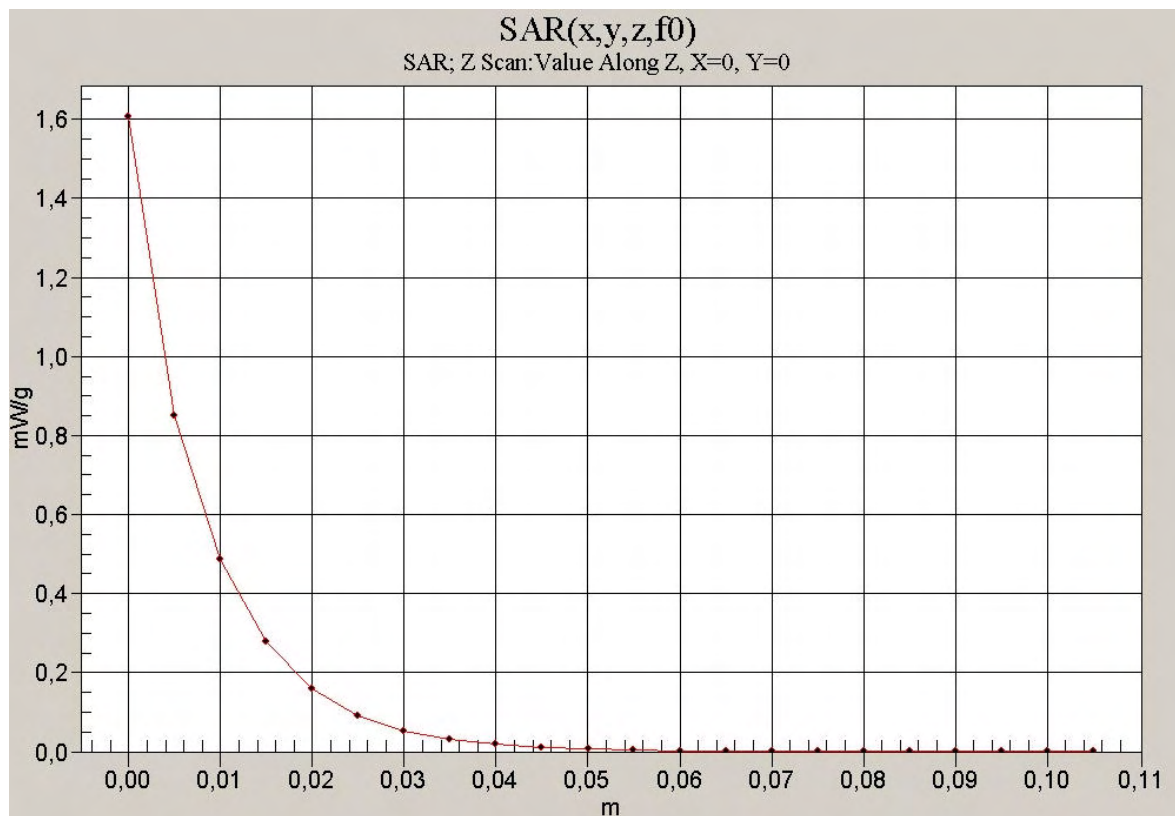

WCDMA FDD II 1900 head

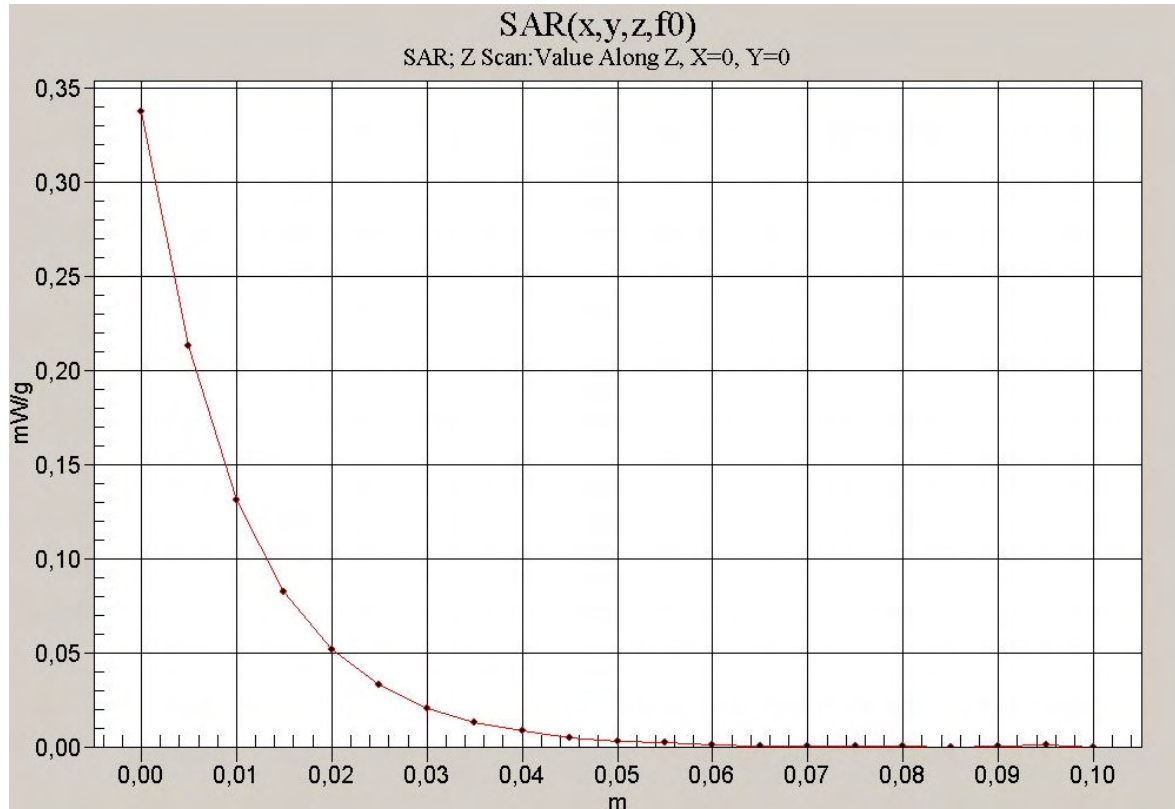

WCDMA FDD II 1900 body

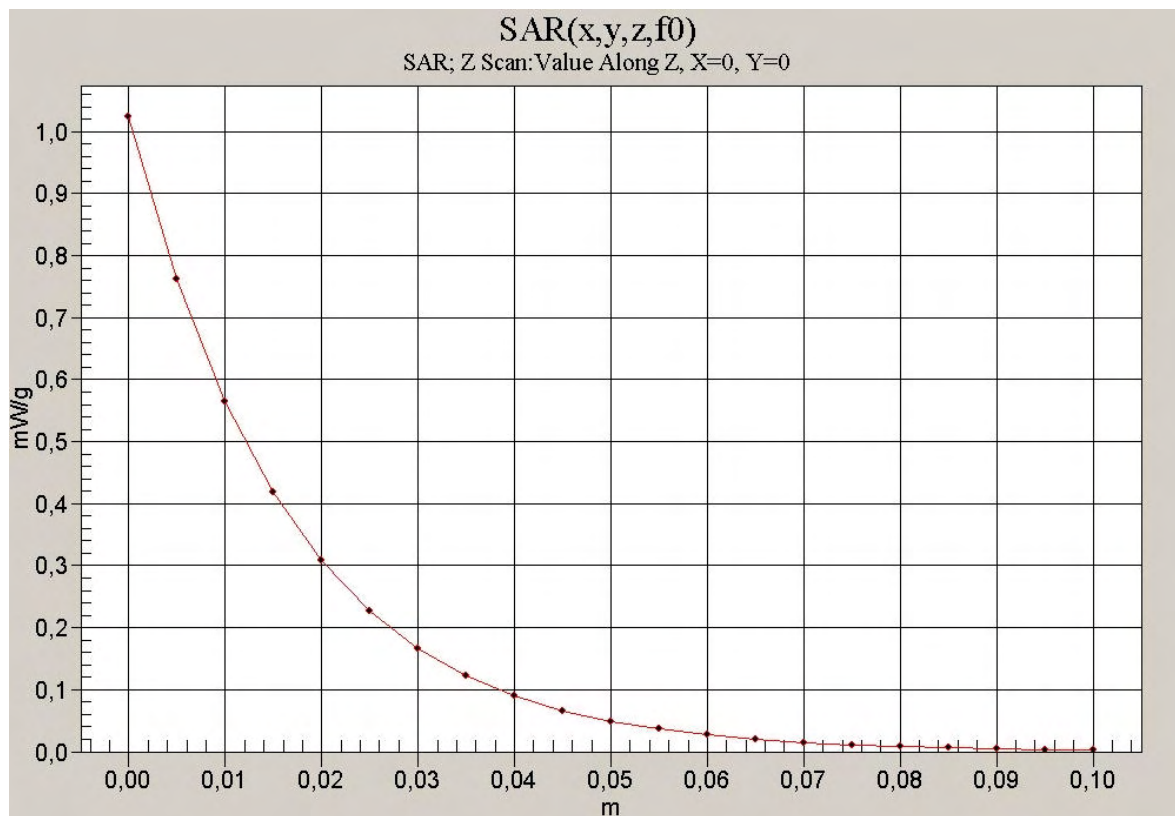

WCDMA FDD V 850 head

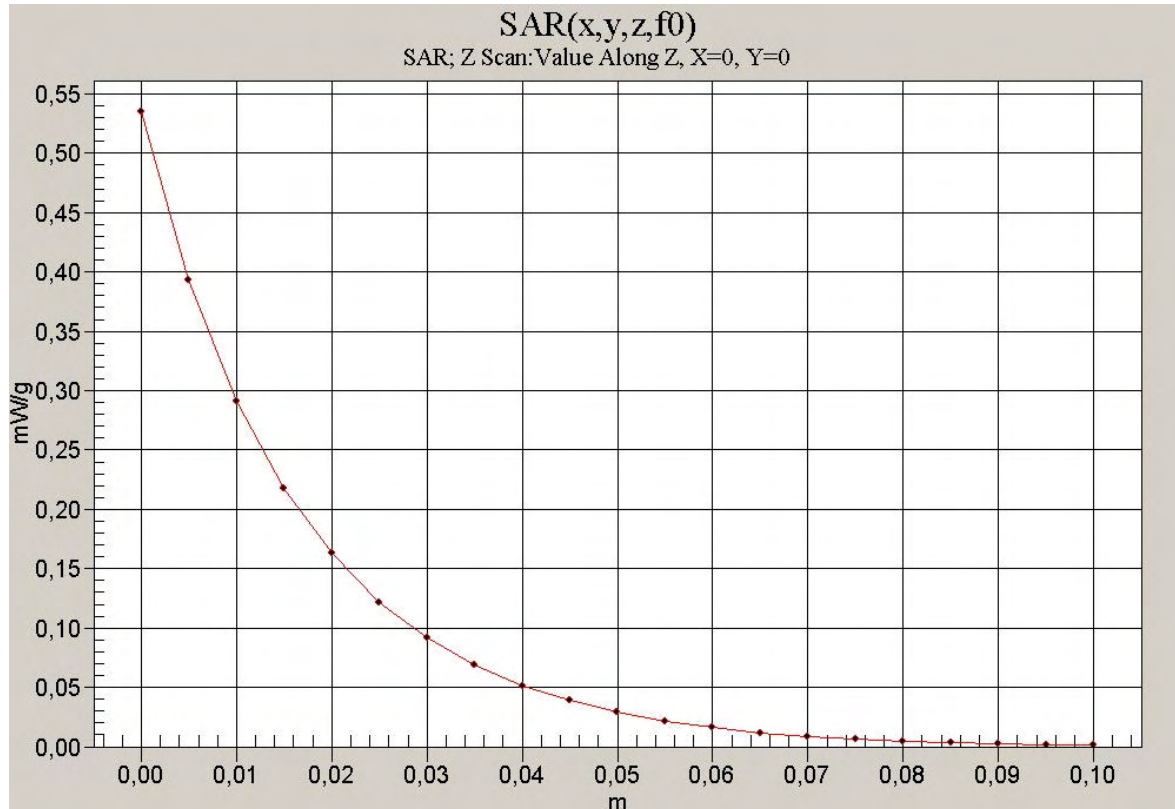

WCDMA FDD V 850 body

**Annex 3 Photo documentation**

Photo 1: Measurement System DASY 4



Photo 2: DUT - front view





Photo 3: DUT - rear view



Photo 4: DUT - side view



Photo 5: DUT - rear view (open)



Photo 6: DUT - rear view (open) without battery



Photo 7: The battery



Photo 8: The label



Photo 9: Test position left hand touched

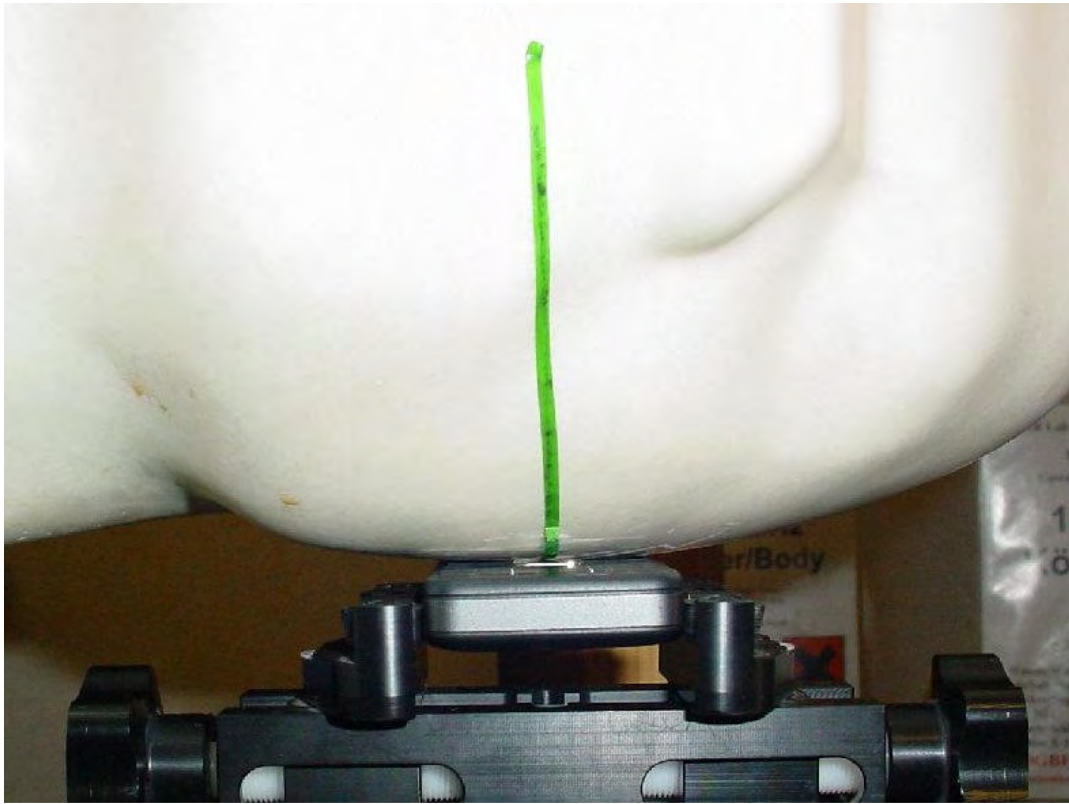

Photo 10: Test position left hand touched



Photo 11: Test position left hand touched



Photo 12: Test position left hand tilted 15°

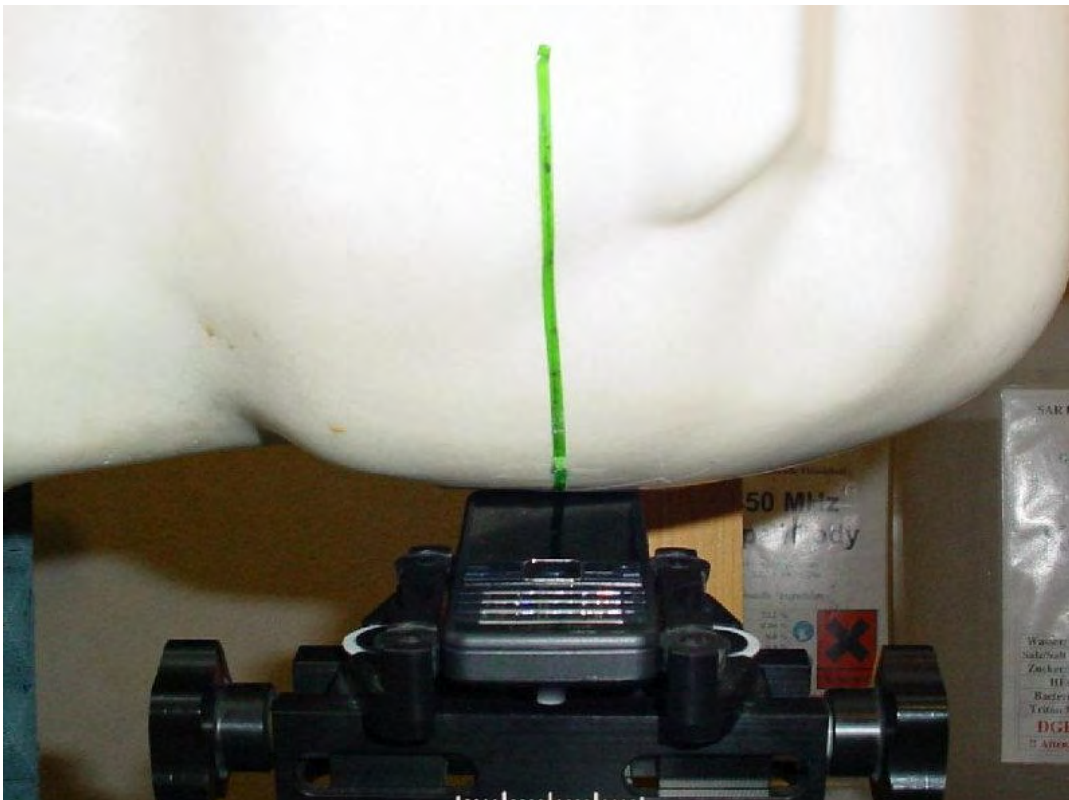

Photo 13: Test position left hand tilted 15°



Photo 14: Test position right hand touched

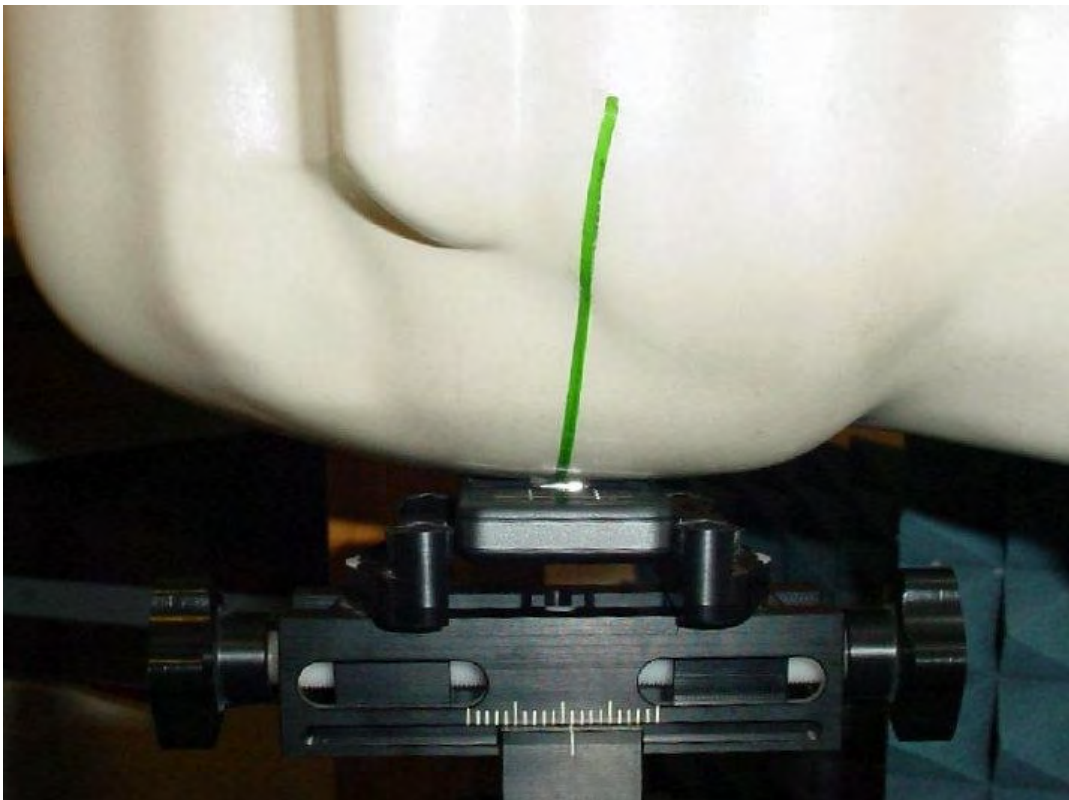

Photo 15: Test position right hand touched

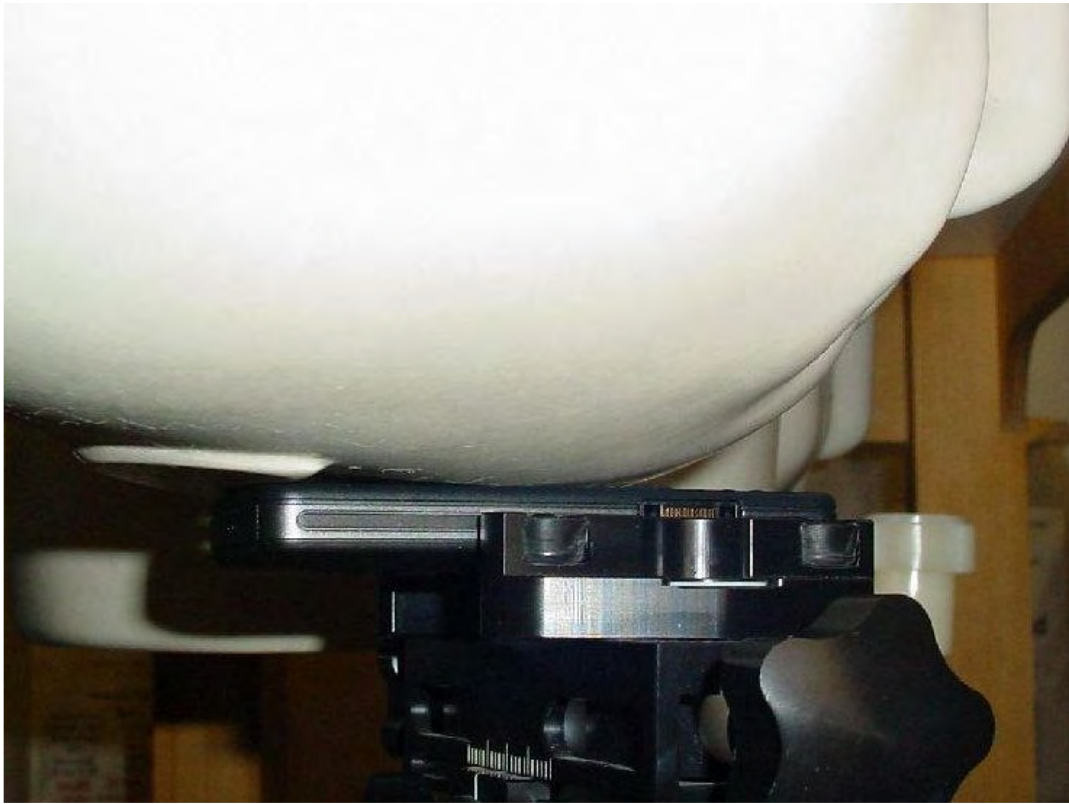

Photo 16: Test position right hand touched



Photo 17: Test position right hand tilted 15°

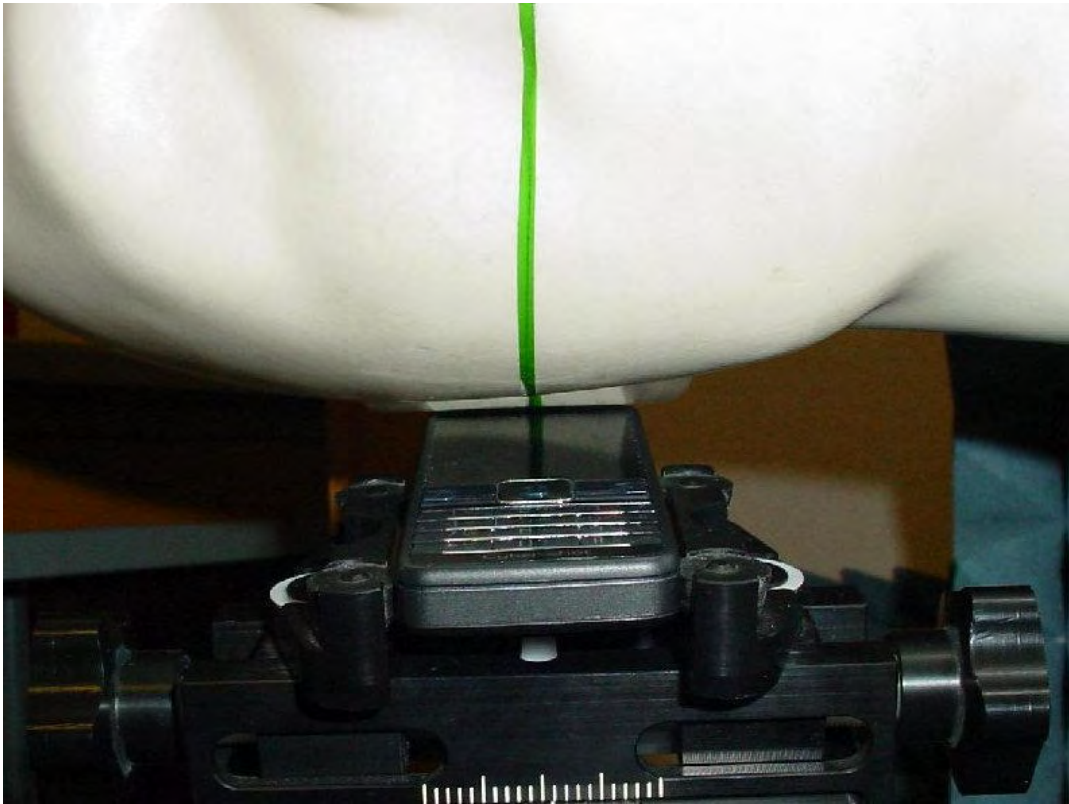

Photo 18: Test position right hand tilted 15°





Photo 19: Test position body worn front side with 15 mm distance



Photo 20: Test position body worn front side with 15 mm distance



Photo 21: Test position body worn rear side with 15 mm distance



Photo 22: Test position body worn rear side with 15 mm distance



**Annex 3.1 Liquid depth**

Photo 23: Liquid depth 850 MHz head simulating liquid



Photo 24: Liquid depth 850 MHz body simulating liquid



Photo 25: Liquid depth 1900 MHz head simulating liquid

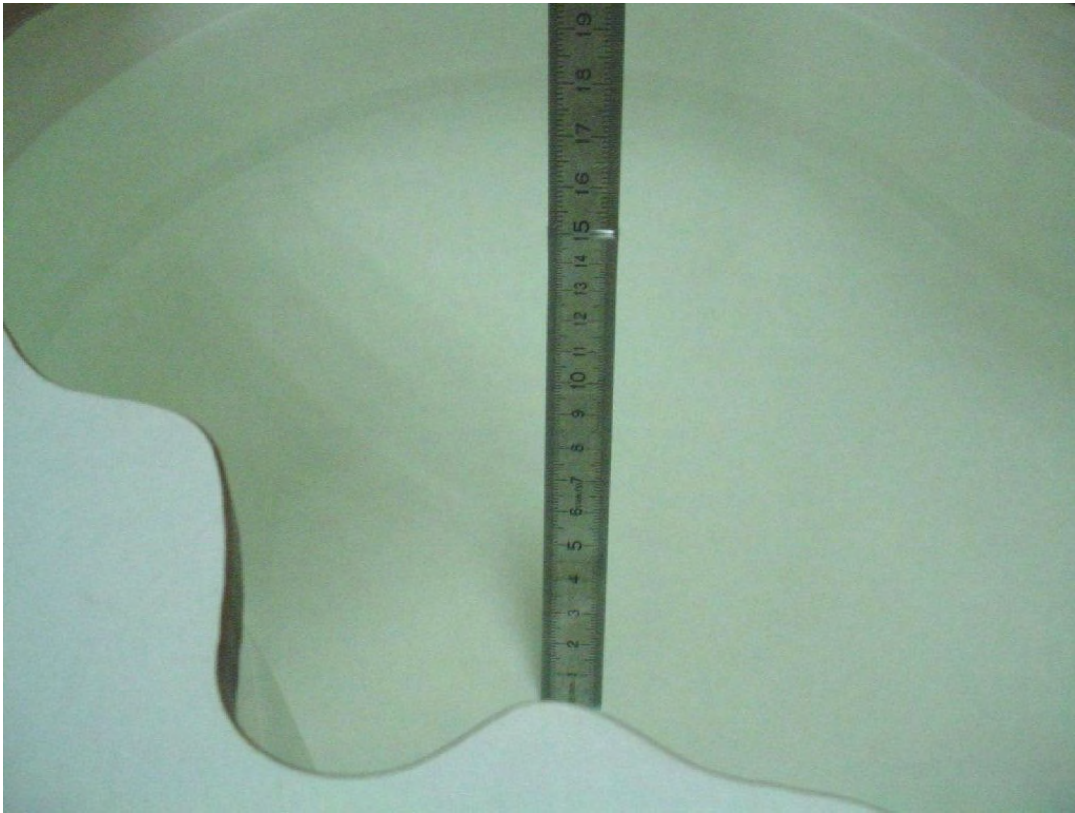
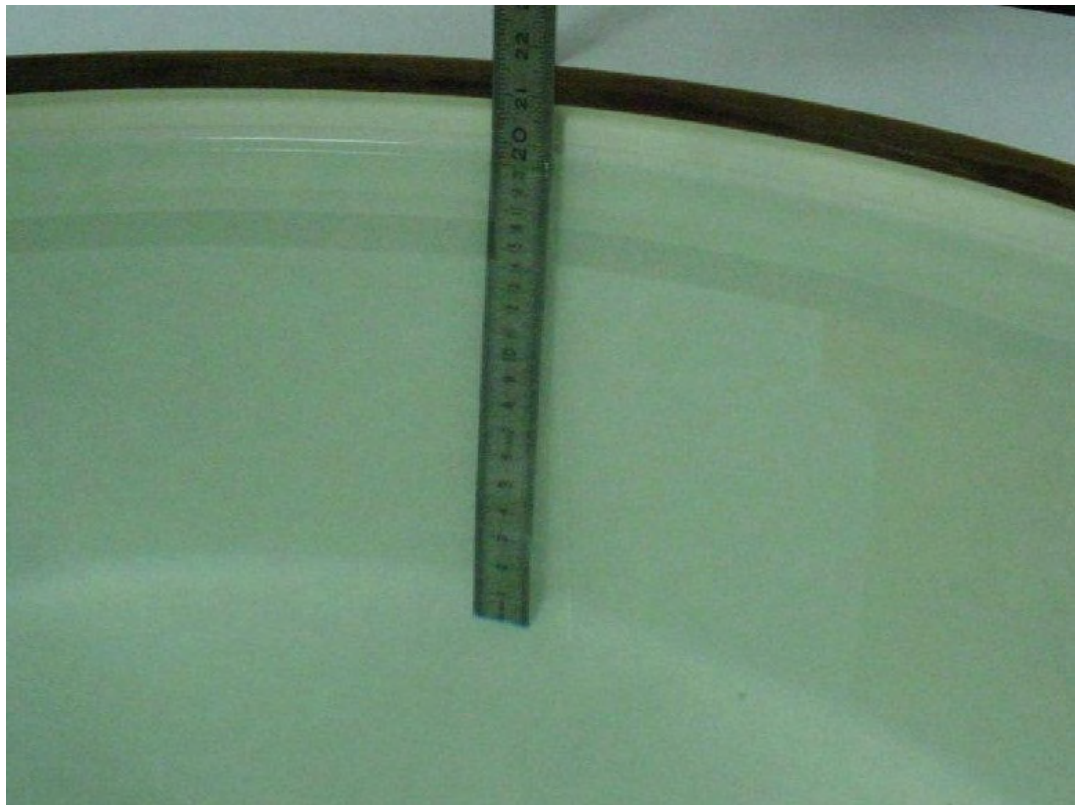

Photo 26: Liquid depth 1900 MHz body simulating liquid



**Annex 4 RF Technical Brief Cover Sheet acc. to RSS-102**

**1. COMPANY NUMBER: 4170B**

**2. MODEL NUMBER: A3880008**

**3. MANUFACTURER: Sony Ericsson Mobile Communications AB**

**4. TYPE OF EVALUATION:**

**(a) SAR Evaluation: Device used in the Vicinity of the Human Head**

- **Multiple transmitters:** Yes  No
- **Evaluated against exposure limits:** General Public Use  Controlled Use
- **Duty cycle used in evaluation:** 12.5 %
- **Standard used for evaluation:** RSS-102 Issue 2 (2005-11)
- **SAR value:** 1.450 W/kg. Measured  Computed  Calculated

**(b) SAR Evaluation: Body-worn Device**

- **Multiple transmitters:** Yes  No
- **Evaluated against exposure limits:** General Public Use  Controlled Use
- **Duty cycle used in evaluation:** 25 %
- **Standard used for evaluation:** RSS-102 Issue 2 (2005-11)
- **SAR value:** 0.991 W/kg. Measured  Computed  Calculated

**Annex 4.1 Declaration of RF Exposure Compliance**

**ATTESTATION:** I attest that the information provided in Annex 4 is correct; that a Technical Brief was prepared and the information it contains is correct; that the device evaluation was performed or supervised by me; that applicable measurement methods and evaluation methodologies have been followed and that the device meets the SAR and/or RF exposure limits of RSS-102.

**Signature:** 

**Date:** 2009-04-07

**NAME :** Thomas Vogler

**TITLE :** Dipl.-Ing. (FH)

**COMPANY :** CETECOM ICT Services GmbH

## **Annex 5 Calibration parameters**

**Calibration parameters are described in the additional document :**

**Appendix to test report no. 1-1065-14-05/09‘  
Calibration data, Phantom certificate  
and detail information of the DASY4 System**