

Contents

Getting Started	5	Vicemail	24
Assembly	5	Forwarding Calls	26
Turning on the Phone	5	More than One Call	27
Making and Receiving Calls	6	Conference Calls	28
Help in your Phone	6	My Numbers	28
Charging the Battery	7	Accept Calls	28
Desk Stand CDS-65	8	Restricted Dialing	29
Phone Overview	10	Fixed Dialing	29
Menu Overview	12	Call Time and Cost	30
Navigation	14	Business Cards	30
Shortcuts	15	Messaging	31
Activity Menu	16	Text Messages	31
File Manager	16	Picture Messages	32
Phone Language	18	Templates	34
Entering Text	18	Voice Messages	35
Calling	19	Email	35
Making and Receiving Calls	19	My Friends	37
Emergency Calls	20	Area and Cell Information	39
Video Call	21	Imaging	39
Contacts	21	Camera and Video Recorder	39
Synchronizing Contacts	23	Transferring Pictures	41
Groups	23	Pictures and Video Clips	42
Call List	24	PhotoDJ™ and VideoDJ™	43
Speed Dial	24	Themes	43

Entertainment	44	Locks	65
Stereo Portable Handsfree	44	IMEI Number	66
Music and Video Players	44	Troubleshooting	67
Radio	47	Common Questions	67
PlayNow™	48	Error Messages	68
MusicDJ™	49	Important Information	70
Games	50	Guidelines for Safe	
Applications	51	and Efficient Use	72
Connectivity	52	Limited Warranty	76
Settings	52	FCC Statement	78
Using Internet	52	Declaration of Conformity	79
RSS Reader	54	Index	80
Synchronizing	54		
Bluetooth™ Wireless			
Technology	55		
Update Service	59		
More Features	60		
Alarms	60		
Calendar	60		
Tasks	62		
Notes	62		
Timer, Stopwatch			
and Calculator	63		
Code Memo	63		
Profiles	64		
Time and Date	65		

Sony Ericsson T650i

UMTS 2100 GSM 900/1800/1900

This User guide is published by Sony Ericsson Mobile Communications AB or its local affiliated company, without any warranty. Improvements and changes to this User guide necessitated by typographical errors, inaccuracies of current information, or improvements to programs and/or equipment, may be made by Sony Ericsson Mobile Communications AB at any time and without notice. Such changes will, however, be incorporated into new editions of this User guide.

All rights reserved.

©Sony Ericsson Mobile Communications AB, 2007

Publication number: 1201-7641.1

Please note:

Some of the services in this User guide are not supported by all networks. *This also applies to the GSM International Emergency Number 112.*

Please contact your network operator or service provider if you are in doubt whether you can use a particular service or not.

Please read the *Guidelines for safe and efficient use* and the *Limited warranty* chapters before you use your cell phone.

Your cell phone has the capability to download, store and forward additional content, e.g. ringtones. The use of such content may be restricted or prohibited by rights of third parties, including but not limited to restriction under applicable copyright laws. You, and not Sony Ericsson, are entirely responsible for additional content that you download to or forward from your cell phone. Prior to your use of any additional content, please verify that your intended use is properly licensed or is otherwise authorized. Sony Ericsson does not guarantee the accuracy, integrity or quality of any additional content or any other third party content. Under no circumstances will Sony Ericsson be liable in any

way for your improper use of additional content or other third party content.

Bluetooth™ is a trademark or registered trademark of Bluetooth SIG Inc.

The liquid identity logo, PlayNow, MusicDJ, PhotoDJ and VideoDJ are trademarks or registered trademarks of Sony Ericsson Mobile Communications AB.

Sony, Memory Stick Micro™ and M2™ are trademarks of Sony Corporation.

Ericsson is a trademark or registered trademark of Telefonaktiebolaget LM Ericsson.

Adobe® Photoshop® Album Starter Edition is a trademark or registered trademark of Adobe Systems Incorporated in the United States and/or other countries.

Microsoft, Windows, PowerPoint, Outlook and Vista are trademarks or registered trademarks of Microsoft Corporation in the US and other countries.

T9™ Text Input is a trademark or a registered trademark of Tegic Communications. T9™

Text Input is licensed under one or more of the following: U.S. Pat. Nos. 5,818,437, 5,953,541, 5,187,480, 5,945,928, and 6,011,554; Canadian Pat. No. 1,331,057, United Kingdom Pat. No. 2238414B; Hong Kong Standard Pat. No. HK0940329; Republic of Singapore Pat. No. 51383; Euro.Pat. No. 0 842 463 (96927260.8) DE/DK, FI, FR, IT, NL, PT, ES, SE, GB; and additional patents are pending worldwide.

Java and all Java based trademarks and logos are trademarks or registered trademarks of Sun Microsystems, Inc. in the U.S. and other countries.

End-user license agreement for Sun™ Java™ J2ME™.

Restrictions: Software is confidential copyrighted information of Sun and title to all copies is retained by Sun and/or its licensors. Customer shall not modify, decompile, disassemble, decrypt, extract, or otherwise reverse engineer Software. Software

may not be leased, assigned, or sublicensed, in whole or in part.

Export Regulations: Software, including technical data, is subject to U.S. export control laws, including the U.S. Export Administration Act and its associated regulations, and may be subject to export or import regulations in other countries. Customer agrees to comply strictly with all such regulations and acknowledges that it has the responsibility to obtain licenses to export, re-export, or import Software. Software may not be downloaded, or otherwise exported or re-exported (i) into, or to a national or resident of, Cuba, Iraq, Iran, North Korea, Libya, Sudan, Syria (as such listing may be revised from time to time) or any country to which the U.S. has embargoed goods; or (ii) to anyone on the U.S. Treasury Department's list of Specially Designated Nations or the U.S. Commerce Department's Table of Denial Orders.

Restricted Rights: Use, duplication or disclosure by the United States government is subject to the restrictions as set forth in the Rights in Technical Data and Computer Software Clauses in DFARS 252.227-7013(c) (1) (ii) and FAR 52.227-19(c) (2) as applicable.

Other product and company names mentioned herein may be the trademarks of their respective owners. Any rights not expressly granted herein are reserved. All illustrations are for illustration only and may not accurately depict the actual phone.

Instruction Symbols

The following appear in the User guide.

 Note

 Tip

 Warning

 A service or function is network- or subscription-dependent. Contact your network operator for details.

> Use a selection or navigation key to scroll and select. See *Navigation* on page 14.

 Press the navigation key center.

 Press the navigation key up.

 Press the navigation key down.

 Press the navigation key left.

 Press the navigation key right.

Getting Started

Assembly

Before you start using your phone, you need to insert a SIM card and the battery.

To insert the SIM card and battery

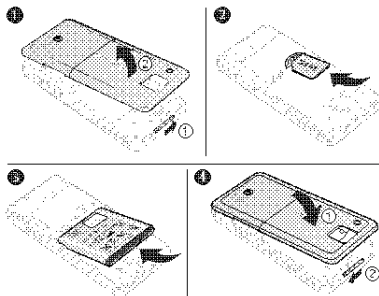

- 1 Slide and hold the clasp sideways and remove the battery cover.
- 2 Slide the SIM card into its holder with the contacts facing down.
- 3 Insert the battery with the label side up and the connectors facing each other.
- 4 Replace the battery cover.

Turning on the Phone

To turn on the phone

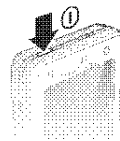

- 1 Press and hold down ①.
- 2 Select a mode:
 - Normal Mode – full functionality.
 - Flight Mode – limited functionality with network, FM radio, Bluetooth™ transceivers off.
- 3 Enter your SIM card PIN, if requested.
- 4 Select a language.
- 5 Select Yes to use the setup wizard.

! If you make a mistake when you enter your PIN, you can press ⑤ to delete numbers from the screen.

SIM card

The SIM (Subscriber Identity Module) card, which you get from your network operator, contains information about your subscription. Always turn off your phone and detach the charger before you insert or remove the SIM card.

- You can save contacts on the SIM card before you remove it from your phone. See *To copy names and numbers to the SIM card on page 22.*

PIN

You may need a PIN (Personal Identification Number) to activate the services in your phone. Your PIN is supplied by your network operator. Each PIN digit appears as *, unless it starts with emergency number digits, for example, 112 or 911. You can see and call an emergency number without entering a PIN.

To delete numbers from the display

- Press .

- If you enter the wrong PIN three times in a row, PIN Blocked appears. To unblock it, you need to enter your PUK (Personal Unblocking Key). See *SIM card lock on page 65.*

Flight mode

In Flight Mode the network, radio and Bluetooth transceivers are turned off to prevent disturbance to sensitive equipment.

Startup screen

The startup screen appears when you turn your phone on. See *Using pictures on page 42.*

Standby

After you have turned your phone on and entered your PIN, the name of the network operator appears on the screen. This is called standby.

Making and Receiving Calls

You must turn on your phone and be within range of a network.

To make a call

- 1 From standby enter a phone number (with international country code and area code, if applicable).
- 2 Select Call.

To answer a call

- Select Answer.

To reject a call

- Select Busy.

Help in your Phone

Help and information is available in your phone at any time.



To use the setup wizard

- 1 From standby select Menu > Settings > the General tab > Setup Wizard.
- 2 Select an option.
See *Navigation* on page 14.

To view information about functions

- Scroll to a function and select More > Info, if available.

To view the phone demonstration

- From standby select Menu > Entertainment > Demo Tour.

Settings download

You can download settings to your phone. These settings let you use functionality that require Internet accounts, for example, picture messaging and email.

To download settings

- From standby select Menu > Settings > the General tab > Setup Wizard > Settings Download.
- **Contact your network operator or service provider for more information.**

Charging the Battery

The phone battery is partly charged when you buy it.

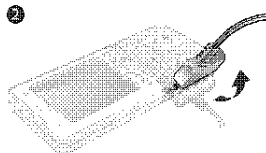
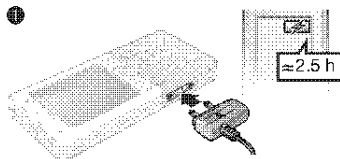
To charge the battery

- 1 Connect the charger to the phone. It takes approximately 2.5 hours to fully charge the battery. Press a key to view the screen.
- 2 Remove the charger by tilting the plug upwards.

You can use your phone while it is charging. You can charge the battery at any time and for more or less 2.5 hours. You can interrupt the charging without damaging the battery.

Desk Stand CDS-65

Your phone's best assistant: connect a USB cable, charger and portable handsfree.

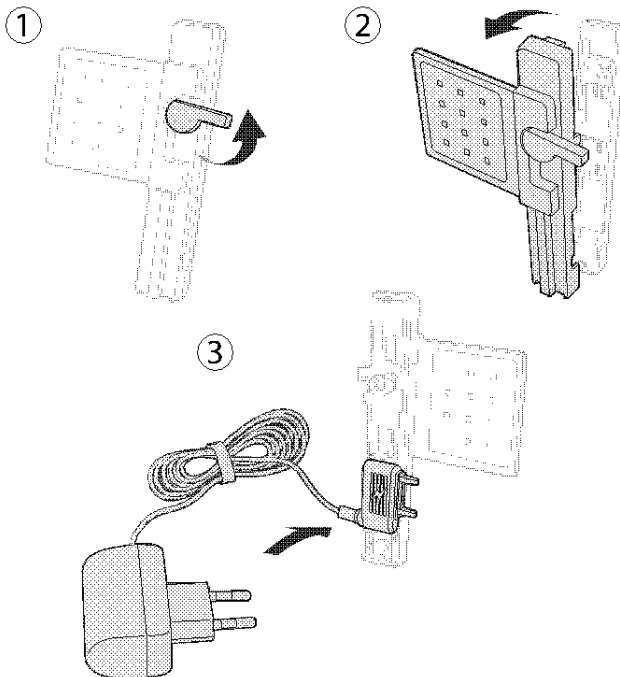

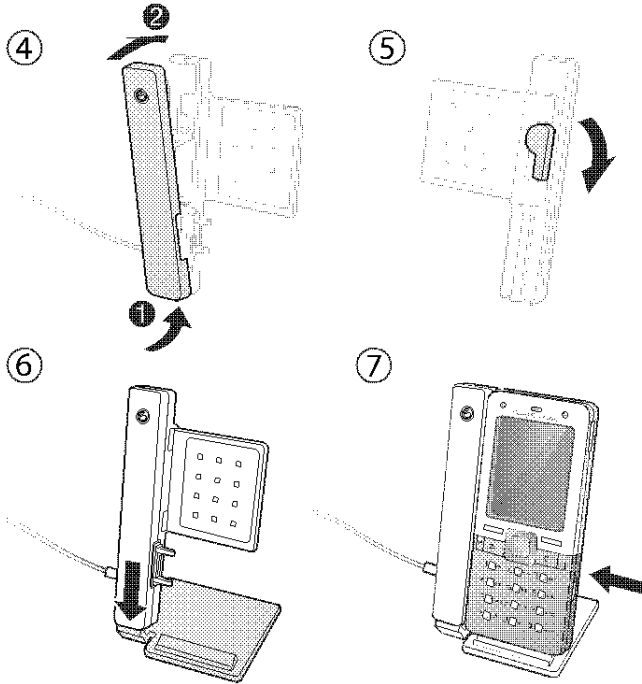

Phone Overview

- 1 Power on/off key
- 2 Screen
- 3 Navigation key, music player control
- 4 Selection key
- 5 Back key
- 6 Internet key
- 7 Keypad lock
- 8 Volume, camera digital zoom buttons
- 9 Selection key
- 10 Activity menu key
- 11 Clear key
- 12 Camera key
- 13 Silent key

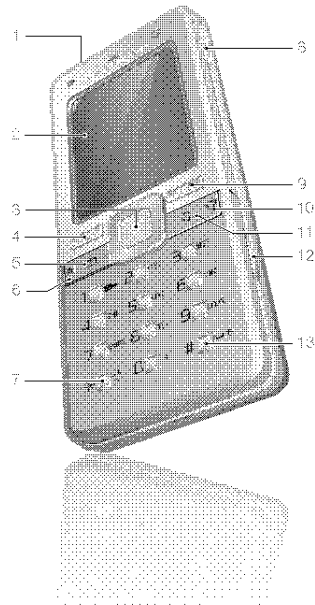

10 Getting Started

- 14 Light
- 15 Main camera
- 16 Connector for charger, handsfree and USB cable
- 17 Speaker

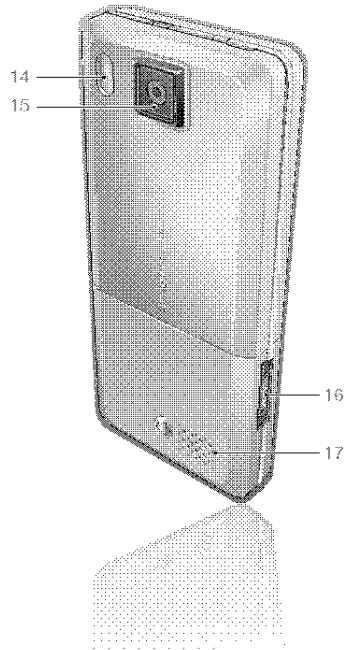

Menu Overview



PlayNow™*



Internet*



Entertainment

- Online Services*
- Radio
- Games
- Video Player
- VideoDJ™
- PhotoDJ™
- MusicDJ™
- Remote Control
- Record Sound
- Demo Tour



Camera



Messaging

- Write New
- Inbox
- Email
- RSS Reader
- Drafts
- Outbox
- Sent Messages
- Saved Messages
- My Friends*
- Call Voicemail
- Templates
- Settings



Music Player

- Now Playing
- Artists
- Tracks
- Playlists



File Manager**

- Camera Album
- Music
- Pictures
- Videos
- Themes
- Web Pages
- Games
- Applications
- Other



Contacts

- New Contact



Alarms

12 Getting Started





Calls**



All



Answered



Dialed



Missed



Organizer

- Applications
- Video Call
- Calendar
- Tasks
- Notes
- Synchronization
- Timer
- Stopwatch
- Light
- Calculator
- Code Memo



Settings**



- General
- Profiles
- Time & Date
- Language
- Update Service
- Voice Control
- New Events
- Shortcuts
- Flight Mode
- Security
- Setup Wizard
- Phone Status
- Master Reset



- Sounds & Alerts
- Ring Volume
- Ringtone
- Silent Mode
- Increasing Ring
- Vibrating Alert
- Message Alert
- Key Sound



- Display
- Wallpaper
- Themes
- Startup Screen
- Screen Saver
- Clock Size
- Brightness
- Edit Line Names*



- Calls
- Speed Dial
- Forward Calls
- Manage Calls
- Time & Cost*
- Show/Hide My No.
- Handsfree
- Switch to Line 2*



- Connectivity*
- Bluetooth
- USB
- Synchronization
- Device Mgmt.
- Mobile Networks
- Data Comm.
- Internet Settings
- Streaming Settings
- Accessories

* Some menus are operator-, network- and subscription-dependent.

** You can use the navigation key to scroll between tabs in submenus. For more information, see Navigation on page 14.



Navigation

The main menus are shown as icons.
Some submenus include tabs.

To navigate the phone menus



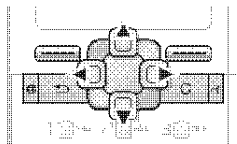









- 1 From standby select Menu.
- 2 Use the navigation key to move through the menus.





To scroll between the tabs

- Scroll to a tab by pressing the navigation key left or right.

Key

	Go to the main menus or to select items
   	Scroll between the menus and tabs
	Select options shown immediately above these keys on the screen
	Go back one level in the menus. Press and hold down to return to standby or to end a function
	Delete items, such as pictures, sounds and contacts. Press and hold down to mute the microphone during a call
	Open the browser
	Open the activity menu
	Press and hold down to take a picture or record a video clip
	Press and hold down to call your voicemail service (if set)

 -  Press and hold down a number key to reach a contact beginning with a specific letter.

  -  Press a number key and select Call... to speed dial.

 Press to turn off the ringtone when you receive a call. Press and hold down to set the phone to silent. The alarm signals even if your phone is set to silent.

 View status information in standby.
Increase the volume during a call, or when you use the music player. Press and hold down to go back one track when you use the music player.
Zoom out when you use the camera or view pictures.
Press twice to reject a call.
Voice control. See *Voice control* on page 25.

 Decrease the volume during a call, or when you use the music player. Press and hold down to go forward one track when you use the Music Player.
Zoom in when you use the camera or view pictures.
Voice control. See *Voice control* on page 25.





Shortcuts

You can use keypad shortcuts to go directly to a menu. Menu numbering starts from the top left icon and moves across and then down row by row.

To go directly to the seventh menu

- From standby select Menu and press .

To use navigation key shortcuts

- From standby press , ,  or  to go directly to a function.

To edit a navigation key shortcut

- From standby select Menu > Settings > the General tab > Shortcuts.
- Scroll to an option and select Edit.
- Scroll to a menu option and select Shortcut.

Activity Menu

The activity menu gives you fast access to certain functions.

To open the activity menu

- Press .

Activity menu tabs

- New Events – view missed calls and new messages. These can also be set to appear as pop-up texts.
- Running Apps – applications that are running in the background.
- My Shortcuts – add your favorite functions to access them quickly.
- Internet – your Internet bookmarks.

To select pop-up texts

- From standby select Menu > Settings > the General tab > New Events > Popup.

File Manager

You can use the file manager to handle items saved in the phone memory or on a memory card.

- You may have to purchase a memory card separately from your phone.

Memory Stick Micro™ (M2™)

Your phone supports Memory Stick Micro™ (M2™) memory card adding more storage space to your phone. It can also be used as a portable memory card with other compatible devices.

To insert a memory card

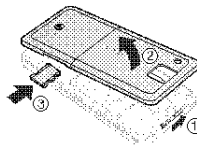

- 1 Remove the battery cover.
- 2 Insert the memory card with the golden contacts facing down.

To remove a memory card

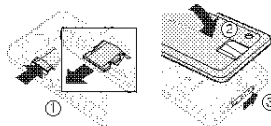

- 1 Press the edge to release and remove the memory card.
- 2 Replace the battery cover.

To view memory card options

- 1 From standby select Menu > File Manager > the On Memory Stick tab.
- 2 Select More.

Handling files

You can move and copy files between your phone, a computer and a memory card. Files are saved on the memory card first and then in the phone memory. Unrecognized files are saved in the Other folder.

You can create subfolders to move or copy files to. When you handle files, you can select more than one or all the files in a folder at the same time for all items except Games and Applications.

If the memory is full, delete some content to create space.

File manager tabs

The file manager is divided into three tabs, and icons indicate where the files are saved.

- All Files – all content in the phone memory and on a memory card.
- On Memory Stick – all content on a memory card.
- In Phone – all content in the phone memory.

To open a file in the file manager

- 1 From standby select Menu > File Manager.
- 2 Scroll to a folder and select Open.

To view information about files

- 1 From standby select Menu > File Manager.
- 2 Scroll to a file and select More > Information.

To move a file in the file manager

- 1 From standby select Menu > File Manager.
- 2 Scroll to a folder and select Open.
- 3 Scroll to a file and select More > Manage File > Move.
- 4 Select an option.

To select more than one file in a folder

- 1 From standby select Menu > File Manager.
- 2 Scroll to a folder and select Open.
- 3 Select More > Mark > Mark Several.
- 4 Select Mark to mark the files.

To delete a file from the file manager

- 1 From standby select Menu > File Manager.
- 2 Find the file and press .

Phone Language

You can select a language to use in your phone.

To change the phone language

- 1 From standby select Menu > Settings > the General tab > Language > Phone Language.
- 2 Select an option.

Entering Text

There are two methods you can use to enter text:

- Multitap text input
- T9™ Text Input.





To change text input methods





- When you enter letters, press and hold down .

To view options when you enter letters

- Select More.

To enter text using multitap









- From standby select Menu > Messaging > Write New > Text Message.
- Press  -  until the desired character appears.
- Press  to delete.
- Press  to shift between capitals and lower-case letters.

- Press and hold down  -  to enter numbers.
- Press  to add a space.
- Press  to enter periods and commas.
- Press  to enter the + sign.

T9™ Text Input

The T9™ Text Input method uses a built-in dictionary.

To enter text using T9™ Text Input

- 1 From standby select Menu > Messaging > Write New > Text Message.
- 2 Press each key only once, even if the letter you want is not the first letter on the key. For example, if you want to write the word “Jane”, press , , , . Write the whole word before looking at the suggestions.
- 3 Press  to delete.
- 4 Use  or  to view suggestions.
- 5 Press  to accept a suggestion.
- 6 Press  to enter periods and commas.

To add words to the built-in dictionary

- 1 When you enter letters, select More > Spell Word.
- 2 Write the word using multitap input and select Insert.

Next word prediction

When you write a message, you can use T9 Text Input to predict the next word, if previously used in a sentence.

To turn next word prediction on

- When you enter letters, select More > Writing Options > Next Word Pred. > On.

To use next word prediction

- When you enter letters, press  to accept or continue.

Calling

Making and Receiving Calls

You need to turn on your phone and be within range of a network.

To make a call

- 1 From standby enter a phone number (with international country code and area code, if applicable).
- 2 Select Call.
See *Video Call* on page 21.

 You can call numbers from the contacts and call list, see *Contacts* on page 21, and *Call List* on page 24. You can also use your voice to make calls. See *Voice Control* on page 25.

To make international calls

- 1 From standby press and hold down  until a “+” sign appears.
- 2 Enter the country code, area code (without the first zero) and phone number.
- 3 Select Call.

To redial a number

- When *Retry?* appears select Yes.

 Do not hold your phone to your ear when waiting. When the call connects, your phone gives a loud signal.

To answer a call

- Select Answer.



To reject a call

- Select Busy.

To change the ear speaker volume during a call

- Press  or .

To mute the microphone during a call

- 1 Press and hold down .
- 2 Press and hold down  again to resume.

To turn the loudspeaker on during a call

- Select More > Turn On Speaker.

 **Do not hold your phone to your ear when using the loudspeaker.**
This could damage your hearing.

To view missed calls from standby

- Press  and scroll to the New Events tab and select a number.
- If pop-up is set: select Calls and scroll to the Missed tab and select a number.

Networks

Your phone switches automatically between GSM and 3G (UMTS) networks depending on availability. Some network operators allow you to switch networks manually.

To switch networks manually

- 1 From standby select Menu > Settings > the Connectivity tab > Mobile Networks > GSM/3G Networks.
- 2 Select an option.

Emergency Calls

Your phone supports international emergency numbers, for example, 112 and 911. These numbers can normally be used to make emergency calls in any country, with or without the SIM card inserted, if a 3G (UMTS) or GSM network is within range.

 *In some countries, other emergency numbers may also be promoted. Your network operator may therefore have saved additional local emergency numbers on the SIM card.*

To make an emergency call

- From standby enter 112 (the international emergency number) and select Call.

To view your local emergency numbers

- 1 From standby select Menu > Contacts.
- 2 Select More > Options > Special Numbers > Emergency Nos.



Video Call

You can see a person on the screen during calls.



Before you use video call

Both parties need a subscription that supports the 3G (UMTS) service, and you need to be within range of a 3G (UMTS) network. 3G (UMTS) service is available when  appears on the screen.

To make a video call

- 1 From standby enter a phone number (international prefix and area code if applicable).
- 2 Select More > Make Video Call.

To use the zoom with an outgoing video

- Press  or .

To view video call options

- 1 During the call, select More.
- 2 Select an option.

Contacts

You can save names, phone numbers and personal information in Contacts. Information can be saved in the phone memory or on the SIM card.

Default contact

You can choose which contact information – Phone Contacts or SIM Contacts – is shown as default.

If Phone Contacts is selected as default, your contacts show all the information saved in Contacts. If you select SIM Contacts as default, your contacts show names and numbers saved on the SIM card.

To select default contacts

- 1 From standby select Menu > Contacts.
- 2 Select Options > Advanced > Default Contacts.
- 3 Select an option.

Phone contacts

Phone contacts can contain names, phone numbers and personal information. They are saved in the phone memory.

To add a phone contact

- 1 From standby select Menu > Contacts.
- 2 Scroll to New Contact and select Add.
- 3 Enter the name and select OK.
- 4 Enter the number and select OK.
- 5 Select a number option.
- 6 Scroll between tabs and select the fields to add information.
- 7 Select Save.

To add an item to a phone contact

- 1 From standby select Menu > Contacts.
- 2 Scroll to a contact and select More > Edit Contact.
- 3 Scroll between the tabs and select Add.
- 4 Select an option and an item to add.
- 5 Select Save.

 *If your subscription supports Calling Line Identification (CLI) service, you can assign personal ringtones to contacts.*

To copy names and numbers to the SIM card

- 1 From standby select Menu > Contacts.
- 2 Select More > Options > Advanced > Copy to SIM.
- 3 Select an option.

To call a phone contact

- 1 From standby select Menu > Contacts.
- 2 Scroll to a contact and select Call.

 *To go directly to a contact, from standby press **2** - **9**. See Speed Dial on page 24.*

To call a SIM contact from phone contacts

- 1 From standby select Menu > Contacts > More > Options > SIM Contacts.
- 2 Scroll to a contact and select Call.

SIM contacts

SIM contacts can contain names and numbers only. They are saved on the SIM card.

To add a SIM contact

- 1 From standby select Menu > Contacts > New Contact.
- 2 Select Add.
- 3 Enter the name and select OK.
- 4 Enter the number and select OK.
- 5 Select a number option and add more information, if available.
- 6 Select Save.

To copy names and numbers to phone contacts

- 1 From standby select Menu > Contacts > More > Options.
- 2 Select Advanced > Copy from SIM.
- 3 Select an option.

 *When you copy all contacts from your phone to the SIM card, all existing SIM card information is replaced.*

To automatically save names and phone numbers on the SIM card

- 1 From standby select Menu > Contacts.
- 2 Select More > Options > Advanced > Auto Save on SIM.
- 3 Select an option.

To call a SIM contact

- 1 From standby select Menu > Contacts.
- 2 Scroll to a contact and select Call.

Deleting contacts

To delete a contact

- 1 From standby select Menu > Contacts.
- 2 Scroll to a contact and press **(C)**.

To delete all phone contacts

- 1 From standby select Menu > Contacts.
- 2 Select More > Options > Advanced > Delete All Contacts.

Sending contacts

To send a contact

- 1 From standby select Menu > Contacts.
- 2 Scroll to a contact and select More > Send Contact.
- 3 Select a transfer method.

Memory status

The number of contacts you can save in your phone or on the SIM card depends on available memory.

To view memory status

- 1 From standby select Menu > Contacts.
- 2 Select More > Options > Advanced > Memory Status.

Synchronizing Contacts

Contacts can be synchronized with your computer and some Web applications. For more information, see *Synchronizing* on page 54.

To save contacts on a memory card

- 1 From standby select Menu > Contacts.
- 2 Select More > Options > Advanced > Back Up To M.S.

Groups

You can create a group of phone numbers and email addresses to send messages to. See *Messaging* on page 31. You can also use groups (with phone numbers) when you create accepted callers lists. See *Accept Calls* on page 28.

To create a group of numbers and email addresses

- 1 From standby select Menu > Contacts > Options > Groups > New Group.
- 2 Enter a name for the group and select Continue.
- 3 Select New to find and select a contact phone number or email address.
- 4 Repeat step 3 to add more phone numbers or email addresses.
- 5 Select Done.

Call List

You can view information about most recent calls.

To call a number from the call list

- 1 From standby select Calls and scroll to a tab.
- 2 Scroll to a name or a number and select Call.

To add a call list number to contacts

- 1 From standby select Calls and scroll to a tab.
- 2 Scroll to the number and select More > Save Number.
- 3 Select New Contact to create a new contact or select an existing contact to add the number to.

To clear the call list

- From standby select Calls > the All tab > More > Delete All.

Speed Dial

Speed dialing lets you select nine contacts that you can dial quickly. The contacts can be saved in positions 1-9.

To add contacts to speed dial numbers

- 1 From standby select Menu > Contacts.
- 2 Select Options > Speed Dial.

24 Calling

- 3 Scroll to a position number and select Add.
- 4 Select a contact.

To speed dial

- From standby enter the position number and select Call.

Voicemail

If your subscription includes an answering service, callers can leave a voicemail message when you cannot answer a call.

To enter your voicemail number

- 1 From standby select Menu > Messaging > Settings > Voicemail Number.
- 2 Enter the number and select OK.

To call your voicemail service

- From standby press and hold down .

To edit your voicemail number

- 1 From standby select Menu > Messaging > Settings > Voicemail Number.
- 2 Edit the number and select OK.





Voice control

By creating voice commands you can:

- Voice dial – call someone by saying their name.
- Activate voice control by saying a “magic word”.
- Answer and reject calls when you use a handsfree.

To activate voice dialing and record a voice command

- 1 From standby select Menu > Settings > the General tab > Voice Control > Voice Dialing > Activate.
- 2 Select Yes > New Voice Cmd. and select a contact.
- 3 If the contact has more than one number, use  and  to select the number to add the voice command to. Record a voice command such as “John mobile”.
- 4 Follow the instructions on the screen. Wait for the tone and say the command to record. The voice command is played back to you.
- 5 If the recording sounds OK, select Yes. If not, select No and repeat steps 3 and 4.

 *Voice commands are saved in the phone memory only. They cannot be used in another phone.*



To rerecord a voice command

- 1 From standby select Menu > Settings > the General tab > Voice Control > Voice Dialing > Edit Names.
- 2 Scroll to a command and select More > Replace Voice > Yes.
- 3 Wait for the tone and say the command.

Voice dialing

You can hear your recorded contact name when you receive a call from that contact.

To voice dial

- 1 From standby press and hold down  or .
- 2 Wait for the tone and say a recorded name, for example “John mobile”. The name is played back to you and the call is connected.

The magic word

You can record and use a voice command as a magic word to activate voice control without pressing any keys.

 *You should choose a long, unusual word or phrase that can easily be distinguished from ordinary background speech.*

To activate and record the magic word

- 1 From standby select Menu > Settings > the General tab > Voice Control > Magic Word > Activate.
- 2 Follow the instructions on the screen and select Continue. Wait for the tone and say the magic word.
- 3 Select Yes to accept or No for a new recording.
- 4 Follow the instructions on the screen and select Continue.
- 5 Select where your magic word is to be activated.

To make a call using the magic word

- 1 From standby say the magic word.
- 2 Wait for the tone and say a voice command.

Voice answering

When you use a handsfree, you can answer or reject incoming calls with your voice.

To activate voice answering and record voice answer commands

- 1 From standby select Menu > Settings > the General tab > Voice Control > Voice Answer > Activate.
- 2 Follow the instructions on the screen and select Continue. Wait for the tone and say "Answer", or another word.

- 3 Select Yes to accept or No for a new recording.
- 4 Follow the instructions on the screen and select Continue. Wait for the tone and say "Busy", or another word.
- 5 Select Yes to accept or No for a new recording.
- 6 Follow the instructions on the screen and select Continue.
- 7 Select where your voice answering is to be activated.

To answer a call using voice commands

- Say "Answer".

To reject a call using voice commands

- Say "Busy".

Forwarding Calls

You can forward calls, for example, to an answering service.

- ! *When Restrict Calls is used, some forward call options are not available. See Restricted Dialing on page 29.*

Forward call options

Standard options are:

- Always Forward – forward all your calls
- When Busy – if a call is ongoing

- Not Reachable – if turned off or unreachable
- No Reply – if not answered in a specified time

To forward calls

- 1 From standby select Menu > Settings > the Calls tab > Forward Calls.
- 2 Scroll to a call type and forward option and select Activate.
- 3 Enter the number to forward calls to and select OK.

More than One Call

You can handle more than one call at the same time. For example, you can put an ongoing call on hold, while you make or answer a second call. You can also switch between the two calls. You cannot answer a third call without ending one of the first two calls.

Call waiting

When call waiting is used, you hear a beep if you receive a second call.

To activate call waiting

- From standby select Menu > Settings > the Calls tab > Manage Calls > Call Waiting > Activate.

To make a second call

- 1 During the call, select More > Hold. This puts the ongoing call on hold.
- 2 Enter the number to call and select More > Call.

To answer a second call

- During the call, select Answer. This puts the ongoing call on hold.

To reject a second call

- During the call, select Busy and continue with the ongoing call.

To end an ongoing call and answer a second call

- During the call, select Replace Active Call.

Handling two voice calls

You can have calls ongoing and on hold at the same time.

To switch between two calls

- During the call, select More > Switch.

To join two calls

- During the call, select More > Join Calls.

To connect two calls

- During the call, select More > Transfer Call. You are disconnected from both calls.

To end an ongoing call and return to the call on hold

- Select End Call > Yes.

To end both calls

- Select End Call > No.

Receiving a third voice call

You cannot answer a third call without ending one of the first two calls or joining them into a conference call.

Conference Calls

With a conference call, you can have a joint conversation with up to five people.

To join the two calls

- During the call, select More > Join Calls.

To add a new participant

- 1 During the call, select More > Hold. This puts the joined calls on hold.
- 2 Select More > Add Call.
- 3 Enter the number to call and select Call.
- 4 Select More > Join Calls to add the new participant.
- 5 Repeat this task to add more participants.

To release a participant

- 1 Select More > Release Party.
- 2 Select the participant to release.

To have a private conversation

- 1 During the call, select More > Talk to and select the participant to talk to.
- 2 To resume the conference call, select More > Join Calls.

 *If your subscription supports Alternate Line Service (ALS), you can make separate calls with different phone numbers.*

My Numbers

You can view, add and edit your own phone numbers.

To check your phone numbers

- 1 From standby select Menu > Contacts > Options > Special Numbers > My Numbers.
- 2 Select an option.

Accept Calls

You can choose to receive calls from certain phone numbers only.

To add numbers to the accepted callers list

- 1 From standby select Menu > Settings > the Calls tab > Manage Calls > Accept Calls > Only from List > New.
- 2 Scroll to a contact or select Groups. See *Groups* on page 23.

To accept all calls

- From standby select Menu > Settings > the Calls tab > Manage Calls > Accept Calls > All Callers.

Restricted Dialing

You can restrict outgoing and incoming calls. A password from your service provider is required.

- *If you forward incoming calls, you cannot use some restrict calls options.*

Restrict calls options

Standard options are:

- All Outgoing – all outgoing calls
- Outgoing Intl. – all outgoing international calls
- Outgoing Intl Roam – all outgoing international calls except to your home country
- All Incoming – all incoming calls
- Inc. When Roaming – all incoming calls when you are abroad.

To restrict calls

- 1 From standby select Menu > Settings > the Calls tab > Manage Calls > Restrict Calls.
- 2 Select an option.
- 3 Enter your password and select OK.

Fixed Dialing

Fixed dialing allows calls to be made only to certain numbers saved on the SIM card. The fixed numbers are protected by your PIN2.

When fixed dialing is used, you can still call the international emergency number, 112.

Partial numbers can be saved. For example, saving 0123456 allows calls to be made to all numbers starting with 0123456.

- *When fixed dialing is used, you cannot view or manage any phone numbers saved on the SIM card.*

To use fixed dialing

- 1 From standby select Menu > Contacts.
- 2 Select More > Options > Special Numbers > Fixed Dialing > Activate.
- 3 Enter your PIN2 and select OK.
- 4 Select OK again to confirm.

To save a fixed number

- 1 From standby select Menu > Contacts.
- 2 Select More > Options > Special Numbers > Fixed Dialing > Fixed Numbers > New Number.
- 3 Enter the information and select Save.



Call Time and Cost

During a call, the duration of the call is shown. You can check the duration of your last call, outgoing calls and the total time of your calls.

To check the call time

- From standby select Menu > Settings > the Calls tab > Time & Cost > Call Timers.

Business Cards

To add your own business card

- 1 From standby select Menu > Contacts.
- 2 Select More > Options > My Business Card.
- 3 Scroll between tabs and select the fields to add information. To enter a symbol select More > Add Symbol > Insert.
- 4 Enter the information and select Save.

To send your business card

- 1 From standby select Menu > Contacts.
- 2 Select More > Options > My Business Card > Send My Card.
- 3 Select a transfer method.

Messaging

Text Messages

Text messages can contain simple pictures, sound effects, animations, and melodies.

Before you use messaging

You must have a service center number. The number is supplied by your service provider and is usually saved on the SIM card. If the number to your service center is not saved on your SIM card, you must enter the number yourself.

To enter a service center number

- 1 From standby select Menu > Messaging > Settings > Text Message > Service Center. The number is shown if it is saved on the SIM card.
- 2 If there is no number shown, select Edit > New Service Center and enter the number, including the international “+” sign and country code.
- 3 Select Save.

Sending messages

For information about entering letters, see *Entering Text* on page 18.

To write and send a text message

- 1 From standby select Menu > Messaging > Write New > Text Message.
- 2 Write the message and select Continue.
- 3 Scroll to an option and select Send.

! If you send a text message to a group, you will be charged for each member. See *Groups* on page 23.

To select more than one text message

- 1 From standby select Menu > Messaging and select a folder.
- 2 Scroll to a message and select More > Mark Several.
- 3 Select Mark to mark the messages.

To add an item to a text message

- 1 When you write the message, select More > Add Item.
- 2 Select an option and then an item.

Receiving text messages

You are notified when you receive a message. Received messages are saved in the inbox.

To view a text message from standby

- If the activity menu is set: select View.
- If pop-up is set: follow the instructions on the screen.

To view a text message from the inbox

- 1 From standby select Menu > Messaging > Inbox.
- 2 Scroll to the message and select View.

To close a text message

- Press .

To call a number in a text message

- When you view the message, scroll to the phone number and select Call.

Saving and deleting text messages

Received text messages are saved in the phone memory. When the phone memory is full, you can delete messages or move them to the SIM card.

To save a text message on the SIM card

- 1 From standby select Menu > Messaging and select a folder.
- 2 Scroll to the message and select More > Save message > Saved Messages.

To save an item in a text message

- 1 When you view the message, select the item.
- 2 Select More > Use.
- 3 Select an option.

To delete a text message

- 1 From standby select Menu > Messaging and select a folder.
- 2 Scroll to the message and press .

Picture Messages

Picture messages can contain text, pictures, slides, sound recordings, video clips, signatures and attachments. You can send picture messages to a cell phone or an email address.

Before you use picture messaging

You must set an Internet profile and the address of your message server. If no Internet profile or message server exists, you can receive all the settings automatically from your network operator or at www.sonyericsson.com/support.

To select an Internet profile

- 1 From standby select Menu > Messaging > Settings > Picture Message > MMS Profile.
- 2 Select a profile.

To set the message server address

- 1 From standby select Menu > Messaging > Settings > Picture Message > MMS Profile.
- 2 Scroll to a profile and select More > Edit > Message Server.
- 3 Select Edit and enter the address.



Sending messages

For information about entering letters, see *Entering Text* on page 18.

To create and send a picture message

- 1 From standby select Menu > Messaging > Write New > Picture Msg.
- 2 Enter the text and press to add items to the message.
- 3 Select Continue.
- 4 Scroll to an option and select Send.

Receiving picture messages

You can select how to download your picture messages. Standard options when you download picture messages are:

- Always – automatic download.
- Ask in Roaming – ask to download when not in home network.
- Not in Roaming – do not download when not in home network.
- Always Ask – ask to download.
- Off – new messages appear in the Inbox.

To set automatic download

- 1 From standby select Menu > Messaging > Settings > Picture Message > Auto Download.
- 2 Select an option.

To view a picture message from standby

- If the activity menu is set: select View.
- If pop-up is set: follow the instructions on the screen.

To view a picture message from the inbox

- 1 From standby select Menu > Messaging > Inbox.
- 2 Scroll to the message and select View.

To close a picture message

- Press .

To save an item in a picture message

- When you view a picture message select More > Save Items and select an item.

To delete a message

- 1 From standby select Menu > Messaging and select a folder.
- 2 Scroll to the message and press .

Message options

You can set standard options for all messages or choose specific settings each time you send a message.

To set text message options

- 1 From standby select Menu > Messaging > Settings > Text Message.
- 2 Scroll to an option and select Edit.





To set picture message options

- 1 From standby select Menu > Messaging > Settings > Picture Message.
- 2 Scroll to an option and select Edit.

Send options

You can request a delivery report, a read report, and set a priority for a specific message. You can also add more recipients to the message.

To set send options

- 1 When the message is ready and a recipient is selected, select More > Advanced.
- 2 Scroll to an option and select Edit.

Templates

If you often use the same phrases and pictures in a message, you can save the message as a template.

To use a text message template

- 1 From standby select Menu > Messaging > Templates.
- 2 Scroll to a template and select Use > Text Message.
- 3 Add text and select Continue and select a recipient.

To use a picture message template

- 1 From standby select Menu > Messaging > Templates.
- 2 Scroll to a template and select Use.
- 3 When the message is ready, select Continue and select a recipient.

To add a text message template

- 1 From standby select Menu > Messaging > Templates > New Template > Text.
- 2 Insert text or select More to add items. Select OK.
- 3 Enter a title and select OK.

To add a picture message template

- 1 From standby select Menu > Messaging > Templates > New Template > Picture Msg.
- 2 Enter the text and press  to add items to the message.
- 3 Select Save, enter a title and select OK.

To edit a template

- 1 From standby select Menu > Messaging > Templates.
- 2 Scroll to a template and select More > Edit Template > Save.

To save a message as a template

- 1 From standby select Menu > Messaging > Inbox.
- 2 Scroll to the message and select More > Save message > Templates.



Voice Messages

You can send and receive a sound recording as a voice message.

- ! *The sender and recipient must have a subscription supporting picture messaging.*

To record and send a voice message

- 1 From standby select Menu > Messaging > Write New > Voice Message.
- 2 Record the message and select Stop > Send.
- 3 Scroll to an option and select Send.

Email

You can use standard email functions and your computer email address in your phone.

Before you use email

Email settings must be entered in your phone. You can have these settings sent directly to your phone from the Sony Ericsson support site, or you can enter them manually.

Email settings using Internet

You can receive settings at www.sonyericsson.com/support.

Entering email settings manually

You can also enter the email settings manually. To do this, you need to ask your email provider for the settings information:

Settings types	Examples
Connection Type	POP3 or IMAP4
Email Address	joe.smith@example.com
Incoming Server	mail.example.com
Username	jsmith
Password	zX123
Outgoing Server	mail.example.com

An email provider could be the company that supplied your email address, for example, your IT administrator at work or an Internet provider.

You may find settings information in your computer email program settings, or in a document from your email provider.



- ! *There are many different email providers. Their terminology and required information may differ. Not all service providers allow email access.*

To enter email settings

- 1 From standby select Menu > Messaging > Email > Settings.
- 2 Enter the settings.
Help appears as you enter settings.

 For more information, contact your email provider or go to www.sonyericsson.com/support.

To write and send an email message

- 1 From standby select Menu > Messaging > Email > Write New.
- 2 Select Add to enter the first recipient.
- 3 Select Edit to enter more recipients.
- 4 Select an option and a recipient. When you are ready, select Done.
- 5 Press  to scroll to Subject:. Select Edit and enter a subject.
- 6 Press  to scroll to Text:. Select Edit and enter the text.
- 7 Press  to scroll to Attachments:. Select Add and select a file to attach.
- 8 Select Continue > Send.

To receive and read an email message

- 1 From standby select Menu > Messaging > Email > Inbox > Send&Rec.
- 2 Scroll to the message and select View.

To save an email message

- 1 From standby select Menu > Messaging > Email > Inbox.
- 2 Scroll to the message and select More > Save Message > Saved Email.

To reply to an email message

- 1 From standby select Menu > Messaging > Email > Inbox.
- 2 Scroll to the message and select More > Reply.
- 3 Write the reply and select OK.
- 4 Select Continue > Send.

To view an attachment in an email message

- When you view the message, select More > Attachments > View.

To save an attachment in an email message

- When you view the message, select More > Attachments > View > Save.

Active email account

If you have several email accounts, you can change which one is active.

To change the active email account

- 1 From standby select Menu > Messaging > Email > Settings.
- 2 Select an account.

To delete an email message (POP3)

- 1 From standby select Menu > Messaging > Email > Inbox.
- 2 Scroll to the message and select More > Mark for Del. > Yes.

 *Marked messages will be deleted when you next connect to your server.*

To delete an email message (IMAP4)

- 1 From standby select Menu > Messaging > Email > Inbox.
- 2 Scroll to the message and select More > Mark for Del. > Yes.
- 3 Select More > Clear Inbox.

 *Marked messages will be deleted in the phone and on the server.*

Push email

You can receive notification in your phone from your email server that you have new email.

To turn on push email notification

- 1 From standby select Menu > Messaging > Email > Settings.
- 2 Scroll to an account to edit and select More > Edit Account > Advanced Settings > Push Email.
- 3 Select an option.

My Friends

You can connect and log in to the My friends server to communicate online with chat messages.

Before you use My friends

If no settings exist in your phone, you need to enter server settings. Standard settings information supplied by your service provider is:

- username
- password
- server address
- Internet profile.

To enter My friends server settings

- 1 From standby select Menu > Messaging > My Friends > Configure.
- 2 Select Add and enter the settings.

To edit My friends settings

- 1 From standby select Menu > Messaging > My Friends.
- 2 Select More > Settings.
- 3 Scroll to the setting and select Edit.

To log in to the My friends server

- From standby select Menu > Messaging > My Friends > Log In.

To log out of the My friends server

- Select More > Log Out.

To add a chat contact

- 1 From standby select Menu > Messaging > My Friends > the Contacts tab.
- 2 Select More > Add Contact.

To send a chat message

- 1 From standby select Menu > Messaging > My Friends > the Contacts tab.
- 2 Scroll to a contact and select Chat.
- 3 Write the message and select Send.

Status

You can show your status, for example, Happy or Busy, to your contacts only. You can also show your status to all users on the My friends server.

To show my status

- 1 From standby select Menu > Messaging > My Friends > More > Settings > Show My Status.
- 2 Select an option.

To update your own status

- 1 From standby select Menu > Messaging > My Friends > the My Status tab.
- 2 Scroll between tabs and select the fields to add information.

Chat group

A chat group can be started by your service provider, by an individual My friends user or by yourself. You can save chat groups by saving a chat invitation or by searching for a specific chat group.

To create a chat group

- 1 From standby select Menu > Messaging > My Friends > the Chat Groups tab.
- 2 Select More > Add Chat Group > New Chat Group.
- 3 Select who to invite from your contacts list and select Continue.
- 4 Enter a short invitation text and select Continue > Send.

To add a chat group

- 1 From standby select Menu > Messaging > My Friends > the Chat Groups tab > More > Add Chat Group.
- 2 Select an option.

 *Conversation history is saved between log out and when you log in again to let you return to chat messages from previous conversations.*

To save a conversation

- 1 From standby select Menu > Messaging > My Friends > the Conversations tab.
- 2 Scroll to a conversation and select More > Advanced > Save Conv.

To view a saved conversation

- 1 From standby select Menu > Messaging > My Friends > the Conversations tab.
- 2 Select More > Saved Conv.

Area and Cell Information

Area and cell information are text messages, for example, local traffic reports that are sent to subscribers within a certain network area.

Contact your service provider for more information.

To turn area information on

- 1 From standby select Menu > Messaging > Settings > Area Info.
- 2 Scroll to Reception and select Edit > On.



Imaging

Camera and Video Recorder

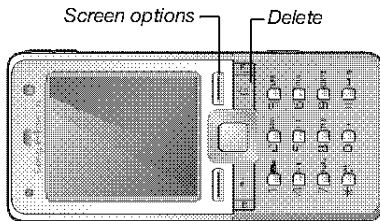
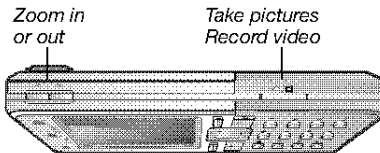

You can take pictures and record video clips to view, save or send.



To take a picture

- 1 From standby press  to activate the camera.
- 2 Use the navigation key to select camera.
- 3 Press  half way down to use auto focus and then fully down to take a picture.

**To record a video clip**

- 1 From standby press  to activate the camera.
- 2 Use the navigation key to select video recorder.
- 3 Press  half way down to use auto focus and then fully down to start recording.



 Do not record with a strong light source in the background.

To stop recording

- Press .

To use zoom

- Press  or .

To adjust brightness

- Press  or .

To use auto focus

- Press  half way down. You hear a beep when auto focus is set.

Saving and deleting pictures and video clips

Pictures and video clips are saved automatically in File Manager.

To view pictures and video clips

- 1 From standby select Menu > File Manager > Camera Album.
- 2 Scroll to an item and select View.

To delete pictures and video clips

- 1 From standby select Menu > File Manager > Camera Album.
- 2 Scroll to an item and press .

Camera settings

You can select different settings before you take a picture or record a video clip.







To view settings

- When you are in the viewfinder select Settings.

To view information about settings

- Scroll to a setting and select Info.

Camera shortcuts

Key	Shortcut
	Shoot Mode
	Zoom out
	Focus
	Zoom in
	Scenes
	Camera key guide
	Light

Transferring Pictures

Transfer to and from your computer

You can use Bluetooth and picture messages to transfer pictures to your computer. You can also use the USB cable to drag and drop camera pictures. See *Transferring files using the USB cable* on page 57.

You can enhance and organize your pictures on your computer by installing Adobe™ Photoshop™ Album Starter Edition. These are included on the CD that comes with your phone and are available at www.sonyericsson.com/support.

Picture blog

A picture blog is a personal Web page. If your subscription supports this service, you can send pictures to a blog.

- ! *Web services may require a separate license agreement between you and the service provider. Additional regulations and/or charges may apply. Contact your service provider.*

To send camera pictures to a blog

- 1 From standby select Menu > File Manager > Camera Album.
- 2 Scroll to a picture and select More > Send > To Blog.
- 3 Add title and text.
- 4 Select OK > Publish.

To go to a blog address from contacts

- 1 From standby select Menu > Contacts.
- 2 Scroll to contact.
- 3 Scroll to a Web address and select Go To.

Camera album printing

You can print camera pictures using the USB cable connected to a compatible printer.

- ! *You can also print using a Bluetooth compatible printer.*

To print camera pictures using the USB cable

- 1 From standby select Menu > File Manager > Camera Album.
- 2 Select More > Print.
- 3 Select an option.
- 4 Connect the USB cable to the phone.
- 5 Connect the USB cable to the printer.
- 6 Wait for feedback in the phone and select OK.
- 7 Set printer settings, if required and select Print.

! *You should disconnect and re-connect the USB cable if there is a printer error.*

To print camera pictures using a memory card

- 1 Check printer documentation for information regarding settings, memory card and PictBridge support.
- 2 When you view a camera picture, select More > Print > DPOF (M.S.) > Save.
- 3 Transfer the memory card to your printer and follow the instructions on the screen.

Pictures and Video Clips

You can view, add, edit or delete pictures in the File Manager. File types supported are, for example, GIF, JPEG, WBMP, BMP, PNG and SVG-Tiny.

Using pictures

You can add a picture to a contact, use it during phone startup, as a wallpaper in standby or as a screen saver.

To view pictures

- 1 From standby select Menu > File Manager > Pictures.
- 2 Scroll to a picture and select View.

To use pictures

- 1 From standby select Menu > File Manager > Pictures.
- 2 Scroll to a picture and select More > Use As.
- 3 Select an option.

To view pictures in a slide show

- 1 From standby select Menu > File Manager > Pictures.
- 2 Scroll to a picture and select View > More > Slide Show.

Sending and receiving

You can send and receive pictures as a picture message, an email or using Bluetooth.

To send a picture

- 1 From standby select Menu > File Manager > Pictures.
- 2 Scroll to a picture and select More > Send.
- 3 Select an option.



To send a video clip

- 1 From standby select Menu > File Manager > Videos.
- 2 Scroll to a video clip and select More > Send.
- 3 Select an option.

To receive a picture

- 1 From standby select Menu > Settings > the Connectivity tab.
- 2 Select an option.

PhotoDJ™ and VideoDJ™

You can edit pictures and video clips using PhotoDJ™ or VideoDJ™.

To edit and save a picture

- 1 From standby select Menu > File Manager > Pictures.
- 2 Scroll to a picture and select More > Edit in PhotoDJ™.
- 3 Select an option and edit the picture.
- 4 Select More > Save Picture.

To edit and save a video clip

- 1 From standby select Menu > File Manager > Videos.
- 2 Scroll to a video clip and select More > VideoDJ™.
- 3 Select an option and edit the video clip.
- 4 Select More > Save.

Themes

You can change the appearance of the screen through items such as colors and wallpaper. You can also create new themes and download them. For more information, go to www.sonyericsson.com/support.

To set a theme

- 1 From standby select Menu > File Manager > Themes.
- 2 Scroll to a theme and select Set.



Entertainment

Stereo Portable Handsfree

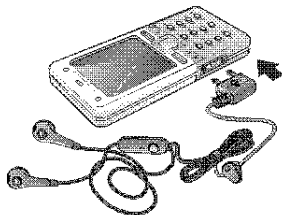

To use the handsfree

- Connect the portable handsfree. Music stops when you receive a call and resumes when the call has ended.

Music and Video Players

File types supported are: MP3, MP4, M4A, 3GP, AAC, AAC+, Enhanced AAC, AMR, MIDI, IMY, EMY, WAV (16 kHz maximum sample rate) and Real@8. Your phone also supports streamed files that are 3GPP compatible.

To play music

- 1 From standby select Menu > Music Player.
- 2 Scroll to an option and select Open.
- 3 Scroll to a title and select Play.

To play videos

- 1 From standby select Menu > Entertainment > Video Player.
- 2 Scroll to a title and select Play.

Music and video controls

To stop playing music

- Select Stop.

To resume playing music

- Select Play.

To change the volume

- When you listen to music in the music player, press or .

To move between tracks

- When you listen to music in the music player, press or .

To fast forward and rewind

- When you listen to music in the music player, press and hold down or .

To return to the music player menu

- When you listen to music in the music player, press .

To exit the music player menu

- Press and hold down .

Sending and receiving music

You can send and receive music in a picture message, an email or using Bluetooth.

To send music

- 1 From standby select Menu > Music Player.
- 2 Scroll to an option and select Open.
- 3 Scroll to a title and select More > Send.
- 4 Select an option.

To receive music

- When you receive notification, follow the instructions on the screen.

Transferring music from a computer

Disc2Phone computer software and USB drivers are included on the CD that comes with your phone. You can use Disc2Phone to transfer music from CDs or your computer to the phone memory or a memory card.

Before you use Disc2Phone

You need one of these operating system requirements to use Disc2Phone on your computer:

- Windows 2000 SP4
- XP Home
- XP Professional SP1.

To install Disc2Phone

- 1 Turn on your computer and insert the CD that came with the phone. The CD starts automatically and the installation window opens.
- 2 Select a language and click OK.
- 3 Click Install Disc2Phone and follow the instructions on the screen.

 *Disc2Phone software is available at www.sonyericsson.com/support.*

To use Disc2Phone

- 1 Connect the phone to a computer with the USB cable that came with the phone.
- 2 Select File Transfer. The phone turns off and prepares to transfer files.
- 3 Computer: *Start/Programs/Disc2Phone*.
- 4 For details on transferring music, please refer to Disc2Phone Help. Click  in the top-right corner of the Disc2Phone window.
- 5 For safe disconnection of the USB cable in file transfer mode, right-click the removable disk icon in Windows Explorer and select Eject.
See Transferring files using the USB cable on page 57.

- *Do not remove the USB cable from your phone or computer during transfer, as this may corrupt a memory card or the phone memory. You cannot view the transferred files in your phone until you have removed the USB cable from your phone.*

More information about transferring files to your phone is available at www.sonyericsson.com/support.

Browsing files

Music and video files are saved and categorized.

- Artists – list tracks you have transferred using Disc2Phone.
- Tracks – list all music tracks in your phone and on a memory card.
- Playlists – your own lists of tracks.
- Videos – list all video clips in your phone or on a memory card.

Playlists

You can create playlists to organize files in the File Manager. You can sort the files by artist or title. Files can be added to more than one playlist.

Deleting a playlist, or a file from a playlist, does not delete the file from the memory, just the reference to the file.

To create a playlist

- 1 From standby select Menu > Music Player.
- 2 Scroll to Playlists and select Open.
- 3 Scroll to New Playlist and select Add.
- 4 Enter a name and select OK.
- 5 Scroll to a track and select Mark.
- 6 Select Add to add the track to the playlist.

To add files to a playlist

- 1 From standby select Menu > Music Player.
- 2 Scroll to Playlists and select Open.
- 3 Scroll to the playlist and select Open.
- 4 Select More > Add Media.
- 5 Scroll to a track and select Mark.
- 6 Select Add to add the track to the playlist.

To remove tracks from a playlist

- 1 From standby select Menu > Music Player > Playlists.
- 2 Scroll to a playlist and select Open.
- 3 Scroll to the track and press **(E)**.

To delete a playlist

- 1 From standby select Menu > Music Player > Playlists.
- 2 Scroll to a playlist and press **(G)**.

To view information about a track

- Scroll to a track and select More > Information.

Online music and video clips

You can view video clips and listen to music by streaming them to your phone from the Internet. If settings are not already in your phone, see *Settings* on page 52. For more information, contact your network operator or go to www.sonyericsson.com/support.

To select a data account for streaming

- 1 From standby select Menu > Settings > the Connectivity tab > Streaming Settings.
- 2 Select the data account to use.

To stream music and video clips

- 1 From standby select Menu > Internet > More > Go To > Bookmarks.
- 2 Select a link to stream from.



Radio

- *Do not use your phone as a radio in places where this is prohibited.*

To listen to the radio

- 1 Connect the handsfree to the phone.
- 2 From standby select Menu > Entertainment > Radio.



To change the volume

- When the radio is playing, press  or .



To automatically search for radio channels

- When the radio is playing, select Search.

To manually search for radio channels

- When the radio is playing, press  or .

To search for preset channels

- When the radio is playing, press  or .

Saving radio channels

You can save up to 20 preset channels.

To save radio channels

- 1 From standby select Menu > Entertainment > Radio.
- 2 Select Search to find a radio channel.
- 3 Select More > Save.

To select saved radio channels

- 1 From standby select Menu > Entertainment > Radio > More > Channels.
- 2 Select a radio channel.

To save radio channels in positions 1 to 10

- When you have found a radio channel, press and hold down - .

To select radio channels saved in positions 1 to 10

- When the radio is playing, press - .

To view radio options

- When the radio is playing, select More.



PlayNow™

You can listen to music before you purchase and download it to your phone.

- *This service is not available in all countries. Contact your network operator for more information. In some countries you can purchase music from some of the world's top musical artists.*

Before you use PlayNow™

You must have the required settings in your phone. See *Settings* on page 52.

To listen to PlayNow™ music

- 1 From standby select Menu > PlayNow™.
- 2 Select music from a list.

Downloading from PlayNow™

The price appears when you select to download and save a music file. Your phone bill or prepaid card is debited when a purchase is accepted.

To download a music file

- 1 When you have listened to a music file preview, you can agree to accept the conditions.
- 2 Select Yes to download.
- 3 A text message is sent to confirm payment and the file is made available to download.

Ringtones and melodies

To set a ringtone

- 1 From standby select Menu > Settings > the Sounds & Alerts tab > Ringtone.
- 2 Select an option.

To set the ringtone volume

- 1 From standby select Menu > Settings > the Sounds & Alerts tab > Ring Volume.
- 2 Press or to change the volume.
- 3 Select Save.

To turn the ringtone off

- From standby press and hold down .
All signals except the alarm signal are affected.

To set the vibrating alert

- 1 From standby select Menu > Settings > the Sounds & Alerts tab > Vibrating Alert.
- 2 Select an option.

To send a ringtone

- 1 From standby select Menu > File Manager > Music > Ringtones.
- 2 Scroll to a ringtone and select More > Send.
- 3 Select a transfer method.

To receive a ringtone





- Select a transfer method and follow the instructions on the screen.

 *You are not allowed to exchange some copyright-protected material. A protected file has a key symbol.*

MusicDJ™

You can compose and edit your own melodies to use as ringtones. A melody consists of four types of tracks – Drums, Basses, Chords, and Accents. A track contains a number of music blocks. The blocks consist of pre-arranged sounds with different characteristics. The blocks are grouped into Intro, Verse, Chorus, and Break. You compose a melody by adding music blocks to the tracks.

To compose a melody

- 1 From standby select Menu > Entertainment > MusicDJ™.
- 2 Select to Insert, Copy or Paste blocks.
- 3 Use , ,  or  to scroll between the blocks.
- 4 Select More > Save Melody.

To send a melody

- 1 From standby select Menu > File Manager.
- 2 Scroll to Music and select Open.
- 3 Scroll to a melody and select More > Send.
- 4 Select a transfer method.

To receive a melody

- Select a transfer method and follow the instructions on the screen.
-  *You cannot send a polyphonic melody or MP3 file in a text message.*

VideoDJ™

You can create and edit your own video clips by using video clips, pictures and text.

To create a video clip

- 1 From standby select Menu > Entertainment > VideoDJ™.
- 2 Select Add and select an option.

- 3 Press  and select Add to add more items.
- 4 Select More > Save.

To edit video a clip

- 1 From standby select Menu > File Manager.
- 2 Scroll to Videos and select Open.
- 3 Scroll to a video clip and select More > VideoDJ™ > Edit.
- 4 Edit the video clip and select More > Save.

To trim a video clip

- 1 From standby select Menu > File Manager.
- 2 Scroll to Videos and select Open.
- 3 Scroll to a video clip and select More > VideoDJ™ > Edit > Trim.
- 4 Select Set to set the start point and select Start.
- 5 Select Set to set the end point and select End.
- 6 Select Trim > More > Save.

To send a video clip

- 1 From standby select Menu > File Manager > Videos.
- 2 Scroll to Videos and select Open.
- 3 Scroll to a video clip and select More > Send.
- 4 Select a transfer method.

50 Entertainment

To receive a video clip

- When you receive notification, follow the instructions on the screen.

Sound recorder

You can record a voice memo or a call. Recorded sounds can also be set as ringtones.

 *In some countries or states it is required by law that you inform the other person before recording the call.*

To record a sound

- From standby select Menu > Entertainment > Record Sound.

To listen to a recording

- 1 From standby select Menu > File Manager > Music.
- 2 Scroll to a recording and Play.

Games

Your phone contains several games. You can also download games. Help texts are available for most games.

To start a game

- 1 From standby select Menu > Entertainment > Games.
- 2 Select game.

To end a game

- Press and hold down .



Applications

Before you use Java™ applications

If settings are not already entered in your phone, see *Settings* on page 52.

You can download and run Java applications. You can also view information or set different permissions.

To select a Java application

- 1 From standby select Menu > File Manager > Applications.
- 2 Select an application.

To view information about a Java application

- 1 From standby select Menu > File Manager > Applications.
- 2 Scroll to an application and select More > Information.

To set permissions for a Java application

- 1 From standby select Menu > File Manager > Applications.
- 2 Scroll to an application and select More > Permissions.

To set the screen size for a Java application

- 1 From standby select Menu > File Manager > Applications.
- 2 Scroll to an application and select More > Screen Size.
- 3 Select an option.

Internet profiles for Java applications

Some Java applications need to connect to the Internet to receive information.

To select an Internet profile for Java applications

- 1 From standby select Menu > Settings > the Connectivity tab > Internet Settings > Settings for Java.
- 2 Select an option.



Connectivity

Settings

Before you use Internet, PlayNow™, My friends, Java, remote synchronization, picture messaging, email and picture blog you need to have settings in your phone.

If settings are not already entered, make sure your phone supports data transfer. You can download settings using the setup wizard or from www.sonyericsson.com/support.

To download settings using the Setup wizard

- 1 From standby select Menu > Settings > the General tab > Setup Wizard > Settings Download.
- 2 Follow the instructions on the screen.

To download settings using a computer

- 1 Go to www.sonyericsson.com/support.
- 2 Follow the instructions on the screen.

Using Internet

You can use the Internet to access online services.

To start browsing

- From standby select Menu > Internet.

To exit the browser

- When you browse the Internet, select More > Exit Browser.

To view options

- When you browse the Internet, select More.

When you browse the Internet

You can make a call or send a link when you browse the Internet.

To make a call

- When you browse the Internet, select More > Tools > Make a Call.

To send a link

- 1 When you browse the Internet, select More > Tools > Send Link.
- 2 Select an option.

Using bookmarks

You can create and edit bookmarks as quick links to your favorite Web pages.

To create a bookmark

- 1 From standby select Menu > Internet > More > Go To > Bookmarks.
- 2 Scroll to New Bookmark and select Add.
- 3 Enter the information and select Save.

To select a bookmark











- 1 From standby select Menu > Internet > More > Go To > Bookmarks.
- 2 Scroll to a bookmark and select Go To.

Internet keypad shortcuts

You can use the keypad to go directly to an Internet browser function.

To select Internet keypad shortcuts

- From standby select Menu > Internet > More > Options > Keypad Mode > Shortcuts.

Key	Shortcut
	Bookmarks
	Enter Address
	Search Internet
	History
	Refresh Page
	Forward
	Page up
	Page down
	Full Screen or Landscape or Normal Screen
	Zoom
	Shortcuts

Downloading

You can download files, for example, pictures, themes, games and ringtones from Web pages.

To download from a Web page

- 1 When you browse the Internet, select a file to download.
- 2 Follow the instructions on the screen.

Internet profiles

You can select another Internet profile if you have more than one.

To select an Internet profile for the Internet browser

- 1 From standby select Menu > Settings > the Connectivity tab > Internet Settings > Internet Profiles.
- 2 Select an option.

Internet security and certificates

Your phone supports secure browsing. Certain Internet services, such as banking, require certificates in your phone. Your phone may already contain certificates when you buy it or you can download new certificates.

To view certificates in the phone

- From standby select Menu > Settings > the General tab > Security > Certificates.

RSS Reader

You can receive frequently updated content, such as news headlines, as feeds, using Really Simple Syndication (RSS).

To add new feeds for a Web page

- When you browse the Internet, select More > RSS Feeds.

To create a new feed

- 1 From standby select Menu > Messaging > RSS Reader > More > New Feed.
- 2 Enter the address and select Go To.

To set and use RSS reader options

- 1 From standby select Menu > Messaging > RSS Reader > More.
- 2 Select an option.

Synchronizing

You can synchronize phone contacts, appointments, tasks and notes. You can use Bluetooth wireless technology, Internet services or the USB cable.

Sony Ericsson PC Suite software

In order to synchronize, you need to install the synchronization software for your computer. This is found in the Sony Ericsson PC Suite on the CD included with your phone. The software includes help information.

You can also go to www.sonyericsson.com/support to download the software.

Remote synchronization using Internet

You can synchronize online using an Internet service. If Internet settings are not in your phone, see *Settings* on page 52.

Before you use Sony Ericsson PC Suite

You must enter settings for remote synchronization and register a synchronization account online. Settings that are required are:

- Server Address – server URL.
- Username – account username.
- Password – account password.
- Connection – select an Internet profile.
- Applications – mark applications to synchronize.
- Application Settings – select an application and enter a database name, and if required, username and password.
- Sync. Interval – set how often to synchronize.
- Remote Initiation – select an option to use when you start synchronization from a service.
- Remote Security – enter a server ID and a server password.



To enter settings for remote synchronization

- 1 From standby select Menu > Organizer > Synchronization > Yes.
- 2 Enter a name for the new account and select Continue.
- 3 Enter the settings and select Save.

To start remote synchronization

- 1 From standby select Menu > Organizer > Synchronization.
- 2 Scroll to an account and select Start.

Bluetooth™ Wireless Technology

The Bluetooth function makes wireless connection to other Bluetooth devices possible. You can, for example:

- Connect to handsfree devices.
- Connect to stereo headsets.
- Connect to more than one device at the same time.
- Connect to computers and access the Internet.
- Synchronize information with computers.
- Use remote control computer applications.
- Use media viewer accessories.
- Exchange items and play multiplayer games.

 *We recommend a range within 33 feet (10 meters), with no solid objects in between, for Bluetooth communication.*

Before you use Bluetooth wireless technology

You must turn on the Bluetooth function to communicate with other devices. You must also pair your phone with other Bluetooth devices.

To turn the Bluetooth function on

- From standby select Menu > Settings > the Connectivity tab > Bluetooth > Turn On.

 *Make sure that the device you want to pair your phone with has the Bluetooth function activated and is made visible.*

To pair the phone with a device

- 1 From standby select Menu > Settings > the Connectivity tab > Bluetooth > My Devices > New Device to search for available devices.
- 2 Select a device.
- 3 Enter a passcode, if required.

To allow connection to the phone

- 1 From standby select Menu > Settings > the Connectivity tab > Bluetooth > My Devices.
- 2 Select a device from the list.
- 3 Select More > Allow Connect.



To pair the phone with a Bluetooth handsfree for the first time

- 1 From standby select Menu > Settings > the Connectivity tab > Bluetooth > Handsfree.
- 2 Select Yes.
- 3 Enter a passcode, if required.

To pair the phone with more than one Bluetooth handsfree

- 1 From standby select Menu > Settings > the Connectivity tab > Bluetooth > Handsfree > My Handsfree > New Handsfree.
- 2 Scroll to a device and select Add.

Power save

You can save battery power with this function. You can only connect with a single Bluetooth device. You must turn this function off if you want to connect with more than one Bluetooth device at the same time.

To turn powersave on

- From standby select Menu > Settings > the Connectivity tab > Bluetooth > Powersave > On.

Phone name

You can enter a name for your phone to be shown when other devices find it.

To enter a phone name

- 1 From standby select Menu > Settings > the Connectivity tab > Bluetooth > Phone Name.
- 2 Enter the phone name and select OK.

Visibility

If you want other Bluetooth devices to be able to discover your phone, you can choose to make your phone visible.

To send a contact using Bluetooth

- 1 From standby select Menu > Contacts.
- 2 Scroll to a contact and select More > Send Contact > Via Bluetooth.
- 3 Select the device to send the item to.

To receive an item

- 1 From standby select Menu > Settings > the Connectivity tab > Bluetooth > Turn On > Visibility > Show Phone.
- 2 When you receive an item, follow the instructions on the screen.

Transferring sound to and from a Bluetooth handsfree

You can transfer the sound to and from a Bluetooth handsfree. To do this, you can use a phone key or the handsfree key.

To transfer sound

- 1 From standby select Menu > Settings > the Connectivity tab > Bluetooth > Handsfree > Incoming Call.
- 2 Select an option. In Phone transfers sound to the phone. In Handsfree transfers sound to the handsfree.

File transfer

You can synchronize and transfer files using Bluetooth wireless technology. See *Sony Ericsson PC Suite software* on page 54.

Transferring files using the USB cable

You can connect your phone to a computer, using the USB cable. You can transfer files using File Transfer and you can synchronize your phone with a computer using Phone Mode.

Before you use the USB cable

You need one of the these operating system requirements to transfer files using a USB cable:

- Windows® 2000 with SP3/SP4
- Windows XP (Pro and Home) with SP1/SP2.

USB drivers are installed automatically with the Sony Ericsson PC Suite software.

File transfer

You can drag and drop files between your phone and a computer in Microsoft Windows Explorer.

- Sony Disc2Phone – drag and drop music files
- Adobe™ Photoshop™ Album Starter Edition – drag and drop pictures

These applications can only be used in file transfer mode.

 *Only use the USB cable that comes with your phone, and connect the USB cable directly to the computer. Do not remove the USB cable from your phone or computer during file transfer as this may corrupt the phone memory or the memory card.*



To use file transfer mode

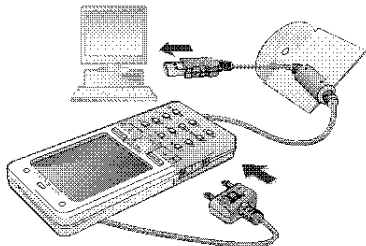

- 1 Connect the USB cable to the phone and the computer.
- 2 Phone: From standby select Menu > Settings > the Connectivity tab > USB > USB connection. > File Transfer. The phone shuts down.
- 3 Wait until the phone memory and memory card appear as external disks in Windows Explorer.

To disconnect the USB cable safely

- 1 Right-click the removable disk icon in Windows Explorer.
- 2 Select Eject.
- 3 Remove the USB cable.

Phone mode

You can synchronize contacts and calendar, transfer files and use your phone as a modem from your computer. Supported applications in phone mode include:

- Synchronization
- File manager
- Mobile Networking Wizard.

For other applications, use the file transfer mode.

To install the Sony Ericsson PC Suite

- 1 Turn on your computer and insert the CD that came with the phone. The CD starts automatically and the installation window opens.
- 2 Select a language and click OK.
- 3 Click Install Sony Ericsson PC suite and follow the instructions on the screen.

 *Sony Ericsson PC suite software is available at www.sonyericsson.com/support.*

To use phone mode

- 1 Computer: Start PC Suite from Start/Programs/Sony Ericsson/PC Suite.
- 2 Connect the USB cable to the phone and the computer.

- 3 **Phone:** From standby select Menu > Settings > the Connectivity tab > USB > USB connection. > Phone Mode.
- 4 **Computer:** Wait while Windows installs the required drivers.
- 5 **Computer:** When you are notified that PC Suite has found your phone, use one of the phone mode applications in the Sony Ericsson PC Suite.

Update Service

You can update your phone with the latest software. You do not lose personal or phone information.

There are two ways to update your phone:

- Over the air using your phone
- Using the provided USB cable and an Internet-connected computer

 *The update service requires data access (GPRS).*

Before you use the Update service

If settings are not in your phone, see *Settings* on page 52.

To view the current software in the phone

- 1 From standby select Menu > Settings > the General tab > Update Service.
- 2 Select Software Version.

To use Update service using the phone

- 1 From standby select Menu > Settings > the General tab > Update Service.
- 2 Select Search For Update and follow the instructions on the screen.

To use Update service using a USB cable

- 1 Go to *www.sonyericsson.com/support*.
- 2 Select a region and country.
- 3 Enter the product name.
- 4 Select Sony Ericsson Update Service and follow the instructions on the screen.

To set a reminder to use Update service

- 1 From standby select Menu > Settings > the General tab > Update Service > Reminder.
- 2 Select an option.

More Features

Alarms

You can set a sound or the radio as an alarm signal. The alarm sounds even if the phone is set to silent or turned off. When the alarm sounds you can silence it for 9 minutes or turn it off.

To set the alarm

- 1 From standby select Menu > Alarms.
- 2 Scroll to an alarm and select Edit.
- 3 Scroll to Time: and select Edit.
- 4 Enter a time and select OK > Save.

To set the recurring alarm

- 1 From standby select Menu > Alarms.
- 2 Scroll to an alarm and select Edit.
- 3 Scroll to Recurrent: and select Edit.
- 4 Scroll to a day and select Mark.
- 5 Select Done > Save.

To set the alarm signal

- 1 From standby select Menu > Alarms.
- 2 Scroll to an alarm and select Edit.
- 3 Scroll to Alarm Signal: and select Edit.
- 4 Scroll to an option and select Save.

To silence the alarm

- When the alarm sounds, press any key.

To silence the radio alarm

- When the alarm sounds, select Snooze.

To turn off an alarm

- When the alarm sounds, select Turn Off.

To cancel the alarm

- 1 From standby select Menu > Alarms.
- 2 Scroll to an alarm and select Turn Off.

Calendar

The calendar can be synchronized with a computer calendar or with a calendar on the Web. See *Synchronizing* on page 54.

Appointments

You can add new appointments or reuse existing appointments.

To add an appointment

- 1 From standby select Menu > Organizer > Calendar.
- 2 Select a date.
- 3 Scroll to New appointment and select Add.
- 4 Enter the information and confirm each entry.
- 5 Select Save.

To view an appointment

- 1 From standby select Menu > Organizer > Calendar.
- 2 Select a date.
- 3 Scroll to an appointment and select View.

To reuse an existing appointment

- 1 From standby select Menu > Organizer > Calendar.
- 2 Select a date.
- 3 Scroll to an appointment and select View.
- 4 Select More > Edit.
- 5 Edit the appointment and confirm each entry.
- 6 Select Save.

To send an appointment

- 1 From standby select Menu > Organizer > Calendar.
- 2 Select a date.
- 3 Scroll to an appointment and select More > Send.
- 4 Select a transfer method.

To view a calendar week

- 1 From standby select Menu > Organizer > Calendar.
- 2 Select a date.
- 3 Select More > View Week.









To set when reminders should sound

- 1 From standby select Menu > Organizer > Calendar.
- 2 Select a date.
- 3 Select More > Advanced > Reminders.
- 4 Select an option.

 A reminders option set in calendar affects a reminders option set in tasks.

Navigating your calendar

You can use the navigation key to move between days or weeks. In the monthly view, you can use keypad shortcuts.

Key	Shortcut
	Back a week
	Back a month
	Back a year
	Next year
	Today's date
	Next week
	Next month
	Next year



Calendar settings

To view calendar options

- 1 From standby select Menu > Organizer > Calendar.
- 2 Select More.

Tasks

You can add new tasks or reuse existing tasks.

To add a task

- 1 From standby select Menu > Organizer > Tasks.
- 2 Select New Task > Add.
- 3 Select an option.
- 4 Enter details and confirm each entry.

To view a task

- 1 From standby select Menu > Organizer > Tasks.
- 2 Scroll to a task and select View.

To reuse an existing task

- 1 From standby select Menu > Organizer > Tasks.
- 2 Scroll to a task and select View.
- 3 Select More > Edit.
- 4 Edit the task and select Continue.
- 5 Choose to set a reminder.

To send a task

- 1 From standby select Menu > Organizer > Tasks.
- 2 Scroll to a task and select More > Send.
- 3 Select a transfer method.

To set when reminders should sound

- 1 From standby select Menu > Organizer > Tasks.
- 2 Scroll to a task and select More > Reminders.
- 3 Select an option.

- ! *A reminders option set in tasks affects a reminders option set in calendar.*

Notes

You can make notes and save them. You can also show a note in standby.

To add a note

- 1 From standby select Menu > Organizer > Notes.
- 2 Select New Note > Add.
- 3 Write a note and select Save.

To show a note in standby

- 1 From standby select Menu > Organizer > Notes.
- 2 Scroll to a note and select More > Show in Standby.



**To edit a note**

- 1 From standby select Menu > Organizer > Notes.
- 2 Scroll to a note and select More > Edit.
- 3 Edit the note and select Save.

To send a note

- 1 From standby select Menu > Organizer > Notes.
- 2 Scroll to a note and select More > Send.
- 3 Select a transfer method.

Timer, Stopwatch and Calculator**To use the timer**

- 1 From standby select Menu > Organizer > Timer.
- 2 Enter the hours, minutes and seconds.
- 3 Select Start.

To use the stopwatch

- 1 From standby select Menu > Organizer > Stopwatch > Start.
- 2 To view a new lap time, select New Lap.

To use the calculator

- 1 From standby select Menu > Organizer > Calculator.
- 2 Press or to select \div \times $-$ $+$ $.$ $\%$ $=$.

Code Memo

You can save security codes, for example, for credit cards. You must set a passcode to open the code memo.

Checkword

The checkword confirms that you have entered the correct passcode. If the passcode is correct, the correct codes are shown. If the passcode is incorrect, the checkword and the codes shown are also incorrect.

To open code memo for the first time

- 1 From standby select Menu > Organizer > Code Memo.
- 2 Follow the instructions on the screen and select Continue.
- 3 Enter a passcode and select Continue.
- 4 Confirm the passcode and select Continue.
- 5 Enter a checkword and select Done.

To add a code

- 1 From standby select Menu > Organizer > Code Memo.
- 2 Enter a passcode and select New Code > Add.
- 3 Enter a name associated with the code and select Continue.
- 4 Enter the code and select Done.



To change a passcode

- 1 From standby select Menu > Organizer > Code Memo.
- 2 Enter your passcode and select More > Change Passcode.
- 3 Enter your new passcode and select Continue.
- 4 Re-enter the new passcode and select Continue.
- 5 Enter a checkword and select Done.

Forget your passcode?

If you forget your passcode, you must reset the code memo. This means that all entries in the code memo are deleted. The next time you enter the code memo, you must proceed as if you are opening it for the first time. See *To open code memo for the first time* on page 63.

To reset code memo

- 1 From standby select Menu > Organizer > Code Memo.
- 2 Enter any passcode to access the code memo. The checkword and codes that are then shown are incorrect.
- 3 Select More > Reset.
- 4 Reset code memo? appears.
- 5 Select Yes.

Profiles

Profiles automatically adapt your phone to different situations, for example, while in a meeting or when driving. Some profiles settings, for example, ring volume may be adjusted automatically to suit a certain area or accessory. You can reset all profile settings to how they were set when you bought your phone.

To select a profile

- 1 From standby select Menu > Settings > the General tab > Profiles.
- 2 Select a profile.

To view and edit a profile

- 1 From standby select Menu > Settings > the General tab > Profiles.
- 2 Scroll to a profile and select More > View And Edit.

 *You cannot rename the Normal profile.*

To reset all profiles

- 1 From standby select Menu > Settings > the General tab > Profiles.
- 2 Scroll to a profile and select More > Reset Profiles.

Time and Date

To set the time

- 1 From standby select Menu > Settings > the General tab > Time & Date > Time.
- 2 Enter the time > Save.

To set the date

- 1 From standby select Menu > Settings > the General tab > Time & Date > Date.
- 2 Enter the date and select Save.

Locks

SIM card lock

This lock only protects your subscription. Your phone will work with a new SIM card. If the lock is on, you have to enter a PIN (Personal Identity Number).

If you enter your PIN incorrectly three times in a row, the SIM card is blocked and you need to enter your PUK (Personal Unblocking Key). Your PIN and PUK are supplied by your network operator.

To unblock the SIM card

- 1 When PIN Blocked appears, enter your PUK and select OK.
- 2 Enter a new four-to-eight-digit PIN and select OK.
- 3 Re-enter the new PIN and select OK.

To edit the PIN

- 1 From standby select Menu > Settings > the General tab > Security > Locks > SIM Protection > Change PIN.
- 2 Enter your PIN and select OK.
- 3 Enter a new four-to-eight-digit PIN and select OK.
- 4 Re-enter the new PIN and select OK.

 If Codes do not match. *appears, you entered the new PIN incorrectly.*
If Wrong PIN. *appears, followed by Old PIN:, you entered your old PIN incorrectly.*

To use the SIM card lock

- 1 From standby select Menu > Settings > the General tab > Security > Locks > SIM Protection > Protection.
- 2 Select an option.
- 3 Enter your PIN and select OK.

Phone lock

You can stop unauthorized use of your phone. Change the phone lock code (0000) to any four-to-eight-digit personal code.

- *It is important that you remember your new code. If you forget it, you have to take your phone to your local Sony Ericsson retailer.*

To use the phone lock

- 1 From standby select Menu > Settings > the General tab > Security > Locks > Phone Protection > Protection.
- 2 Select an option.
- 3 Enter the phone lock code and select OK.

To change the phone lock code

- 1 From standby select Menu > Settings > the General tab > Security > Locks > Phone Protection > Change Code.
- 2 Enter the old code and select OK.
- 3 Enter the new code and select OK.
- 4 Repeat the code and select OK.

Keypad lock

You can set this lock to avoid accidental dialing. Incoming calls can be answered without unlocking the keypad.

- *Calls to the international emergency number 112 can still be made.*

To use the automatic key lock

- 1 From standby select Menu > Settings > the General tab > Security > Automatic Key Lock.
- 2 Select an option.

To lock the keypad manually

- From standby press  and select Lock Keys.





To unlock the keypad manually

- From standby press  and select Unlock.

IMEI Number

Keep a copy of your IMEI (International Mobile Equipment Identity) number in case your phone should be stolen.

To view your IMEI number

- From standby press , , , , .



Troubleshooting

Why doesn't the phone work the way I want it to?

Some problems will require that you to call your network operator.

For more support go to www.sonyericsson.com/support.

Common Questions

I have problems with memory capacity or the phone is working slowly

Restart your phone every day to free memory or do a Master Reset.

Master reset

If you select Reset Settings, the changes that you have made to settings will be deleted.

If you select Reset All, in addition to your changes to settings, all contacts, messages, personal data, and content that you have downloaded, received or edited will also be deleted.

To reset the phone

- 1 From standby select Settings > the General tab > Master Reset > Reset Settings.
- 2 Follow the instructions on the screen and select Continue.

I cannot charge the phone or battery capacity is low

The charger is not properly connected or the battery connection is poor. Remove the battery and clean the connectors.

The battery is worn out and needs to be replaced. See *Charging the Battery* on page 7.

No battery icon appears when I start charging the phone

It may take a few minutes before the battery icon appears on the screen.

Some menu options appear in gray

A service is not activated. Contact your network operator.

I cannot use SMS/text messages on my phone

Settings are missing or incorrect. Contact your network operator to find out the correct SMS service center setting. See *Text Messages* on page 31.

I cannot use picture messages on my phone

Your subscription does not include data capability. Settings are missing or incorrect. Please contact your network operator.



See *Help in your Phone* on page 6 or go to www.sonyericsson.com/support, choose your phone model, then choose “Phone setup – MMS” and follow the instructions on the screen. See *Settings* on page 52.

How do I turn on and off T9 text input when writing a text message?

When you enter text, press and hold down . You will see “T9” at the top of the text message when T9 is activated.

How do I change phone language?

- 1 From standby select Menu > Settings > the General tab > Language > Phone Language.
- 2 Select an option.

I cannot use the Internet

Your subscription does not include data capability. Internet settings are missing or incorrect. Please contact your network operator.

See *Help in your Phone* on page 6 or go to www.sonyericsson.com/support, choose your phone model, then choose “Phone setup – WAP” and follow the instructions on the screen. See *Settings* on page 52.

The phone cannot be detected by other devices using Bluetooth wireless technology

You have not turned the Bluetooth function on.

Make sure that the visibility is set to show phone. See *To receive an item* on page 56.

I cannot synchronize or transfer data between my phone and my computer, when using the USB cable

The cable or software that came with your phone has not been properly installed. Go to www.sonyericsson.com/support, choose your phone model, then choose Product information - Getting started. The Synchronizing the phone with a computer Getting started guide contains installation instructions and a troubleshooting guide.

Error Messages

Insert SIM.

There is no SIM card in your phone or you have inserted it incorrectly.

See *Charging the Battery* on page 7.

The SIM card connectors need cleaning. If the card is damaged, contact your network operator.





Insert correct SIM card.
Your phone is set to work only with certain SIM cards. Check if you are using the correct operator SIM card.

Wrong PIN./Wrong PIN2.
You have entered your PIN or PIN2 incorrectly.

Enter the correct PIN or PIN2 and select Yes. See *To insert the SIM card and battery* on page 5.

PIN Blocked/PIN2 blocked.
You have entered your PIN or PIN2 code incorrectly three times in a row.

To unblock, see *SIM card lock* on page 65.

Codes do not match.
Codes that you have entered do not match. When you want to change a security code, for example your PIN, you have to confirm the new code. See *SIM card lock* on page 65.

No Netw. Coverage
Your phone is in flight mode. See *Flight mode* on page 6.

Your phone is not receiving any radio signal, or the received signal is too weak. Contact your network operator

and make sure that the network has coverage where you are.

The SIM card is not working properly. Insert your SIM card in another phone. If this works, it is probably your phone that is causing the problem. Please contact the nearest Sony Ericsson service location.

Emerg. Calls Only
You are within range of a network, but you are not allowed to use it. However, in an emergency, some network operators allow you to call the international emergency number 112. See *Emergency Calls* on page 20.

PUK blocked. Contact provider.
You entered your personal unblocking key code (PUK) incorrectly 10 times in a row.

Charging - Non-standard battery.
The battery that you are using is not a Sony Ericsson-approved battery. See *Battery* on page 73.



Important Information

Sony Ericsson Consumer Web Site

On www.sonyericsson.com/support is a support section where help and tips are only a few clicks away. Here you will find the latest computer software updates and tips on how to use your product more efficiently.

Service and support

From now on you will have access to a portfolio of exclusive service advantages such as:

- Global and local Web sites providing support.
- A global network of Call Centers.
- An extensive network of Sony Ericsson service partners.
- A warranty period. Learn more about the warranty conditions in this User guide.

On www.sonyericsson.com, under the support section in the language of your choice, you will

find the latest support tools and information, such as software updates, Knowledge base, phone setup and additional help when you require it. For operator-specific services and features, please contact your network operator for more information. You can also contact our Call Centers. See the phone number for the nearest Call Center in the list below. If your country/region is not represented in the list, please contact your local dealer. (The phone numbers below were correct at the time of going to print. On www.sonyericsson.com you can always find the latest updates.

In the unlikely event that your product needs service please contact the dealer from whom it was purchased or one of our service partners. Save your original proof of purchase, you will need it if you need to claim warranty.

For a call to one of our Call Centers you will be charged according to national rates, including local taxes, unless the phone number is a toll-free number.

Country	Phone number
Argentina	800-333-7427
Australia	1-300 650 050
Austria	0810 200245
Belgium	02-745 1611
Brazil	4001-0444
Canada	1-866-766-8374
Central Africa	+27 112589023
Chile	123-0020-0656
China	4008100000
Colombia	18009122135
Croatia	062 000 000
Czech Republic	844 550 055
Denmark	33 31 28 28
Finland	09-299 2000
France	0 825 383 383
Germany	0180 534 2020

Email address

questions.AR@support.sonyericsson.com
 questions.AU@support.sonyericsson.com
 questions.AT@support.sonyericsson.com
 questions.BE@support.sonyericsson.com
 questions.BR@support.sonyericsson.com
 questions.CA@support.sonyericsson.com
 questions.CF@support.sonyericsson.com
 questions.CL@support.sonyericsson.com
 questions.CN@support.sonyericsson.com
 questions.CO@support.sonyericsson.com
 questions.HR@support.sonyericsson.com
 questions.CZ@support.sonyericsson.com
 questions.DK@support.sonyericsson.com
 questions.FI@support.sonyericsson.com
 questions.FR@support.sonyericsson.com
 questions.DE@support.sonyericsson.com



Greece	801-11-810-810 210-89 91 919 (from mobile)	questions.GR@support.sonyericsson.com
Hong Kong	8203 8863	questions.HK@support.sonyericsson.com
Hungary	+36 1 880 4747	questions.HU@support.sonyericsson.com
India	39011111 (Add STD code when dialing from a GSM connection)	questions.IN@support.sonyericsson.com
Indonesia	021-2701388	questions.ID@support.sonyericsson.com
Ireland	1850 545 888	questions.IE@support.sonyericsson.com
Italy	06 48895206	questions.IT@support.sonyericsson.com
Lithuania	8 700 55030	questions.LT@support.sonyericsson.com
Malaysia	1-800-889900	questions.MY@support.sonyericsson.com
Mexico	01 800 000 4722	questions.MX@support.sonyericsson.com
Netherlands	0900 899 8318	questions.NL@support.sonyericsson.com
New Zealand	0800-100150	questions.NZ@support.sonyericsson.com
Norway	815 00 840	questions.NO@support.sonyericsson.com
Pakistan	111 22 55 73 Outside Karachi: (92-21) 111 22 55 73	questions.PK@support.sonyericsson.com
Philippines	02-6351860	questions.PH@support.sonyericsson.com
Poland	0 (prefix) 22 6916200	questions.PL@support.sonyericsson.com
Portugal	808 204 466	questions.PT@support.sonyericsson.com
Romania	(+4021) 401 0401	questions.RO@support.sonyericsson.com
Russia	8(495) 787 0986	questions.RU@support.sonyericsson.com
Singapore	67440733	questions.SG@support.sonyericsson.com
Slovakia	02-5443 6443	questions.SK@support.sonyericsson.com
South Africa	0861 632222	questions.ZA@support.sonyericsson.com
Spain	902 180 576	questions.ES@support.sonyericsson.com
Sweden	013-24 45 00	questions.SE@support.sonyericsson.com
Switzerland	0848 824 040	questions.CH@support.sonyericsson.com
Taiwan	02-25625511	questions.TW@support.sonyericsson.com
Thailand	02-2483030	questions.TH@support.sonyericsson.com
Turkey	0212 47 37 777	questions.TR@support.sonyericsson.com
Ukraine	(+380) 44 590 1515	questions.UA@support.sonyericsson.com
United Arab Emirates	43 919880	questions.AE@support.sonyericsson.com
United Kingdom	08705 23 7237	questions.GB@support.sonyericsson.com
United States	1-866-766-9374	questions.US@support.sonyericsson.com
Venezuela	0-800-100-2250	questions.VE@support.sonyericsson.com



Guidelines for Safe and Efficient Use

Please read this information before using your cell phone.

These instructions are intended for your safety. Please follow these guidelines. If the product has been subject to any of the conditions listed below or you have any doubt as to its proper function make sure you have the product checked by a certified service partner before charging or using it. Failure to do so might entail a risk of product malfunction or even a potential hazard to your health.



Recommendations for safe use of product (cell phone, battery, charger and other accessories)

- Always treat your product with care and keep it in a clean and dust-free place.
- **Warning!** May explode if disposed of in fire.
- Do not expose your product to liquid or moisture or humidity.
- Do not expose your product to extreme high or low temperatures. Do not expose the battery to temperatures above +140°F (+60°C).
- Do not expose your product to open flames or lit tobacco products.
- Do not drop, throw or try to bend your product.
- Do not paint your product.
- Do not attempt to disassemble or modify your product. Only Sony Ericsson authorized personnel should perform service.
- Do not use your product near medical equipment without requesting permission from your treating physician or authorized medical staff.



- Do not use your product when in, or around aircraft, or areas showing the sign "turn off two-way radio".
- Do not use your product in an area where a potentially explosive atmosphere exists.
- Do not place your product or install wireless equipment in the area above an air bag in your car.
- Caution: Cracked or broken displays may create sharp edges or splinters that could be harmful upon contact.



CHILDREN

KEEP OUT OF CHILDRENS REACH. DO NOT ALLOW CHILDREN TO PLAY WITH YOUR CELL PHONE OR ITS ACCESSORIES. THEY COULD HURT THEMSELVES OR OTHERS, OR COULD ACCIDENTALLY DAMAGE THE CELL PHONE OR ACCESSORY. YOUR CELL PHONE OR ITS ACCESSORY MAY CONTAIN SMALL PARTS THAT COULD BECOME DETACHED AND CREATE A CHOKING HAZARD.



Power supply (Charger)

Connect the AC power adapter only to designated power sources as marked on the product. Make sure the cord is positioned so that it will not be subjected to damage or stress. To reduce risk of electric shock, unplug the unit from any power source before attempting to clean it. The AC power adapter must not be used outdoors or in damp areas. Never alter the cord or plug. If the plug does not fit into the outlet, have a proper outlet installed by a qualified electrician.

Use only Sony Ericsson branded original chargers intended for use with your cell phone. Other chargers may not be designed to the same safety and performance standards.

Battery

We recommend that you fully charge the battery before you use your cell phone for the first time. A new battery or one that has not been used for a long time could have reduced capacity the first few times it is used. The battery should only be charged in temperatures between +41°F (+5°C) and +113°F (+45°C).

Use only Sony Ericsson branded original batteries intended for use with your cell phone. Using other batteries and chargers could be dangerous.

Talk and standby times depend on several different conditions such as signal strength, operating temperature, application usage patterns, features selected and voice or data transmissions when the cell phone is being used.

Turn off your cell phone before removing the battery. Do not put the battery into your mouth. Battery electrolytes may be toxic if swallowed. Do not let the metal contacts on the battery touch another metal object. Doing this could short-circuit and damage the battery. Use the battery for the intended purpose only.

Personal medical devices

Cell phones may affect the operation of pacemakers and other implanted equipment. Please avoid placing the cell phone over the pacemaker, e.g. in your breast pocket. When using the cell phone, use it at the ear on the opposite side of the body to the pacemaker. If a minimum distance of 6 inches (15 cm) is kept between the cell phone and the pacemaker, the risk of interference is limited. If you have any reason to suspect that interference is taking place, immediately turn off your cell phone. Contact your cardiologist for more information. For other medical devices, please consult your physician and the manufacturer of the device.

Driving

Please check if local laws and regulations restrict the use of cell phones while driving or require drivers to use handsfree solutions. We recommend that you use only Sony Ericsson handsfree solutions intended for use with your product.

Please note that because of possible interference to electronic equipment, some vehicle manufacturers forbid the use of cell phones in their vehicles unless a handsfree kit with an external antenna has been installed.

Always pay full attention to driving and pull off the road and park before making or answering a call if driving conditions so require.

Emergency calls

Cell phones operate using radio signals, which cannot guarantee connection in all conditions. You should therefore never rely solely upon any cell phone for essential communications (e.g. medical emergencies).

Emergency calls may not be possible in all areas, on all cellular networks, or when certain network services and/or cell phone features are in use. Check with your local service provider.

Antenna

This phone contains a built-in antenna. Use of antenna devices not marketed by Sony Ericsson specifically for this model could damage your cell phone, reduce performance, and produce SAR levels above the established limits (see below).

Efficient use

Hold your cell phone as you would any other phone. Do not cover the top of the phone when it is in use, as this affects call quality and may cause the phone to operate at a higher power level than needed, thus shortening talk and standby times.

Radio frequency (RF) exposure and Specific Absorption Rate (SAR)

Your cell phone is a low-power radio transmitter and receiver. When it is turned on, it emits low levels of radio frequency energy (also known as radio waves or radio frequency fields).

Governments around the world have adopted comprehensive international safety guidelines, developed by scientific organizations, e.g. ICNIRP (International Commission on Non-Ionizing Radiation Protection) and IEEE (The Institute of Electrical and Electronics Engineers Inc.), through periodic and thorough evaluation of scientific studies. These guidelines establish permitted levels of radio wave exposure for the general population. The levels include a safety margin designed to assure the safety of all persons, regardless of age and health, and to account for any variations in measurements.

Specific Absorption Rate (SAR) is the unit of measurement for the amount of radio frequency energy absorbed by the body when using a cell phone. The SAR value is determined at the highest certified power level in laboratory conditions, but the actual SAR level of the cell phone while it is operating can be well below this value. This is because the cell phone is designed to use the minimum power required to reach the network.

Variations in SAR below the radio frequency exposure guidelines do not mean that there are variations in safety. While there may be differences in SAR levels among cell phones, all Sony Ericsson cell phone models are designed to meet radio frequency exposure guidelines.

For phones sold in the US, before a phone model is available for sale to the public, it must be tested and certified by the Federal Communications Commission (FCC) that it does not exceed the limit established by the government-adopted requirement for safe exposure. The tests are performed in positions and locations (that is, at the ear and worn on the body) as required by the

FCC for each model. For body-worn operation, this phone has been tested and meets FCC RF exposure guidelines when the handset is positioned a minimum of 15 mm from the body without any metal parts in the vicinity of the phone or when used with the original Sony Ericsson accessory intended for this phone and worn on the body. Use of other accessories may not ensure compliance with FCC RF exposure guidelines.

A separate leaflet with SAR information about this cell phone model is included with the material accompanying this cell phone. This information can also be found, together with more information on radio frequency exposure and SAR, on: www.sonyericsson.com/health.

Accessible Solutions/Special Needs

For phones sold in the US, you can use your TTY terminal with your Sony Ericsson cell phone (with the necessary accessory). For information on Accessible Solutions for individuals with special needs call the Sony Ericsson Special Needs Center on 877 878 1996 (TTY) or 877 207 2058 (voice), or visit the Sony Ericsson Special Needs Center at www.sonyericsson-snc.com.

Disposal of old electrical and electronic equipment



This symbol indicates that all electrical and electronic equipment included shall not be treated as household waste. Instead it shall be left at the appropriate collection point for recycling of electrical and electronic equipment. By ensuring this product is disposed of correctly, you will help prevent potential negative consequences for the environment and human health, which could otherwise be caused by inappropriate waste handling of this product. The recycling of materials will help to conserve natural resources. For more detailed

information about recycling this product, please contact your local city office, your household waste disposal service or the shop where you purchased the product.

Disposing of the battery

Please check local regulations for disposal of batteries or call your local Sony Ericsson Call Center for information.

The battery should never be placed in municipal waste. Use a battery disposal facility if available.



Memory card

Your product comes complete with a removable memory card. It is generally compatible with the handset purchased but may not be compatible with other devices or the capabilities of their memory cards. Check other devices for compatibility before purchase or use.

The memory card is formatted prior to shipping. To reformat the memory card, use a compatible device. Do not use the standard operating system format when formatting the memory card on a PC. For details, refer to the operating instructions of the device or contact customer support.

WARNING:

If your device requires an adapter for insertion into the handset or another device, do not insert the card directly without the required adapter.

Precautions on Memory Card Use

- Do not expose the memory card to moisture.
- Do not touch terminal connections with your hand or any metal object.
- Do not strike, bend, or drop the memory card.
- Do not attempt to disassemble or modify the memory card.

- Do not use or store the memory card in humid or corrosive locations or in excessive heat such as a closed car in summer, in direct sunlight or near a heater, etc.
- Do not press or bend the end of the memory card adapter with excessive force.
- Do not let dirt, dust, or foreign objects get into the insert port of any memory card adapter.
- Check you have inserted the memory card correctly.
- Insert the memory card as far as it will go into any memory card adapter needed. The memory card may not operate properly unless fully inserted.
- We recommend that you make a backup copy of important data. We are not responsible for any loss or damage to content you store on the memory card.
- Recorded data may be damaged or lost when you remove the memory card or memory card adapter, turn off the power while formatting, reading or writing data, or use the memory card in locations subject to static electricity or high electrical field emissions.

Protection of personal information

To safeguard your privacy and prevent information being accessible to a third party, you should erase all personal data before selling or disposing of the product. To delete personal data, perform a master reset and remove the memory card. DELETION OF MATERIAL FROM THE PHONE MEMORY DOES NOT ENSURE THAT SAID INFORMATION CANNOT BE RECOVERED BY A SUBSEQUENT USER. SONY ERICSSON DOES NOT WARRANT AGAINST A SUBSEQUENT USER OF THE DEVICE ACCESSING YOUR INFORMATION AND DOES NOT ASSUME ANY RESPONSIBILITY FOR SUBSEQUENT DISCLOSURE OF SAID INFORMATION EVEN IF A MASTER RESET HAS BEEN PERFORMED. If you are concerned about such potential disclosure retain your device or secure its permanent destruction.

Accessories

Sony Ericsson recommends use of Sony Ericsson original accessories for safe and efficient use of its products. Use of third-party accessories may decrease performance or pose a risk to your health or safety.

LOUDNESS WARNING:

Please adjust the audio volume cautiously when using third-party audio accessories to avoid volume levels that may be harmful to your hearing. Sony Ericsson does not test use of third-party audio accessories with this cell phone. Sony Ericsson recommends using only Sony Ericsson original audio accessories.

End User License Agreement

This wireless device, including without limitation any media delivered with the device, ("Device") contains software owned by Sony Ericsson Mobile Communications AB and its affiliated companies ("Sony Ericsson") and its third party suppliers and licensors ("Software").

As user of this Device, Sony Ericsson grants you a non-exclusive, non-transferable, non-assignable license to use the Software solely in conjunction with the Device on which it is installed and/or delivered with. Nothing herein shall be construed as a sale of the Software to a user of this Device. You shall not reproduce, modify, distribute, reverse engineer, decompile, otherwise alter or use any other means to discover the source code of the Software or any component of the Software. For avoidance of doubt, you are at all times entitled to transfer all rights and obligations to the Software to a third party, solely together with the Device with which you received the Software, provided always that such third party agrees in writing to be bound by these rules.

You are granted this license for a term of the useful life of this Device. You can terminate this license by

transferring all your rights to the Device on which you have received the Software to a third party in writing. If you fail to comply with any of the terms and conditions set out in this license, it will terminate with immediate effect.

Sony Ericsson and its third party suppliers and licensors are the sole and exclusive owner of and retain all rights, title and interest in and to the Software. Sony Ericsson, and, to the extent that the Software contains material or code of a third party, such third party, shall be entitled third party beneficiaries of these terms.

The validity, construction and performance of this license shall be governed by the laws of Sweden. The foregoing shall apply to the full extent permitted by, when applicable, statutory consumer rights.

Limited Warranty

Sony Ericsson Mobile Communications AB, SE-221 88 Lund, Sweden, (Sony Ericsson) or its local affiliated company, provides this Limited Warranty for your cell phone and original accessory delivered with your cell phone (hereinafter referred to as "Product").

Should your Product need warranty service, please return it to the dealer from whom it was purchased, or contact your local Sony Ericsson Call Center (national rates may apply) or visit www.sonyericsson.com to get further information.

Our warranty

Subject to the conditions of this Limited Warranty, Sony Ericsson warrants this Product to be free from defects in design, material and workmanship at the time of its original purchase by a consumer. This Limited Warranty will last for a period of one (1) year as from the original date of purchase of the Product.

What we will do

If, during the warranty period, this Product fails to operate under normal use and service, due to defects in design, materials or workmanship, Sony Ericsson authorized distributors or service partners, in the country* where you purchased the Product, will, at their option, either repair or replace the Product in accordance with the terms and conditions stipulated herein.

Sony Ericsson and its service partners reserve the right to charge a handling fee if a returned Product is found not to be under warranty according to the conditions below.

Please note that some of your personal settings, downloads and other information may be lost when your Sony Ericsson Product is repaired or replaced. At present Sony Ericsson may be prevented by applicable law, other regulation or technical restrictions from making a backup copy of certain downloads. Sony Ericsson does not take any responsibility for any lost information of any kind and will not reimburse you for any such loss.

You should always make backup copies of all the information stored on your Sony Ericsson Product such as downloads, calendar and contacts before handing in your Sony Ericsson Product for repair or replacement.

Conditions

- 1 This Limited Warranty is valid only if the original proof of purchase for this Product issued by a Sony Ericsson authorized dealer specifying the date of purchase and serial number**, is presented with the Product to be repaired or replaced. Sony Ericsson reserves the right to refuse warranty service if this information has been removed or changed after the original purchase of the Product from the dealer.

- 2 If Sony Ericsson repairs or replaces the Product, the repair for the defect concerned, or the replaced Product shall be warranted for the remaining time of the original warranty period or for ninety (90) days from the date of repair, whichever is longer. Repair or replacement may involve the use of functionally equivalent reconditioned units. Replaced parts or components will become the property of Sony Ericsson.
- 3 This warranty does not cover any failure of the Product due to normal tear and wear, or due to misuse, including but not limited to use in other than the normal and customary manner, in accordance with the Sony Ericsson instructions for use and maintenance of the Product. Nor does this warranty cover any failure of the Product due to accident, software or hardware modification or adjustment, acts of God or damage resulting from liquid.

A rechargeable battery can be charged and discharged more than a hundred times. However, it will eventually wear out – this is not a defect and corresponds to normal wear and tear. When the talk-time or standby time is noticeably shorter, it is time to replace your battery. Sony Ericsson recommends that you use only batteries and chargers approved by Sony Ericsson.

Minor variations in display brightness and color may occur between the phones. There may be tiny bright or dark dots on the display. These are called defective pixels and occur when individual dots have malfunctioned and can not be adjusted. Two defective pixels are deemed acceptable.

Minor variations in camera image appearance may occur between phones. This is nothing uncommon and is not regarded as a defective camera module.

- 4 Since the cellular system on which the Product is to operate is provided by a carrier independent from Sony Ericsson, Sony Ericsson will not be responsible for the operation, availability, coverage, services or range of that system.

- 5 This warranty does not cover Product failures caused by installations, modifications, or repair or opening of the Product performed by a non-Sony Ericsson authorized person.
- 6 The warranty does not cover Product failures which have been caused by use of accessories or other peripheral devices which are not Sony Ericsson branded original accessories intended for use with the Product.
- 7 Tampering with any of the seals on the Product will void the warranty.
- 8 **THERE ARE NO EXPRESS WARRANTIES, WHETHER WRITTEN OR ORAL, OTHER THAN THIS PRINTED LIMITED WARRANTY. ALL IMPLIED WARRANTIES, INCLUDING WITHOUT LIMITATION THE IMPLIED WARRANTIES OF MERCHANTABILITY OR FITNESS FOR A PARTICULAR PURPOSE, ARE LIMITED TO THE DURATION OF THIS LIMITED WARRANTY. IN NO EVENT SHALL SONY ERICSSON OR ITS LICENSORS BE LIABLE FOR INCIDENTAL OR CONSEQUENTIAL DAMAGES OF ANY NATURE WHATSOEVER, INCLUDING BUT NOT LIMITED TO LOST PROFITS OR COMMERCIAL LOSS; TO THE FULL EXTENT THOSE DAMAGES CAN BE DISCLAIMED BY LAW.**

Some countries/states do not allow the exclusion or limitation of incidental or consequential damages, or limitation of the duration of implied warranties, so the preceding limitations or exclusions may not apply to you.

The warranty provided does not affect the consumer's statutory rights under applicable legislation in force, nor the consumer's rights against the dealer arising from their sales / purchase contract.

*Geographical scope of the warranty

If you have purchased your Product in a country member of the European Economic Area (EEA) or in Switzerland or the Republic of Turkey, and such Product was intended for sale in the EEA or in Switzerland or in Turkey, you can have your Product serviced in any EEA country or in Switzerland or in Turkey, under the warranty conditions prevailing in the country in which you require servicing, provided that an identical Product is sold in such country by an authorized Sony Ericsson distributor. To find out if your Product is sold in the country you are in, please call the local Sony Ericsson Call Center. Please observe that certain services may not be possible elsewhere than in the country of original purchase, for example due to the fact that your Product may have an interior or exterior which is different from equivalent models sold in other countries. Please note in addition that it may sometimes not be possible to repair SIM-locked Products.

** In some countries/regions additional information (such as a valid warranty card) may be requested.

FCC Statement

This device complies with Part 15 of the FCC rules. Operation is subject to the following two conditions:
(1) This device may not cause harmful interference, and (2) This device must accept any interference received, including interference that may cause undesired operation.

Declaration of Conformity

We, Sony Ericsson Mobile Communications AB of Nya Vattentomet SE-221 88 Lund, Sweden declare under our sole responsibility that our product Sony Ericsson type AAD-3022081-BV and in combination with our accessories, to which this declaration relates is in conformity with the appropriate standards 3GPP TS 51.010-1, EN 301908-1, EN 301489-7, EN 301489-24, EN 300328, EN 301489-17 and EN 60950, following the provisions of, Radio Equipment and Telecommunication Terminal Equipment directive 99/5/EC with requirements covering EMC directive 89/336/EEC, and Low Voltage directive 73/23/EEC.

Lund, May 2007

CE 0682

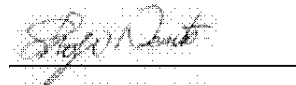

Shoji Nemoto,
Head of Product Business Group GSM/UMTS

We fulfill the requirements of the R&TTE Directive (99/5/EC).

Index

- A**
- activity menu 16
 - alarms 60
 - answering service 24
 - applications 51
 - appointments 60
 - assembly 5
 - automatic redialing 19
- B**
- battery
 - inserting and charging 7
 - use and care 73
 - Bluetooth™ wireless technology 55
 - business cards 30
 - buttons 11, 14
- C**
- calculator 63
 - calendar 60–61
 - call forward 26
 - call list 24
 - call numbers in message 32
 - call time 30
 - caller-specific ringtones 22
 - calls
 - accepting 28
 - answering and rejecting 6, 20
- handling two calls 27
- international 19
- making and receiving 6, 19
- putting on hold 27
- recording 50
- video 21
- camera
 - overview 40
 - settings 40
- code memo 63
- conference calls 28
- contacts
 - adding phone contacts 21
 - default contacts 21
 - groups of 23
 - synchronizing 54
- D**
- date 65
 - declaration of conformity 79
 - Disc2Phone 45
 - downloading files 53
- E**
- email 35
 - entering text 18
 - multitap 18
 - T9™ Text Input 18



F	
file manager	16
fixed dialing	29

G	
games	50
groups	23

H	
handsfree	25, 44
Bluetooth	56
help	6

I	
IMEI number	66
Internet	
bookmarks	52
profiles	53
security and certificates	53
settings	52

J	
Java™	51

K	
keypad lock	66
keys	11, 14

L	
Limited Warranty	76
lock	
keypad	66
phone	66
SIM card	65

M	
magic word	25
master reset	67
memory card	16
memory status	23
menu overview	11
menus	14
messages	
area and cell information	39
email	35
voice	34
microphone	20
music	
transferring	45
video files	44
music player	44
MusicDJ™	49
My friends	37
my numbers	28

N	
navigating menus	14
notes	62–63





P			
phone		settings	
language	18	Internet	52
lock	66	Java™	51
PhotoDJ™	43	shortcuts	15
pictures	42	SIM card	
edit	43	copying to/from	22
PIN code		lock and unblock	65
changing	65	sound recorder	50
unlocking	6	sound, transferring and directing	56
playlists	46	speed dialing	24
PlayNow™	48	standby	6
profiles	64	startup screen	6
PUK	6, 65	stopwatch	63
push email	37	submenus	14
		synchronizing	54–55
R		T	
ringtones	48–49	tasks	62
RSS reader	54	templates	34
S		themes	43–49
safety guidelines	72	time	65
sending		timer	63
appointments and tasks	61	transfer method	
business cards	30	Bluetooth	55
melodies and ringtones	49	USB	57
music	45	transferring	
notes	63	camera pictures	41
pictures	42	files	57
		music	45





turning on/off

- Bluetooth 55
- phone lock 66
- SIM lock protection 65

U

- unblock SIM card 65



V



- video player 44
- video recorder 39
- VideoDJ™ 49
- voice answering 26
- voice control 25
- voice messages 34
- voicemail 24
- volume
 - ear speaker 20
 - ringtone 48



Z

- zoom 40



Preflighted by  Summers Berfings ( polish)  PASSIO

Preflighted by  Summers Berfings ( polina)  PASSIO

Preflighted by  Summers Berfings ( polina)  PASSIO