

Congratulations on your purchase of the Sony Ericsson Z550. In addition to the pre-installed Z550 multimedia content, you have more waiting for you at www.sonyericsson.com/fun.

If you register at www.sonyericsson.com/register, you get an exclusive offer. Don't miss out. Go there now.

Added dimensions – Accessories from Sony Ericsson



Stereo Portable Handsfree HPM-61
Deep bass with light in-ear design.



Desk Stand CDS-60
Your phone's best assistant: connect a USB cable, charger and portable handsfree.



Bluetooth™ Headset HPB-PV705
A powerful Bluetooth™ headset with compact design.

Contents

Getting started	4
Getting to know the phone	7
Calling	13
Messaging	24
Imaging	28
Entertainment	31
Connectivity	35
More features	40
Troubleshooting	44
Important information	46
Index	55

www.sonyericsson.com/support

At Sony Ericsson Product Support, you can find troubleshooting, tips & tricks, software, phone settings for Internet browsing, messaging and much more.

Sony Ericsson

GSM 900/1800/1900

This user guide is published by Sony Ericsson Mobile Communications AB, without any warranty. Improvements and changes to this user guide necessitated by typographical errors, inaccuracies of current information, or improvements to programs and/or equipment, may be made by Sony Ericsson Mobile Communications AB at any time and without notice. Such changes will, however, be incorporated into new editions of this user guide. All rights reserved.

©Sony Ericsson Mobile Communications AB, 2006
Publication number: EN/LZT 108 8652 R2A

Please note: Some of the services in this user guide are not supported by all networks. This also applies to the GSM International Emergency Number 112.

Please contact your network operator or service provider if you are in doubt whether you can use a particular service or not.

Please read the Guidelines for safe and efficient use and the Limited warranty chapters before you use your mobile phone.

Your mobile phone has the capability to download, store and forward additional content, e.g. ringtones. The use of such content may be restricted or prohibited by rights of third parties, including but not limited to restriction under applicable copyright laws. You, and not Sony Ericsson, are entirely responsible for additional content that you download to or forward from your mobile phone. Prior to your use of any additional content, please verify that your intended use is properly licensed or is otherwise authorized. Sony Ericsson does not guarantee the accuracy, integrity or quality of any additional content or any other third party content. Under no circumstances will Sony Ericsson be liable in any way for your improper use of additional content or other third party content.

QuickShare™, PlayNow™, MusicDJ™, PhotoDJ™, VideoDJ™ and Style Up™ are trademarks or registered trademarks of Sony Ericsson Mobile Communications AB.

The Bluetooth word mark and logos are owned by the Bluetooth SIG, Inc. and any use of such marks by Sony Ericsson is under license.

Memory Stick™ and Memory Stick Micro™ (M2™) are trademarks or registered trademarks of Sony corporation.

Microsoft, Windows and PowerPoint are either registered trademarks or trademarks of Microsoft Corporation in the U.S and other countries/regions.

Mac OS is a trademark of Apple Computer, Inc., registered in the U.S. and other countries.

T9™ Text Input is a trademark or a registered trademark of Tegic Communications.

T9™ Text Input is licensed under one or more of the following: U.S. Pat. Nos. 5,818,437, 5,953,541, 5,187,480, 5,945,928, and 6,011,554; Canadian Pat. No. 1,331,057, United Kingdom Pat. No. 2238414B; Hong Kong Standard Pat. No. HK0940329; Republic of Singapore Pat. No. 51383; Euro.Pat. No. 0 842 463(96927260.8) DE/DK, FI, FR, IT, NL, PT, ES, SE, GB; and additional patents are pending worldwide.

Java and all Java based trademarks and logos are trademarks or registered trademarks of Sun Microsystems, Inc. in the U.S. and other countries. End-user license agreement for Sun™ Java™ JME™.

- 1 Restrictions: Software is confidential copyrighted information of Sun and title to all copies is retained by Sun and/or its licensors. Customer shall not modify, decompile, disassemble, decrypt, extract, or otherwise reverse engineer Software. Software may not be leased, assigned, or sublicensed, in whole or in part.
- 2 Export Regulations: Software, including technical data, is subject to U.S. export control laws, including the U.S. Export Administration Act and its associated regulations, and may be subject to export or import regulations in other countries. Customer agrees to comply strictly with all such regulations and acknowledges that it has the responsibility to obtain licenses to export, re-export, or import Software. Software may not be downloaded, or otherwise exported or re-exported (i) into, or to a national or resident of, Cuba, Iraq, Iran, North Korea, Libya, Sudan, Syria (as such listing may be revised from time to time) or any country to which the U.S. has embargoed goods; or (ii) to anyone on the U.S. Treasury Department's list of Specially Designated Nations or the U.S. Commerce Department's Table of Denial Orders.

- 3 Restricted Rights: Use, duplication or disclosure by the United States government is subject to the restrictions as set forth in the Rights in Technical Data and Computer Software Clauses in DFARS 252.227-7013(c) (1) (ii) and FAR 52.227-19(c) (2) as applicable.

Part of the software in this product is copyright © SyncML initiative Ltd. (1999-2002). All rights reserved.

Other product and company names mentioned herein may be the trademarks of their respective owners. Any rights not expressly granted herein are reserved.

User guide symbols

The following instruction symbols appear in this user guide:

- ▶ Use the navigation key to scroll and select ➤ *10 Navigating the menus.*
- ⦿ Press the navigation key centre.
- ⦿ Press the navigation key up.
- ⦿ Press the navigation key down.
- ⦿ Press the navigation key to the left.
- ⦿ Press the navigation key to the right.
- See also page ...



Note



Indicates that a service or function is network- or subscription-dependent. Because of this, all menus may not be available in your phone. Consult your network operator for more information.

Getting started

To insert the SIM card

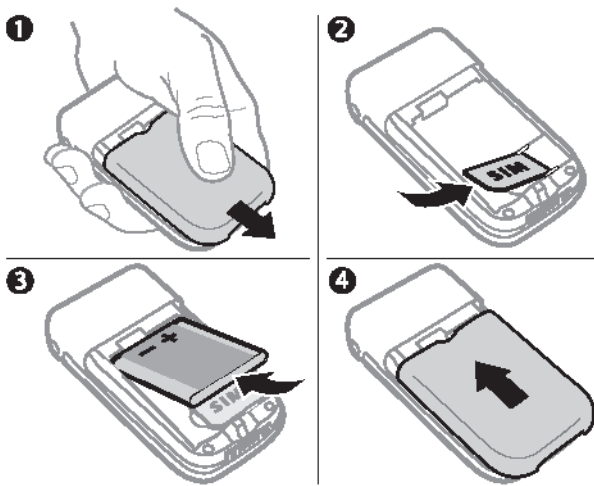

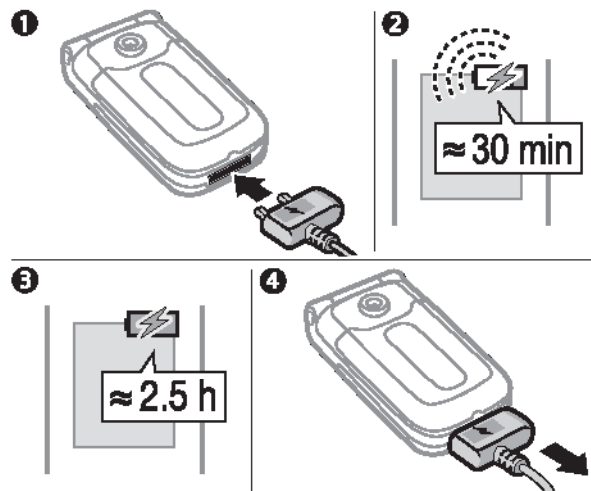

- 1 Remove the battery cover.
- 2 Slide the SIM card into its holder with the gold contacts facing down.
- 3 Insert the battery with the label side up and the connectors facing in.
- 4 Slide the battery cover into place.

To charge the battery



- 1 Connect the charger plug to the phone with the symbol facing upwards.
- 2 It may take 30 minutes for the battery icon to appear.
- 3 Wait approximately 2.5 hours or until the battery icon indicates that the battery is fully charged. For an indication of charging, press  to activate the screen.
- 4 Remove the charger by pulling it out.

 *Talk-time or standby time may become noticeably shorter due to wear and you may have to replace your battery. Only use approved batteries from Sony Ericsson ➤ 49 Battery.*

 *Save contacts to your SIM card before you remove it from another phone. Contacts may have been saved in the phone memory ➤ 14 Contacts.*

To turn the phone on and off



- 1 Press and hold .
- 2 Enter your SIM card PIN, if you have one.
- 3 At first start-up, select the language for phone menus.

- 4 ▶ Yes if you want the setup wizard to help you with instructions and tips. The setup wizard is also available in the menu system ▶ Settings ▶ General ▶ Setup wizard.

To make and receive calls

- 1 Enter the area code and phone number ▶ Call to make the call.
- 2 ▶ End call to end the call. When the phone rings ▶ Answer to answer the call. For more information ➤ 13 Making and receiving calls.

Memory Stick Micro™ (M2™)

Use a memory card to save, for example, pictures.

 *Your phone does not come with a memory card. You can buy a memory card to add more storage space to your phone.*

If you use a memory card you can select to automatically store all pictures on the memory card ➤ 29 Camera options.

PIN

You may need a PIN (Personal Identification Number) from your network operator to activate the services in your phone. Each PIN digit appears as *, unless it starts

with emergency number digits, for example 112 or 911. The reason for this is to always let you make emergency calls. ➔ *14 Emergency calls*. Press **⌂** to correct mistakes.

💡 *If you enter the wrong PIN three times in a row, the SIM card is blocked ➔ 42 SIM card lock.*

Standby mode

After you have turned the phone on and entered your PIN, the name of the network operator will appear on the display. This is called standby mode.

To insert and remove the memory card

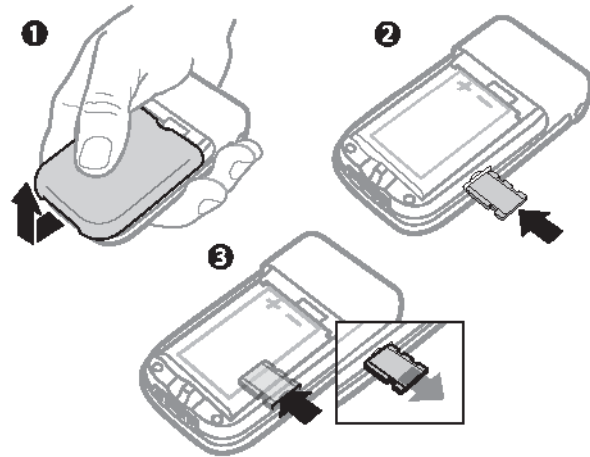

- 1 Remove the battery cover.
- 2 Insert the memory card in the slot.
- 3 Press the edge of the memory card to release it from the slot.

Getting to know the phone

Phone overview

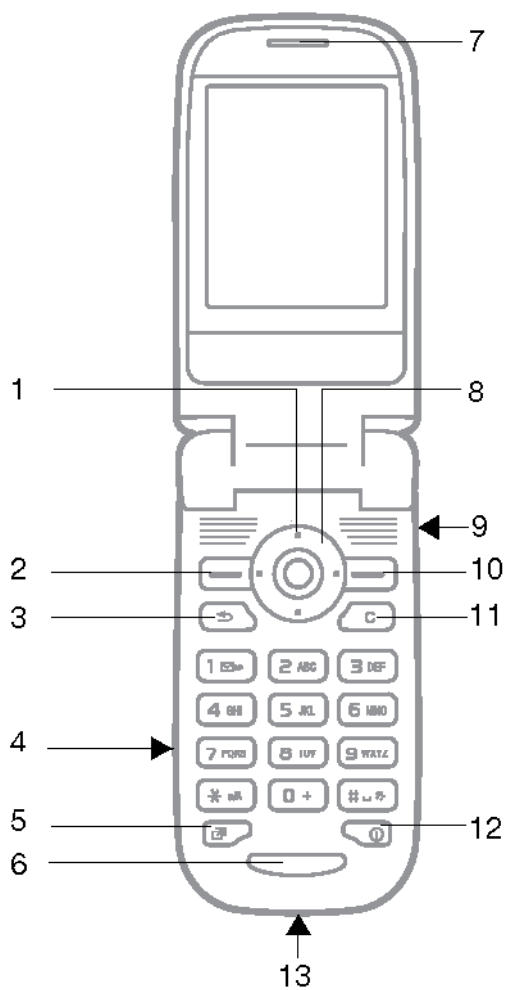

- | | |
|----|------------------------------|
| 1 | Camera key |
| 2 | Selection key |
| 3 | Back key |
| 4 | Memory Stick Micro (M2) slot |
| 5 | Activity menu key |
| 6 | Microphone |
| 7 | Earpiece |
| 8 | Navigation key |
| 9 | Volume button |
| 10 | Selection key |
| 11 | Clear key |
| 12 | On/off key |
| 13 | Charger and USB connector |

Menu overview



PlayNow™*



Internet services*



Entertainment

Online services*
Games
VideoDJ™
PhotoDJ™
MusicDJ™
Remote control
Record sound
Demo tour



Camera



Messaging

Write new
Inbox
My friends*
Email
Call voicemail
Drafts
Outbox
Sent messages
Saved messages
Templates
Settings



Media player



File manager***



All files



On Memory Stick



In phone



Contacts**

Options
New contact



Radio







Calls***



Organizer



Settings***

-  All
-  Answered
-  Dialed
-  Missed

- Alarms
- Calendar
- Tasks
- Notes
- Calculator
- Synchronization
- Timer
- Stopwatch
- Applications
- Code memo

-  General
-  Sounds & alerts
-  Display
-  Calls
-  Connectivity*







* Some menus are operator-, network- and subscription-dependent.







** Options when phone contacts are set to default. Options change when SIM contacts are set to default.

*** Use the navigation key right and left to move between tabs in submenus. For more information

➔ 10 Navigating the menus.

Status bar icons

-  Tells you the strength of the GSM network signal.
-  Tells you the status of the battery.
-  Tells you the status of the battery charging.
-  You have missed an incoming call.
-  Call and messaging function alerts are off, alarm is still on.
-  You have received a text message.
-  You have received an email message.

-  You have received a picture message.
-  You have an ongoing call.
-  You have an appointment reminder.
-  You have a task reminder.
-  The magic word is activated.
-  Handsfree is connected.
-  Radio playing in the background.

Navigating the menus

The main menus are shown as icons on the desktop. Some submenus include tabs that appear on the screen.



- Press to go to the desktop or to select items.
- Press , , or to move through menus and tabs.
- Press to go back one level in the menus or to end a function or application. Press and hold to return to standby.
- Press to select the options shown immediately above these keys on the screen.
- Press to delete items.
- Scroll to a menu item **Info** to get help on selected features.
- **More** to enter a list of options.

Shortcuts

From standby, you can use , , or to go directly to a function.

To create a standby shortcut

- 1 Press and follow the instructions.
- 2 Scroll to a function **Shortcut**.

To edit a standby shortcut

- 1 **Settings** **General** **Shortcuts** and select an shortcut **Edit**.
- 2 Scroll to a function **Shortcut**.

Activity menu

Use the activity menu to view and handle new events, and access bookmarks and shortcuts.

To open the activity menu

Press and use and to select a tab.

Activity menu tabs

- **New events** – such as missed calls and messages.
- **My shortcuts** – applications that are running in the background and your shortcuts. You can add, delete and change the order of shortcuts.
- **Bookmarks** – your Internet bookmarks.

If you want new events to appear as pop-up text instead of in the activity menu **Settings** **General** **New events** **Popup**.

Shut down menu

Use the shut down menu to shut down the phone, turn on silent or activate a profile. For more information about profiles ► *40 Profiles*.

To open the shut down menu

Press  and select a menu item.

File manager

Files such as pictures, videos, sounds, themes, games and applications are saved in folders in the phone memory. If you have a memory card inserted you can save the files on the memory card. Unrecognized files are saved in the **Other** folder.

File manager menu tabs

The file manager is divided into three tabs, and icons indicate where the files are saved.

- **All files** – all content in the phone and on the memory card.
- **On Memory Stick** – all content on the memory card.
- **In phone** – all content in the phone memory.

File information

If a file is protected, you may not be able to copy or send the file. View file information by highlighting the file ► **More** ► **Information**.

To move or copy a file

- 1 ► **File manager**. Select a folder and scroll to a file ► **More** ► **Manage files**.
- 2 Select **Move** or **Copy**.
- 3 ► **Memory Stick** or ► **Phone memory**.
- 4 Select a folder or ► **New folder** name the folder ► **OK**.
- 5 ► **Paste**.

To select several files

- 1 ► **File manager**. Select a folder and scroll to a file ► **More** ► **Mark**.
- 2 ► **Mark several** or **Mark all**. To select files, scroll and ► **Mark** or **Unmark**.

To check memory status

► **File manager** ► **More** ► **Memory status**.

Formatting the memory card

Format a memory card if you want to delete all information from it, or if it has been corrupted.

To format the memory card

- ▶ File manager ▶ More ▶ Format M.S.
 - ▶ Yes and enter your phone lock code.
- For more information ➡ *43 Phone lock*.

Transferring files

For more information ➡ *39 Transferring files*.

Languages

Select the language for phone menus and for writing.

To change the phone language

- ▶ Settings ▶ General ▶ Language ▶ Phone language, select a language.
- From standby, Press **0000** for English, or press **8888** for Automatic language.

To select writing languages

- ▶ Settings ▶ General ▶ Language ▶ Writing language.
- ▶ Mark to select languages ▶ Save.

Entering letters

Scroll to a function where text input is possible, for example, ▶ Messaging ▶ Write new ▶ Text message.

To enter letters using multitap text input

- Press **2** – **9** until the desired character appears.
- Press ***aA** to shift between capitals and lower case letters.
- Press and hold **0+** – **9** to enter numbers.
- Press **C** to delete letters and numbers.
- Press **#-#** to add a space.
- Press **1** for the most common punctuation marks.
- Press and hold ***aA** to change writing method.

T9™ Text Input

The T9™ Text Input method uses a built-in dictionary to recognize the most commonly used word for each sequence of key presses. This way, you press each key only once, even if the letter you want is not the first letter on the key.

To enter letters using T9 Text Input

- For example, if you want to write the word “Jane”, press **5**, **2**, **6**, **3**.
- If the word shown is not the one you want, press **0** or **0** repeatedly to view alternative words. To accept and add a space, press **#-#**. To accept a word without adding a space, press **0**.

- Continue writing your message. To enter punctuation marks, press **[1]** and then **[Ⓢ]** or **[Ⓣ]** repeatedly.

To add words to the T9 Text Input dictionary

- While entering letters ► **More** ► **Spell word**.
- Edit the word by using multitap input. Navigate between the letters with **[Ⓢ]** and **[Ⓣ]**. To delete a character, press **[C]**. To delete the entire word, press and hold **[C]**.
- When you have edited the word ► **Insert**. The word is added to the T9 Text Input dictionary. Next time you enter this word using T9 Text Input, it will appear as one of the alternative words.

To select another writing method

Before, or while entering letters, press and hold **[*#0]** to select another writing method.

Options when entering letters

► **More** to view options when entering letters.

Calling

Making and receiving calls

Turn on the phone and make sure that you are within range of a network ► **5 To turn the phone on and off**. If your subscription includes the Calling Line Identification service and the caller's number is identified, the number is displayed. If the number is saved in **Contacts**, the name, number, and picture are displayed. If the number is a restricted number, **Withheld** is displayed.

To make a call

Enter the phone number (with international country code and area code, if applicable) ► **Call** to make the call. ► **End call** to end the call.

To redial a number

If the connection failed, **Retry?** is displayed ► **Yes**.



Do not hold the phone to your ear while waiting. When a call connects, the phone gives a loud signal.

To answer a call

Open your phone or ► **Answer** if your phone is already open.

To reject a call

Close your phone ► **Busy** or quickly press twice on the volume button.

To change the ear speaker volume

During a call, press **+** or **-** to increase or decrease the volume.

To turn off the microphone

Press and hold **(M)**. To resume, press and hold **(G)** again.

To select more options during a call

► **More** and select an option.

Missed calls

A missed call appears in the Activity menu if **New events** is set to **Activity menu** ► **10 Activity menu**. ► **Call** to call the missed number.

If **New events** is set to **Popup**, **Missed calls**: appears. ► **Yes** to view the missed calls or ► **No** to do it later.

Call list

Information about the last calls is saved in the call list.

To call a number from the call list

► **Calls** from standby and select a tab. Scroll to a name or number you want to call ► **Call**.

To add a call list number to contacts

- 1 ► **Calls** from standby and select a tab. Scroll to the number you want to add ► **More** ► **Save number**.
- 2 Select a contact to add the number to or ► **New contact**.

Emergency calls

Your phone supports the international emergency numbers, for example, 112 and 911. These numbers can normally be used to make an emergency call in any country, with or without a SIM card inserted, if a GSM network is in range.



In some countries, other emergency numbers may also be promoted. Your network operator may have saved additional local emergency numbers on the SIM card.

To make an emergency call

Enter, for example, 112 ► **Call**.

To view your local emergency numbers

► **Contacts** ► **Options** ► **Special numbers** ► **Emergency nos.**

Contacts

Phone contacts contain detailed information saved in the phone memory. **SIM contacts** contain names and numbers saved on the SIM card.

To select default contacts

- 1 ► Contacts ► Options ► Advanced ► Default contacts.
- 2 ► Phone contacts or SIM contacts.

To add a contact

- 1 ► Contacts ► New contact ► Add.
- 2 ► Name: ► Add enter the name ► OK.
- 3 ► New number: ► Add enter the number ► OK.
- 4 For phone contacts only, select a number type. Scroll between tabs and select fields to enter more information. To enter symbols such as @ ► More ► Add symbol and select the symbol ► Insert. To save the contact ► Save.

 *Enter the + sign and country code with all numbers.*

To add a picture or a ringtone to a contact

- 1 ► Contacts and select the contact ► More ► Edit contact.
- 2 Select the relevant tab, then ► Picture or Ringtone ► Add. Select a file and ► Save.

To set the default number for a contact

To set the phone number to be displayed first for a contact ► Contacts and scroll to the contact ► More ► Default number and select a number.



To add your own business card

► Contacts ► Options ► My business card and enter the information for your business card ► Save.

To send your business card

► Contacts ► Options ► My business card ► Send my card.

To call a phone contact

► Contacts. Enter the first letters of the contact you want to call. Use  or  to select a number ► Call.

To call a SIM contact

- If SIM contacts is default ► Contacts select the name and number from the list ► Call.
- If Phone contacts is default ► Contacts ► Options ► SIM contacts select the name and number from the list ► Call.

Managing contacts

Copy contacts to and from the phone memory and the SIM card.

To copy names and numbers to the SIM card

- 1 ► Contacts ► Options ► Advanced ► Copy to SIM.
- 2 ► Copy all or Copy a number.

 *When copying all contacts from the phone to the SIM card, all existing SIM card information is replaced.*

To copy SIM contacts to phone contacts

- 1 ▶ Contacts ▶ Options ▶ Advanced ▶ Copy from SIM.
- 2 ▶ Copy all or Copy a number.

To automatically save to the SIM card

- 1 ▶ Contacts ▶ Options ▶ Advanced ▶ Auto save on SIM.
- 2 ▶ On.

To back up contacts on memory card

- ▶ Contacts ▶ Options ▶ Advanced ▶ Back up to M.S. ▶ Yes.

To restore contacts from memory card

- ▶ Contacts ▶ Options ▶ Advanced ▶ Restore from M.S. ▶ Yes ▶ Yes.

To send contacts

- To send a selected contact ▶ More ▶ Send contact and select a transfer method.
- To send all contacts ▶ Contacts ▶ Options ▶ Advanced ▶ Send all contacts.

To edit a phone contact

- 1 ▶ Contacts and select a contact ▶ More ▶ Edit contact.
- 2 Select a tab and edit the information ▶ Save.

To edit a SIM contact

- 1 If SIM contacts is default ▶ Contacts or if Phone contacts is default ▶ Contacts ▶ Options ▶ SIM contacts.
- 2 Select the name and number you want to edit.
- 3 ▶ More ▶ Edit contact and edit the name and number.

To delete contacts

- To delete a selected contact, press .
- To delete all contacts ▶ Contacts ▶ Options ▶ Advanced ▶ Delete all contacts ▶ Yes and ▶ Yes. Names and numbers on the SIM card are not deleted.

To check the memory status

- ▶ Contacts ▶ Options ▶ Advanced ▶ Memory status.

 *The number of entries you can save in the phone or on the SIM card depends on the available memory.*

Synchronizing contacts

For more information see
www.sonyericsson.com/support.

Speed dialling

Save phone numbers that you want to reach easily in positions 1-9 in your phone.

To set or replace speed dialling numbers

- 1 ► **Contacts** ► **Options** ► **Speed dial**.
- 2 Scroll to a position ► **Add or Replace** and select a phone number.

To speed dial

From standby, enter a speed dial number (1-9) ► **Call**.

Voicemail

If your subscription includes an answering service, callers can leave a voice message when you cannot answer a call.

To enter your voicemail number

Press and hold **1** ► **Yes** enter the number ► **OK**. You get the number from your service provider.

To call your voicemail service

If you have entered your voicemail number, press and hold **1**.

To check your voicemail number

► **Messaging** ► **Settings** ► **Voicemail number**.

Voice control



Manage calls with your voice by creating voice commands to:

- Voice dial – call someone by saying their name.
- Activate voice control by saying a “magic word”.
- Answer and reject calls when using a handsfree.

Before voice dialling

Activate the voice dialling function and record your voice commands. An icon appears next to a phone number that has a voice command.

To activate voice dialling and record names

- 1 ► **Settings** ► **General** ► **Voice control** ► **Voice dialling** ► **Activate** ► **Yes** ► **New voice** and select a contact.
- 2 If the contact has more than one number, use  and  to view the numbers. Select the number to add the voice command to. Record a voice command such as “John mobile”.

- 3 Instructions appear. Wait for the tone and say the command to record. The voice command is played back to you.
- 4 If the recording sounds OK ► **Yes**. If not ► **No** and repeat step 3.
To record another voice command for a contact ► **New voice** ► **Add** and repeat steps 2-4 above.

Caller name

Hear your recorded contact name when you receive a call from that contact.

To turn the caller name on or off

- **Settings** ► **General** ► **Voice control**
- **Play caller name**.

Voice dialling

Start voice dialling from standby using the phone, a portable handsfree, a Bluetooth™ headset or by saying your magic word.

To make a call

- 1 From standby, press and hold one of the volume buttons.
- 2 Wait for the tone and say a recorded name, for example "John mobile". The name is played back to you and the call is connected.

To make a call with a handsfree

From standby, press and hold the handsfree button, or press the Bluetooth headset button.

The magic word

Record and use a voice command as a magic word to activate voice control without pressing any keys. The magic word can only be used with a handsfree or a Bluetooth headset.



Choose a long, unusual word or phrase that can easily be distinguished from ordinary background speech.

To activate and record the magic word

- 1 ► **Settings** ► **General** ► **Voice control** ► **Magic word** ► **Activate**.
- 2 Instructions appear. ► **Continue**. Wait for the tone and say the magic word.
- 3 ► **Yes** to accept or ► **No** to record a new magic word.
- 4 Instructions appear. ► **Continue** and select the environments in which your magic word is to be activated.

Voice answering

Answer or reject incoming calls by using your voice, when using a handsfree.

 *You can use a MIDI, WAV (16 kHz), EMY or IMY file as a ringtone with voice answering.*

To activate voice answering and record voice answer commands

- 1 ► Settings ► General ► Voice control ► Voice answer ► Activate.
- 2 Instructions appear. ► Continue. Wait for the tone and say "Answer", or another word.
- 3 ► Yes to accept or ► No for a new recording.
- 4 Instructions appear ► Continue. Wait for the tone and say "Busy", or another word.
- 5 ► Yes to accept or ► No for a new recording.
- 6 Instructions appear. ► Continue and select the environments in which voice answering is to be activated ► Save.

To answer or reject a call using voice commands

When the phone rings, say:

- "Answer" to connect the call.
- "Busy" to reject the call.

To edit your voice commands

- 1 ► Contacts and scroll to a contact.
- 2 ► More ► Edit contact and scroll to the relevant tab.

To re-record a voice command

- 1 ► Settings ► General ► Voice control ► Voice dialling ► Edit names.
- 2 Select a command ► More ► Replace voice.
- 3 Wait for the tone and say the command.

Diverting calls

Divert calls, for example, to an answering service.

 *When the Restrict calls function is activated, some Divert calls options are not available.*

To activate a call divert

- 1 ► Settings ► Calls ► Divert calls.
- 2 Select a call type and divert option ► Activate.
- 3 Enter the phone number to divert your calls to ► OK, or ► Look up to select a contact.

To deactivate a call divert

Scroll to the divert option ► Deactivate.

To check all divert options

- ▶ Settings ▶ Calls ▶ Divert calls
- ▶ Check all.



More than one call

Handle more than one call simultaneously.

Call waiting service

When activated, you hear a beep if you receive a second call.

To activate the call waiting service

- ▶ Settings ▶ Calls ▶ Manage calls
- ▶ Call waiting ▶ Activate.

To make a second call

- ▶ More ▶ Hold to hold the ongoing call. Enter the number you want to call
- ▶ Call.

Receiving a second call

When you receive a second call, you can:

- ▶ Answer and put the ongoing call on hold.
- ▶ Busy to reject and continue the ongoing call.
- ▶ Replace active call to answer and to end the ongoing call.

Handling two calls

If you have an ongoing call and a call on hold, you can:

- ▶ More ▶ Switch to switch between the two calls.
- ▶ More ▶ Join calls to join the two calls.
- ▶ More ▶ Transfer call, to connect the two calls. You are disconnected from both calls.



Contact your network operator to check if this function is supported.

- ▶ End call ▶ Yes to retrieve the held call.
- ▶ End call ▶ No to end both calls (operator-dependent).
You cannot answer a third call without ending one of the first two calls or joining them into a conference call.



Conference calls

Start a conference call by joining an ongoing call and a call on hold. Put the conference on hold to call and add up to five participants or just to make another call.

To join the two calls into a conference call

- ▶ More ▶ Join calls.

To add a new participant

- 1 ► **More** ► Hold to put the joined calls on hold.
- 2 ► **More** ► **Add call** and call the next person.
- 3 ► **More** ► **Join calls**.
- 4 Repeat the procedure to include more participants.

To release a participant

- **More** ► **Release part.** and select the participant.

To have a private conversation

- 1 ► **More** ► Talk to and select the participant.
- 2 ► **More** ► **Join calls** to resume the conference call.



Two voice lines

Make separate calls with different phone numbers if your subscription supports alternate line service.

To select a line

- **Settings** ► **Calls** and select line 1 or 2.

To change the name of a line

- **Settings** ► **Display** ► **Edit line names** and select one of the lines to edit the name.

My numbers

View, add and edit your own phone numbers.

To check your phone numbers

- **Contacts** ► **Options** ► **Special numbers** ► **My numbers** and select one of the options.

Accept calls

Only receive calls from certain phone numbers. If the divert calls option **When busy** is activated, calls are diverted.

To add numbers to the accepted callers list

- **Settings** ► **Calls** ► **Manage calls** ► **Accept calls** ► **Only from list** ► **Edit** ► **Add**. Select a contact or ► **Groups** ► **23 Groups**.

To accept all calls

- **Settings** ► **Calls** ► **Manage calls** ► **Accept calls** ► **All callers**.



Restricted dialling

Restrict outgoing and incoming calls. A password from your service provider is required.



If you divert incoming calls, you cannot activate some restrict calls options.

The following calls can be restricted:

- **All outgoing** – all outgoing calls.
- **Outgoing intl** – all outgoing international calls.
- **Outgoing intl roam.** – all outgoing international calls except to your home country.
- **All incoming** – all incoming calls.
- **Inc. when roaming** – all incoming calls when you are abroad.

To activate or deactivate a call restriction

- 1 ► **Settings** ► **Calls** ► **Manage calls** ► **Restrict calls**. Select an option.
- 2 ► **Activate** or **Deactivate**, enter your password ► **OK**.



Call time and cost

During a call, the duration of the call is shown. You can check the duration of your last call, outgoing calls and the total time of your calls.

To check the call time

- **Settings** ► **Calls** ► **Time & cost**
- **Call timers**.

Additional calling functions

Tone signals

Use telephone banking services or control an answering machine with tone signals during a call.

To use tone signals

- Press **[+] - [9]**, **[*11]** or **[*12]** to send tones.
- ► **More** ► **Disable tones** or **Enable tones** to turn the tones on or off during a call.
- Press **[E]** to clear the screen after a call.

Notepad

Use the screen as a notepad to enter a phone number during a call. When you end the call, the number remains on the screen for you to call or save in your contacts.

To call or save from the notepad

- ► **Call** to call the number or
- ► **More** ► **Save number** and create a new contact or select a contact to save the number to.

Groups

Create a group of numbers and email addresses to send messages to several recipients at the same time ➡ *24 Messaging*. You can also use groups (with numbers) when you create accepted callers lists ➡ *21 Accept calls*.

To create a group of numbers and email addresses

- 1 ▶ **Contacts** ▶ **Options** ▶ **Groups** ▶ **New group** ▶ **Add**.
- 2 Enter a name for the group ▶ **Continue**.
- 3 ▶ **New** ▶ **Add** to find and select a contact number or email address.
- 4 Repeat step 3 to add more numbers or email addresses. ▶ **Done**.

Closed user groups

If your network supports closed user groups, you may be able to call at lower costs. You can save up to ten groups. An index number is required from your network operator.

To add a group

▶ **Settings** ▶ **Calls** ▶ **Manage calls** ▶ **Closed groups** ▶ **Edit list** ▶ **New group** ▶ **Add**. Enter the name of the user group ▶ **Continue**. Enter the index number ▶ **Save**.

To call outside a closed user group

▶ **Settings** ▶ **Calls** ▶ **Manage calls** ▶ **Closed groups** ▶ **Open calls** ▶ **On**. To only call within the group ▶ **Off**.

Showing or hiding your number

If your subscription supports the Calling Line Identification Restriction (CLIR) service, you can hide your phone number when making a call.

To always show or hide your phone number

- 1 ▶ **Settings** ▶ **Calls** ▶ **Show/hide my no.**
- 2 ▶ **Show number**, **Hide number** or **Network default**.

Messaging

Your phone supports various messaging services. Contact your service provider about the services you can use, or for more information see www.sonyericsson.com/support.

 *If you send a message to a group, you are charged for each member of that group.*

Text messaging (SMS)

Text messages can contain simple pictures, animations, melodies and sound effects.

Before you start

A service centre number is provided by your network operator to send and receive text messages. It may already be saved on the SIM card or you can add the number yourself.

To set the service centre number

- 1 ► **Messaging** ► **Settings** ► **Text message** ► **Service centre**. The number is shown if it is saved on the SIM card.
- 2 If there is no number ► **New ServiceCentre** and enter the number, including the international “+” sign and country code ► **Save**.

To write and send a text message

- 1 ► **Messaging** ► **Write new** ► **Text message**.
- 2 Write your message. To insert an item in your message ► **More** ► **Add item**.
- 3 ► **Continue**. (To save in Drafts press  and ► **Yes**.)
- 4 ► **Enter phone no.** or **Contacts** look-up to enter a recipient.
- 5 To change the options for your message, when a recipient is selected ► **More** ► **Advanced** select an option ► **Edit** and select a setting ► **Done** ► **Send**.

 *You can convert your text message to a picture message. While writing ► **More** ► **To picture msg**.*

To check the delivery status of a sent message

- **Messaging** ► **Sent messages** and select a message ► **View** ► **More** ► **Details**.

Receiving messages

When you receive a text message or an automatically downloaded picture message, it appears in the Activity menu or as a popup ► **10 Activity menu**.

Press  to close the message.

To call a number in a message

Select the phone number displayed in the message ► **Call**.

To save an item in a text message

- 1 Select the item displayed in the message ► **More**.
- 2 ► **Use** to save a phone number, or **Save picture** to save a picture, or **Save bookmark** to save a Web address.

To save messages

- To save a selected message ► **More** ► **Save message** ► **Saved messages** (SIM card) or **Templates** (phone).
- To save several messages in a folder ► **More** ► **Mark several** ► **Mark** to select messages. ► **More** ► **Save messages**.

To delete messages

- To delete a selected message, press **C**.
- To delete several messages in a folder ► **More** ► **Delete all msgs** or **Mark several**. When marking several messages ► **Mark** to select messages. ► **More** ► **Delete messages**.

Long messages

The number of characters allowed in a text message depends on the writing

language. You can send a longer message by linking two or more messages. You are charged for each of the messages linked in a long message. You may not receive all parts of a long message at the same time.



Check with your service provider for the maximum number of messages that can be linked.

To turn on long messages

- **Messaging** ► **Settings** ► **Text message** ► **Max. msg length** ► **Max. available**.

Picture messaging (MMS)

Picture messages can contain text, pictures, video clips, camera pictures, sound recordings, and signatures. They are sent via MMS (Multimedia Messaging Service) to a mobile phone or via email.



Sending and receiving phones must have subscriptions that support picture messaging.

Before you start

If settings are not already in your phone ► **35 Settings**.

Creating and sending picture messages

Select to write text and add pictures, sounds, videos, more pages, a signature and attachments.

To create and send a picture message

- 1 ► **Messaging** ► **Write new** ► **Picture msg.**
- 2 ► **More** to add an item to the message.
- 3 Write text ► **OK**.
- 4 To send, continue as when sending a text message ► *24 To write and send a text message.*

 *You have the same options for picture messages as for text messages*
► *24 Text messaging (SMS).*

To create your own signature for picture messages

- 1 ► **Messaging** ► **Settings** ► **Picture message**.
- 2 ► **Signature** ► **New signature** and create your signature as a picture message.

To save an item in a picture message

- 1 While reading a message, select the item ► **More**.
- 2 Select **Use** to save a phone number, or **Save bookmark** to save a Web address, or **Save items** to save, for example, a picture or sound.

Automatic download

Select how to download your picture messages.

► **Messaging** ► **Settings** ► **Picture message** ► **Auto download** to select one of the following:

- **Always** – automatically download messages.
- **Ask in roaming** – ask to download other network messages.
- **Not in roaming** – do not download other network messages.
- **Always ask** – ask to download messages.
- **Off** – new messages appear in the inbox as icons. Select the message ► **View** to download.

Voice messages

Send and receive a sound recording as a voice message.

 *Sending and receiving phones must have subscriptions that support picture messaging.*

To record and send a voice message

- 1 ► **Messaging** ► **Write new** ► **Voice message**.
- 2 Record your message ► **Stop**.

- 3 ▶ **Send.** Continue as when sending a text message ➤ *24 To write and send a text message.*

Receiving voice messages

When you receive a voice message, it appears in the Activity menu or as a popup ➤ *10 Activity menu.*

Press  to close the message.

Email

Connect to a POP3 or IMAP4 mail server to send and receive email messages with your phone. You can use the same email settings in your phone as in your computer email program.

 *With a POP3 email account, messages are downloaded to each computer or device used for access. With an IMAP4 email account, messages can be kept on the server.*

Before you start

If settings are not already in your phone ➤ *35 Settings.*

To write and send an email message

- 1 ▶ **Messaging** ▶ **Email** ▶ **Write new.**
- 2 ▶ **Add** to enter the **To:** field. ▶ **Enter email addr.** or **Contacts look-up** to enter a recipient.
- 3 To add more recipients ▶ **To, Cc** or **Bcc.**
- 4 When finished selecting recipients ▶ **Done.**
- 5 Write the subject ▶ **OK.** Write the text ▶ **OK.**
- 6 To add an attachment ▶ **Add** and select the attachment ▶ **Done.**
- 7 ▶ **Continue.** ▶ **Send** or **More** to view options.

To receive and read email messages

▶ **Messaging** ▶ **Email** ▶ **Inbox.**

- 1 If the inbox is empty ▶ **Send&rec.** If the inbox is not empty ▶ **More** ▶ **Send & receive.**
- 2 Select a message ▶ **View** to read it.

To reply to an email message

- 1 Open the email message ▶ **Reply.**
- 2 ▶ **Write new** or **Include message.**
- 3 Write your message ▶ **OK** ▶ **Continue** ▶ **Send.**

To save an item or attachment in an email message

- To save an email address, a phone number or a Web address, select the item ▶ **More** and select to save the item.

- To save an attachment, select the message ► **More** ► **Attachments**. Select the attachment ► **More** and select an option.

To delete email messages

- To delete a selected message, press **G**.
- To delete several messages in a folder ► **More** ► **Mark several**. ► **Mark** to select messages. ► **More** ► **Delete messages**. The marked messages are deleted the next time you connect to your email server.

 *For IMAP4 users, ► More ► Clear inbox and select With send & rec. or No send & rec. to delete messages the next time you connect to the server.*

My friends

For more information, contact your service provider or see www.sonyericsson.com/support.



Imaging

Camera and video recorder

Your phone has a digital camera which also works as a digital video recorder. Take pictures and record video clips to save, send or use. Use a picture as a screen saver, wallpaper, start-up screen or for a contact ► **15 To add a picture or a ringtone to a contact**.

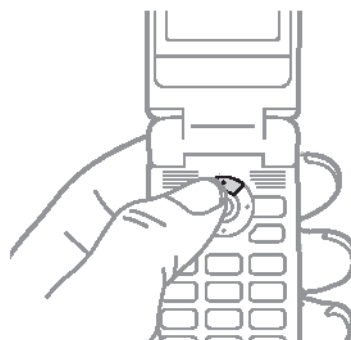

To take pictures and record video clips



- 1 Press  from standby to start the camera.
- 2 Press  or  to switch between video and photo.
- 3 ► **Capture** to take a picture.
► **Record** to start a video recording.

 *If you try to record a strong light source such as direct sunlight or a lamp, the screen may black out or the picture may be distorted.*

To use the zoom

Press  and  to zoom in and zoom out.

To adjust brightness

Use the volume button to increase or decrease brightness.

Camera options

When the camera is activated ► **More** to view options:

- **View all pictures.**
- **Shoot mode** – select **Normal** for no frame, **Panorama** to combine a few pictures into one wide picture, **Frames** to add a frame to your picture, or **Burst** to take a few pictures in rapid succession.
- **Picture size** – select **1280x1024**, **640x480**, **160x120**.
- **Night mode** – enhance picture quality in poor lighting conditions with longer exposure time.
- **Effects** – select different effects for your picture.
- **Self-timer** – the picture is taken a few seconds after you press the camera button.

- **Picture quality** – select **Normal** or **Fine** picture quality.
- **Shutter sound** – select different shutter sounds.
- **Reset file number** – reset the file number counter for pictures stored on the memory card.
- **Save to** – select **Memory Stick** or **Phone memory**.

Video options

When the video is activated ► **More** to view options:

- **View all clips.**
- **Shoot mode** – select **For picture msg** or **Hi-quality video**.
- **Video size** – select **Large 176x144** or **Small 128x96**.
- **Night mode** – enhance video quality in poor lighting conditions with longer exposure time.
- **Effects** – select different effects for your video.
- **Save to** – select **Memory Stick** or **Phone memory**.

Saving and sending pictures and video clips

The picture or the recorded video clip is saved in the phone memory or on the memory card. You can send the picture or video clip instantly in a picture message. To exchange

pictures and video clips using other transfer methods ➤ *30 Exchanging pictures and video clips.*

Pictures and video clips

All pictures and videos are saved in **File manager**. The number of pictures or video clips that you can save depends on the size of the files. There is support for GIF, JPEG, WBMP, BMP, PNG, SVG-Tiny, MPG4, SDP and 3GPP.

 *Animations are handled like pictures.*

To view your pictures and video clips

- 1 ▶ **File manager** and ▶ **Pictures or Videos**.
- 2 Select a picture or video clip ▶ **View**.
- 3 For video clips ▶ **Play** to start the video clip.

To search camera pictures by time line

- 1 ▶ **File manager** ▶ **Pictures** ▶ **Camera pictures**.
- 2 ▶ **More** ▶ **Search**. Now you can browse the camera pictures, sorted by date in a time line.

Exchanging pictures and video clips

Exchange pictures and video clips with friends using one of the available transfer methods. You may not be allowed to exchange copyright-protected material.

You can also transfer pictures and video clips to a computer ➤ *39 Transferring files.*

To send a picture or video clip

- 1 ▶ **File manager** and ▶ **Pictures or Videos**.
- 2 Select a picture or video clip ▶ **More** ▶ **Send**. Select a transfer method.

To receive and save a picture or video clip

From a message containing the file ➤ *24 Messaging.*

If you want to receive a picture or a videoclip via another transfer method, make sure the transfer method is activated and follow the instructions that appear.

Screen saver and wallpaper

If you have a picture as wallpaper, this picture is shown in standby mode. The screen saver activates automatically when the phone is idle for a few seconds. After a few more seconds

sleep mode activates, to save power. In sleep mode only the clock is shown. Press any key or button to activate the screen again.

To activate sleep mode clock

► Settings ► Display ► Sleep mode clock ► On.

To use a picture

- 1 ► File manager ► Pictures and select a picture.
- 2 ► More ► Use as and select an option.

PhotoDJ™ and VideoDJ™

Visit www.sonyericsson.com/support for information on how to use PhotoDJ™ and VideoDJ™ in your phone.

Entertainment

Media player

Play music and video clips that you download or receive in a picture message or transfer from your computer. The following file types are supported: MP3, MP4, MP4A, 3GP, AAC, AMR, G-MIDI, EMY, IMY and WAV (16 kHz maximum sample rate). You can also use streamed files that are 3GPP compatible.

Music and video clips

Play music and video clips saved in your phone. Information such as artist and songtitle will show in the external display when the phone is closed.

To play music or view a video clip

► Media player and browse for songs by selecting Artists, Tracks, Playlists or Videos. Highlight a title ► Play.

Media player control

- ► Stop to pause a music track.
- ► Pause to pause a video clip.
- Press ⏸ to go to the next music track or video clip.
- Press ⏮ to go to the previous music track or video clip.

- Press and hold or to fast forward or rewind when playing music tracks or video clips.
- ► **Play** to select a highlighted track in a list.
- Press or to adjust the volume.
- When in **Now playing**, press to go to the **Media player** browser.
- When a video clip is paused, press to play the video clip one frame at a time.
- Press and hold to exit.

Media player options

When playing a music track ► **More** for the following options:

- **Minimize** – return to standby to use other functions while listening.
- **Information** – view information for the current track.
- **Play mode** – set options for **Shuffle** and **Loop**.
- **Equalizer** – set treble and bass when playing music.
- **Sort** – choose to sort tracks by **Artist**, **Title** or **As created**.
- **Send** – send the track to another device.
- **Delete** – delete the track from the playlist.

Radio

Listen to FM radio with RDS (Radio Data System) functionality. You must connect the handsfree to your phone as it works as an antenna. The radio can also be used as an alarm signal ► **40 Alarm clock**.

To listen to the radio

- 1 Connect the handsfree to your phone
- 2 ► **Radio**.

Radio control

- ► **Search** to find a broadcasting frequency.
- Press or to move 0.1 MHz.
- Press or to select preset channels.
- ► **More** to view options.

To save radio channels

► **Radio** set frequency ► **More** ► **Save** and chose a position from 1 to 20 or press and hold - to save in positions 1 to 10.

To select radio channels

Use the navigation key or press - to select a saved channel.

Radio options

► **More** for the following options:

- **Turn off** – turn off the radio.
- **Minimize** – return to standby to use other functions while listening.
- **Save** – save the current frequency in a position.
- **Channels** – select, rename, replace or delete a preset channel.
- **Turn on speaker** – use the loudspeakers.
- **Auto save** – save tuned channels in positions 1 to 20. Previously saved channels are replaced.
- **Set frequency** – enter a frequency manually. Press **#->** to go directly to **Set frequency**.
- **RDS** – set options for alternative frequency (AF) and station information.
- **Turn on Mono** – turn on mono sound.

PlayNow™

► **PlayNow™** to pre-listen, buy and download music via the Internet. If settings are not already in your phone ► **35 Settings**. For more information, contact your service provider or see www.sonyericsson.com/support.

Ringtones and melodies

Your phone comes with melodies that can be used as ringtones. You can exchange melodies by selecting a transfer method. Please note that you may not be allowed to exchange some copyright-protected material.

To set sounds and alerts options

► **Settings** ► **Sounds & alerts**, you can set:





- **Ring volume** – select the volume of a ringtone.
- **Ringtone** – select a sound or melody that will be heard when your phone rings.
- **Silent mode** – turn off and on all signals except the alarm signal. Press and hold **#->** from standby.
- **Increasing ring** – select increasing volume for your ringtone.
- **Open phone sounds** – select a sound that will be heard when you open your phone.
- **Vibrating alert** – turn on and off the vibrating alert.
- **Message alert** – select message notification.
- **Key sound** – select the key press sound.

Composing melodies

Compose and edit ringtones using the MusicDJ™.

To compose a melody

► Entertainment ► MusicDJ™.

Choose to Insert, Copy and Paste blocks to compose. Use , ,  or  to move between the blocks. Press  to delete a block. ► More to view more options.

To edit a previously created ringtone

► File manager ► Sounds and select a ringtone ► More ► Edit.

To send and receive a ringtone

► File manager ► Sounds and select a ringtone. ► More ► Send and select a transfer method. When you receive the ringtone, follow the instructions that appear.

 *You cannot send a polyphonic ringtone or an MP3 file in a text message.*

Sound recorder

Record your own memos or calls which can be set as ringtones.

 *In some countries or states it is required by law that you inform the other person before recording the call.*

To start a sound recording

► Entertainment ► Record sound.

To listen to your recordings

- 1 ► File manager ► Sounds and select a recording.
- 2 ► Play to listen to the recording.

Themes, games and applications

Your phone comes with predefined themes, games and applications. A theme is the background colours and patterns of the screen. You can download new content to your phone. For more information, see www.sonyericsson.com/support.

To set a theme

► File manager ► Themes, select a theme ► Set.

To send a theme

► File manager ► Themes, select a theme ► More ► Send. Select a transfer method.

To receive and save a theme

When you receive the theme, follow the instructions that appear.

To start and end a game

► Entertainment ► Games, select a game ► Select. Press and hold  to end the game.

To start and end an application

► File manager ► Applications, select an application ► Select. Press and hold  to end the application.

 *Unrecognized formats are saved in the Other folder.*

To download a theme

► File manager ► Themes and scroll to a direct link ► Go to.

To download a game

► Entertainment ► Games and scroll to a direct link ► Go to.

To download an application

► Internet services ► More ► Go to
► Bookmarks and scroll to a direct link
► Go to.

If settings are not already in your phone ► *35 Settings.*

Connectivity

Settings

 *Before you start using the Internet, Messaging, My friends or PlayNow™, settings are required in your phone.*

In order to use the Internet, and send and receive picture and email messages, you need the following:

- A phone subscription that supports data transmission.
- Settings entered in your phone.
- You may also have to register as an Internet and email user with your service provider or network operator.

Entering settings

Settings may already be entered when you buy your phone. If the settings are not already entered in your phone, you can:

- Receive settings in a message from your network operator, service provider or visit www.sonyericsson.com/support.
- Enter or edit settings yourself.

Using Internet

Browse the Internet using HTTP (Hyper Text Transfer Protocol).

To select an Internet profile

► Settings ► Connectivity ► Internet settings ► Internet profiles and select a profile to use.

To start browsing

► Internet services, select a service or
► More for options.

To stop browsing

► More ► Exit browser.



If you select an email address when browsing a Web page, you can send a message to that address.

To work with bookmarks

► Internet services ► More ► Go to
► Bookmarks and select a bookmark
► More. Select an option.

Internet security

Secure browsing is supported. When using an Internet profile you can turn on security in the phone.

Trusted certificates

Certain Internet services, such as banking, require certificates in your phone. Your phone may already contain certificates when you buy it, or you can download new certificates.

To check the certificates in your phone

► Settings ► Connectivity ► Internet settings ► Security ► Trusted cert.

Synchronizing

Synchronize contacts, appointments, tasks and notes via Bluetooth, Internet services or a USB cable.

Visit www.sonyericsson.com/support to download the software or Getting started guides for synchronization.

Synchronization with nearby devices

Install the computer synchronization by downloading it from www.sonyericsson.com/support. The software includes help information.

Remote synchronization via Internet

Synchronize online via an Internet service. Contact your network operator for more information.

To enter the remote synchronization settings

- Organizer ► Synchronization and
► Yes or New account. Enter a name for the new account ► Continue.
- Enter the following settings:
 - Server address – server URL.
 - Username – account username.

- **Password** – account username.
 - **Connection** – select an Internet profile.
 - **Applications** – mark applications to synchronize.
 - **App. settings** – select an application and enter a database name, and if required, username and password.
 - **Sync. interval** – set how often to synchronize.
 - **Remote initiation** – select to always accept, never accept or always ask when starting from a service.
 - **Remote security** – enter server ID and password.
- 3 ► **Save** to save your new account.

To start the remote synchronization

► **Organizer** ► **Synchronization**, select an account ► **Start**.

Bluetooth™ wireless technology

Bluetooth wireless technology makes it possible to connect wirelessly to other Bluetooth devices. You can:

- connect to several devices at the same time.
- synchronize information with other devices.
- use the remote control functionality.

- use a remote screen.
- exchange items and play multiplayer games.

 *The recommended maximum distance between two Bluetooth devices is 10 meters, with no solid objects in between.*

Before you start

- Turn on the Bluetooth function to communicate with other devices.
- Pair your phone with the Bluetooth devices that you want to communicate with.

 *Please check if local laws or regulations restrict the use of Bluetooth wireless technology. If Bluetooth wireless technology is not allowed, you must ensure that the Bluetooth function is turned off. The maximum Bluetooth radio output power allowed from the phone is automatically adjusted according to possible local restrictions. This means that the maximum distance may vary.*

To turn on the Bluetooth function in your phone

► **Settings** ► **Connectivity** ► **Bluetooth**
 ► **Turn on**.

To show or hide your phone

- ▶ Settings ▶ Connectivity ▶ Bluetooth
- ▶ Visibility ▶ Show phone or Hide phone.

 *If set to hide, other devices will not be able to discover your phone via the Bluetooth connection.*

To add a device to your phone

- ▶ Settings ▶ Connectivity ▶ Bluetooth ▶ My devices ▶ New device to search for available devices.
- Select a device from the list.
- Enter a passcode, if required.

To save power

- ▶ Settings ▶ Connectivity ▶ Bluetooth
- ▶ Powersave ▶ On.

 *This reduces power consumption when using a single Bluetooth device. Turn it off when using several Bluetooth devices.*

To add a Bluetooth headset

- ▶ Settings ▶ Connectivity ▶ Bluetooth ▶ Handsfree.
- ▶ Yes if you are adding a Bluetooth handsfree for the first time or ▶ My handsfree ▶ New handsfree ▶ Add if you are adding another Bluetooth handsfree. Ensure that your handsfree is prepared to be added.

USB cable

Use a USB cable and exchange information between your phone and a computer.

To start a USB connection

Turn on your phone and connect the USB cable to your phone and computer:

- **File transfer** to browse files on the memory card and on the phone memory. The phone will turn off in this mode.
- **Phone mode** to synchronize information with other devices or use the phone as a modem. The phone will remain on in this mode.

 *Do not remove the USB cable from the phone or computer during file transfer as this may corrupt the memory card and the phone memory.*

To end a USB connection

- When in **File transfer** mode, exit the USB connection on your computer by right-clicking on the Removable disk icon in Windows Explorer and select Eject. Then remove the USB cable from your phone and computer.
- When in **Phone mode**, remove the USB cable from your phone and computer.

Transferring files

You can transfer pictures, videos, sounds, and themes by using Bluetooth wireless technology or USB cable.

-  *You can also send files via email*
- 27 *Email or picture messages*
 - 25 *Picture messaging (MMS)*.

To transfer files using Bluetooth wireless technology

- 1 Select a file to transfer.
- 2 ▶ **More** ▶ **Send** and select **Via Bluetooth**.

To transfer files using the USB cable

- 1 Prepare your phone for file transfer
 - 38 *To start a USB connection*.
- 2 Use drag-and-drop functionality in your computer to transfer files between your phone and the computer.
- 3 End USB connection ➤ 38 *To end a USB connection*.

Update service

Download and install new software without affecting the user data in your phone. Update your phone over the air or online via USB cable and an Internet-connected computer.



The Update service requires data access (GPRS). Your operator will provide you with a subscription with data access and with price information.

To use Update service over the air

- 1 ▶ **Settings** ▶ **General** ▶ **Update service**.
- 2 ▶ **Search for update** to search for the latest available software, or ▶ **Software version** to display the current software installed in your mobile phone, or ▶ **Reminder** to set when to search for new software.

To use Update service online

- 1 Visit www.sonyericsson.com/support.
- 2 Select a region and country.
- 3 Enter the product name.
- 4 Select Sony Ericsson Update Service and follow the instructions that appear.

More features

Time and date

Time and date are always displayed in standby.

To set the time and date

► Settings ► General ► Time & date:

- **Time** – edit time and time format.
- **Date** – edit date and date format.
- **Time zone** – select a time zone.
- **Daylight saving** – turn daylight saving on and off.
- **Auto time zone** – switches time zone automatically.

Alarm clock

The alarm rings even if the phone is set to silent or turned off.

To set and use an alarm

► Organizer ► Alarms and select an option:

- **Alarm** – set an alarm.
- **Recurrent alarm** – set a recurrent alarm.
- **Alarm signal** – select a sound.

To turn the alarm signal off when it rings, press any key. To cancel an alarm ► Alarm or Recurrent alarm ► Turn off.

Profiles

Your phone has predefined profiles that are set to suit a certain environment. You can reset all profile settings to the way they were set when you bought your phone.

To use profiles

► Settings ► General ► Profiles:



- Select a profile to use.
- To view and edit a profile ► More ► View and edit.
- To reset profiles ► More ► Reset profiles.



You can also activate a profile from the shut down menu ► 11 Shut down menu.

Brightness

Adjust the brightness of the screen.

► Settings ► Display ► Brightness and press  or  to set brightness level ► Save.

Calendar

Add, save, edit and set reminders for appointments. Synchronize the calendar with a Web calendar or a computer calendar ► 36 Synchronizing.

To add a new appointment

► Organizer ► Calendar select a date
► New appointment ► Add. Enter details ► Continue to confirm each entry. ► Select to confirm the appointment.

To view an appointment

► Organizer ► Calendar and select a day. Select an appointment ► View.

To view a calendar week

► Organizer ► Calendar ► More
► View week.

To set reminders options

- Organizer ► Calendar ► More
► Advanced ► Reminders.
- Select an option. ► Always for a reminder to sound even though the phone is turned off or set to silent.
- When the reminder sounds:
 - If **New events** is set to **Activity menu**, ► View to read the appointment.
 - If **New events** is set to **Popup** ► Yes to read the appointment or ► No to turn off the reminder.



A reminder option set in the calendar affects a reminder option set in tasks.

Navigating in your calendar

Use the navigation key to move between days or weeks.

Calendar settings

► Organizer ► Calendar ► More and select an option:

- **View week** – view appointments of the week.
- **New appointment** – add a new appointment.
- **Change date** – go to another date.
- **Advanced** – for options to find and set reminders or select a start day for the week.
- **Delete** – delete appointments.
- **Help** – view help text for more calendar information.

To send an appointment

► Organizer ► Calendar and select an appointment ► More ► Send and select a transfer method.

Tasks

Add new tasks or use existing tasks as templates. You can also set reminders for tasks.

To add a new task

► Organizer ► Tasks ► New task
► Add. ► Task or Phone call. Enter details and confirm each entry.

To view a task

- ▶ Organizer ▶ Tasks and select a task
- ▶ View.

To set reminders

- ▶ Organizer ▶ Tasks and select a task
▶ More ▶ Reminders.
- Follow step 2 and 3 ➡ 41 *To set reminders options.*



A reminder option set in tasks affects a reminder option set in the calendar.

To send a task

- ▶ Organizer ▶ Tasks and select a task
- ▶ More ▶ Send and select a transfer method.

Notes

Make notes and save them in a list. You can also show a note in standby.

To add a note

- ▶ Organizer ▶ Notes ▶ New note
- ▶ Add and enter the note ▶ Save.

To edit notes

- ▶ Organizer ▶ Notes select a note
- ▶ More and edit the note ▶ Save.

Calculator

Use the calculator to add, subtract, divide and multiply. ▶ Organizer

▶ Calculator:

- To select \div \times $-$ $+$ $.$ $\%$ $=$, press \odot or \odot .
- To delete a figure, press C .

SIM card lock

The SIM card lock protects your subscription from unauthorized use. Most SIM cards are locked at the time of purchase. If the SIM card lock is on, you have to enter a PIN every time you turn on your phone. If you enter your PIN incorrectly three times in a row, the SIM card is blocked and the message **PIN blocked** is displayed. To unblock it, you need to enter your PUK (Personal Unblocking Key). Your PIN and PUK are supplied by your network operator. You can edit your PIN and select a new four- to eight-digit PIN.

To unblock your SIM card

- When **PIN blocked** is displayed, enter your PUK ▶ OK.
- Enter a new PIN ▶ OK. Re-enter the new PIN to confirm ▶ OK.

To edit your PIN

- 1 ► Settings ► General ► Locks ► SIM lock ► Change PIN.
- 2 Enter your PIN ► OK.
- 3 Enter a new PIN ► OK. Re-enter the new PIN to confirm ► OK.

 *If the message Codes do not match appears when you edit your PIN, the new PIN is entered incorrectly. If the message Wrong PIN appears, followed by Old PIN: you entered your old PIN incorrectly.*

To turn the SIM card lock on or off

- 1 ► Settings ► General ► Locks ► SIM lock ► Protection and ► On or Off.
- 2 Enter your PIN ► OK.

Phone lock

The phone lock protects the phone against unauthorized use. You can change the phone lock code (0000) to any four- to eight-digit personal code.

To unlock the phone

If the phone lock is on, enter your code ► OK.

Automatic phone lock

If the phone lock is set to automatic, you only need to enter your phone lock code when you insert a different SIM card.

To set the phone lock

- 1 ► Settings ► General ► Locks ► Phone lock ► Protection and select an option.
- 2 Enter the phone lock code ► OK.

To edit your phone lock code

► Settings ► General ► Locks ► Phone lock ► Change code.

 *It is important that you remember your new code. If you forget it, you have to hand in your phone to your local Sony Ericsson retailer.*

Code memo

Save security codes, such as for credit cards, in the code memo. Set a passcode to open the code memo. Enter a checkword. When you enter your passcode to open the code memo, the checkword is shown for a short time. If the passcode is correct, the correct codes are shown. If you enter the incorrect passcode, the checkword and the codes that are shown are also incorrect. If you forgot your passcode you must reset the code memo.

To open code memo for the first time

- 1 ► Organizer ► Code memo. Instructions appear ► Continue.
- 2 Enter a four-digit passcode ► Continue.

More features 43

- 3 Re-enter the passcode ► Continue.
- 4 Enter a checkword (maximum 15 characters) ► Done.

To add a new code

- 1 ► Organizer ► Code memo and enter your passcode ► Continue ► New code ► Add.
- 2 Enter a name associated with the code, for example, the name of the credit card company ► Continue.
- 3 Enter the code ► Done.

To change the passcode

- 1 ► Organizer ► Code memo and enter your passcode ► Continue ► More ► Change passcode.
- 2 Enter your new passcode ► Continue.
- 3 Re-enter the new passcode ► Continue.
- 4 Enter a checkword ► Done.

To reset code memo

- 1 ► Organizer ► Code memo and enter any passcode ► Continue ► More ► Reset.
- 2 Reset code memo? appears ► Yes. The code memo is reset and all entries are cleared. The next time you enter the code memo, you must start at ► 43 To open code memo for the first time.

Troubleshooting

Some problems require that you call your service provider, but most problems you can correct yourself.



Before handing your phone in for repair, copy your saved content and information to another device as it may be lost during repair. For more support go to www.sonyericsson.com/support.

Grey menu options

The service may not be activated or your subscription does not support the function. Contact your network operator.

The phone is working slowly

Delete unwanted content and then restart the phone.

No indication of charging

The battery is empty or has not been used for a long time. It may take up to 30 minutes before the battery icon appears.

The phone cannot be turned on

The battery is discharged
 ► 4 To charge the battery.

Charging a non Sony Ericsson battery

► 49 Battery.

The wrong menu language is shown

➡ *12 To change the phone language.*

Master reset

Delete your settings and the content you have added or edited.

To reset your phone

▶ Settings ▶ General ▶ Master reset.

Select **Reset settings** to delete your changes to settings or **Reset all** to delete your changes to settings, all contacts, messages, personal data, and content you have downloaded, received or edited. ▶ Continue.

Error messages

Insert SIM

Is the SIM card correctly inserted?

➡ *4 To insert the SIM card*

Insert correct SIM card

Are you using the correct operator SIM card for your phone?

Emerg. calls only

You are within range of a network but not allowed to use it, except for emergency calls. Contact your network operator to ensure your subscription is correct.

No netw. coverage

There is no network within range. Contact your network operator to ensure that the network has coverage.

Wrong PIN/Wrong PIN2

You have entered your PIN or PIN2 incorrectly. Enter the correct PIN or PIN2 ▶ Yes ➡ *42 SIM card lock.*

Codes do not match

To change a security code you have to confirm the new code by entering exactly the same code twice.

PIN blocked/PIN2 blocked

To unblock ➡ *42 SIM card lock.*

PUK blocked

Contact your network operator.

Phone locked

The phone is locked. To unlock the phone ➡ *43 Phone lock.*

Phone lock code

The phone lock code is required ➡ *43 Phone lock.*

Important information

Sony Ericsson Consumer Web site

On www.sonyericsson.com/support there is a support section where help and tips are only a few clicks away. Here you find the latest computer software updates and tips on how to use your product more efficiently.

Service and support

From now on you will have access to a portfolio of exclusive service advantages such as:

- Global and local websites providing support.
- A global network of Call Centers.
- An extensive network of Sony Ericsson service partners.
- A warranty period. Learn more about the warranty conditions in this user guide.

Country	Phone number
Australia	1-300 650 050
Argentina	800-333-7427
Austria	0810 200245
Belgium	02-7451611
Brazil	4001-0444
Canada	1-866-766-9374
Central Africa	+27 112589023
Chile	123-0020-0656
China	4008100000
Colombia	18009122135
Croatia	062 000 000
Czech Republic	844 550 055
Denmark	33 31 28 28
Finland	09-299 2000

On www.sonyericsson.com, under the support section in the language of your choice, you will find the latest support tools and information, such as software updates, Knowledgebase, Phone setup and additional help when you require it.

For operator-specific services and features, please contact your network operator for more information.

You can also contact our Call Centers. See the phone number for the nearest Call Center in the list below. If your country/region is not represented in the list, please contact your local dealer. (The phone numbers below were correct at the time of going to print. On www.sonyericsson.com you can always find the latest updates.)

In the unlikely event that your product needs service, please contact the dealer from whom it was purchased or one of our service partners. Save your original proof of purchase, you will need it if you need to claim warranty.

For a call to one of our Call Centers you will be charged according to national rates, including local taxes, unless the phone number is a toll-free number.

Email address

questions.AU@support.sonyericsson.com
questions.AR@support.sonyericsson.com
questions.AT@support.sonyericsson.com
questions.BE@support.sonyericsson.com
questions.BR@support.sonyericsson.com
questions.CA@support.sonyericsson.com
questions.CF@support.sonyericsson.com
questions.CL@support.sonyericsson.com
questions.CN@support.sonyericsson.com
questions.CO@support.sonyericsson.com
questions.HR@support.sonyericsson.com
questions.CZ@support.sonyericsson.com
questions.DK@support.sonyericsson.com
questions.FI@support.sonyericsson.com

France	0 825 383 383	questions.FR@support.sonyericsson.com
Germany	0180 534 2020	questions.DE@support.sonyericsson.com
Greece	801-11-810-810	
	210-89 91 919 (from mobile phone)	questions.GR@support.sonyericsson.com
Hong Kong	8203 8863	questions.HK@support.sonyericsson.com
Hungary	+36 1 880 47 47	questions.HU@support.sonyericsson.com
India	1800 11 1800 (toll-free number)	questions.IN@support.sonyericsson.com
	39011111 (from mobile phone)	
Indonesia	021-2701388	questions.ID@support.sonyericsson.com
Ireland	1850 545 888	questions.IE@support.sonyericsson.com
Italy	06 48895206	questions.IT@support.sonyericsson.com
Malaysia	1-800-889900	questions.MY@support.sonyericsson.com
Mexico	01 800 000 4722 (national toll-free number)	questions.MX@support.sonyericsson.com
Netherlands	0900 899 8318	questions.NL@support.sonyericsson.com
New Zealand	0800-100150	questions.NZ@support.sonyericsson.com
Norway	815 00 840	questions.NO@support.sonyericsson.com
Philippines	02-6351860	questions.PH@support.sonyericsson.com
Poland	0 (prefix) 22 6916200	questions.PL@support.sonyericsson.com
Portugal	808 204 466	questions.PT@support.sonyericsson.com
Romania	(+4021) 401 0401	questions.RO@support.sonyericsson.com
Russia	8(495) 7870986	questions.RU@support.sonyericsson.com
Singapore	67440733	questions.SG@support.sonyericsson.com
Slovakia	02-5443 6443	questions.SK@support.sonyericsson.com
South Africa	0861 632222	questions.ZA@support.sonyericsson.com
Spain	902 180 576	questions.ES@support.sonyericsson.com
Sweden	013-24 45 00	questions.SE@support.sonyericsson.com
Switzerland	0848 824 040	questions.CH@support.sonyericsson.com
Taiwan	02-25625511	questions.TW@support.sonyericsson.com
Thailand	02-2483030	questions.TH@support.sonyericsson.com
Turkey	0212 47 37 777	questions.TR@support.sonyericsson.com
Ukraine	(+380) 44 590 1515	questions.UA@support.sonyericsson.com
United Arab Emirates	43 919880	questions.AE@support.sonyericsson.com
United Kingdom	08705 23 7237	questions.GB@support.sonyericsson.com
United States	1-866-766-9374	questions.US@support.sonyericsson.com
Venezuela	0-800-100-2250	questions.VE@support.sonyericsson.com

Guidelines for Safe and Efficient Use

Please read this information before using your mobile phone.

These instructions are intended for your safety. Please follow these guidelines. If the product has been subject to any of the conditions listed below or you have any doubt of the proper function make sure to have the product checked by certified service partner before charging or using it. Failure to do so might lead to risk for product malfunction or even a potential hazard to your health.



Recommendations for safe use of product (mobile phone, battery, charger and other accessories)

- Always treat your product with care and keep it in a clean and dust-free place.
- **Warning!** May explode if disposed of in fire.
- Do not expose your product to liquid or moisture or humidity.
- Do not expose your product to extreme high or low temperatures. Do not expose the battery to temperatures above +60°C (+140°F).
- Do not expose your product to open flames or lit tobacco products.
- Do not drop, throw or try to bend your product.
- Do not close your product with an object inserted between keypad and display; this may damage your product.



- Do not paint your product.
- Do not attempt to disassemble your product. Only Sony Ericsson authorised personnel should perform service.
- Do not use your product near medical equipment without requesting permission.
- Do not use your product when in, or around aircraft, or areas posted "turn off two-way radio".
- Do not use your product in an area where a potentially explosive atmosphere exists.
- Do not place your product or install wireless equipment in the area above your car's air bag.



CHILDREN

KEEP OUT OF CHILDRENS REACH. DO NOT ALLOW CHILDREN TO PLAY WITH YOUR MOBILE PHONE OR ITS ACCESSORIES. THEY COULD HURT THEMSELVES OR OTHERS, OR COULD

ACCIDENTALLY DAMAGE THE MOBILE PHONE OR ACCESSORY. YOUR MOBILE PHONE OR ITS ACCESSORY MAY CONTAIN SMALL PARTS THAT COULD BE DETACHED AND CREATE A CHOKING HAZARD.



Power supply (Charger)

Connect the AC power adapter only to designated power sources as marked on the product. Make sure the cord is positioned so that it will not be subjected to damage or stress. To reduce risk of electric shock, unplug the unit from any power source before attempting to clean it. The AC power adapter must not be used outdoors or in damp areas. Never alter the cord or plug. If the plug will not fit into the outlet, have a proper outlet installed by a qualified electrician.

Use only Sony Ericsson branded original chargers intended for use with your mobile phone. Other chargers may not be designed to the same safety and performance standards.

Battery

We recommend that you fully charge the battery before you use your mobile phone for the first time. A new battery or one that has not been used for a long time could have reduced capacity the first few times it is used. The battery should only be charged in temperatures between +5°C (+41°F) and +45°C (+113°F).

Use only Sony Ericsson branded original batteries intended for use with your mobile phone. Using other batteries and chargers could be dangerous.

The talk and standby times depend on several different conditions such as signal strength, operating temperature, application usage patterns, features selected and voice or data transmissions when using the mobile phone.

Turn off your mobile phone before removing the battery. Do not allow the battery to be put into the mouth. Battery electrolytes may be toxic if swallowed. Do not let the metal contacts on the battery touch another metal object. This could short-circuit and damage the battery. Use the battery for the intended purpose only.

Personal medical devices

Mobile phones may affect the operation of cardiac pacemakers and other implanted equipment. Please avoid placing the mobile phone over the pacemaker, e.g. in your breast pocket. When using the mobile phone, place it at the ear opposite the pacemaker. If a minimum distance of 15 cm (6 inches) is kept between the mobile phone and the pacemaker, the risk of interference is limited. If you have any reason to suspect that interference is taking place, immediately turn off your mobile phone. Contact your cardiologist for more information.

For other medical devices, please consult your physician and the manufacturer of the device.

Driving

Please check if local laws and regulations restrict the use of mobile phones while driving or require drivers to use handsfree solutions. We recommend that you use only Sony Ericsson handsfree solutions intended for use with your product.

Please note that because of possible interference to electronic equipment, some vehicle manufacturers forbid the use of mobile phones in their vehicles unless a handsfree kit with an external antenna supports the installation.

Always give full attention to driving and pull off the road and park before making or answering a call if driving conditions so require.

Emergency calls

Mobile phones operate using radio signals, which cannot guarantee connection under all conditions. Therefore you should never rely solely upon any mobile phone for essential communications (e.g. medical emergencies).

Emergency calls may not be possible in all areas, on all cellular networks, or when certain network services and/or mobile phone features are in use. Check with your local service provider.

Antenna

This phone contains a built in antenna. Use of antenna devices not marketed by Sony Ericsson specifically for this model could damage your mobile phone, reduce performance, and produce SAR levels above the established limits (see below).

Efficient use

Hold your mobile phone as you would any other phone. Do not cover the top of the phone when in use, as this affects call quality and may cause the phone to operate at a higher power level than needed, thus shortening talk and standby times.

Radio frequency (RF) exposure and SAR

Your mobile phone is a low-power radio transmitter and receiver. When it is turned on, it emits low levels of radio frequency energy (also known as radio waves or radio frequency fields).

Governments around the world have adopted comprehensive international safety guidelines, developed by scientific organizations, e.g. ICNIRP (International Commission on Non-Ionizing Radiation Protection) and IEEE (The Institute of Electrical and Electronics Engineers Inc.), through periodic and thorough evaluation of scientific studies. These guidelines establish permitted levels of radio wave exposure for the general population. The levels include a safety margin designed to assure the safety of all persons, regardless of age and health, and to account for any variations in measurements.

Specific Absorption Rate (SAR) is the unit of measurement for the amount of radio frequency energy absorbed by the body when using a mobile phone. The SAR value is determined at the highest certified power level in laboratory conditions, but the actual SAR level of the mobile phone while operating can be well below this value. This is because the mobile phone is designed to use the minimum power required to reach the network.

Variations in SAR below the radio frequency exposure guidelines do not mean that there are variations in safety. While there may be differences in SAR levels among mobile phones, all Sony Ericsson mobile phone models are designed to meet radio frequency exposure guidelines.

For phones sold in the U.S., before a phone model is available for sale to the public, it must be tested and certified to the FCC that it does not exceed the limit established by the government-adopted requirement for safe exposure. The tests are performed in positions and locations (that is, at the ear and worn on the body) as required by the FCC for each model. For body worn operation, this phone has been tested and meets FCC RF exposure guidelines when the handset is positioned a minimum of 15 mm from the body without any metal parts in the vicinity of the phone or when used with the original Sony Ericsson body worn accessory intended for this phone. Use of other accessories may not ensure compliance with FCC RF exposure guidelines.

A separate leaflet with SAR information for this mobile phone model is included with the material that comes with this mobile phone. This information can also be found, together with more information on radio frequency exposure and SAR, on: www.sonyericsson.com.

Accessible Solutions/Special Needs

For phones sold in the U.S., you can use your TTY terminal with your Sony Ericsson mobile phone (with the necessary accessory). For information on Accessible Solutions for individuals with special needs call the Sony Ericsson Special Needs Center at 877 878 1996 (TTY) or 877 207 2056 (voice), or visit the Sony Ericsson Special Needs Center at www.sonyericsson-snc.com.

Disposal of old electrical & electronic equipment

This symbol on the product or on its packaging indicates that this product shall not be treated as household waste. Instead it shall be handed over to the applicable collection point for the recycling of electrical and electronic equipment. By ensuring



this product is disposed of correctly, you will help prevent potential negative consequences for the environment and human health, which could otherwise be caused by inappropriate waste handling of this product. The recycling of materials will help to conserve natural resources. For more detailed information about recycling of this product, please contact your local city office, your household waste disposal service or the shop where you purchased the product.

Disposing of the battery

Please check local regulations for disposal of batteries or call your local Sony Ericsson Call Center for information.



The battery should never be placed in municipal waste. Use a battery disposal facility if available.

End User Licence Agreement

This wireless device, including without limitation any media delivered with the device, ("Device") contains software owned by Sony Ericsson Mobile Communications AB and its affiliated companies ("Sony Ericsson") and its third party suppliers and licensors ("Software").

As user of this Device, Sony Ericsson grants you a non-exclusive, non-transferable, non-assignable license to use the Software solely in conjunction with the Device on which it is installed and/or delivered with. Nothing herein shall be construed as a sale of the Software to a user of this Device. You shall not reproduce, modify, distribute, reverse engineer, decompile, otherwise alter or use any other means to discover the source code of the Software or any component of the Software. For avoidance of doubt, you are at all times entitled to transfer all rights and obligations to the Software to a third party, solely together with the Device with

which you received the Software, provided always that such third party agrees in writing to be bound by these rules.

You are granted this license for a term of the useful life of this Device. You can terminate this license by transferring all your rights to the Device on which you have received the Software to a third party in writing. If you fail to comply with any of the terms and conditions set out in this license, it will terminate with immediate effect.

Sony Ericsson and its third party suppliers and licensors are the sole and exclusive owner of and retain all rights, title and interest in and to the Software. Sony Ericsson, and, to the extent that the Software contains material or code of a third party, such third party, shall be entitled third party beneficiaries of these terms.

The validity, construction and performance of this license shall be governed by the laws of Sweden. The foregoing shall apply to the full extent permitted by, when applicable, statutory consumer rights.

Limited Warranty

Sony Ericsson Mobile Communications AB, S-221 88 Lund, Sweden, (Sony Ericsson), provides this Limited Warranty for your mobile phone and original accessory delivered with your mobile phone (hereinafter referred to as "Product").

Should your Product need warranty service, please return it to the dealer from whom it was purchased, or contact your local Sony Ericsson Call Center (national rates may apply) or visit www.sonyericsson.com to get further information.

OUR WARRANTY

Subject to the conditions of this Limited Warranty, Sony Ericsson warrants this Product to be free from defects in design, material and workmanship at the time of its original purchase by a consumer, and for a subsequent period of one (1) year.

WHAT WE WILL DO

If, during the warranty period, this Product fails to operate under normal use and service, due to defects in design, materials or workmanship, Sony Ericsson authorised distributors or service partners, in the country/region* where you purchased the Product, will, at their option, either repair or replace the Product in accordance with the terms and conditions stipulated herein.

Sony Ericsson and its service partners reserve the right to charge a handling fee if a returned Product is found not to be under warranty according to the conditions below.

Please note that some of your personal settings, downloads or other information may be lost when your Sony Ericsson Product is repaired or replaced. At present Sony Ericsson may be prevented by applicable law, other regulation or technical restrictions from making a backup copy of certain downloads. Sony Ericsson does not take any responsibility for any lost information of any kind and will not reimburse you for any such loss. You should always make backup copies of all the information stored on your Sony Ericsson Product such as downloads, calendar and contacts before handing in your Sony Ericsson Product for repair or replacement.

CONDITIONS

- 1 The warranty is valid only if the original proof of purchase issued to the original purchaser by a Sony Ericsson authorised dealer, specifying the date of purchase and serial number**, for this Product, is presented with the Product to be repaired or replaced. Sony Ericsson reserves the right to refuse warranty service if this information has been removed or changed after the original purchase of the Product from the dealer.
- 2 If Sony Ericsson repairs or replaces the Product, the repaired or replaced Product shall be warranted for the remaining time of the original warranty

period or for ninety (90) days from the date of repair, whichever is longer. Repair or replacement may involve the use of functionally equivalent reconditioned units. Replaced parts or components will become the property of Sony Ericsson.

- 3 This warranty does not cover any failure of the Product due to normal wear and tear, or due to misuse, including but not limited to use in other than the normal and customary manner, in accordance with the Sony Ericsson instructions for use and maintenance of the Product. Nor does this warranty cover any failure of the Product due to accident, software or hardware modification or adjustment, acts of God or damage resulting from liquid.

A rechargeable battery can be charged and discharged hundreds of times. However, it will eventually wear out – this is not a defect. When the talk-time or standby time is noticeably shorter, it is time to replace your battery. Sony Ericsson recommends that you use only batteries and chargers approved by Sony Ericsson.

Minor variations in display brightness and color may occur between phones. There may be tiny bright or dark dots on the display. These are called defective pixels and occur when individual dots have malfunctioned and can not be adjusted. Two defective pixels are deemed acceptable.

Minor variations in the appearance of the camera image may occur between phones. This is not uncommon in digital cameras and does not mean that the camera is defective in any way.

- 4 Since the cellular system on which the Product is to operate is provided by a carrier independent from Sony Ericsson, Sony Ericsson will not be responsible for the operation, availability, coverage, services or range of that system.
- 5 This warranty does not cover Product failures caused by installations, modifications, or repair or opening of the Product performed by a non-Sony Ericsson authorised person.

- 6 The warranty does not cover Product failures which have been caused by use of accessories or other peripheral devices which are not Sony Ericsson branded original accessories intended for use with the Product.
- 7 Tampering with any of the seals on the Product will void the warranty.
- 8 THERE ARE NO EXPRESS WARRANTIES, WHETHER WRITTEN OR ORAL, OTHER THAN THIS PRINTED LIMITED WARRANTY. ALL IMPLIED WARRANTIES, INCLUDING WITHOUT LIMITATION THE IMPLIED WARRANTIES OF MERCHANTABILITY OR FITNESS FOR A PARTICULAR PURPOSE, ARE LIMITED TO THE DURATION OF THIS LIMITED WARRANTY. IN NO EVENT SHALL SONY ERICSSON OR ITS LICENSORS BE LIABLE FOR INCIDENTAL OR CONSEQUENTIAL DAMAGES OF ANY NATURE WHATSOEVER, INCLUDING BUT NOT LIMITED TO LOST PROFITS OR COMMERCIAL LOSS; TO THE FULL EXTENT THOSE DAMAGES CAN BE DISCLAIMED BY LAW.

Some countries/states do not allow the exclusion or limitation of incidental or consequential damages, or limitation of the duration of implied warranties, so the preceding limitations or exclusions may not apply to you.

The warranty provided does not affect the consumer's statutory rights under applicable legislation in force, nor the consumer's rights against the dealer arising from their sales / purchase contract.

***EUROPEAN UNION (EU)**

If you have purchased your Product in an EU country you can have your Product serviced, under the conditions set out above, within the warranty period in any EU country where an identical Product is sold by an authorised Sony Ericsson distributor. To find out if your Product is sold in the EU country you are in, please call the local Sony Ericsson Call Center. Please observe that certain services may not be possible elsewhere than in the country of original purchase, for example due to the fact that your Product may have an interior or exterior which is different from equivalent models sold in other EU countries. It may not be possible to repair SIM-locked Products.

*** In some countries/regions additional information is requested. If so, this is clearly shown on the valid proof of purchase.

FCC Statement

This device complies with Part 15 of the FCC rules. Operation is subject to the following two conditions: (1) This device may not cause harmful interference, and (2) This device must accept any interference received, including interference that may cause undesired operation.



Declaration of Conformity

We, Sony Ericsson Mobile Communications AB of Nya Vattentorget
S-221 88 Lund, Sweden

declare under our sole responsibility that our product

Sony Ericsson type AAB-1022015-BV

and in combination with our accessories, to which this declaration relates is in conformity with the appropriate standards 3GPP TS 51.010-1, EN 301489-7, EN 300328, EN 301489-17, and EN 60950 following the provisions of, Radio Equipment and Telecommunication Terminal Equipment directive 99/5/EC with requirements covering EMC directive 89/336/EEC, and Low Voltage directive 73/23/EEC

Lund, February 2006

CE 0682

A handwritten signature in black ink, reading 'Shoji Nemoto'.

Shoji Nemoto,

Head of Product Business Unit GSM/UMTS

We fulfil the requirements of the R&TTE Directive (99/5/EC).

Index

A

adding	
personal ringtones	15
pictures to contacts	15
adding appointment	41
alarm clock	40
answering service	17
applications	34
appointment	
adding	41

B

battery	
charging	4
inserting	4
Bluetooth headset	38
Bluetooth™ wireless technology ...	37–38
bookmarks	
Internet	36

C

calculator	42
calendar	40
call waiting	20
calls	
answering	13
emergency	14
hold	20

making	5, 13
missed	14
phone contact	15
receiving	5
recording	34
redial	13
SIM contact	15
two calls	20
camera	28–30
certificates	36
closed user groups	23
code memo	43
codes	
PIN	5
PUK	45
conference calls	20
contacts	14
adding contacts	15
default contacts	15
delete	16
edit	16
synchronizing	36

D

date	40
declaration of conformity	54
diverting calls	19

E		media player31–32
email	27	melodies33
emergency calls	14	memory card
		insert and remove6
F		memory status
file information	11	contacts16
file manager	11	file manager11
		Memory Stick Micro™ (M2M™)
G		formatting11
games	34	menu overview8
groups	23	menus10
		messaging24
H		microphone, off/on14
handsfree	38	multitap text input12
		music31
I		My friends28
Internet	35	
bookmarks	36	N
		navigation key10
L		networks13
language		notes42
phone	12	P
writing	12	pairing38
limited Warranty	51	phone lock43, 45
locks		picture messaging25–26
phone lock	45	pictures30–31
SIM card	42	adding to contacts15
M		PIN42
magic word	18	
Making emergency calls	14	

PIN code		sending	
changing	43	appointments	41
entering	5	contacts	16
PlayNow™	33	pictures	30
profiles	40	ringtones	34
PUK	42, 45	tasks	42
R		themes	34
radio	32	settings	
recording		email	35
calls	34	Internet	35
sounds	34	picture messages	35
video clips	28	setup wizard	5
redialling		time and date	40
using call list	14	shortcuts	10
reject a call	14	show/hide phone	38
reminders options	41	silent mode	33
restrict dialling	21	SIM card	
ring volume	33	copying to/from	15, 16
ringtone	33	lock	42
ringtones	33	save automatically	16
adding to contacts	15	unblocking	42
S		SOS numbers	14
safety guidelines	48	sound recorder	34
screen saver	30	speaker volume	14
security		standby mode	6
Internet	36	synchronizing	36
SIM card lock	42		

T		W	
T9™ Text Input	12	warranty	51
tasks	41–42	Z	
text messaging	24–25	zoom	29
themes	34		
time	40		
transfer method			
Bluetooth™	37		
USB	38		
transferring files	39		
troubleshooting	44		
turning on/off			
Bluetooth function	37		
phone	5		
phone lock	43		
SIM lock protection	43		
two voice lines	21		
 U			
USB cable	38		
 V			
vibrating alert	33		
video clips	30–31		
video recorder	28–30		
voice dialling	17		
voicemail	17		
volume			
ear speaker	14		

