



FCC RADIO TEST REPORT

FCC ID : PY7-87261H
Equipment : GSM/WCDMA/LTE Phone with BT, DTS/UNII
a/b/g/n/ac/ax, GPS, WPC and NFC
Brand Name : Sony
Applicant : Sony Mobile Communications Inc.
4-12-3 Higashi-Shinagawa, Shinagawa-ku,
Tokyo, 140-0002, Japan
Manufacturer : Sony Mobile Communications Inc.
4-12-3 Higashi-Shinagawa, Shinagawa-ku,
Tokyo, 140-0002, Japan
Standard : FCC Part 15 Subpart E §15.407

The product was received on Dec. 04, 2019 and testing was started from Dec. 19, 2019 and completed on Feb. 19, 2020. We, SPORTON INTERNATIONAL INC., EMC & Wireless Communications Laboratory, would like to declare that the tested sample has been evaluated in accordance with the test procedures and has been in compliance with the applicable technical standards.

The report must not be used by the client to claim product certification, approval, or endorsement by TAF or any agency of government.

The test results in this report apply exclusively to the tested model / sample. Without written approval of SPORTON INTERNATIONAL INC. EMC & Wireless Communications Laboratory, the test report shall not be reproduced except in full.

Louis Wu

Approved by: Louis Wu

SPORTON INTERNATIONAL INC. EMC & Wireless Communications Laboratory
No. 52, Huaya 1st Rd., Guishan Dist., Taoyuan City, Taiwan (R.O.C.)



Table of Contents

History of this test report.....3

Summary of Test Result.....4

1 General Description5

 1.1 Product Feature of Equipment Under Test.....5

 1.2 Modification of EUT5

 1.3 Testing Location6

 1.4 Applicable Standards.....6

2 Test Configuration of Equipment Under Test7

 2.1 Carrier Frequency and Channel7

 2.2 Test Mode.....7

 2.3 Connection Diagram of Test System.....9

 2.4 Support Unit used in test configuration and system11

 2.5 EUT Operation Test Setup11

 2.6 Measurement Results Explanation Example.....11

3 Test Result12

 3.1 6dB and 26dB and 99% Occupied Bandwidth Measurement12

 3.2 Maximum Conducted Output Power Measurement15

 3.3 Power Spectral Density Measurement16

 3.4 Unwanted Emissions Measurement.....19

 3.5 AC Conducted Emission Measurement.....24

 3.6 Automatically Discontinue Transmission26

 3.7 Antenna Requirements.....28

4 List of Measuring Equipment.....29

5 Uncertainty of Evaluation.....31

Appendix A. Conducted Test Results

Appendix B. AC Conducted Emission Test Result

Appendix C. Radiated Spurious Emission

Appendix D. Radiated Spurious Emission Plots

Appendix E. Duty Cycle Plots



History of this test report

Report No.	Version	Description	Issued Date
FR9O1542-02F	01	Initial issue of report	Feb. 04, 2020
FR9O1542-02F	02	Add simultaneous power.	Feb. 20, 2020



Summary of Test Result

Report Clause	Ref Std. Clause	Test Items	Result (PASS/FAIL)	Remark
3.1	15.403 (i)	6dB & 26dB Bandwidth	Pass	-
3.1	2.1049	99% Occupied Bandwidth	Reporting only	-
3.2	15.407 (a)	Maximum Conducted Output Power	Pass	-
3.3	15.407 (a)	Power Spectral Density	Pass	-
3.4	15.407(b)	Unwanted Emissions	Pass	Under limit 5.09 dB at 31.350 MHz for Quasi-Peak
3.5	15.207	AC Conducted Emission	Pass	Under limit 11.64 dB at 1.586 MHz
3.6	15.407 (c)	Automatically Discontinue Transmission	Pass	-
3.7	15.203 & 15.407 (a)	Antenna Requirement	Pass	-

Declaration of Conformity:

The test results with all measurement uncertainty excluded are presented in accordance with the regulation limits or requirements declared by manufacturers.

Comments and Explanations:

The declared of product specification for EUT presented in the report are provided by the manufacturer, and the manufacturer takes all the responsibilities for the accuracy of product specification.

Reviewed by: Wii Chang

Report Producer: Yvonne Cheng



1 General Description

1.1 Product Feature of Equipment Under Test

GSM/WCDMA/LTE, Bluetooth, DTS/UNII a/b/g/n/ac/ax, NFC, GNSS and WPC.

Product Specification subjective to this standard	
Antenna Type / Gain	<Ant. 1>: Loop Antenna with gain -6.50 dBi <Ant. 2>: Monopole Antenna with gain -3.70 dBi

EUT Information List			
HW Version	SW Version	S/N	Performed Test Item
A	0.261	BH9500AVJ7 BH95006JJ7	RF Conducted Measurement
	2.94	QV7100302A QV7100FD2A	Radiated Spurious Emission
	2.38	QV7100Q62A	Conducted Emission

Accessory List	
AC Adapter	Model Name : UCH32
	S/N: 6218W30200178 (for Radiated Spurious Emission) 6218W30200005 (for Conducted Emission)
Earphone	Model Name.: STH40D
	S/N : S458096
Bluetooth Earphone	Model Name : SBH82D
	S/N : N/A
USB Cable	Model Name : UCB24
	S/N : N/A
Audio Cable	Model Name : EC234
	S/N : N/A

Note:

1. Above EUT list used are electrically identical per declared by manufacturer.
2. Above the accessories list are used to exercise the EUT during test, and the serial number of each type of accessories is listed in each section of this report.
3. For other wireless features of this EUT, test report will be issued separately.

1.2 Modification of EUT

No modifications are made to the EUT during all test items.



1.3 Testing Location

Test Site	SPORTON INTERNATIONAL INC. EMC & Wireless Communications Laboratory		
Test Site Location	No.52, Huaya 1st Rd., Guishan Dist., Taoyuan City, Taiwan (R.O.C.) TEL: +886-3-327-3456 FAX: +886-3-328-4978		
Test Site No.	Sporton Site No.		
	TH05-HY	CO05-HY	03CH07-HY

Note: The test site complies with ANSI C63.4 2014 requirement.

FCC designation No.: TW1190

1.4 Applicable Standards

According to the specifications of the manufacturer, the EUT must comply with the requirements of the following standards:

- ♦ FCC Part 15 Subpart E
- ♦ FCC KDB 789033 D02 General UNII Test Procedures New Rules v02r01.
- ♦ FCC KDB 414788 D01 Radiated Test Site v01r01.
- ♦ FCC KDB 662911 D01 Multiple Transmitter Output v02r01.
- ♦ ANSI C63.10-2013

Remark:

1. All test items were verified and recorded according to the standards and without any deviation during the test.
2. This EUT has also been tested and complied with the requirements of FCC Part 15, Subpart B, recorded in a separate test report.



2 Test Configuration of Equipment Under Test

- a. The EUT has been associated with peripherals and configuration operated in a manner tended to maximize its emission characteristics in a typical application. Frequency range investigated: conduction emission (150 kHz to 30 MHz), radiation emission (9 kHz to the 10th harmonic of the highest fundamental frequency or to 40 GHz, whichever is lower). For radiated measurement, pre-scanned in three orthogonal panels, X, Y, Z. The worst cases (X plane) were recorded in this report.
- b. AC power line Conducted Emission was tested under maximum output power.

2.1 Carrier Frequency and Channel

Frequency Band	Channel	Freq. (MHz)	Channel	Freq. (MHz)
5725-5850 MHz Band 4 (U-NII-3)	149	5745	157	5785
	151*	5755	159*	5795
	153	5765	161	5805
	155#	5775	165	5825

Note:

- 1. The above Frequency and Channel in "*" were 802.11n HT40, 802.11ac VHT40, and 802.11ax HE40.
- 2. The above Frequency and Channel in "#" were 802.11ac VHT80 and 802.11ax HE80.

2.2 Test Mode

Final test modes are considering the modulation and worse data rates as below table.

Modulation	Data Rate
802.11a	6 Mbps
802.11n HT20	MCS0
802.11n HT40	MCS0
802.11ac VHT20 (Covered by HT20)	MCS0
802.11ac VHT40 (Covered by HT40)	MCS0
802.11ac VHT80	MCS0
802.11ax HE20	MCS0
802.11ax HE40	MCS0
802.11ax HE80	MCS0



Test Cases	
AC Conducted Emission	Mode 1 : GSM850 Idle + WLAN (5GHz) Link + Bluetooth Link + MPEG4 + USB Cable (Charging from Adapter) + Earphone + Bettery Mode 2 : GSM850 Idle + WLAN (5GHz) Link + Bluetooth Link + MPEG4 + Earphone + Bettery + WPC Charging pad (Charging from Adapter)

Ch. #		Band IV : 5725-5850 MHz			
		802.11a	802.11n HT20	802.11n HT40	802.11ac VHT80
L	Low	149	149	151	-
M	Middle	157	157	-	155
H	High	165	165	159	-

Ch. #		Band IV : 5725-5850 MHz		
		802.11ax HE20	802.11ax HE40	802.11ax HE80
L	Low	149	151	-
M	Middle	157	-	155
H	High	165	159	-

2.3 Connection Diagram of Test System

<AC Conducted Emission>

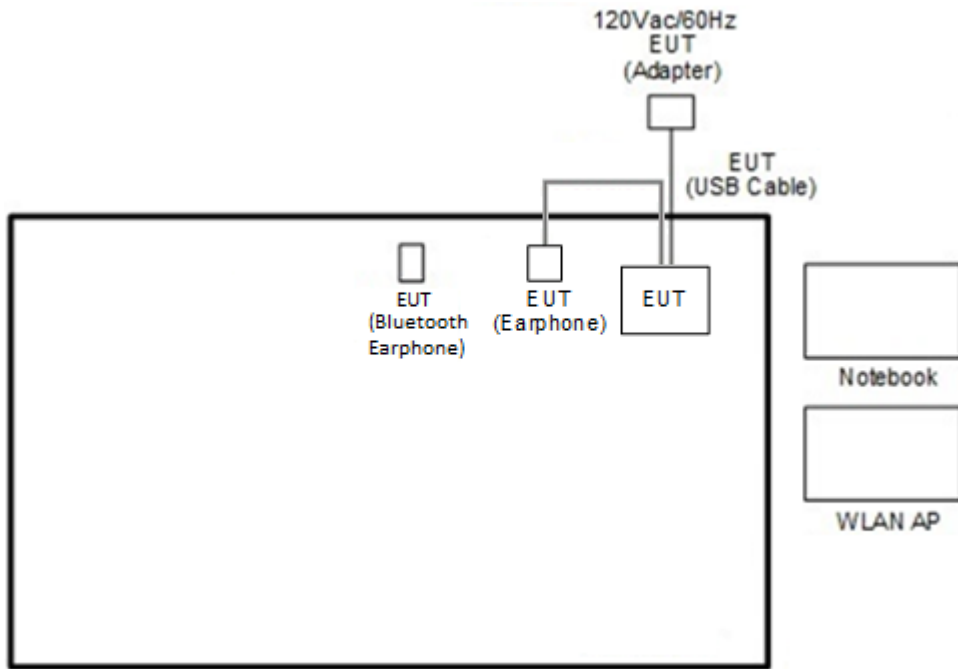

<AC Conducted Emission with WPC Charger>

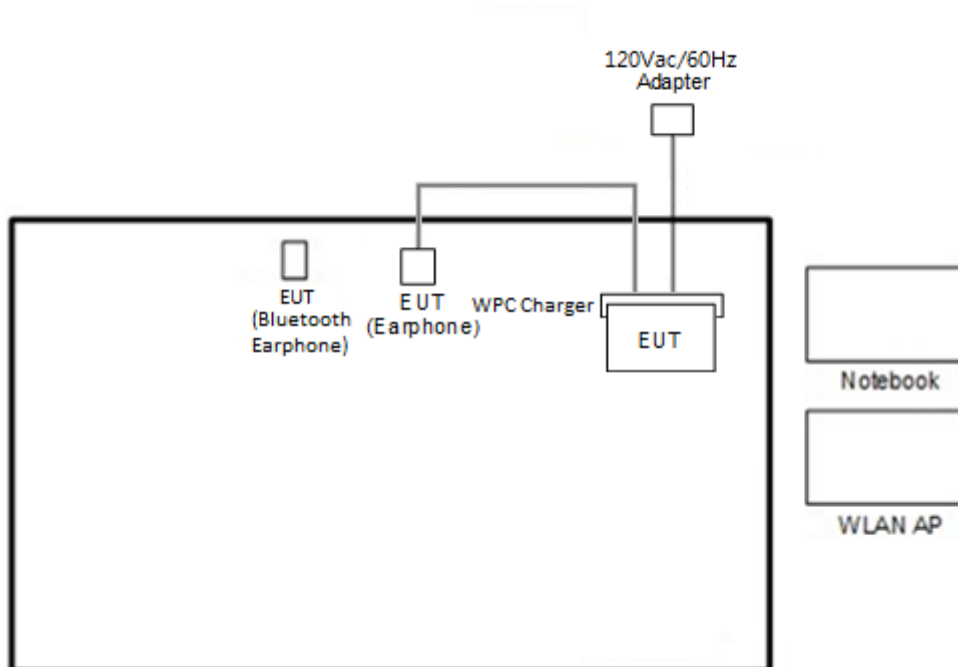

< For Radiated Emissions Measurement >

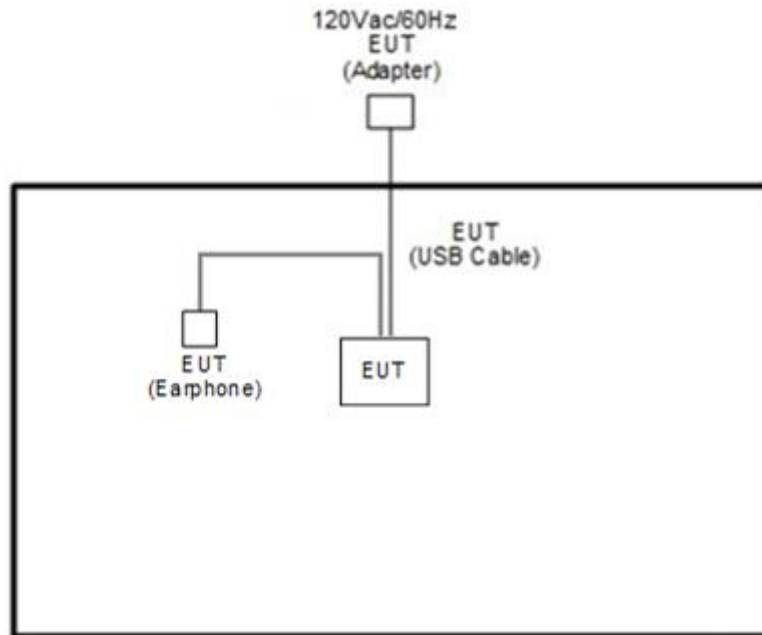

<For Radiated Emissions Measurement with WPC Charger>

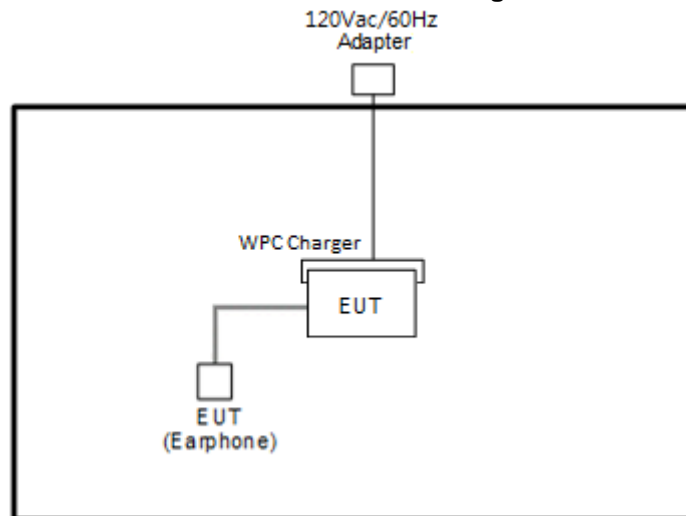



2.4 Support Unit used in test configuration and system

Item	Equipment	Trade Name	Model Name	FCC ID	Data Cable	Power Cord
1.	System Simulator	R&S	CMU 200	N/A	N/A	Unshielded, 1.8 m
2.	WLAN AP	ASUS	RT-AC66U	MSQ-RTAC66U	N/A	Unshielded, 1.8 m
3.	Notebook	DELL	Latitude E3400	FCC DoC	N/A	AC I/P: Unshielded, 1.2 m DC O/P: Shielded, 1.8 m
4.	SD Card	SanDisk	MicroSD HC	FCC DoC	N/A	N/A
5.	Wireless charging pad	belkin	F7U050	N/A	N/A	N/A

2.5 EUT Operation Test Setup

The RF test items, utility “FTMC_bridge_forURC_v0.39” was installed in Notebook which was programmed in order to make the EUT get into the engineering modes to provide channel selection, power level, data rate and the application type and for continuous transmitting signals.

2.6 Measurement Results Explanation Example

For all conducted test items:

The offset level is set in the spectrum analyzer to compensate the RF cable loss and attenuator factor between EUT conducted output port and spectrum analyzer. With the offset compensation, the spectrum analyzer reading level is exactly the EUT RF output level.

Example :

The spectrum analyzer offset is derived from RF cable loss and attenuator factor.

Offset = RF cable loss + attenuator factor.

Following shows an offset computation example with cable loss 4.2 dB and 10dB attenuator.

$$\begin{aligned} \text{Offset(dB)} &= \text{RF cable loss(dB)} + \text{attenuator factor(dB)}. \\ &= 4.2 + 10 = 14.2 \text{ (dB)} \end{aligned}$$

3 Test Result

3.1 6dB and 26dB and 99% Occupied Bandwidth Measurement

3.1.1 Description of 6dB and 26dB and 99% Occupied Bandwidth

The minimum 6 dB bandwidth shall be at least 500 kHz.

26dB and 99% Occupied bandwidth are reporting only.

3.1.2 Measuring Instruments

See list of measuring equipment of this test report.

3.1.3 Test Procedures

1. The testing follows FCC KDB 789033 D02 General UNII Test Procedures New Rules v02r01. Section C) Emission bandwidth for the band 5.725-5.85GHz
2. Set RBW = 100kHz.
3. Set the VBW $\geq 3 \times$ RBW.
4. Detector = Peak.
5. Trace mode = max hold
6. Measure the maximum width of the emission that is 6 dB down from the peak of the emission.
7. Measure and record the results in the test report.

3.1.4 Test Setup

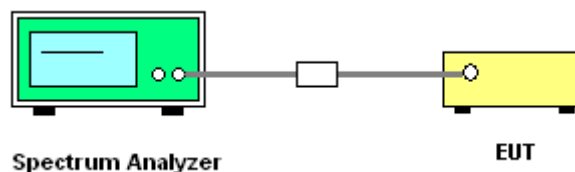

3.1.5 Test Result of 6dB and 26dB and 99% Occupied Bandwidth

Please refer to Appendix A.

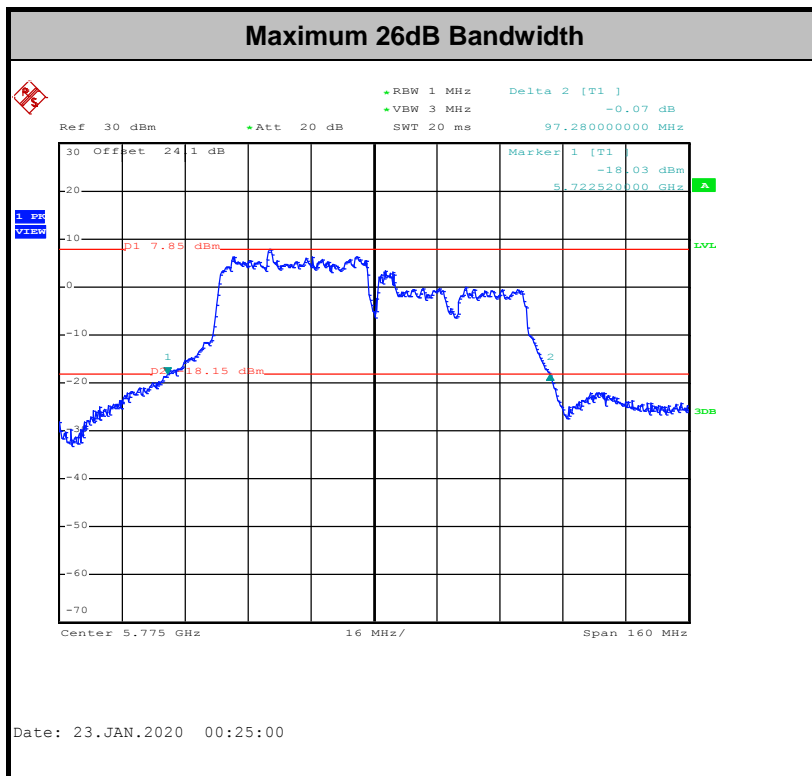
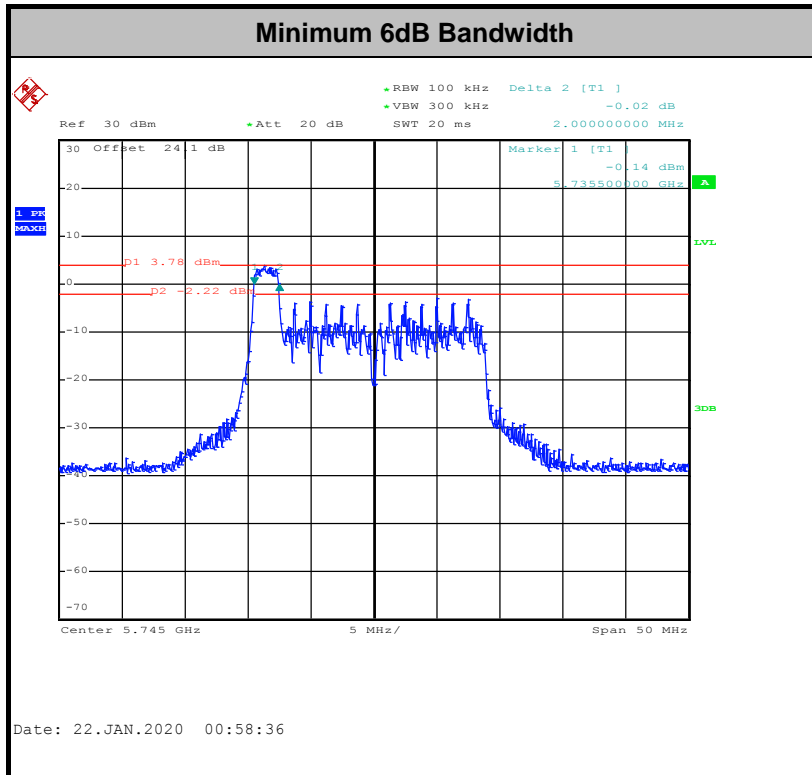

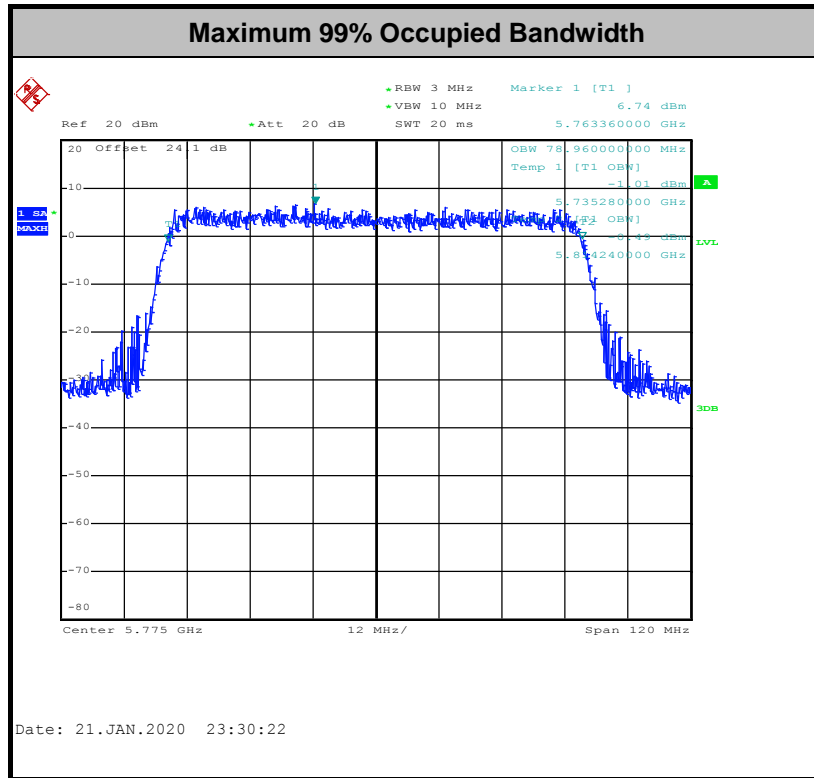

Note: The occupied channel bandwidth is maintained within the band of operation for all of the modulations.

3.2 Maximum Conducted Output Power Measurement

3.2.1 Limit of Maximum Conducted Output Power

For the band 5.725–5.85 GHz, the maximum conducted output power over the frequency band of operation shall not exceed 1 W.

If transmitting antennas of directional gain greater than 6 dBi are used, the peak output power shall be reduced by the amount in dB that the directional gain of the antenna exceeds 6 dBi.

3.2.2 Measuring Instruments

See list of measuring equipment of this test report.

3.2.3 Test Procedures

The testing follows Method PM-G of FCC KDB 789033 D02 General UNII Test Procedures New Rules v02r01.

Method PM-G (Measurement using a gated RF average power meter):

1. Measurement is performed using a wideband RF power meter.
2. The EUT is configured to transmit at its maximum power control level.
3. Measure the average power of the transmitter
4. Since the measurement is made only during the ON time of the transmitter, no duty cycle correction factor is required.

3.2.4 Test Setup

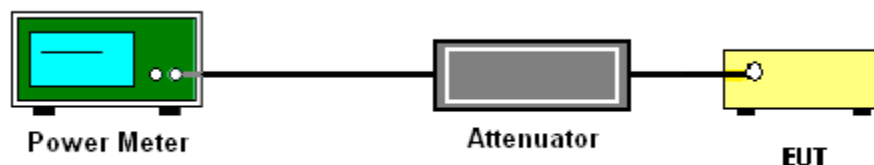

3.2.5 Test Result of Maximum Conducted Output Power

Please refer to Appendix A.



3.3 Power Spectral Density Measurement

3.3.1 Limit of Power Spectral Density

For the band 5.725–5.85 GHz, the maximum power spectral density shall not exceed 30 dBm in any 500-kHz band.

If transmitting antennas of directional gain greater than 6 dBi are used, the peak output power shall be reduced by the amount in dB that the directional gain of the antenna exceeds 6 dBi.

3.3.2 Measuring Instruments

See list of measuring equipment of this test report.

3.3.3 Test Procedures

The testing follows FCC KDB 789033 D02 General UNII Test Procedures New Rules v02r01. Section F) Maximum power spectral density.

Method SA-3

(power averaging (rms) detection with max hold):

- Set span to encompass the entire emission bandwidth (EBW) of the signal.
- Set RBW = 300 kHz.
- Set VBW \geq 1 MHz.
- Number of points in sweep \geq 2 Span / RBW.
- Sweep time \leq (number of points in sweep) \times T, when duty cycle is less than 98 percent where T is the minimum transmission duration over which the transmitter is on and is transmitting at its maximum power control level for the tested mode of operation.
- Detector = power averaging (rms).
- Trace mode = max hold.
- Allow max hold to run for at least 60 seconds, or longer as needed to allow the trace to stabilize.

1. The RF output of EUT was connected to the spectrum analyzer by a low loss cable.
2. Each plot has already offset with cable loss, and attenuator loss. Measure the PPSD and record it.
3. For MIMO mode, calculation method follows FCC KDB 662911 D01 Multiple Transmitter Output v02r01.

Method (c): Measure and add $10 \log(N_{ANT})$ dB.

With this technique, spectrum measurements are performed at each output of the device, but rather than summing the spectra or the spectral peaks across the outputs, the quantity $10 \log(N_{ANT})$ dB is added to each spectrum value before comparing to the emission limit. The addition of $10 \log(N_{ANT})$ dB serves to apportion the emission limit among the N_{ANT} outputs so that each output is permitted to contribute no more than $1/N_{ANT}^{\text{th}}$ of the PSD limit.

3.3.4 Test Setup

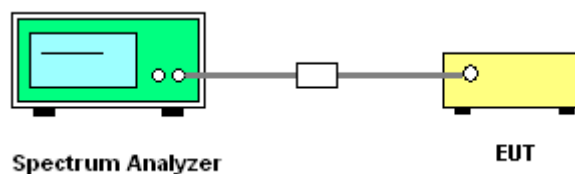



3.3.5 Test Result of Power Spectral Density

Please refer to Appendix A

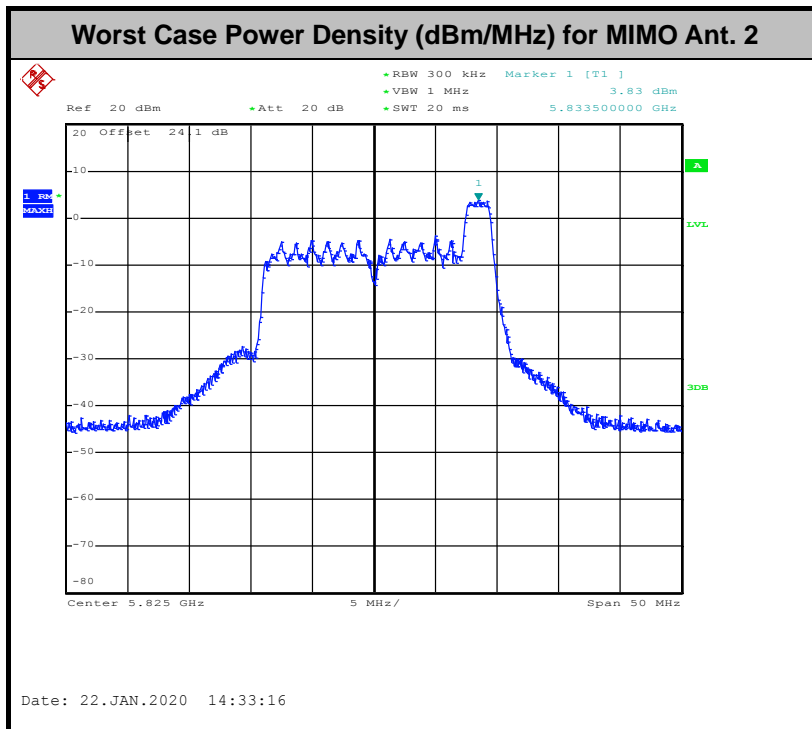
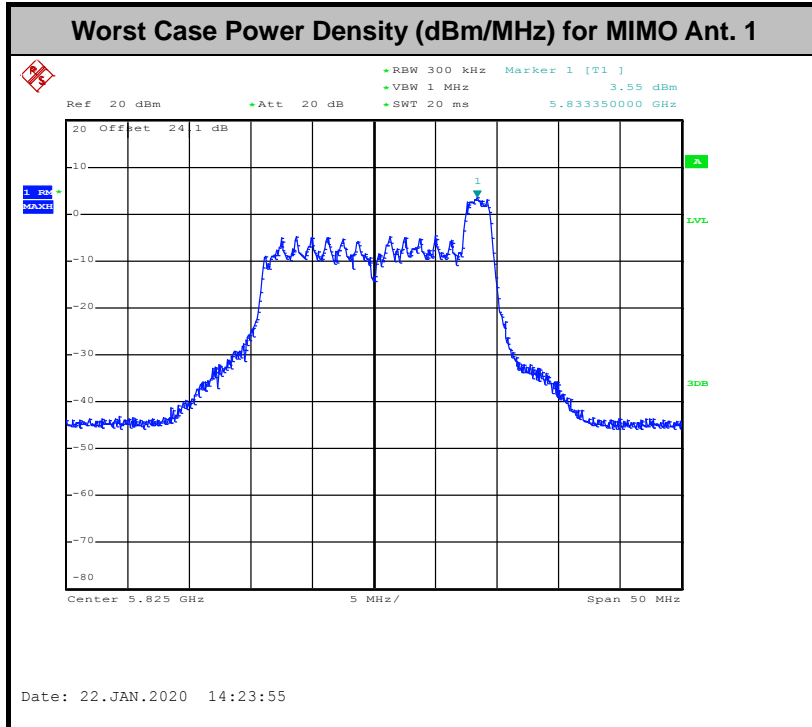



3.4 Unwanted Emissions Measurement

This section is to measure unwanted emissions through radiated measurement for band edge spurious emissions and out of band emissions measurement.

3.4.1 Limit of Unwanted Emissions

- (1) For transmitters operating in the 5.725-5.85 GHz band:
 15.407(b)(4)(i) All emissions shall be limited to a level of -27 dBm/MHz at 75 MHz or more above or below the band edge increasing linearly to 10 dBm/MHz at 25 MHz above or below the band edge, and from 25 MHz above or below the band edge increasing linearly to a level of 15.6 dBm/MHz at 5 MHz above or below the band edge, and from 5 MHz above or below the band edge increasing linearly to a level of 27 dBm/MHz at the band edge.
- (2) Unwanted spurious emissions fallen in restricted bands shall comply with the general field strength limits as below table,

Frequency (MHz)	Field Strength (microvolts/meter)	Measurement Distance (meters)
0.009 – 0.490	2400/F(kHz)	300
0.490 – 1.705	24000/F(kHz)	30
1.705 – 30.0	30	30
30 – 88	100	3
88 – 216	150	3
216 - 960	200	3
Above 960	500	3

Note: The following formula is used to convert the EIRP to field strength.

$$E = \frac{1000000\sqrt{30P}}{3} \text{ } \mu\text{V/m, where P is the eirp (Watts)}$$



EIRP (dBm)	Field Strength at 3m (dBμV/m)
- 27	68.3

(3) KDB789033 D02 v02r01 G)2)c)

- (i) Sections 15.407(b)(1-3) specifies the unwanted emissions limit for the U-NII-1 and U-NII-2 bands. As specified, emissions above 1000 MHz that are outside of the restricted bands are subject to a peak emission limit of -27 dBm/MHz.
- (ii) Section 15.407(b)(4) specifies the unwanted emissions limit for the U-NII-3 band. A band emissions mask is specified in Section 15.407(b)(4)(i). The emission limits are based on the use of a peak detector.

3.4.2 Measuring Instruments

See list of measuring equipment of this test report.

3.4.3 Test Procedures

1. The testing follows FCC KDB 789033 D02 General UNII Test Procedures New Rules v02r01. Section G) Unwanted emissions measurement.

(1) Procedure for Unwanted Emissions Measurements Below 1000MHz

- RBW = 120 kHz
- VBW = 300 kHz
- Detector = Peak
- Trace mode = max hold

(2) Procedure for Peak Unwanted Emissions Measurements Above 1000 MHz

- RBW = 1 MHz
- VBW ≥ 3 MHz
- Detector = Peak
- Sweep time = auto
- Trace mode = max hold

(3) Procedures for Average Unwanted Emissions Measurements Above 1000MHz

- RBW = 1 MHz
- VBW = 10 Hz, when duty cycle is no less than 98 percent.
- VBW ≥ 1/T, when duty cycle is less than 98 percent where T is the minimum transmission duration over which the transmitter is on and is transmitting at its maximum power control level for the tested mode of operation.



2. The EUT was placed on a turntable with 0.8 meter for frequency below 1GHz and 1.5 meter for frequency above 1GHz respectively above ground.
3. The EUT was set 3 meters from the interference receiving antenna which was mounted on the top of a variable height antenna tower.
4. The antenna is a broadband antenna and its height is adjusted between one meter and four meters above ground to find the maximum value of the field strength for both horizontal polarization and vertical polarization of the antenna.
5. For each suspected emission, the EUT was arranged to its worst case and then adjust the antenna tower (from 1 m to 4 m) and turntable (from 0 degree to 360 degrees) to find the maximum reading.
6. For testing below 1GHz, if the emission level of the EUT in peak mode was 3 dB lower than the limit specified, then peak values of EUT will be reported, otherwise, the emissions will be repeated one by one using the CISPR quasi-peak method and reported.
7. For testing above 1GHz, the emission level of the EUT in peak mode was 20dB lower than average limit (that means the emission level in average mode also complies with the limit in average mode), then peak values of EUT will be reported, otherwise, the emissions will be measured in average mode again and reported.

3.4.4 Test Setup

For radiated emissions below 30MHz

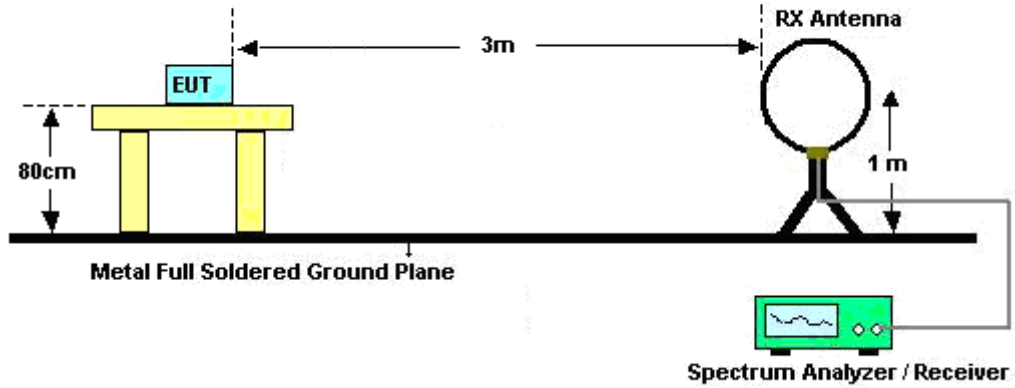

For radiated emissions from 30MHz to 1GHz

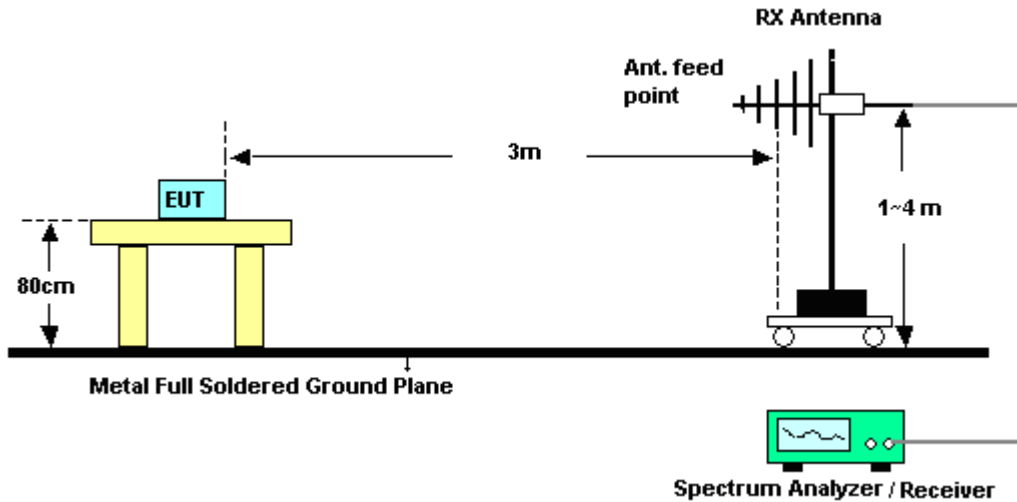

For radiated emissions from 1GHz to 18GHz

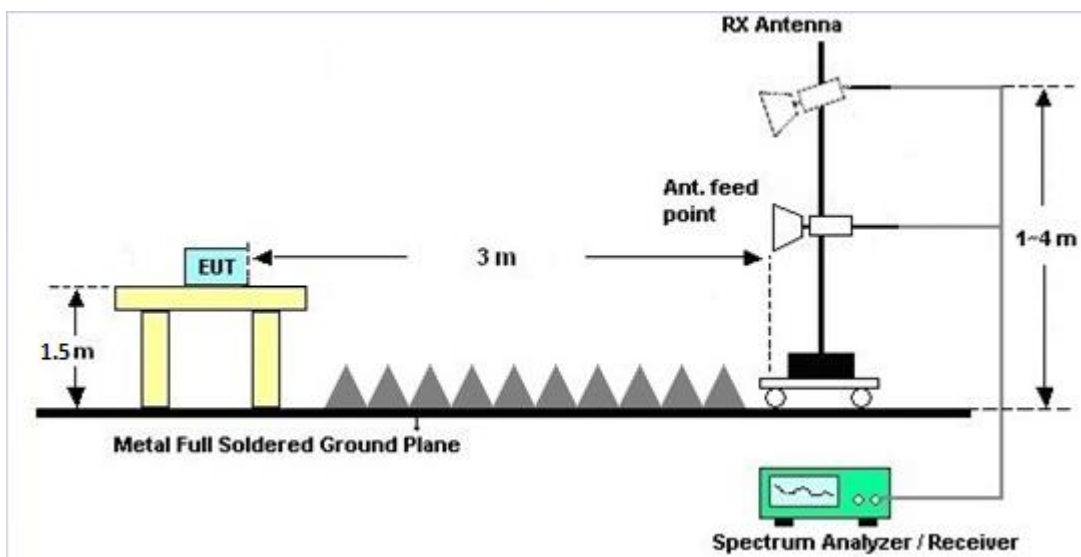

For radiated emissions from 18GHz~40GHz

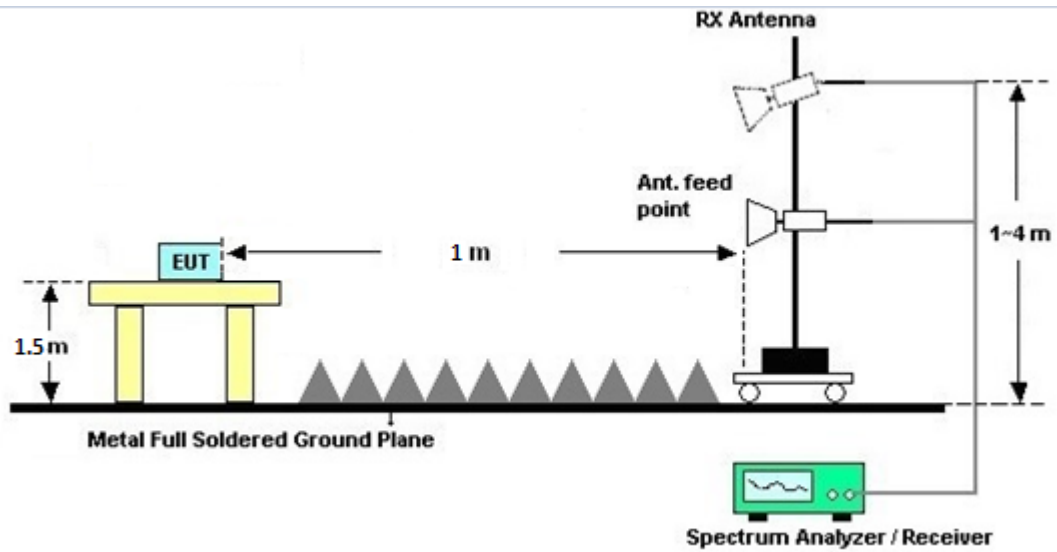

3.4.5 Test Results of Radiated Emissions (9 kHz ~ 30 MHz)

The low frequency, which started from 9 kHz to 30MHz, was pre-scanned and the result which was 20dB lower than the limit line was not reported.

There is a comparison data of both open-field test site and alternative test site - semi-Anechoic chamber according to 414788 D01 Radiated Test Site v01r01, and the result came out very similar.

3.4.6 Test Result of Radiated Band Edges

Please refer to Appendix C and D.

3.4.7 Duty Cycle

Please refer to Appendix E.

3.4.8 Test Result of Unwanted Radiated Emission (30MHz ~ 10th Harmonic)

Please refer to Appendix C and D.



3.5 AC Conducted Emission Measurement

3.5.1 Limit of AC Conducted Emission

For equipment that is designed to be connected to the public utility (AC) power line, the radio frequency voltage that is conducted back onto the AC power line on any frequency or frequencies within the band 150 kHz to 30 MHz shall not exceed the limits in the following table.

Frequency of emission (MHz)	Conducted limit (dB μ V)	
	Quasi-peak	Average
0.15-0.5	66 to 56*	56 to 46*
0.5-5	56	46
5-30	60	50

*Decreases with the logarithm of the frequency.

3.5.2 Measuring Instruments

See list of measuring equipment of this test report.

3.5.3 Test Procedures

1. The EUT was placed 0.4 meter from the conducting wall of the shielding room was kept at least 80 centimeters from any other grounded conducting surface.
2. Connect EUT to the power mains through a line impedance stabilization network (LISN).
3. All the support units are connecting to the other LISN.
4. The LISN provides 50 ohm coupling impedance for the measuring instrument.
5. The FCC states that a 50 ohm, 50 microhenry LISN should be used.
6. Both sides of AC line were checked for maximum conducted interference.
7. The frequency range from 150 kHz to 30 MHz was searched.
8. Set the test-receiver system to Peak Detect Function and specified bandwidth with Maximum Hold Mode.

3.5.4 Test Setup

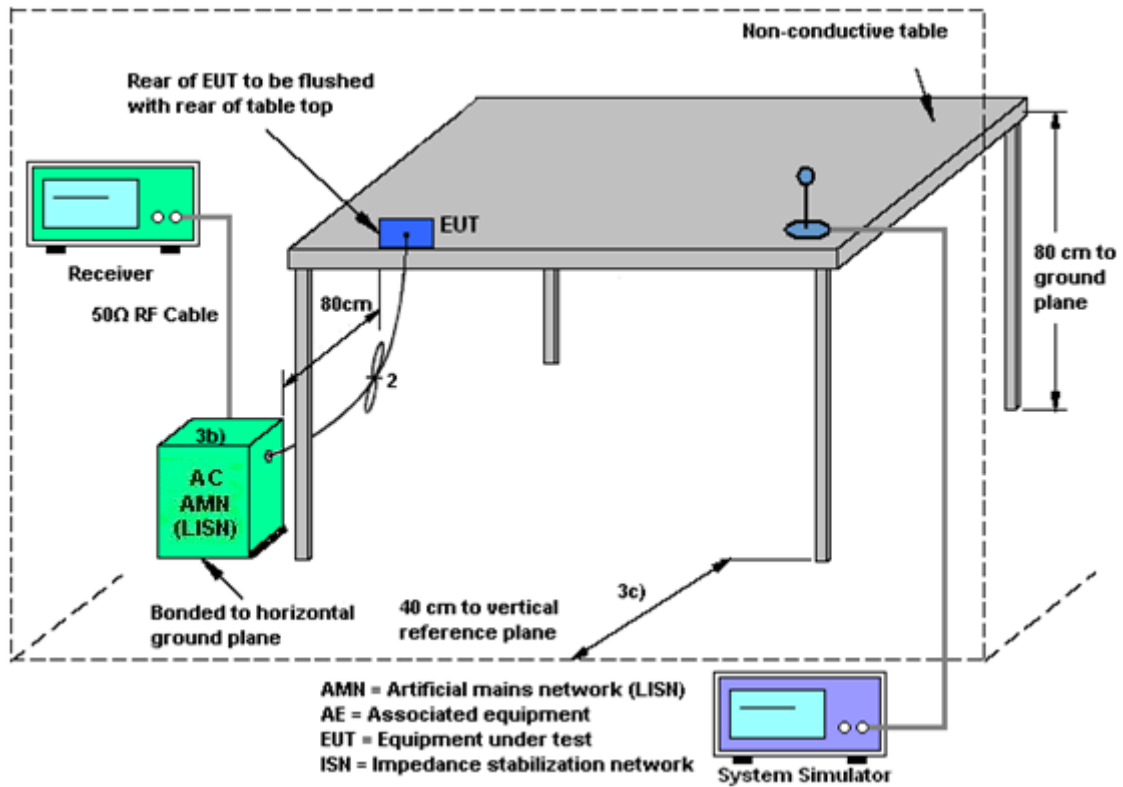

3.5.5 Test Result of AC Conducted Emission

Please refer to Appendix B.



3.6 Automatically Discontinue Transmission

3.6.1 Limit of Automatically Discontinue Transmission

The device shall automatically discontinue transmission in case of either absence of information to transmit or operational failure. These provisions are not intended to preclude the transmission of control or signaling information or the use of repetitive codes used by certain digital technologies to complete frame or burst intervals. Applicants shall include in their application for equipment authorization to describe how this requirement is met.

3.6.2 Measuring Instruments

See list of measuring equipment of this test report.

3.6.3 Test Result of Automatically Discontinue Transmission

EUT is verified this characteristic during the function check of normal sample associated with an access point:

- A. Information start: make EUT supply information to the access point.
- B. Information stop: stop supplying information to the access point.

While the EUT is not transmitting any information, the EUT can automatically discontinue transmission and become standby mode for power saving.

- C. Information start: make EUT supply information to the access point again.

The EUT can detect the controlling signal of ACK message transmitting from remote device and verify whether it shall resend or discontinue transmission.

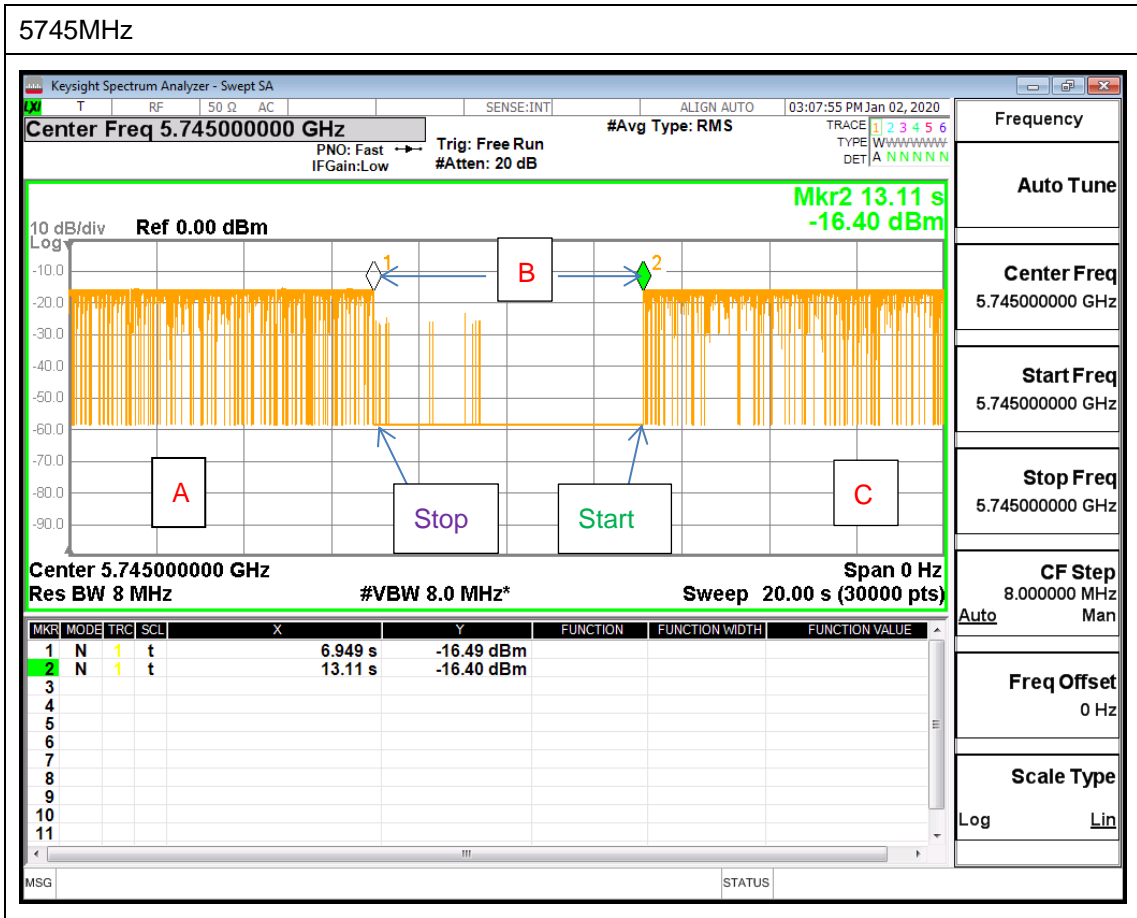

Note : The control / signalling information during the period B is precluded.



3.7 Antenna Requirements

3.7.1 Standard Applicable

If transmitting antenna directional gain is greater than 6 dBi, both the peak transmit power and the peak power spectral density shall be reduced by the amount in dB that the directional gain of the antenna exceeds 6 dBi.

3.7.2 Antenna Anti-Replacement Construction

An embedded-in antenna design is used.

3.7.3 Antenna Gain

<CDD Modes >

FCC KDB 662911 D01 Multiple Transmitter Output v02r01

For CDD transmissions, directional gain is calculated as

Directional gain = GANT + Array Gain, where Array Gain is as follows.

For power spectral density (PSD) measurements on all devices,

Array Gain = 10 log(NANT/NSS=1) dB.

For power measurements on IEEE 802.11 devices,

Array Gain = 0 dB (i.e., no array gain) for NANT ≤ 4.

Directional gain may be calculated by using the formulas applicable to equal gain antennas with GANT set equal to the gain of the antenna having the highest gain;

The EUT supports CDD mode.

For power, the directional gain GANT is set equal to the antenna having the highest gain, i.e., F)2)f)i).

For PSD, the directional gain calculation is following F)2)f)ii) of KDB 662911 D01 v02r01.

The power and PSD limit should be modified if the directional gain of EUT is over 6 dBi,

The directional gain “DG” is calculated as following table.

<CDD Modes>						
			DG	DG	Power	PSD
			for	for	Limit	Limit
	Ant. 1	Ant. 2	Power	PSD	Reduction	Reduction
	(dBi)	(dBi)	(dBi)	(dBi)	(dB)	(dB)
Band IV	-6.50	-3.70	-3.70	-1.98	0.00	0.00

Power Limit Reduction = DG(Power) – 6dBi, (min = 0)

PSD Limit Reduction = DG(PSD) – 6dBi, (min = 0)



4 List of Measuring Equipment

Instrument	Manufacturer	Model No.	Serial No.	Characteristics	Calibration Date	Test Date	Due Date	Remark
Loop Antenna	Rohde & Schwarz	HFH2-Z2	100315	9 kHz~30 MHz	Dec. 26, 2019	Jan. 10, 2020~ Jan. 14, 2020	Dec. 25, 2020	Radiation (03CH07-HY)
Bilog Antenna	TESEQ	CBL 6111D & 00800N1D01 N-06	35419 & 03	30MHz~1GHz	Apr. 30, 2019	Jan. 10, 2020~ Jan. 14, 2020	Apr. 29, 2020	Radiation (03CH07-HY)
Double Ridge Horn Antenna	ESCO	3117	00075962	1GHz ~ 18GHz	Dec. 06, 2019	Jan. 10, 2020~ Jan. 14, 2020	Dec. 05, 2020	Radiation (03CH07-HY)
Preamplifier	MITEQ	AMF-7D-001 01800-30-10 P	1590075	1GHz~18GHz	Apr. 24, 2019	Jan. 10, 2020~ Jan. 14, 2020	Apr. 23, 2020	Radiation (03CH07-HY)
Preamplifier	COM-POWER	PA-103A	161241	10MHz~1GHz	May 20, 2019	Jan. 10, 2020~ Jan. 14, 2020	May 19, 2020	Radiation (03CH07-HY)
Preamplifier	Agilent	8449B	3008A0236 2	1GHz~26.5GHz	Nov. 01, 2019	Jan. 10, 2020~ Jan. 14, 2020	Oct. 31, 2020	Radiation (03CH07-HY)
Preamplifier	EMEC	EM18G40G	060715	18GHz~40GHz	Dec. 12, 2019	Jan. 10, 2020~ Jan. 14, 2020	Dec. 12, 2020	Radiation (03CH07-HY)
EMI Test Receiver	Agilent	N9038A(MX E)	MY532900 53	20Hz~26.5GHz	Jan. 23, 2019	Jan. 10, 2020~ Jan. 14, 2020	Jan. 22, 2020	Radiation (03CH07-HY)
Spectrum Analyzer	Agilent	E4446A	MY501801 36	3Hz~44GHz	Apr. 29, 2019	Jan. 10, 2020~ Jan. 14, 2020	Apr. 28, 2020	Radiation (03CH07-HY)
RF Cable	HUBER + SUHNER	SUCOFLEX 104	MY24971/4 , MY28655/4	9kHz~30MHz	Feb. 26, 2019	Jan. 10, 2020~ Jan. 14, 2020	Feb. 25, 2020	Radiation (03CH07-HY)
RF Cable	HUBER + SUHNER	SUCOFLEX 104	MY28655/4 MY24971/4 MY15682/4	30MHz~1GHz	Feb. 26, 2019	Jan. 10, 2020~ Jan. 14, 2020	Feb. 25, 2020	Radiation (03CH07-HY)
RF Cable	HUBER + SUHNER	SUCOFLEX 104	MY28655/4 MY24971/4 MY15682/4	1GHz~18GHz	Feb. 26, 2019	Jan. 10, 2020~ Jan. 14, 2020	Feb. 25, 2020	Radiation (03CH07-HY)
SHF-EHF Horn Antenna	SCHWARZBE CK	BBHA 9170	BBHA9170 251	18GHz~40GHz	Nov. 26, 2019	Jan. 10, 2020~ Jan. 14, 2020	Nov. 25, 2020	Radiation (03CH07-HY)
Hygrometer	TECPEL	HTC-2	1	N/A	Jun. 17, 2019	Jan. 10, 2020~ Jan. 14, 2020	Jun. 16, 2020	Radiation (03CH07-HY)
Software	Audix	E3 6.2009-8- 24	805040046 56H	N/A	N/A	Jan. 10, 2020~ Jan. 14, 2020	N/A	Radiation (03CH07-HY)



Instrument	Manufacturer	Model No.	Serial No.	Characteristics	Calibration Date	Test Date	Due Date	Remark
Hygrometer	Testo	608-H2	41410069	N/A	Jun. 17, 2019	Dec. 19, 2019~ Feb. 19, 2020	Jun. 16, 2020	Conducted (TH05-HY)
Power Sensor	DARE	RPR3006W	13100030S NO32	9kHz~6GHz	Dec. 17, 2019	Dec. 19, 2019~ Feb. 19, 2020	Dec. 16, 2020	Conducted (TH05-HY)
Spectrum Analyzer	Rohde & Schwarz	FSP40	100055	9kHz-40GHz	Aug. 14, 2019	Dec. 19, 2019~ Feb. 19, 2020	Aug. 13, 2020	Conducted (TH05-HY)
Signal Analyzer	Rohde & Schwarz	FSV40	101566	10Hz~40GHz	Jul. 15, 2019	Dec. 19, 2019~ Feb. 19, 2020	Jul. 14, 2020	Conducted (TH05-HY)
Switch Box & RF Cable	Burgeon	ETF-058	EC1208382	N/A	Mar. 27, 2019	Dec. 19, 2019~ Feb. 19, 2020	Mar. 26, 2020	Conducted (TH05-HY)
AC Power Source	ChainTek	APC-1000W	N/A	N/A	N/A	Dec. 26, 2019~ Jan. 16, 2020	N/A	Conduction (CO05-HY)
EMI Test Receiver	Rohde & Schwarz	ESR3	102388	9kHz~3.6GHz	Nov. 15, 2019	Dec. 26, 2019~ Jan. 16, 2020	Nov. 14, 2020	Conduction (CO05-HY)
Hygrometer	Testo	608-H1	34913912	N/A	Mar. 19, 2019	Dec. 26, 2019~ Jan. 16, 2020	Mar. 18, 2020	Conduction (CO05-HY)
LISN	Rohde & Schwarz	ENV216	100081	9kHz~30MHz	Nov. 15, 2019	Dec. 26, 2019~ Jan. 16, 2020	Nov. 14, 2020	Conduction (CO05-HY)
Software	Rohde & Schwarz	EMC32 V10.30	N/A	N/A	N/A	Dec. 26, 2019~ Jan. 16, 2020	N/A	Conduction (CO05-HY)
LF Cable	HUBER + SUHNER	RG-214/U	LF01	N/A	Dec. 31, 2018	Dec. 26, 2019	Dec. 30, 2019	Conduction (CO05-HY)
LF Cable	HUBER + SUHNER	RG-214/U	LF01	N/A	Jan. 02, 2020	Jan. 16, 2020	Jan. 01, 2021	Conduction (CO05-HY)
Pulse Limiter	Rohde & Schwarz	ESH3-Z2	100851	N/A	Dec. 31, 2018	Dec. 26, 2019	Dec. 30, 2019	Conduction (CO05-HY)
Pulse Limiter	Rohde & Schwarz	ESH3-Z2	100851	N/A	Jan. 02, 2020	Jan. 16, 2020	Jan. 01, 2021	Conduction (CO05-HY)



5 Uncertainty of Evaluation

Uncertainty of Conducted Emission Measurement (150kHz ~ 30MHz)

Measuring Uncertainty for a Level of Confidence of 95% ($U = 2Uc(y)$)	2.0
---	-----

Uncertainty of Radiated Emission Measurement (30 MHz ~ 1000 MHz)

Measuring Uncertainty for a Level of Confidence of 95% ($U = 2Uc(y)$)	4.6
---	-----

Uncertainty of Radiated Emission Measurement (1000 MHz ~ 18000 MHz)

Measuring Uncertainty for a Level of Confidence of 95% ($U = 2Uc(y)$)	5.2
---	-----

Uncertainty of Radiated Emission Measurement (18000 MHz ~ 40000 MHz)

Measuring Uncertainty for a Level of Confidence of 95% ($U = 2Uc(y)$)	5.3
---	-----

Appendix A. Test Result of Conducted Test Items

Test Engineer:	Derek Hsu and Shiming Liu	Temperature:	21~25	°C
Test Date:	2019/12/19~2020/1/23	Relative Humidity:	51~54	%

TEST RESULTS DATA
6dB and 26dB EBW and 99% OBW

Band IV MIMO												
Mod.	Data Rate	NTX	CH.	Freq. (MHz)	99% Bandwidth (MHz)		26dB Bandwidth (MHz)		6 dB Bandwidth (MHz)		6 dB Bandwidth Min. Limit (MHz)	Pass/Fail
					Ant 1	Ant 2	Ant 1	Ant 2	Ant 1	Ant 2		
11a	6Mbps	2	149	5745	16.80	16.75	27.40	27.00	16.35	16.35	0.5	Pass
11a	6Mbps	2	157	5785	16.80	16.75	27.60	26.40	16.30	16.30	0.5	Pass
11a	6Mbps	2	165	5825	16.80	16.75	27.55	26.15	16.35	16.30	0.5	Pass
HT20	MCS0	2	149	5745	16.80	17.85	27.40	26.20	16.34	17.55	0.5	Pass
HT20	MCS0	2	157	5785	17.90	17.85	27.25	26.70	17.55	17.55	0.5	Pass
HT20	MCS0	2	165	5825	16.80	16.70	27.50	26.45	16.30	16.30	0.5	Pass
HT40	MCS0	2	151	5755	36.80	37.00	48.34	48.47	36.36	36.25	0.5	Pass
HT40	MCS0	2	159	5795	36.70	36.80	49.01	47.88	36.36	36.36	0.5	Pass
VHT80	MCS0	2	155	5775	78.00	77.52	92.06	89.12	76.27	76.31	0.5	Pass

TEST RESULTS DATA
Average Power Table

Band IV single antenna												
Mod.	Data Rate	NTX	CH.	Freq. (MHz)	Average Conducted Power (dBm)			FCC Conducted Power Limit (dBm)		DG (dBi)		Pass/Fail
					Ant 1	Ant 2	SUM	Ant 1	Ant 2	Ant 1	Ant 2	
11a	6Mbps	1	149	5745	11.00	11.30		30.00	30.00	-6.50	-3.70	Pass
11a	6Mbps	1	157	5785	11.30	11.20		30.00	30.00	-6.50	-3.70	Pass
11a	6Mbps	1	165	5825	11.40	11.40		30.00	30.00	-6.50	-3.70	Pass
HT20	MCS0	1	149	5745	11.10	11.30		30.00	30.00	-6.50	-3.70	Pass
HT20	MCS0	1	157	5785	11.30	11.20		30.00	30.00	-6.50	-3.70	Pass
HT20	MCS0	1	165	5825	11.40	11.40		30.00	30.00	-6.50	-3.70	Pass
HT40	MCS0	1	151	5755	11.40	11.40		30.00	30.00	-6.50	-3.70	Pass
HT40	MCS0	1	159	5795	11.10	11.10		30.00	30.00	-6.50	-3.70	Pass
VHT20	MCS0	1	149	5745	11.00	11.20		30.00	30.00	-6.50	-3.70	Pass
VHT20	MCS0	1	157	5785	11.20	11.10		30.00	30.00	-6.50	-3.70	Pass
VHT20	MCS0	1	165	5825	11.30	11.30		30.00	30.00	-6.50	-3.70	Pass
VHT40	MCS0	1	151	5755	11.30	11.30		30.00	30.00	-6.50	-3.70	Pass
VHT40	MCS0	1	159	5795	11.00	11.00		30.00	30.00	-6.50	-3.70	Pass
VHT80	MCS0	1	155	5775	11.40	11.30		30.00	30.00	-6.50	-3.70	Pass

Band IV MIMO												
Mod.	Data Rate	NTX	CH.	Freq. (MHz)	Average Conducted Power (dBm)			FCC Conducted Power Limit (dBm)		DG (dBi)		Pass/Fail
					Ant 1	Ant 2	SUM	Ant 1	Ant 2	Ant 1	Ant 2	
11a	6Mbps	2	149	5745	11.00	11.40	14.21	30.00		-3.70		Pass
11a	6Mbps	2	157	5785	11.30	11.30	14.31	30.00		-3.70		Pass
11a	6Mbps	2	165	5825	11.40	11.40	14.41	30.00		-3.70		Pass
HT20	MCS0	2	149	5745	11.10	11.40	14.26	30.00		-3.70		Pass
HT20	MCS0	2	157	5785	11.30	11.30	14.31	30.00		-3.70		Pass
HT20	MCS0	2	165	5825	11.40	11.40	14.41	30.00		-3.70		Pass
HT40	MCS0	2	151	5755	11.40	11.40	14.41	30.00		-3.70		Pass
HT40	MCS0	2	159	5795	11.10	11.10	14.11	30.00		-3.70		Pass
VHT20	MCS0	2	149	5745	11.00	11.30	14.16	30.00		-3.70		Pass
VHT20	MCS0	2	157	5785	11.20	11.20	14.21	30.00		-3.70		Pass
VHT20	MCS0	2	165	5825	11.30	11.30	14.31	30.00		-3.70		Pass
VHT40	MCS0	2	151	5755	11.30	11.30	14.31	30.00		-3.70		Pass
VHT40	MCS0	2	159	5795	11.00	11.00	14.01	30.00		-3.70		Pass
VHT80	MCS0	2	155	5775	11.40	11.30	14.36	30.00		-3.70		Pass

TEST RESULTS DATA
Power Spectral Density

Band IV MIMO														
Mod.	Data Rate	NTX	CH.	Freq. (MHz)	10log (500kHz /RBW) Factor (dB)		Average Power Density (dBm/500kHz)			Average PSD Limit (dBm/500kHz)		DG (dBi)		Pass /Fail
					Ant 1	Ant 2	Ant 1	Ant 2	SUM	Ant 1	Ant 2	Ant 1	Ant 2	
11a	6Mbps	2	149	5745	2.22		-1.35	-0.46	2.55	30.00		-1.98	Pass	
11a	6Mbps	2	157	5785	2.22		-1.06	-0.42	2.59	30.00		-1.98	Pass	
11a	6Mbps	2	165	5825	2.22		-1.17	-0.21	2.80	30.00		-1.98	Pass	
HT20	MCS0	2	149	5745	2.22		-1.25	-0.47	2.54	30.00		-1.98	Pass	
HT20	MCS0	2	157	5785	2.22		-1.01	-0.63	2.38	30.00		-1.98	Pass	
HT20	MCS0	2	165	5825	2.22		-0.84	-0.43	2.58	30.00		-1.98	Pass	
HT40	MCS0	2	151	5755	2.22		-4.03	-3.24	-0.23	30.00		-1.98	Pass	
HT40	MCS0	2	159	5795	2.22		-4.79	-3.90	-0.89	30.00		-1.98	Pass	
VHT80	MCS0	2	155	5775	2.22		-6.94	-6.51	-3.50	30.00		-1.98	Pass	

Note: PSD Sum = Max PSD(Ant. 1, Ant. 2) + 10 log (n)

TEST RESULTS DATA
6dB and 26dB EBW and 99% OBW

Band IV MIMO													
Mod.	Data Rate	NTX	CH.	Freq. (MHz)	RU Config	99% Bandwidth (MHz)		26dB Bandwidth (MHz)		6 dB Bandwidth (MHz)		6 dB Bandwidth Min. Limit (MHz)	Pass/Fail
						Ant 1	Ant 2	Ant 1	Ant 2	Ant 1	Ant 2		
HE20	MCS0	2	149	5745	Full	19.10	19.05	25.90	26.30	18.90	18.95	0.5	Pass
HE20	MCS0	2	149	5745	26/0	18.50	18.50	22.30	21.65	2.05	2.00	0.5	Pass
HE20	MCS0	2	149	5745	52/37	18.30	18.25	24.35	24.65	16.90	16.90	0.5	Pass
HE20	MCS0	2	149	5745	106/53	18.25	18.30	26.30	26.60	17.10	17.15	0.5	Pass
HE20	MCS0	2	157	5785	Full	19.10	19.15	26.10	26.05	18.95	18.90	0.5	Pass
HE20	MCS0	2	165	5825	Full	19.10	19.10	25.20	26.70	18.90	18.90	0.5	Pass
HE20	MCS0	2	165	5825	26/8	18.70	18.40	22.60	21.85	2.05	2.10	0.5	Pass
HE20	MCS0	2	165	5825	52/40	18.50	18.35	23.50	24.20	17.05	16.95	0.5	Pass
HE20	MCS0	2	165	5825	106/54	18.45	18.30	25.70	26.45	17.10	17.20	0.5	Pass
HE40	MCS0	2	151	5755	Full	38.10	38.30	46.44	46.13	38.05	38.16	0.5	Pass
HE40	MCS0	2	151	5755	242/61	37.60	37.90	46.26	45.67	36.63	36.79	0.5	Pass
HE40	MCS0	2	159	5795	Full	38.30	38.20	46.14	46.80	37.97	37.93	0.5	Pass
HE40	MCS0	2	159	5795	242/62	37.70	37.80	47.34	59.09	36.90	36.54	0.5	Pass
HE80	MCS0	2	155	5775	Full	78.96	78.96	88.00	87.36	78.27	78.26	0.5	Pass
HE80	MCS0	2	155	5775	484/65	78.24	78.36	89.60	97.28	76.48	76.88	0.5	Pass
HE80	MCS0	2	155	5775	484/66	78.60	78.36	91.52	93.88	76.80	76.59	0.5	Pass

TEST RESULTS DATA
Average Power Table

Band IV single antenna													
Mod.	Data Rate	NTX	CH.	Freq. (MHz)	RU Config	Average Conducted Power (dBm)			FCC Conducted Power Limit (dBm)		DG (dBi)		Pass/Fail
						Ant 1	Ant 2	SUM	Ant 1	Ant 2	Ant 1	Ant 2	
HE20	MCS0	1	149	5745	Full	11.30	11.30		30.00	30.00	-6.50	-3.70	Pass
HE20	MCS0	1	149	5745	26/0	8.70	8.60		30.00	30.00	-6.50	-3.70	Pass
HE20	MCS0	1	149	5745	52/37	11.20	11.10		30.00	30.00	-6.50	-3.70	Pass
HE20	MCS0	1	149	5745	106/53	11.30	11.20		30.00	30.00	-6.50	-3.70	Pass
HE20	MCS0	1	157	5785	Full	11.30	11.20		30.00	30.00	-6.50	-3.70	Pass
HE20	MCS0	1	157	5785	26/4	8.60	8.80		30.00	30.00	-6.50	-3.70	Pass
HE20	MCS0	1	157	5785	52/38	11.10	11.20		30.00	30.00	-6.50	-3.70	Pass
HE20	MCS0	1	157	5785	106/53	11.20	11.10		30.00	30.00	-6.50	-3.70	Pass
HE20	MCS0	1	165	5825	Full	11.10	11.20		30.00	30.00	-6.50	-3.70	Pass
HE20	MCS0	1	165	5825	26/8	8.60	8.80		30.00	30.00	-6.50	-3.70	Pass
HE20	MCS0	1	165	5825	52/40	11.10	11.10		30.00	30.00	-6.50	-3.70	Pass
HE20	MCS0	1	165	5825	106/54	11.30	11.20		30.00	30.00	-6.50	-3.70	Pass
HE40	MCS0	1	151	5755	Full	11.10	11.30		30.00	30.00	-6.50	-3.70	Pass
HE40	MCS0	1	151	5755	242/61	11.10	11.30		30.00	30.00	-6.50	-3.70	Pass
HE40	MCS0	1	159	5795	Full	11.20	11.20		30.00	30.00	-6.50	-3.70	Pass
HE40	MCS0	1	159	5795	242/62	11.10	11.20		30.00	30.00	-6.50	-3.70	Pass
HE80	MCS0	1	155	5775	Full	11.20	11.30		30.00	30.00	-6.50	-3.70	Pass
HE80	MCS0	1	155	5775	484/65	11.30	11.10		30.00	30.00	-6.50	-3.70	Pass
HE80	MCS0	1	155	5775	484/66	11.20	11.10		30.00	30.00	-6.50	-3.70	Pass

Band IV MIMO													
Mod.	Data Rate	NTX	CH.	Freq. (MHz)	RU Config	Average Conducted Power (dBm)			FCC Conducted Power Limit (dBm)		DG (dBi)		Pass/Fail
						Ant 1	Ant 2	SUM	Ant 1	Ant 2	Ant 1	Ant 2	
HE20	MCS0	2	149	5745	Full	11.40	11.40	14.41	30.00		-3.70		Pass
HE20	MCS0	2	149	5745	26/0	8.80	8.70	11.76	30.00		-3.70		Pass
HE20	MCS0	2	149	5745	52/37	11.30	11.20	14.26	30.00		-3.70		Pass
HE20	MCS0	2	149	5745	106/53	11.40	11.30	14.36	30.00		-3.70		Pass
HE20	MCS0	2	157	5785	Full	11.40	11.30	14.36	30.00		-3.70		Pass
HE20	MCS0	2	157	5785	26/4	8.70	8.90	11.81	30.00		-3.70		Pass
HE20	MCS0	2	157	5785	52/38	11.20	11.30	14.26	30.00		-3.70		Pass
HE20	MCS0	2	157	5785	106/53	11.30	11.20	14.26	30.00		-3.70		Pass
HE20	MCS0	2	165	5825	Full	11.20	11.30	14.26	30.00		-3.70		Pass
HE20	MCS0	2	165	5825	26/8	8.70	8.90	11.81	30.00		-3.70		Pass
HE20	MCS0	2	165	5825	52/40	11.20	11.20	14.21	30.00		-3.70		Pass
HE20	MCS0	2	165	5825	106/54	11.40	11.30	14.36	30.00		-3.70		Pass
HE40	MCS0	2	151	5755	Full	11.20	11.40	14.31	30.00		-3.70		Pass
HE40	MCS0	2	151	5755	242/61	11.20	11.40	14.31	30.00		-3.70		Pass
HE40	MCS0	2	159	5795	Full	11.30	11.30	14.31	30.00		-3.70		Pass
HE40	MCS0	2	159	5795	242/62	11.20	11.30	14.26	30.00		-3.70		Pass
HE80	MCS0	2	155	5775	Full	11.30	11.40	14.36	30.00		-3.70		Pass
HE80	MCS0	2	155	5775	484/65	11.40	11.20	14.31	30.00		-3.70		Pass
HE80	MCS0	2	155	5775	484/66	11.30	11.20	14.26	30.00		-3.70		Pass

TEST RESULTS DATA
Power Spectral Density

Band IV MIMO																
Mod.	Data Rate	NTX	CH.	Freq. (MHz)	RU Config.	10log (500kHz /RBW) Factor (dB)			Average Power Density (dBm/500kHz)			Average PSD Limit (dBm/500kHz)		DG (dBi)		Pass /Fail
						Ant 1	Ant 2	SUM	Ant 1	Ant 2	SUM	Ant 1	Ant 2	Ant 1	Ant 2	
HE20	MCS0	2	149	5745	Full	2.22	-1.20	-1.11	1.90	30.00	-1.98	Pass				
HE20	MCS0	2	149	5745	26/0	2.22	4.97	5.03	8.04	30.00	-1.98	Pass				
HE20	MCS0	2	149	5745	52/37	2.22	5.25	5.13	8.26	30.00	-1.98	Pass				
HE20	MCS0	2	149	5745	106/53	2.22	2.53	2.21	5.54	30.00	-1.98	Pass				
HE20	MCS0	2	157	5785	Full	2.22	-1.01	-0.80	2.21	30.00	-1.98	Pass				
HE20	MCS0	2	157	5785	26/4	2.22	4.64	4.87	7.88	30.00	-1.98	Pass				
HE20	MCS0	2	157	5785	52/38	2.22	5.18	5.17	8.19	30.00	-1.98	Pass				
HE20	MCS0	2	157	5785	106/53	2.22	2.30	2.19	5.31	30.00	-1.98	Pass				
HE20	MCS0	2	165	5825	Full	2.22	-1.19	-1.21	1.82	30.00	-1.98	Pass				
HE20	MCS0	2	165	5825	26/8	2.22	5.77	6.05	9.06	30.00	-1.98	Pass				
HE20	MCS0	2	165	5825	52/40	2.22	4.86	5.27	8.28	30.00	-1.98	Pass				
HE20	MCS0	2	165	5825	106/54	2.22	2.13	2.11	5.14	30.00	-1.98	Pass				
HE40	MCS0	2	151	5755	Full	2.22	-4.16	-4.08	-1.07	30.00	-1.98	Pass				
HE40	MCS0	2	151	5755	242/61	2.22	-1.48	-1.35	1.66	30.00	-1.98	Pass				
HE40	MCS0	2	159	5795	Full	2.22	-4.45	-4.47	-1.44	30.00	-1.98	Pass				
HE40	MCS0	2	159	5795	242/62	2.22	-1.72	-1.47	1.54	30.00	-1.98	Pass				
HE80	MCS0	2	155	5775	Full	2.22	-6.63	-6.35	-3.34	30.00	-1.98	Pass				
HE80	MCS0	2	155	5775	484/65	2.22	-4.14	-4.17	-1.13	30.00	-1.98	Pass				
HE80	MCS0	2	155	5775	484/66	2.22	-4.15	-4.48	-1.14	30.00	-1.98	Pass				

Note: PSD Sum = Max PSD(Ant. 1, Ant. 2) + 10 log (n)

<Simultaneous Mode>

Test Engineer:	Howard Lin	Temperature:	21~25	°C
Test Date:	2020/1/15	Relative Humidity:	51~54	%

TEST RESULTS DATA
Average Power Table

Band IV single antenna												
Mod.	Data Rate	NTX	CH.	Freq. (MHz)	Average Conducted Power (dBm)			FCC Conducted Power Limit (dBm)		DG (dBi)		Pass/Fail
					Ant 1	Ant 2	SUM	Ant 1	Ant 2	Ant 1	Ant 2	
11a	6Mbps	1	149	5745	9.30	9.40		30.00	30.00	-6.50	-3.70	Pass
11a	6Mbps	1	157	5785	9.10	9.40		30.00	30.00	-6.50	-3.70	Pass
11a	6Mbps	1	165	5825	9.20	9.40		30.00	30.00	-6.50	-3.70	Pass
HT20	MCS0	1	149	5745	9.40	9.30		30.00	30.00	-6.50	-3.70	Pass
HT20	MCS0	1	157	5785	9.20	9.40		30.00	30.00	-6.50	-3.70	Pass
HT20	MCS0	1	165	5825	9.20	9.40		30.00	30.00	-6.50	-3.70	Pass
HT40	MCS0	1	151	5755	9.30	9.40		30.00	30.00	-6.50	-3.70	Pass
HT40	MCS0	1	159	5795	9.30	9.30		30.00	30.00	-6.50	-3.70	Pass
VHT20	MCS0	1	149	5745	9.30	9.20		30.00	30.00	-6.50	-3.70	Pass
VHT20	MCS0	1	157	5785	9.10	9.30		30.00	30.00	-6.50	-3.70	Pass
VHT20	MCS0	1	165	5825	9.10	9.30		30.00	30.00	-6.50	-3.70	Pass
VHT40	MCS0	1	151	5755	9.20	9.30		30.00	30.00	-6.50	-3.70	Pass
VHT40	MCS0	1	159	5795	9.20	9.20		30.00	30.00	-6.50	-3.70	Pass
VHT80	MCS0	1	155	5775	9.20	9.10		30.00	30.00	-6.50	-3.70	Pass

Band IV MIMO												
Mod.	Data Rate	NTX	CH.	Freq. (MHz)	Average Conducted Power (dBm)			FCC Conducted Power Limit (dBm)		DG (dBi)		Pass/Fail
					Ant 1	Ant 2	SUM	Ant 1	Ant 2	Ant 1	Ant 2	
11a	6Mbps	2	149	5745	9.40	9.50	12.46	30.00		-3.70		Pass
11a	6Mbps	2	157	5785	9.20	9.50	12.36	30.00		-3.70		Pass
11a	6Mbps	2	165	5825	9.30	9.50	12.41	30.00		-3.70		Pass
HT20	MCS0	2	149	5745	9.50	9.40	12.46	30.00		-3.70		Pass
HT20	MCS0	2	157	5785	9.30	9.50	12.41	30.00		-3.70		Pass
HT20	MCS0	2	165	5825	9.30	9.50	12.41	30.00		-3.70		Pass
HT40	MCS0	2	151	5755	9.40	9.50	12.46	30.00		-3.70		Pass
HT40	MCS0	2	159	5795	9.40	9.40	12.41	30.00		-3.70		Pass
VHT20	MCS0	2	149	5745	9.40	9.30	12.36	30.00		-3.70		Pass
VHT20	MCS0	2	157	5785	9.20	9.40	12.31	30.00		-3.70		Pass
VHT20	MCS0	2	165	5825	9.20	9.40	12.31	30.00		-3.70		Pass
VHT40	MCS0	2	151	5755	9.30	9.40	12.36	30.00		-3.70		Pass
VHT40	MCS0	2	159	5795	9.30	9.30	12.31	30.00		-3.70		Pass
VHT80	MCS0	2	155	5775	9.30	9.20	12.26	30.00		-3.70		Pass

TEST RESULTS DATA
Average Power Table

Band IV single antenna													
Mod.	Data Rate	NTX	CH.	Freq. (MHz)	RU Config	Average Conducted Power (dBm)			FCC Conducted Power Limit (dBm)		DG (dBi)		Pass/Fail
						Ant 1	Ant 2	SUM	Ant 1	Ant 2	Ant 1	Ant 2	
HE20	MCS0	1	149	5745	Full	9.20	9.20		30.00	30.00	-6.50	-3.70	Pass
HE20	MCS0	1	157	5785	Full	9.20	9.40		30.00	30.00	-6.50	-3.70	Pass
HE20	MCS0	1	165	5825	Full	9.40	9.30		30.00	30.00	-6.50	-3.70	Pass
HE40	MCS0	1	151	5755	Full	9.20	9.40		30.00	30.00	-6.50	-3.70	Pass
HE40	MCS0	1	159	5795	Full	9.20	9.40		30.00	30.00	-6.50	-3.70	Pass
HE80	MCS0	1	155	5775	Full	9.10	9.10		30.00	30.00	-6.50	-3.70	Pass

Band IV MIMO													
Mod.	Data Rate	NTX	CH.	Freq. (MHz)	RU Config	Average Conducted Power (dBm)			FCC Conducted Power Limit (dBm)		DG (dBi)		Pass/Fail
						Ant 1	Ant 2	SUM	Ant 1	Ant 2	Ant 1	Ant 2	
HE20	MCS0	1	149	5745	Full	9.30	9.30	12.31	30.00	30.00	-3.70	-3.70	Pass
HE20	MCS0	1	157	5785	Full	9.30	9.50	12.41	30.00	30.00	-3.70	-3.70	Pass
HE20	MCS0	1	165	5825	Full	9.50	9.40	12.46	30.00	30.00	-3.70	-3.70	Pass
HE40	MCS0	1	151	5755	Full	9.30	9.50	12.41	30.00	30.00	-3.70	-3.70	Pass
HE40	MCS0	1	159	5795	Full	9.30	9.50	12.41	30.00	30.00	-3.70	-3.70	Pass
HE80	MCS0	1	155	5775	Full	9.20	9.20	12.21	30.00	30.00	-3.70	-3.70	Pass



Appendix B. AC Conducted Emission Test Results

Test Engineer :	Howard Huang and Tom Lee	Temperature :	22~25°C
		Relative Humidity :	45~52%

EUT Information

Report NO : 901542-02
 Test Mode : Mode 1
 Test Voltage : 120Vac/60Hz
 Phase : Line

Full Spectrum

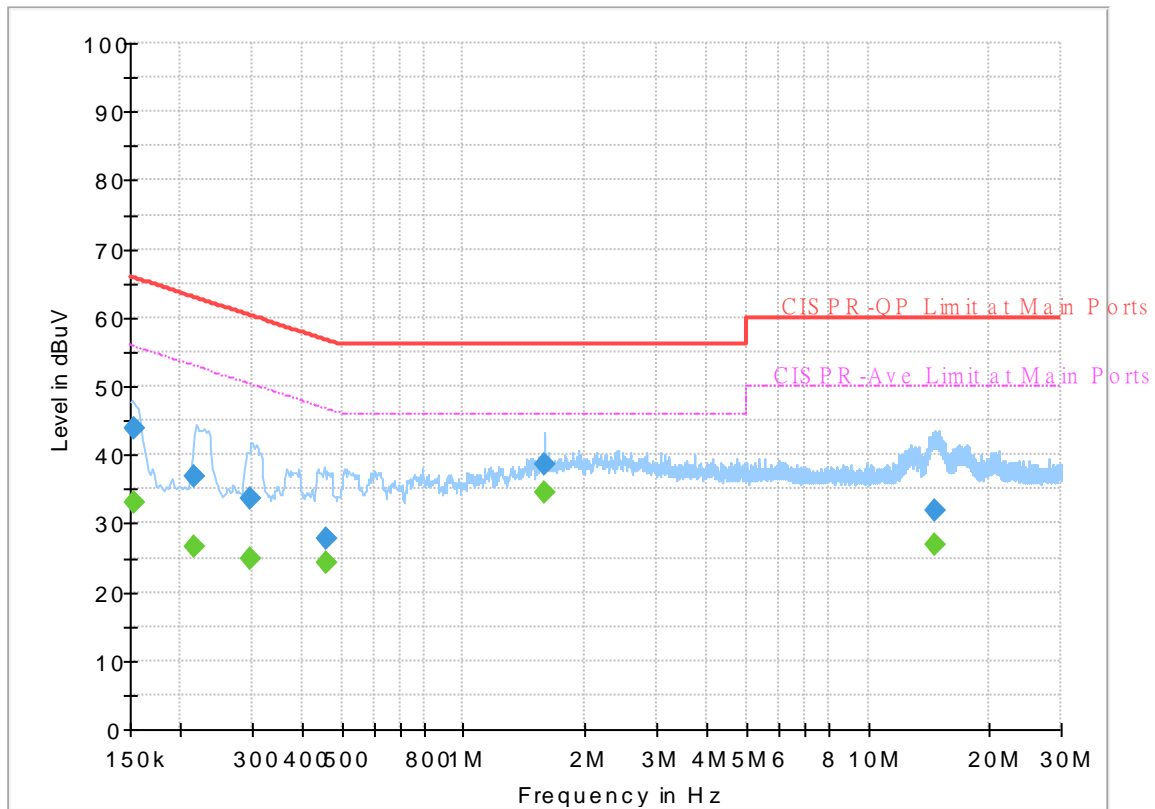

Final_Result

Frequency (MHz)	QuasiPeak (dBuV)	CAverage (dBuV)	Limit (dBuV)	Margin (dB)	Line	Filter	Corr. (dB)
0.153983	---	32.96	55.78	22.82	L1	OFF	19.5
0.153983	43.93	---	65.78	21.85	L1	OFF	19.5
0.217140	---	26.61	52.93	26.32	L1	OFF	19.5
0.217140	36.89	---	62.93	26.04	L1	OFF	19.5
0.298140	---	24.80	50.29	25.49	L1	OFF	19.5
0.298140	33.59	---	60.29	26.70	L1	OFF	19.5
0.455640	---	24.15	46.77	22.62	L1	OFF	19.5
0.455640	27.74	---	56.77	29.03	L1	OFF	19.5
1.585680	---	34.36	46.00	11.64	L1	OFF	19.6
1.585680	38.52	---	56.00	17.48	L1	OFF	19.6
14.581050	---	26.96	50.00	23.04	L1	OFF	20.0
14.581050	31.96	---	60.00	28.04	L1	OFF	20.0

EUT Information

Report NO : 9O1542-02
 Test Mode : Mode 1
 Test Voltage : 120Vac/60Hz
 Phase : Neutral

Full Spectrum

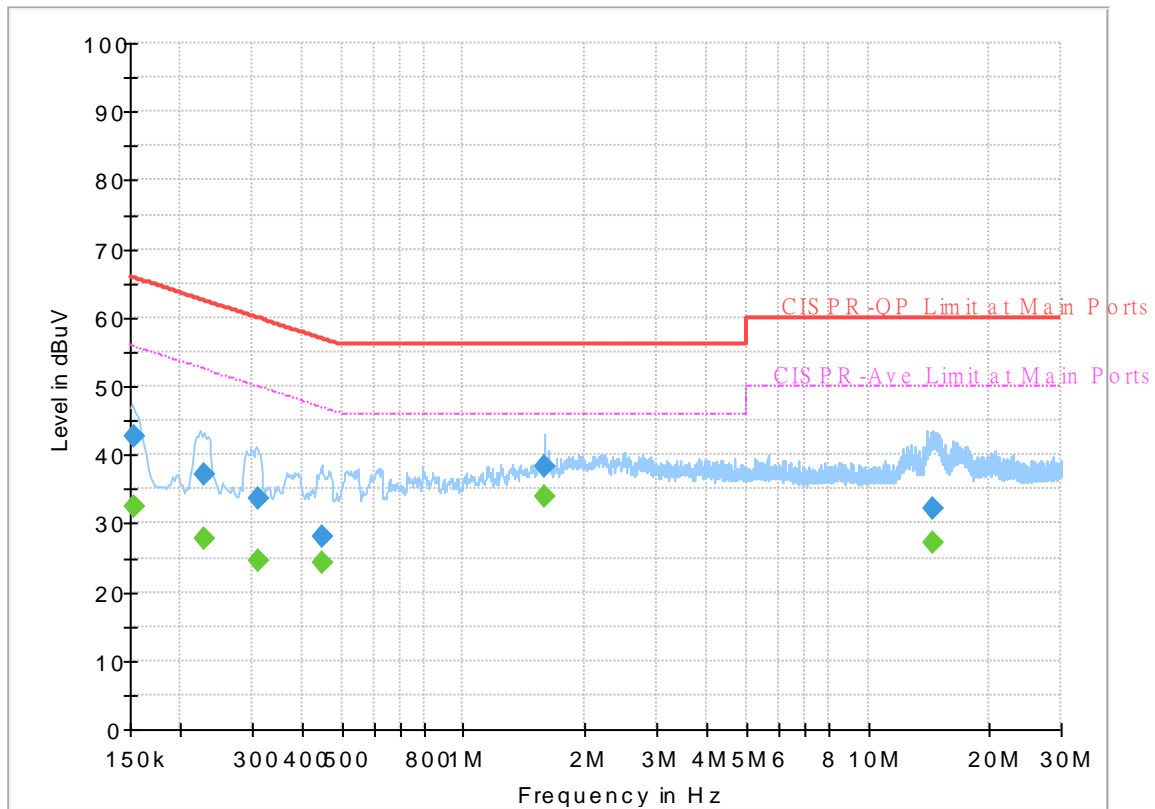

Final Result

Frequency (MHz)	QuasiPeak (dBuV)	CAverage (dBuV)	Limit (dBuV)	Margin (dB)	Line	Filter	Corr. (dB)
0.153443	---	32.48	55.81	23.33	N	OFF	19.5
0.153443	42.79	---	65.81	23.02	N	OFF	19.5
0.228750	---	27.92	52.50	24.58	N	OFF	19.5
0.228750	37.28	---	62.50	25.22	N	OFF	19.5
0.309930	---	24.62	49.97	25.35	N	OFF	19.5
0.309930	33.71	---	59.97	26.26	N	OFF	19.5
0.449250	---	24.39	46.89	22.50	N	OFF	19.5
0.449250	28.07	---	56.89	28.82	N	OFF	19.5
1.585590	---	34.00	46.00	12.00	N	OFF	19.6
1.585590	38.20	---	56.00	17.80	N	OFF	19.6
14.532000	---	27.10	50.00	22.90	N	OFF	20.1
14.532000	32.12	---	60.00	27.88	N	OFF	20.1



Appendix C. Radiated Spurious Emission

Test Engineer :	Jesse Wang, Stan Hsieh and Ken Wu	Temperature :	21~24°C
		Relative Humidity :	53~62%

Band 4 - 5725~5850MHz
WIFI 802.11a (Band Edge @ 3m)

WIFI	Note	Frequency	Level	Over	Limit	Read	Antenna	Path	Preamp	Ant	Table	Peak	Pol.	
Ant.				Limit	Line	Level	Factor	Loss	Factor	Pos	Pos	Avg.		
1+2		(MHz)	(dBµV/m)	(dB)	(dBµV/m)	(dBµV)	(dB/m)	(dB)	(dB)	(cm)	(deg)	(P/A)	(H/V)	
802.11a CH 149 5745MHz		5600.2	51.1	-17.1	68.2	39.73	35	11.68	35.31	110	246	P	H	
		5695.6	50.28	-51.68	101.96	38.82	35	11.78	35.32	110	246	P	H	
		5703.4	51.27	-54.88	106.15	39.76	35	11.83	35.32	110	246	P	H	
		5725	50.71	-71.49	122.2	39.2	35	11.83	35.32	110	246	P	H	
	*	5745	108.46	-	-	96.9	35	11.88	35.32	110	246	P	H	
	*	5745	100.44	-	-	88.88	35	11.88	35.32	110	246	A	H	
														H
														H
			5626.4	51.84	-16.36	68.2	40.52	34.9	11.73	35.31	100	360	P	V
			5670	50.74	-32.3	83.04	39.43	34.85	11.78	35.32	100	360	P	V
			5717	49.72	-60.24	109.96	38.21	35	11.83	35.32	100	360	P	V
			5724.6	49.49	-71.8	121.29	37.98	35	11.83	35.32	100	360	P	V
	*		5745	104.23	-	-	92.67	35	11.88	35.32	100	360	P	V
	*		5745	95.61	-	-	84.05	35	11.88	35.32	100	360	A	V
													V	
													V	



WIFI Ant. 1+2	Note	Frequency (MHz)	Level (dBµV/m)	Over Limit (dB)	Limit Line (dBµV/m)	Read Level (dBµV)	Antenna Factor (dB/m)	Path Loss (dB)	Preamp Factor (dB)	Ant Pos (cm)	Table Pos (deg)	Peak Avg. (P/A)	Pol. (H/V)
		5608	51.57	-16.63	68.2	40.2	35	11.68	35.31	107	245	P	H
		5692	51.87	-47.43	99.3	40.41	35	11.78	35.32	107	245	P	H
		5703.8	51.08	-55.19	106.27	39.57	35	11.83	35.32	107	245	P	H
		5720.6	50.24	-61.93	112.17	38.73	35	11.83	35.32	107	245	P	H
	*	5785	108.69	-	-	97.09	35	11.93	35.33	107	245	P	H
	*	5785	100.7	-	-	89.1	35	11.93	35.33	107	245	A	H
		5854	48.19	-64.89	113.08	36.48	35.07	11.98	35.34	107	245	P	H
		5857.2	50.51	-59.67	110.18	38.8	35.07	11.98	35.34	107	245	P	H
		5903.4	49.82	-34.33	84.15	37.89	35.2	12.07	35.34	107	245	P	H
		5927.8	49.2	-19	68.2	37.27	35.2	12.07	35.34	107	245	P	H
													H
													H
802.11a													
CH 157													
5785MHz		5644.6	51.48	-16.72	68.2	40.26	34.8	11.73	35.31	100	360	P	V
		5659	50.74	-24.14	74.88	39.63	34.7	11.73	35.32	100	360	P	V
		5702.6	50.56	-55.37	105.93	39.05	35	11.83	35.32	100	360	P	V
		5722.8	49.89	-67.29	117.18	38.38	35	11.83	35.32	100	360	P	V
	*	5785	103.78	-	-	92.18	35	11.93	35.33	100	360	P	V
	*	5785	95.7	-	-	84.1	35	11.93	35.33	100	360	A	V
		5854.2	50.94	-61.68	112.62	39.23	35.07	11.98	35.34	100	360	P	V
		5868	49.23	-57.93	107.16	37.48	35.07	12.02	35.34	100	360	P	V
		5914	51.03	-25.28	76.31	39.1	35.2	12.07	35.34	100	360	P	V
		5948.8	50.2	-18	68.2	38.23	35.2	12.11	35.34	100	360	P	V
													V
													V



WiFi Ant.	Note	Frequency	Level	Over Limit	Limit Line	Read Level	Antenna Factor	Path Loss	Preamp Factor	Ant Pos	Table Pos	Peak Avg.	Pol.	
1+2		(MHz)	(dBµV/m)	(dB)	(dBµV/m)	(dBµV)	(dB/m)	(dB)	(dB)	(cm)	(deg)	(P/A)	(H/V)	
802.11a CH 165 5825MHz	*	5825	108.04	-	-	96.39	35	11.98	35.33	100	246	P	H	
	*	5825	100.54	-	-	88.89	35	11.98	35.33	100	246	A	H	
		5850.4	48.58	-72.71	121.29	36.94	35	11.98	35.34	100	246	P	H	
		5863.2	49.43	-59.07	108.5	37.68	35.07	12.02	35.34	100	246	P	H	
		5905.2	49.75	-33.06	82.81	37.82	35.2	12.07	35.34	100	246	P	H	
		5927.8	49.22	-18.98	68.2	37.29	35.2	12.07	35.34	100	246	P	H	
														H
														H
	*	5825	104.24	-	-	92.59	35	11.98	35.33	107	360	P	V	
	*	5825	96.84	-	-	85.19	35	11.98	35.33	107	360	A	V	
		5851.4	50.4	-68.61	119.01	38.76	35	11.98	35.34	107	360	P	V	
		5861.4	49.54	-59.47	109.01	37.79	35.07	12.02	35.34	107	360	P	V	
		5918.2	49.17	-24.04	73.21	37.24	35.2	12.07	35.34	107	360	P	V	
		5940.6	48.89	-19.31	68.2	36.92	35.2	12.11	35.34	107	360	P	V	
														V
														V
													V	
Remark	1. No other spurious found. 2. All results are PASS against Peak and Average limit line.													



Band 4 5725~5850MHz
WIFI 802.11a (Harmonic @ 3m)

WIFI Ant.	Note	Frequency	Level	Over Limit	Limit Line	Read Level	Antenna Factor	Path Loss	Preamp Factor	Ant Pos	Table Pos	Peak Avg.	Pol.
1+2		(MHz)	(dBμV/m)	(dB)	(dBμV/m)	(dBμV)	(dB/m)	(dB)	(dB)	(cm)	(deg)	(P/A)	(H/V)
802.11a CH 149 5745MHz		11490	48.11	-25.89	74	49.02	38.18	18.37	57.46	100	0	P	H
		17235	52.93	-15.27	68.2	44.75	41.53	22.68	56.03	100	0	P	H
													H
													H
		11490	47.98	-26.02	74	48.89	38.18	18.37	57.46	100	0	P	V
		17235	54.47	-13.73	68.2	46.29	41.53	22.68	56.03	100	0	P	V
													V
													V
802.11a CH 157 5785MHz		11570	47.91	-26.09	74	48.53	38.33	18.41	57.36	100	0	P	H
		17355	53.64	-14.56	68.2	45.28	41.5	22.8	55.94	100	0	P	H
													H
													H
		11570	47.72	-26.28	74	48.34	38.33	18.41	57.36	100	0	P	V
		17355	53.31	-14.89	68.2	44.95	41.5	22.8	55.94	100	0	P	V
													V
													V
802.11a CH 165 5825MHz		11650	47.94	-26.06	74	48.34	38.44	18.45	57.29	100	0	P	H
		17475	54.15	-14.05	68.2	45.77	41.33	22.9	55.85	100	0	P	H
													H
													H
		11650	48.7	-25.3	74	49.1	38.44	18.45	57.29	100	0	P	V
		17475	54.06	-14.14	68.2	45.68	41.33	22.9	55.85	100	0	P	V
													V
													V
Remark	1. No other spurious found. 2. All results are PASS against Peak and Average limit line.												



**Band 4 5725~5850MHz
WIFI 802.11n HT20 (Band Edge @ 3m)**

WIFI Ant.	Note	Frequency	Level	Over Limit	Limit Line	Read Level	Antenna Factor	Path Loss	Preamp Factor	Ant Pos	Table Pos	Peak Avg.	Pol.	
1+2		(MHz)	(dBμV/m)	(dB)	(dBμV/m)	(dBμV)	(dB/m)	(dB)	(dB)	(cm)	(deg)	(P/A)	(H/V)	
802.11n HT20 CH 149 5745MHz		5616.2	51.85	-16.35	68.2	40.58	34.9	11.68	35.31	110	246	P	H	
		5692.6	50.83	-48.91	99.74	39.37	35	11.78	35.32	110	246	P	H	
		5705.2	50.4	-56.26	106.66	38.89	35	11.83	35.32	110	246	P	H	
		5724.8	51.77	-69.97	121.74	40.26	35	11.83	35.32	110	246	P	H	
	*	5745	108.16	-	-	96.6	35	11.88	35.32	110	246	P	H	
	*	5745	98.36	-	-	86.8	35	11.88	35.32	110	246	A	H	
														H
														H
			5635.2	50.4	-17.8	68.2	39.18	34.8	11.73	35.31	100	0	P	V
			5659.6	52.54	-22.79	75.33	41.43	34.7	11.73	35.32	100	0	P	V
			5704.8	50.15	-56.4	106.55	38.64	35	11.83	35.32	100	0	P	V
			5720.6	50.4	-61.77	112.17	38.89	35	11.83	35.32	100	0	P	V
	*		5745	102.96	-	-	91.4	35	11.88	35.32	100	0	P	V
	*		5745	93.76	-	-	82.2	35	11.88	35.32	100	0	A	V
														V
													V	



WIFI Ant. 1+2	Note	Frequency (MHz)	Level (dBμV/m)	Over Limit (dB)	Limit Line (dBμV/m)	Read Level (dBμV)	Antenna Factor (dB/m)	Path Loss (dB)	Preamp Factor (dB)	Ant Pos (cm)	Table Pos (deg)	Peak Avg. (P/A)	Pol. (H/V)
		5610	51.78	-16.42	68.2	40.41	35	11.68	35.31	104	245	P	H
		5663.8	51.73	-26.71	78.44	40.57	34.7	11.78	35.32	104	245	P	H
		5702.8	49.99	-56	105.99	38.48	35	11.83	35.32	104	245	P	H
		5723.2	50.44	-67.66	118.1	38.93	35	11.83	35.32	104	245	P	H
	*	5785	108.2	-	-	96.6	35	11.93	35.33	104	245	P	H
	*	5785	98.7	-	-	87.1	35	11.93	35.33	104	245	A	H
		5854	49.6	-63.48	113.08	37.89	35.07	11.98	35.34	104	245	P	H
		5857.4	49.63	-60.5	110.13	37.92	35.07	11.98	35.34	104	245	P	H
		5899.4	50.23	-36.87	87.1	38.35	35.2	12.02	35.34	104	245	P	H
		5941.8	49.8	-18.4	68.2	37.83	35.2	12.11	35.34	104	245	P	H
802.11n													H
HT20													H
CH 157		5627.6	50.43	-17.77	68.2	39.11	34.9	11.73	35.31	100	360	P	V
5785MHz		5657.6	50.77	-23.08	73.85	39.66	34.7	11.73	35.32	100	360	P	V
		5709.2	50.34	-57.44	107.78	38.83	35	11.83	35.32	100	360	P	V
		5720	50.04	-60.76	110.8	38.53	35	11.83	35.32	100	360	P	V
	*	5785	103	-	-	91.4	35	11.93	35.33	100	360	P	V
	*	5785	93.14	-	-	81.54	35	11.93	35.33	100	360	A	V
		5850.2	48.34	-73.4	121.74	36.7	35	11.98	35.34	100	360	P	V
		5869.4	49.36	-57.41	106.77	37.61	35.07	12.02	35.34	100	360	P	V
		5875.2	48.97	-56.08	105.05	37.16	35.13	12.02	35.34	100	360	P	V
		5929.6	48.96	-19.24	68.2	37.03	35.2	12.07	35.34	100	360	P	V
													V
													V



WiFi Ant.	Note	Frequency	Level	Over Limit	Limit Line	Read Level	Antenna Factor	Path Loss	Preamp Factor	Ant Pos	Table Pos	Peak Avg.	Pol.	
1+2		(MHz)	(dBμV/m)	(dB)	(dBμV/m)	(dBμV)	(dB/m)	(dB)	(dB)	(cm)	(deg)	(P/A)	(H/V)	
802.11n HT20 CH 165 5825MHz	*	5825	108.24	-	-	96.59	35	11.98	35.33	100	246	P	H	
	*	5825	98.54	-	-	86.89	35	11.98	35.33	100	246	A	H	
		5854	49.97	-63.11	113.08	38.26	35.07	11.98	35.34	100	246	P	H	
		5859.6	49.58	-59.93	109.51	37.87	35.07	11.98	35.34	100	246	P	H	
		5881.4	49.61	-50.84	100.45	37.8	35.13	12.02	35.34	100	246	P	H	
		5950	50.05	-18.15	68.2	38.08	35.2	12.11	35.34	100	246	P	H	
														H
														H
	*	5825	103.84	-	-	92.19	35	11.98	35.33	107	360	P	V	
	*	5825	93.84	-	-	82.19	35	11.98	35.33	107	360	A	V	
		5850.2	48.93	-72.81	121.74	37.29	35	11.98	35.34	107	360	P	V	
		5855.2	49.22	-61.52	110.74	37.51	35.07	11.98	35.34	107	360	P	V	
		5900.8	49.45	-36.62	86.07	37.52	35.2	12.07	35.34	107	360	P	V	
		5927	49.13	-19.07	68.2	37.2	35.2	12.07	35.34	107	360	P	V	
														V
													V	
Remark	1. No other spurious found. 2. All results are PASS against Peak and Average limit line.													



Band 4 5725~5850MHz
WIFI 802.11n HT20 (Harmonic @ 3m)

WIFI Ant.	Note	Frequency	Level	Over Limit	Limit Line	Read Level	Antenna Factor	Path Loss	Preamp Factor	Ant Pos	Table Pos	Peak Avg.	Pol.
1+2		(MHz)	(dBμV/m)	(dB)	(dBμV/m)	(dBμV)	(dB/m)	(dB)	(dB)	(cm)	(deg)	(P/A)	(H/V)
802.11n HT20 CH 149 5745MHz		11490	48.05	-25.95	74	48.96	38.18	18.37	57.46	100	0	P	H
		17235	53.21	-14.99	68.2	45.03	41.53	22.68	56.03	100	0	P	H
													H
													H
		11490	48.56	-25.44	74	49.47	38.18	18.37	57.46	100	0	P	V
		17235	53.9	-14.3	68.2	45.72	41.53	22.68	56.03	100	0	P	V
													V
													V
802.11n HT20 CH 157 5785MHz		11570	47.87	-26.13	74	48.49	38.33	18.41	57.36	100	0	P	H
		17355	54.3	-13.9	68.2	45.94	41.5	22.8	55.94	100	0	P	H
													H
													H
		11570	47.98	-26.02	74	48.6	38.33	18.41	57.36	100	0	P	V
		17355	55.06	-13.14	68.2	46.7	41.5	22.8	55.94	100	0	P	V
													V
													V
802.11n HT20 CH 165 5825MHz		11650	48.68	-25.32	74	49.08	38.44	18.45	57.29	100	0	P	H
		17475	54.53	-13.67	68.2	46.15	41.33	22.9	55.85	100	0	P	H
													H
													H
		11650	48.32	-25.68	74	48.72	38.44	18.45	57.29	100	0	P	V
		17475	54.39	-13.81	68.2	46.01	41.33	22.9	55.85	100	0	P	V
													V
													V
Remark	1. No other spurious found. 2. All results are PASS against Peak and Average limit line.												



**Band 4 5725~5850MHz
WIFI 802.11n HT40 (Band Edge @ 3m)**

WIFI Ant.	Note	Frequency	Level	Over Limit	Limit Line	Read Level	Antenna Factor	Path Loss	Preamp Factor	Ant Pos	Table Pos	Peak Avg.	Pol.
1+2		(MHz)	(dBμV/m)	(dB)	(dBμV/m)	(dBμV)	(dB/m)	(dB)	(dB)	(cm)	(deg)	(P/A)	(H/V)
		5612.4	50.86	-17.34	68.2	39.49	35	11.68	35.31	106	246	P	H
		5698.2	51.28	-52.59	103.87	39.82	35	11.78	35.32	106	246	P	H
		5700	51.78	-53.42	105.2	40.32	35	11.78	35.32	106	246	P	H
		5723.4	51.26	-67.29	118.55	39.75	35	11.83	35.32	106	246	P	H
	*	5755	105.35	-	-	93.8	35	11.88	35.33	106	246	P	H
	*	5755	95.75	-	-	84.2	35	11.88	35.33	106	246	A	H
		5851	48.63	-71.29	119.92	36.99	35	11.98	35.34	106	246	P	H
		5859.8	49.67	-59.78	109.45	37.96	35.07	11.98	35.34	106	246	P	H
		5903.8	49.52	-34.33	83.85	37.59	35.2	12.07	35.34	106	246	P	H
		5942.6	49.52	-18.68	68.2	37.55	35.2	12.11	35.34	106	246	P	H
802.11n													H
HT40													H
CH 151		5623.4	50.96	-17.24	68.2	39.64	34.9	11.73	35.31	100	360	P	V
5755MHz		5685.4	51.06	-43.37	94.43	39.6	35	11.78	35.32	100	360	P	V
		5701.6	50.55	-55.1	105.65	39.04	35	11.83	35.32	100	360	P	V
		5720.2	51.08	-60.18	111.26	39.57	35	11.83	35.32	100	360	P	V
	*	5755	99.75	-	-	88.2	35	11.88	35.33	100	360	P	V
	*	5755	90.65	-	-	79.1	35	11.88	35.33	100	360	A	V
		5850.2	48.78	-72.96	121.74	37.14	35	11.98	35.34	100	360	P	V
		5862.8	49.75	-58.86	108.61	38	35.07	12.02	35.34	100	360	P	V
		5893.2	50.06	-41.64	91.7	38.18	35.2	12.02	35.34	100	360	P	V
		5941.2	48.95	-19.25	68.2	36.98	35.2	12.11	35.34	100	360	P	V
													V
													V



WIFI Ant. 1+2	Note	Frequency (MHz)	Level (dBμV/m)	Over Limit (dB)	Limit Line (dBμV/m)	Read Level (dBμV)	Antenna Factor (dB/m)	Path Loss (dB)	Preamp Factor (dB)	Ant Pos (cm)	Table Pos (deg)	Peak Avg. (P/A)	Pol. (H/V)
		5625	50.88	-17.32	68.2	39.56	34.9	11.73	35.31	100	246	P	H
		5697	51.58	-51.41	102.99	40.12	35	11.78	35.32	100	246	P	H
		5706.8	51.92	-55.19	107.11	40.41	35	11.83	35.32	100	246	P	H
		5720.6	50.16	-62.01	112.17	38.65	35	11.83	35.32	100	246	P	H
	*	5795	105.1	-	-	93.5	35	11.93	35.33	100	246	P	H
	*	5795	95.3	-	-	83.7	35	11.93	35.33	100	246	A	H
		5854.4	49.78	-62.39	112.17	38.07	35.07	11.98	35.34	100	246	P	H
		5871.4	50.26	-55.95	106.21	38.45	35.13	12.02	35.34	100	246	P	H
		5902.8	49.65	-34.94	84.59	37.72	35.2	12.07	35.34	100	246	P	H
		5929.4	50.12	-18.08	68.2	38.19	35.2	12.07	35.34	100	246	P	H
802.11n													H
HT40													H
CH 159		5618.6	50.73	-17.47	68.2	39.46	34.9	11.68	35.31	100	0	P	V
5795MHz		5653.6	51.01	-19.86	70.87	39.9	34.7	11.73	35.32	100	0	P	V
		5712.2	50.27	-58.35	108.62	38.76	35	11.83	35.32	100	0	P	V
		5721.8	49.55	-65.35	114.9	38.04	35	11.83	35.32	100	0	P	V
	*	5795	98.9	-	-	87.3	35	11.93	35.33	100	0	P	V
	*	5795	89.71	-	-	78.11	35	11.93	35.33	100	0	A	V
		5850.4	48.7	-72.59	121.29	37.06	35	11.98	35.34	100	0	P	V
		5873.2	49.47	-56.23	105.7	37.66	35.13	12.02	35.34	100	0	P	V
		5893	49.3	-42.54	91.84	37.42	35.2	12.02	35.34	100	0	P	V
		5931.6	49.34	-18.86	68.2	37.41	35.2	12.07	35.34	100	0	P	V
													V
													V
Remark	1. No other spurious found. 2. All results are PASS against Peak and Average limit line.												



Band 4 5725~5850MHz
WIFI 802.11n HT40 (Harmonic @ 3m)

WIFI Ant.	Note	Frequency	Level	Over Limit	Limit Line	Read Level	Antenna Factor	Path Loss	Preamp Factor	Ant Pos	Table Pos	Peak Avg.	Pol.
1+2		(MHz)	(dBμV/m)	(dB)	(dBμV/m)	(dBμV)	(dB/m)	(dB)	(dB)	(cm)	(deg)	(P/A)	(H/V)
802.11n HT40 CH 151 5755MHz		11510	49.21	-24.79	74	50.04	38.2	18.4	57.43	100	0	P	H
		17265	54.73	-13.47	68.2	46.54	41.47	22.72	56	100	0	P	H
													H
													H
802.11n HT40 CH 159 5795MHz		11510	49.73	-24.27	74	50.56	38.2	18.4	57.43	100	0	P	V
		17265	54.49	-13.71	68.2	46.3	41.47	22.72	56	100	0	P	V
													V
													V
802.11n HT40 CH 159 5795MHz		11590	47.83	-26.17	74	48.37	38.37	18.43	57.34	100	0	P	H
		17385	53.44	-14.76	68.2	44.94	41.57	22.84	55.91	100	0	P	H
													H
													H
802.11n HT40 CH 159 5795MHz		11590	47.39	-26.61	74	47.93	38.37	18.43	57.34	100	0	P	V
		17385	54.58	-13.62	68.2	46.08	41.57	22.84	55.91	100	0	P	V
													V
													V
Remark	1. No other spurious found. 2. All results are PASS against Peak and Average limit line.												



Band 4 5725~5850MHz
WIFI 802.11ac VHT80 (Band Edge @ 3m)

WIFI Ant.	Note	Frequency	Level	Over Limit	Limit Line	Read Level	Antenna Factor	Path Loss	Preamp Factor	Ant Pos	Table Pos	Peak Avg.	Pol.
1+2		(MHz)	(dBμV/m)	(dB)	(dBμV/m)	(dBμV)	(dB/m)	(dB)	(dB)	(cm)	(deg)	(P/A)	(H/V)
		5606	51.43	-16.77	68.2	40.06	35	11.68	35.31	104	245	P	H
		5691.8	50.98	-48.17	99.15	39.52	35	11.78	35.32	104	245	P	H
		5719.4	51.43	-59.2	110.63	39.92	35	11.83	35.32	104	245	P	H
		5720.2	50.64	-60.62	111.26	39.13	35	11.83	35.32	104	245	P	H
	*	5775	102.75	-	-	91.2	35	11.88	35.33	104	245	P	H
	*	5775	94.35	-	-	82.8	35	11.88	35.33	104	245	A	H
		5851	49.82	-70.1	119.92	38.18	35	11.98	35.34	104	245	P	H
		5860.2	51.22	-58.12	109.34	39.47	35.07	12.02	35.34	104	245	P	H
		5902.4	50.58	-34.31	84.89	38.65	35.2	12.07	35.34	104	245	P	H
		5926.2	50.86	-17.34	68.2	38.93	35.2	12.07	35.34	104	245	P	H
802.11ac													H
VHT80													H
CH 155		5627.2	50.72	-17.48	68.2	39.4	34.9	11.73	35.31	100	360	P	V
5775MHz		5673.8	51.29	-34.56	85.85	39.98	34.85	11.78	35.32	100	360	P	V
		5715.6	50.86	-58.71	109.57	39.35	35	11.83	35.32	100	360	P	V
		5720.8	49.76	-62.86	112.62	38.25	35	11.83	35.32	100	360	P	V
	*	5775	97.49	-	-	85.94	35	11.88	35.33	100	360	P	V
	*	5775	88.31	-	-	76.76	35	11.88	35.33	100	360	A	V
		5854.4	47.59	-64.58	112.17	35.88	35.07	11.98	35.34	100	360	P	V
		5865.8	49.3	-58.47	107.77	37.55	35.07	12.02	35.34	100	360	P	V
		5922.2	49.56	-20.7	70.26	37.63	35.2	12.07	35.34	100	360	P	V
		5925.4	50.04	-18.16	68.2	38.11	35.2	12.07	35.34	100	360	P	V
													V
													V
Remark	1. No other spurious found. 2. All results are PASS against Peak and Average limit line.												



**Band 4 5725~5850MHz
WIFI 802.11ac VHT80 (Harmonic @ 3m)**

WIFI Ant.	Note	Frequency	Level	Over Limit	Limit Line	Read Level	Antenna Factor	Path Loss	Preamp Factor	Ant Pos	Table Pos	Peak Avg.	Pol.
1+2		(MHz)	(dBμV/m)	(dB)	(dBμV/m)	(dBμV)	(dB/m)	(dB)	(dB)	(cm)	(deg)	(P/A)	(H/V)
802.11ac VHT80 CH 155 5775MHz		11550	47.61	-26.39	74	48.28	38.3	18.41	57.38	100	0	P	H
		17325	54.91	-13.29	68.2	46.68	41.43	22.76	55.96	100	0	P	H
													H
													H
		11550	47.64	-26.36	74	48.31	38.3	18.41	57.38	100	0	P	V
		17325	54.72	-13.48	68.2	46.49	41.43	22.76	55.96	100	0	P	V
													V
													V
Remark	1. No other spurious found. 2. All results are PASS against Peak and Average limit line.												



Band 4 - 5725~5850MHz

WIFI 802.11ax HE20_Full (Band Edge @ 3m)

WIFI	Note	Frequency	Level	Over	Limit	Read	Antenna	Path	Preamp	Ant	Table	Peak	Pol.	
Ant.				Limit	Line	Level	Factor	Loss	Factor	Pos	Pos	Avg.		
1+2		(MHz)	(dBμV/m)	(dB)	(dBμV/m)	(dBμV)	(dB/m)	(dB)	(dB)	(cm)	(deg)	(P/A)	(H/V)	
802.11ax HE20_Full CH 149 5745MHz		5603.6	50.92	-17.28	68.2	39.55	35	11.68	35.31	100	243	P	H	
		5697.6	51.54	-51.89	103.43	40.08	35	11.78	35.32	100	243	P	H	
		5715.6	51.41	-58.16	109.57	39.9	35	11.83	35.32	100	243	P	H	
		5724.8	51.98	-69.76	121.74	40.47	35	11.83	35.32	100	243	P	H	
	*	5745	109.76	-	-	98.2	35	11.88	35.32	100	243	P	H	
	*	5745	98.62	-	-	87.06	35	11.88	35.32	100	243	A	H	
														H
														H
			5623.2	49.92	-18.28	68.2	38.6	34.9	11.73	35.31	100	354	P	V
			5678.6	50.7	-38.7	89.4	39.39	34.85	11.78	35.32	100	354	P	V
			5704.8	50.6	-55.95	106.55	39.09	35	11.83	35.32	100	354	P	V
			5722	51.43	-63.93	115.36	39.92	35	11.83	35.32	100	354	P	V
	*		5745	105.36	-	-	93.8	35	11.88	35.32	100	354	P	V
	*		5745	94.26	-	-	82.7	35	11.88	35.32	100	354	A	V
													V	
													V	



WIFI Ant.	Note	Frequency	Level	Over Limit	Limit Line	Read Level	Antenna Factor	Path Loss	Preamp Factor	Ant Pos	Table Pos	Peak Avg.	Pol.
1+2		(MHz)	(dBμV/m)	(dB)	(dBμV/m)	(dBμV)	(dB/m)	(dB)	(dB)	(cm)	(deg)	(P/A)	(H/V)
		5629	51.34	-16.86	68.2	40.02	34.9	11.73	35.31	100	63	P	H
		5679.4	51.78	-38.22	90	40.47	34.85	11.78	35.32	100	63	P	H
		5702.8	51.61	-54.38	105.99	40.1	35	11.83	35.32	100	63	P	H
		5720.8	49.99	-62.63	112.62	38.48	35	11.83	35.32	100	63	P	H
	*	5785	110	-	-	98.4	35	11.93	35.33	100	63	P	H
	*	5785	98.62	-	-	87.02	35	11.93	35.33	100	63	A	H
		5852.4	48.85	-67.88	116.73	37.21	35	11.98	35.34	100	63	P	H
		5867.4	49.39	-57.94	107.33	37.64	35.07	12.02	35.34	100	63	P	H
		5891.8	50.63	-42.1	92.73	38.75	35.2	12.02	35.34	100	63	P	H
		5930.6	49.81	-18.39	68.2	37.88	35.2	12.07	35.34	100	63	P	H
802.11ax													H
HE20_Full													H
CH 157		5646.4	50.78	-17.42	68.2	39.56	34.8	11.73	35.31	100	103	P	V
5785MHz		5698.4	51.19	-52.83	104.02	39.73	35	11.78	35.32	100	103	P	V
		5709.2	50.48	-57.3	107.78	38.97	35	11.83	35.32	100	103	P	V
		5721.8	49.78	-65.12	114.9	38.27	35	11.83	35.32	100	103	P	V
	*	5785	104.18	-	-	92.58	35	11.93	35.33	100	103	P	V
	*	5785	93.86	-	-	82.26	35	11.93	35.33	100	103	A	V
		5855	49.32	-61.48	110.8	37.61	35.07	11.98	35.34	100	103	P	V
		5870.2	49.78	-56.76	106.54	38.03	35.07	12.02	35.34	100	103	P	V
		5916.4	49.76	-24.78	74.54	37.83	35.2	12.07	35.34	100	103	P	V
		5948.4	49.98	-18.22	68.2	38.01	35.2	12.11	35.34	100	103	P	V
													V
													V



WiFi Ant.	Note	Frequency	Level	Over Limit	Limit Line	Read Level	Antenna Factor	Path Loss	Preamp Factor	Ant Pos	Table Pos	Peak Avg.	Pol.	
1+2		(MHz)	(dBμV/m)	(dB)	(dBμV/m)	(dBμV)	(dB/m)	(dB)	(dB)	(cm)	(deg)	(P/A)	(H/V)	
802.11ax HE20_Full CH 165 5825MHz	*	5825	109.26	-	-	97.61	35	11.98	35.33	100	63	P	H	
	*	5825	98.29	-	-	86.64	35	11.98	35.33	100	63	A	H	
		5850.2	48.43	-73.31	121.74	36.79	35	11.98	35.34	100	63	P	H	
		5862.4	49.54	-59.19	108.73	37.79	35.07	12.02	35.34	100	63	P	H	
		5915.6	49.3	-25.83	75.13	37.37	35.2	12.07	35.34	100	63	P	H	
		5931.2	48.92	-19.28	68.2	36.99	35.2	12.07	35.34	100	63	P	H	
														H
														H
	*	5825	104.19	-	-	92.54	35	11.98	35.33	100	185	185	P	V
	*	5825	93.59	-	-	81.94	35	11.98	35.33	100	185	185	A	V
		5852.4	50.3	-66.43	116.73	38.66	35	11.98	35.34	100	185	185	P	V
		5855.2	49.45	-61.29	110.74	37.74	35.07	11.98	35.34	100	185	185	P	V
		5912.6	49.69	-27.66	77.35	37.76	35.2	12.07	35.34	100	185	185	P	V
		5937.4	49.4	-18.8	68.2	37.47	35.2	12.07	35.34	100	185	185	P	V
													V	
													V	
Remark	1. No other spurious found. 2. All results are PASS against Peak and Average limit line.													



Band 4 5725~5850MHz
WIFI 802.11ax HE20_Full (Harmonic @ 3m)

WIFI Ant.	Note	Frequency	Level	Over Limit	Limit Line	Read Level	Antenna Factor	Path Loss	Preamp Factor	Ant Pos	Table Pos	Peak Avg.	Pol.
1+2		(MHz)	(dBμV/m)	(dB)	(dBμV/m)	(dBμV)	(dB/m)	(dB)	(dB)	(cm)	(deg)	(P/A)	(H/V)
802.11ax HE20_Full CH 149 5745MHz		11490	48.63	-25.37	74	49.54	38.18	18.37	57.46	100	0	P	H
		17235	53.95	-14.25	68.2	45.77	41.53	22.68	56.03	100	0	P	H
													H
													H
		11490	48.36	-25.64	74	49.27	38.18	18.37	57.46	100	0	P	V
		17235	53.58	-14.62	68.2	45.4	41.53	22.68	56.03	100	0	P	V
													V
802.11ax HE20_Full CH 157 5785MHz		11570	48.2	-25.8	74	48.82	38.33	18.41	57.36	100	0	P	H
		17355	53.22	-14.98	68.2	44.86	41.5	22.8	55.94	100	0	P	H
													H
													H
		11570	48.43	-25.57	74	49.05	38.33	18.41	57.36	100	0	P	V
		17355	55.14	-13.06	68.2	46.78	41.5	22.8	55.94	100	0	P	V
													V
802.11ax HE20_Full CH 165 5825MHz		11650	48.29	-25.71	74	48.69	38.44	18.45	57.29	100	0	P	H
		17475	53.89	-14.31	68.2	45.51	41.33	22.9	55.85	100	0	P	H
													H
													H
		11650	48.76	-25.24	74	49.16	38.44	18.45	57.29	100	0	P	V
		17475	54.56	-13.64	68.2	46.18	41.33	22.9	55.85	100	0	P	V
													V
Remark	1. No other spurious found.												
	2. All results are PASS against Peak and Average limit line.												



Band 4 5725~5850MHz
WIFI 802.11ax HE40_Full (Band Edge @ 3m)

WIFI Ant.	Note	Frequency	Level	Over Limit	Limit Line	Read Level	Antenna Factor	Path Loss	Preamp Factor	Ant Pos	Table Pos	Peak Avg.	Pol.
1+2		(MHz)	(dBμV/m)	(dB)	(dBμV/m)	(dBμV)	(dB/m)	(dB)	(dB)	(cm)	(deg)	(P/A)	(H/V)
		5634.6	51.85	-16.35	68.2	40.63	34.8	11.73	35.31	102	62	P	H
		5669.6	51.42	-31.32	82.74	40.11	34.85	11.78	35.32	102	62	P	H
		5717	51.95	-58.01	109.96	40.44	35	11.83	35.32	102	62	P	H
		5723.4	50.84	-67.71	118.55	39.33	35	11.83	35.32	102	62	P	H
	*	5755	105.16	-	-	93.61	35	11.88	35.33	102	62	P	H
	*	5755	95.46	-	-	83.91	35	11.88	35.33	102	62	A	H
		5855	49.76	-61.04	110.8	38.05	35.07	11.98	35.34	102	62	P	H
		5860.8	50.16	-59.01	109.17	38.41	35.07	12.02	35.34	102	62	P	H
		5889.4	50.28	-44.23	94.51	38.4	35.2	12.02	35.34	102	62	P	H
		5937.6	49.83	-18.37	68.2	37.9	35.2	12.07	35.34	102	62	P	H
802.11ax													H
HE40_Full													H
CH 151		5639.6	51.36	-16.84	68.2	40.14	34.8	11.73	35.31	100	103	P	V
5755MHz		5680	51.36	-39.08	90.44	40.05	34.85	11.78	35.32	100	103	P	V
		5711.6	50.74	-57.71	108.45	39.23	35	11.83	35.32	100	103	P	V
		5720.6	49.33	-62.84	112.17	37.82	35	11.83	35.32	100	103	P	V
	*	5755	99.89	-	-	88.34	35	11.88	35.33	100	103	P	V
	*	5755	89.95	-	-	78.4	35	11.88	35.33	100	103	A	V
		5851.4	48.66	-70.35	119.01	37.02	35	11.98	35.34	100	103	P	V
		5872.4	50.05	-55.88	105.93	38.24	35.13	12.02	35.34	100	103	P	V
		5878.4	49.75	-52.92	102.67	37.94	35.13	12.02	35.34	100	103	P	V
		5925.6	49.29	-18.91	68.2	37.36	35.2	12.07	35.34	100	103	P	V
													V
													V



WiFi Ant.	Note	Frequency	Level	Over Limit	Limit Line	Read Level	Antenna Factor	Path Loss	Preamp Factor	Ant Pos	Table Pos	Peak Avg.	Pol.
1+2		(MHz)	(dBμV/m)	(dB)	(dBμV/m)	(dBμV)	(dB/m)	(dB)	(dB)	(cm)	(deg)	(P/A)	(H/V)
		5630.6	51.5	-16.7	68.2	40.18	34.9	11.73	35.31	100	63	P	H
		5687.6	50.79	-45.26	96.05	39.33	35	11.78	35.32	100	63	P	H
		5704.6	50.21	-56.28	106.49	38.7	35	11.83	35.32	100	63	P	H
		5724.2	50.95	-69.43	120.38	39.44	35	11.83	35.32	100	63	P	H
	*	5795	105.56	-	-	93.96	35	11.93	35.33	100	63	P	H
	*	5795	95.81	-	-	84.21	35	11.93	35.33	100	63	A	H
		5852.8	49.38	-66.44	115.82	37.74	35	11.98	35.34	100	63	P	H
		5859.8	49.64	-59.81	109.45	37.93	35.07	11.98	35.34	100	63	P	H
		5885.6	49.99	-47.34	97.33	38.18	35.13	12.02	35.34	100	63	P	H
		5932.6	50.82	-17.38	68.2	38.89	35.2	12.07	35.34	100	63	P	H
802.11ax													H
HE40_Full													H
CH 159		5619.6	51.23	-16.97	68.2	39.96	34.9	11.68	35.31	100	103	P	V
5795MHz		5684.4	51.11	-42.58	93.69	39.65	35	11.78	35.32	100	103	P	V
		5713.8	50.02	-59.05	109.07	38.51	35	11.83	35.32	100	103	P	V
		5724.8	50	-71.74	121.74	38.49	35	11.83	35.32	100	103	P	V
	*	5795	101.53	-	-	89.93	35	11.93	35.33	100	103	P	V
	*	5795	90.76	-	-	79.16	35	11.93	35.33	100	103	A	V
		5855	48.49	-62.31	110.8	36.78	35.07	11.98	35.34	100	103	P	V
		5862	49.51	-59.33	108.84	37.76	35.07	12.02	35.34	100	103	P	V
		5905.6	49.68	-32.84	82.52	37.75	35.2	12.07	35.34	100	103	P	V
		5945.6	50.23	-17.97	68.2	38.26	35.2	12.11	35.34	100	103	P	V
													V
													V
Remark	1. No other spurious found. 2. All results are PASS against Peak and Average limit line.												



Band 4 5725~5850MHz
WIFI 802.11ax HE40_Full (Harmonic @ 3m)

WIFI Ant.	Note	Frequency	Level	Over Limit	Limit Line	Read Level	Antenna Factor	Path Loss	Preamp Factor	Ant Pos	Table Pos	Peak Avg.	Pol.
1+2		(MHz)	(dBμV/m)	(dB)	(dBμV/m)	(dBμV)	(dB/m)	(dB)	(dB)	(cm)	(deg)	(P/A)	(H/V)
802.11ax HE40_Full CH 151 5755MHz		11510	49.32	-24.68	74	50.15	38.2	18.4	57.43	100	0	P	H
		17265	54.48	-13.72	68.2	46.29	41.47	22.72	56	100	0	P	H
													H
													H
		11510	48.77	-25.23	74	49.6	38.2	18.4	57.43	100	0	P	V
		17265	54.81	-13.39	68.2	46.62	41.47	22.72	56	100	0	P	V
													V
802.11ax HE40_Full CH 159 5795MHz		11590	47.19	-26.81	74	47.73	38.37	18.43	57.34	100	0	P	H
		17385	54.35	-13.85	68.2	45.85	41.57	22.84	55.91	100	0	P	H
													H
													H
		11590	47.32	-26.68	74	47.86	38.37	18.43	57.34	100	0	P	V
		17385	54	-14.2	68.2	45.5	41.57	22.84	55.91	100	0	P	V
													V
Remark	1. No other spurious found.												
	2. All results are PASS against Peak and Average limit line.												



Band 4 5725~5850MHz
WIFI 802.11ax HE80_Full (Band Edge @ 3m)

WIFI Ant.	Note	Frequency	Level	Over Limit	Limit Line	Read Level	Antenna Factor	Path Loss	Preamp Factor	Ant Pos	Table Pos	Peak Avg.	Pol.
1+2		(MHz)	(dBμV/m)	(dB)	(dBμV/m)	(dBμV)	(dB/m)	(dB)	(dB)	(cm)	(deg)	(P/A)	(H/V)
		5605.2	51.8	-16.4	68.2	40.43	35	11.68	35.31	100	62	P	H
		5665.2	51.78	-27.7	79.48	40.62	34.7	11.78	35.32	100	62	P	H
		5712.4	51.4	-57.27	108.67	39.89	35	11.83	35.32	100	62	P	H
		5721	51.19	-61.89	113.08	39.68	35	11.83	35.32	100	62	P	H
	*	5775	102.32	-	-	90.77	35	11.88	35.33	100	62	P	H
	*	5775	93.17	-	-	81.62	35	11.88	35.33	100	62	A	H
		5851	50.22	-69.7	119.92	38.58	35	11.98	35.34	100	62	P	H
		5873.2	49.63	-56.07	105.7	37.82	35.13	12.02	35.34	100	62	P	H
		5879.6	50	-51.78	101.78	38.19	35.13	12.02	35.34	100	62	P	H
		5925.6	49.56	-18.64	68.2	37.63	35.2	12.07	35.34	100	62	P	H
802.11ax													H
HE80_Full													H
CH 155		5618.6	51.52	-16.68	68.2	40.25	34.9	11.68	35.31	100	103	P	V
5775MHz		5682	51.52	-40.4	91.92	40.21	34.85	11.78	35.32	100	103	P	V
		5707.2	50.39	-56.83	107.22	38.88	35	11.83	35.32	100	103	P	V
		5721	49.56	-63.52	113.08	38.05	35	11.83	35.32	100	103	P	V
	*	5775	97.16	-	-	85.61	35	11.88	35.33	100	103	P	V
	*	5775	87.7	-	-	76.15	35	11.88	35.33	100	103	A	V
		5851.6	48.35	-70.2	118.55	36.71	35	11.98	35.34	100	103	P	V
		5857	49.6	-60.64	110.24	37.89	35.07	11.98	35.34	100	103	P	V
		5882	49.61	-50.39	100	37.8	35.13	12.02	35.34	100	103	P	V
		5947.2	49.37	-18.83	68.2	37.4	35.2	12.11	35.34	100	103	P	V
													V
													V
Remark	1. No other spurious found. 2. All results are PASS against Peak and Average limit line.												



Band 4 5725~5850MHz
WIFI 802.11ax HE80_Full (Harmonic @ 3m)

WIFI Ant.	Note	Frequency	Level	Over Limit	Limit Line	Read Level	Antenna Factor	Path Loss	Preamp Factor	Ant Pos	Table Pos	Peak Avg.	Pol.
1+2		(MHz)	(dBμV/m)	(dB)	(dBμV/m)	(dBμV)	(dB/m)	(dB)	(dB)	(cm)	(deg)	(P/A)	(H/V)
802.11ax HE80_Full		11550	48.23	-25.77	74	48.9	38.3	18.41	57.38	100	0	P	H
		17325	54.22	-13.98	68.2	45.99	41.43	22.76	55.96	100	0	P	H
													H
													H
CH 155 5775MHz		11550	48.85	-25.15	74	49.52	38.3	18.41	57.38	100	0	P	V
		17325	54.9	-13.3	68.2	46.67	41.43	22.76	55.96	100	0	P	V
													V
													V
Remark	1. No other spurious found. 2. All results are PASS against Peak and Average limit line.												



Band 4 5725~5850MHz
WIFI 802.11ax HE20_Partial 26 (Band Edge @ 3m)

WIFI Ant.	Note	Frequency	Level	Over Limit	Limit Line	Read Level	Antenna Factor	Path Loss	Preamp Factor	Ant Pos	Table Pos	Peak Avg.	Pol.	
1+2		(MHz)	(dBμV/m)	(dB)	(dBμV/m)	(dBμV)	(dB/m)	(dB)	(dB)	(cm)	(deg)	(P/A)	(H/V)	
802.11ax HE20 Partial 26/0 CH 149 5745MHz		5602.6	51.4	-16.8	68.2	40.03	35	11.68	35.31	100	63	P	H	
		5696.4	50.41	-52.14	102.55	38.95	35	11.78	35.32	100	63	P	H	
		5718.6	55.72	-54.69	110.41	44.21	35	11.83	35.32	100	63	P	H	
		5723.8	58.88	-60.58	119.46	47.37	35	11.83	35.32	100	63	P	H	
	*	5745	111.7	-	-	100.14	35	11.88	35.32	100	63	P	H	
	*	5745	102.37	-	-	90.81	35	11.88	35.32	100	63	A	H	
														H
														H
			5605.4	50.55	-17.65	68.2	39.18	35	11.68	35.31	100	100	P	V
			5666.8	50.94	-29.73	80.67	39.63	34.85	11.78	35.32	100	100	P	V
			5705.8	50.07	-56.76	106.83	38.56	35	11.83	35.32	100	100	P	V
			5722.2	52.53	-63.29	115.82	41.02	35	11.83	35.32	100	100	P	V
	*		5745	106.74	-	-	95.18	35	11.88	35.32	100	100	P	V
	*		5745	97.1	-	-	85.54	35	11.88	35.32	100	100	A	V
													V	
													V	



WIFI Ant. 1+2	Note	Frequency (MHz)	Level (dBμV/m)	Over Limit (dB)	Limit Line (dBμV/m)	Read Level (dBμV)	Antenna Factor (dB/m)	Path Loss (dB)	Preamp Factor (dB)	Ant Pos (cm)	Table Pos (deg)	Peak Avg. (P/A)	Pol. (H/V)	
802.11ax HE20 Partial 26/8 CH 165 5825MHz	*	5825	112.22	-	-	100.57	35	11.98	35.33	102	62	P	H	
	*	5825	102.89	-	-	91.24	35	11.98	35.33	102	62	A	H	
		5852.4	49.28	-67.45	116.73	37.64	35	11.98	35.34	102	62	P	H	
		5863.8	49.66	-58.67	108.33	37.91	35.07	12.02	35.34	102	62	P	H	
		5890.4	50.27	-43.5	93.77	38.39	35.2	12.02	35.34	102	62	P	H	
		5930.2	50.24	-17.96	68.2	38.31	35.2	12.07	35.34	102	62	P	H	
														H
														H
	*	5825	107.15	-	-	95.5	35	11.98	35.33	100	103	P	V	
	*	5825	97.61	-	-	85.96	35	11.98	35.33	100	103	A	V	
		5854.8	48.49	-62.77	111.26	36.78	35.07	11.98	35.34	100	103	P	V	
		5859.6	49.56	-59.95	109.51	37.85	35.07	11.98	35.34	100	103	P	V	
		5897	49.54	-39.34	88.88	37.66	35.2	12.02	35.34	100	103	P	V	
		5940.4	50	-18.2	68.2	38.03	35.2	12.11	35.34	100	103	P	V	
														V
													V	
Remark	1. No other spurious found. 2. All results are PASS against Peak and Average limit line.													



Band 4 5725~5850MHz

WIFI 802.11ax HE20_Partial 26 (Harmonic @ 3m)

WIFI Ant.	Note	Frequency	Level	Over Limit	Limit Line	Read Level	Antenna Factor	Path Loss	Preamp Factor	Ant Pos	Table Pos	Peak Avg.	Pol.
1+2		(MHz)	(dBμV/m)	(dB)	(dBμV/m)	(dBμV)	(dB/m)	(dB)	(dB)	(cm)	(deg)	(P/A)	(H/V)
802.11ax HE20 Partial 26/0 CH 149 5745MHz		11490	47.83	-26.17	74	48.74	38.18	18.37	57.46	100	0	P	H
		17235	54.43	-13.77	68.2	46.25	41.53	22.68	56.03	100	0	P	H
													H
													H
		11490	47.71	-26.29	74	48.62	38.18	18.37	57.46	100	0	P	V
		17235	53.85	-14.35	68.2	45.67	41.53	22.68	56.03	100	0	P	V
													V
													V
802.11ax HE20 Partial 26/8 CH 165 5825MHz		11650	48.49	-25.51	74	48.89	38.44	18.45	57.29	100	0	P	H
		17475	54.32	-13.88	68.2	45.94	41.33	22.9	55.85	100	0	P	H
													H
													H
		11650	49.47	-24.53	74	49.87	38.44	18.45	57.29	100	0	P	V
		17475	54.26	-13.94	68.2	45.88	41.33	22.9	55.85	100	0	P	V
													V
													V
Remark	1. No other spurious found. 2. All results are PASS against Peak and Average limit line.												



Band 4 5725~5850MHz
WIFI 802.11ax HE20_Partial 52 (Band Edge @ 3m)

WIFI Ant.	Note	Frequency	Level	Over Limit	Limit Line	Read Level	Antenna Factor	Path Loss	Preamp Factor	Ant Pos	Table Pos	Peak Avg.	Pol.	
1+2		(MHz)	(dBμV/m)	(dB)	(dBμV/m)	(dBμV)	(dB/m)	(dB)	(dB)	(cm)	(deg)	(P/A)	(H/V)	
802.11ax HE20 Partial 52/37 CH 149 5745MHz		5608.6	51.04	-17.16	68.2	39.67	35	11.68	35.31	100	243	P	H	
		5686.6	51.04	-44.28	95.32	39.58	35	11.78	35.32	100	243	P	H	
		5718.2	55.86	-54.44	110.3	44.35	35	11.83	35.32	100	243	P	H	
		5723.4	49.61	-68.94	118.55	38.1	35	11.83	35.32	100	243	P	H	
	*	5745	111.36	-	-	99.8	35	11.88	35.32	100	243	P	H	
	*	5745	100.23	-	-	88.67	35	11.88	35.32	100	243	A	H	
														H
														H
			5637	50.38	-17.82	68.2	39.16	34.8	11.73	35.31	100	198	P	V
			5678	50.11	-38.85	88.96	38.8	34.85	11.78	35.32	100	198	P	V
			5712.6	50.39	-58.34	108.73	38.88	35	11.83	35.32	100	198	P	V
			5725	58.01	-64.19	122.2	46.5	35	11.83	35.32	100	198	P	V
		*	5745	107.08	-	-	95.52	35	11.88	35.32	100	198	P	V
		*	5745	96.16	-	-	84.6	35	11.88	35.32	100	198	A	V
													V	
													V	



WIFI Ant.	Note	Frequency	Level	Over Limit	Limit Line	Read Level	Antenna Factor	Path Loss	Preamp Factor	Ant Pos	Table Pos	Peak Avg.	Pol.	
1+2		(MHz)	(dBμV/m)	(dB)	(dBμV/m)	(dBμV)	(dB/m)	(dB)	(dB)	(cm)	(deg)	(P/A)	(H/V)	
802.11ax HE20 Partial 52/40 CH 165 5825MHz	*	5825	110.84	-	-	99.19	35	11.98	35.33	100	243	P	H	
	*	5825	100.34	-	-	88.69	35	11.98	35.33	100	243	A	H	
		5855	50.12	-60.68	110.8	38.41	35.07	11.98	35.34	100	243	P	H	
		5856.8	50.57	-59.73	110.3	38.86	35.07	11.98	35.34	100	243	P	H	
		5912.2	50.17	-27.47	77.64	38.24	35.2	12.07	35.34	100	243	P	H	
		5944.6	49.54	-18.66	68.2	37.57	35.2	12.11	35.34	100	243	P	H	
														H
														H
	*	5825	108.14	-	-	96.49	35	11.98	35.33	103	205	P	V	
	*	5825	97.65	-	-	86	35	11.98	35.33	103	205	A	V	
		5850.6	50.14	-70.69	120.83	38.5	35	11.98	35.34	103	205	P	V	
		5860	49.64	-59.76	109.4	37.93	35.07	11.98	35.34	103	205	P	V	
		5909.6	49.43	-30.13	79.56	37.5	35.2	12.07	35.34	103	205	P	V	
		5942.6	49.72	-18.48	68.2	37.75	35.2	12.11	35.34	103	205	P	V	
														V
													V	
Remark	1. No other spurious found. 2. All results are PASS against Peak and Average limit line.													



Band 4 5725~5850MHz
WIFI 802.11ax HE20_Partial 52 (Harmonic @ 3m)

WIFI Ant.	Note	Frequency	Level	Over Limit	Limit Line	Read Level	Antenna Factor	Path Loss	Preamp Factor	Ant Pos	Table Pos	Peak Avg.	Pol.
1+2		(MHz)	(dBμV/m)	(dB)	(dBμV/m)	(dBμV)	(dB/m)	(dB)	(dB)	(cm)	(deg)	(P/A)	(H/V)
802.11ax HE20 Partial 52/37 CH 149 5745MHz		11490	48.82	-25.18	74	49.73	38.18	18.37	57.46	100	0	P	H
		17235	54.13	-14.07	68.2	45.95	41.53	22.68	56.03	100	0	P	H
													H
													H
		11490	48.23	-25.77	74	49.14	38.18	18.37	57.46	100	0	P	V
		17235	53.81	-14.39	68.2	45.63	41.53	22.68	56.03	100	0	P	V
													V
													V
802.11ax HE20 Partial 52/40 CH 165 5825MHz		11650	48.77	-25.23	74	49.17	38.44	18.45	57.29	100	0	P	H
		17475	54.85	-13.35	68.2	46.47	41.33	22.9	55.85	100	0	P	H
													H
													H
		11650	48.74	-25.26	74	49.14	38.44	18.45	57.29	100	0	P	V
		17475	54.38	-13.82	68.2	46	41.33	22.9	55.85	100	0	P	V
													V
													V
Remark	1. No other spurious found. 2. All results are PASS against Peak and Average limit line.												



Band 4 5725~5850MHz
WIFI 802.11ax HE20_Partial 106 (Band Edge @ 3m)

WIFI Ant.	Note	Frequency	Level	Over Limit	Limit Line	Read Level	Antenna Factor	Path Loss	Preamp Factor	Ant Pos	Table Pos	Peak Avg.	Pol.	
1+2		(MHz)	(dBμV/m)	(dB)	(dBμV/m)	(dBμV)	(dB/m)	(dB)	(dB)	(cm)	(deg)	(P/A)	(H/V)	
802.11ax HE20 Partial 106/53 CH 149 5745MHz		5632	51.36	-16.84	68.2	40.04	34.9	11.73	35.31	100	244	P	H	
		5658.4	51.69	-22.75	74.44	40.58	34.7	11.73	35.32	100	244	P	H	
		5719.4	58.01	-52.62	110.63	46.5	35	11.83	35.32	100	244	P	H	
		5724.8	64.08	-57.66	121.74	52.57	35	11.83	35.32	100	244	P	H	
	*	5745	107.66	-	-	96.1	35	11.88	35.32	100	244	P	H	
	*	5745	97.16	-	-	85.6	35	11.88	35.32	100	244	A	H	
														H
														H
			5640.2	51.34	-16.86	68.2	40.12	34.8	11.73	35.31	110	206	P	V
			5679	52.26	-37.44	89.7	40.95	34.85	11.78	35.32	110	206	P	V
			5719.2	51.86	-58.72	110.58	40.35	35	11.83	35.32	110	206	P	V
			5724.6	57.04	-64.25	121.29	45.53	35	11.83	35.32	110	206	P	V
		*	5745	104.66	-	-	93.1	35	11.88	35.32	110	206	P	V
		*	5745	93.96	-	-	82.4	35	11.88	35.32	110	206	A	V
													V	
													V	



WIFI Ant.	Note	Frequency	Level	Over Limit	Limit Line	Read Level	Antenna Factor	Path Loss	Preamp Factor	Ant Pos	Table Pos	Peak Avg.	Pol.	
1+2		(MHz)	(dBμV/m)	(dB)	(dBμV/m)	(dBμV)	(dB/m)	(dB)	(dB)	(cm)	(deg)	(P/A)	(H/V)	
802.11ax HE20 Partial 106/54 CH 165 5825MHz	*	5825	108.34	-	-	96.69	35	11.98	35.33	100	243	P	H	
	*	5825	97.34	-	-	85.69	35	11.98	35.33	100	243	A	H	
		5850	54.18	-68.02	122.2	42.53	35	11.98	35.33	100	243	P	H	
		5862.8	50.85	-57.76	108.61	39.1	35.07	12.02	35.34	100	243	P	H	
		5892	50.46	-42.12	92.58	38.58	35.2	12.02	35.34	100	243	P	H	
		5937.6	50.6	-17.6	68.2	38.67	35.2	12.07	35.34	100	243	P	H	
														H
														H
	*	5825	104.94	-	-	93.29	35	11.98	35.33	100	335	335	P	V
	*	5825	94.24	-	-	82.59	35	11.98	35.33	100	335	335	A	V
		5854.4	50.34	-61.83	112.17	38.63	35.07	11.98	35.34	100	335	335	P	V
		5872.2	50.88	-55.1	105.98	39.07	35.13	12.02	35.34	100	335	335	P	V
		5887.4	50.42	-45.57	95.99	38.61	35.13	12.02	35.34	100	335	335	P	V
		5927.8	50.35	-17.85	68.2	38.42	35.2	12.07	35.34	100	335	335	P	V
														V
													V	
Remark	1. No other spurious found. 2. All results are PASS against Peak and Average limit line.													



**Band 4 5725~5850MHz
WIFI 802.11ax HE20_Partial 106 (Harmonic @ 3m)**

WIFI Ant.	Note	Frequency	Level	Over Limit	Limit Line	Read Level	Antenna Factor	Path Loss	Preamp Factor	Ant Pos	Table Pos	Peak Avg.	Pol.
1+2		(MHz)	(dBμV/m)	(dB)	(dBμV/m)	(dBμV)	(dB/m)	(dB)	(dB)	(cm)	(deg)	(P/A)	(H/V)
802.11ax HE20 Partial 106/53 CH 149 5745MHz		11490	48.11	-25.89	74	49.02	38.18	18.37	57.46	100	0	P	H
		17235	54.18	-14.02	68.2	46	41.53	22.68	56.03	100	0	P	H
													H
													H
		11490	48.44	-25.56	74	49.35	38.18	18.37	57.46	100	0	P	V
		17235	53.14	-15.06	68.2	44.96	41.53	22.68	56.03	100	0	P	V
													V
													V
802.11ax HE20 Partial 106/54 CH 165 5825MHz		11650	48.72	-25.28	74	49.12	38.44	18.45	57.29	100	0	P	H
		17475	54.56	-13.64	68.2	46.18	41.33	22.9	55.85	100	0	P	H
													H
													H
		11650	48.76	-25.24	74	49.16	38.44	18.45	57.29	100	0	P	V
		17475	54.33	-13.87	68.2	45.95	41.33	22.9	55.85	100	0	P	V
													V
													V
Remark	1. No other spurious found. 2. All results are PASS against Peak and Average limit line.												



Band 4 5725~5850MHz
WIFI 802.11ax HE40_Partial 242 (Band Edge @ 3m)

WIFI Ant.	Note	Frequency	Level	Over Limit	Limit Line	Read Level	Antenna Factor	Path Loss	Preamp Factor	Ant Pos	Table Pos	Peak Avg.	Pol.
1+2		(MHz)	(dBμV/m)	(dB)	(dBμV/m)	(dBμV)	(dB/m)	(dB)	(dB)	(cm)	(deg)	(P/A)	(H/V)
		5625.2	52.14	-16.06	68.2	40.82	34.9	11.73	35.31	102	243	P	H
		5697.8	58.88	-44.7	103.58	47.42	35	11.78	35.32	102	243	P	H
		5717.4	73.35	-36.72	110.07	61.84	35	11.83	35.32	102	243	P	H
		5722.8	75.09	-42.09	117.18	63.58	35	11.83	35.32	102	243	P	H
	*	5755	104.72	-	-	93.17	35	11.88	35.33	102	243	P	H
	*	5755	94.05	-	-	82.5	35	11.88	35.33	102	243	A	H
		5850.6	49.92	-70.91	120.83	38.28	35	11.98	35.34	102	243	P	H
		5859.4	50.75	-58.82	109.57	39.04	35.07	11.98	35.34	102	243	P	H
		5916.8	50.6	-23.65	74.25	38.67	35.2	12.07	35.34	102	243	P	H
		5927.2	50.82	-17.38	68.2	38.89	35.2	12.07	35.34	102	243	P	H
802.11ax													H
HE40													H
Partial													H
242/61		5632.6	51.64	-16.56	68.2	40.42	34.8	11.73	35.31	100	349	P	V
CH 151		5696.4	53.24	-49.31	102.55	41.78	35	11.78	35.32	100	349	P	V
5755MHz		5716.8	68.12	-41.79	109.91	56.61	35	11.83	35.32	100	349	P	V
		5721.6	69.03	-45.42	114.45	57.52	35	11.83	35.32	100	349	P	V
	*	5755	100.45	-	-	88.9	35	11.88	35.33	100	349	P	V
	*	5755	90.05	-	-	78.5	35	11.88	35.33	100	349	A	V
		5850	50.22	-71.98	122.2	38.57	35	11.98	35.33	100	349	P	V
		5864.2	50.53	-57.69	108.22	38.78	35.07	12.02	35.34	100	349	P	V
		5891.6	50.87	-42.01	92.88	38.99	35.2	12.02	35.34	100	349	P	V
		5927	50.93	-17.27	68.2	39	35.2	12.07	35.34	100	349	P	V
													V
													V



WiFi Ant.	Note	Frequency	Level	Over Limit	Limit Line	Read Level	Antenna Factor	Path Loss	Preamp Factor	Ant Pos	Table Pos	Peak Avg.	Pol.	
1+2		(MHz)	(dBµV/m)	(dB)	(dBµV/m)	(dBµV)	(dB/m)	(dB)	(dB)	(cm)	(deg)	(P/A)	(H/V)	
802.11ax		5611.6	51.46	-16.74	68.2	40.09	35	11.68	35.31	100	244	P	H	
		5697	52.99	-50	102.99	41.53	35	11.78	35.32	100	244	P	H	
		5717.4	54.18	-55.89	110.07	42.67	35	11.83	35.32	100	244	P	H	
		5723	56.5	-61.14	117.64	44.99	35	11.83	35.32	100	244	P	H	
	*	5795	105.3	-	-	93.7	35	11.93	35.33	100	244	P	H	
	*	5795	94.76	-	-	83.16	35	11.93	35.33	100	244	A	H	
		5854.8	53.12	-58.14	111.26	41.41	35.07	11.98	35.34	100	244	P	H	
		5860	58.2	-51.2	109.4	46.49	35.07	11.98	35.34	100	244	P	H	
		5887.8	51.74	-43.96	95.7	39.86	35.2	12.02	35.34	100	244	P	H	
		5945.2	50.84	-17.36	68.2	38.87	35.2	12.11	35.34	100	244	P	H	
	HE40													H
	Partial													H
	242/62		5641.2	51.4	-16.8	68.2	40.18	34.8	11.73	35.31	100	204	P	V
	CH 159		5673.2	51.88	-33.53	85.41	40.57	34.85	11.78	35.32	100	204	P	V
	5795MHz		5707.6	51.69	-55.64	107.33	40.18	35	11.83	35.32	100	204	P	V
			5724.2	50.68	-69.7	120.38	39.17	35	11.83	35.32	100	204	P	V
	*		5795	101.86	-	-	90.26	35	11.93	35.33	100	204	P	V
	*		5795	91	-	-	79.4	35	11.93	35.33	100	204	A	V
			5852	50.32	-67.32	117.64	38.68	35	11.98	35.34	100	204	P	V
			5861.8	51.05	-57.84	108.89	39.3	35.07	12.02	35.34	100	204	P	V
		5923	50.87	-18.8	69.67	38.94	35.2	12.07	35.34	100	204	P	V	
		5931.4	50.52	-17.68	68.2	38.59	35.2	12.07	35.34	100	204	P	V	
													V	
													V	
Remark	1. No other spurious found. 2. All results are PASS against Peak and Average limit line.													



Band 4 5725~5850MHz
WIFI 802.11ax HE40_Partial 242 (Harmonic @ 3m)

WIFI Ant.	Note	Frequency	Level	Over Limit	Limit Line	Read Level	Antenna Factor	Path Loss	Preamp Factor	Ant Pos	Table Pos	Peak Avg.	Pol.
1+2		(MHz)	(dBμV/m)	(dB)	(dBμV/m)	(dBμV)	(dB/m)	(dB)	(dB)	(cm)	(deg)	(P/A)	(H/V)
802.11ax HE40 Partial 242/61 CH 151 5755MHz		11510	49.38	-24.62	74	50.21	38.2	18.4	57.43	100	0	P	H
		17265	54.48	-13.72	68.2	46.29	41.47	22.72	56	100	0	P	H
													H
													H
		11510	48.99	-25.01	74	49.82	38.2	18.4	57.43	100	0	P	V
		17265	54.63	-13.57	68.2	46.44	41.47	22.72	56	100	0	P	V
													V
													V
802.11ax HE40 Partial 242/62 CH 159 5795MHz		11590	47.09	-26.91	74	47.63	38.37	18.43	57.34	100	0	P	H
		17385	54.38	-13.82	68.2	45.88	41.57	22.84	55.91	100	0	P	H
													H
													H
		11590	47.32	-26.68	74	47.86	38.37	18.43	57.34	100	0	P	V
		17385	55.35	-12.85	68.2	46.85	41.57	22.84	55.91	100	0	P	V
													V
													V
Remark	1. No other spurious found. 2. All results are PASS against Peak and Average limit line.												



Band 4 5725~5850MHz
WIFI 802.11ax HE80_Partial 484 (Band Edge @ 3m)

WIFI Ant.	Note	Frequency	Level	Over Limit	Limit Line	Read Level	Antenna Factor	Path Loss	Preamp Factor	Ant Pos	Table Pos	Peak Avg.	Pol.
1+2		(MHz)	(dBμV/m)	(dB)	(dBμV/m)	(dBμV)	(dB/m)	(dB)	(dB)	(cm)	(deg)	(P/A)	(H/V)
		5636.6	52.34	-15.86	68.2	41.12	34.8	11.73	35.31	100	245	P	H
		5684	68.52	-24.88	93.4	57.06	35	11.78	35.32	100	245	P	H
		5719.4	71.99	-38.64	110.63	60.48	35	11.83	35.32	100	245	P	H
		5725	74.58	-47.62	122.2	63.07	35	11.83	35.32	100	245	P	H
	*	5775	102.04	-	-	90.49	35	11.88	35.33	100	245	P	H
	*	5775	91.95	-	-	80.4	35	11.88	35.33	100	245	A	H
		5851.6	67.82	-50.73	118.55	56.18	35	11.98	35.34	100	245	P	H
		5856.2	67.95	-42.51	110.46	56.24	35.07	11.98	35.34	100	245	P	H
		5877	55.2	-48.51	103.71	43.39	35.13	12.02	35.34	100	245	P	H
		5947.8	50.37	-17.83	68.2	38.4	35.2	12.11	35.34	100	245	P	H
802.11ax													H
HE80													H
Partial													H
484/65		5648.8	51.18	-17.02	68.2	39.96	34.8	11.73	35.31	100	360	P	V
CH 155		5683.6	63.52	-29.58	93.1	52.06	35	11.78	35.32	100	360	P	V
5775MHz		5719.6	68.2	-42.49	110.69	56.69	35	11.83	35.32	100	360	P	V
		5725	70.52	-51.68	122.2	59.01	35	11.83	35.32	100	360	P	V
	*	5775	101.84	-	-	90.29	35	11.88	35.33	100	360	P	V
	*	5775	91.15	-	-	79.6	35	11.88	35.33	100	360	A	V
		5854.8	61.79	-49.47	111.26	50.08	35.07	11.98	35.34	100	360	P	V
		5855.4	63.21	-47.48	110.69	51.5	35.07	11.98	35.34	100	360	P	V
		5876.4	52.95	-51.21	104.16	41.14	35.13	12.02	35.34	100	360	P	V
		5936.2	50.44	-17.76	68.2	38.51	35.2	12.07	35.34	100	360	P	V
													V
													V
Remark	1. No other spurious found. 2. All results are PASS against Peak and Average limit line.												



WiFi Ant.	Note	Frequency	Level	Over Limit	Limit Line	Read Level	Antenna Factor	Path Loss	Preamp Factor	Ant Pos	Table Pos	Peak Avg.	Pol.	
1+2		(MHz)	(dBµV/m)	(dB)	(dBµV/m)	(dBµV)	(dB/m)	(dB)	(dB)	(cm)	(deg)	(P/A)	(H/V)	
802.11ax HE80 Partial 484/66 CH 155 5775MHz		5650	53.23	-14.97	68.2	42.11	34.7	11.73	35.31	100	243	P	H	
		5686.6	68.52	-26.8	95.32	57.06	35	11.78	35.32	100	243	P	H	
		5719.8	72.12	-38.62	110.74	60.61	35	11.83	35.32	100	243	P	H	
		5723.2	74.28	-43.82	118.1	62.77	35	11.83	35.32	100	243	P	H	
	*	5775	105.57	-	-	94.02	35	11.88	35.33	100	243	P	H	
	*	5775	95.56	-	-	84.01	35	11.88	35.33	100	243	A	H	
		5851.6	68.38	-50.17	118.55	56.74	35	11.98	35.34	100	243	P	H	
		5856.2	68.37	-42.09	110.46	56.66	35.07	11.98	35.34	100	243	P	H	
		5875.8	57.49	-47.12	104.61	45.68	35.13	12.02	35.34	100	243	P	H	
		5938.6	50.09	-18.11	68.2	38.16	35.2	12.07	35.34	100	243	P	H	
														H
														H
			5645.2	51.95	-16.25	68.2	40.73	34.8	11.73	35.31	100	292	P	V
			5687.8	64.5	-31.7	96.2	53.04	35	11.78	35.32	100	292	P	V
			5717.6	66.49	-43.64	110.13	54.98	35	11.83	35.32	100	292	P	V
			5723	69.6	-48.04	117.64	58.09	35	11.83	35.32	100	292	P	V
	*		5775	102.85	-	-	91.3	35	11.88	35.33	100	292	P	V
	*		5775	92.15	-	-	80.6	35	11.88	35.33	100	292	A	V
			5852.8	63.69	-52.13	115.82	52.05	35	11.98	35.34	100	292	P	V
			5858.4	63.21	-46.64	109.85	51.5	35.07	11.98	35.34	100	292	P	V
		5875	54.75	-50.45	105.2	42.94	35.13	12.02	35.34	100	292	P	V	
		5947.6	50.69	-17.51	68.2	38.72	35.2	12.11	35.34	100	292	P	V	
													V	
													V	
Remark	<ol style="list-style-type: none"> No other spurious found. All results are PASS against Peak and Average limit line. 													



Band 4 5725~5850MHz
WIFI 802.11ax HE80_Partial 484 (Harmonic @ 3m)

WIFI Ant.	Note	Frequency	Level	Over Limit	Limit Line	Read Level	Antenna Factor	Path Loss	Preamp Factor	Ant Pos	Table Pos	Peak Avg.	Pol.
1+2		(MHz)	(dBμV/m)	(dB)	(dBμV/m)	(dBμV)	(dB/m)	(dB)	(dB)	(cm)	(deg)	(P/A)	(H/V)
802.11ax HE80 Partial 484/65 CH 155 5775MHz		11550	47.82	-26.18	74	48.49	38.3	18.41	57.38	100	0	P	H
		17325	54.46	-13.74	68.2	46.23	41.43	22.76	55.96	100	0	P	H
													H
													H
		11550	48.39	-25.61	74	49.06	38.3	18.41	57.38	100	0	P	V
		17325	54.8	-13.4	68.2	46.57	41.43	22.76	55.96	100	0	P	V
													V
													V
802.11ax HE80 Partial 484/66 CH 155 5775MHz		11550	47.94	-26.06	74	48.61	38.3	18.41	57.38	100	0	P	H
		17325	53.87	-14.33	68.2	45.64	41.43	22.76	55.96	100	0	P	H
													H
													H
		11550	48.42	-25.58	74	49.09	38.3	18.41	57.38	100	0	P	V
		17325	54.54	-13.66	68.2	46.31	41.43	22.76	55.96	100	0	P	V
													V
													V
Remark	1. No other spurious found. 2. All results are PASS against Peak and Average limit line.												



Emission above 18GHz

WIFI 802.11ax HE40 (SHF @ 3m)

WIFI	Note	Frequency	Level	Over	Limit	Read	Antenna	Path	Preamp	Ant	Table	Peak	Pol.	
Ant.				Limit	Line	Level	Factor	Loss	Factor	Pos	Pos	Avg.		
1		(MHz)	(dBμV/m)	(dB)	(dBμV/m)	(dBμV)	(dB/m)	(dB)	(dB)	(cm)	(deg)	(P/A)	(H/V)	
802.11ax HE40 SHF		18000	41.79	-32.21	74	45.86	37.9	12.03	54	150	0	P	H	
													H	
													H	
													H	
			18132	40.51	-33.49	74	45.1	37.9	11.64	54.13	150	0	P	V
														V
														V
														V
Remark	1. No other spurious found. 2. All results are PASS against limit line.													



<WPC Mode>

Band 4 - 5725~5850MHz

WIFI 802.11ax HE40_Partial 242 (Band Edge @ 3m)

WIFI	Note	Frequency	Level	Over	Limit	Read	Antenna	Path	Preamp	Ant	Table	Peak	Pol.	
Ant.				Limit	Line	Level	Factor	Loss	Factor	Pos	Pos	Avg.		
1+2		(MHz)	(dBμV/m)	(dB)	(dBμV/m)	(dBμV)	(dB/m)	(dB)	(dB)	(cm)	(deg)	(P/A)	(H/V)	
802.11ax HE40 Partial 242/62 CH 159 5795MHz		5629	52.7	-15.5	68.2	41.38	34.9	11.73	35.31	100	258	P	H	
		5699.2	52.56	-52.05	104.61	41.1	35	11.78	35.32	100	258	P	H	
		5718.4	54.78	-55.57	110.35	43.27	35	11.83	35.32	100	258	P	H	
		5724	54.56	-65.36	119.92	43.05	35	11.83	35.32	100	258	P	H	
	*	5795	105	-	-	93.4	35	11.93	35.33	100	258	P	H	
	*	5795	94.7	-	-	83.1	35	11.93	35.33	100	258	A	H	
		5851.2	53.48	-65.98	119.46	41.84	35	11.98	35.34	100	258	P	H	
		5868.4	54.78	-52.27	107.05	43.03	35.07	12.02	35.34	100	258	P	H	
		5896.2	50.49	-38.98	89.47	38.61	35.2	12.02	35.34	100	258	P	H	
		5929.2	51.24	-16.96	68.2	39.31	35.2	12.07	35.34	100	258	P	H	
														H
														H
			5605.4	51.27	-16.93	68.2	39.9	35	11.68	35.31	100	210	P	V
			5659	52.04	-22.84	74.88	40.93	34.7	11.73	35.32	100	210	P	V
			5715.6	51.32	-58.25	109.57	39.81	35	11.83	35.32	100	210	P	V
			5725	52.71	-69.49	122.2	41.2	35	11.83	35.32	100	210	P	V
	*		5795	103.1	-	-	91.5	35	11.93	35.33	100	210	P	V
	*		5795	93.03	-	-	81.43	35	11.93	35.33	100	210	A	V
			5851.8	50.9	-67.2	118.1	39.26	35	11.98	35.34	100	210	P	V
			5863	50.35	-58.21	108.56	38.6	35.07	12.02	35.34	100	210	P	V
		5915.8	51.4	-23.58	74.98	39.47	35.2	12.07	35.34	100	210	P	V	
		5939.6	50.35	-17.85	68.2	38.42	35.2	12.07	35.34	100	210	P	V	
													V	
													V	
Remark	1. No other spurious found. 2. All results are PASS against Peak and Average limit line.													



**Band 4 5725~5850MHz
WIFI 802.11ax HE40_Partial 242 (Harmonic @ 3m)**

WIFI Ant.	Note	Frequency	Level	Over Limit	Limit Line	Read Level	Antenna Factor	Path Loss	Preamp Factor	Ant Pos	Table Pos	Peak Avg.	Pol.
1+2		(MHz)	(dBμV/m)	(dB)	(dBμV/m)	(dBμV)	(dB/m)	(dB)	(dB)	(cm)	(deg)	(P/A)	(H/V)
802.11ax HE40 Partial 242/62 CH 159 5795MHz		11590	47.38	-26.62	74	47.92	38.37	18.43	57.34	100	0	P	H
		17385	54.3	-13.9	68.2	45.8	41.57	22.84	55.91	100	0	P	H
													H
													H
		11590	47.14	-26.86	74	47.68	38.37	18.43	57.34	100	0	P	V
		17385	54.52	-13.68	68.2	46.02	41.57	22.84	55.91	100	0	P	V
													V
													V
Remark	1. No other spurious found. 2. All results are PASS against Peak and Average limit line.												



**Emission below 1GHz
5GHz WIFI 802.11ax HE40 (LF @ 3m)**

WIFI Ant.	Note	Frequency	Level	Over Limit	Limit Line	Read Level	Antenna Factor	Path Loss	Preamp Factor	Ant Pos	Table Pos	Peak Avg.	Pol.	
1+2		(MHz)	(dBµV/m)	(dB)	(dBµV/m)	(dBµV)	(dB/m)	(dB)	(dB)	(cm)	(deg)	(P/A)	(H/V)	
5GHz 802.11ax HE40 LF		30.54	23.86	-16.14	40	28.55	24.09	1.2	29.98	-	-	P	H	
		66.99	23.44	-16.56	40	39.82	12.03	1.58	29.99	-	-	P	H	
		120.45	26.39	-17.11	43.5	36.95	17.43	1.97	29.96	-	-	P	H	
		780.2	32.1	-13.9	46	28.94	27.98	4.52	29.34		-	P	H	
		911.1	33.11	-12.89	46	28.02	28.96	4.98	28.85	-	-	P	H	
		955.2	34.14	-11.86	46	26.97	30.64	5.06	28.53	100	0	P	H	
														H
														H
														H
														H
														H
														H
														H
														H
														H
			31.35	34.91	-5.09	40	39.6	24.09	1.2	29.98	100	301	Q	V
			65.37	33.36	-6.64	40	49.94	11.83	1.58	29.99	-	-	P	V
			84.27	26.17	-13.83	40	40.77	13.75	1.64	29.99	-	-	P	V
			797.7	31.64	-14.36	46	28.43	27.96	4.54	29.29	-	-	P	V
			882.4	32.64	-13.36	46	27.85	28.87	4.91	28.99	-	-	P	V
		958	34.22	-11.78	46	26.86	30.8	5.06	28.5	-	-	P	V	
													V	
													V	
													V	
													V	
													V	
													V	
Remark	1. No other spurious found. 2. All results are PASS against limit line.													



Note symbol

*	Fundamental Frequency which can be ignored. However, the level of any unwanted emissions shall not exceed the level of the fundamental frequency.
!	Test result is over limit line.
P/A	Peak or Average
H/V	Horizontal or Vertical



A calculation example for radiated spurious emission is shown as below:

WIFI	Note	Frequency	Level	Over	Limit	Read	Antenna	Path	Preamp	Ant	Table	Peak	Pol.
Ant.				Limit	Line	Level	Factor	Loss	Factor	Pos	Pos	Avg.	
1+2		(MHz)	(dBμV/m)	(dB)	(dBμV/m)	(dBμV)	(dB/m)	(dB)	(dB)	(cm)	(deg)	(P/A)	(H/V)
802.11b		2390	55.45	-18.55	74	54.51	32.22	4.58	35.86	103	308	P	H
CH 01													
2412MHz		2390	43.54	-10.46	54	42.6	32.22	4.58	35.86	103	308	A	H

1. Path Loss(dB) = Cable loss(dB) + Filter loss(dB) + Attenuator loss(dB)
2. Level(dBμV/m) = Antenna Factor(dB/m) + Path Loss(dB) + Read Level(dBμV) - Preamp Factor(dB)
3. Over Limit(dB) = Level(dBμV/m) – Limit Line(dBμV/m)

For Peak Limit @ 2390MHz:

1. Level(dBμV/m)
= Antenna Factor(dB/m) + Path Loss(dB) + Read Level(dBμV) - Preamp Factor(dB)
= 32.22(dB/m) + 4.58(dB) + 54.51(dBμV) – 35.86 (dB)
= 55.45 (dBμV/m)
2. Over Limit(dB)
= Level(dBμV/m) – Limit Line(dBμV/m)
= 55.45(dBμV/m) – 74(dBμV/m)
= -18.55(dB)

For Average Limit @ 2390MHz:

1. Level(dBμV/m)
= Antenna Factor(dB/m) + Path Loss(dB) + Read Level(dBμV) - Preamp Factor(dB)
= 32.22(dB/m) + 4.58(dB) + 42.6(dBμV) – 35.86 (dB)
= 43.54 (dBμV/m)
2. Over Limit(dB) = Level(dBμV/m) – Limit Line(dBμV/m)
= 43.54(dBμV/m) – 54(dBμV/m)
= -10.46(dB)

Both peak and average measured complies with the limit line, so test result is “PASS”.



Appendix D. Radiated Spurious Emission Plots

Test Engineer :	Jesse Wang, Stan Hsieh and Ken Wu	Temperature :	21~24°C
		Relative Humidity :	53~62%

Note symbol

-L	Low channel location
-R	High channel location



Band 4 - 5725~5850MHz
WIFI 802.11a (Band Edge @ 3m)

WIFI	Band 4 5725~5850MHz Band Edge @ 3m	
ANT	802.11a CH149 5745MHz	
1+2	Horizontal	Fundamental
Peak	<p>Date: 2020-01-10 PEAK: 135.2</p> <p>Site : 03C107-HY Condition : PEAK: BE(B4), 16-24 3m HF_ANT_00075962 HORIZONTAL : RBW:1000.000KHz VBW:3000.000KHz SWT:Auto Detector : Peak Project : 901542-02 Mode : 78</p>	<p>Date: 2020-01-10 PEAK: 135.2</p> <p>Site : 03C107-HY Condition : PEAK(FUN) 3m HF_ANT_00075962 HORIZONTAL : RBW:1000.000KHz VBW:3000.000KHz SWT:Auto Detector : Peak Project : 901542-02 Mode : 78</p>



WIFI	Band 4 5725~5850MHz Band Edge @ 3m	
ANT	802.11a CH149 5745MHz	
1+2	Vertical	Fundamental
Peak	<p>Site : 03CH07-11Y Condition : PEAK_BE(B4)_16-24 3m HF_ANT_00075962 VERTICAL Detector : RBW:1000.000kHz VBW:3000.000kHz SWT:Auto Project : 901542-02 Mode : 78</p>	<p>Site : 03CH07-11Y Condition : PEAK(LNB) 3m HF_ANT_00075962 VERTICAL Detector : RBW:1000.000kHz VBW:3000.000kHz SWT:Auto Project : 901542-02 Mode : 78</p>



WIFI	Band 4 5725~5850MHz Band Edge @ 3m	
ANT	802.11a CH157 5785MHz	
1+2	Horizontal	Fundamental
<p>Peak</p>	<p>Date: 2020-01-10 PEAK_BE(B4)_16-24</p> <p>Site : 03CH07-HY Condition : PEAK_BE(B4)_16-24 3m HF_ANT_00075962 HORIZONTAL Detector : Peak Project : 901542-02 Mode : 79</p>	<p>Date: 2020-01-10 PEAK(LNB) AVG_51</p> <p>Site : 03CH07-HY Condition : PEAK(LNB)_3m HF_ANT_00075962 HORIZONTAL Detector : Peak Project : 901542-02 Mode : 79</p>
<p>Peak</p>	<p>Date: 2020-01-10 PEAK_BE(B4)_16-24</p> <p>Site : 03CH07-HY Condition : PEAK_BE(B4)_16-24 3m HF_ANT_00075962 HORIZONTAL Detector : Peak Project : 901542-02 Mode : 79</p>	<p>Left blank</p>



WIFI	Band 4 5725~5850MHz Band Edge @ 3m	
ANT	802.11a CH157 5785MHz	
1+2	Vertical	Fundamental
<p>Peak</p>	<p>Site : 03CH07-HY Condition : PEAK_BE(B4)_16-24 3m HF_ANT_00075962 VERTICAL Detector : Peak Project : 901542-02 Mode : 79</p>	<p>Site : 03CH07-HY Condition : PEAK(LNB) 3m HF_ANT_00075962 VERTICAL Detector : Peak Project : 901542-02 Mode : 79</p>
<p>Peak</p>	<p>Site : 03CH07-HY Condition : PEAK_BE(B4)_16-24 3m HF_ANT_00075962 VERTICAL Detector : Peak Project : 901542-02 Mode : 79</p>	<p>Left blank</p>

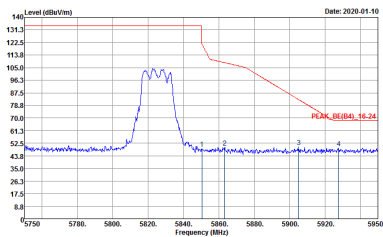
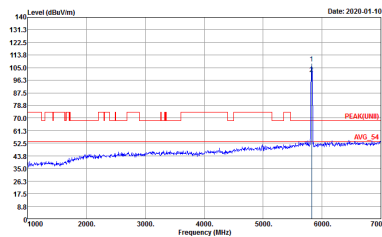

WIFI	Band 4 5725~5850MHz Band Edge @ 3m	
ANT	802.11a CH165 5825MHz	
1+2	Horizontal	Fundamental
Peak	 <p>Site : 03CH07-11Y Condition : PEAK_BE(B4)_16-24 3m HF_ANT_00075962 HORIZONTAL Detector : RBW:1000.000kHz VBW:3000.000kHz SWT:Auto Detector : Peak Project : 901542-02 Mode : 80</p>	 <p>Site : 03CH07-11Y Condition : PEAK(LIN) 3m HF_ANT_00075962 HORIZONTAL Detector : RBW:1000.000kHz VBW:3000.000kHz SWT:Auto Detector : Peak Project : 901542-02 Mode : 80</p>

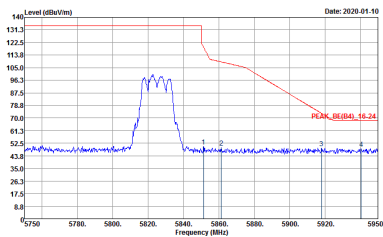
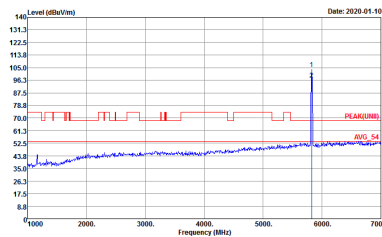

WIFI	Band 4 5725~5850MHz Band Edge @ 3m	
ANT	802.11a CH165 5825MHz	
1+2	Vertical	Fundamental
Peak	 <p>Site : 03CH07-11Y Condition : PEAK_BE(B4)_16-24 3m HF_ANT_00075962 VERTICAL Detector : RBW:1000.000kHz VBW:3000.000kHz SWT:Auto Project : 901542-02 Mode : 80</p>	 <p>Site : 03CH07-11Y Condition : PEAK(U)N11 3m HF_ANT_00075962 VERTICAL Detector : RBW:1000.000kHz VBW:3000.000kHz SWT:Auto Project : 901542-02 Mode : 80</p>



**Band 4 5725~5850MHz
WIFI 802.11n HT20 (Band Edge @ 3m)**

WIFI	Band 4 5725~5850MHz Band Edge @ 3m	
ANT	802.11n HT20 CH149 5745MHz	
1+2	Horizontal	Fundamental
Peak	<p>Site : 03CH07-HY Condition : PEAK_BE(B4)_16-24 3m HF_ANT_00075962 HORIZONTAL Detector : Peak Project : 901542-02 Mode : S1</p>	<p>Site : 03CH07-HY Condition : PEAK(UWB) 3m HF_ANT_00075962 HORIZONTAL Detector : Peak Project : 901542-02 Mode : S1</p>

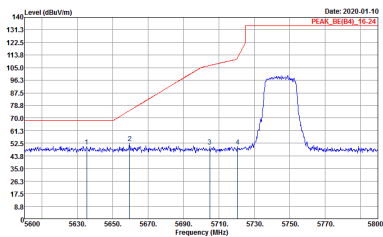
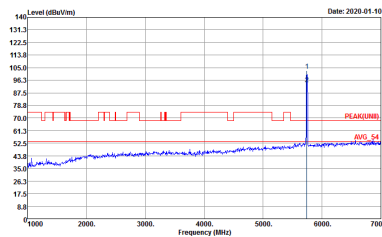

WIFI	Band 4 5725~5850MHz Band Edge @ 3m	
ANT	802.11n HT20 CH149 5745MHz	
1+2	Vertical	Fundamental
Peak	 <p>Site : 03CH07-11Y Condition : PEAK_BE(B4) 16-24 3m HF_ANT_00075962 VERTICAL Detector : RBW:1000.000KHz VBW:3000.000KHz SWT:Auto Project : 901542-02 Mode : 81</p>	 <p>Site : 03CH07-11Y Condition : PEAK(LNB) 3m HF_ANT_00075962 VERTICAL Detector : RBW:1000.000KHz VBW:3000.000KHz SWT:Auto Project : 901542-02 Mode : 81</p>



WIFI	Band 4 5725~5850MHz Band Edge @ 3m	
ANT	802.11n HT20 CH157 5785MHz	
1+2	Horizontal	Fundamental
<p>Peak</p>		
<p>Peak</p>		<p>Left blank</p>



WIFI	Band 4 5725~5850MHz Band Edge @ 3m	
ANT	802.11n HT20 CH157 5785MHz	
1+2	Vertical	Fundamental
<p>Peak</p>	<p>Date: 2020-01-10 PEAK_BE(B4)_16-24</p> <p>Site : 03CH07-HY Condition : PEAK_BE(B4)_16-24 3m HF_ANT_00075962 VERTICAL Detector : RBW:1000.000KHz VBW:3000.000KHz SWT:Auto Project : 901542-02 Mode : 82</p>	<p>Date: 2020-01-10 PEAK(LNB) AVG_51</p> <p>Site : 03CH07-HY Condition : PEAK(LNB) 3m HF_ANT_00075962 VERTICAL Detector : RBW:1000.000KHz VBW:3000.000KHz SWT:Auto Project : 901542-02 Mode : 82</p>
<p>Peak</p>	<p>Date: 2020-01-10 PEAK_BE(B4)_16-24</p> <p>Site : 03CH07-HY Condition : PEAK_BE(B4)_16-24 3m HF_ANT_00075962 VERTICAL Detector : RBW:1000.000KHz VBW:3000.000KHz SWT:Auto Project : 901542-02 Mode : 82</p>	<p>Left blank</p>



WIFI	Band 4 5725~5850MHz Band Edge @ 3m	
ANT	802.11n HT20 CH165 5825MHz	
1+2	Horizontal	Fundamental
Peak	<p>Site : 03CH07-11Y Condition : PEAK_BE(B4)_16-24 3m HF_ANT_00075962 HORIZONTAL Detector : RBW:1000.000KHz VBW:3000.000KHz SWT:Auto Project : 901542-02 Mode : 83</p>	<p>Site : 03CH07-11Y Condition : PEAK(LIN) 3m HF_ANT_00075962 HORIZONTAL Detector : RBW:1000.000KHz VBW:3000.000KHz SWT:Auto Project : 901542-02 Mode : 83</p>



WIFI	Band 4 5725~5850MHz Band Edge @ 3m	
ANT	802.11n HT20 CH165 5825MHz	
1+2	Vertical	Fundamental
Peak	<p>Site : 03CH07-11Y Condition : PEAK_BE(B4)_16-24 3m HF_ANT_00075962 VERTICAL Detector : Peak Project : 901542-02 Mode : 83</p>	<p>Site : 03CH07-11Y Condition : PEAK(U)N11 3m HF_ANT_00075962 VERTICAL Detector : Peak Project : 901542-02 Mode : 83</p>



**Band 4 5725~5850MHz
WIFI 802.11n HT40 (Band Edge @ 3m)**

WIFI	Band 4 5725~5850MHz Band Edge @ 3m	
ANT	802.11n HT40 CH151 5755MHz	
1+2	Horizontal	Fundamental
Peak	<p>Site : 03CH07-HY Condition : PEAK_BE(B4)_16-24 3m HF_ANT_00075962 HORIZONTAL Detector : RBW:1000.000KHz VBW:3000.000KHz SWF:Auto Project : 901542-02 Mode : 84</p>	<p>Site : 03CH07-HY Condition : PEAK(LNB) 3m HF_ANT_00075962 HORIZONTAL Detector : RBW:1000.000KHz VBW:3000.000KHz SWF:Auto Project : 901542-02 Mode : 84</p>
Peak	<p>Site : 03CH07-HY Condition : PEAK_BE(B4)_16-24 3m HF_ANT_00075962 HORIZONTAL Detector : RBW:1000.000KHz VBW:3000.000KHz SWF:Auto Project : 901542-02 Mode : 84</p>	Left blank

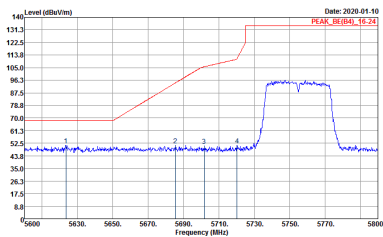
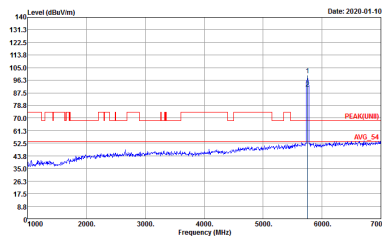
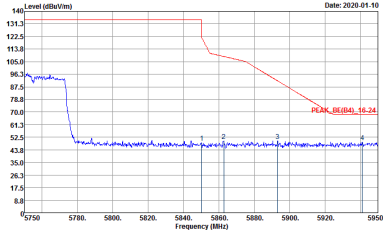

WIFI	Band 4 5725~5850MHz Band Edge @ 3m	
ANT	802.11n HT40 CH151 5755MHz	
1+2	Vertical	Fundamental
<p>Peak</p>	 <p>Site : 03CH07-HY Condition : PEAK_BE(B4)_16-24 3m HF_ANT_00075962 VERTICAL Detector : RBW:1000.000kHz VBW:3000.000kHz SWT:Auto Project : 901542-02 Mode : 84</p>	 <p>Site : 03CH07-HY Condition : PEAK(LNB) 3m HF_ANT_00075962 VERTICAL Detector : RBW:1000.000kHz VBW:3000.000kHz SWT:Auto Project : 901542-02 Mode : 84</p>
<p>Peak</p>	 <p>Site : 03CH07-HY Condition : PEAK_BE(B4)_16-24 3m HF_ANT_00075962 VERTICAL Detector : RBW:1000.000kHz VBW:3000.000kHz SWT:Auto Project : 901542-02 Mode : 84</p>	<p>Left blank</p>

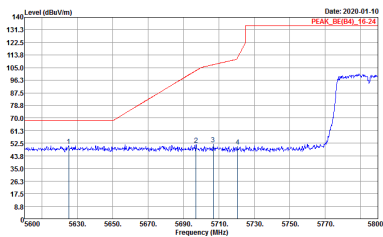
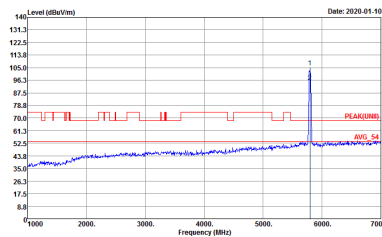
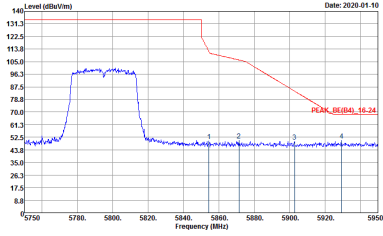

WIFI	Band 4 5725~5850MHz Band Edge @ 3m	
ANT	802.11n HT40 CH159 5795MHz	
1+2	Horizontal	Fundamental
<p>Peak</p>	 <p>Date: 2020-01-10 PEAK_BE(B4)_16-24</p> <p>Site : 03CH07-HY Condition : PEAK_BE(B4)_16-24 3m HF_ANT_00075962 HORIZONTAL : RBW:1000.000kHz VBW:3000.000kHz SWT:Auto Detector : Peak Project : 901542-02 Mode : 85</p>	 <p>Date: 2020-01-10 PEAK(LNB) AVG_54</p> <p>Site : 03CH07-HY Condition : PEAK(LNB)_3m HF_ANT_00075962 HORIZONTAL : RBW:1000.000kHz VBW:3000.000kHz SWT:Auto Detector : Peak Project : 901542-02 Mode : 85</p>
<p>Peak</p>	 <p>Date: 2020-01-10 PEAK_BE(B4)_16-24</p> <p>Site : 03CH07-HY Condition : PEAK_BE(B4)_16-24 3m HF_ANT_00075962 HORIZONTAL : RBW:1000.000kHz VBW:3000.000kHz SWT:Auto Detector : Peak Project : 901542-02 Mode : 85</p>	<p>Left blank</p>



WIFI	Band 4 5725~5850MHz Band Edge @ 3m	
ANT	802.11n HT40 CH159 5795MHz	
1+2	Vertical	Fundamental
<p>Peak</p>	<p>Site : 03CH07-HY Condition : PEAK_BE(B4)_16-24 3m HF_ANT_00075962 VERTICAL Detector : Peak Project : 901542-02 Mode : 85</p>	<p>Site : 03CH07-HY Condition : PEAK(LNB) 3m HF_ANT_00075962 VERTICAL Detector : Peak Project : 901542-02 Mode : 85</p>
<p>Peak</p>	<p>Site : 03CH07-HY Condition : PEAK_BE(B4)_16-24 3m HF_ANT_00075962 VERTICAL Detector : Peak Project : 901542-02 Mode : 85</p>	<p>Left blank</p>



Band 4 5725~5850MHz
WIFI 802.11ac VHT80 (Band Edge @ 3m)

WIFI	Band 4 5725~5850MHz Band Edge @ 3m	
ANT	802.11ac VHT80 CH155 5775MHz	
1+2	Horizontal	Fundamental
Peak	<p>Site : 03CH07-HY Condition : PEAK_BE(B4)_16-24 3m HF_ANT_00075962 HORIZONTAL Detector : RBW:1000.000kHz VBW:3000.000kHz SWF:Auto Project : 901542-02 Mode : 86</p>	<p>Site : 03CH07-HY Condition : PEAK(UWB) 3m HF_ANT_00075962 HORIZONTAL Detector : RBW:1000.000kHz VBW:3000.000kHz SWF:Auto Project : 901542-02 Mode : 86</p>
Peak	<p>Site : 03CH07-HY Condition : PEAK_BE(B4)_16-24 3m HF_ANT_00075962 HORIZONTAL Detector : RBW:1000.000kHz VBW:3000.000kHz SWF:Auto Project : 901542-02 Mode : 86</p>	Left blank

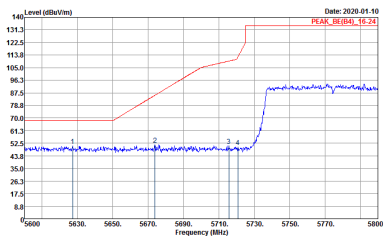
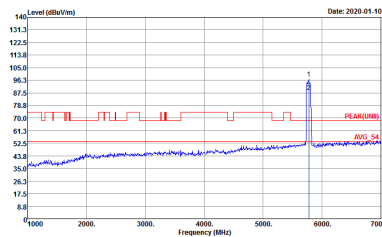
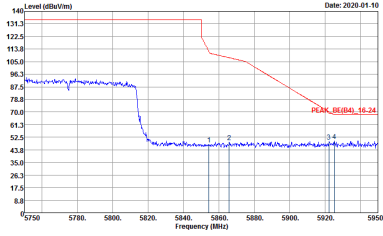

WIFI	Band 4 5725~5850MHz Band Edge @ 3m	
ANT	802.11ac VHT80 CH155 5775MHz	
1+2	Vertical	Fundamental
<p>Peak</p>	 <p>Date: 2020-01-10 PEAK_BE(B4)_16-24</p> <p>Site : 03CH07-HY Condition : PEAK_BE(B4)_16-24 3m HF_ANT_00075962 VERTICAL RBW:1000.000kHz VBW:3000.000kHz SWT:Auto Detector : Peak Project : 901542-02 Mode : 86</p>	 <p>Date: 2020-01-10 PEAK(LNB) AVG 51</p> <p>Site : 03CH07-HY Condition : PEAK(LNB) 3m HF_ANT_00075962 VERTICAL RBW:1000.000kHz VBW:3000.000kHz SWT:Auto Detector : Peak Project : 901542-02 Mode : 86</p>
<p>Peak</p>	 <p>Date: 2020-01-10 PEAK_BE(B4)_16-24</p> <p>Site : 03CH07-HY Condition : PEAK_BE(B4)_16-24 3m HF_ANT_00075962 VERTICAL RBW:1000.000kHz VBW:3000.000kHz SWT:Auto Detector : Peak Project : 901542-02 Mode : 86</p>	<p>Left blank</p>



Band 4 - 5725~5850MHz
WIFI 802.11a (Harmonic @ 3m)

WIFI	Band 4 5725~5850MHz Harmonic @ 3m	
ANT	802.11a CH149 5745MHz	
1+2	Horizontal	Vertical
Peak Avg.	<p>Site : 09CH07-HY Condition : PEAK(LINE) 3m HF_ANT_00075962 HORIZONTAL Detector : Peak Project : 901542-02 Mode : 79</p>	<p>Site : 09CH07-HY Condition : PEAK(LINE) 3m HF_ANT_00075962 VERTICAL Detector : Peak Project : 901542-02 Mode : 79</p>



WIFI	Band 4 5725~5850MHz Harmonic @ 3m	
ANT	802.11a CH157 5785MHz	
1+2	Horizontal	Vertical
<p>Peak</p> <p>Avg.</p>	<p>Site : 03CH07-1V Condition : PEAK(UM) 3m HF_ANT_00075962 HORIZONTAL Detector : Peak Project : 901542-02 Mode : 79</p>	<p>Site : 03CH07-1V Condition : PEAK(UM) 3m HF_ANT_00075962 VERTICAL Detector : Peak Project : 901542-02 Mode : 79</p>

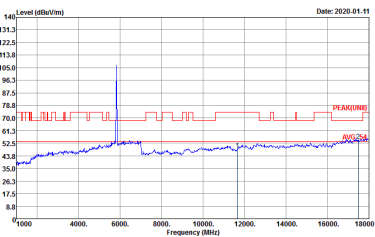
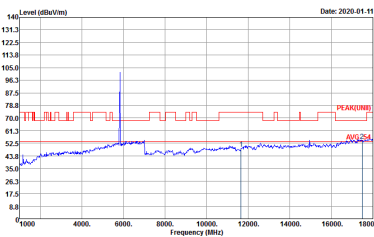

WIFI	Band 4 5725~5850MHz Harmonic @ 3m	
ANT	802.11a CH165 5825MHz	
1+2	Horizontal	Vertical
<p>Peak</p> <p>Avg.</p>	 <p>Date: 2020-01-11</p> <p>Site : 03CH07-11V Condition : PEAK(LIN) 3m HF_ANT_00075962 HORIZONTAL Detector : Peak Project : 901542-02 Mode : 80</p>	 <p>Date: 2020-01-11</p> <p>Site : 03CH07-11V Condition : PEAK(LIN) 3m HF_ANT_00075962 VERTICAL Detector : Peak Project : 901542-02 Mode : 80</p>



Band 4 5725~5850MHz
WIFI 802.11n HT20 (Harmonic @ 3m)

WIFI	Band 4 5725~5850MHz Harmonic @ 3m	
ANT	802.11n HT20 CH149 5745MHz	
1+2	Horizontal	Vertical
Peak Avg.	<p>Site : 03CH07-HY Condition : PEAK(UMI) 3m HF_ANT_00075962 HORIZONTAL Detector : Peak Project : 901542-02 Mode : 81</p>	<p>Site : 03CH07-HY Condition : PEAK(UMI) 3m HF_ANT_00075962 VERTICAL Detector : Peak Project : 901542-02 Mode : 81</p>

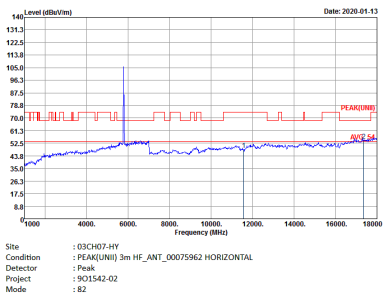
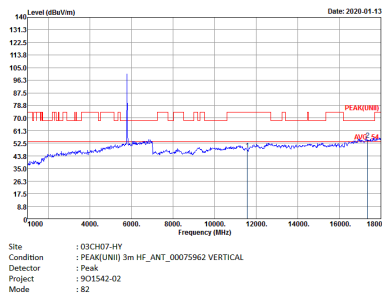

WIFI	Band 4 5725~5850MHz Harmonic @ 3m	
ANT	802.11n HT20 CH157 5785MHz	
1+2	Horizontal	Vertical
<p>Peak</p> <p>Avg.</p>		

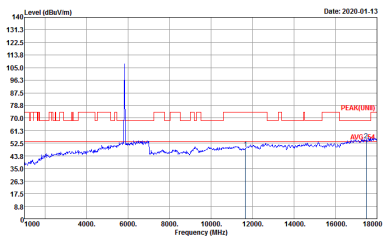
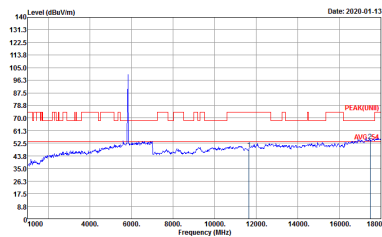

WIFI	Band 4 5725~5850MHz Harmonic @ 3m	
ANT	802.11n HT20 CH165 5825MHz	
1+2	Horizontal	Vertical
<p>Peak</p> <p>Avg.</p>	 <p>Site : 03CH07-11Y Condition : PEAK(UM) 3m HF_ANT_00075962 HORIZONTAL Detector : Peak Project : 901542-02 Mode : S3</p>	 <p>Site : 03CH07-11Y Condition : PEAK(UM) 3m HF_ANT_00075962 VERTICAL Detector : Peak Project : 901542-02 Mode : S3</p>



Band 4 5725~5850MHz
WIFI 802.11n HT40 (Harmonic @ 3m)

WIFI	Band 4 5725~5850MHz Harmonic @ 3m	
ANT	802.11n HT40 CH151 5755MHz	
1+2	Horizontal	Vertical
Peak Avg.	<p>Site : 03CH07-HY Condition : PEAK(LINII) 3m HF_ANT_00075962 HORIZONTAL Detector : Peak Project : 901542-02 Mode : 84</p>	<p>Site : 03CH07-HY Condition : PEAK(LINII) 3m HF_ANT_00075962 VERTICAL Detector : Peak Project : 901542-02 Mode : 84</p>

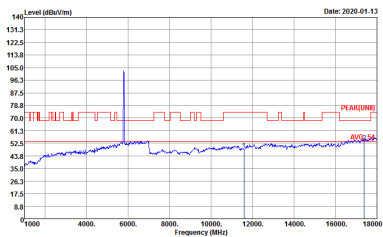
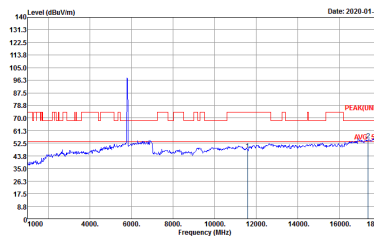

WIFI	Band 4 5725~5850MHz Harmonic @ 3m	
ANT	802.11n HT40 CH159 5795MHz	
1+2	Horizontal	Vertical
<p>Peak</p> <p>Avg.</p>	 <p>Site : ESCH07-11Y Condition : PEAK(LIN) 3m HF_ANT_00075962 HORIZONTAL Detector : Peak Project : 901542-02 Mode : SS</p>	 <p>Site : ESCH07-11Y Condition : PEAK(LIN) 3m HF_ANT_00075962 VERTICAL Detector : Peak Project : 901542-02 Mode : SS</p>

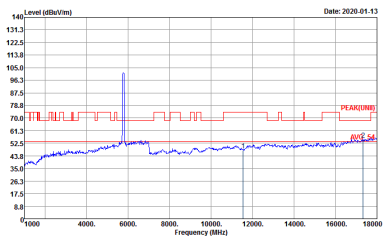
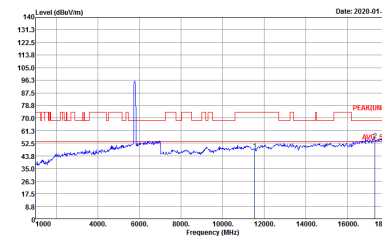

**Band 4 5725~5850MHz
WIFI 802.11ac VHT80 (Harmonic @ 3m)**

WIFI	Band 4 5725~5850MHz Harmonic @ 3m	
ANT	802.11ac VHT80 CH155 5775MHz	
1+2	Horizontal	Vertical
Peak Avg.	 <p>Site : 03CH07-HY Condition : PEAK(UNI) 3m HF_ANT_00075962 HORIZONTAL Detector : Peak Project : 901542-02 Mode : 86</p>	 <p>Site : 03CH07-HY Condition : PEAK(UNI) 3m HF_ANT_00075962 VERTICAL Detector : Peak Project : 901542-02 Mode : 86</p>



Band 4 - 5725~5850MHz

WIFI 802.11ax HE20_Full (Band Edge @ 3m)

WIFI	Band 4 5725~5850MHz Band Edge @ 3m	
ANT	802.11ax HE20_Full CH149 5745MHz	
1+2	Horizontal	Fundamental
Peak	<p>Site : 03C107-HY Condition : PEAK_BE(B4)_16-24 3m HF_ANT_00075962 HORIZONTAL : RBW:1000.000KHz VBW:3000.000KHz SWT:Auto Detector : Peak Project : 901542.02 Mode : 87</p>	<p>Site : 03C107-HY Condition : PEAK(FUN) 3m HF_ANT_00075962 HORIZONTAL : RBW:1000.000KHz VBW:3000.000KHz SWT:Auto Detector : Peak Project : 901542.02 Mode : 87</p>

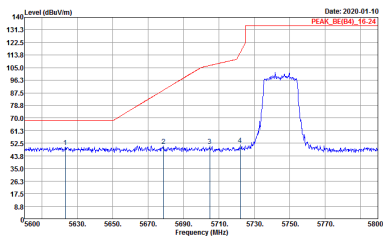
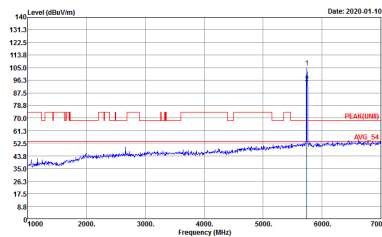

WIFI	Band 4 5725~5850MHz Band Edge @ 3m	
ANT	802.11ax HE20_Full CH149 5745MHz	
1+2	Vertical	Fundamental
<p>Peak</p> <p>Avg.</p>	 <p>Site : 03CH07-11Y Condition : PEAK_BE(B4)_16-24 3m HF_ANT_00075962 VERTICAL RBW:1000.000kHz VBW:3000.000kHz SWT:Auto Detector : Peak Project : 901542-02 Mode : 87</p>	 <p>Site : 03CH07-11Y Condition : PEAK(LNB) 3m HF_ANT_00075962 VERTICAL RBW:1000.000kHz VBW:3000.000kHz SWT:Auto Detector : Peak Project : 901542-02 Mode : 87</p>



WIFI	Band 4 5725~5850MHz Band Edge @ 3m	
ANT	802.11ax HE20_Full CH157 5785MHz	
1+2	Horizontal	Fundamental
<p>Peak</p>		
<p>Peak</p>		<p>Left blank</p>



WIFI	Band 4 5725~5850MHz Band Edge @ 3m	
ANT	802.11ax HE20_Full CH157 5785MHz	
1+2	Vertical	Fundamental
<p>Peak</p>	<p>Site : 03CH07-HY Condition : PEAK_BE(B4)_16-24 3m HF_ANT_00075962 VERTICAL Detector : Peak Project : 901542-02 Mode : 88</p>	<p>Site : 03CH07-HY Condition : PEAK(LNB) 3m HF_ANT_00075962 VERTICAL Detector : Peak Project : 901542-02 Mode : 88</p>
<p>Peak</p>	<p>Site : 03CH07-HY Condition : PEAK_BE(B4)_16-24 3m HF_ANT_00075962 VERTICAL Detector : Peak Project : 901542-02 Mode : 88</p>	<p>Left blank</p>



WIFI	Band 4 5725~5850MHz Band Edge @ 3m	
ANT	802.11ax HE20_Full CH165 5825MHz	
1+2	Horizontal	Fundamental
Peak	<p>Site : 03CH07-11Y Condition : PEAK_BE(B4)_16-24 3m HF_ANT_00075962 HORIZONTAL Detector : RBW:1000.000kHz VBW:3000.000kHz SWT:Auto Project : Peak Mode : 89</p>	<p>Site : 03CH07-11Y Condition : PEAK(LIN) 3m HF_ANT_00075962 HORIZONTAL Detector : RBW:1000.000kHz VBW:3000.000kHz SWT:Auto Project : Peak Mode : 89</p>

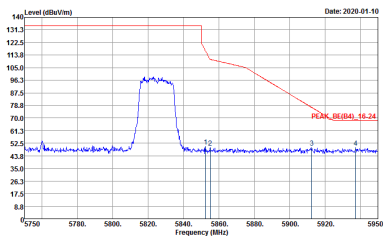
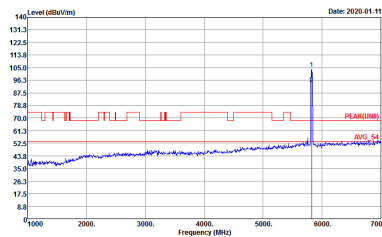

WIFI	Band 4 5725~5850MHz Band Edge @ 3m	
ANT	802.11ax HE20_Full CH165 5825MHz	
1+2	Vertical	Fundamental
<p>Peak</p> <p>Avg.</p>	 <p>Site : 03CH07-11Y Condition : PEAK_BE(B4)_16-24 3m HF_ANT_00075962 VERTICAL Detector : RBW:1000.000kHz VBW:3000.000kHz SWT:Auto Project : 9031542-02 Mode : 89</p>	 <p>Site : 03CH07-11Y Condition : PEAK(LNB) 3m HF_ANT_00075962 VERTICAL Detector : RBW:1000.000kHz VBW:3000.000kHz SWT:Auto Project : 9031542-02 Mode : 89</p>



Band 4 5725~5850MHz
WIFI 802.11ax HE40_Full (Band Edge @ 3m)

WIFI	Band 4 5725~5850MHz Band Edge @ 3m	
ANT	802.11ax HE40_Full CH151 5755MHz	
1+2	Horizontal	Fundamental
<p align="center">Peak</p>	<p>Site : 03CH07-HY Condition : PEAK_BE(B4)_16-24 3m HF_ANT_00075962 HORIZONTAL Detector : Peak Project : 901542-02 Mode : 90</p>	<p>Site : 03CH07-HY Condition : PEAK(UWB) 3m HF_ANT_00075962 HORIZONTAL Detector : Peak Project : 901542-02 Mode : 90</p>
<p align="center">Peak</p>	<p>Site : 03CH07-HY Condition : PEAK_BE(B4)_16-24 3m HF_ANT_00075962 HORIZONTAL Detector : Peak Project : 901542-02 Mode : 90</p>	<p align="center">Left blank</p>

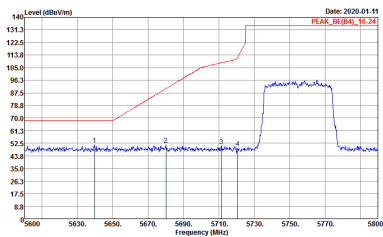
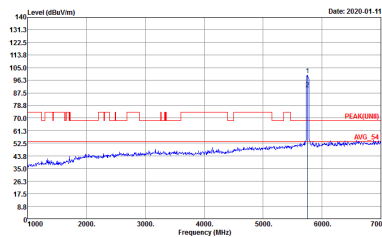
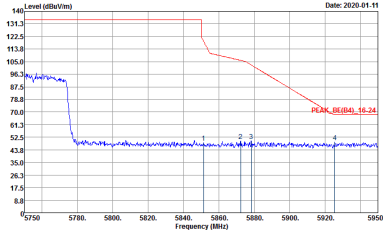

WIFI	Band 4 5725~5850MHz Band Edge @ 3m	
ANT	802.11ax HE40_Full CH151 5755MHz	
1+2	Vertical	Fundamental
<p>Peak</p>	 <p>Site : 03CH07-HY Condition : PEAK_BE(B4)_16-24 3m HF_ANT_00075962 VERTICAL Detector : RBW:1000.000kHz VBW:3000.000kHz SWT:Auto Project : 901542-02 Mode : 90</p>	 <p>Site : 03CH07-HY Condition : PEAK(LNB) 3m HF_ANT_00075962 VERTICAL Detector : RBW:1000.000kHz VBW:3000.000kHz SWT:Auto Project : 901542-02 Mode : 90</p>
<p>Peak</p>	 <p>Site : 03CH07-HY Condition : PEAK_BE(B4)_16-24 3m HF_ANT_00075962 VERTICAL Detector : RBW:1000.000kHz VBW:3000.000kHz SWT:Auto Project : 901542-02 Mode : 90</p>	<p>Left blank</p>



WIFI	Band 4 5725~5850MHz Band Edge @ 3m	
ANT	802.11ax HE40_Full CH159 5795MHz	
1+2	Horizontal	Fundamental
<p>Peak</p>	<p>Date: 2020-01-11 PEAK_BE(B4)_16-24</p> <p>Site : 03CH07-HY Condition : PEAK_BE(B4)_16-24 3m HF_ANT_00075962 HORIZONTAL RBW:1000.000kHz VBW:3000.000kHz SWT:Auto Detector : Peak Project : 901542-02 Mode : 91</p>	<p>Date: 2020-01-11 PEAK(LNB) AVG_51</p> <p>Site : 03CH07-HY Condition : PEAK(LNB)_3m HF_ANT_00075962 HORIZONTAL RBW:1000.000kHz VBW:3000.000kHz SWT:Auto Detector : Peak Project : 901542-02 Mode : 91</p>
<p>Peak</p>	<p>Date: 2020-01-11 PEAK_BE(B4)_16-24</p> <p>Site : 03CH07-HY Condition : PEAK_BE(B4)_16-24 3m HF_ANT_00075962 HORIZONTAL RBW:1000.000kHz VBW:3000.000kHz SWT:Auto Detector : Peak Project : 901542-02 Mode : 91</p>	<p>Left blank</p>

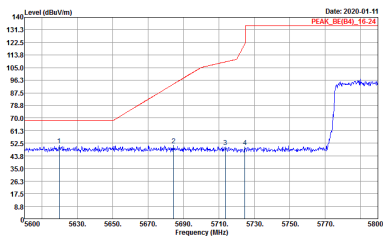
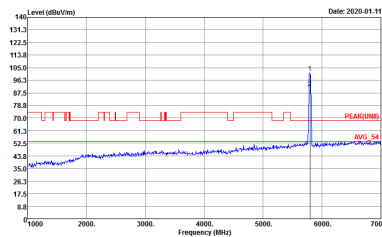
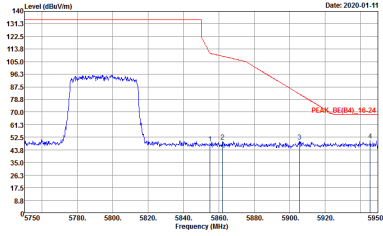

WIFI	Band 4 5725~5850MHz Band Edge @ 3m	
ANT	802.11ax HE40_Full CH159 5795MHz	
1+2	Vertical	Fundamental
<p>Peak</p>	 <p>Site : 03CH07-HY Condition : PEAK_BE(B4)_16-24 3m HF_ANT_00075962 VERTICAL Detector : Peak Project : 901542-02 Mode : 91</p>	 <p>Site : 03CH07-HY Condition : PEAK(LNB) 3m HF_ANT_00075962 VERTICAL Detector : Peak Project : 901542-02 Mode : 91</p>
<p>Peak</p>	 <p>Site : 03CH07-HY Condition : PEAK_BE(B4)_16-24 3m HF_ANT_00075962 VERTICAL Detector : Peak Project : 901542-02 Mode : 91</p>	<p>Left blank</p>



Band 4 5725~5850MHz
WIFI 802.11ax HE80_Full (Band Edge @ 3m)

WIFI	Band 4 5725~5850MHz Band Edge @ 3m	
ANT	802.11ax HE80_Full CH155 5775MHz	
1+2	Horizontal	Fundamental
Peak	<p>Site : 03CH07-HY Condition : PEAK_BE(B4)_16-24 3m HF_ANT_00075962 HORIZONTAL Detector : RBW:1000.000kHz VBW:3000.000kHz SWF:Auto Project : 901542-02 Mode : 92</p>	<p>Site : 03CH07-HY Condition : PEAK(LIN) 3m HF_ANT_00075962 HORIZONTAL Detector : RBW:1000.000kHz VBW:3000.000kHz SWF:Auto Project : 901542-02 Mode : 92</p>
Peak	<p>Site : 03CH07-HY Condition : PEAK_BE(B4)_16-24 3m HF_ANT_00075962 HORIZONTAL Detector : RBW:1000.000kHz VBW:3000.000kHz SWF:Auto Project : 901542-02 Mode : 92</p>	Left blank



WIFI	Band 4 5725~5850MHz Band Edge @ 3m	
ANT	802.11ax HE80_Full CH155 5775MHz	
1+2	Vertical	Fundamental
<p>Peak</p>	<p>Site : 03CH07-HY Condition : PEAK_BE(B4)_16-24 3m HF_ANT_00075962 VERTICAL Detector : Peak Project : 901542-02 Mode : 92</p>	<p>Site : 03CH07-HY Condition : PEAK(LUN1) 3m HF_ANT_00075962 VERTICAL Detector : Peak Project : 901542-02 Mode : 92</p>
<p>Peak</p>	<p>Site : 03CH07-HY Condition : PEAK_BE(B4)_16-24 3m HF_ANT_00075962 VERTICAL Detector : Peak Project : 901542-02 Mode : 92</p>	<p>Left blank</p>



Band 4 5725~5850MHz
WIFI 802.11ax HE20 Partial 26 (Band Edge @ 3m)

WIFI	Band 4 5725~5850MHz Band Edge @ 3m	
ANT	802.11ax HE20 Partial 26/0 CH149 5745MHz	
1+2	Horizontal	Fundamental
Peak	<p>Site : 03CH07-HY Condition : PEAK_BE(B4)_16-24 3m HF_ANT_00075962 HORIZONTAL Detector : RBW:1000.000KHz VBW:3000.000KHz SWT:Auto Project : 901542-02 Mode : S3</p>	<p>Site : 03CH07-HY Condition : PEAK(UWB) 3m HF_ANT_00075962 HORIZONTAL Detector : RBW:1000.000KHz VBW:3000.000KHz SWT:Auto Project : 901542-02 Mode : S3</p>



WIFI	Band 4 5725~5850MHz Band Edge @ 3m	
ANT	802.11ax HE20 Partial 26/0 CH149 5745MHz	
1+2	Vertical	Fundamental
Peak	<p>Site : 03CH07-11Y Condition : PEAK_BE(B4)_16-24 3m HF_ANT_00075962 VERTICAL Detector : Peak Project : 901542-02 Mode : 93</p>	<p>Site : 03CH07-11Y Condition : PEAK(LN1) 3m HF_ANT_00075962 VERTICAL Detector : Peak Project : 901542-02 Mode : 93</p>



WIFI	Band 4 5725~5850MHz Band Edge @ 3m	
ANT	802.11ax HE20 Partial 26/8 CH165 5825MHz	
1+2	Horizontal	Fundamental
Peak	<p>Site : 03CH07-11Y Condition : PEAK_BE(B4)_16-24 3m HF_ANT_00075962 HORIZONTAL RBW:1000.000kHz VBW:3000.000kHz SWT:Auto Detector : Peak Project : 901542-02 Mode : 94</p>	<p>Site : 03CH07-11Y Condition : PEAK(LNB) 3m HF_ANT_00075962 HORIZONTAL RBW:1000.000kHz VBW:3000.000kHz SWT:Auto Detector : Peak Project : 901542-02 Mode : 94</p>



WIFI	Band 4 5725~5850MHz Band Edge @ 3m	
ANT	802.11ax HE20 Partial 26/8 CH165 5825MHz	
1+2	Vertical	Fundamental
Peak	<p>Site : 03CH07-11Y Condition : PEAK_BE(B4)_16-24 3m HF_ANT_00075962 VERTICAL Detector : Peak Project : 901542-02 Mode : 94</p>	<p>Site : 03CH07-11Y Condition : PEAK(LIN) 3m HF_ANT_00075962 VERTICAL Detector : Peak Project : 901542-02 Mode : 94</p>



Band 4 5725~5850MHz
WIFI 802.11ax HE20 Partial 52 (Band Edge @ 3m)

WIFI	Band 4 5725~5850MHz Band Edge @ 3m	
ANT	802.11ax HE20 Partial 52/37 CH149 5745MHz	
1+2	Horizontal	Fundamental
Peak	<p>Site : 03CH07-HY Condition : PEAK_BE(B4)_16-24 3m HF_ANT_00075962 HORIZONTAL Detector : RBW:1000.000KHz VBW:3000.000KHz SWT:Auto Project : 901542-02 Mode : -95</p>	<p>Site : 03CH07-HY Condition : PEAK(UWB) 3m HF_ANT_00075962 HORIZONTAL Detector : RBW:1000.000KHz VBW:3000.000KHz SWT:Auto Project : 901542-02 Mode : -95</p>



WIFI	Band 4 5725~5850MHz Band Edge @ 3m	
ANT	802.11ax HE20 Partial 52/37 CH149 5745MHz	
1+2	Vertical	Fundamental
Peak	<p>Site : 03CH07-11Y Condition : PEAK_BE(B4)_16-24 3m HF_ANT_00075962 VERTICAL RBW:1000.000kHz VBW:3000.000kHz SWT:Auto Detector : Peak Project : 901542-02 Mode : 95</p>	<p>Site : 03CH07-11Y Condition : PEAK(LNB) 3m HF_ANT_00075962 VERTICAL RBW:1000.000kHz VBW:3000.000kHz SWT:Auto Detector : Peak Project : 901542-02 Mode : 95</p>

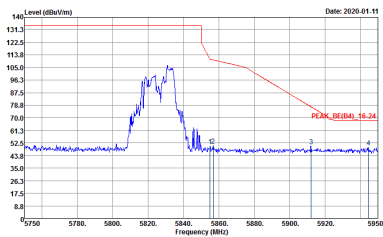
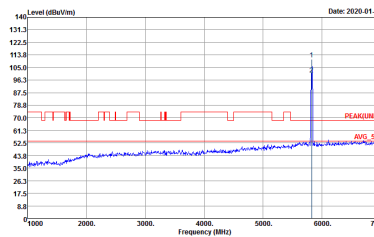

WIFI	Band 4 5725~5850MHz Band Edge @ 3m	
ANT	802.11ax HE20 Partial 52/40 CH165 5825MHz	
1+2	Horizontal	Fundamental
Peak	 <p>Site : 03CH07-11Y Condition : PEAK_BE(B4)_16-24 3m HF_ANT_00075962 HORIZONTAL RBW:1000.000kHz VBW:3000.000kHz SWT:Auto Detector : Peak Project : 901542-02 Mode : 96</p>	 <p>Site : 03CH07-11Y Condition : PEAK(LIN) 3m HF_ANT_00075962 HORIZONTAL RBW:1000.000kHz VBW:3000.000kHz SWT:Auto Detector : Peak Project : 901542-02 Mode : 96</p>

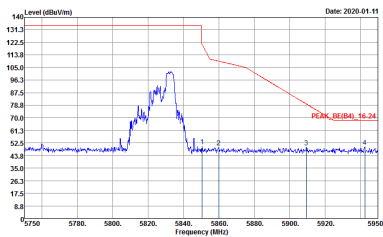
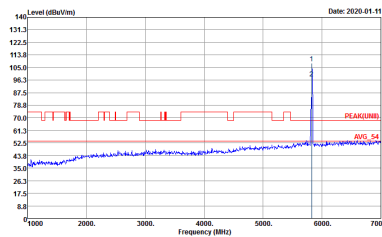

WIFI	Band 4 5725~5850MHz Band Edge @ 3m	
ANT	802.11ax HE20 Partial 52/40 CH165 5825MHz	
1+2	Vertical	Fundamental
Peak	 <p>Site : 03CH07-11Y Condition : PEAK_BE(B4)_16-24 3m HF_ANT_00075962 VERTICAL RBW:1000.000kHz VBW:3000.000kHz SWT:Auto Detector : Peak Project : 901542-02 Mode : 96</p>	 <p>Site : 03CH07-11Y Condition : PEAK(LIN) 3m HF_ANT_00075962 VERTICAL RBW:1000.000kHz VBW:3000.000kHz SWT:Auto Detector : Peak Project : 901542-02 Mode : 96</p>



Band 4 5725~5850MHz
WIFI 802.11ax HE20 Partial 106 (Band Edge @ 3m)

WIFI	Band 4 5725~5850MHz Band Edge @ 3m	
ANT	802.11ax HE20 Partial 106/53 CH149 5745MHz	
1+2	Horizontal	Fundamental
Peak	<p>Site : 03CH07-HY Condition : PEAK_BE(B4)_16-24 3m HF_ANT_00075962 HORIZONTAL Detector : RBW:1000.000KHz VBW:3000.000KHz SWT:Auto Project : 901542-02 Mode : -97</p>	<p>Site : 03CH07-HY Condition : PEAK(UWB) 3m HF_ANT_00075962 HORIZONTAL Detector : RBW:1000.000KHz VBW:3000.000KHz SWT:Auto Project : 901542-02 Mode : -97</p>



WIFI	Band 4 5725~5850MHz Band Edge @ 3m	
ANT	802.11ax HE20 Partial 106/53 CH149 5745MHz	
1+2	Vertical	Fundamental
Peak	<p>Site : 03CH07-11Y Condition : PEAK_BE(B4)_16-24 3m HF_ANT_00075962 VERTICAL RBW:1000.000kHz VBW:3000.000kHz SWT:Auto Detector : Peak Project : 901542-02 Mode : 97</p>	<p>Site : 03CH07-11Y Condition : PEAK(LIN) 3m HF_ANT_00075962 VERTICAL RBW:1000.000kHz VBW:3000.000kHz SWT:Auto Detector : Peak Project : 901542-02 Mode : 97</p>

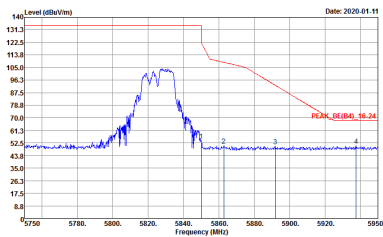
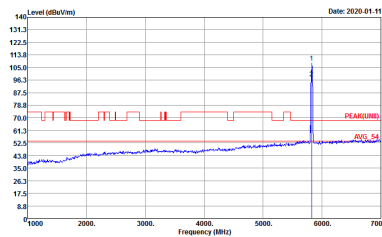

WIFI	Band 4 5725~5850MHz Band Edge @ 3m	
ANT	802.11ax HE20 Partial 106/54 CH165 5825MHz	
1+2	Horizontal	Fundamental
Peak	 <p>Site : 03CH07-11Y Condition : PEAK_BE(B4)_16-24 3m HF_ANT_00075962 HORIZONTAL RBW:1000.000KHz VBW:3000.000KHz SWT:Auto Detector : Peak Project : 901542-02 Mode : 98</p>	 <p>Site : 03CH07-11Y Condition : PEAK(LIN) 3m HF_ANT_00075962 HORIZONTAL RBW:1000.000KHz VBW:3000.000KHz SWT:Auto Detector : Peak Project : 901542-02 Mode : 98</p>

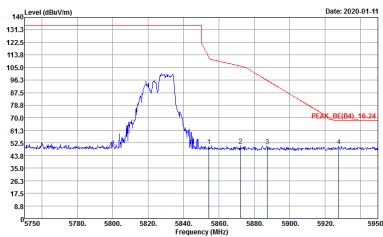
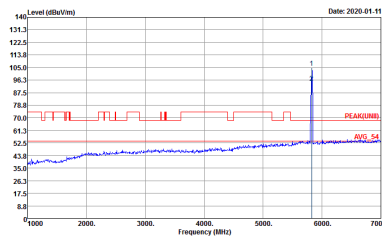

WIFI	Band 4 5725~5850MHz Band Edge @ 3m	
ANT	802.11ax HE20 Partial 106/54 CH165 5825MHz	
1+2	Vertical	Fundamental
Peak	 <p>Site : 03CH07-11Y Condition : PEAK_BE(B4)_16-24 3m HF_ANT_00075962 VERTICAL RBW:1000.000KHz VBW:3000.000KHz SWT:Auto Detector : Peak Project : 901542-02 Mode : 98</p>	 <p>Site : 03CH07-11Y Condition : PEAK(LN1) 3m HF_ANT_00075962 VERTICAL RBW:1000.000KHz VBW:3000.000KHz SWT:Auto Detector : Peak Project : 901542-02 Mode : 98</p>



Band 4 5725~5850MHz
WIFI 802.11ax HE40 Partial 242 (Band Edge @ 3m)

WIFI	Band 4 5725~5850MHz Band Edge @ 3m	
ANT	802.11ax HE40 Partial 242/61 CH151 5755MHz	
1+2	Horizontal	Fundamental
Peak	<p>Site : 03CH07-HY Condition : PEAK_BE(B4)_16-24 3m HF_ANT_00075962 HORIZONTAL Detector : Peak Project : 901542-02 Mode : 99</p>	<p>Site : 03CH07-HY Condition : PEAK(UWB) 3m HF_ANT_00075962 HORIZONTAL Detector : Peak Project : 901542-02 Mode : 99</p>
Peak	<p>Site : 03CH07-HY Condition : PEAK_BE(B4)_16-24 3m HF_ANT_00075962 HORIZONTAL Detector : Peak Project : 901542-02 Mode : 99</p>	Left blank



WIFI	Band 4 5725~5850MHz Band Edge @ 3m	
ANT	802.11ax HE40 Partial 242/61 CH151 5755MHz	
1+2	Vertical	Fundamental
<p>Peak</p>	<p>Date: 2020-01-11 PEAK_BE(B4)_16-24</p> <p>Site : 03CH07-HY Condition : PEAK_BE(B4)_16-24 3m HF_ANT_00075962 VERTICAL RBW:1000.000kHz VBW:3000.000kHz SWT:Auto Detector : Peak Project : 901542-02 Mode : 99</p>	<p>Date: 2020-01-11 PEAK(FUNB) AVG_55</p> <p>Site : 03CH07-HY Condition : PEAK(FUNB)_3m HF_ANT_00075962 VERTICAL RBW:1000.000kHz VBW:3000.000kHz SWT:Auto Detector : Peak Project : 901542-02 Mode : 99</p>
<p>Peak</p>	<p>Date: 2020-01-11 PEAK_BE(B4)_16-24</p> <p>Site : 03CH07-HY Condition : PEAK_BE(B4)_16-24 3m HF_ANT_00075962 VERTICAL RBW:1000.000kHz VBW:3000.000kHz SWT:Auto Detector : Peak Project : 901542-02 Mode : 99</p>	<p>Left blank</p>

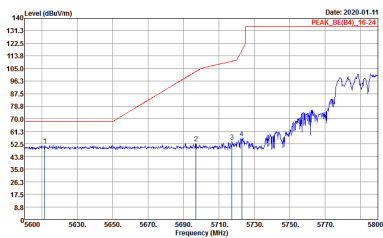
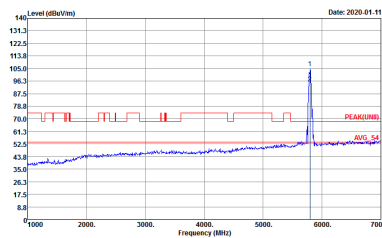
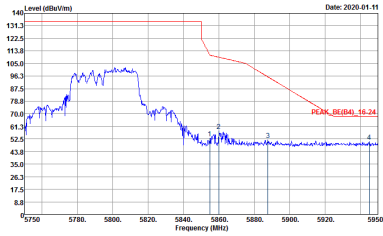

WIFI	Band 4 5725~5850MHz Band Edge @ 3m	
ANT	802.11ax HE40 Partial 242/62 CH159 5795MHz	
1+2	Horizontal	Fundamental
<p>Peak</p>	 <p>Date: 2020-01-11 PEAK_BE(B4)_16-24</p> <p>Site : 03CH07-HY Condition : PEAK_BE(B4)_16-24 3m HF_ANT_00075962 HORIZONTAL RBW:1000.000kHz VBW:3000.000kHz SWT:Auto Detector : Peak Project : 901542-02 Mode : 100</p>	 <p>Date: 2020-01-11 PEAK(LNB) AVG_55</p> <p>Site : 03CH07-HY Condition : PEAK(LNB) 3m HF_ANT_00075962 HORIZONTAL RBW:1000.000kHz VBW:3000.000kHz SWT:Auto Detector : Peak Project : 901542-02 Mode : 100</p>
<p>Peak</p>	 <p>Date: 2020-01-11 PEAK_BE(B4)_16-24</p> <p>Site : 03CH07-HY Condition : PEAK_BE(B4)_16-24 3m HF_ANT_00075962 HORIZONTAL RBW:1000.000kHz VBW:3000.000kHz SWT:Auto Detector : Peak Project : 901542-02 Mode : 100</p>	<p>Left blank</p>

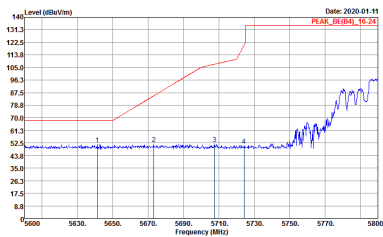
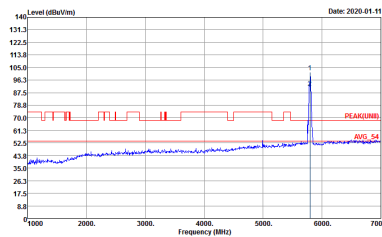
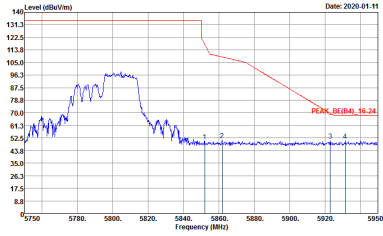

WIFI	Band 4 5725~5850MHz Band Edge @ 3m	
ANT	802.11ax HE40 Partial 242/62 CH159 5795MHz	
1+2	Vertical	Fundamental
<p>Peak</p>	 <p>Date: 2020-01-11 PEAK_BE(B4)_16-24</p> <p>Site : 03CH07-HY Condition : PEAK_BE(B4)_16-24 3m HF_ANT_00075962 VERTICAL RBW:1000.000kHz VBW:3000.000kHz SWT:Auto Detector : Peak Project : 901542-02 Mode : 100</p>	 <p>Date: 2020-01-11 PEAK(LNB) AVG_50</p> <p>Site : 03CH07-HY Condition : PEAK(LNB) 3m HF_ANT_00075962 VERTICAL RBW:1000.000kHz VBW:3000.000kHz SWT:Auto Detector : Peak Project : 901542-02 Mode : 100</p>
<p>Peak</p>	 <p>Date: 2020-01-11 PEAK_BE(B4)_16-24</p> <p>Site : 03CH07-HY Condition : PEAK_BE(B4)_16-24 3m HF_ANT_00075962 VERTICAL RBW:1000.000kHz VBW:3000.000kHz SWT:Auto Detector : Peak Project : 901542-02 Mode : 100</p>	<p>Left blank</p>

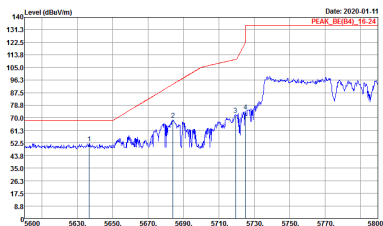
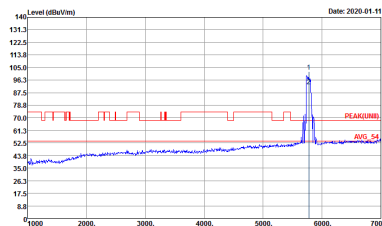
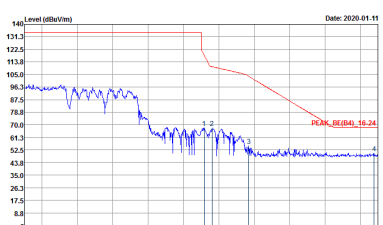

Band 4 5725~5850MHz
WIFI 802.11ax HE80 Partial 484 (Band Edge @ 3m)

WIFI	Band 4 5725~5850MHz Band Edge @ 3m	
ANT	802.11ax HE80 Partial 484/65 CH155 5775MHz	
1+2	Horizontal	Fundamental
<p align="center">Peak</p>	 <p>Site : 03CH07-HY Condition : PEAK_BE(B4)_16-24 3m HF_ANT_00075962 HORIZONTAL Detector : Peak Project : 901542-02 Mode : 101</p>	 <p>Site : 03CH07-HY Condition : PEAK(LIN) 3m HF_ANT_00075962 HORIZONTAL Detector : Peak Project : 901542-02 Mode : 101</p>
<p align="center">Peak</p>	 <p>Site : 03CH07-HY Condition : PEAK_BE(B4)_16-24 3m HF_ANT_00075962 HORIZONTAL Detector : Peak Project : 901542-02 Mode : 101</p>	<p align="center">Left blank</p>

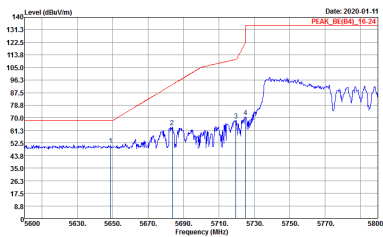
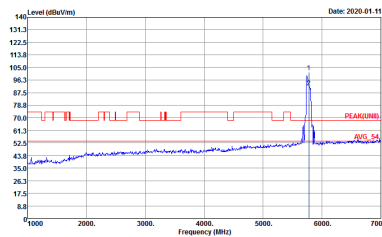
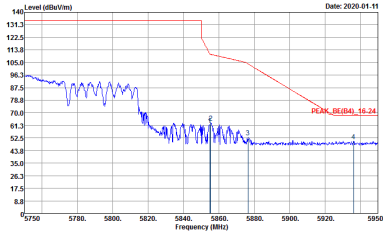

WIFI	Band 4 5725~5850MHz Band Edge @ 3m	
ANT	802.11ax HE80 Partial 484/65 CH155 5775MHz	
1+2	Vertical	Fundamental
<p>Peak</p>	 <p>Site : 03CH07-HY Condition : PEAK_BE(B4)_16-24 3m HF_ANT_00075962 VERTICAL Detector : Peak Project : 901542-02 Mode : 101</p>	 <p>Site : 03CH07-HY Condition : PEAK(LNB) 3m HF_ANT_00075962 VERTICAL Detector : Peak Project : 901542-02 Mode : 101</p>
<p>Peak</p>	 <p>Site : 03CH07-HY Condition : PEAK_BE(B4)_16-24 3m HF_ANT_00075962 VERTICAL Detector : Peak Project : 901542-02 Mode : 101</p>	<p>Left blank</p>



WIFI	Band 4 5725~5850MHz Band Edge @ 3m	
ANT	802.11ax HE80 Partial 484/66 CH155 5775MHz	
1+2	Horizontal	Fundamental
<p>Peak</p>	<p>Date: 2020-01-11 PEAK_BE(B4)_16-24</p> <p>Site : 03CH07-HY Condition : PEAK_BE(B4)_16-24 3m HF_ANT_00075962 HORIZONTAL RBW:1000.000kHz VBW:3000.000kHz SWT:Auto Detector : Peak Project : 901542-02 Mode : 102</p>	<p>Date: 2020-01-11 PEAK(LNB) AVG. 51</p> <p>Site : 03CH07-HY Condition : PEAK(LNB) 3m HF_ANT_00075962 HORIZONTAL RBW:1000.000kHz VBW:3000.000kHz SWT:Auto Detector : Peak Project : 901542-02 Mode : 102</p>
<p>Peak</p>	<p>Date: 2020-01-11 PEAK_BE(B4)_16-24</p> <p>Site : 03CH07-HY Condition : PEAK_BE(B4)_16-24 3m HF_ANT_00075962 HORIZONTAL RBW:1000.000kHz VBW:3000.000kHz SWT:Auto Detector : Peak Project : 901542-02 Mode : 102</p>	<p>Left blank</p>

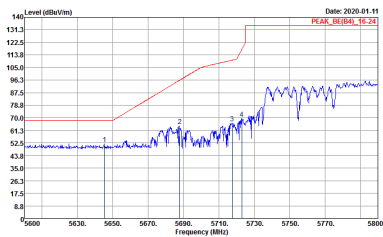
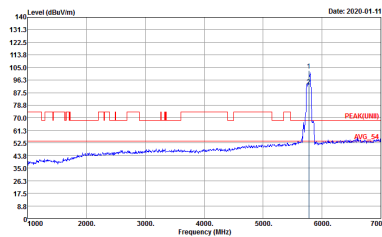
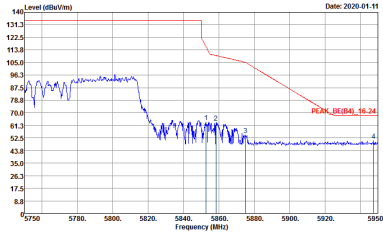

WIFI	Band 4 5725~5850MHz Band Edge @ 3m	
ANT	802.11ax HE80 Partial 484/66 CH155 5775MHz	
1+2	Vertical	Fundamental
<p>Peak</p>	 <p>Site : 03CH07-HY Condition : PEAK_BE(B4)_16-24 3m HF_ANT_00075962 VERTICAL Detector : Peak Project : 901542-02 Mode : 102</p>	 <p>Site : 03CH07-HY Condition : PEAK(LNB) 3m HF_ANT_00075962 VERTICAL Detector : Peak Project : 901542-02 Mode : 102</p>
<p>Peak</p>	 <p>Site : 03CH07-HY Condition : PEAK_BE(B4)_16-24 3m HF_ANT_00075962 VERTICAL Detector : Peak Project : 901542-02 Mode : 102</p>	<p>Left blank</p>



Band 4 - 5725~5850MHz

WIFI 802.11ax HE20_Full (Harmonic @ 3m)

WIFI	Band 4 5725~5850MHz Harmonic @ 3m	
ANT	802.11ax HE20_Full CH149 5745MHz	
1+2	Horizontal	Vertical
Peak Avg.	<p>Site : 03CH07-HY Condition : PEAK(AVG) 3m HF_ANT_00075962 HORIZONTAL Detector : Peak Project : 901542-02 Mode : E7</p>	<p>Site : 03CH07-HY Condition : PEAK(AVG) 3m HF_ANT_00075962 VERTICAL Detector : Peak Project : 901542-02 Mode : E7</p>



WIFI	Band 4 5725~5850MHz Harmonic @ 3m	
ANT	802.11ax HE20_Full CH157 5785MHz	
1+2	Horizontal	Vertical
<p>Peak</p> <p>Avg.</p>		

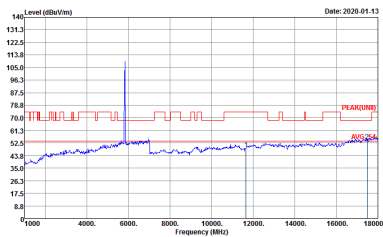
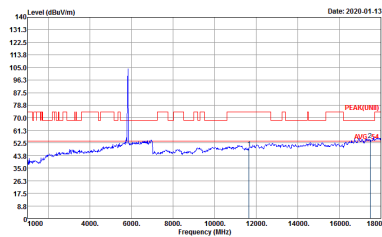

WIFI	Band 4 5725~5850MHz Harmonic @ 3m	
ANT	802.11ax HE20_Full CH165 5825MHz	
1+2	Horizontal	Vertical
<p>Peak</p> <p>Avg.</p>	 <p>Site : 03CH07-11Y Condition : PEAK(LIN) 3m HF_ANT_00075962 HORIZONTAL Detector : Peak Project : 901542-02 Mode : 0</p>	 <p>Site : 03CH07-11Y Condition : PEAK(LIN) 3m HF_ANT_00075962 VERTICAL Detector : Peak Project : 901542-02 Mode : 0</p>



**Band 4 5725~5850MHz
WIFI 802.11ax HE40_Full (Harmonic @ 3m)**

WIFI	Band 4 5725~5850MHz Harmonic @ 3m	
ANT	802.11ax HE40_Full CH151 5755MHz	
1+2	Horizontal	Vertical
Peak Avg.	<p>Site : 03CH07-HY Condition : PEAK(UNI) 3m HF_ANT_00075962 HORIZONTAL Detector : Peak Project : 901542-02 Mode : 90</p>	<p>Site : 03CH07-HY Condition : PEAK(UNI) 3m HF_ANT_00075962 VERTICAL Detector : Peak Project : 901542-02 Mode : 90</p>

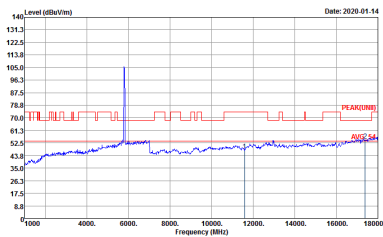
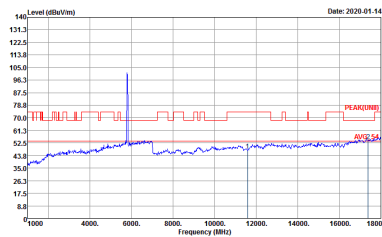

WIFI	Band 4 5725~5850MHz Harmonic @ 3m	
ANT	802.11ax HE40_Full CH159 5795MHz	
1+2	Horizontal	Vertical
<p>Peak</p> <p>Avg.</p>	 <p>Site : 03CH07-11Y Condition : PEAK(LIN) 3m HF_ANT_00075962 HORIZONTAL Detector : Peak Project : 901542-02 Mode : 91</p>	 <p>Site : 03CH07-11Y Condition : PEAK(LIN) 3m HF_ANT_00075962 VERTICAL Detector : Peak Project : 901542-02 Mode : 91</p>



**Band 4 5725~5850MHz
WIFI 802.11ax HE80_Full (Harmonic @ 3m)**

WIFI	Band 4 5725~5850MHz Harmonic @ 3m	
ANT	802.11ax HE80_Full CH155 5775MHz	
1+2	Horizontal	Vertical
Peak Avg.	<p>Site : 03CH07-HY Condition : PEAK(UNII) 3m HF_ANT_00075962 HORIZONTAL Detector : Peak Project : 901542-02 Mode : 92</p>	<p>Site : 03CH07-HY Condition : PEAK(UNII) 3m HF_ANT_00075962 VERTICAL Detector : Peak Project : 901542-02 Mode : 92</p>



**Band 4 5725~5850MHz
WIFI 802.11ax HE20 Partial 26 (Harmonic @ 3m)**

WIFI	Band 4 5725~5850MHz Harmonic @ 3m	
ANT	802.11ax HE20 Partial 26/0 CH149 5745MHz	
1+2	Horizontal	Vertical
Peak Avg.	<p>Site : 03CH07-HY Condition : PEAK(UNI) 3m HF_ANT_00075962 HORIZONTAL Detector : Peak Project : 901542-02 Mode : 93</p>	<p>Site : 03CH07-HY Condition : PEAK(UNI) 3m HF_ANT_00075962 VERTICAL Detector : Peak Project : 901542-02 Mode : 93</p>

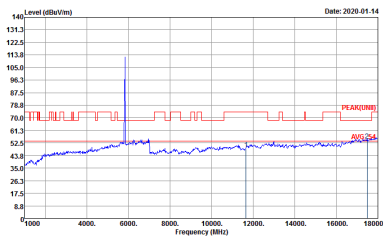
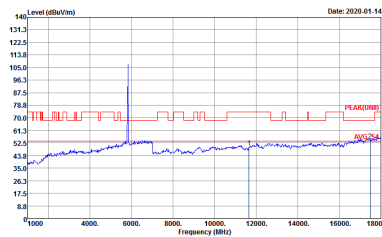

WIFI	Band 4 5725~5850MHz Harmonic @ 3m	
ANT	802.11ax HE20 Partial 26/8 CH165 5825MHz	
1+2	Horizontal	Vertical
<p>Peak</p> <p>Avg.</p>	 <p>Site : 03CH07-11Y Condition : PEAK(LIN) 3m HF_ANT_00075962 HORIZONTAL Detector : Peak Project : 901542-02 Mode : 94</p>	 <p>Site : 03CH07-11Y Condition : PEAK(LIN) 3m HF_ANT_00075962 VERTICAL Detector : Peak Project : 901542-02 Mode : 94</p>



Band 4 5725~5850MHz
WIFI 802.11ax HE20 Partial 52 (Harmonic @ 3m)

WIFI	Band 4 5725~5850MHz Harmonic @ 3m	
ANT	802.11ax HE20 Partial 52/37 CH149 5745MHz	
1+2	Horizontal	Vertical
Peak Avg.	<p>Site : 03CH07-HY Condition : PEAK(UNI) 3m HF_ANT_00075962 HORIZONTAL Detector : Peak Project : 901542-02 Mode : 95</p>	<p>Site : 03CH07-HY Condition : PEAK(UNI) 3m HF_ANT_00075962 VERTICAL Detector : Peak Project : 901542-02 Mode : 95</p>

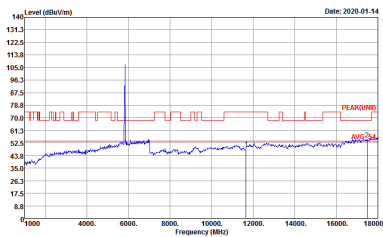
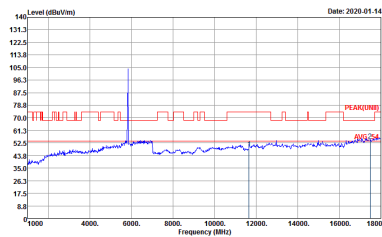

WIFI	Band 4 5725~5850MHz Harmonic @ 3m	
ANT	802.11ax HE20 Partial 52/40 CH165 5825MHz	
1+2	Horizontal	Vertical
<p>Peak</p> <p>Avg.</p>	 <p>Site : 03CH07-11Y Condition : PEAK(LIN) 3m HF_ANT_00075962 HORIZONTAL Detector : Peak Project : 901542-02 Mode : 90</p>	 <p>Site : 03CH07-11Y Condition : PEAK(LIN) 3m HF_ANT_00075962 VERTICAL Detector : Peak Project : 901542-02 Mode : 90</p>



Band 4 5725~5850MHz
WIFI 802.11ax HE20 Partial 106 (Harmonic @ 3m)

WIFI	Band 4 5725~5850MHz Harmonic @ 3m	
ANT	802.11ax HE20 Partial 106/53 CH149 5745MHz	
1+2	Horizontal	Vertical
Peak Avg.	<p>Site : 03CH07-HY Condition : PEAK(UNII) 3m HF_ANT_00075962 HORIZONTAL Detector : Peak Project : 901542-02 Mode : 97</p>	<p>Site : 03CH07-HY Condition : PEAK(UNII) 3m HF_ANT_00075962 VERTICAL Detector : Peak Project : 901542-02 Mode : 97</p>

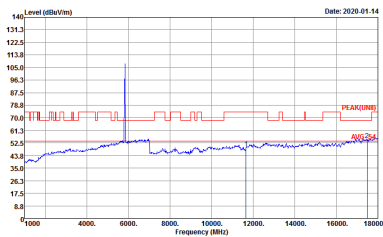
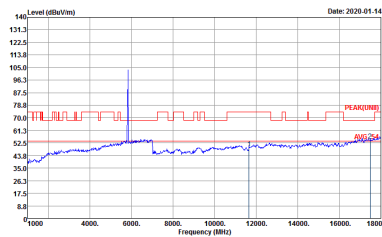

WIFI	Band 4 5725~5850MHz Harmonic @ 3m	
ANT	802.11ax HE20 Partial 106/54 CH165 5825MHz	
1+2	Horizontal	Vertical
<p>Peak</p> <p>Avg.</p>	 <p>Site : 03CH07-11Y Condition : PEAK(LIN) 3m HF_ANT_00075962 HORIZONTAL Detector : Peak Project : 901542-02 Mode : 98</p>	 <p>Site : 03CH07-11Y Condition : PEAK(LIN) 3m HF_ANT_00075962 VERTICAL Detector : Peak Project : 901542-02 Mode : 98</p>



Band 4 5725~5850MHz
WIFI 802.11ax HE40 Partial 242 (Harmonic @ 3m)

WIFI	Band 4 5725~5850MHz Harmonic @ 3m	
ANT	802.11ax HE40 Partial 242/61 CH151 5755MHz	
1+2	Horizontal	Vertical
Peak Avg.	<p>Site : 03CH07-HY Condition : PEAK(UNI) 3m HF_ANT_00075962 HORIZONTAL Detector : Peak Project : 901542-02 Mode : 99</p>	<p>Site : 03CH07-HY Condition : PEAK(UNI) 3m HF_ANT_00075962 VERTICAL Detector : Peak Project : 901542-02 Mode : 99</p>



WIFI	Band 4 5725~5850MHz Harmonic @ 3m	
ANT	802.11ax HE40 Partial 242/62 CH159 5795MHz	
1+2	Horizontal	Vertical
Peak Avg.	<p>Site : 03CH07-11Y Condition : PEAK(LIN) 3m HF_ANT_00075962 HORIZONTAL Detector : Peak Project : 901542-02 Mode : 100</p>	<p>Site : 03CH07-11Y Condition : PEAK(LIN) 3m HF_ANT_00075962 VERTICAL Detector : Peak Project : 901542-02 Mode : 100</p>



Band 4 5725~5850MHz
WIFI 802.11ax HE80 Partial 484 (Harmonic @ 3m)

WIFI	Band 4 5725~5850MHz Harmonic @ 3m	
ANT	802.11ax HE80 Partial 484/65 CH155 5775MHz	
1+2	Horizontal	Vertical
Peak Avg.	<p>Site : 03CH07-HY Condition : PEAK(UNI) 3m HF_ANT_00075962 HORIZONTAL Detector : Peak Project : 901542-02 Mode : 100</p>	<p>Site : 03CH07-HY Condition : PEAK(UNI) 3m HF_ANT_00075962 VERTICAL Detector : Peak Project : 901542-02 Mode : 100</p>

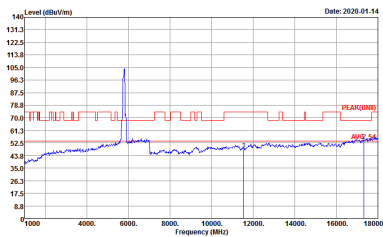
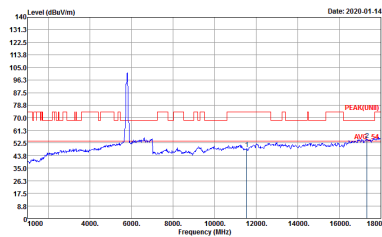

WIFI	Band 4 5725~5850MHz Harmonic @ 3m	
ANT	802.11ax HE80 Partial 484/66 CH155 5775MHz	
1+2	Horizontal	Vertical
<p>Peak</p> <p>Avg.</p>	 <p>Site : 03CH07-11Y Condition : PEAK(LIN) 3m HF_ANT_00075962 HORIZONTAL Detector : Peak Project : 901542-02 Mode : 10Z</p>	 <p>Site : 03CH07-11Y Condition : PEAK(LIN) 3m HF_ANT_00075962 VERTICAL Detector : Peak Project : 901542-02 Mode : 10Z</p>

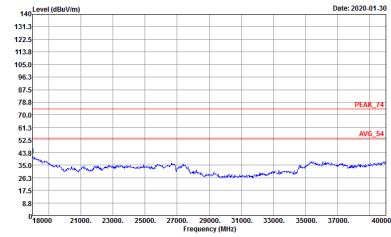
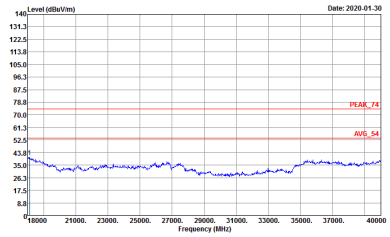

**Emission above 18GHz
5GHz WIFI 802.11ax HE40 (SHF)**

WIFI	5GHz WIFI	
ANT	802.11ax HE40 SHF	
1+2	Horizontal	Vertical
<p>QP / Peak</p>	 <p>Site : 09CH07-HY Condition : PEAK_74 1m SHF-EHF_9170576 HORIZONTAL Detector : Peak Project : 901542-02 Mode : 107</p>	 <p>Site : 09CH07-HY Condition : PEAK_74 1m SHF-EHF_9170576 VERTICAL Detector : Peak Project : 901542-02 Mode : 107</p>



Emission below 1GHz
5GHz WIFI 802.11ax HE40 (LF)

WIFI	5GHz 5725~5850MHz	
ANT	802.11ax HE40 LF	
1+2	Horizontal	Vertical
QP / Peak	<p>Site : 03CH07-HY Condition : QP 5m LF-ANT-35419(e) HORIZONTAL Detector : Peak Project : 901285 Mode : 103</p>	<p>Site : 03CH07-HY Condition : QP 5m LF-ANT-35419(e) VERTICAL Detector : Peak Project : 901285 Mode : 103</p>



<WPC Mode>

Band 4 - 5725~5850MHz

WIFI 802.11ax HE40 Partial 242 (Band Edge @ 3m)

WIFI	Band 4 5725~5850MHz Band Edge @ 3m	
ANT	802.11ax HE40 Partial 242/62 CH159 5795MHz	
1+2	Horizontal	Fundamental
Peak	<p>Site : 03CH07-HY Condition : PEAK_B1(B4)_16-24 3m HF_ANT_00075962 HORIZONTAL Detector : Peak Project : 901542-02 Mode : 105</p>	<p>Site : 03CH07-HY Condition : PEAK(B1(B4)) 3m HF_ANT_00075962 HORIZONTAL Detector : Peak Project : 901542-02 Mode : 105</p>
Peak	<p>Site : 03CH07-HY Condition : PEAK_B1(B4)_16-24 3m HF_ANT_00075962 HORIZONTAL Detector : Peak Project : 901542-02 Mode : 105</p>	Left blank



WIFI	Band 4 5725~5850MHz Band Edge @ 3m	
ANT	802.11ax HE40 Partial 242/62 CH159 5795MHz	
1+2	Vertical	Fundamental
<p>Peak</p>	<p>Date: 2020-01-14 PEAK_BE(B4)_16-24</p> <p>Site : 03CH07-HY Condition : PEAK_BE(B4)_16-24 3m HF_ANT_00075962 VERTICAL Detector : Peak Project : 901542-02 Mode : 105</p>	<p>Date: 2020-01-14 PEAK(FUNB) EVS_51</p> <p>Site : 03CH07-HY Condition : PEAK(FUNB)_3m HF_ANT_00075962 VERTICAL Detector : Peak Project : 901542-02 Mode : 105</p>
<p>Peak</p>	<p>Date: 2020-01-14 PEAK_BE(B4)_16-24</p> <p>Site : 03CH07-HY Condition : PEAK_BE(B4)_16-24 3m HF_ANT_00075962 VERTICAL Detector : Peak Project : 901542-02 Mode : 105</p>	<p>Left blank</p>



Band 4 - 5725~5850MHz

WIFI 802.11ax HE40 Partial 242 (Harmonic @ 3m)

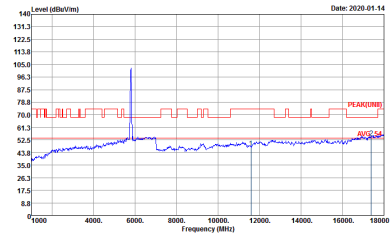
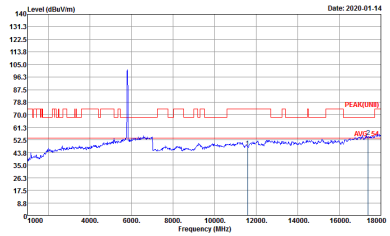
WIFI	Band 4 5725~5850MHz Harmonic @ 3m	
ANT	802.11ax HE40 Partial 242/62 CH159 5795MHz	
1+2	Horizontal	Vertical
<p>Peak</p> <p>Avg.</p>	 <p>Site : 09CH07-HY Condition : PEAK(LINE) 3m HF_ANT_00075962 HORIZONTAL Detector : Peak Project : 901542-02 Mode : 105</p>	 <p>Site : 09CH07-HY Condition : PEAK(LINE) 3m HF_ANT_00075962 VERTICAL Detector : Peak Project : 901542-02 Mode : 105</p>



Emission below 1GHz

5GHz WIFI 802.11ax HE40 (LF)

WIFI	5GHz 5725~5850MHz	
ANT	802.11ax HE40 LF	
1+2	Horizontal	Vertical
QP / Peak	<p>Site : 03CH07-HY Condition : CP 3m LF-ANT-35419(6) HORIZONTAL Detector : Peak Project : 901285 Mode : 106</p>	<p>Site : 03CH07-HY Condition : CP 3m LF-ANT-35419(6) VERTICAL Detector : Peak Project : 901285 Mode : 106</p>



Appendix E. Duty Cycle Plots

Antenna	Band	Duty Cycle(%)	T(us)	1/T(kHz)	VBW Setting	Duty Factor(dB)
1	802.11a	98.50	-	-	10Hz	0.07
2	802.11a	98.01	-	-	10Hz	0.09
1+2	802.11a for Ant. 1	98.02	-	-	10Hz	0.09
1+2	802.11a for Ant. 2	98.02	-	-	10Hz	0.09
1	5GHz 802.11n HT20	99.20	-	-	10Hz	0.03
2	5GHz 802.11n HT20	99.42	-	-	10Hz	0.03
1+2	5GHz 802.11n HT20 for Ant. 1	99.41	-	-	10Hz	0.03
1+2	5GHz 802.11n HT20 for Ant. 2	99.20	-	-	10Hz	0.03
1	5GHz 802.11n HT40	98.87	-	-	10Hz	0.05
2	5GHz 802.11n HT40	99.20	-	-	10Hz	0.03
1+2	5GHz 802.11n HT40 for Ant. 1	99.13	-	-	10Hz	0.04
1+2	5GHz 802.11n HT40 for Ant. 2	99.19	-	-	10Hz	0.04
1	5GHz 802.11ac VHT20	99.23	-	-	10Hz	0.03
2	5GHz 802.11ac VHT20	99.41	-	-	10Hz	0.03
1+2	5GHz 802.11ac VHT20 for Ant. 1	99.16	-	-	10Hz	0.04
1+2	5GHz 802.11ac VHT20 for Ant. 2	99.20	-	-	10Hz	0.03
1	5GHz 802.11ac VHT40	99.41	-	-	10Hz	0.03
2	5GHz 802.11ac VHT40	99.19	-	-	10Hz	0.04
1+2	5GHz 802.11ac VHT40 for Ant. 1	99.41	-	-	10Hz	0.03
1+2	5GHz 802.11ac VHT40 for Ant. 2	99.41	-	-	10Hz	0.03
1	5GHz 802.11ac VHT80	99.20	-	-	10Hz	0.03
2	5GHz 802.11ac VHT80	99.41	-	-	10Hz	0.03
1+2	5GHz 802.11ac VHT80 for Ant. 1	99.19	-	-	10Hz	0.04
1+2	5GHz 802.11ac VHT80 for Ant. 2	99.19	-	-	10Hz	0.04



Antenna	Band	Duty Cycle(%)	T(us)	1/T(kHz)	VBW Setting	Duty Factor(dB)
1	5GHz 802.11ax HE20	99.00	-	-	10Hz	0.04
2	5GHz 802.11ax HE20	99.96	-	-	10Hz	0.00
1+2	5GHz 802.11ax HE20 for Ant. 1	99.36	-	-	10Hz	0.03
1+2	5GHz 802.11ax HE20 for Ant. 2	99.45	-	-	10Hz	0.02
1	5GHz 802.11ax HE40	99.33	-	-	10Hz	0.03
2	5GHz 802.11ax HE40	99.17	-	-	10Hz	0.04
1+2	5GHz 802.11ax HE40 for Ant. 1	98.39	-	-	10Hz	0.07
1+2	5GHz 802.11ax HE40 for Ant. 2	98.39	-	-	10Hz	0.07
1	5GHz 802.11ax HE80	98.91	-	-	10Hz	0.05
2	5GHz 802.11ax HE80	99.45	-	-	10Hz	0.02
1+2	5GHz 802.11ax HE80 for Ant. 1	99.09	-	-	10Hz	0.04
1+2	5GHz 802.11ax HE80 for Ant. 2	99.09	-	-	10Hz	0.04



<Ant. 1>

802.11a

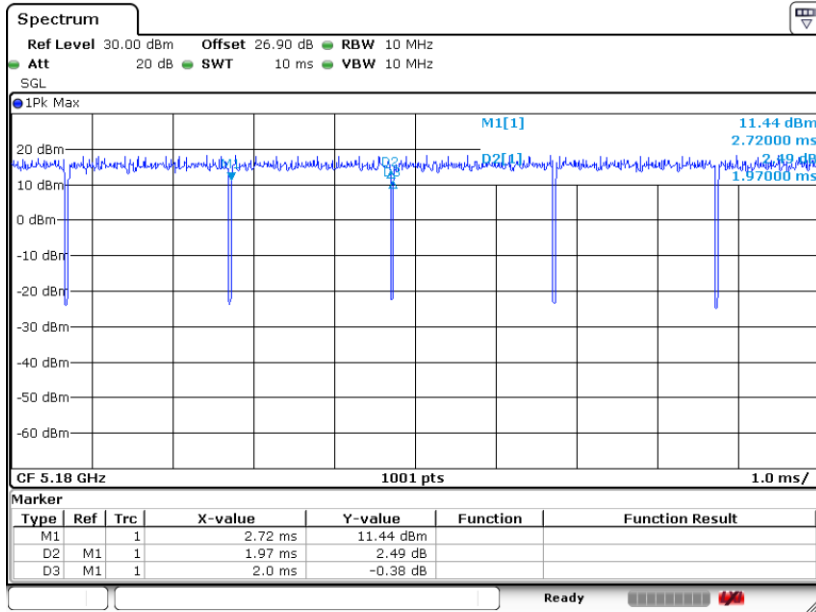

Date: 19.DEC.2019 12:33:10

802.11n HT20

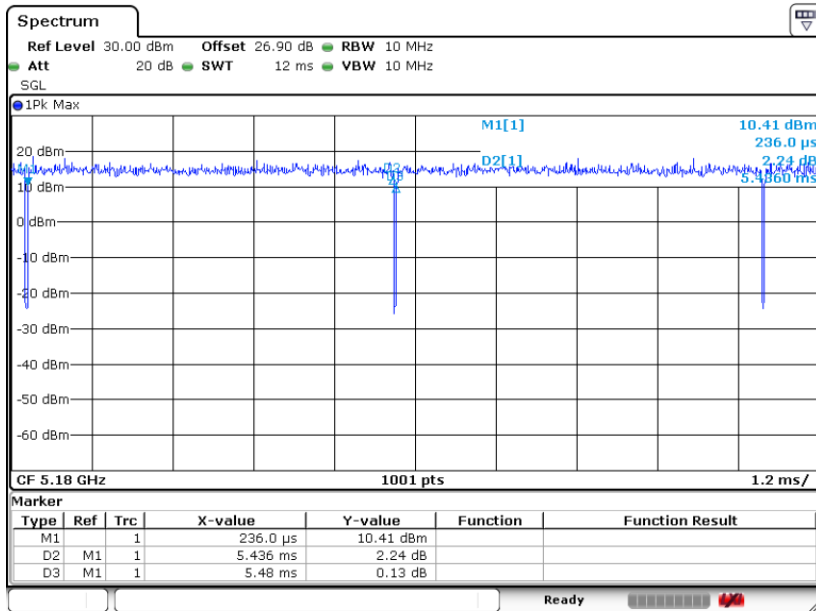

Date: 20.DEC.2019 21:49:32



802.11n HT40

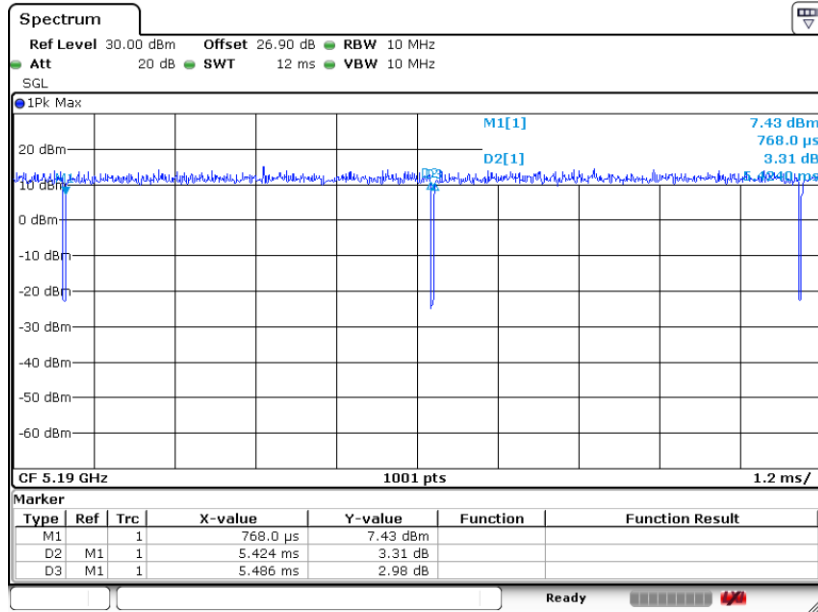

Date: 20.DEC.2019 23:31:59

802.11ac VHT20

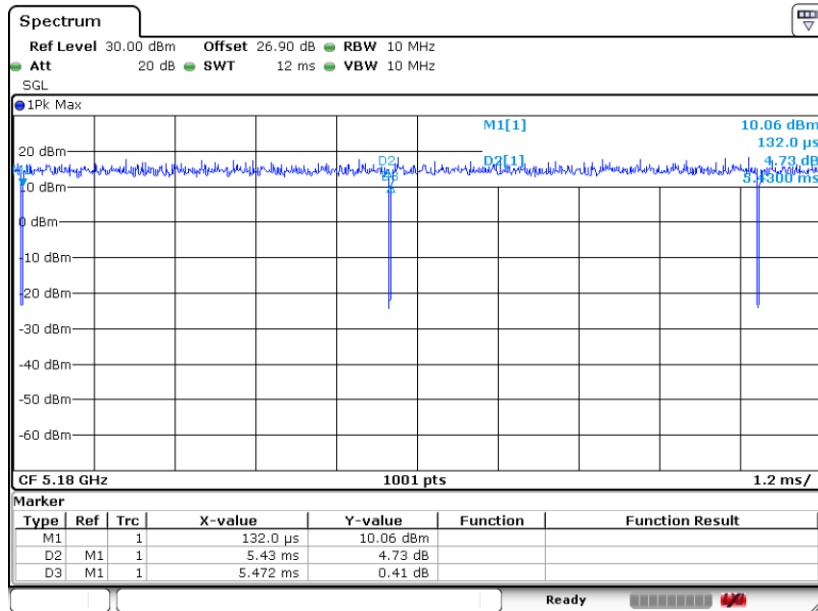

Date: 21.DEC.2019 00:31:44



802.11ac VHT40

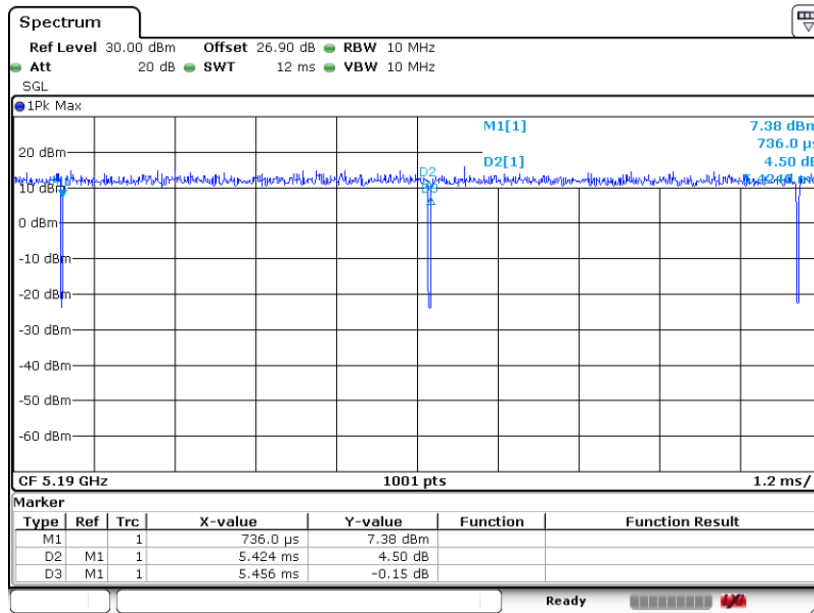

Date: 22.DEC.2019 13:29:45

802.11ac VHT80

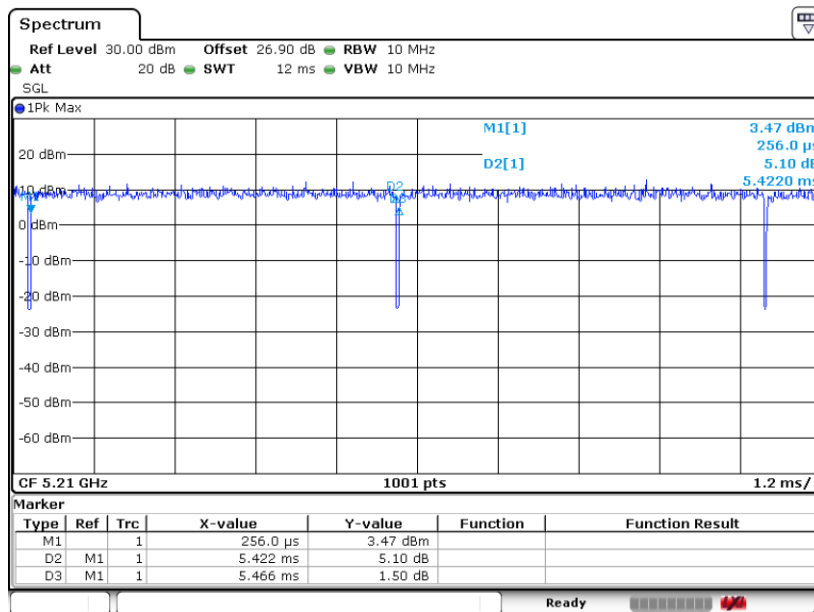

Date: 22.DEC.2019 14:44:51