



**DFS PORTION of FCC 47 CFR PART 15 SUBPART E**

**CERTIFICATION TEST REPORT**

**FOR**

**GSM/WCDMA/LTE/5G Phone with BT, DTS/UNII a/b/g/n/ac/ax, GPS, WPT & NFC**

**FCC ID: PY7-12907W**

**REPORT NUMBER: R14634918-D1**

**ISSUE DATE: 2023-03-15**

*Prepared for*

**SONY CORPORATION  
1-7-1 KONAN MINATO-KU  
TOKYO, 108-0075, JAPAN**

*Prepared by*

**UL LLC  
12 Laboratory Dr.  
Research Triangle Park, NC 27709 U.S.A.  
TEL: (919) 549-1400**



Revision History

<u>Rev.</u>	<u>Issue Date</u>	<u>Revisions</u>	<u>Revised By</u>
V1	2023-02-27	Initial Issue	Samuel Bryson
V2	2023-03-10	Corrected lowest gain antenna assembly on pg. 15	John E. Manser III
V3	2023-03-15	Corrected EIRP in Section 7.1.6	John E. Manser III

## TABLE OF CONTENTS

<b>1. ATTESTATION OF TEST RESULTS .....</b>	<b>4</b>
<b>2. TEST METHODOLOGY .....</b>	<b>5</b>
<b>3. SUMMARY OF TEST RESULTS.....</b>	<b>5</b>
<b>4. REFERENCE DOCUMENTS.....</b>	<b>5</b>
<b>5. FACILITIES AND ACCREDITATION .....</b>	<b>5</b>
<b>6. DECISION RULES AND MEASUREMENT UNCERTAINTY .....</b>	<b>6</b>
6.1. METROLOGICAL TRACEABILITY .....	6
6.2. DECISION RULES.....	6
<b>7. DYNAMIC FREQUENCY SELECTION.....</b>	<b>7</b>
7.1. OVERVIEW .....	7
7.1.1. LIMITS.....	7
7.1.2. TEST AND MEASUREMENT SYSTEM.....	11
7.1.3. TEST AND MEASUREMENT SOFTWARE.....	13
7.1.4. TEST ROOM ENVIRONMENT .....	13
7.1.5. SETUP OF EUT.....	14
7.1.6. DESCRIPTION OF EUT .....	15
7.2. RESULTS FOR 20 MHz BANDWIDTH .....	17
7.2.1. TEST CHANNEL .....	17
7.2.2. RADAR WAVEFORM AND TRAFFIC.....	17
7.2.3. OVERLAPPING CHANNEL TESTS.....	20
7.2.4. MOVE AND CLOSING TIME .....	20
7.3. RESULTS FOR 40 MHz BANDWIDTH .....	24
7.3.1. TEST CHANNEL .....	24
7.3.2. RADAR WAVEFORM AND TRAFFIC.....	24
7.3.3. OVERLAPPING CHANNEL TESTS.....	27
7.3.4. MOVE AND CLOSING TIME .....	27
7.4. RESULTS FOR 80 MHz BANDWIDTH .....	31
7.4.1. TEST CHANNEL .....	31
7.4.2. RADAR WAVEFORM AND TRAFFIC.....	31
7.4.3. OVERLAPPING CHANNEL TESTS.....	34
7.4.4. MOVE AND CLOSING TIME .....	34
7.5. RESULTS FOR 160 MHz BANDWIDTH .....	38
7.5.1. TEST CHANNEL .....	38
7.5.2. RADAR WAVEFORM AND TRAFFIC.....	38
7.5.3. OVERLAPPING CHANNEL TESTS.....	41
7.5.4. MOVE AND CLOSING TIME .....	41
7.5.5. NON-OCCUPANCY PERIOD .....	45
<b>8. SETUP PHOTOS.....</b>	<b>46</b>

# 1. ATTESTATION OF TEST RESULTS

**COMPANY NAME:** Sony Corporation  
1-7-1 Konan Minato-Ku  
Tokyo, 108-0075, Japan

**EUT DESCRIPTION:** GSM/WCDMA/LTE/5G Phone with BT, DTS/UNII a/b/g/n/ac/ax,  
GPS, WPT & NFC

**SERIAL NUMBER:** QV7700EDFN

**DATE TESTED:** 2023-01-28 to 2023-01-30

APPLICABLE STANDARDS	
STANDARD	TEST RESULTS
DFS Portion of CFR 47 Part 15 Subpart E	Complies

UL LLC tested the above equipment in accordance with the requirements set forth in the above standards. The test results show that the equipment tested is capable of demonstrating compliance with the requirements as documented in this report.

The results documented in this report apply only to the tested sample, under the conditions and modes of operation as described herein. It is the manufacturer's responsibility to assure that additional production units of this model are manufactured with identical electrical and mechanical components. All samples tested were in good operating condition throughout the entire test program. Measurement Uncertainties are published for informational purposes only and were not taken into account unless noted otherwise.

This document may not be altered or revised in any way unless done so by UL LLC and all revisions are duly noted in the revisions section. Any alteration of this document not carried out by UL LLC will constitute fraud and shall nullify the document. This report must not be used by the client to claim product certification, approval, or endorsement by A2LA, NIST, any agency of the Federal Government, or any agency of the U.S. government.

Approved & Released For  
UL LLC By:



Henry Lau  
Senior Project Engineer  
CONSUMER TECHNOLOGY DIVISION  
UL Verification Services Inc.

Prepared By:



Samuel Bryson  
Laboratory Technician  
CONSUMER TECHNOLOGY DIVISION  
UL LLC

## 2. TEST METHODOLOGY

The tests documented in this report were performed in accordance with the DFS portion of FCC CFR 47 Part 2, FCC CFR 47 Part 15, FCC KDB 789033, KDB 905462 D02 and D03.

## 3. SUMMARY OF TEST RESULTS

Requirement Description	Result	Remarks
DFS Portion of FCC 47 CFR PART 15 SUBPART E	Complies	

## 4. REFERENCE DOCUMENTS

Measurements of transmitter parameters as referenced in this report and all other manufacturer's declarations relevant to the RF test requirements are documented in UL LLC report number R14634918-E5 and R14634918-E6.

This report contains data provided by the customer which can impact the validity of results. UL LLC is only responsible for the validity of results after the integration of the data provided by the customer.

Below is a list of the data provided by the customer:

1. Antenna gain and type (see section 7.1.6)

## 5. FACILITIES AND ACCREDITATION

UL LLC is accredited by A2LA, certification # 0751.06, for all testing performed within the scope of this report. Testing was performed at the locations noted below.

	Address	ISED CABID	ISED Company Number	FCC Registration
<input type="checkbox"/>	Building: 12 Laboratory Dr RTP, NC 27709, U.S.A	US0067	2180C	825374
<input checked="" type="checkbox"/>	Building: 2800 Perimeter Park Dr. Suite B Morrisville, NC 27560, U.S.A		27265	

---

## **6. DECISION RULES AND MEASUREMENT UNCERTAINTY**

### **6.1. METROLOGICAL TRACEABILITY**

All test and measuring equipment utilized to perform the tests documented in this report are calibrated on a regular basis, with a maximum time between calibrations of one year or the manufacturers' recommendation, whichever is less, and where applicable is traceable to recognized national standards.

### **6.2. DECISION RULES**

The Decision Rule is based on Simple Acceptance in accordance with ISO Guide 98-4:2012 Clause 8.2. (Measurement uncertainty is not taken into account when stating conformity with a specified requirement).

---

## 7. DYNAMIC FREQUENCY SELECTION

### 7.1. OVERVIEW

#### 7.1.1. LIMITS

##### FCC

§15.407 (h), FCC KDB 905462 D02 “COMPLIANCE MEASUREMENT PROCEDURES FOR UNLICENSED-NATIONAL INFORMATION INFRASTRUCTURE DEVICES OPERATING IN THE 5250-5350 MHz AND 5470-5725 MHz BANDS INCORPORATING DYNAMIC FREQUENCY SELECTION” and KDB 905462 D03 “U-NII CLIENT DEVICES WITHOUT RADAR DETECTION CAPABILITY”.

**Table 1: Applicability of DFS requirements prior to use of a channel**

Requirement	Operational Mode		
	Master	Client (without radar detection)	Client (with radar detection)
Non-Occupancy Period	Yes	Not required	Yes
DFS Detection Threshold	Yes	Not required	Yes
Channel Availability Check Time	Yes	Not required	Not required
U-NII Detection Bandwidth	Yes	Not required	Yes

**Table 2: Applicability of DFS requirements during normal operation**

Requirement	Operational Mode		
	Master	Client (without DFS)	Client (with DFS)
DFS Detection Threshold	Yes	Not required	Yes
Channel Closing Transmission Time	Yes	Yes	Yes
Channel Move Time	Yes	Yes	Yes
U-NII Detection Bandwidth	Yes	Not required	Yes

Additional requirements for devices with multiple bandwidth modes	Master Device or Client with Radar DFS	Client (without DFS)
<i>U-NII Detection Bandwidth and Statistical Performance Check</i>	All BW modes must be tested	Not required
<i>Channel Move Time and Channel Closing Transmission Time</i>	Test using widest BW mode available	Test using the widest BW mode available for the link
<i>All other tests</i>	Any single BW mode	Not required

**Note:** Frequencies selected for statistical performance check (Section 7.8.4) should include several frequencies within the radar detection bandwidth and frequencies near the edge of the radar detection bandwidth. For 802.11 devices it is suggested to select frequencies in all 20 MHz channel blocks and a null frequency between the bonded 20 MHz channel blocks.



**Table 3: Interference Threshold values, Master or Client incorporating In-Service Monitoring**

Maximum Transmit Power	Value (see notes)
E.I.R.P. $\geq$ 200 mill watt	-64 dBm
E.I.R.P. < 200 mill watt and power spectral density < 10 dBm/MHz	-62 dBm
E.I.R.P. < 200 mill watt that do not meet power spectral density requirement	-64 dBm
<p><b>Note 1:</b> This is the level at the input of the receiver assuming a 0 dBi receive antenna  <b>Note 2:</b> Throughout these test procedures an additional 1 dB has been added to the amplitude of the test transmission waveforms to account for variations in measurement equipment. This will ensure that the test signal is at or above the detection threshold level to trigger a DFS response.  <b>Note 3:</b> E.I.R.P. is based on the highest antenna gain. For MIMO devices refer to KDB publication 662911 D01.</p>	

**Table 4: DFS Response requirement values**

Parameter	Value
<i>Non-occupancy period</i>	30 minutes
<i>Channel Availability Check Time</i>	60 seconds
<i>Channel Move Time</i>	10 seconds (See Note 1)
<i>Channel Closing Transmission Time</i>	200 milliseconds + approx. 60 milliseconds over remaining 10 second period. (See Notes 1 and 2)
<i>U-NII Detection Bandwidth</i>	Minimum 100% of the U-NII 99% transmission power bandwidth. (See Note 3)
<p><b>Note 1:</b> <i>Channel Move Time</i> and the <i>Channel Closing Transmission Time</i> should be performed with Radar Type 0. The measurement timing begins at the end of the Radar Type 0 burst.  <b>Note 2:</b> The <i>Channel Closing Transmission Time</i> is comprised of 200 milliseconds starting at the beginning of the <i>Channel Move Time</i> plus any additional intermittent control signals required to facilitate a <i>Channel</i> move (an aggregate of 60 milliseconds) during the remainder of the 10 second period. The aggregate duration of control signals will not count quiet periods in between transmissions.  <b>Note 3:</b> During the <i>U-NII Detection Bandwidth</i> detection test, radar type 0 should be used. For each frequency step the minimum percentage of detection is 90 percent. Measurements are performed with no data traffic.</p>	

**Table 5 – Short Pulse Radar Test Waveforms**

Radar Type	Pulse Width (usec)	PRI (usec)	Pulses	Minimum Percentage of Successful Detection	Minimum Trials
0	1	1428	18	See Note 1	See Note 1
1	1	Test A: 15 unique PRI values randomly selected from the list of 23 PRI values in table 5a	Roundup: $\{(1/360) \times (19 \times 10^6 / \text{PRI}_{\text{usec}})\}$	60%	30
		Test B: 15 unique PRI values randomly selected within the range of 518-3066 usec. With a minimum increment of 1 usec, excluding PRI values selected in Test A			
2	1-5	150-230	23-29	60%	30
3	6-10	200-500	16-18	60%	30
4	11-20	200-500	12-16	60%	30
Aggregate (Radar Types 1-4)				80%	120
<b>Note 1:</b> Short Pulse Radar Type 0 should be used for the <i>Detection Bandwidth</i> test, <i>Channel Move Time</i> , and <i>Channel Closing Time</i> tests.					

**Table 6 – Long Pulse Radar Test Signal**

Radar Waveform Type	Pulse Width (μsec)	Chirp Width (MHz)	PRI (μsec)	Pulses per Burst	Number of Bursts	Minimum Percentage of Successful Detection	Minimum Trials
5	50-100	5-20	1000-2000	1-3	8-20	80%	30

**Table 7 – Frequency Hopping Radar Test Signal**

Radar Waveform Type	Pulse Width (μsec)	PRI (μsec)	Pulses per Hop	Hopping Rate (kHz)	Hopping Sequence Length (msec)	Minimum Percentage of Successful Detection	Minimum Trials
6	1	333	9	0.333	300	70%	30

### 7.1.2. TEST AND MEASUREMENT SYSTEM

#### RADIATED METHOD SYSTEM BLOCK DIAGRAM

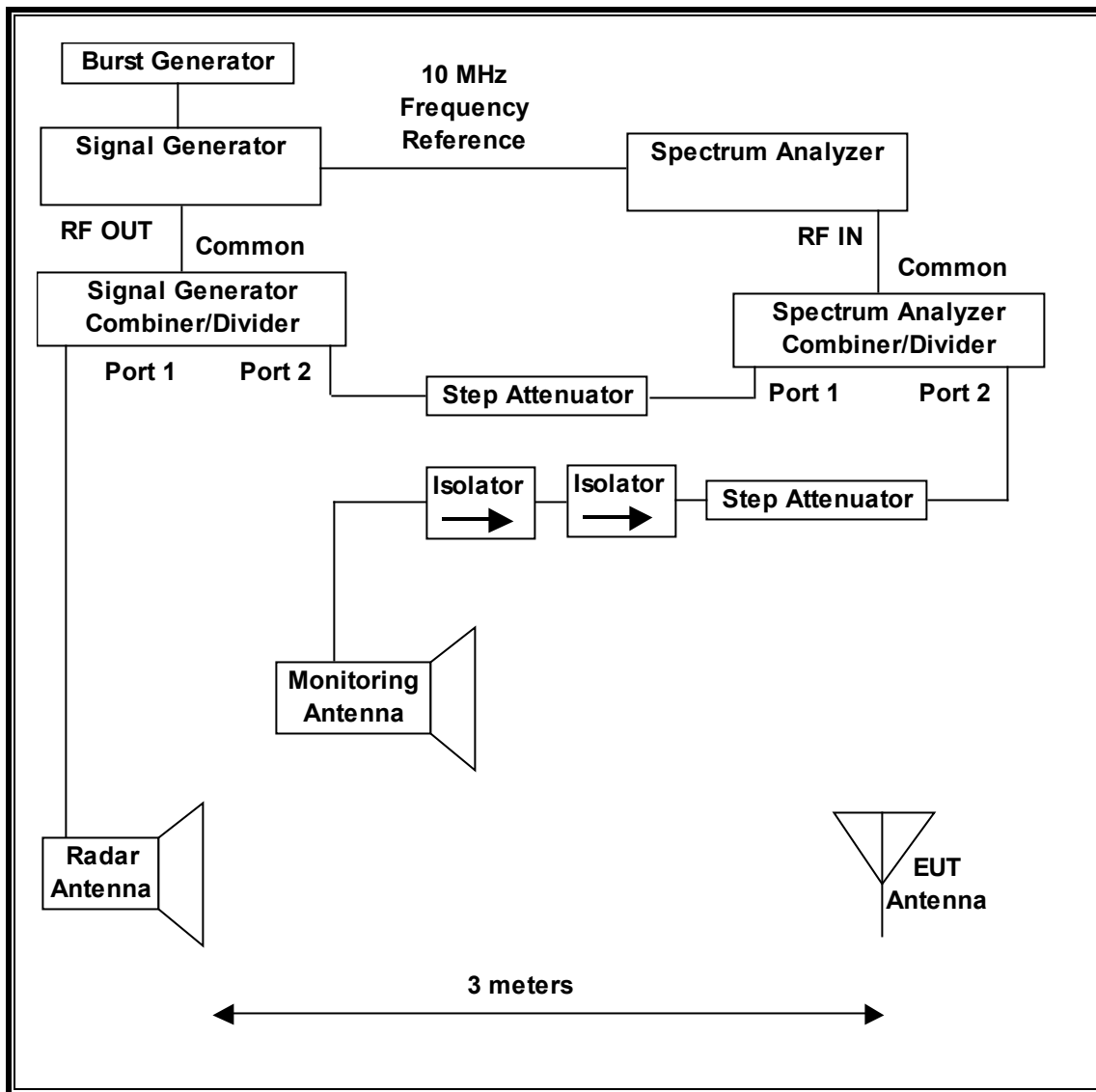

## **SYSTEM OVERVIEW**

The short pulse and long pulse signal generating system utilizes the NTIA software. The Vector Signal Generator has been validated by the NTIA. The hopping signal generating system utilizes the CCS simulated hopping method and system, which has been validated by the DoD, FCC and NTIA. The software selects waveform parameters from within the bounds of the signal type on a random basis using uniform distribution.

The short pulse types 1, 2, 3 and 4, and the long pulse type 5 parameters are randomized at run-time.

The hopping type 6 pulse parameters are fixed while the hopping sequence is based on the August 2005 NTIA Hopping Frequency List. The initial starting point randomized at run-time and each subsequent starting point is incremented by 475. Each frequency in the 100-length segment is compared to the boundaries of the EUT Detection Bandwidth and the software creates a hopping burst pattern in accordance with Section 7.4.1.3 Method #2 Simulated Frequency Hopping Radar Waveform Generating Subsystem of KDB 905462 D02. The frequency of the signal generator is incremented in 1 MHz steps from  $F_L$  to  $F_H$  for each successive trial. This incremental sequence is repeated as required to generate a minimum of 30 total trials and to maintain a uniform frequency distribution over the entire Detection Bandwidth.

The signal monitoring equipment consists of a spectrum analyzer. The aggregate ON time is calculated by multiplying the number of bins above a threshold during a particular observation period by the dwell time per bin, with the analyzer set to peak detection and max hold.

## **SYSTEM CALIBRATION**

A 50-ohm load is connected in place of the spectrum analyzer, and the spectrum analyzer is connected to a horn antenna via a coaxial cable, with the reference level offset set to (horn antenna gain – coaxial cable loss). The signal generator is set to CW mode. The amplitude of the signal generator is adjusted to yield a level of –64 dBm as measured on the spectrum analyzer.

Without changing any of the instrument settings, the spectrum analyzer is reconnected to the Common port of the Spectrum Analyzer Combiner/Divider. The Reference Level Offset of the spectrum analyzer is adjusted so that the displayed amplitude of the signal is –64 dBm.

The spectrum analyzer displays the level of the signal generator as received at the antenna ports of the Master Device. The interference detection threshold may be varied from the calibrated value of –64 dBm and the spectrum analyzer will still indicate the level as received by the Master Device.

**ADJUSTMENT OF DISPLAYED TRAFFIC LEVEL**

A link is established between the Master and Slave and the distance between the units is adjusted as needed to provide a suitable received level at the Master and Slave devices. Traffic that meets or exceed the minimum loading requirement is streamed from the Master device to the Slave Device. The monitoring antenna is adjusted so that the WLAN traffic level, as displayed on the spectrum analyzer, is at lower amplitude than the radar detection threshold.

**TEST AND MEASUREMENT EQUIPMENT**

The following test and measurement equipment was utilized for the tests documented in this report:

TEST EQUIPMENT LIST				
Description	Manufacturer	Model	ID No.	Cal Due
Spectrum Analyzer, PXA, 3Hz to 8.4GHz	Keysight	N9030A	SA0021	2023-07-14
Signal Generator, MXG X-Series RF Vector	Keysight	N5182B	SIG003	2023-05-19
2.5-7.5 GHz Horn Antenna	Advanced Technical Materials INC.	250-441EM-NF/CAL	AT0070	2023-04-11

**7.1.3. TEST AND MEASUREMENT SOFTWARE**

The following test and measurement software was utilized for the tests documented in this report:

**Slave Device Testing**

TEST SOFTWARE LIST		
Name	Version	Test / Function
Aggregate Time-PXA	3.1	Channel Loading and Aggregate Closing Time
PXA Read	3.1	Signal Generator Screen Capture
SGXProject.exe	1.7	Radar Waveform Generation and Download

**7.1.4. TEST ROOM ENVIRONMENT**

The test room temperature and humidity shall be maintained within normal temperature of 15~35 °C and normal humidity 20~75% (relative humidity).

**ENVIRONMENT CONDITION**

Parameter	Value
Temperature	21 – 23.3 °C
Humidity	20 – 44 %

### 7.1.5. SETUP OF EUT

#### RADIATED METHOD EUT TEST SETUP

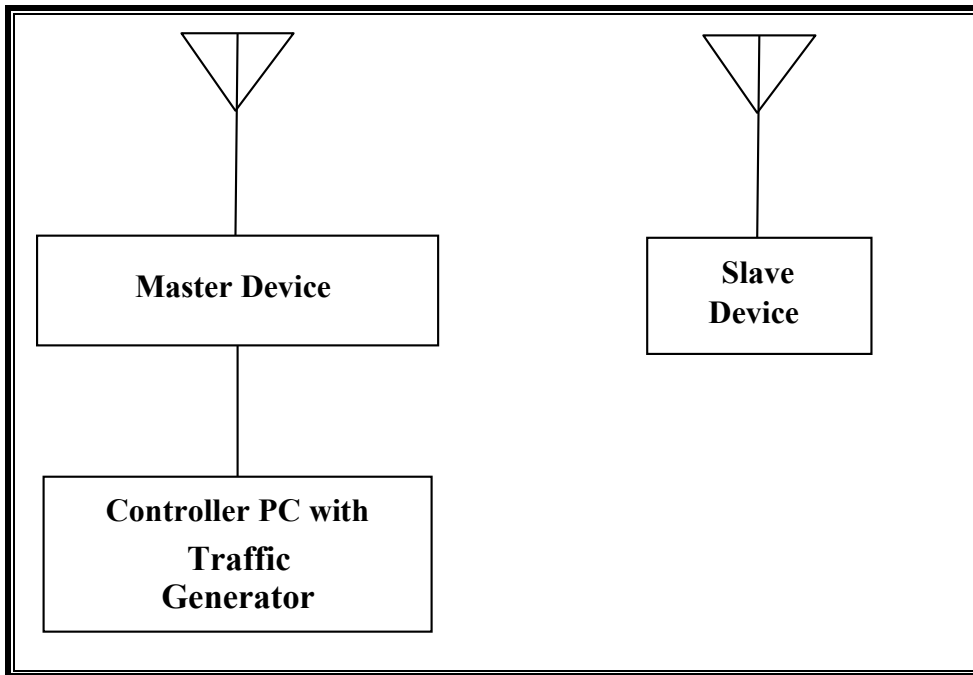

#### SUPPORT EQUIPMENT

The following support equipment was utilized for the tests documented in this report:

PERIPHERAL SUPPORT EQUIPMENT LIST				
Description	Manufacturer	Model	Serial Number	FCC ID
Master Device	ASUS	GT-AXE11000	M9IG0X400839JKM	MSQ-RTAXJF00
Master Device Power Supply	Ac Bel	ADDD011 LPS	ADD01117AG2134034 40A	N/A
Controller Laptop	Lenovo	Yoga 7 14ITL5	PF323ZV2	PD9AX201 NG
Laptop Power Supply	Lenovo	ADLX65YLC2D	N/A	N/A

### 7.1.6. DESCRIPTION OF EUT

For FCC the EUT operates over the 5250-5350 MHz and 5470-5725 MHz ranges.

The EUT is a Slave Device without Radar Detection.

The manufacturer has declared that the highest power level within these bands is 14.67 dBm EIRP in the 5250-5350 MHz band and 14.54 dBm EIRP in the 5470-5725 MHz band.

The manufacturer has declared that the highest gain antenna assembly utilized with the EUT has a gain of 0.61 dBi in the 5250-5350 MHz band and 0.53 dBi in the 5470-5725 MHz band. The manufacturer has declared that the lowest gain antenna assembly utilized with the EUT has a gain of -0.29 dBi in the 5250-5350 MHz band and -0.43 dBi in the 5470-5725 MHz band.

Two identical antennas are utilized to meet the diversity and MIMO operational requirements.

The rated output power of the Master unit is > 23dBm (EIRP). Therefore the required interference threshold level is -64 dBm. After correction for procedural adjustments, the required radiated threshold at the antenna port is  $-64 + 1 = -63$  dBm.

The EUT uses two transmitter/receiver chains, each connected to an antenna to perform radiated tests.

WLAN traffic that meets or exceeds the minimum required loading was generated by transferring a data stream from the Master Device to the Slave Device using iPerf version 3.1.3 software package.

TPC is not required since the maximum EIRP is less than 500 mW (27 dBm).

The EUT utilizes the 802.11ax architecture. Four nominal channel bandwidths are implemented: 20 MHz, 40 MHz, 80 MHz and 160 MHz.

Channel puncturing is not supported by the EUT.

TDLS (Tunneled Direct Link Setup) mode is not supported by the EUT.

The software installed in the EUT is:  
Build Number 67.0.B.0.81  
Magic iPerf 3.1

The software installed in the access point is v 3.0.0.4.386\_42489.

---

**UNIFORM CHANNEL SPREADING**

This is requirement not applicable to Slave Devices.

**OVERVIEW OF MASTER DEVICE WITH RESPECT TO §15.407 (h) REQUIREMENTS**

The Master Device is an Asus Access Point, FCC ID: MSQ-RTAXJF00. The minimum antenna gain for the Master Device is 3.8 dBi.

The rated output power of the Master unit is > 23dBm (EIRP). Therefore, the required interference threshold level is -64 dBm. After correction for procedural adjustments, the required radiated threshold at the antenna port is  $-64 + 1 = -63$  dBm.

The calibrated radiated DFS Detection Threshold level is set to -64 dBm. The tested level is lower than the required level hence it provides a margin to the limit.

The software installed in the access point is 3.0.0.4.386.42489.



## 7.2. RESULTS FOR 20 MHz BANDWIDTH

### 7.2.1. TEST CHANNEL

All tests were performed at a channel center frequency of 5500 MHz.

### 7.2.2. RADAR WAVEFORM AND TRAFFIC

#### RADAR WAVEFORM

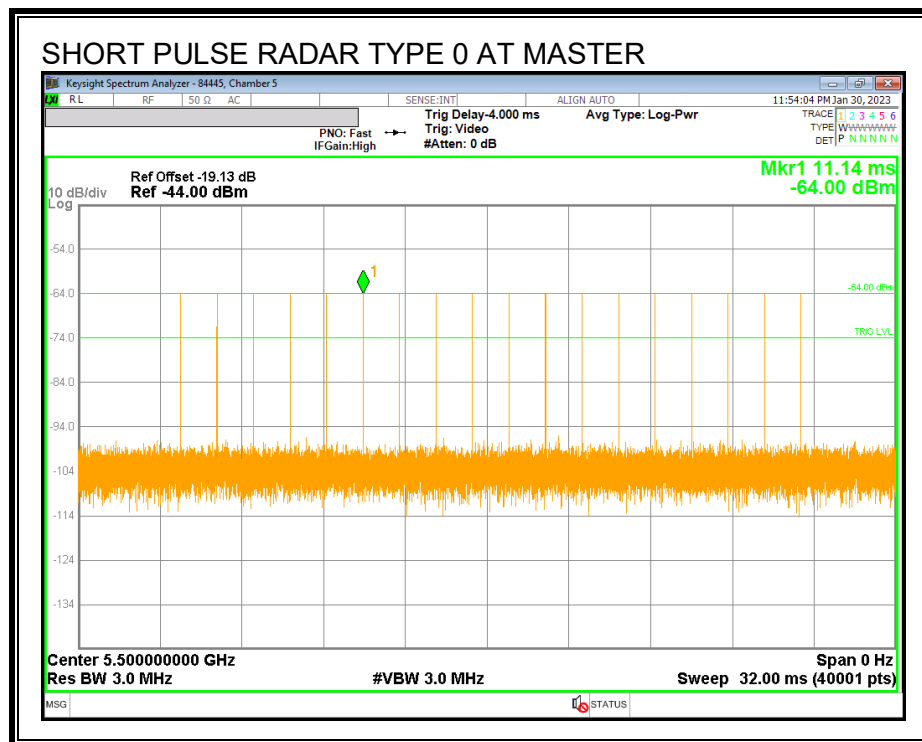

**TRAFFIC**

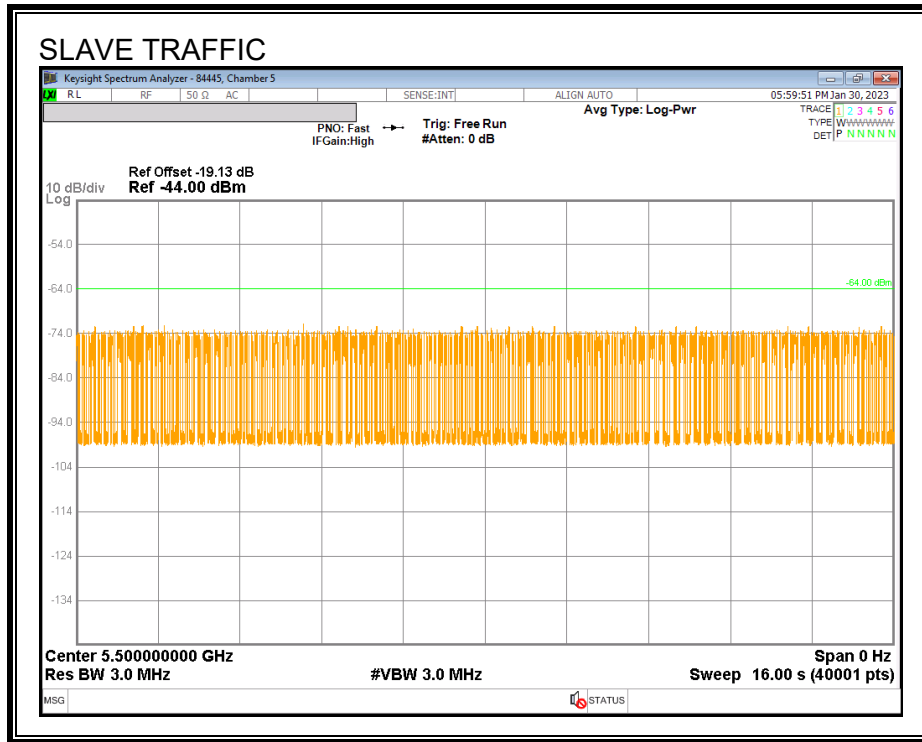

**CHANNEL LOADING**

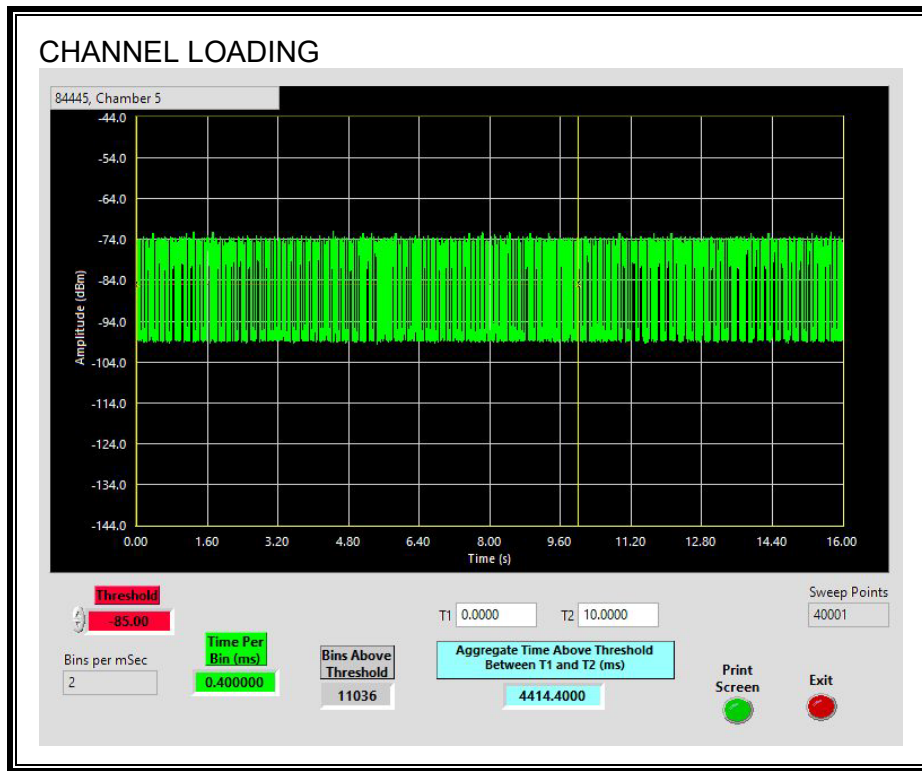

The level of traffic loading on the channel by the EUT is 44.1%

### 7.2.3. OVERLAPPING CHANNEL TESTS

#### RESULTS

These tests are not applicable.

### 7.2.4. MOVE AND CLOSING TIME

#### REPORTING NOTES

The reference marker is set at the end of last radar pulse.

The delta marker is set at the end of the last WLAN transmission following the radar pulse. This delta is the channel move time.

The aggregate channel closing transmission time is calculated as follows:

Aggregate Transmission Time =  
(Number of analyzer bins showing transmission) \* (dwell time per bin)

The observation period over which the aggregate time is calculated begins at (Reference Marker + 200 msec) and ends no earlier than (Reference Marker + 10 sec).

#### RESULTS

Channel Move Time (sec)	Limit (sec)
0.068	10

Aggregate Channel Closing Transmission Time (msec)	Limit (msec)
0	60

**MOVE TIME**

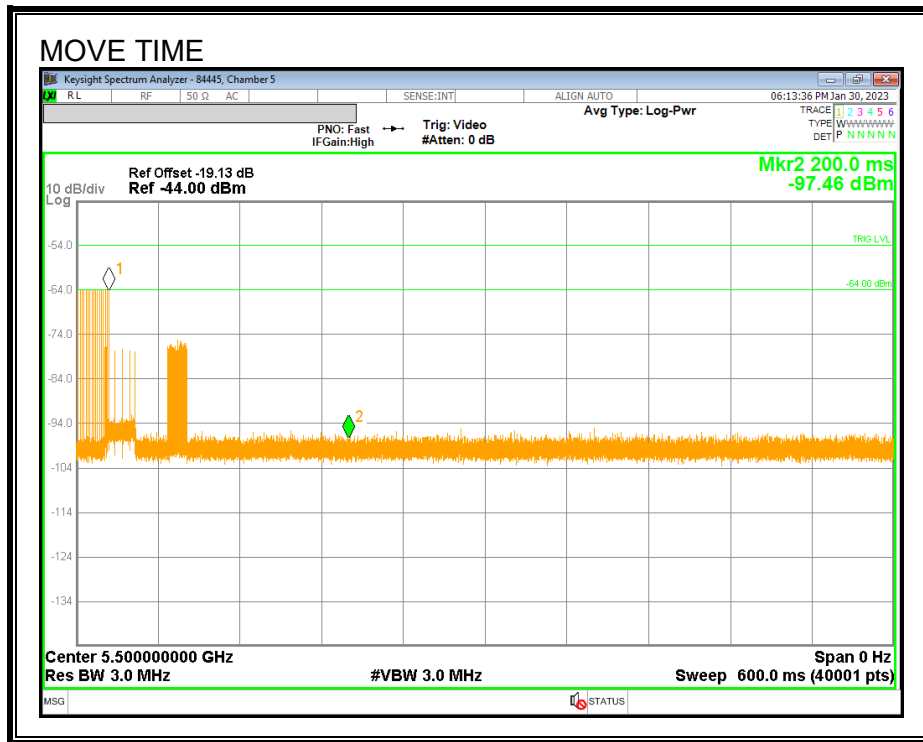

**CHANNEL CLOSING TIME**

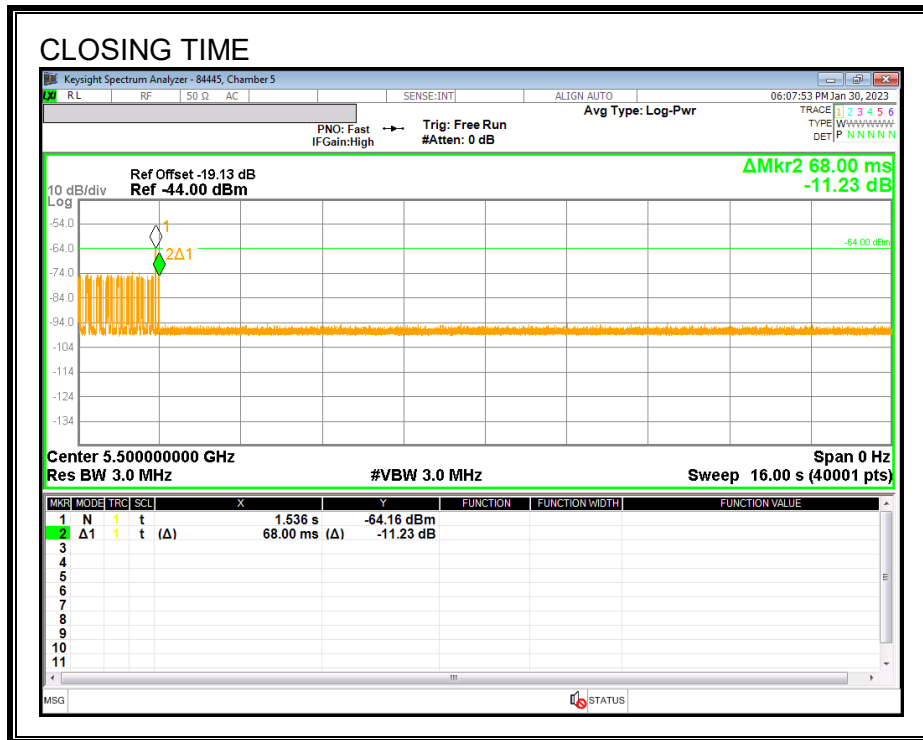

**AGGREGATE CHANNEL CLOSING TRANSMISSION TIME**

No transmissions are observed during the aggregate monitoring period.

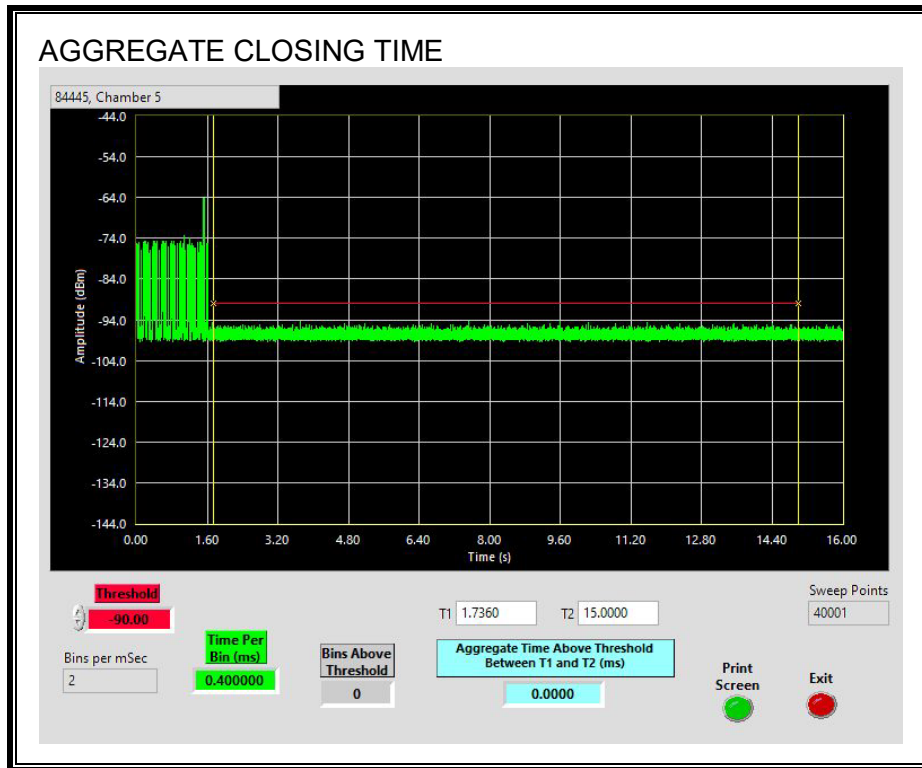

### 7.3. RESULTS FOR 40 MHz BANDWIDTH

#### 7.3.1. TEST CHANNEL

All tests were performed at a channel center frequency of 5510 MHz.

#### 7.3.2. RADAR WAVEFORM AND TRAFFIC

##### RADAR WAVEFORM

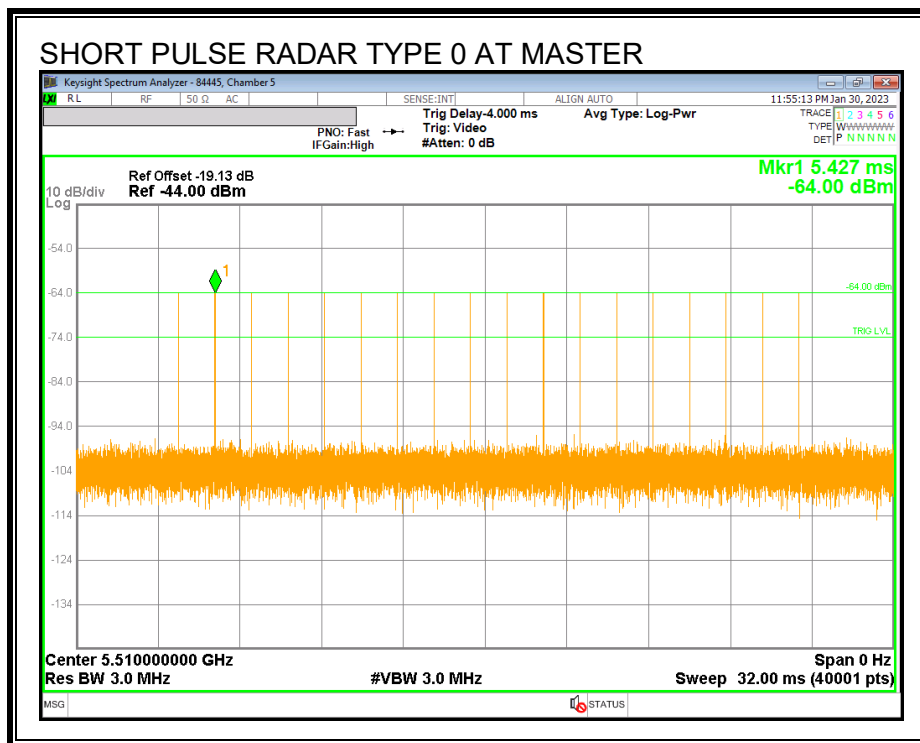



**TRAFFIC**

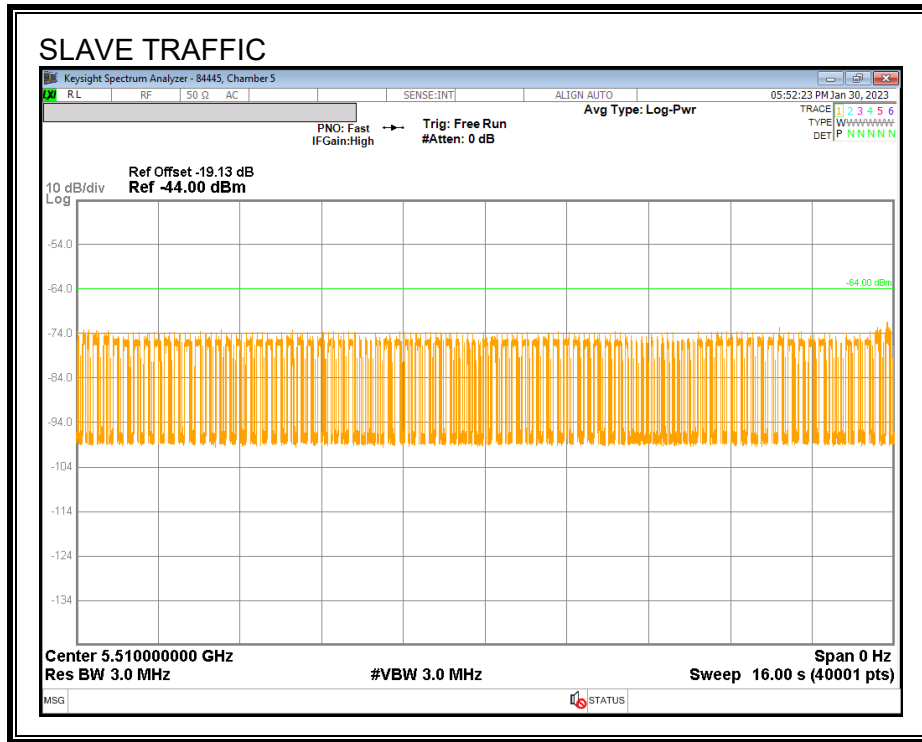

**CHANNEL LOADING**

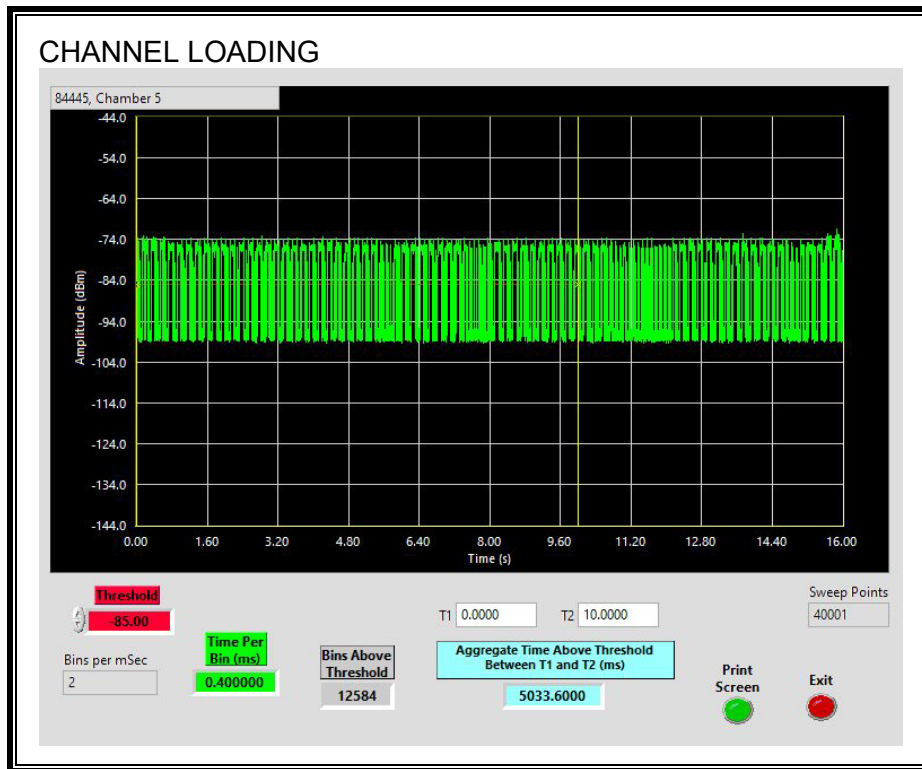

The level of traffic loading on the channel by the EUT is 50.3%

### 7.3.3. OVERLAPPING CHANNEL TESTS

#### RESULTS

These tests are not applicable.

### 7.3.4. MOVE AND CLOSING TIME

#### REPORTING NOTES

The reference marker is set at the end of last radar pulse.

The delta marker is set at the end of the last WLAN transmission following the radar pulse. This delta is the channel move time.

The aggregate channel closing transmission time is calculated as follows:

Aggregate Transmission Time =  
(Number of analyzer bins showing transmission) \* (dwell time per bin)

The observation period over which the aggregate time is calculated begins at (Reference Marker + 200 msec) and ends no earlier than (Reference Marker + 10 sec).

#### RESULTS

Channel Move Time (sec)	Limit (sec)
0.16	10

Aggregate Channel Closing Transmission Time (msec)	Limit (msec)
0	60

**MOVE TIME**

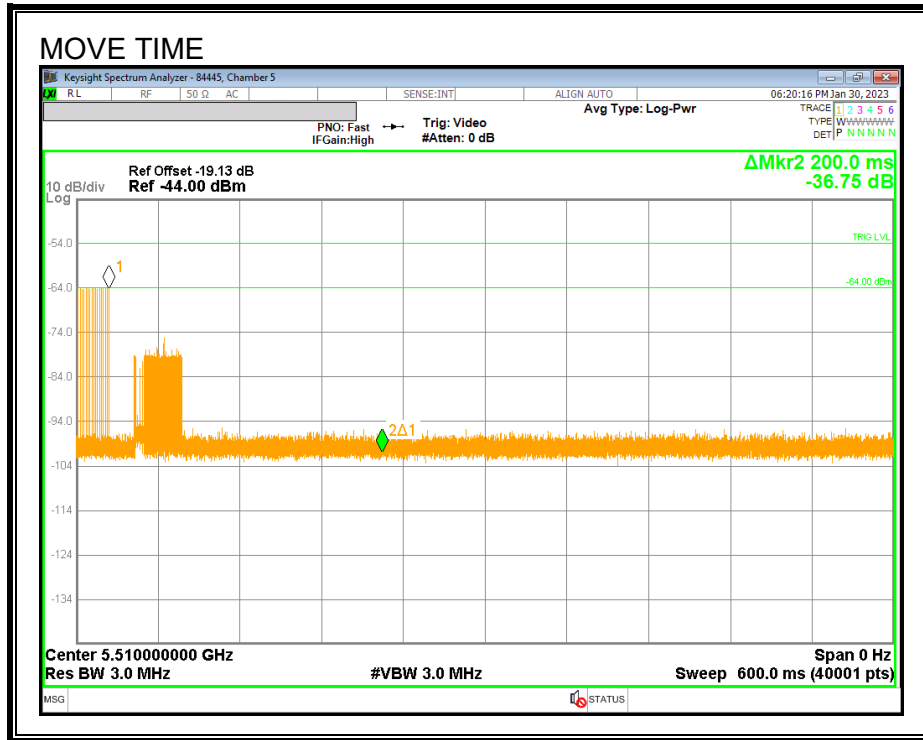

**CHANNEL CLOSING TIME**

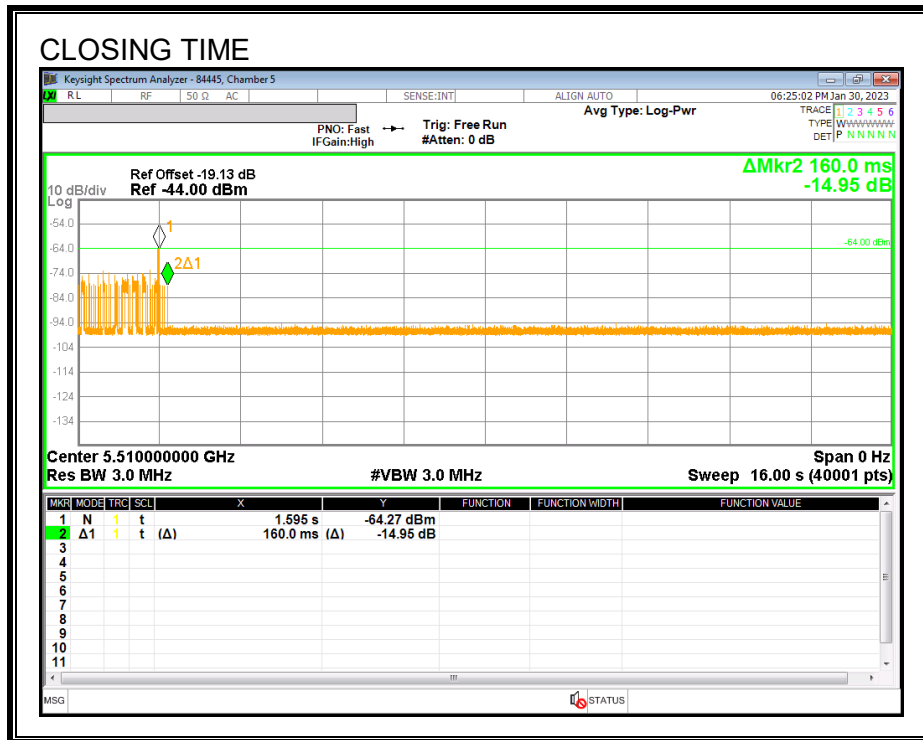

### AGGREGATE CHANNEL CLOSING TRANSMISSION TIME

No transmissions are observed during the aggregate monitoring period.

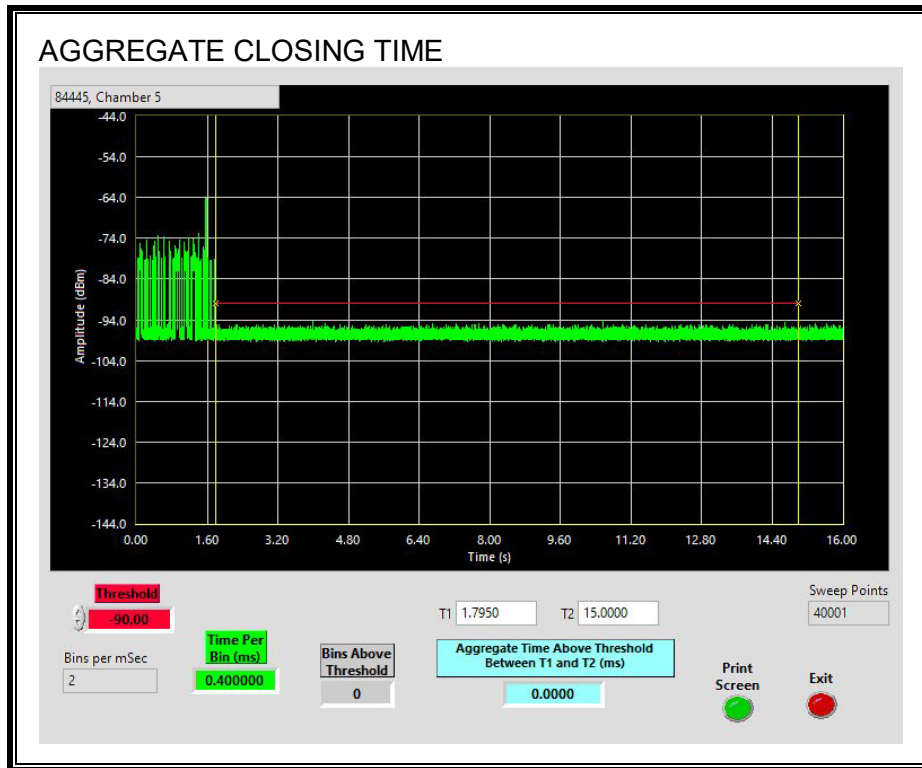

## 7.4. RESULTS FOR 80 MHz BANDWIDTH

### 7.4.1. TEST CHANNEL

All tests were performed at a channel center frequency of 5530 MHz.

### 7.4.2. RADAR WAVEFORM AND TRAFFIC

#### RADAR WAVEFORM

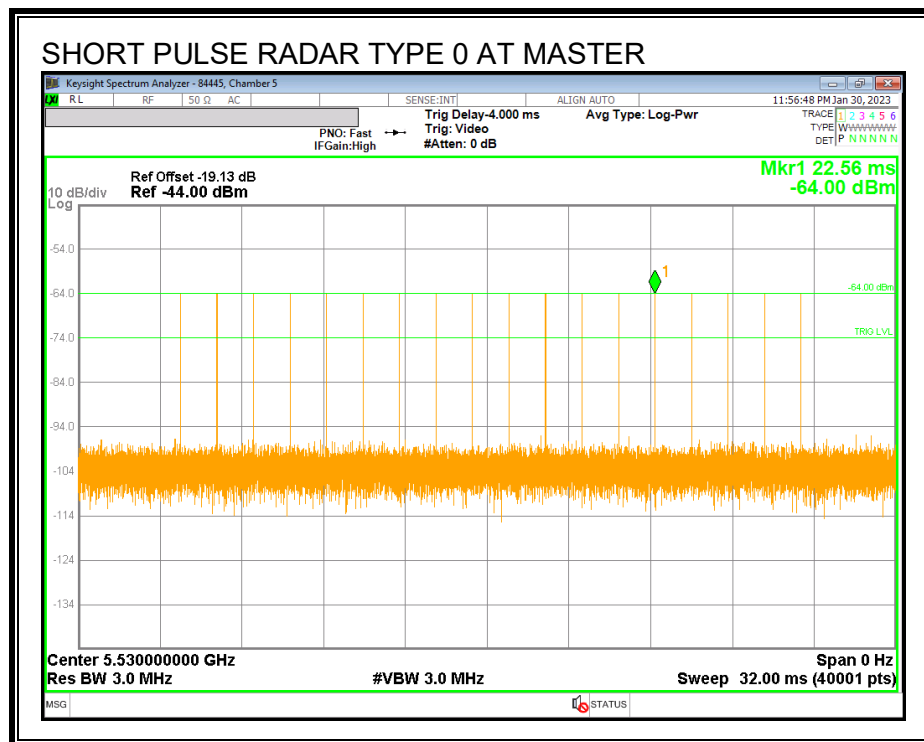

**TRAFFIC**

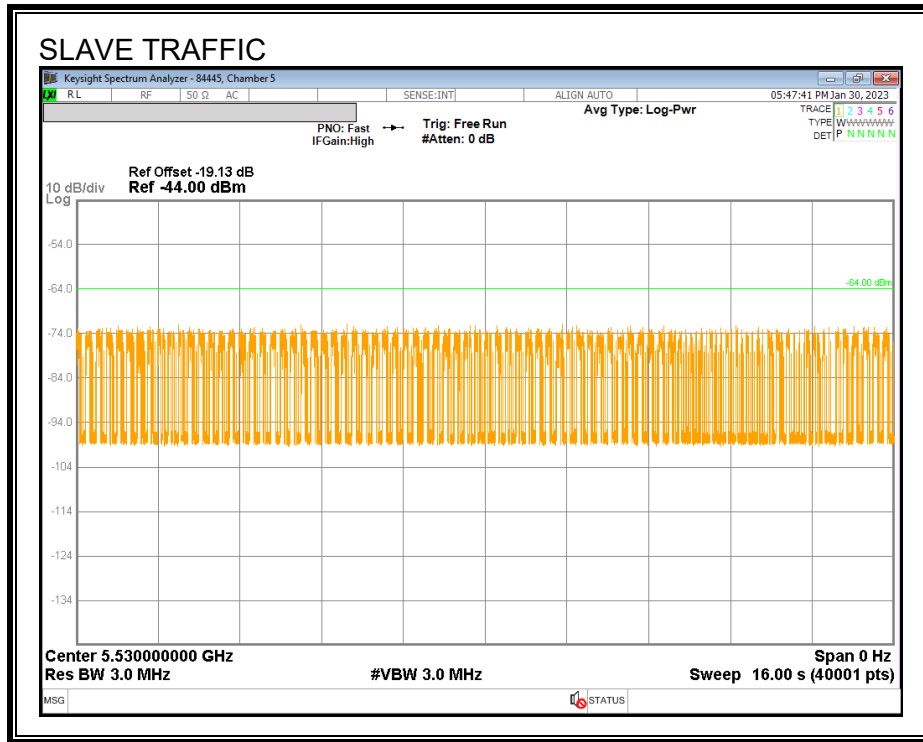



**CHANNEL LOADING**

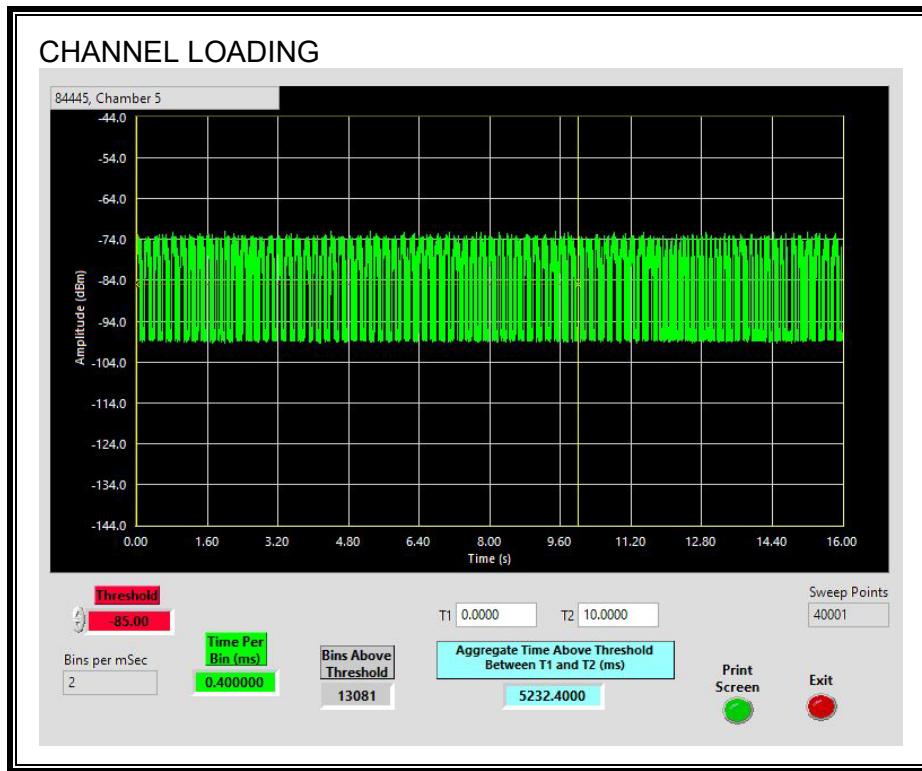

The level of traffic loading on the channel by the EUT is 52.3%

### 7.4.3. OVERLAPPING CHANNEL TESTS

#### RESULTS

These tests are not applicable.

### 7.4.4. MOVE AND CLOSING TIME

#### REPORTING NOTES

The reference marker is set at the end of last radar pulse.

The delta marker is set at the end of the last WLAN transmission following the radar pulse. This delta is the channel move time.

The aggregate channel closing transmission time is calculated as follows:

Aggregate Transmission Time =  
(Number of analyzer bins showing transmission) \* (dwell time per bin)

The observation period over which the aggregate time is calculated begins at (Reference Marker + 200 msec) and ends no earlier than (Reference Marker + 10 sec).

#### RESULTS

Channel Move Time (sec)	Limit (sec)
0	10

Aggregate Channel Closing Transmission Time (msec)	Limit (msec)
0	60

**MOVE TIME**

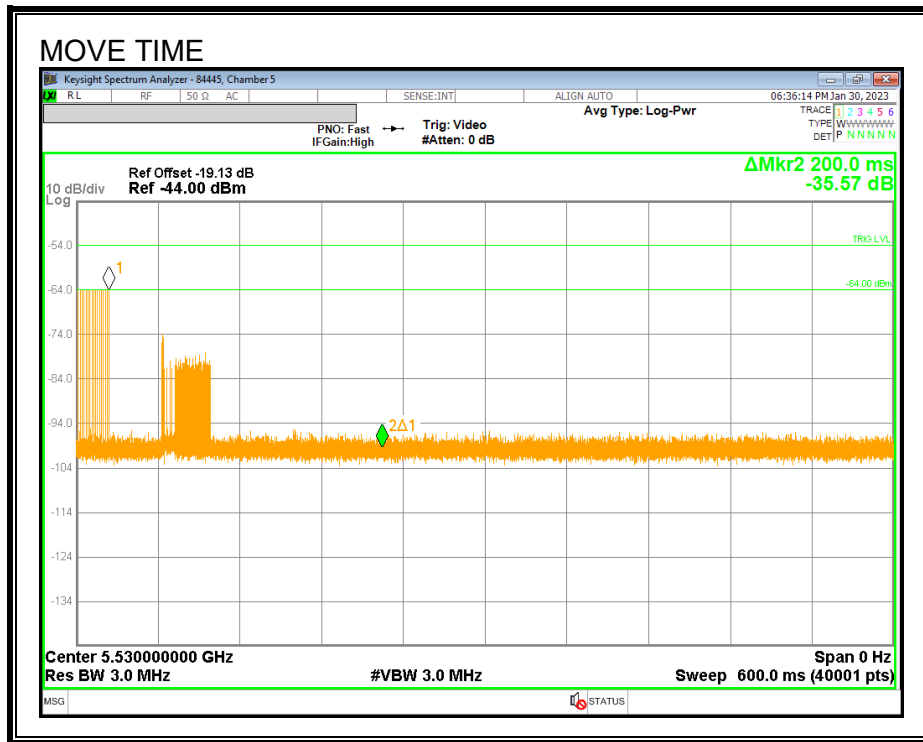

**CHANNEL CLOSING TIME**

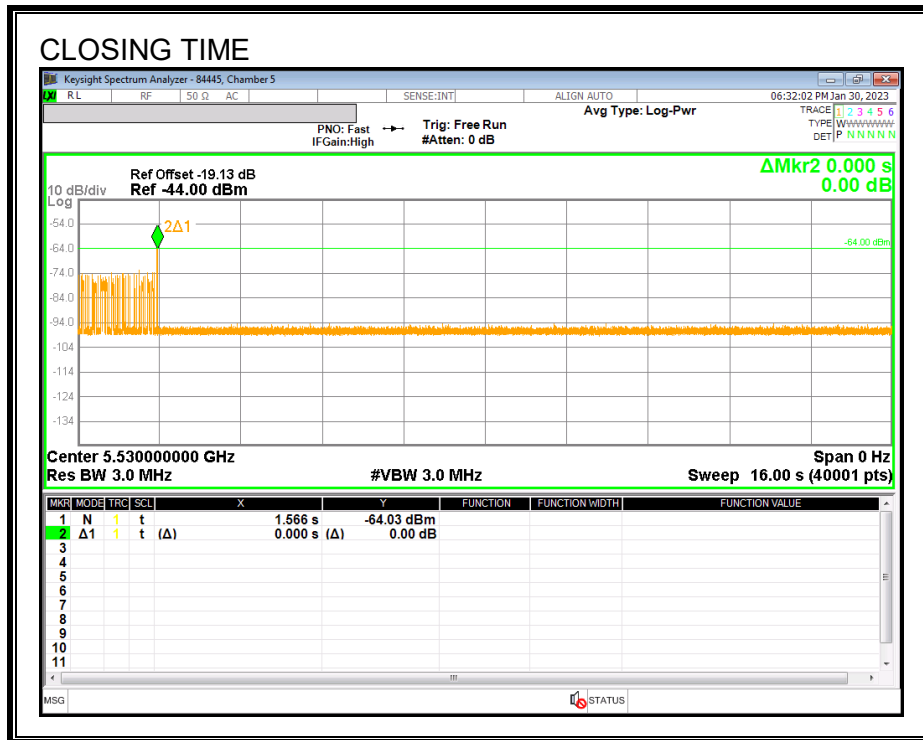

### AGGREGATE CHANNEL CLOSING TRANSMISSION TIME

No transmissions are observed during the aggregate monitoring period.

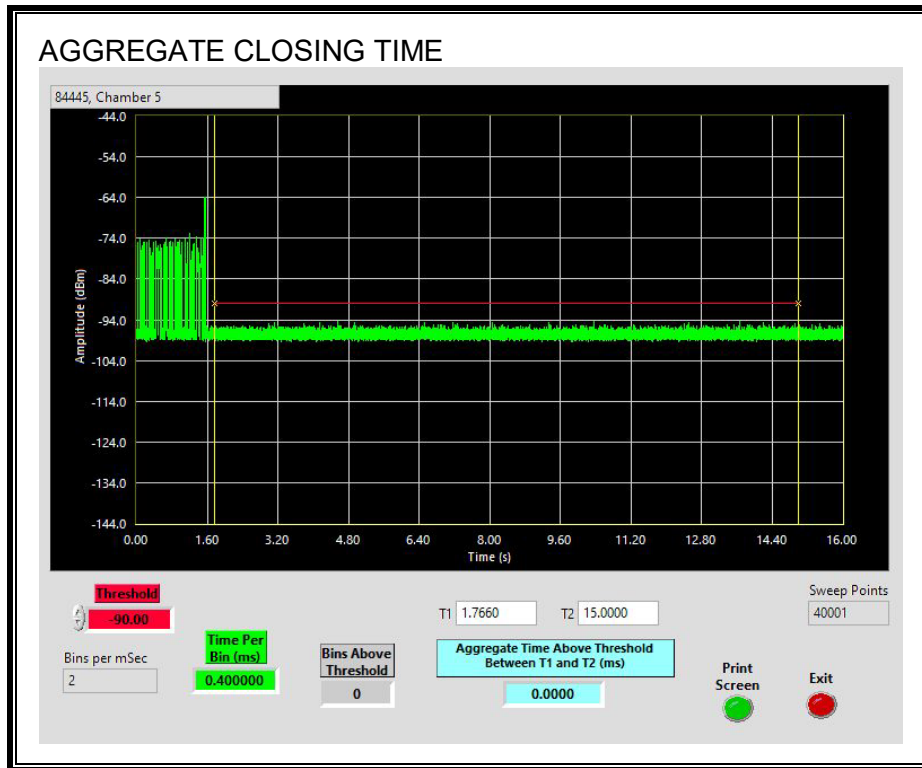

## 7.5. RESULTS FOR 160 MHz BANDWIDTH

### 7.5.1. TEST CHANNEL

All tests were performed at a channel center frequency of 5570 MHz.

### 7.5.2. RADAR WAVEFORM AND TRAFFIC

#### RADAR WAVEFORM

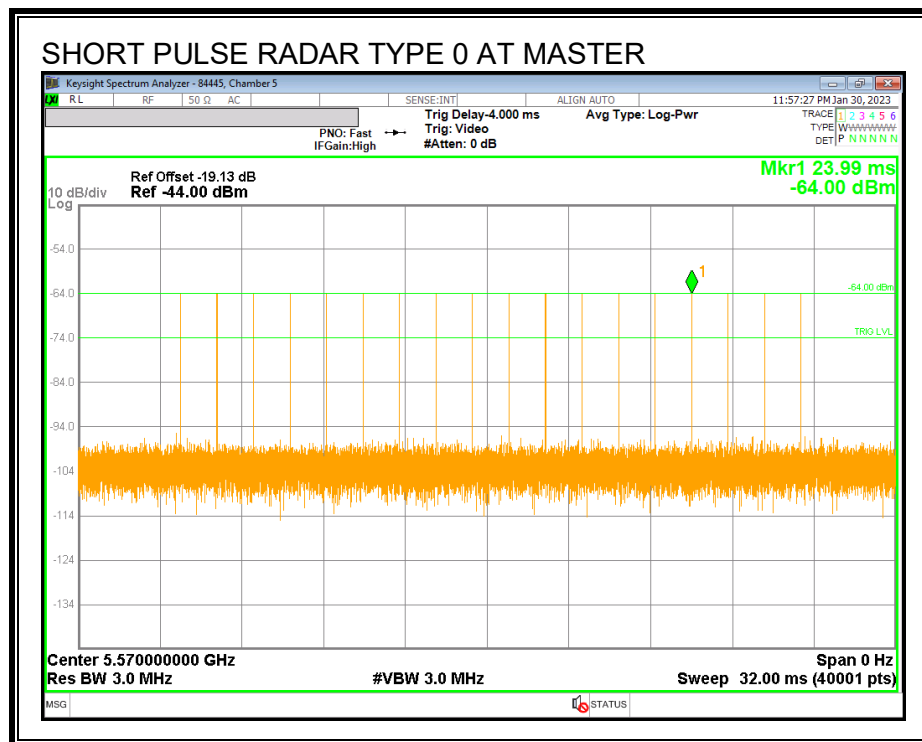

**TRAFFIC**

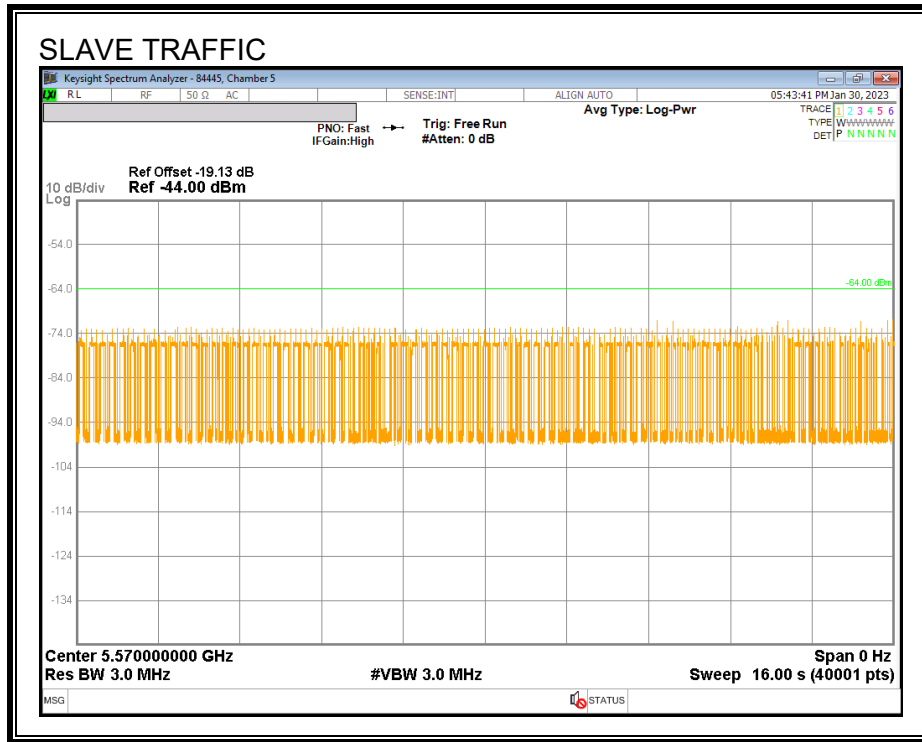

**CHANNEL LOADING**

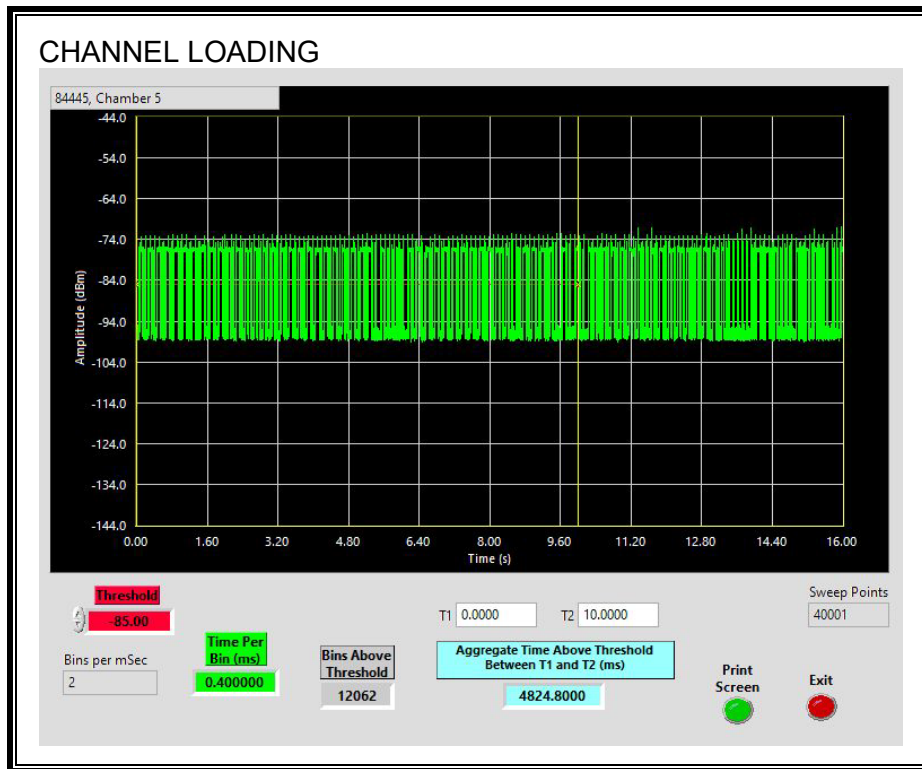

The level of traffic loading on the channel by the EUT is 48.3%



### 7.5.3. OVERLAPPING CHANNEL TESTS

#### RESULTS

These tests are not applicable.

### 7.5.4. MOVE AND CLOSING TIME

#### REPORTING NOTES

The reference marker is set at the end of last radar pulse.

The delta marker is set at the end of the last WLAN transmission following the radar pulse. This delta is the channel move time.

The aggregate channel closing transmission time is calculated as follows:

Aggregate Transmission Time =  
(Number of analyzer bins showing transmission) \* (dwell time per bin)

The observation period over which the aggregate time is calculated begins at (Reference Marker + 200 msec) and ends no earlier than (Reference Marker + 10 sec).

#### RESULTS

Channel Move Time (sec)	Limit (sec)
0.0896	10

Aggregate Channel Closing Transmission Time (msec)	Limit (msec)
0	60

**MOVE TIME**

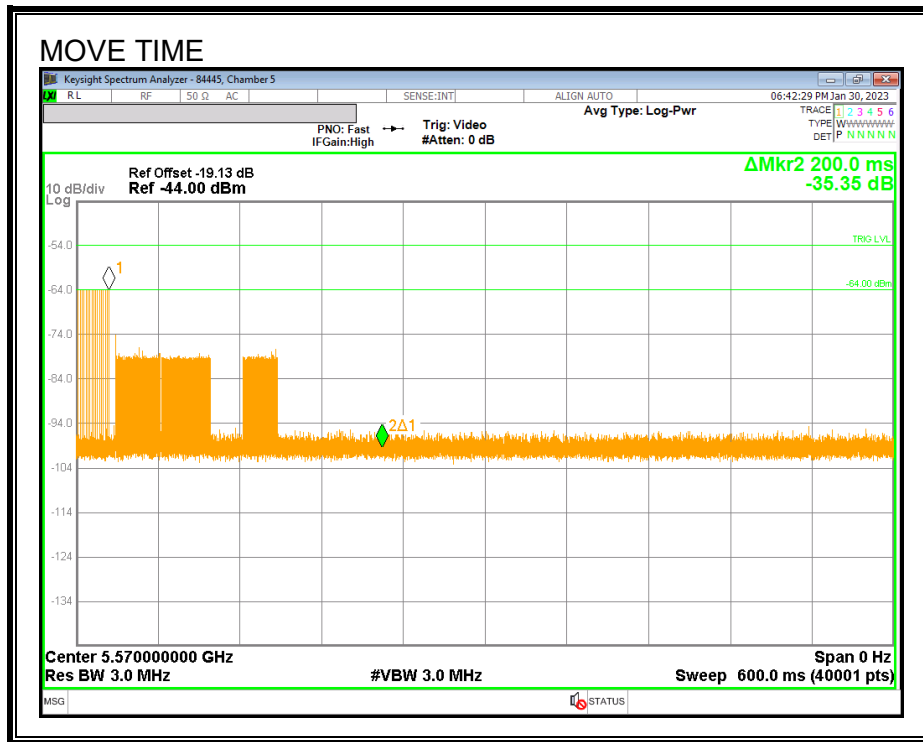

**CHANNEL CLOSING TIME**

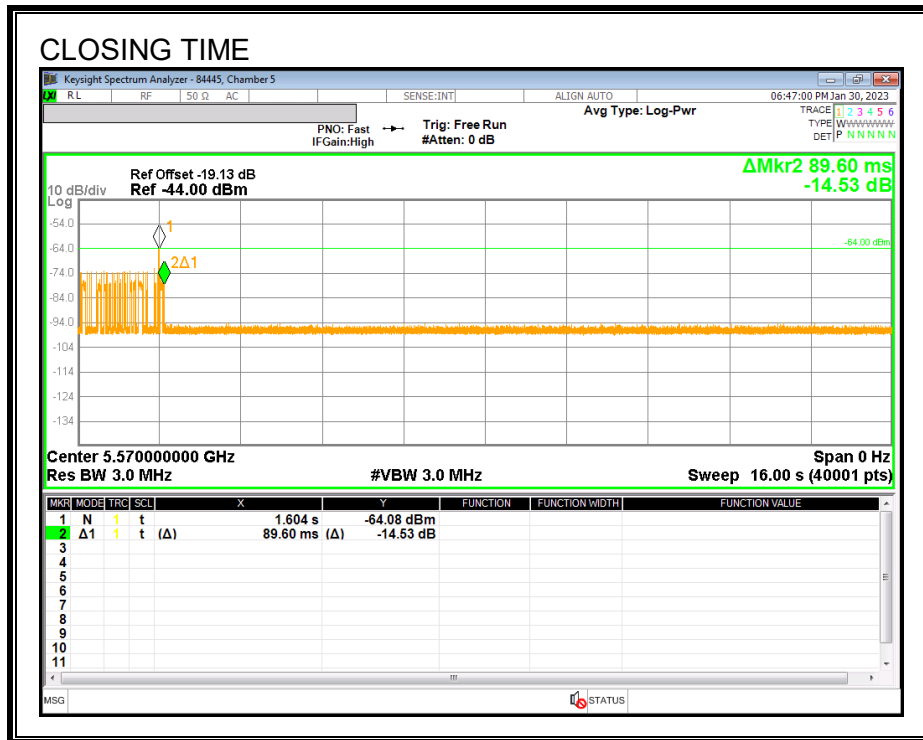

**AGGREGATE CHANNEL CLOSING TRANSMISSION TIME**

No transmissions are observed during the aggregate monitoring period.

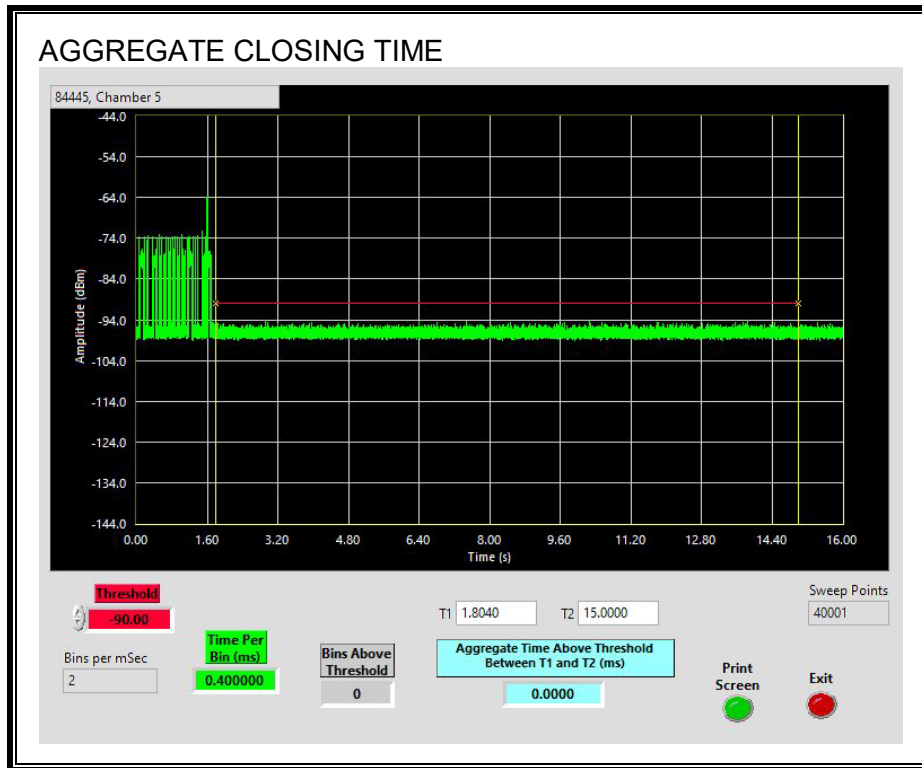

### 7.5.5. NON-OCCUPANCY PERIOD

#### RESULTS

No EUT transmissions were observed on the test channel during the 30-minute observation time.

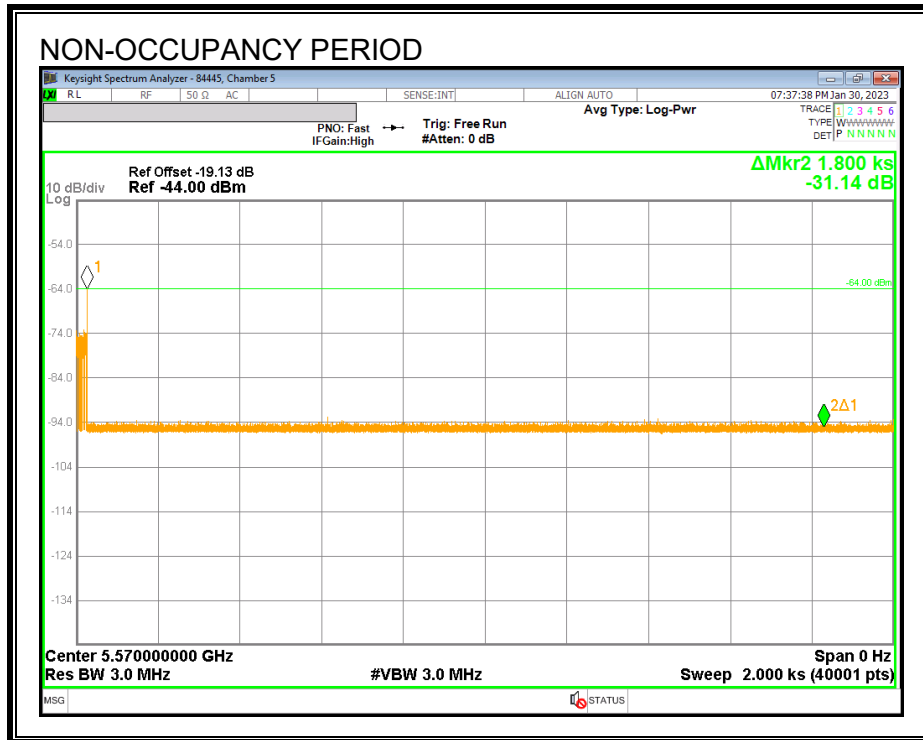

## 8. SETUP PHOTOS

Please refer to R14634918-EP5 for setup photos

**END OF TEST REPORT**