



# FCC RADIO TEST REPORT

**FCC ID** : PY7-04605Z  
**Equipment** : GSM/WCDMA/LTE Phone+Bluetooth,  
DTS/UNII a/b/g/n/ac and NFC  
**Brand Name** : Sony  
**Applicant** : Sony Mobile Communications Inc.  
4-12-3 Higashi-Shinagawa, Shinagawa-ku,  
Tokyo, 140-0002, Japan  
**Manufacturer** : Sony Mobile Communications Inc.  
4-12-3 Higashi-Shinagawa, Shinagawa-ku,  
Tokyo, 140-0002, Japan  
**Standard** : FCC Part 15 Subpart C §15.247

The product was received on Feb. 11, 2019 and testing was started from Apr. 12, 2019 and completed on Apr. 17, 2019. We, SPORTON INTERNATIONAL INC. EMC & Wireless Communications Laboratory, would like to declare that the tested sample has been evaluated in accordance with the test procedures and has been in compliance with the applicable technical standards.

The report must not be used by the client to claim product certification, approval, or endorsement by TAF or any agency of government.

The test results in this spot check data report apply exclusively to the tested model / sample. Without written approval of SPORTON INTERNATIONAL INC. EMC & Wireless Communications Laboratory, the test report shall not be reproduced except in full.

Approved by: Jones Tsai

**SPORTON INTERNATIONAL INC. EMC & Wireless Communications Laboratory**  
No. 52, Huaya 1st Rd., Guishan Dist., Taoyuan City, Taiwan (R.O.C.)



# Table of Contents

**History of this test report..... 3**

**Summary of Test Result..... 4**

**1 General Description ..... 5**

    1.1 Product Feature of Equipment Under Test..... 5

    1.2 Modification of EUT ..... 5

    1.3 Testing Location ..... 6

    1.4 Applicable Standards..... 6

**2 Test Configuration of Equipment Under Test ..... 7**

    2.1 Carrier Frequency and Channel ..... 7

    2.2 Test Mode..... 7

    2.3 Connection Diagram of Test System..... 8

    2.4 EUT Operation Test Setup ..... 8

**3 Test Result ..... 9**

    3.1 Output Power Measurement..... 9

    3.2 Radiated Band Edges and Spurious Emission Measurement ..... 10

    3.3 Antenna Requirements..... 14

**4 List of Measuring Equipment..... 15**

**5 Uncertainty of Evaluation..... 17**

**Appendix A. Conducted Test Results**

**Appendix B. Radiated Spurious Emission**

**Appendix C. Radiated Spurious Emission Plots**

**Appendix D. Duty Cycle Plots**



### History of this test report

Report No.	Version	Description	Issued Date
FR921116-01C	01	Initial issue of report	Apr. 22, 2019
FR921116-01C	02	Revising the standard and antenna gina.	May 13, 2019
FR921116-01C	03	Add the description of accessing spot check test plan in Summary of Test Result.	May 17, 2019
FR921116-01C	04	Add the remark description.	May 20, 2019
FR921116-01C	05	Revising the remark description.	May 21, 2019



### Summary of Test Result

Report Clause	Ref Std. Clause	Test Items	Result (PASS/FAIL)	Remark
-	15.247(a)(2)	6dB Bandwidth	Not Required	-
-	2.1049	99% Occupied Bandwidth	Not Required	-
3.1	15.247(b)	Power Output Measurement	Pass	-
-	15.247(e)	Power Spectral Density	Not Required	-
-	15.247(d)	Conducted Band Edges	Not Required	-
		Conducted Spurious Emission	Not Required	-
3.2	15.247(d)	Radiated Band Edges and Radiated Spurious Emission	Pass	Under limit 4.88 dB at 2484.240 MHz
-	15.207	AC Conducted Emission	Not Required	-
3.3	15.203 & 15.247(b)	Antenna Requirement	Pass	-

**Remark:**

1. Not required means after assessing, test items are not necessary to carry out.
2. This is a spot check data report. All the test cases were performed on original report which can be referred to Sporton Report Number FR8O2416-02C.
3. The spot-check data performed in this report are chosen from the worst case of the original FCC ID report and the spot-check data summary is included in the another spot check data report.

**Declaration of Conformity:**

The test results with all measurement uncertainty excluded are presented in accordance with the regulation limits or requirements declared by manufacturers.

**Comments and Explanations:**

The declared of product specification for EUT presented in the report are provided by the manufacturer, and the manufacturer takes all the responsibilities for the accuracy of product specification.

**Reviewed by: Wii Chang**

**Report Producer: Natasha Hsieh**



# 1 General Description

## 1.1 Product Feature of Equipment Under Test

GSM/WCDMA/LTE, Bluetooth, DTS/UNII a/b/g/n/ac, NFC, and GNSS.

Standards-related Product Specification	
Antenna Type / Gain	Monopole Antenna with gain -4.70 dBi

EUT Information List			
HW Version	SW Version	S/N	Performed Test Item
A	0_30047_A_26_7_ IETS-can_remount	BH92008BGE	RF conducted measurement
		BH92003PGE	Radiated Spurious Emission

Accessory List	
AC Adapter	Model Name : UCH20
	S/N: 3515W45302521
Earphone 1	Model Name.: STH40D
	S/N : N/A
USB Cable	Model Name.: UCB20
	S/N : N/A

**Note:**

1. Above EUT list used are electrically identical per declared by manufacturer.
2. Above the accessories list are used to exercise the EUT during test, and the serial number of each type of accessories is listed in each section of this report. .
3. For other wireless features of this EUT, test report will be issued separately.

## 1.2 Modification of EUT

No modifications are made to the EUT during all test items.



### 1.3 Testing Location

<b>Test Site</b>	SPORTON INTERNATIONAL INC.
<b>Test Site Location</b>	No.52, Huaya 1st Rd., Guishan Dist., Taoyuan City, Taiwan (R.O.C.) TEL: +886-3-327-3456 FAX: +886-3-328-4978
<b>Test Site No.</b>	<b>Sporton Site No.</b>
	CO05-HY

**Note:** The test site complies with ANSI C63.4 2014 requirement.

<b>Test Site</b>	SPORTON INTERNATIONAL INC.
<b>Test Site Location</b>	No.58, Aly. 75, Ln. 564, Wenhua 3rd, Rd., Guishan Dist., Taoyuan City, Taiwan (R.O.C.) TEL: +886-3-327-0868 FAX: +886-3-327-0855
<b>Test Site No.</b>	<b>Sporton Site No.</b>
	03CH16-HY

**Note:** The test site complies with ANSI C63.4 2014 requirement.

FCC Designation No.: TW1190 and TW0007

### 1.4 Applicable Standards

According to the specifications of the manufacturer, the EUT must comply with the requirements of the following standards:

- ♦ FCC Part 15 Subpart C §15.247
- ♦ FCC KDB Publication No. 558074 D01 DTS Meas. Guidance v05r02
- ♦ FCC KDB 414788 D01 Radiated Test Site v01r01.
- ♦ FCC KDB 662911 D01 Multiple Transmitter Output v02r01.
- ♦ ANSI C63.10-2013

**Remark:**

1. All test items were verified and recorded according to the standards and without any deviation during the test.
2. This EUT has also been tested and complied with the requirements of FCC Part 15, Subpart B, recorded in a separate test report.
3. KDB 558074 D01 v05 is updated to KDB 558074 D01 v05r02 and we confirmed that the original parent model's test report is still valid as the change does not affect the test.



## 2 Test Configuration of Equipment Under Test

- a. The EUT has been associated with peripherals and configuration operated in a manner tended to maximize its emission characteristics in a typical application. Frequency range investigated: radiation emission (9 kHz to the 10th harmonic of the highest fundamental frequency or to 40 GHz, whichever is lower). For radiated measurement, pre-scanned in three orthogonal panels, X, Y, Z. The worst cases (Y plane) were recorded in this report.

### 2.1 Carrier Frequency and Channel

Frequency Band	Channel	Freq. (MHz)	Channel	Freq. (MHz)
2400-2483.5 MHz	1	2412	8	2447
	2	2417	9	2452
	3	2422	10	2457
	4	2427	11	2462
	5	2432	12	2467
	6	2437	13	2472
	7	2442		

### 2.2 Test Mode

Final test modes are considering the modulation and worse data rates as below table.

Modulation	Data Rate
802.11b	1 Mbps
802.11n HT20	MCS0

## 2.3 Connection Diagram of Test System

<WLAN Tx Mode>

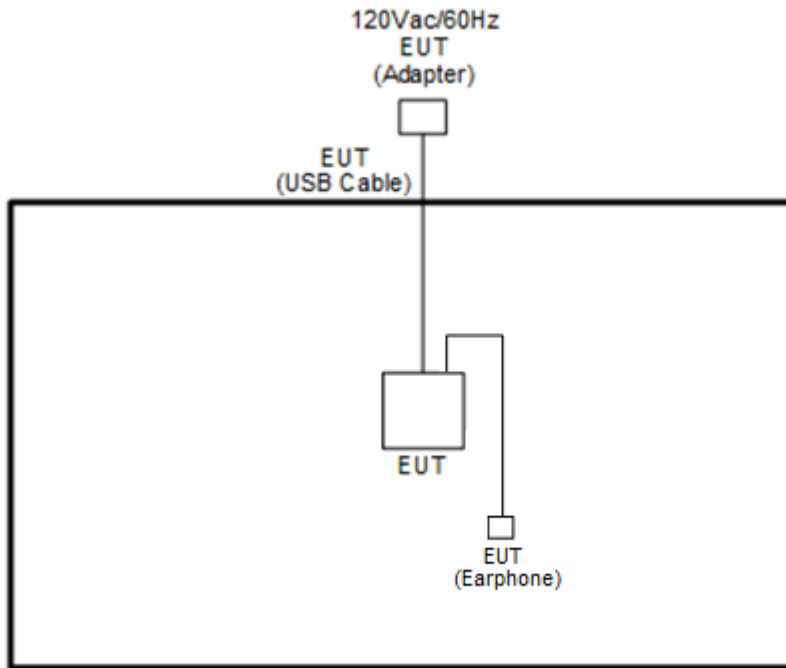

## 2.4 EUT Operation Test Setup

The RF test items, utility “Tera Term” was installed in Notebook which was programmed in order to make the EUT get into the engineering modes to provide channel selection, power level, data rate and the application type and for continuous transmitting signals.



### 3 Test Result

#### 3.1 Output Power Measurement

##### 3.1.1 Limit of Output Power

For systems using digital modulation in the 2400-2483.5MHz, the limit for peak output power is 30dBm. If transmitting antenna with directional gain greater than 6dBi is used, the peak output power from the intentional radiator shall be reduced below the above stated value by the amount in dB that the directional gain of the antenna exceeds 6 dBi. In case of point-to-point operation, the limit has to be reduced by 1dB for every 3dB that the directional gain of the antenna exceeds 6dBi.

##### 3.1.2 Measuring Instruments

See list of measuring equipment of this test report.

##### 3.1.3 Test Procedures

1. For Average Power, the testing follows ANSI C63.10 Section 11.9.2.3.2 Method AVGPM-G.
2. The RF output of EUT was connected to the power meter by RF cable and attenuator. The path loss was compensated to the results for each measurement.
3. Set to the maximum power setting and enable the EUT transmit continuously.
4. Measure the conducted output power and record the results in the test report.

##### 3.1.4 Test Setup

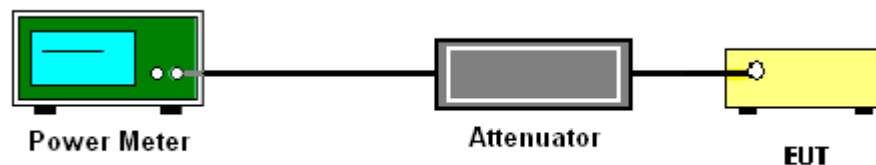

##### 3.1.5 Test Result of Average output Power

Please refer to Appendix A.



### 3.2 Radiated Band Edges and Spurious Emission Measurement

#### 3.2.1 Limit of Radiated band edge and Spurious Emission Measurement

In any 100 kHz bandwidth outside the intentional radiator frequency band, all harmonics/spurious must be at least 20 dB below the highest emission level within the authorized band. If the output power of this device was measured by spectrum analyzer, the attenuation under this paragraph shall be 30 dB instead of 20 dB. In addition, radiated emissions which fall in the restricted bands must also comply with the limits as below.

Frequency (MHz)	Field Strength (microvolts/meter)	Measurement Distance (meters)
0.009 – 0.490	2400/F(kHz)	300
0.490 – 1.705	24000/F(kHz)	30
1.705 – 30.0	30	30
30 – 88	100	3
88 – 216	150	3
216 - 960	200	3
Above 960	500	3

#### 3.2.2 Measuring Instruments

See list of measuring equipment of this test report.



### 3.2.3 Test Procedures

1. The testing follows the ANSI C63.10 Section 11.12.1 Radiated emission measurements.
2. The EUT was arranged to its worst case and then tune the antenna tower (from 1 m to 4 m) and turntable (from 0 degree to 360 degrees) to find the maximum reading. A pre-amp and a high pass filter are used for the test in order to get better signal level.
3. The EUT was placed on a turntable with 0.8 meter for frequency below 1GHz and 1.5 meter for frequency above 1GHz respectively above ground.
4. The EUT was set 3 meters from the interference receiving antenna, which was mounted on the top of a variable height antenna tower.
5. Corrected Reading: Antenna Factor + Cable Loss + Read Level - Preamp Factor = Level
6. For testing below 1GHz, if the emission level of the EUT in peak mode was 3 dB lower than the limit specified, then peak values of EUT will be reported, otherwise, the emissions will be repeated one by one using the CISPR quasi-peak method and reported.
7. For testing above 1GHz, the emission level of the EUT in peak mode was 20dB lower than average limit (that means the emission level in average mode also complies with the limit in average mode), then peak values of EUT will be reported, otherwise, the emissions will be measured in average mode again and reported.
8. Use the following spectrum analyzer settings:
  - (1) Span shall wide enough to fully capture the emission being measured;
  - (2) Set RBW=100 kHz for  $f < 1$  GHz; VBW  $\geq$  RBW; Sweep = auto; Detector function = peak; Trace = max hold;
  - (3) Set RBW = 1 MHz, VBW= 3MHz for  $f \geq 1$  GHz for peak measurement.  
For average measurement:
    - VBW = 10 Hz, when duty cycle is no less than 98 percent.
    - VBW  $\geq 1/T$ , when duty cycle is less than 98 percent where T is the minimum transmission duration over which the transmitter is on and is transmitting at its maximum power control level for the tested mode of operation.

### 3.2.4 Test Setup

For radiated emissions below 30MHz

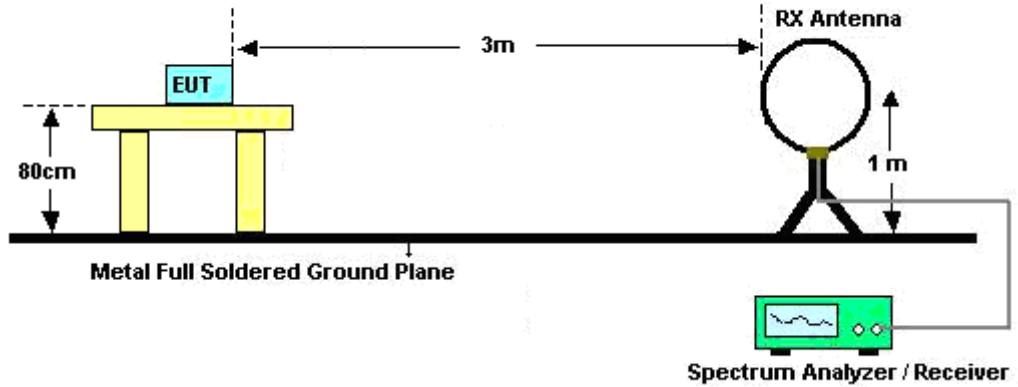

For radiated emissions from 30MHz to 1GHz

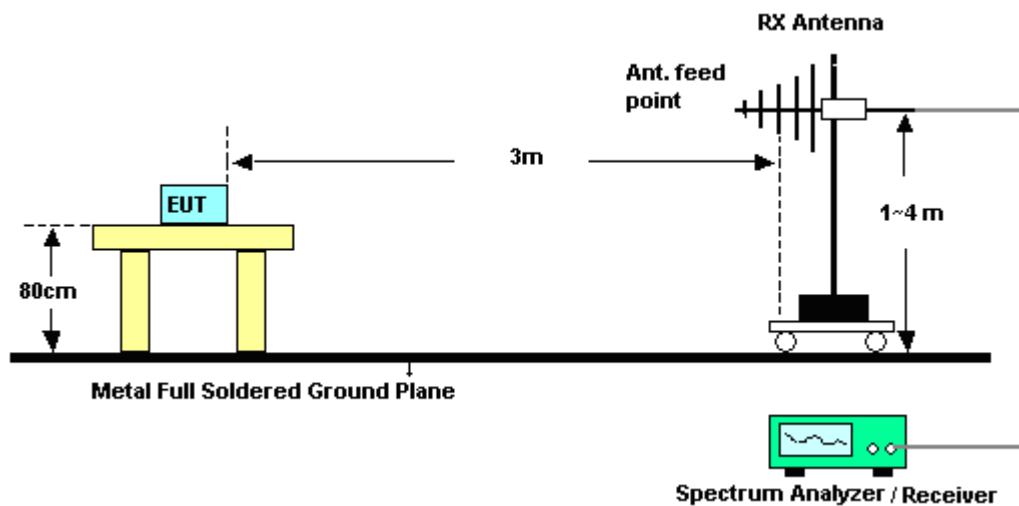

For radiated emissions above 1GHz

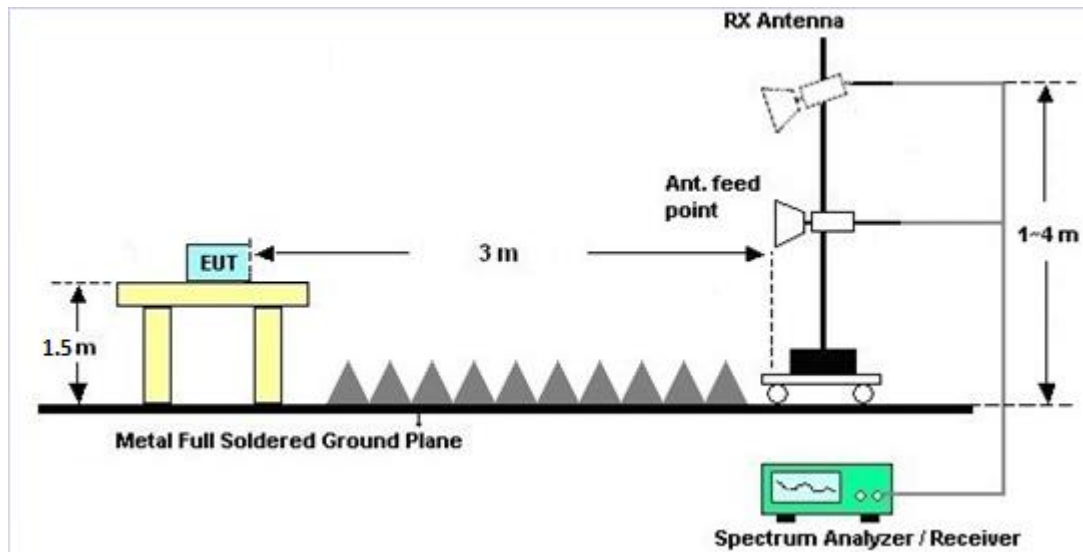

### 3.2.5 Test Results of Radiated Spurious Emissions (9kHz ~ 30MHz)

The low frequency, which started from 9 kHz to 30MHz, was pre-scanned and the result which was 20dB lower than the limit line was not reported.

There is a comparison data of both open-field test site and alternative test site - semi-Anechoic chamber according to 414788 D01 Radiated Test Site v01r01, and the result came out very similar.

### 3.2.6 Test Result of Radiated Spurious at Band Edges

Please refer to Appendix B and C.

### 3.2.7 Duty Cycle

Please refer to Appendix D.

### 3.2.8 Test Result of Radiated Spurious Emission (30MHz ~ 10<sup>th</sup> Harmonic)

Please refer to Appendix B and C.



### **3.3 Antenna Requirements**

#### **3.3.1 Standard Applicable**

If directional gain of transmitting Antennas is greater than 6dBi, the power shall be reduced by the same level in dB comparing to gain minus 6dBi. The use of a permanently attached Antenna or of an Antenna that uses a unique coupling to the intentional radiator shall be considered sufficient to comply with the rule.

#### **3.3.2 Antenna Anti-Replacement Construction**

An embedded-in antenna design is used.

#### **3.3.3 Antenna Gain**

The antenna peak gain of EUT is less than 6 dBi. Therefore, it is not necessary to reduce maximum peak output power limit.



## 4 List of Measuring Equipment

Instrument	Manufacturer	Model No.	Serial No.	Characteristics	Calibration Date	Test Date	Due Date	Remark
Hygrometer	Testo	DTM-303A	TP157075	N/A	Mar. 05, 2019	Apr. 12, 2019~ Apr. 15, 2019	Mar. 04, 2020	Conducted (TH05-HY)
Power Meter	Agilent	E4416A	GB41292344	N/A	Dec. 27, 2018	Apr. 12, 2019~ Apr. 15, 2019	Dec. 26, 2019	Conducted (TH05-HY)
Power Sensor	Agilent	E9327A	US40441548	50MHz~18GHz	Dec. 27, 2018	Apr. 12, 2019~ Apr. 15, 2019	Dec. 26, 2019	Conducted (TH05-HY)
Switch Box & RF Cable	Burgeon	ETF-058	EC1300484	N/A	Apr. 17, 2018	Apr. 12, 2019~ Apr. 15, 2019	Apr. 16, 2019	Conducted (TH05-HY)
Programmable Power Supply	GW Instek	PSS-2005	EL890094	1V~20V 0.5A~5A	Oct. 02, 2018	Apr. 12, 2019~ Apr. 15, 2019	Oct. 01, 2019	Conducted (TH05-HY)
Loop Antenna	Rohde & Schwarz	HFH2-Z2	100315	9 kHz~30 MHz	Nov. 23, 2017	Apr. 15, 2019 ~ Apr. 17, 2019	Nov. 22, 2019	Radiation (03CH16-HY)
Bilog Antenna	TESEQ	CBL6111D&00 802N1D01N-0 6	47020&06	30MHz to 1GHz	Oct. 13, 2018	Apr. 15, 2019 ~ Apr. 17, 2019	Oct. 12, 2019	Radiation (03CH16-HY)
Horn Antenna	SCHWARZBE CK	BBHA 9120 D	9120D-1522	1G~18GHz	Sep. 07, 2018	Apr. 15, 2019 ~ Apr. 17, 2019	Sep. 06, 2019	Radiation (03CH16-HY)
SHF-EHF Horn Antenna	SCHWARZBE CK	BBHA 9170	BBHA917057 6	18GHz ~ 40GHz	May 08, 2018	Apr. 15, 2019 ~ Apr. 17, 2019	May 07, 2019	Radiation (03CH16-HY)
Amplifier	SONOMA	310N	371607	9kHz~1000MHz	Oct. 02, 2018	Apr. 15, 2019 ~ Apr. 17, 2019	Oct. 01, 2019	Radiation (03CH16-HY)
Preamplifier	Jet-Power	JPA0118-55-3 03	17100018000 54001	1GHz~18GHz	Apr. 15, 2019	Apr. 15, 2019 ~ Apr. 17, 2019	Apr. 14, 2020	Radiation (03CH16-HY)
Preamplifier	Keysight	83017A	MY53270264	1GHz~26.5GHz	Dec. 12, 2018	Apr. 15, 2019 ~ Apr. 17, 2019	Dec. 11, 2019	Radiation (03CH16-HY)
Amplifier	MITEQ	TTA1840-35-H G	1871923	18GHz~40GHz, VSWR : 2.5:1 max	Jul. 16, 2018	Apr. 15, 2019 ~ Apr. 17, 2019	Jul. 15, 2019	Radiation (03CH16-HY)
Spectrum Analyzer	Agilent	N9010A	MY54200486	10Hz~44GHz	Oct. 19, 2018	Apr. 15, 2019 ~ Apr. 17, 2019	Oct. 18, 2019	Radiation (03CH16-HY)
EMI Test Receiver	Keysight	N9038A (MXE)	MY57290111	3Hz~26.5GHz	Nov. 29, 2018	Apr. 15, 2019 ~ Apr. 17, 2019	Nov. 28, 2019	Radiation (03CH16-HY)
Hygrometer	TECPEL	DTM-303B	TP162965	N/A	Oct. 22, 2018	Apr. 15, 2019 ~ Apr. 17, 2019	Oct. 21, 2019	Radiation (03CH16-HY)
Filter	Wainwright	WLK4-1000-1 530-8000-40S S	SN11	1G Low Pass	Sep. 16, 2018	Apr. 15, 2019 ~ Apr. 17, 2019	Sep. 17, 2019	Radiation (03CH16-HY)
Filter	Wainwright	WHKX12-270 0-3000-18000- 60SS	SN3	2.7G High Pass	Sep. 16, 2018	Apr. 15, 2019 ~ Apr. 17, 2019	Sep. 17, 2019	Radiation (03CH16-HY)
RF Cable	HUBER + SU HNER	SUCOFLEX 1 04	MY9837/4PE	9kHz-30MHz	Mar. 13, 2019	Apr. 15, 2019 ~ Apr. 17, 2019	Mar. 12, 2020	Radiation (03CH16-HY)
RF Cable	HUBER + SUHNER	SUCOFLEX 126E	MY1082/26E A	30M~18GHz	Oct. 16, 2018	Apr. 15, 2019 ~ Apr. 17, 2019	Oct. 15, 2019	Radiation (03CH16-HY)
RF Cable	HUBER + SUHNER	SUCOFLEX 102	505134/2	30M~40GHz	Oct. 16, 2018	Apr. 15, 2019 ~ Apr. 17, 2019	Oct. 15, 2019	Radiation (03CH16-HY)



Instrument	Manufacturer	Model No.	Serial No.	Characteristics	Calibration Date	Test Date	Due Date	Remark
Controller	ChainTek	3000-1	N/A	Control Turn table & Ant. Mast	N/A	Apr. 15, 2019 ~ Apr. 17, 2019	N/A	Radiation (03CH16-HY)
Antenna Mast	ChainTek	MBS-520-1	N/A	1m~4m	N/A	Apr. 15, 2019 ~ Apr. 17, 2019	N/A	Radiation (03CH16-HY)
Turn Table	ChainTek	T-200-S-1	N/A	0~360 Degree	N/A	Apr. 15, 2019 ~ Apr. 17, 2019	N/A	Radiation (03CH16-HY)
Software	Audix	E3 6.2009-8-24	RK-001136	N/A	N/A	Apr. 15, 2019 ~ Apr. 17, 2019	N/A	Radiation (03CH16-HY)





## 5 Uncertainty of Evaluation

### Uncertainty of Radiated Emission Measurement (30 MHz ~ 1000 MHz)

Measuring Uncertainty for a Level of Confidence of 95% ( $U = 2Uc(y)$ )	4.90
---	------

### Uncertainty of Radiated Emission Measurement (1000 MHz ~ 18000 MHz)

Measuring Uncertainty for a Level of Confidence of 95% ( $U = 2Uc(y)$ )	5.80
---	------

### Uncertainty of Radiated Emission Measurement (18000 MHz ~ 40000 MHz)

Measuring Uncertainty for a Level of Confidence of 95% ( $U = 2Uc(y)$ )	3.90
---	------

**Appendix A. Test Result of Conducted Test Items**

Test Engineer:	Luffy Lin	Temperature:	21~25	°C
Test Date:	2019/4/12 ~ 2019/04/15	Relative Humidity:	51~54	%

**TEST RESULTS DATA**  
**Average Output Power**

2.4GHz Band																
Mod.	Data Rate	N <sub>Tx</sub>	CH.	Freq. (MHz)	Average Conducted Power (dBm)			Conducted Power Limit (dBm)		DG (dBi)		EIRP Power (dBm)		EIRP Power Limit (dBm)		Pass /Fail
					Ant 1	Ant 2	SUM	Ant 1	Ant 2	Ant 1	Ant 2	Ant 1	Ant 2	Ant 1	Ant 2	
11b	1Mbps	1	1	2412	14.90	-	-	30.00	-	-4.70	-	10.20	-	36.00	-	Pass
11b	1Mbps	1	6	2437	14.70	-		30.00	-	-4.70	-	10.00	-	36.00	-	Pass
11b	1Mbps	1	11	2462	14.80	-		30.00	-	-4.70	-	10.10	-	36.00	-	Pass
11b	1Mbps	1	12	2467	14.80	-		30.00	-	-4.70	-	10.10	-	36.00	-	Pass
11b	1Mbps	1	13	2472	9.20	-		30.00	-	-4.70	-	4.50	-	36.00	-	Pass
11g	6Mbps	1	1	2412	14.70	-		30.00	-	-4.70	-	10.00	-	36.00	-	Pass
11g	6Mbps	1	6	2437	14.90	-		30.00	-	-4.70	-	10.20	-	36.00	-	Pass
11g	6Mbps	1	11	2462	14.90	-		30.00	-	-4.70	-	10.20	-	36.00	-	Pass
11g	6Mbps	1	12	2467	9.00	-		30.00	-	-4.70	-	4.30	-	36.00	-	Pass
11g	6Mbps	1	13	2472	-4.50	-		30.00	-	-4.70	-	-9.20	-	36.00	-	Pass
HT20	MCS0	1	1	2412	14.90	-		30.00	-	-4.70	-	10.20	-	36.00	-	Pass
HT20	MCS0	1	6	2437	14.80	-		30.00	-	-4.70	-	10.10	-	36.00	-	Pass
HT20	MCS0	1	11	2462	13.90	-		30.00	-	-4.70	-	9.20	-	36.00	-	Pass
HT20	MCS0	1	12	2467	8.70	-		30.00	-	-4.70	-	4.00	-	36.00	-	Pass
HT20	MCS0	1	13	2472	-4.60	-		30.00	-	-4.70	-	-9.30	-	36.00	-	Pass

Note: Measured power (dBm) has offset with cable loss.



## Appendix B. Radiated Spurious Emission

Test Engineer :	Jacky Hung, Austin LI, and CR Liro	Temperature :	23~24 °C
		Relative Humidity :	60~63 %

### 2.4GHz 2400~2483.5MHz

#### WIFI 802.11b (Band Edge @ 3m)

WIFI Ant.	Note	Frequency ( MHz )	Level ( dBμV/m )	Over Limit ( dB )	Limit Line ( dBμV/m )	Read Level ( dBμV )	Antenna Factor ( dB/m )	Path Loss ( dB )	Preamp Factor ( dB )	Ant Pos ( cm )	Table Pos ( deg )	Peak Avg. ( P/A )	Pol. ( H/V )	
802.11b CH 12 2467MHz	*	2467	102.59	-	-	86.87	27.61	18.37	30.26	222	160	P	H	
	*	2467	99.4	-	-	83.68	27.61	18.37	30.26	222	160	A	H	
		2483.56	57.46	-16.54	74	41.67	27.66	18.38	30.25	222	160	P	H	
		2484.24	48.01	-5.99	54	32.22	27.66	18.38	30.25	222	160	A	H	
													H	
														H
	*	2467	104.28	-	-	88.56	27.61	18.37	30.26	173	317	P	V	
	*	2467	101.3	-	-	85.58	27.61	18.37	30.26	173	317	A	V	
		2484.96	59.21	-14.79	74	43.42	27.66	18.38	30.25	173	317	P	V	
		2484.24	49.12	-4.88	54	33.33	27.66	18.38	30.25	173	317	A	V	
														V
														V
Remark	1. No other spurious found. 2. All results are PASS against Peak and Average limit line.													



2.4GHz 2400~2483.5MHz  
WIFI 802.11b (Harmonic @ 3m)

WIFI Ant. 1	Note	Frequency ( MHz )	Level ( dBμV/m )	Over Limit ( dB )	Limit Line ( dBμV/m )	Read Level ( dBμV )	Antenna Factor ( dB/m )	Path Loss ( dB )	Preamp Factor ( dB )	Ant Pos ( cm )	Table Pos ( deg )	Peak Avg. ( P/A )	Pol. ( H/V )	
802.11b CH 12 2467MHz		4934	39.85	-34.15	74	51.21	32.67	14.01	58.04	100	0	P	H	
		7401	42.74	-31.26	74	48.67	37.36	15.16	58.45	100	0	P	H	
													H	
													H	
			4934	40.42	-33.58	74	51.78	32.67	14.01	58.04	100	0	P	V
			7401	41.94	-32.06	74	47.87	37.36	15.16	58.45	100	0	P	V
														V
														V
Remark	1. No other spurious found. 2. All results are PASS against Peak and Average limit line.													



**2.4GHz 2400~2483.5MHz  
WIFI 802.11n HT20 (Band Edge @ 3m)**

WIFI Ant. 1	Note	Frequency ( MHz )	Level ( dBμV/m )	Over Limit ( dB )	Limit Line ( dBμV/m )	Read Level ( dBμV )	Antenna Factor ( dB/m )	Path Loss ( dB )	Preamp Factor ( dB )	Ant Pos ( cm )	Table Pos ( deg )	Peak Avg. ( P/A )	Pol. ( H/V )
802.11n HT20 CH 13 2472MHz	*	2472	86	-	-	70.26	27.63	18.37	30.26	198	153	P	H
	*	2472	77.52	-	-	61.78	27.63	18.37	30.26	198	153	A	H
		2483.64	61.65	-12.35	74	45.86	27.66	18.38	30.25	198	153	P	H
		2483.52	48.59	-5.41	54	32.8	27.66	18.38	30.25	198	153	A	H
													H
													H
	*	2472	87.44	-	-	71.7	27.63	18.37	30.26	174	318	P	V
	*	2472	78.74	-	-	63	27.63	18.37	30.26	174	318	A	V
		2484.16	61.91	-12.09	74	46.12	27.66	18.38	30.25	174	318	P	V
		2483.52	49.01	-4.99	54	33.22	27.66	18.38	30.25	174	318	A	V
												V	
												V	
<b>Remark</b>	1. No other spurious found. 2. All results are PASS against Peak and Average limit line.												



**2.4GHz 2400~2483.5MHz  
WIFI 802.11n HT20 (Harmonic @ 3m)**

WIFI Ant. 1	Note	Frequency ( MHz )	Level ( dBμV/m )	Over Limit ( dB )	Limit Line ( dBμV/m )	Read Level ( dBμV )	Antenna Factor ( dB/m )	Path Loss ( dB )	Preamp Factor ( dB )	Ant Pos ( cm )	Table Pos ( deg )	Peak Avg. (P/A)	Pol. (H/V)	
802.11n HT20 CH 13 2472MHz		4944	40.71	-33.29	74	52.03	32.69	14.03	58.04	100	0	P	H	
		7416	42.98	-31.02	74	48.83	37.38	15.21	58.44	100	0	P	H	
													H	
													H	
			4944	40.04	-33.96	74	51.36	32.69	14.03	58.04	100	0	P	V
			7416	43.18	-30.82	74	49.03	37.38	15.21	58.44	100	0	P	V
														V
														V
<b>Remark</b>	1. No other spurious found. 2. All results are PASS against Peak and Average limit line.													



Emission below 1GHz  
2.4GHz WIFI 802.11b (LF)

WIFI	Note	Frequency	Level	Over	Limit	Read	Antenna	Path	Preamp	Ant	Table	Peak	Pol.	
Ant.				Limit	Line	Level	Factor	Loss	Factor	Pos	Pos	Avg.		
1		( MHz )	( dBμV/m )	( dB )	( dBμV/m )	( dBμV )	( dB/m )	( dB )	( dB )	( cm )	( deg )	(P/A)	(H/V)	
2.4GHz 802.11b LF		30	21.37	-18.63	40	29.02	24.48	0.32	32.45			P	H	
		185.2	19.56	-23.94	43.5	35.4	14.85	1.66	32.35			P	H	
		503.36	25	-21	46	30.32	23.95	3.31	32.58			P	H	
		850.62	32.36	-13.64	46	30.72	29.05	4.66	32.07			P	H	
		940.83	33.58	-12.42	46	29.9	30.49	4.62	31.43	100	0	P	H	
		982.54	34.28	-19.72	54	29.28	30.81	5.25	31.06			P	H	
													H	
													H	
													H	
													H	
													H	
													H	
			30.97	22.41	-17.59	40	30.56	24	0.3	32.45			P	V
			179.38	18.2	-25.3	43.5	33.86	15.06	1.63	32.35			P	V
			460.68	24.67	-21.33	46	30.71	23.32	3.19	32.55			P	V
			777.87	30.34	-15.66	46	30.11	28.2	4.43	32.4			P	V
			952.47	34.33	-11.67	46	30.19	30.81	4.66	31.33	100	0	P	V
			999.03	34.94	-19.06	54	29.74	30.54	5.58	30.92			P	V
													V	
													V	
												V		
												V		
												V		
												V		
Remark	1. No other spurious found. 2. All results are PASS against limit line.													





**Note symbol**

*	<b>Fundamental Frequency</b> which can be ignored. However, the level of any unwanted emissions shall not exceed the level of the fundamental frequency.
!	Test result is <b>over limit</b> line.
P/A	<b>Peak</b> or <b>Average</b>
H/V	<b>Horizontal</b> or <b>Vertical</b>



A calculation example for radiated spurious emission is shown as below:

WIFI	Note	Frequency	Level	Over	Limit	Read	Antenna	Path	Preamp	Ant	Table	Peak	Pol.
Ant.				Limit	Line	Level	Factor	Loss	Factor	Pos	Pos	Avg.	
1		( MHz )	( dBμV/m )	( dB )	( dBμV/m )	( dBμV )	( dB/m )	( dB )	( dB )	( cm )	( deg )	( P/A )	( H/V )
802.11b		2390	55.45	-18.55	74	54.51	32.22	4.58	35.86	103	308	P	H
CH 01													
2412MHz		2390	43.54	-10.46	54	42.6	32.22	4.58	35.86	103	308	A	H

1. Path Loss(dB) = Cable loss(dB) + Filter loss(dB) + Attenuator loss(dB)
2. Level(dBμV/m) =  
Antenna Factor(dB/m) + Path Loss(dB) + Read Level(dBμV) - Preamp Factor(dB)
3. Over Limit(dB) = Level(dBμV/m) – Limit Line(dBμV/m)

**For Peak Limit @ 2390MHz:**

1. Level(dBμV/m)  
= Antenna Factor(dB/m) + Path Loss(dB) + Read Level(dBμV) - Preamp Factor(dB)  
= 32.22(dB/m) + 4.58(dB) + 54.51(dBμV) – 35.86 (dB)  
= 55.45 (dBμV/m)
2. Over Limit(dB)  
= Level(dBμV/m) – Limit Line(dBμV/m)  
= 55.45(dBμV/m) – 74(dBμV/m)  
= -18.55(dB)

**For Average Limit @ 2390MHz:**

1. Level(dBμV/m)  
= Antenna Factor(dB/m) + Path Loss(dB) + Read Level(dBμV) - Preamp Factor(dB)  
= 32.22(dB/m) + 4.58(dB) + 42.6(dBμV) – 35.86 (dB)  
= 43.54 (dBμV/m)
2. Over Limit(dB)  
= Level(dBμV/m) – Limit Line(dBμV/m)  
= 43.54(dBμV/m) – 54(dBμV/m)  
= -10.46(dB)

Both peak and average measured complies with the limit line, so test result is “PASS”.



### Appendix C. Radiated Spurious Emission Plots

Test Engineer :	Jacky Hung, Austin LI, and CR Liro	Temperature :	23~24 °C
		Relative Humidity :	60~63 %

#### Note symbol

-L	Low channel location
-R	High channel location

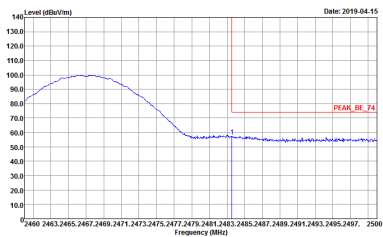
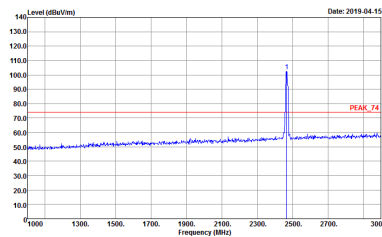
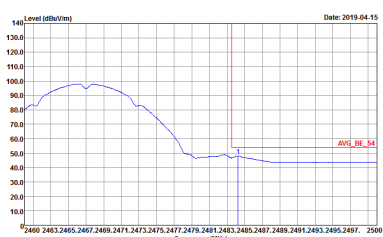
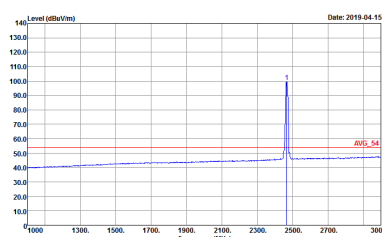

2.4GHz 2400~2483.5MHz  
WIFI 802.11b (Band Edge @ 3m)

WIFI	2.4GHz 2400~2483.5MHz Band Edge @ 3m	
ANT	802.11b CH12 2467MHz	
1	Horizontal	Fundamental
<b>Peak</b>	 <p>Site : 03CH16-HY Condition : PEAK_BE_74 3m 91200_1522 HORIZONTAL Detector : Peak Project : 921116-01 Setting : OXIC</p>	 <p>Site : 03CH16-HY Condition : PEAK_74 3m 91200_1522 HORIZONTAL Detector : Peak Project : 921116-01 Setting : OXIC</p>
<b>Avg.</b>	 <p>Site : 03CH16-HY Condition : AVG_BE_54 3m 91200_1522 HORIZONTAL Detector : Peak Project : 921116-01 Setting : OXIC</p>	 <p>Site : 03CH16-HY Condition : AVG_54 3m 91200_1522 HORIZONTAL Detector : Peak Project : 921116-01 Setting : OXIC</p>

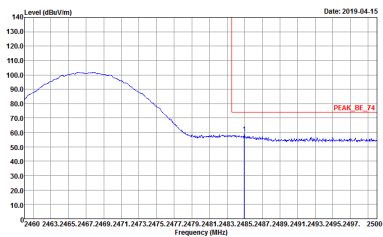
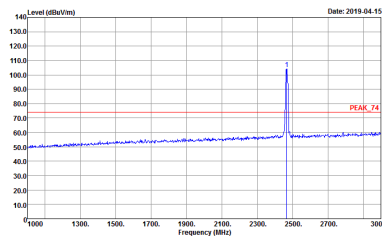
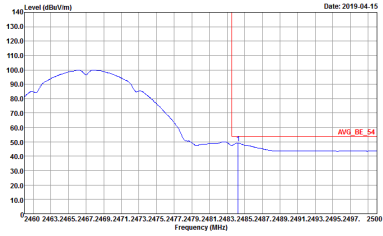
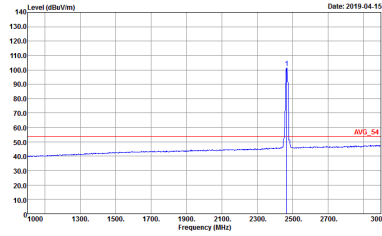

WIFI	2.4GHz 2400~2483.5MHz Band Edge @ 3m	
ANT	802.11b CH12 2467MHz	
1	Vertical	Fundamental
Peak	 <p>Date: 2019-04-15</p> <p>Site : 03CH16-HY            Condition : PEAK_BE_74 3m 91200_1522 VERTICAL            RBW:1000.000KHz VBW:3000.000KHz SWT:Auto            Detector : Peak            Project : 921116-01            Setting : OXIC</p>	 <p>Date: 2019-04-15</p> <p>Site : 03CH16-HY            Condition : PEAK_74 3m 91200_1522 VERTICAL            RBW:1000.000KHz VBW:3000.000KHz SWT:Auto            Detector : Peak            Project : 921116-01            Setting : OXIC</p>
Avg.	 <p>Date: 2019-04-15</p> <p>Site : 03CH16-HY            Condition : AVG_BE_54 3m 91200_1522 VERTICAL            RBW:1000.000KHz VBW:3000.000KHz SWT:Auto            Detector : Peak            Project : 921116-01            Setting : OXIC</p>	 <p>Date: 2019-04-15</p> <p>Site : 03CH16-HY            Condition : AVG_54 3m 91200_1522 VERTICAL            RBW:1000.000KHz VBW:3000.000KHz SWT:Auto            Detector : Peak            Project : 921116-01            Setting : OXIC</p>



2.4GHz 2400~2483.5MHz  
 WIFI 802.11n HT20 (Band Edge @ 3m)

WIFI	2.4GHz 2400~2483.5MHz Band Edge @ 3m	
ANT	802.11n HT20 CH13 2472MHz	
1	Horizontal	Fundamental
Peak	<p>Site : 03CH16-HY            Condition : PEAK_BE_74 3m 91200_1522 HORIZONTAL            RBW:1000.000KHz VBW:3000.000KHz SWT:Auto            Detector : Peak            Project : 921116-01            Setting : CXX00</p>	<p>Site : 03CH16-HY            Condition : PEAK_74 3m 91200_1522 HORIZONTAL            RBW:1000.000KHz VBW:3000.000KHz SWT:Auto            Detector : Peak            Project : 921116-01            Setting : CXX00</p>
Avg.	<p>Site : 03CH16-HY            Condition : AV6_BE_54 3m 91200_1522 HORIZONTAL            RBW:1000.000KHz VBW:0.010KHz SWT:Auto            Detector : Peak            Project : 921116-01            Setting : CXX00</p>	<p>Site : 03CH16-HY            Condition : AV6_54 3m 91200_1522 HORIZONTAL            RBW:1000.000KHz VBW:0.010KHz SWT:Auto            Detector : Peak            Project : 921116-01            Setting : CXX00</p>

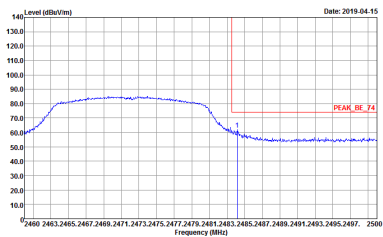
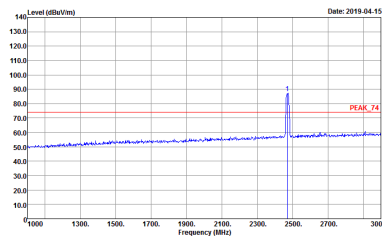
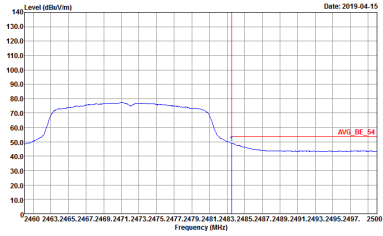
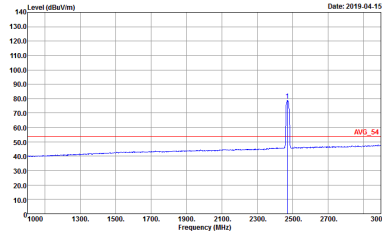

WIFI	2.4GHz 2400~2483.5MHz Band Edge @ 3m	
ANT	802.11n HT20 CH13 2472MHz	
1	Vertical	Fundamental
Peak	 <p>Date: 2019-04-15</p> <p>Site : 03CH16-HY            Condition : PEAK_BE_74 3m 91200_1522 VERTICAL            RBW:1000.000KHz VBW:3000.000KHz SWT:Auto            Detector : Peak            Project : 921116-01            Setting : CXX0</p>	 <p>Date: 2019-04-15</p> <p>Site : 03CH16-HY            Condition : PEAK_74 3m 91200_1522 VERTICAL            RBW:1000.000KHz VBW:3000.000KHz SWT:Auto            Detector : Peak            Project : 921116-01            Setting : CXX0</p>
Avg.	 <p>Date: 2019-04-15</p> <p>Site : 03CH16-HY            Condition : AVG_BE_54 3m 91200_1522 VERTICAL            RBW:1000.000KHz VBW:0.010KHz SWT:Auto            Detector : Peak            Project : 921116-01            Setting : CXX0</p>	 <p>Date: 2019-04-15</p> <p>Site : 03CH16-HY            Condition : AVG_54 3m 91200_1522 VERTICAL            RBW:1000.000KHz VBW:0.010KHz SWT:Auto            Detector : Peak            Project : 921116-01            Setting : CXX0</p>



**2.4GHz 2400~2483.5MHz**  
**WIFI 802.11b (Harmonic @ 3m)**

<b>WIFI</b>	<b>2.4GHz 2400~2483.5MHz Harmonic @ 3m</b>	
<b>ANT</b>	<b>802.11b CH12 2467MHz</b>	
<b>1</b>	<b>Horizontal</b>	<b>Vertical</b>
<b>Peak</b> <b>Avg.</b>	<p>Site : 03CH16-HY          Condition : PEAK_74 3m 9120D_1522 HORIZONTAL          Detector : Peak          Project : 921116-01</p>	<p>Site : 03CH16-HY          Condition : PEAK_74 3m 9120D_1522 VERTICAL          Detector : Peak          Project : 921116-01</p>





**2.4GHz 2400~2483.5MHz**  
**WIFI 802.11n HT20 (Harmonic @ 3m)**

<b>WIFI</b>	<b>2.4GHz 2400~2483.5MHz Harmonic @ 3m</b>	
<b>ANT</b>	<b>802.11n HT20 CH13 2472MHz</b>	
<b>1</b>	<b>Horizontal</b>	<b>Vertical</b>
<b>Peak</b> <b>Avg.</b>	<p>Site : 03CH16-HY          Condition : PEAK_74 3m 91200_1522 HORIZONTAL          Detector : Peak          Project : 921116-01</p>	<p>Site : 03CH16-HY          Condition : PEAK_74 3m 91200_1522 VERTICAL          Detector : Peak          Project : 921116-01</p>



Emission below 1GHz  
2.4GHz WIFI 802.11b (LF)

WIFI	2.4GHz 2400~2483.5MHz	
ANT	802.11b LF	
1	Horizontal	Vertical
QP / Peak	<p>Site : 03CH16-HY Condition : QP 3m 81LOG_47020406 HORIZONTAL Detector : Peak Project : 921116-01</p>	<p>Site : 03CH16-HY Condition : QP 3m 81LOG_47020406 VERTICAL Detector : Peak Project : 921116-01</p>



## Appendix D. Duty Cycle Plots

Antenna	Band	Duty Cycle(%)	T(us)	1/T(kHz)	VBW Setting	Duty Factor(dB)
1	802.11b	99.03	-	-	10Hz	0.04
1	802.11g	95.06	2020	0.50	1kHz	0.22
1	2.4GHz 802.11n HT20	98.02	-	-	10Hz	0.09



<Ant. 1>

802.11b

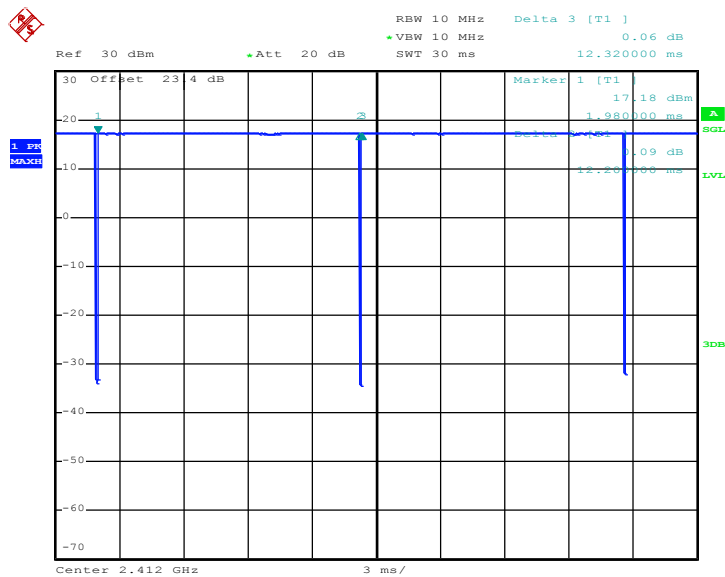

Date: 12.APR.2019 05:29:01

802.11g

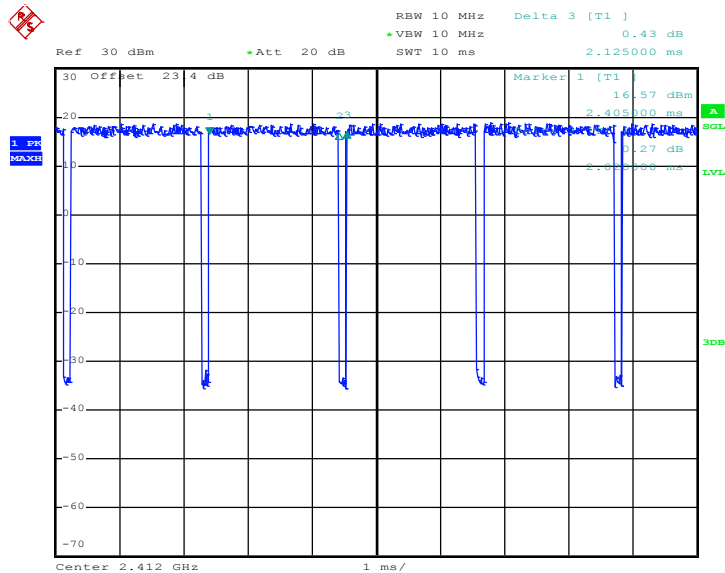

Date: 12.APR.2019 05:51:45



802.11n HT20

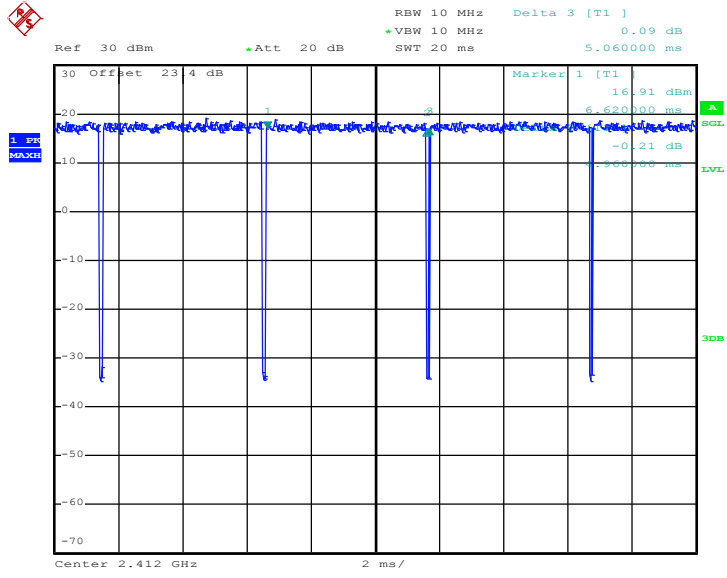

Date: 16.APR.2019 06:17:13

—THE END—