



FCC RF Test Report

APPLICANT : Sony Mobile Communications Inc.
EQUIPMENT : GSM/WCDMA/LTE Phone+Bluetooth,
DTS/UNII a/b/g/n and NFC
BRAND NAME : Sony
FCC ID : PY7-PM0960
STANDARD : FCC Part 15 Subpart C §15.247
CLASSIFICATION : (DSS) Spread Spectrum Transmitter

The product was received on Jan. 22, 2016 and testing was completed on Feb. 10, 2016. We, SPORTON INTERNATIONAL INC., would like to declare that the tested sample has been evaluated in accordance with the test procedures and has been in compliance with the applicable technical standards.

The test results in this report apply exclusively to the tested model / sample. Without written approval of SPORTON INTERNATIONAL INC., the test report shall not be reproduced except in full.

Reviewed by: Joseph Lin / Supervisor

Approved by: Jones Tsai / Manager



SPORTON INTERNATIONAL INC.

No. 52, Hwa Ya 1st Rd., Hwa Ya Technology Park, Kwei-Shan District, Tao Yuan City, Taiwan, R.O.C.



TABLE OF CONTENTS

REVISION HISTORY..... 3

SUMMARY OF TEST RESULT 4

1 GENERAL DESCRIPTION..... 5

 1.1 Applicant 5

 1.2 Manufacturer..... 5

 1.3 Product Feature of Equipment Under Test..... 5

 1.4 Modification of EUT 7

 1.5 Testing Location 7

 1.6 Applicable Standards..... 8

2 TEST CONFIGURATION OF EQUIPMENT UNDER TEST..... 9

 2.1 Descriptions of Test Mode 9

 2.2 Test Mode 10

 2.3 Connection Diagram of Test System 11

 2.4 Support Unit used in test configuration and system 12

 2.5 EUT Operation Test Setup 12

 2.6 Measurement Results Explanation Example..... 12

3 TEST RESULT 13

 3.1 Number of Channel Measurement 13

 3.2 Hopping Channel Separation Measurement 15

 3.3 Dwell Time Measurement..... 22

 3.4 20dB and 99% Bandwidth Measurement 25

 3.5 Peak Output Power Measurement 38

 3.6 Conducted Band Edges Measurement..... 40

 3.7 Conducted Spurious Emission Measurement 47

 3.8 Radiated Band Edges and Spurious Emission Measurement 57

 3.9 AC Conducted Emission Measurement..... 65

 3.10 Antenna Requirements 69

4 LIST OF MEASURING EQUIPMENT..... 70

5 UNCERTAINTY OF EVALUATION..... 72

APPENDIX A. RADIATED SPURIOUS EMISSION

APPENDIX B. RADIATED SPURIOUS EMISSION PLOT



REVISION HISTORY

REPORT NO.	VERSION	DESCRIPTION	ISSUED DATE
FR612117-01A	Rev. 01	Initial issue of report	Mar. 31, 2016
FR612117-01A	Rev. 02	Updating the SW Version.	May 09, 2016



SUMMARY OF TEST RESULT

Report Section	FCC Rule	Description	Limit	Result	Remark
3.1	15.247(a)(1)	Number of Channels	≥ 15Chs	Pass	-
3.2	15.247(a)(1)	Hopping Channel Separation	≥ 2/3 of 20dB BW	Pass	-
3.3	15.247(a)(1)	Dwell Time of Each Channel	≤ 0.4sec in 31.6sec period	Pass	-
3.4	15.247(a)(1)	20dB Bandwidth	NA	Pass	-
3.4	-	99% Bandwidth	-	Pass	-
3.5	15.247(b)(1)	Peak Output Power	≤ 125 mW	Pass	-
3.6	15.247(d)	Conducted Band Edges	≤ 20dBc	Pass	-
3.7	15.247(d)	Conducted Spurious Emission	≤ 20dBc	Pass	-
3.8	15.247(d)	Radiated Band Edges and Radiated Spurious Emission	15.209(a) & 15.247(d)	Pass	Under limit 9.22 dB at 30.540 MHz
3.9	15.207	AC Conducted Emission	15.207(a)	Pass	Under limit 17.70 dB at 0.438 MHz
3.10	15.203 & 15.247(b)	Antenna Requirement	N/A	Pass	-



1 General Description

1.1 Applicant

Sony Mobile Communications Inc.

4-12-3 Higashi-Shinagawa, Shinagawa-ku, Tokyo, 140-0002, Japan

1.2 Manufacturer

Sony Mobile Communications Inc.

4-12-3 Higashi-Shinagawa, Shinagawa-ku, Tokyo, 140-0002, Japan

1.3 Product Feature of Equipment Under Test

GSM/WCDMA/LTE, Bluetooth, DTS/UNII, a/b/g/n, GPS, and NFC

Product Specification subjective to this standard	
Antenna Type	Bluetooth : PIFA Antenna type with gain -0.30 dBi

EUT Information List				
IMEI	HW Version	SW Version	S/N	Performed Test Item
004402455898886	A	37.0.A.0.43	RQ3000DQQZ	RF conducted measurement
004402455893739			RQ3000DQHV	Radiated Spurious Emission
004402455895585			RQ3000DQQU	Conducted Emission



Accessory List	
AC Adapter	Model No. : EP800
	Type No. : CAA-0002016-US B
	S/N : 3113W22608082 (for Radiated spurious emission) 3113W22608092 (for Conducted emission)
Earphone	Model No. : MH410c
	Type No. : AG-1110
	S/N : 1541A8180036F24 (for Radiated spurious emission) 1541A81B0036C26 (for Conducted emission)
USB Cable	Model No. : UCB16
	Type No. : AI-0142
	S/N : N/A (for Radiated spurious emission) N/A (for Conducted emission)

Note:

1. Above EUT list and accessory list used are electrically identical per declared by manufacturer.
2. Above the accessories list are used to exercise the EUT during test.
3. For other wireless features of this EUT, test report will be issued separately.



1.4 Modification of EUT

No modifications are made to the EUT during all test items.

1.5 Testing Location

Sporton Lab is accredited to ISO 17025 by Taiwan Accreditation Foundation (TAF code : 1190) and the FCC designation No. TW1022 under the FCC 2.948(e) by Mutual Recognition Agreement (MRA) in FCC Test.

Test Site	SPORTON INTERNATIONAL INC.	
Test Site Location	No. 52, Hwa Ya 1 st Rd., Hwa Ya Technology Park, Kwei-Shan District, Tao Yuan City, Taiwan, R.O.C. TEL: +886-3-327-3456 FAX: +886-3-328-4978	
Test Site No.	Sporton Site No.	
	TH05-HY	CO05-HY

Note: The test site complies with ANSI C63.4 2014 requirement.

Test Site	SPORTON INTERNATIONAL INC.	
Test Site Location	No.58, Aly. 75, Ln. 564, Wenhua 3rd Rd. Guishan Dist, Taoyuan City, Taiwan (R.O.C.) TEL: +886-3-327-0868 FAX: +886-3-327-0855	
Test Site No.	Sporton Site No.	
	03CH11-HY	

Note: The test site complies with ANSI C63.4 2014 requirement.



1.6 Applicable Standards

According to the specifications of the manufacturer, the EUT must comply with the requirements of the following standards:

- ♦ FCC Part 15 Subpart C §15.247
- ♦ FCC Public Notice DA 00-705
- ♦ ANSI C63.10-2013

Remark:

1. All test items were verified and recorded according to the standards and without any deviation during the test.
2. This EUT has also been tested and complied with the requirements of FCC Part 15, Subpart B, recorded in a separate test report.



2 Test Configuration of Equipment Under Test

2.1 Descriptions of Test Mode

Preliminary tests were performed in different data rates and recorded the RF output power in the following table:

Channel	Frequency	Bluetooth RF Output Power		
		Data Rate / Modulation		
		GFSK	$\pi/4$ -DQPSK	8-DPSK
		1Mbps	2Mbps	3Mbps
Ch00	2402MHz	5.79 dBm	4.97 dBm	5.10 dBm
Ch39	2441MHz	6.05 dBm	5.37 dBm	5.62 dBm
Ch78	2480MHz	5.50 dBm	4.59 dBm	4.80 dBm

Remark:

1. All the test data for each data rate were verified, but only the worst case was reported.
 2. The data rate was set in 1Mbps for all the test items due to the highest RF output power.
- a. The EUT has been associated with peripherals and configuration operated in a manner tended to maximize its emission characteristics in a typical application. Frequency range investigated: conduction (150 kHz to 30 MHz), radiation (9 kHz to the 10th harmonic of the highest fundamental frequency or to 40 GHz, whichever is lower). Pre-scanned tests, X, Y, Z in three orthogonal panels, and different data rates were conducted to determine the final configuration (Z plane as worst plane) from all possible combinations, and the worst mode of radiated spurious emissions is Bluetooth 1Mbps mode, and recorded in this report.
 - b. AC power line Conducted Emission was tested under maximum output power.



2.2 Test Mode

The following summary table is showing all test modes to demonstrate in compliance with the standard.

Summary table of Test Cases			
Test Item	Data Rate / Modulation		
	Bluetooth BR 1Mbps GFSK	Bluetooth EDR 2Mbps $\pi/4$ -DQPSK	Bluetooth EDR 3Mbps 8-DPSK
Conducted Test Cases	Mode 1: CH00_2402 MHz Mode 2: CH39_2441 MHz Mode 3: CH78_2480 MHz	Mode 4: CH00_2402 MHz Mode 5: CH39_2441 MHz Mode 6: CH78_2480 MHz	Mode 7: CH00_2402 MHz Mode 8: CH39_2441 MHz Mode 9: CH78_2480 MHz
Radiated Test Cases	Bluetooth BR 1Mbps GFSK	Bluetooth EDR 2Mbps $\pi/4$ -DQPSK	Bluetooth EDR 3Mbps 8-DPSK
	Mode 1: CH00_2402 MHz Mode 2: CH39_2441 MHz Mode 3: CH78_2480 MHz	Mode 4: CH00_2402 MHz Mode 5: CH39_2441 MHz Mode 6: CH78_2480 MHz	Mode 7: CH00_2402 MHz Mode 8: CH39_2441 MHz Mode 9: CH78_2480 MHz
AC Conducted Emission	Mode 1 :GSM1900 Idle + Bluetooth Link + WLAN (2.4GHz) Link + MP3 + Earphone + Battery 2 + USB Cable (Charging from Adapter)		
Remark: For radiated test cases, the worst mode data rate 1Mbps was reported only, because this data rate has the highest RF output power at preliminary tests, and the conducted spurious emissions and conducted band edge measurement for each data rate are no worse than 1Mbps, and no other significantly frequencies found in conducted spurious emission.			

2.3 Connection Diagram of Test System

<Bluetooth Tx Mode>

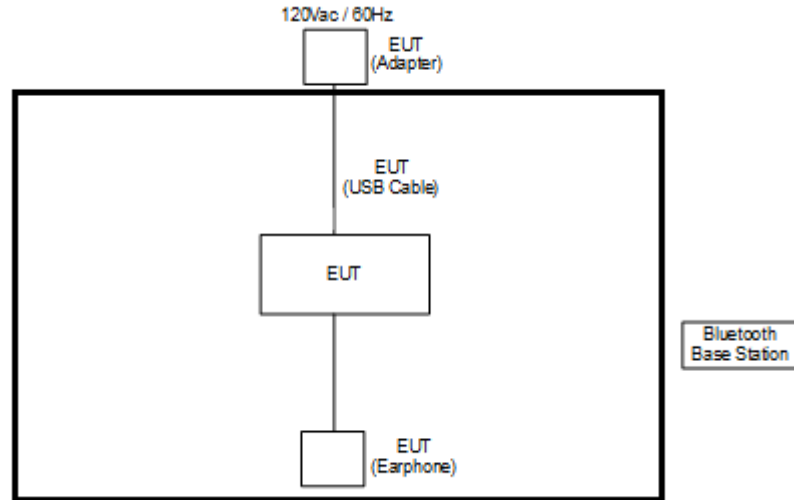

<AC Conducted Emission Mode>

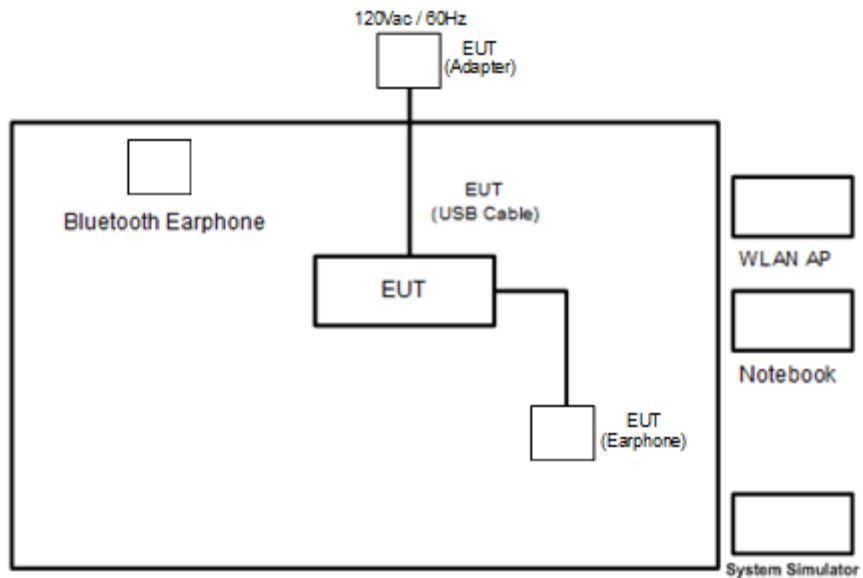



2.4 Support Unit used in test configuration and system

Item	Equipment	Trade Name	Model Name	FCC ID	Data Cable	Power Cord
1.	System Simulator	Anritsu	MT8820C	N/A	N/A	Unshielded, 1.8 m
2.	Bluetooth Base Station	R&S	CBT32	N/A	N/A	Unshielded, 1.8 m
3.	WLAN AP	D-Link	DIR-865L	KA2IR865LA1	N/A	Unshielded, 1.8 m
4.	Bluetooth Earphone	Sony	SBH20	PY7-RD0010	Unshielded, 0.75 m	N/A
5.	Notebook	DELL	Latitude E6320	FCC DoC/ Contains FCC ID: QDS-BRCM1054	N/A	AC I/P: Unshielded, 1.2 m DC O/P: Shielded, 1.8 m
6.	SD Card	SanDisk	MicroSD HC	FCC DoC	N/A	N/A

2.5 EUT Operation Test Setup

For Bluetooth test items, an engineering test program was provided and enabled to make EUT contact with Bluetooth base station for continuous transmitting and receiving signals.

2.6 Measurement Results Explanation Example

For all conducted test items:

The offset level is set in the spectrum analyzer to compensate the RF cable loss and attenuator factor between EUT conducted output port and spectrum analyzer. With the offset compensation, the spectrum analyzer reading level is exactly the EUT RF output level.

Example:

The spectrum analyzer offset is derived from RF cable loss and attenuator factor.

Offset = RF cable loss + attenuator factor.

Following shows an offset computation example with cable loss 4.2 dB and 10dB attenuator.

$$\begin{aligned}
\text{Offset(dB)} &= \text{RF cable loss(dB)} + \text{attenuator factor(dB)}. \\
&= 4.2 + 10 = 14.2 \text{ (dB)}
\end{aligned}$$

3 Test Result

3.1 Number of Channel Measurement

3.1.1 Limits of Number of Hopping Frequency

Frequency hopping systems in the 2400-2483.5 MHz band shall use at least 15 channels.

3.1.2 Measuring Instruments

The measuring equipment is listed in the section 4 of this test report.

3.1.3 Test Procedure

1. The testing follows ANSI C63.10-2013 clause 7.8.3.
2. The RF output of EUT was connected to the spectrum analyzer by RF cable and attenuator. The path loss was compensated to the results for each measurement.
3. Set to the maximum power setting and enable the EUT transmit continuously.
4. Enable the EUT hopping function.
5. Use the following spectrum analyzer settings: Span = the frequency band of operation; RBW = 300kHz; VBW \geq RBW; Sweep = auto; Detector function = peak; Trace = max hold.
6. The number of hopping frequency used is defined as the number of total channel.
7. Record the measurement data derived from spectrum analyzer.

3.1.4 Test Setup

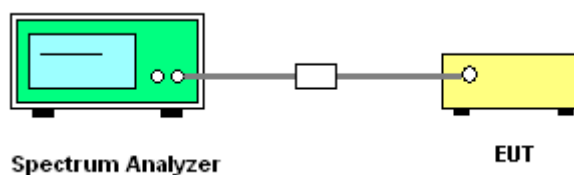

3.1.5 Test Result of Number of Hopping Frequency

Test Mode :	1Mbps	Temperature :	24~26°C
Test Engineer :	Osolemio Chang	Relative Humidity :	48~51%
Number of Hopping (Channel)	Adaptive Frequency Hopping (Channel)	Limits (Channel)	Pass/Fail
79	20	> 15	Pass



Number of Hopping Channel Plot on Channel 00 - 78

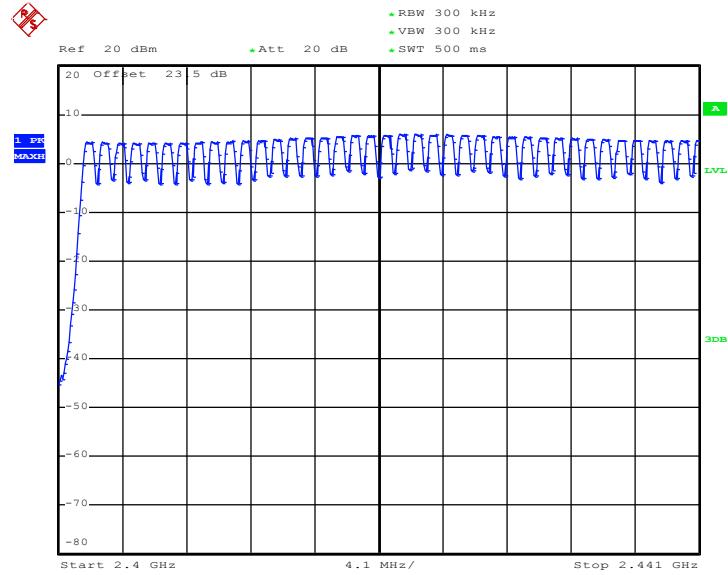

Date: 6.FEB.2016 17:33:55

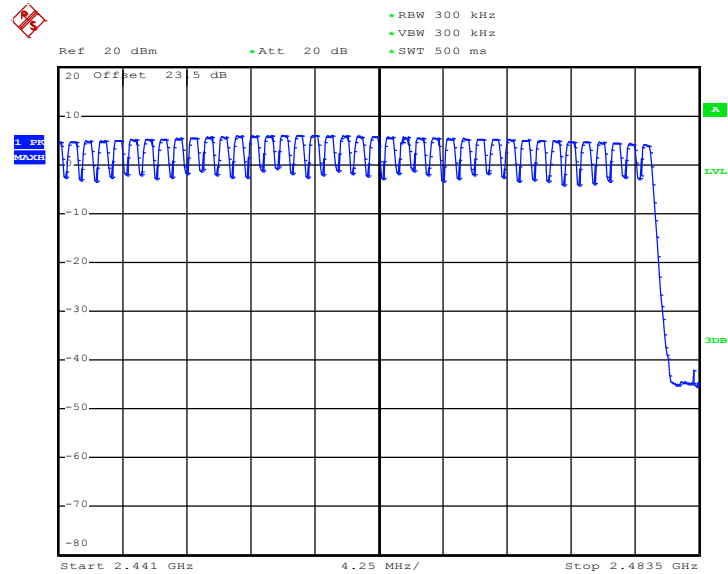

Date: 6.FEB.2016 17:38:50

3.2 Hopping Channel Separation Measurement

3.2.1 Limit of Hopping Channel Separation

Frequency hopping systems operating in the 2400-2483.5 MHz band may have hopping channel carrier frequencies that are separated by 25 kHz or two-thirds of the 20 dB bandwidth of the hopping channel, whichever is greater.

3.2.2 Measuring Instruments

The measuring equipment is listed in the section 4 of this test report.

3.2.3 Test Procedures

1. The testing follows ANSI C63.10-2013 clause 7.8.2.
2. The RF output of EUT was connected to the spectrum analyzer by RF cable and attenuator. The path loss was compensated to the results for each measurement.
3. Set to the maximum power setting and enable the EUT transmit continuously.
4. Enable the EUT hopping function.
5. Use the following spectrum analyzer settings:
Span = wide enough to capture the peaks of two adjacent channels;
RBW = 300kHz; VBW \geq RBW; Sweep = auto; Detector function = peak; Trace = max hold.
6. Measure and record the results in the test report.

3.2.4 Test Setup

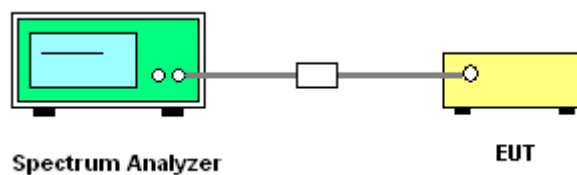



3.2.5 Test Result of Hopping Channel Separation

Test Mode :	1Mbps	Temperature :	24~26°C
Test Engineer :	Osolemio Chang	Relative Humidity :	48~51%

Channel	Frequency (MHz)	Frequency Separation (MHz)	(2/3 of 20dB BW) Limits (MHz)	Pass/Fail
00	2402	1.002	0.6213	Pass
39	2441	1.002	0.6187	Pass
78	2480	1.002	0.6053	Pass

Channel Separation Plot on Channel 00 - 01

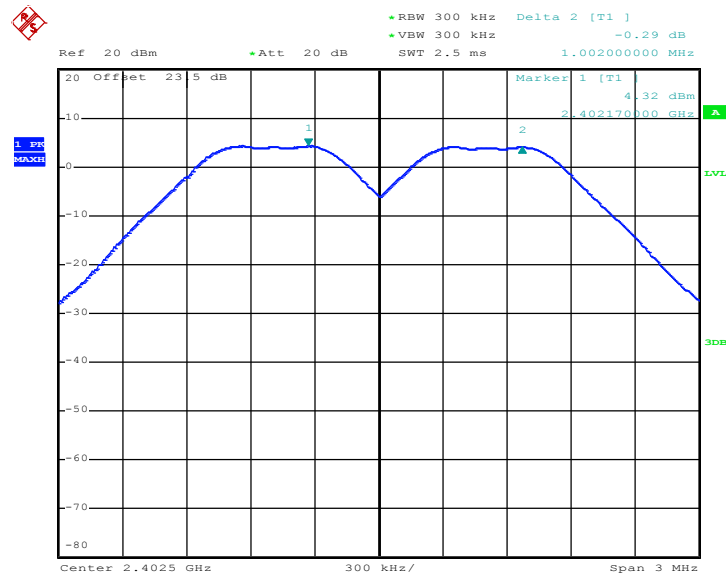

Date: 6.FEB.2016 16:01:26



Channel Separation Plot on Channel 39 - 40

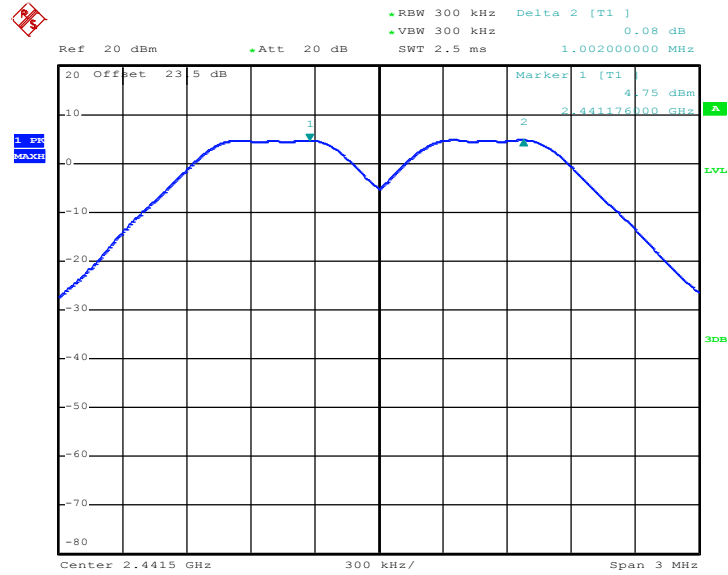

Date: 6.FEB.2016 16:03:43

Channel Separation Plot on Channel 77 - 78

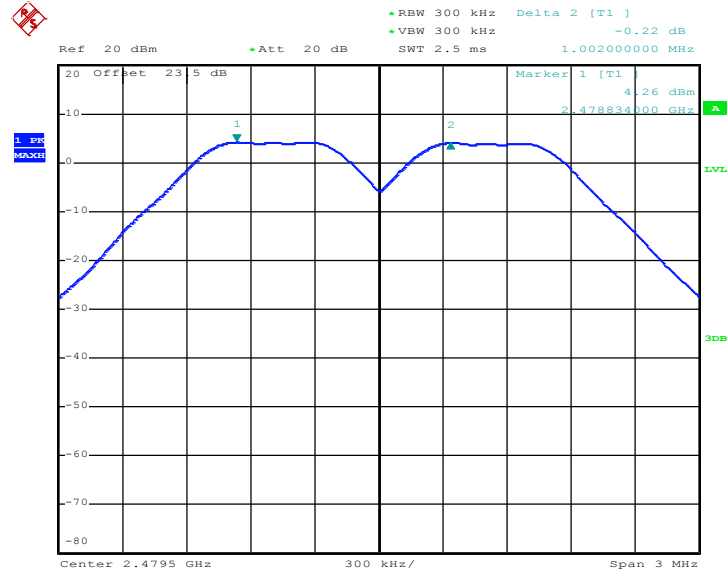

Date: 6.FEB.2016 16:05:12



Test Mode :	2Mbps	Temperature :	24~26°C
Test Engineer :	Osolemio Chang	Relative Humidity :	48~51%

Channel	Frequency (MHz)	Frequency Separation (MHz)	(2/3 of 20dB BW) Limits (MHz)	Pass/Fail
00	2402	1.002	0.8440	Pass
39	2441	1.002	0.8520	Pass
78	2480	1.002	0.8440	Pass

Channel Separation Plot on Channel 00 - 01

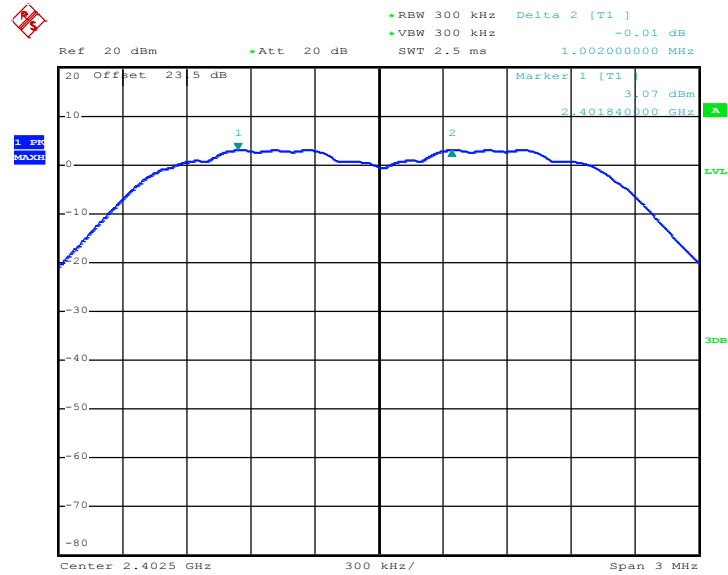

Date: 6.FEB.2016 16:10:34



Channel Separation Plot on Channel 39 - 40

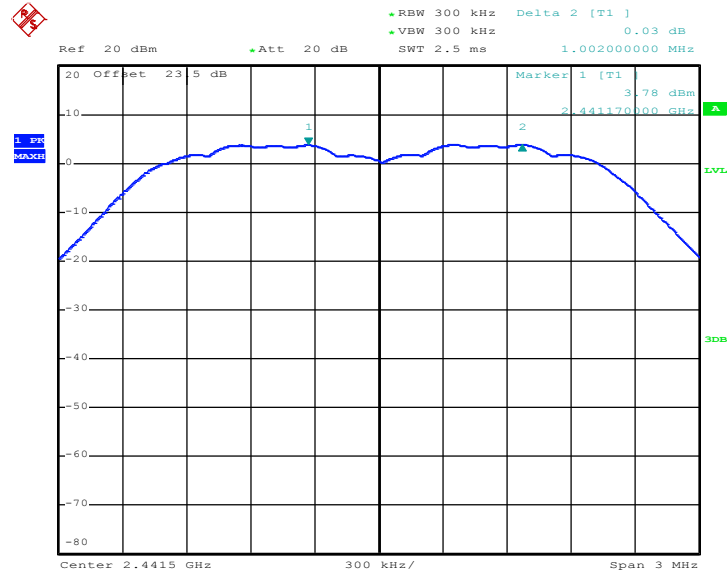

Date: 6.FEB.2016 16:12:16

Channel Separation Plot on Channel 77 - 78

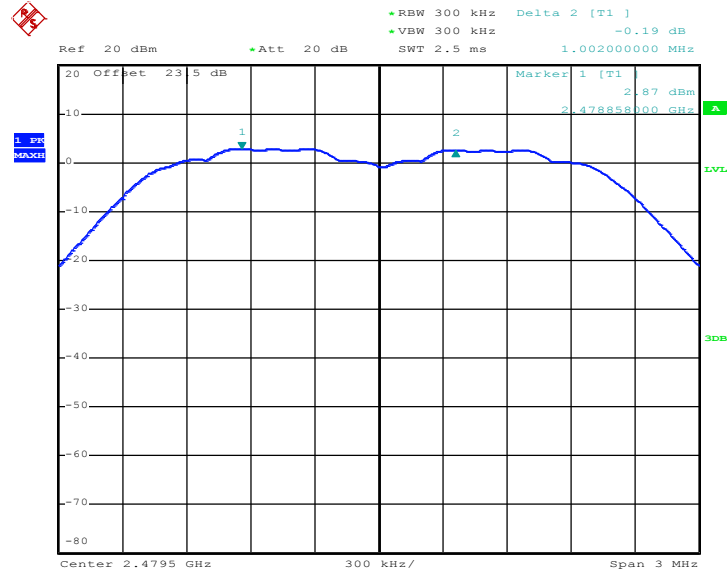

Date: 6.FEB.2016 16:14:05



Test Mode :	3Mbps	Temperature :	24~26°C
Test Engineer :	Osolemio Chang	Relative Humidity :	48~51%

Channel	Frequency (MHz)	Frequency Separation (MHz)	(2/3 of 20dB BW) Limits (MHz)	Pass/Fail
00	2402	1.002	0.8280	Pass
39	2441	1.002	0.8280	Pass
78	2480	1.002	0.8360	Pass

Channel Separation Plot on Channel 00 - 01

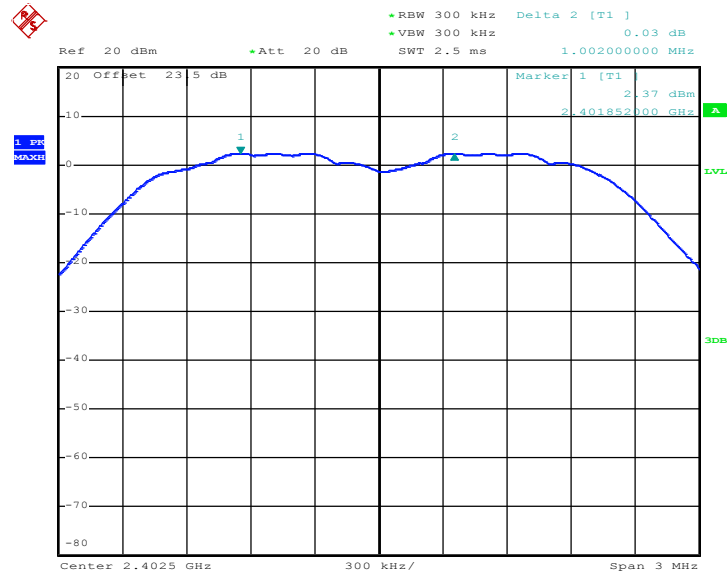

Date: 6.FEB.2016 16:26:38



Channel Separation Plot on Channel 39 - 40

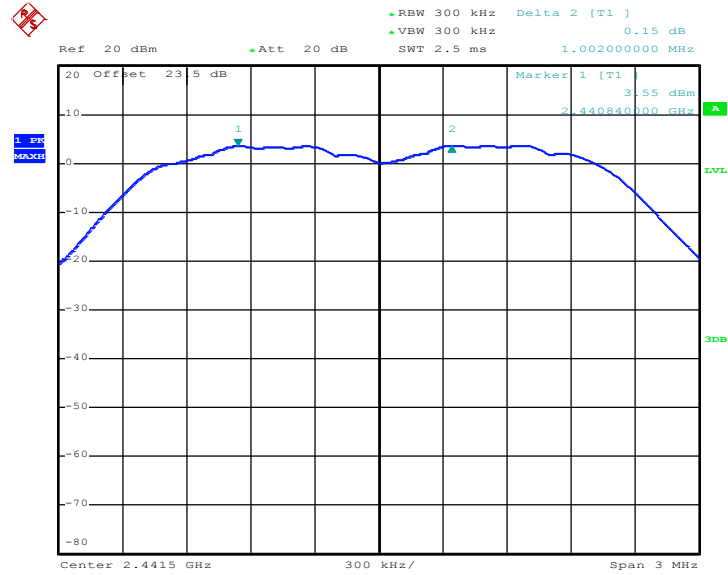

Date: 6.FEB.2016 16:28:20

Channel Separation Plot on Channel 77 - 78

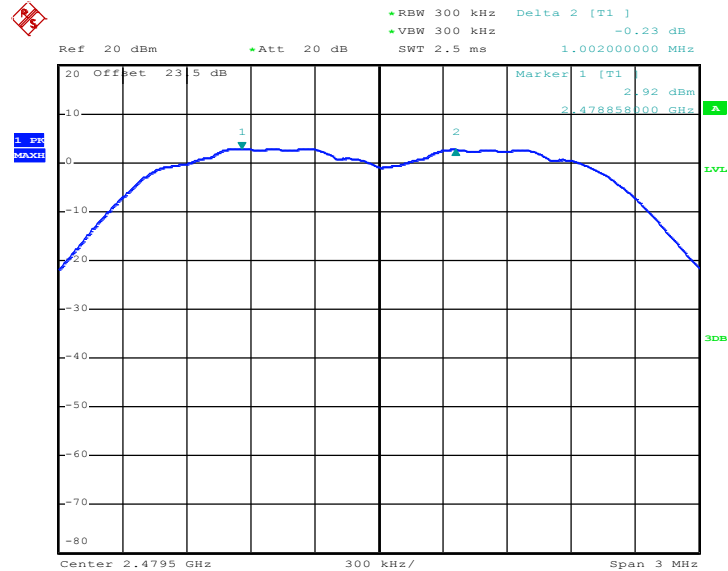

Date: 6.FEB.2016 16:30:19

3.3 Dwell Time Measurement

3.3.1 Limit of Dwell Time

The average time of occupancy on any channel shall not be greater than 0.4 seconds within a period of 0.4 seconds multiplied by the number of hopping channels employed.

3.3.2 Measuring Instruments

The measuring equipment is listed in the section 4 of this test report.

3.3.3 Test Procedures

1. The testing follows ANSI C63.10-2013 clause 7.8.4.
2. The RF output of EUT was connected to the spectrum analyzer by RF cable and attenuator. The path loss was compensated to the results for each measurement.
3. Set to the maximum power setting and enable the EUT transmit continuously.
4. Enable the EUT hopping function.
5. Use the following spectrum analyzer settings: Span = zero span, centered on a hopping channel; RBW = 1 MHz; VBW \geq RBW; Sweep = as necessary to capture the entire dwell time per hopping channel; Detector function = peak; Trace = max hold.
6. Measure and record the results in the test report.

3.3.4 Test Setup

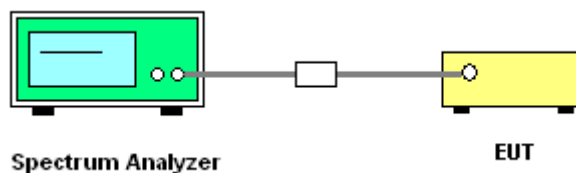



3.3.5 Test Result of Dwell Time

Test Mode :	DH5	Temperature :	24~26°C
Test Engineer :	Osolemio Chang	Relative Humidity :	48~51%

Mode	Hopping Channel Number	Hops Over Occupancy Time(hops)	Package Transfer Time (msec)	Dwell Time (sec)	Limits (sec)	Pass/Fail
Normal	79	106.67	2.88	0.31	0.4	Pass
AFH	20	53.33	2.88	0.15	0.4	Pass

Remark:

- In normal mode, hopping rate is 1600 hops/s with 6 slots in 79 hopping channels.
With channel hopping rate (1600 / 6 / 79) in Occupancy Time Limit (0.4 x 79) (s),
Hops Over Occupancy Time comes to (1600 / 6 / 79) x (0.4 x 79) = 106.67 hops.
- In AFH mode, hopping rate is 800 hops/s with 6 slots in 20 hopping channels.
With channel hopping rate (800 / 6 / 20) in Occupancy Time Limit (0.4 x 20) (s),
Hops Over Occupancy Time comes to (800 / 6 / 20) x (0.4 x 20) = 53.33 hops.
- Dwell Time(s) = Hops Over Occupancy Time (hops) x Package Transfer Time



Package Transfer Time Plot

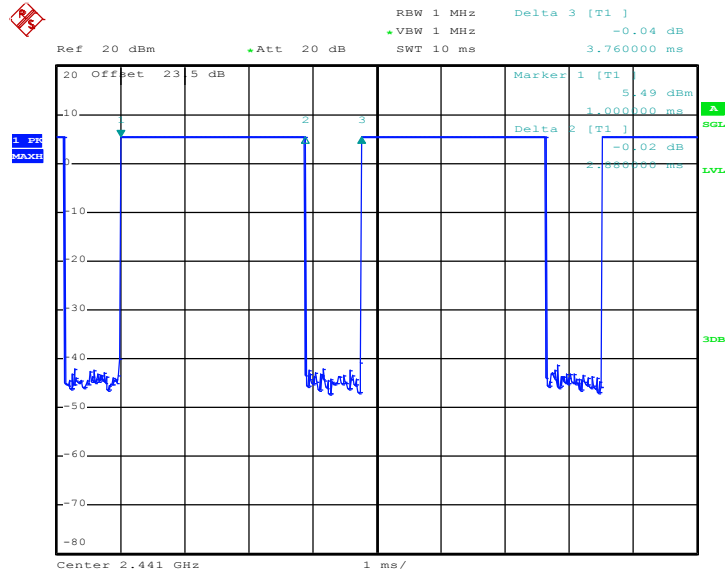

Date: 5.FEB.2016 18:01:19

3.4 20dB and 99% Bandwidth Measurement

3.4.1 Limit of 20dB and 99% Bandwidth

Reporting only

3.4.2 Measuring Instruments

The measuring equipment is listed in the section 4 of this test report.

3.4.3 Test Procedures

1. The testing follows ANSI C63.10-2013 clause 6.9.2 and 6.9.3.
2. The RF output of EUT was connected to the spectrum analyzer by RF cable and attenuator. The path loss was compensated to the results for each measurement.
3. Set to the maximum power setting and enable the EUT transmit continuously.
4. Use the following spectrum analyzer settings for 20dB Bandwidth measurement.
Span = approximately 2 to 5 times the 20 dB bandwidth, centered on a hopping channel;
RBW \geq 1% of the 20 dB bandwidth; VBW \geq RBW; Sweep = auto; Detector function = peak;
Trace = max hold.
5. Use the following spectrum analyzer settings for 99 % Bandwidth measurement.
Span = approximately 1.5 to 5 times the 99% bandwidth, centered on a hopping channel;
RBW \geq 1% of the 99% bandwidth; VBW \geq RBW; Sweep = auto; Detector function = peak;
Trace = max hold.
6. Measure and record the results in the test report.

3.4.4 Test Setup

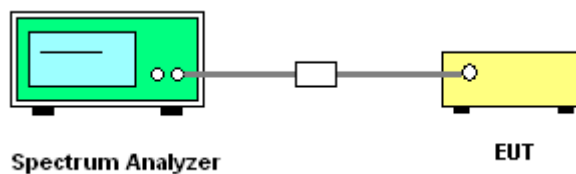



3.4.5 Test Result of 20dB Bandwidth

Test Mode :	1Mbps	Temperature :	24~26°C
Test Engineer :	Osolemio Chang	Relative Humidity :	48~51%

Channel	Frequency (MHz)	20dB Bandwidth (MHz)
00	2402	0.932
39	2441	0.928
78	2480	0.908

20 dB Bandwidth Plot on Channel 00

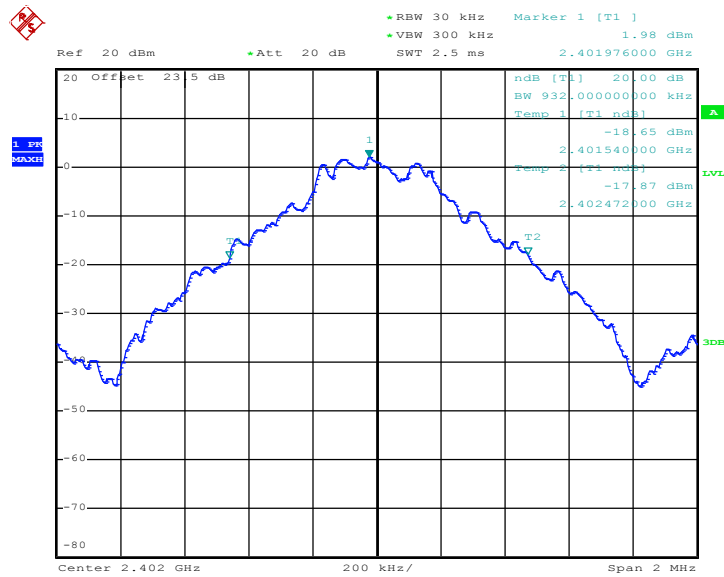

Date: 6.FEB.2016 16:31:27



20 dB Bandwidth Plot on Channel 39

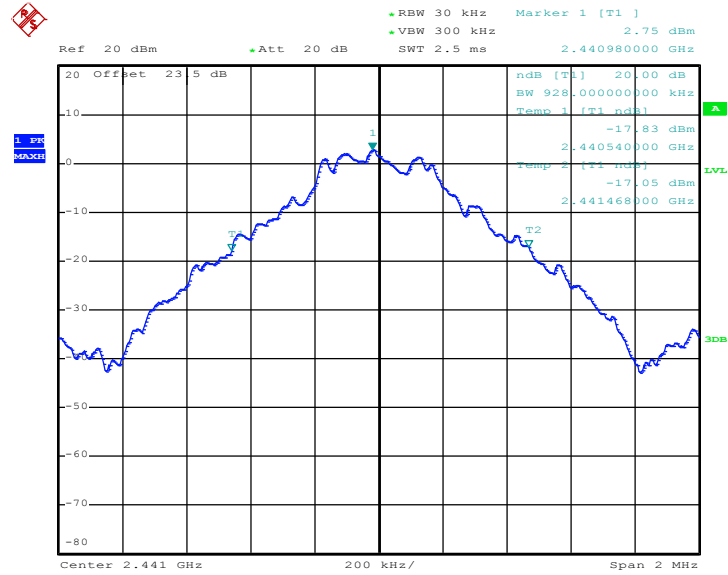

Date: 6.FEB.2016 16:35:41

20 dB Bandwidth Plot on Channel 78

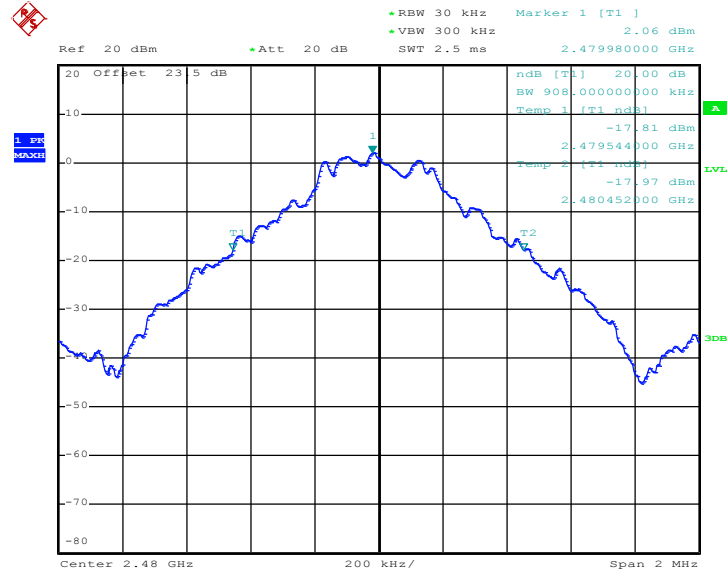

Date: 6.FEB.2016 16:39:00



Test Mode :	2Mbps	Temperature :	24~26°C
Test Engineer :	Osolemio Chang	Relative Humidity :	48~51%

Channel	Frequency (MHz)	20dB Bandwidth (MHz)
00	2402	1.266
39	2441	1.278
78	2480	1.266

20 dB Bandwidth Plot on Channel 00

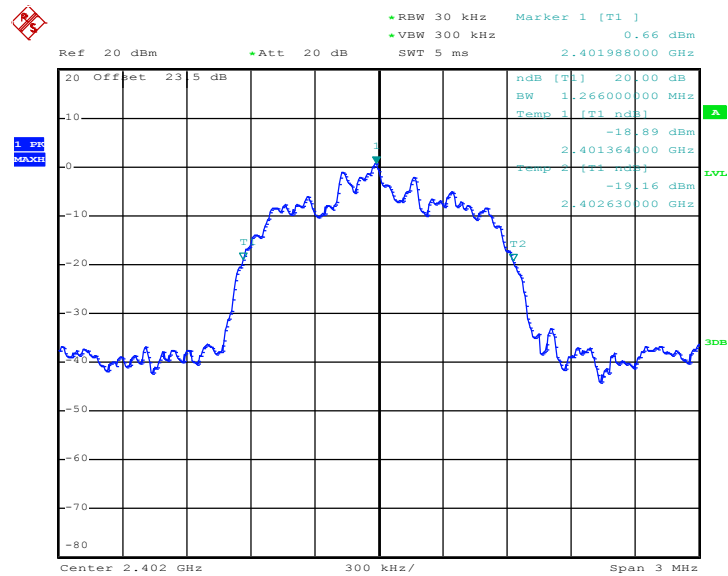

Date: 6.FEB.2016 16:45:20



20 dB Bandwidth Plot on Channel 39

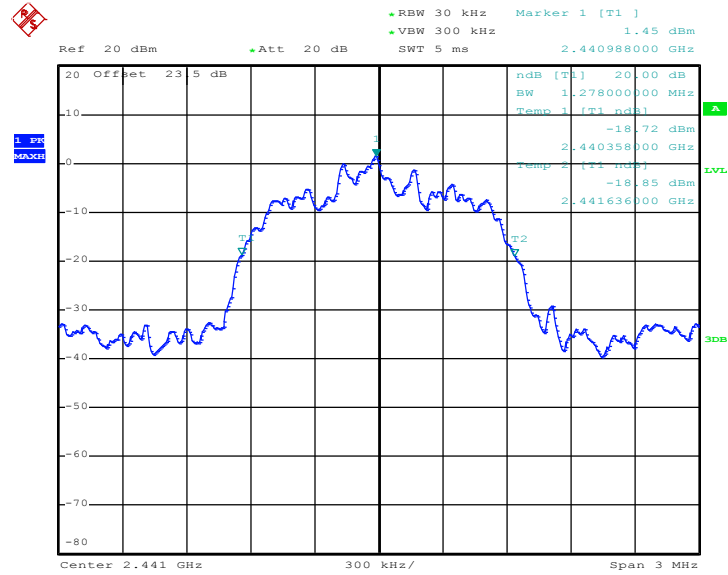

Date: 6.FEB.2016 16:50:13

20 dB Bandwidth Plot on Channel 78

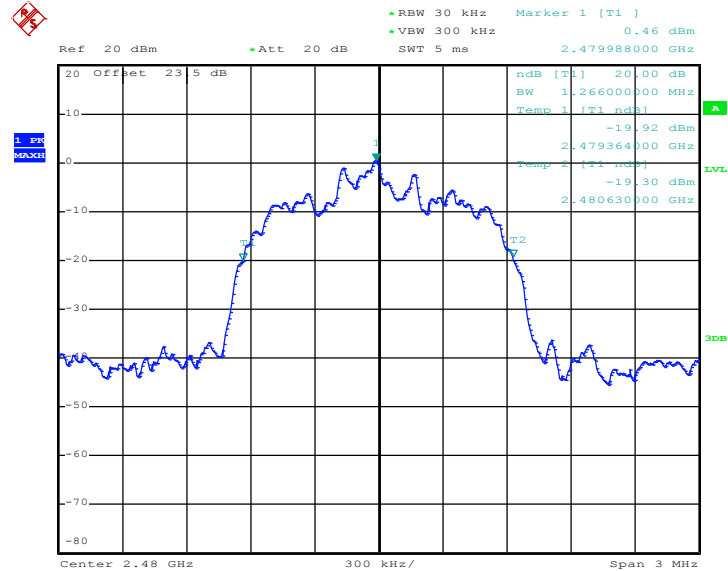

Date: 6.FEB.2016 16:54:57



Test Mode :	3Mbps	Temperature :	24~26°C
Test Engineer :	Osolemio Chang	Relative Humidity :	48~51%

Channel	Frequency (MHz)	20dB Bandwidth (MHz)
00	2402	1.242
39	2441	1.242
78	2480	1.254

20 dB Bandwidth Plot on Channel 00

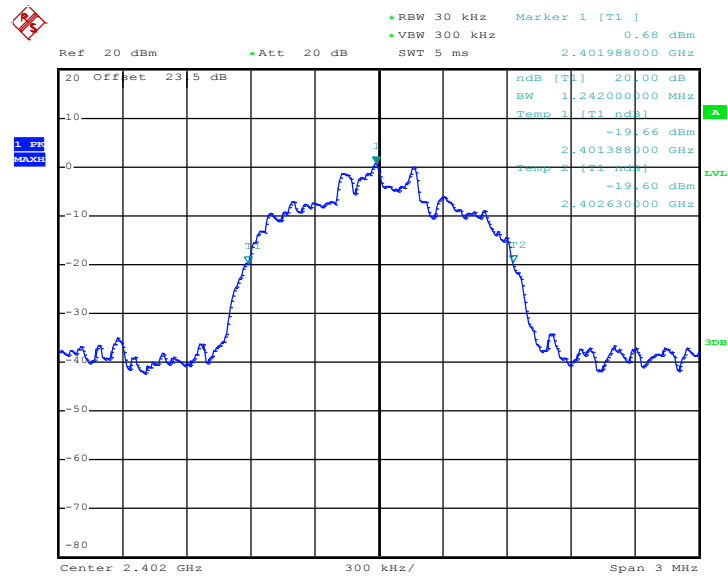

Date: 6.FEB.2016 17:06:31



20 dB Bandwidth Plot on Channel 39

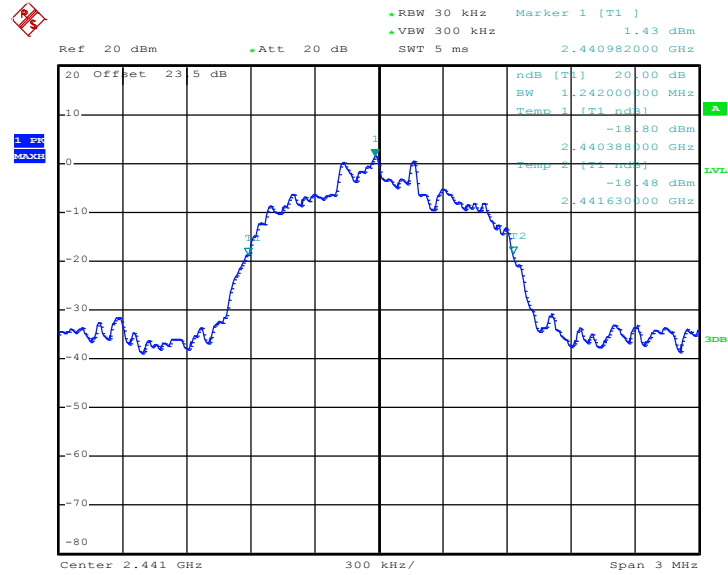

Date: 6.FEB.2016 17:13:59

20 dB Bandwidth Plot on Channel 78

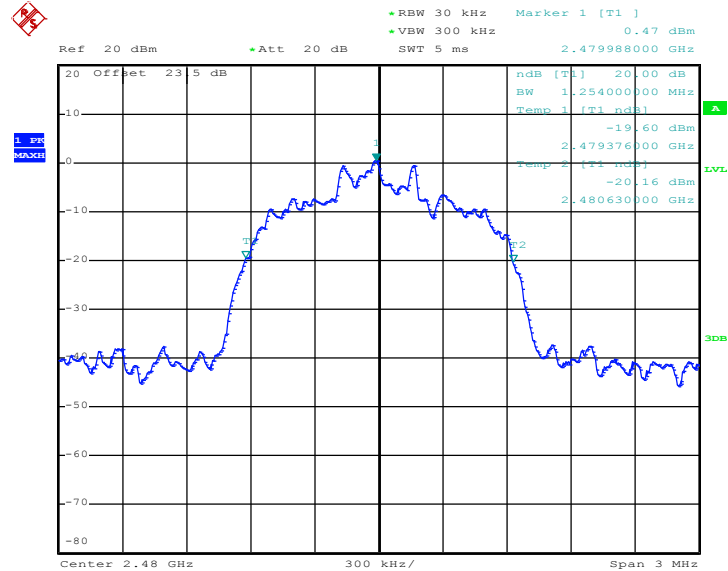

Date: 6.FEB.2016 17:16:46



3.4.6 Test Result of 99% Occupied Bandwidth

Test Mode :	1Mbps	Temperature :	24~26°C
Test Engineer :	Osolemio Chang	Relative Humidity :	48~51%

Channel	Frequency (MHz)	99% Occupied Bandwidth (MHz)
00	2402	0.856
39	2441	0.856
78	2480	0.860

99% Occupied Bandwidth Plot on Channel 00

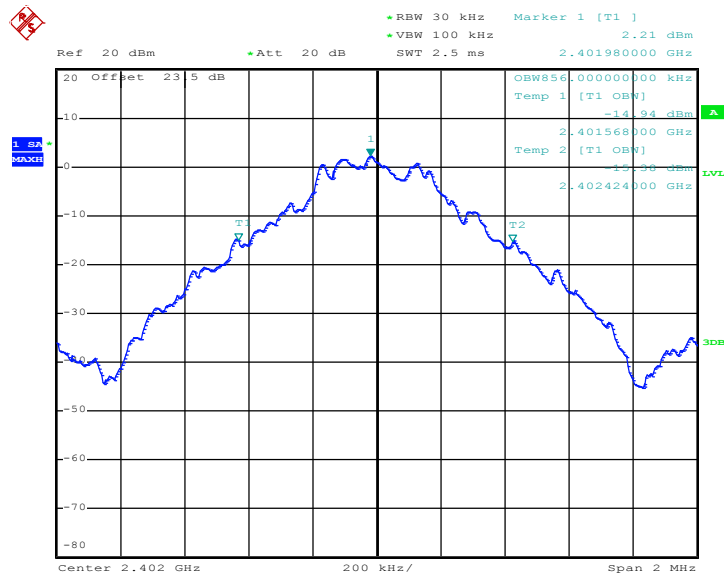

Date: 6.FEB.2016 16:32:09



99% Occupied Bandwidth Plot on Channel 39

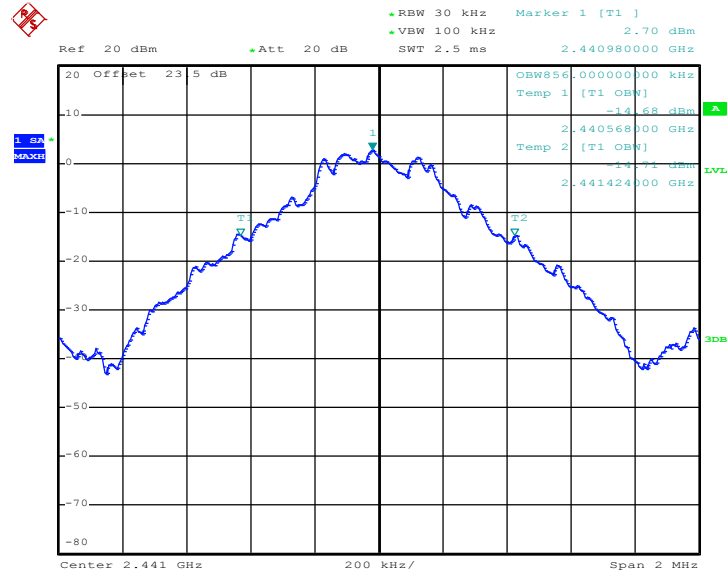

Date: 6.FEB.2016 16:36:54

99% Occupied Bandwidth Plot on Channel 78

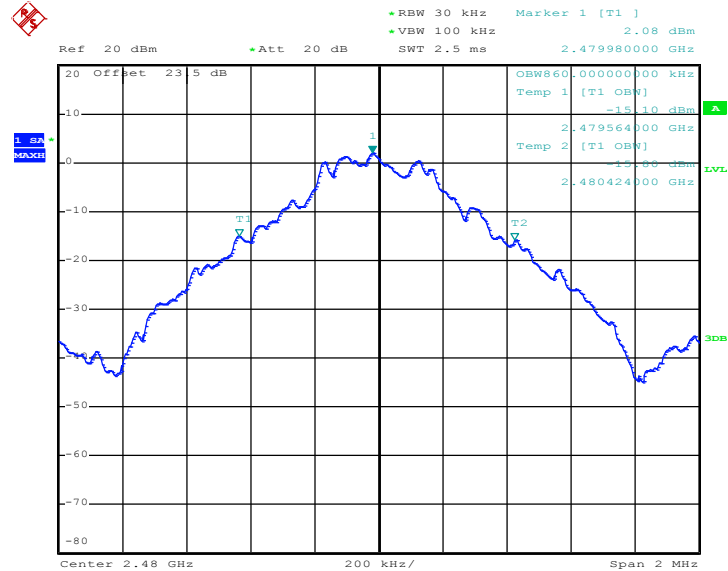

Date: 6.FEB.2016 16:40:19



Test Mode :	2Mbps	Temperature :	24~26°C
Test Engineer :	Osolemio Chang	Relative Humidity :	48~51%

Channel	Frequency (MHz)	99% Occupied Bandwidth (MHz)
00	2402	1.168
39	2441	1.172
78	2480	1.168

99% Occupied Bandwidth Plot on Channel 00

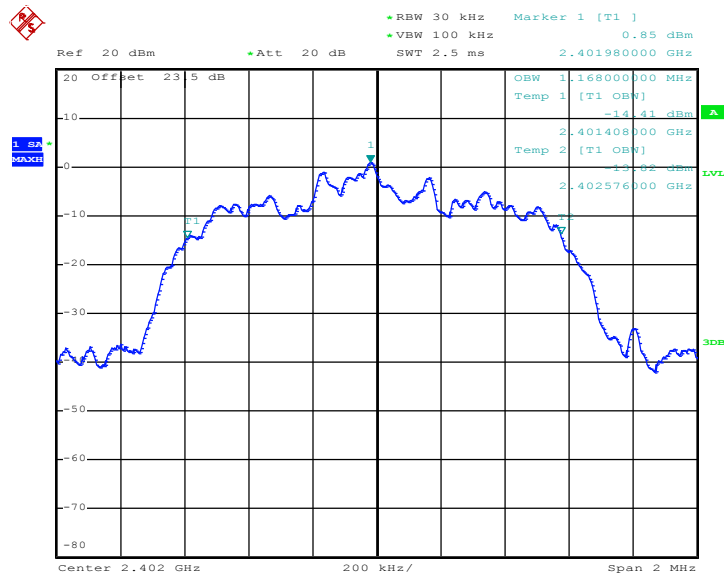

Date: 6.FEB.2016 16:45:56



99% Occupied Bandwidth Plot on Channel 39

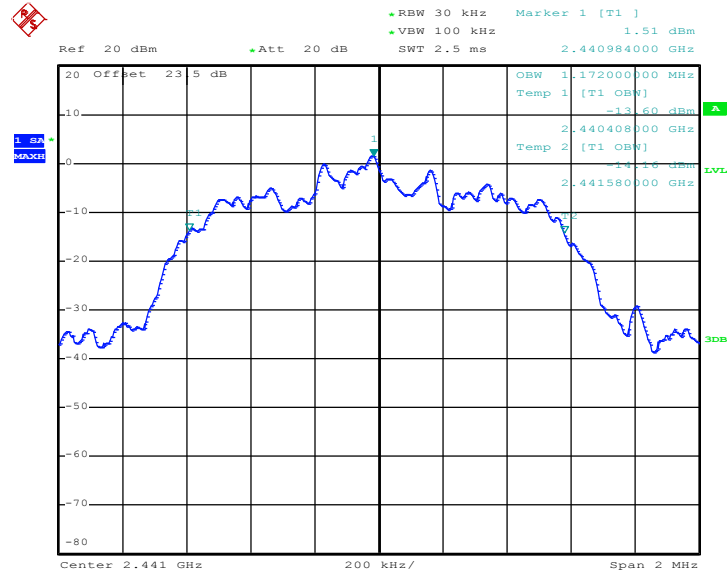

Date: 6.FEB.2016 16:50:58

99% Occupied Bandwidth Plot on Channel 78

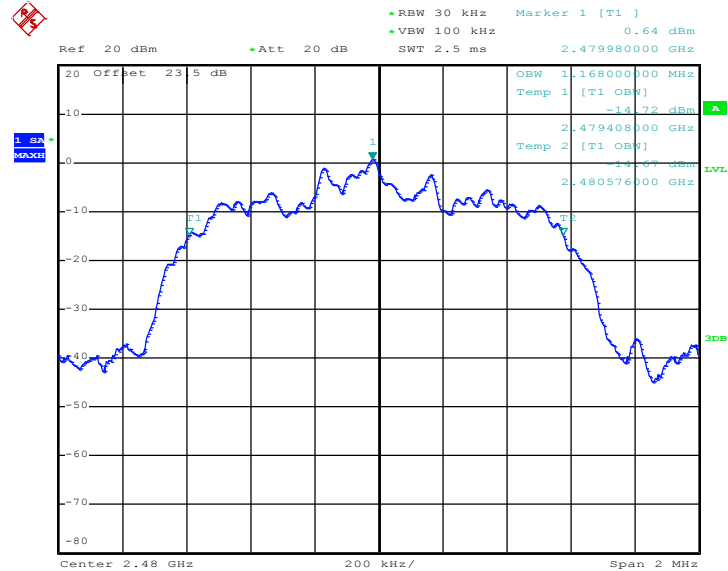

Date: 6.FEB.2016 16:55:58



Test Mode :	3Mbps	Temperature :	24~26°C
Test Engineer :	Osolemio Chang	Relative Humidity :	48~51%

Channel	Frequency (MHz)	99% Occupied Bandwidth (MHz)
00	2402	1.148
39	2441	1.160
78	2480	1.152

99% Occupied Bandwidth Plot on Channel 00

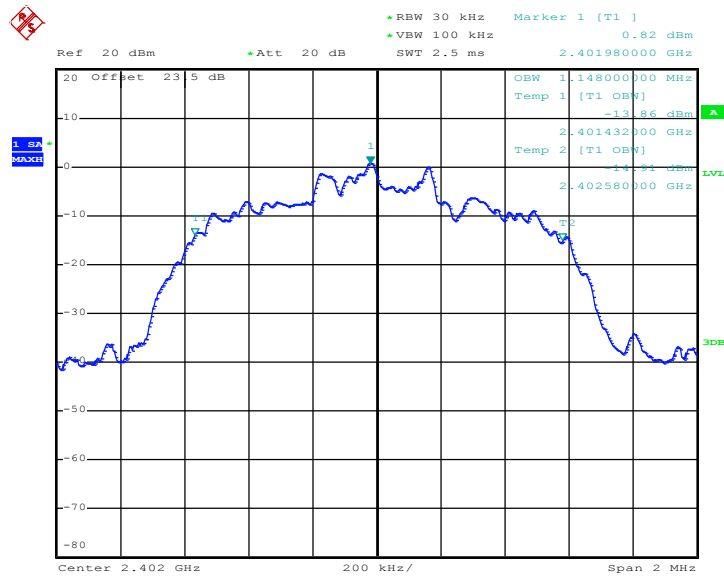

Date: 6.FEB.2016 17:10:04



99% Occupied Bandwidth Plot on Channel 39

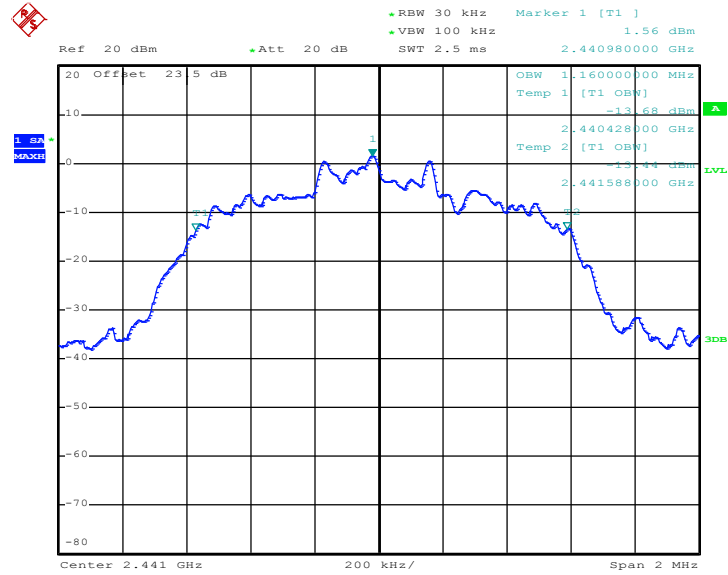

Date: 6.FEB.2016 17:14:58

99% Occupied Bandwidth Plot on Channel 78

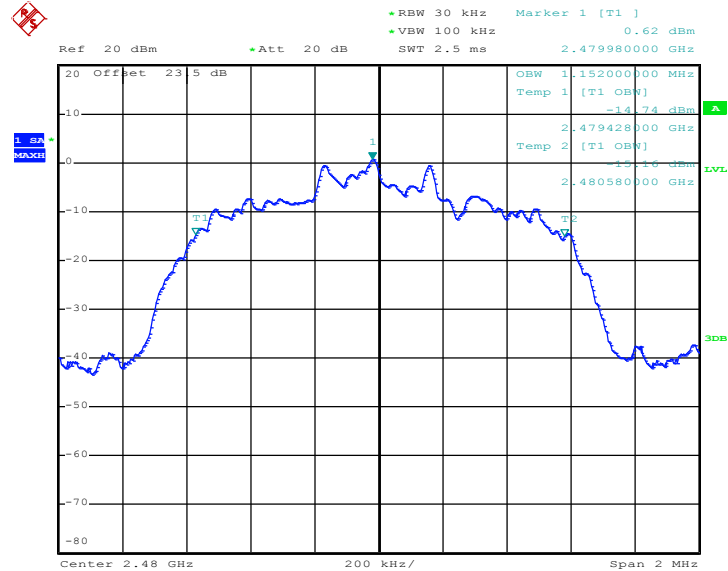

Date: 6.FEB.2016 17:18:19

Note: The occupied channel bandwidth is maintained within the band of operation for all of the modulations.

3.5 Peak Output Power Measurement

3.5.1 Limit of Peak Output Power

Section 15.247 (b) The maximum peak conducted output power of the intentional radiator shall not exceed the following: (1) For frequency hopping systems operating in the 2400-2483.5 MHz band employing at least 75 non-overlapping hopping channels, and all frequency hopping systems in the 5725-5850 MHz band: 1 watt. For all other frequency hopping systems in the 2400-2483.5 MHz band 0.125 watts. The power limit for 1Mbps is 1watt, and for 2Mbps, 3Mbps and AFH are 0.125 watts.

3.5.2 Measuring Instruments

The measuring equipment is listed in the section 4 of this test report.

3.5.3 Test Procedures

1. The testing follows ANSI C63.10-2013 clause 7.8.5.
2. The RF output of EUT was connected to the power meter by RF cable and attenuator. The path loss was compensated to the results for each measurement.
3. Set to the maximum power setting and enable the EUT transmit continuously.
4. Measure the conducted output power with cable loss and record the results in the test report.
5. Measure and record the results in the test report.

3.5.4 Test Setup

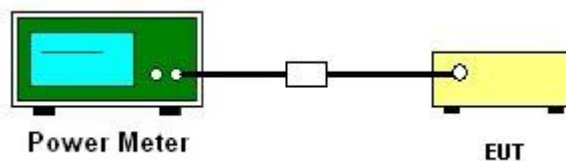



3.5.5 Test Result of Peak Output Power

Test Mode :	1Mbps	Temperature :	24~26°C
Test Engineer :	Osolemio Chang	Relative Humidity :	48~51%

Channel	Frequency (MHz)	RF Power (dBm)		
		GFSK	Max. Limits (dBm)	Pass/Fail
		1 Mbps		
00	2402	5.79	20.97	Pass
39	2441	6.05	20.97	Pass
78	2480	5.50	20.97	Pass

Note: For AFH mode using 20 hopping channels, the maximum output power limit is 20.97dBm.

Test Mode :	2Mbps	Temperature :	24~26°C
Test Engineer :	Osolemio Chang	Relative Humidity :	48~51%

Channel	Frequency (MHz)	RF Power (dBm)		
		$\pi/4$ -DQPSK	Max. Limits (dBm)	Pass/Fail
		2 Mbps		
00	2402	4.97	20.97	Pass
39	2441	5.37	20.97	Pass
78	2480	4.59	20.97	Pass

Test Mode :	3Mbps	Temperature :	24~26°C
Test Engineer :	Osolemio Chang	Relative Humidity :	48~51%

Channel	Frequency (MHz)	RF Power (dBm)		
		8-DPSK	Max. Limits (dBm)	Pass/Fail
		3 Mbps		
00	2402	5.10	20.97	Pass
39	2441	5.62	20.97	Pass
78	2480	4.80	20.97	Pass

3.6 Conducted Band Edges Measurement

3.6.1 Limit of Band Edges

In any 100 kHz bandwidth outside the intentional radiation frequency band, the radio frequency power shall be at least 20 dB below the highest level of the radiated power. In addition, radiated emissions which fall in the restricted bands must also comply with the radiated emission limits.

3.6.2 Measuring Instruments

The measuring equipment is listed in the section 4 of this test report.

3.6.3 Test Procedures

1. The testing follows ANSI C63.10-2013 clause 7.8.6.
2. Set to the maximum power setting and enable the EUT transmit continuously.
3. Set RBW = 100kHz, VBW = 300kHz. Band edge emissions must be at least 20 dB down from the highest emission level within the authorized band as measured with a 100kHz RBW. The attenuation shall be 30 dB instead of 20 dB when RMS conducted output power procedure is used.
4. Enable hopping function of the EUT and then repeat step 2. and 3.
5. Measure and record the results in the test report.

3.6.4 Test Setup

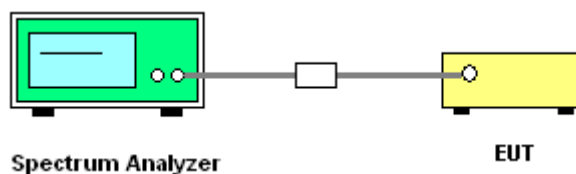



3.6.5 Test Result of Conducted Band Edges

Test Mode :	1Mbps	Temperature :	24~26°C
Test Channel :	00 and 78	Relative Humidity :	48~51%
		Test Engineer :	Osolemio Chang

Low Band Edge Plot on Channel 00

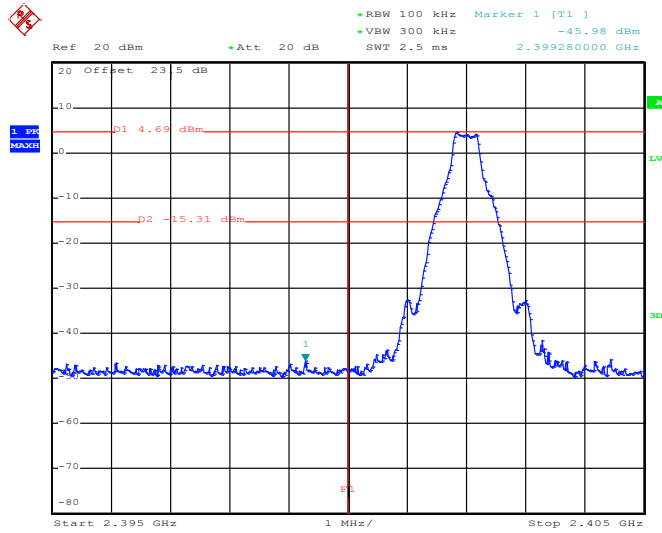

Date: 6.FEB.2016 17:44:49

High Band Edge Plot on Channel 78

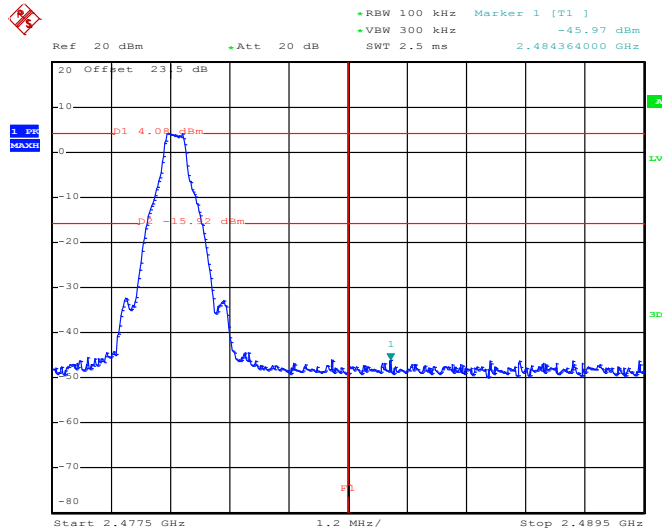

Date: 6.FEB.2016 17:45:17



Test Mode :	2Mbps	Temperature :	24~26°C
Test Channel :	00 and 78	Relative Humidity :	48~51%
		Test Engineer :	Osolemio Chang

Low Band Edge Plot on Channel 00

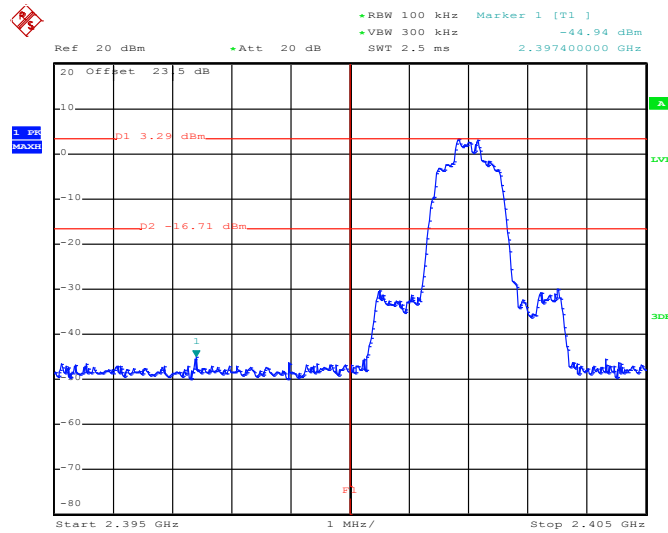

Date: 6.FEB.2016 17:45:47

High Band Edge Plot on Channel 78

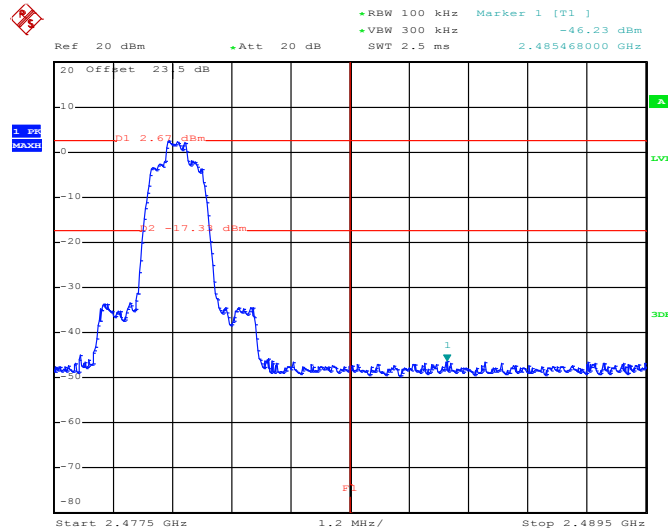

Date: 6.FEB.2016 17:46:11



Test Mode :	3Mbps	Temperature :	24~26°C
Test Channel :	00 and 78	Relative Humidity :	48~51%
		Test Engineer :	Osolemio Chang

Low Band Edge Plot on Channel 00

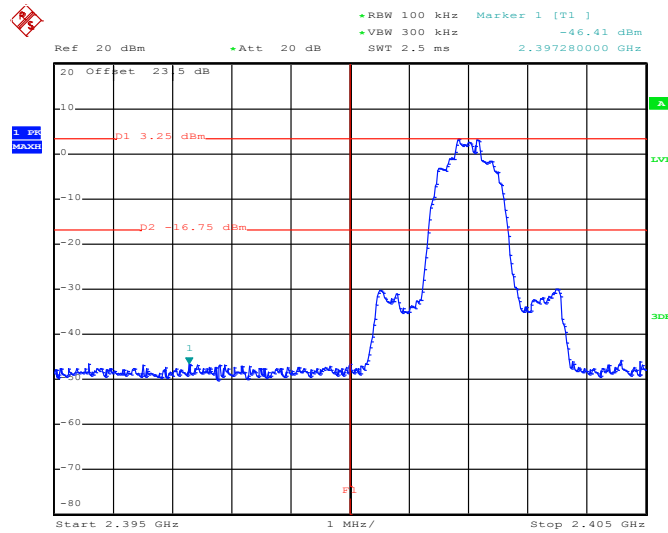

Date: 6.FEB.2016 17:46:39

High Band Edge Plot on Channel 78

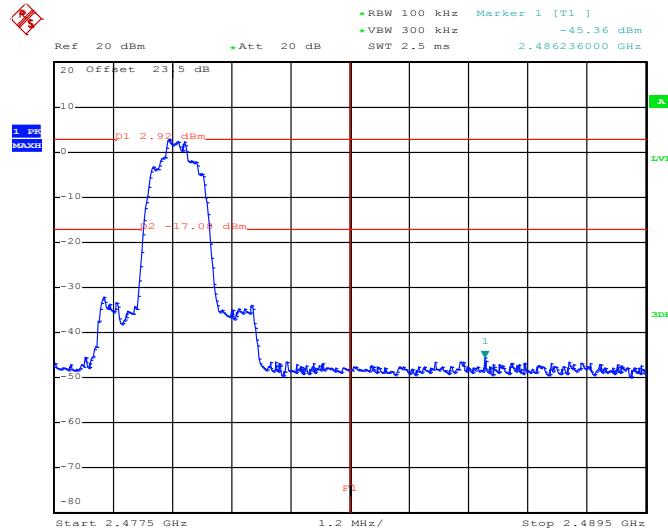

Date: 6.FEB.2016 17:47:42



3.6.6 Test Result of Conducted Hopping Mode Band Edges

Test Mode :	1Mbps	Temperature :	24~26°C
Test Engineer :	Osolemio Chang	Relative Humidity :	48~51%

1Mbps Hopping Mode Low Band Edge Plot

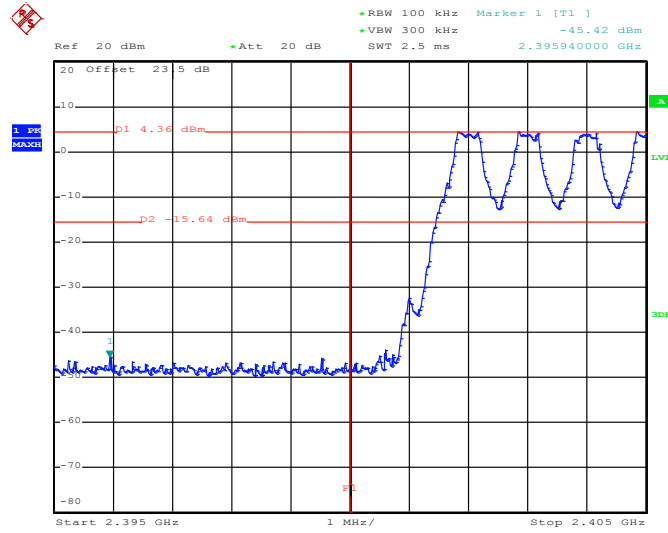

Date: 6.FEB.2016 17:39:27

1Mbps Hopping Mode High Band Edge Plot

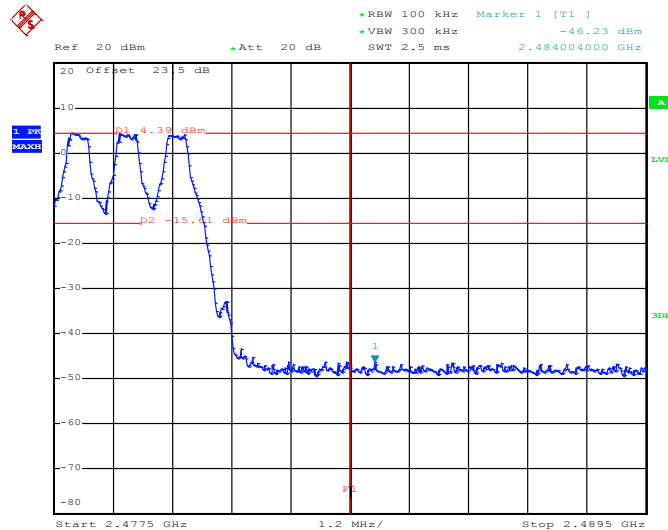

Date: 6.FEB.2016 17:39:57



Test Mode :	2Mbps	Temperature :	24~26°C
Test Engineer :	Osolemio Chang	Relative Humidity :	48~51%

2Mbps Hopping Mode Low Band Edge Plot

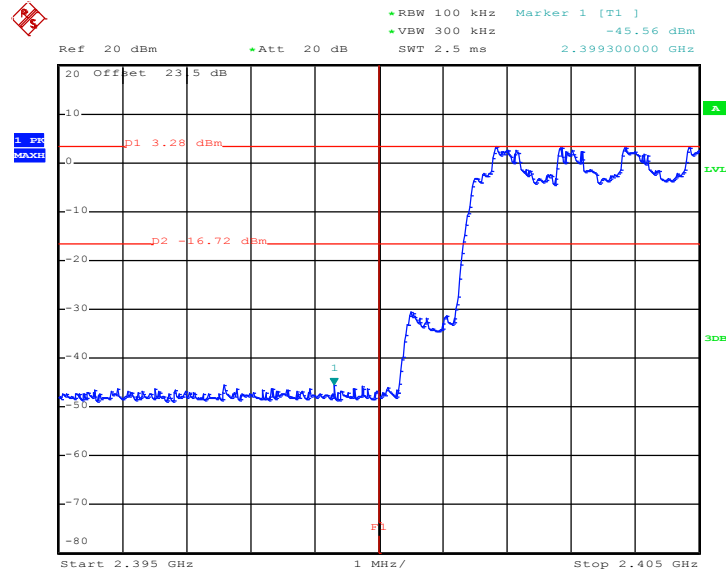

Date: 6.FEB.2016 17:41:01

2Mbps Hopping Mode High Band Edge Plot

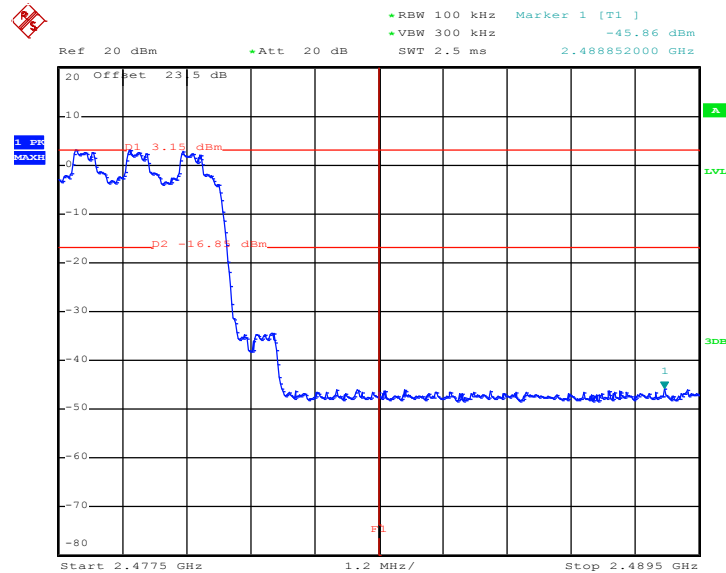

Date: 6.FEB.2016 17:42:21



Test Mode :	3Mbps	Temperature :	24~26°C
Test Engineer :	Osolemio Chang	Relative Humidity :	48~51%

3Mbps Hopping Mode Low Band Edge Plot

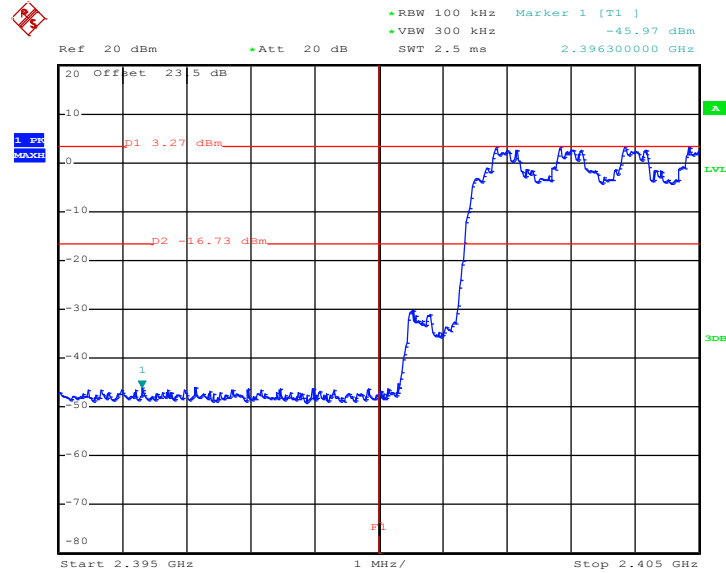

Date: 6.FEB.2016 17:43:11

3Mbps Hopping Mode High Band Edge Plot

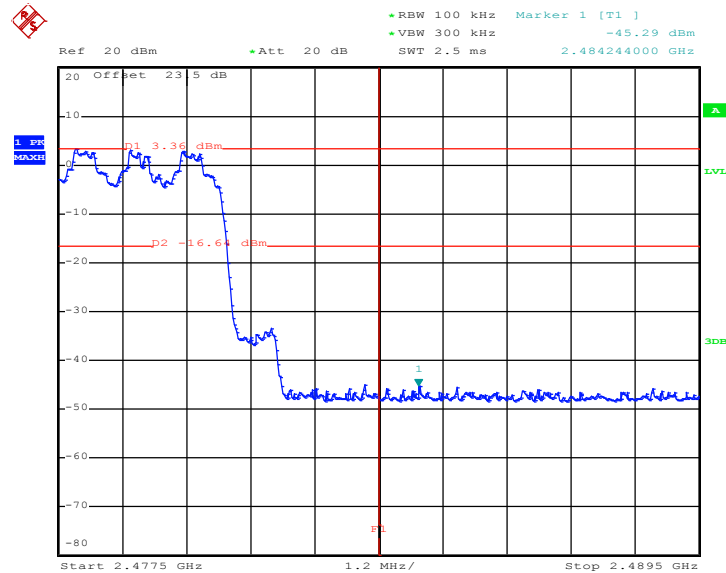

Date: 6.FEB.2016 17:44:20

3.7 Conducted Spurious Emission Measurement

3.7.1 Limit of Spurious Emission Measurement

In any 100 kHz bandwidth outside the intentional radiation frequency band, the radio frequency power shall be at least 20 dB below the highest level of the radiated power. In addition, radiated emissions which fall in the restricted bands must also comply with the radiated emission limits.

3.7.2 Measuring Instruments

The measuring equipment is listed in the section 4 of this test report.

3.7.3 Test Procedure

1. The testing follows ANSI C63.10-2013 clause 7.8.8.
2. The RF output of EUT was connected to the spectrum analyzer by RF cable and attenuator. The path loss was compensated to the results for each measurement.
3. Set to the maximum power setting and enable the EUT transmit continuously.
4. Set RBW = 100 kHz, VBW = 300kHz, scan up through 10th harmonic. All harmonics / spurs must be at least 20 dB down from the highest emission level within the authorized band as measured with a 100 kHz RBW.
5. Measure and record the results in the test report.
6. The RF fundamental frequency should be excluded against the limit line in the operating frequency band.

3.7.4 Test Setup

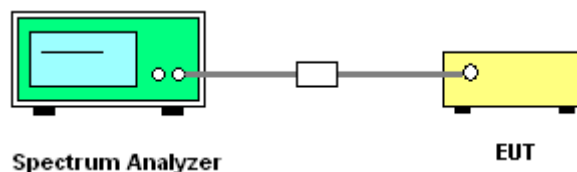



3.7.5 Test Result of Conducted Spurious Emission

Test Mode :	1Mbps	Temperature :	24~26°C
Test Channel :	00	Relative Humidity :	48~51%
		Test Engineer :	Osolemio Chang

1Mbps CSE Plot on Ch 00 between 30MHz ~ 3 GHz

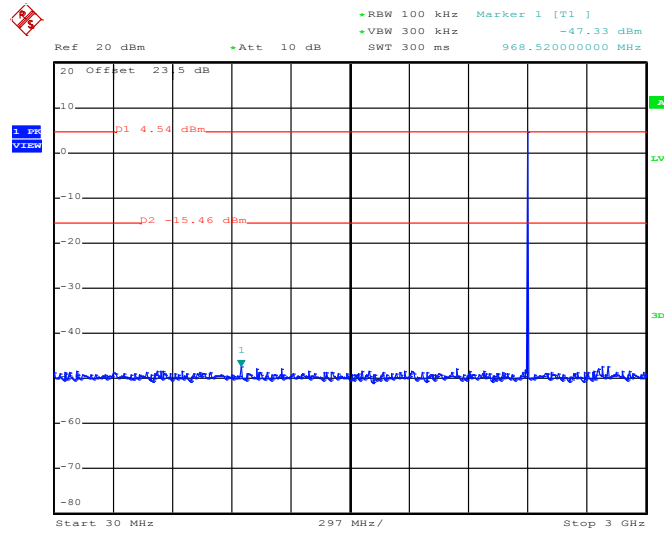

Date: 6.FEB.2016 16:43:39

1Mbps CSE Plot on Ch 00 between 2 GHz ~ 25 GHz

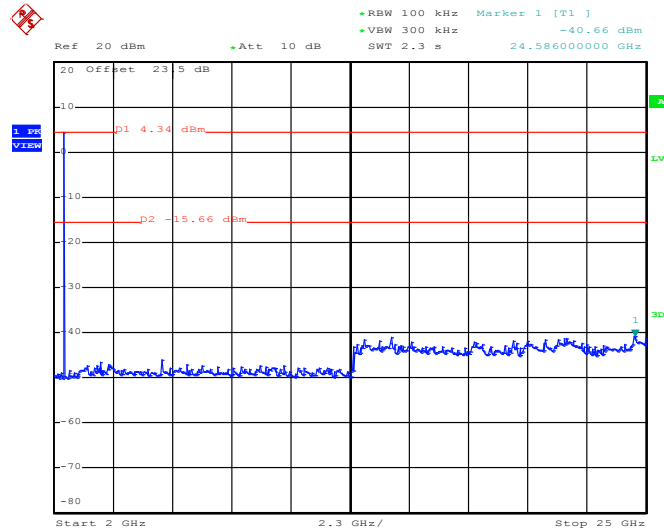

Date: 6.FEB.2016 16:44:01



Test Mode :	1Mbps	Temperature :	24~26°C
Test Channel :	39	Relative Humidity :	48~51%
		Test Engineer :	Osolemio Chang

1Mbps CSE Plot on Ch 39 between 30MHz ~ 3 GHz

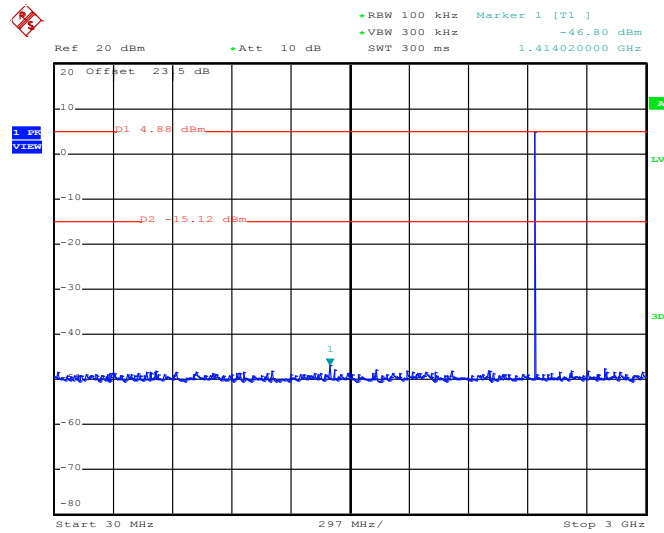

Date: 6.FEB.2016 16:42:35

1Mbps CSE Plot on Ch 39 between 2 GHz ~ 25 GHz

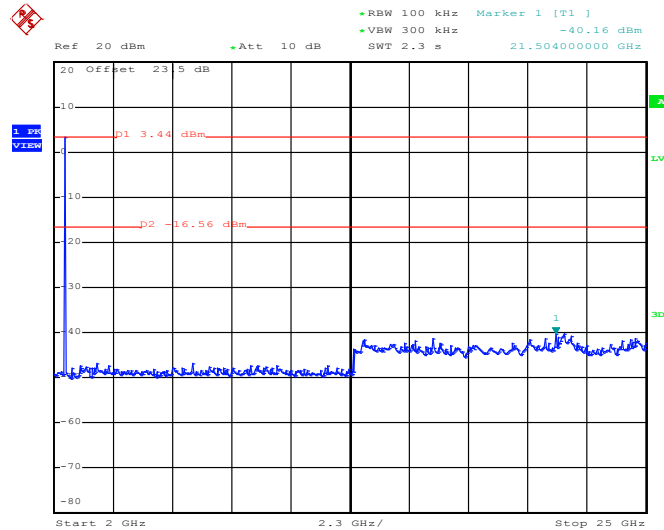

Date: 6.FEB.2016 16:42:57



Test Mode :	1Mbps	Temperature :	24~26°C
Test Channel :	78	Relative Humidity :	48~51%
		Test Engineer :	Osolemio Chang

1Mbps CSE Plot on Ch 78 between 30MHz ~ 3 GHz

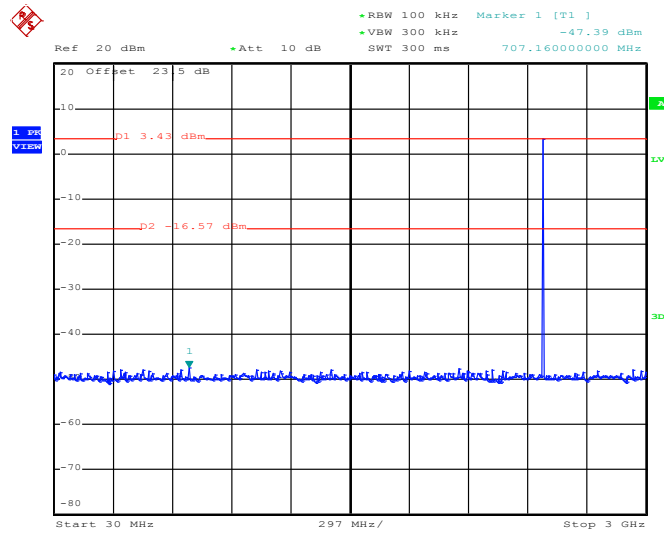

Date: 6.FEB.2016 16:41:19

1Mbps CSE Plot on Ch 78 between 2 GHz ~ 25 GHz

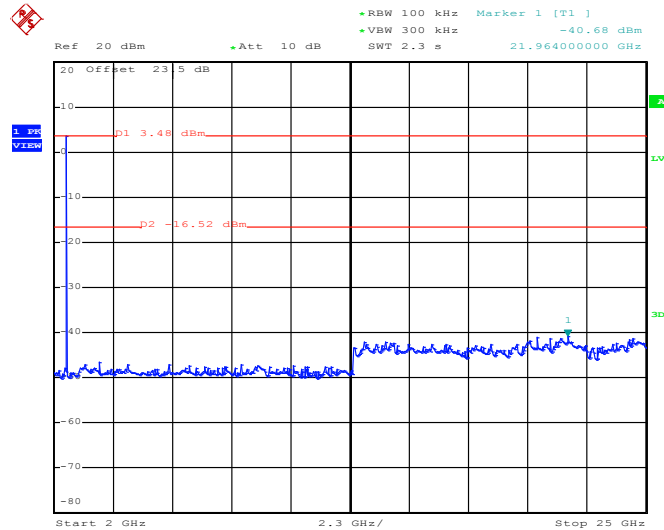

Date: 6.FEB.2016 16:41:40



Test Mode :	2Mbps	Temperature :	24~26°C
Test Channel :	00	Relative Humidity :	48~51%
		Test Engineer :	Osolemio Chang

2Mbps CSE Plot on Ch 00 between 30MHz ~ 3 GHz

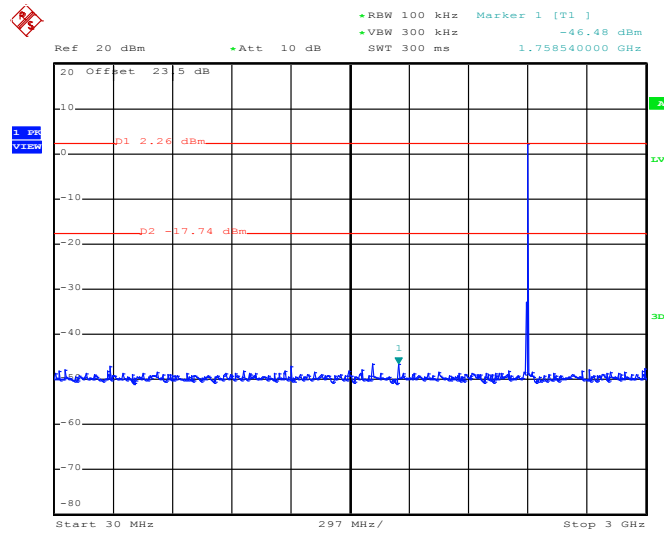

Date: 6.FEB.2016 16:48:09

2Mbps CSE Plot on Ch 00 between 2 GHz ~ 25 GHz

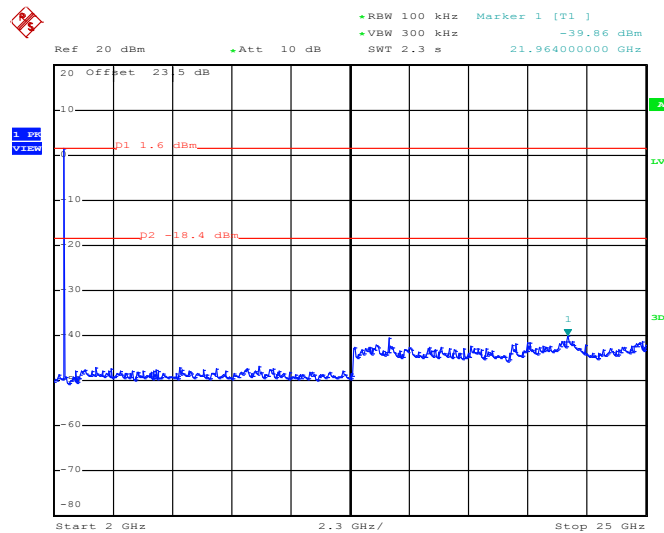

Date: 6.FEB.2016 16:48:31



Test Mode :	2Mbps	Temperature :	24~26°C
Test Channel :	39	Relative Humidity :	48~51%
		Test Engineer :	Osolemio Chang

2Mbps CSE Plot on Ch 39 between 30MHz ~ 3 GHz

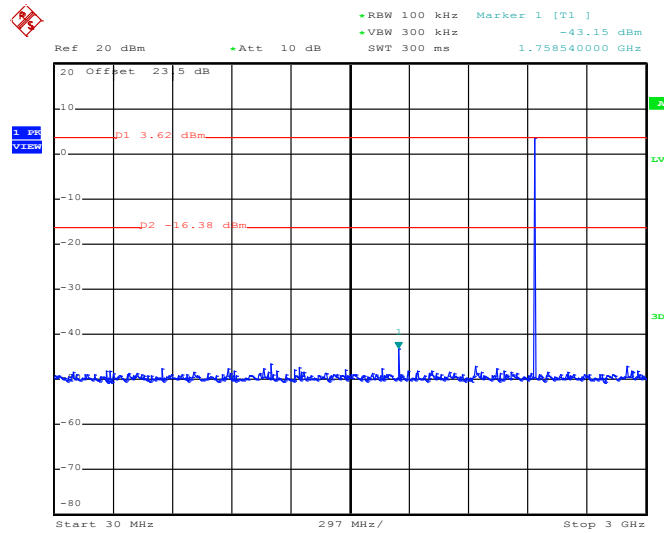

Date: 6.FEB.2016 16:53:49

2Mbps CSE Plot on Ch 39 between 2 GHz ~ 25 GHz

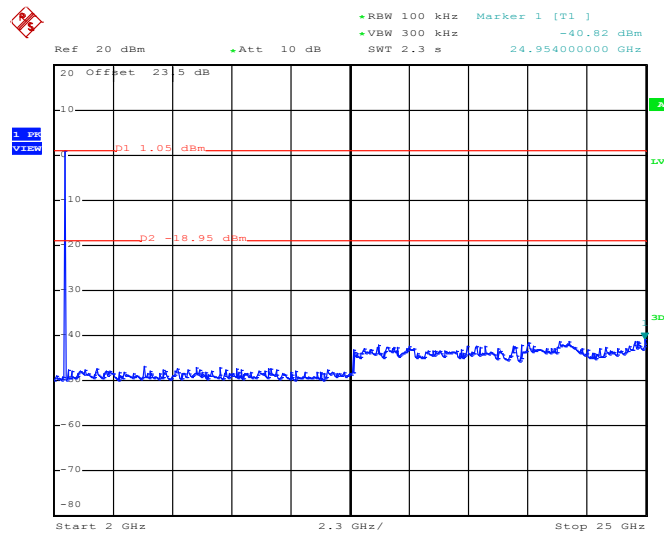

Date: 6.FEB.2016 16:54:11



Test Mode :	2Mbps	Temperature :	24~26°C
Test Channel :	78	Relative Humidity :	48~51%
		Test Engineer :	Osolemio Chang

2Mbps CSE Plot on Ch 78 between 30MHz ~ 3 GHz

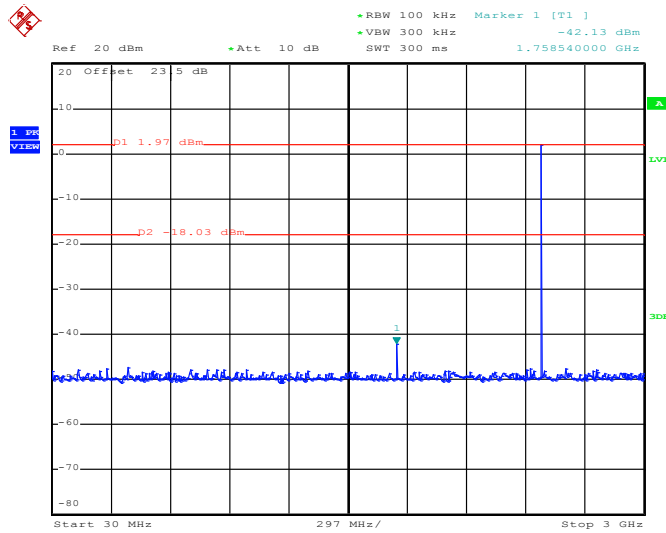

Date: 6.FEB.2016 17:00:46

2Mbps CSE Plot on Ch 78 between 2 GHz ~ 25 GHz

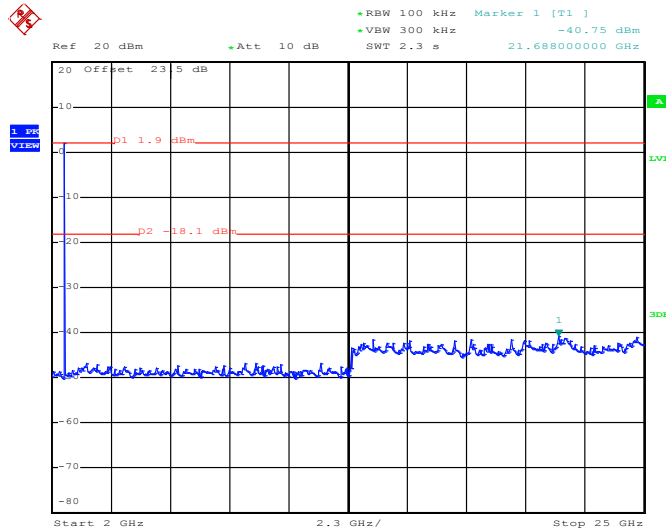

Date: 6.FEB.2016 17:01:07



Test Mode :	3Mbps	Temperature :	24~26°C
Test Channel :	00	Relative Humidity :	48~51%
		Test Engineer :	Osolemio Chang

3Mbps CSE Plot on Ch 00 between 30MHz ~ 3 GHz

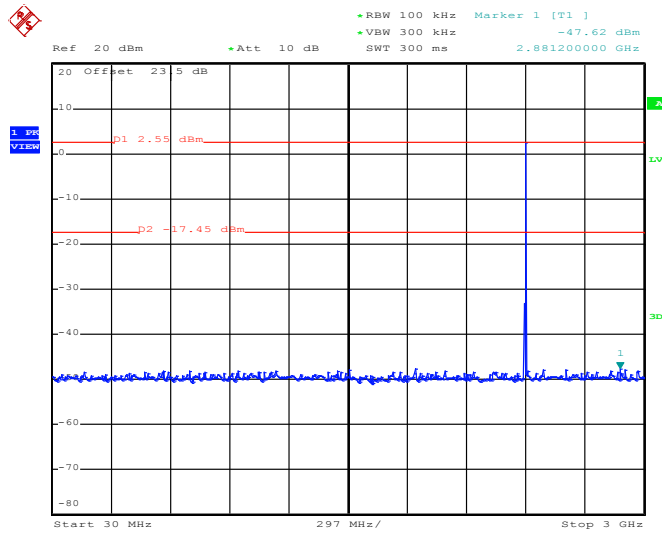

Date: 6.FEB.2016 17:12:26

3Mbps CSE Plot on Ch 00 between 2 GHz ~ 25 GHz

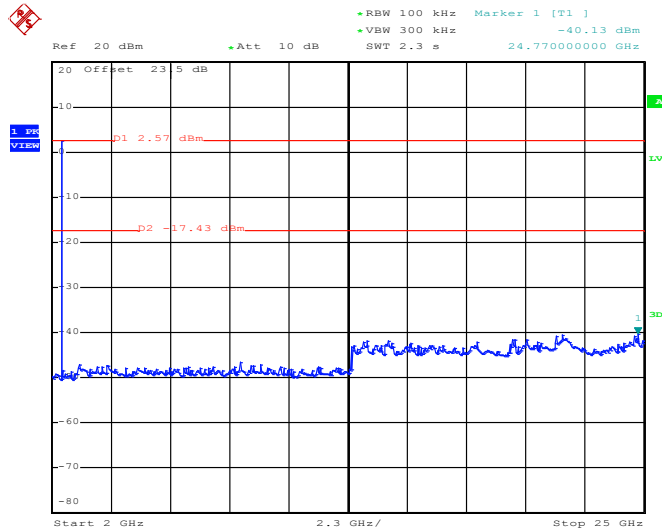

Date: 6.FEB.2016 17:12:48



Test Mode :	3Mbps	Temperature :	24~26°C
Test Channel :	39	Relative Humidity :	48~51%
		Test Engineer :	Osolemio Chang

3Mbps CSE Plot on Ch 39 between 30MHz ~ 3 GHz

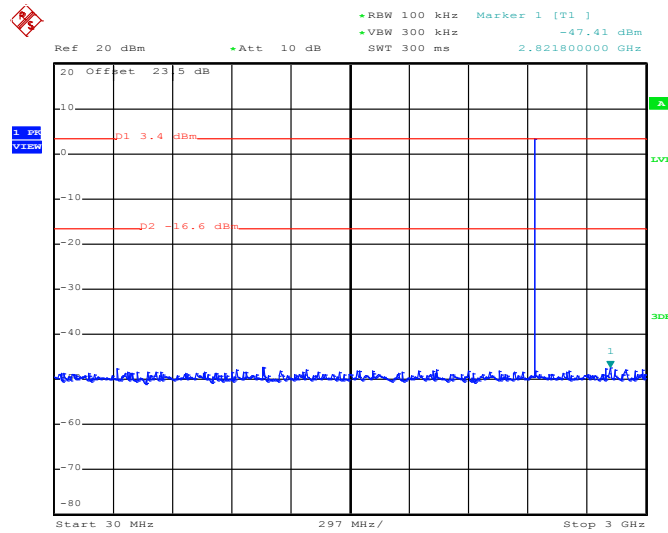

Date: 6.FEB.2016 17:15:39

3Mbps CSE Plot on Ch 39 between 2 GHz ~ 25 GHz

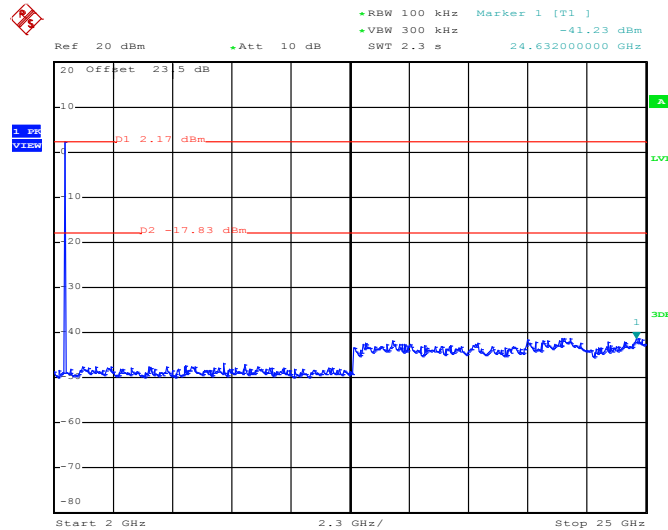

Date: 6.FEB.2016 17:16:01



Test Mode :	3Mbps	Temperature :	24~26°C
Test Channel :	78	Relative Humidity :	48~51%
		Test Engineer :	Osolemio Chang

3Mbps CSE Plot on Ch 78 between 30MHz ~ 3 GHz

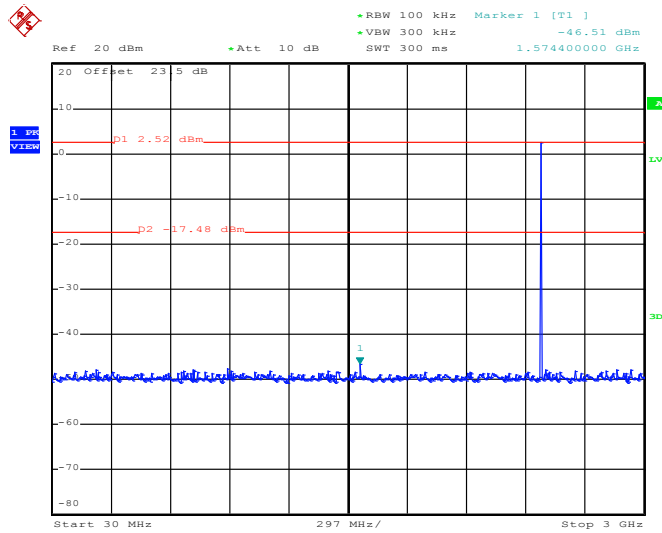

Date: 6.FEB.2016 17:21:30

3Mbps CSE Plot on Ch 78 between 2 GHz ~ 25 GHz

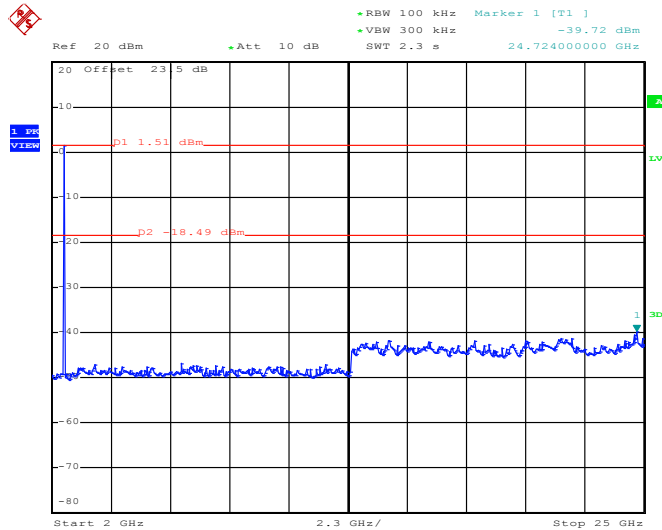

Date: 6.FEB.2016 17:21:52



3.8 Radiated Band Edges and Spurious Emission Measurement

3.8.1 Limit of Radiated Band Edges and Spurious Emission

In any 100 kHz bandwidth outside the intentional radiator frequency band, all harmonics/spurious must be at least 20 dB below the highest emission level within the authorized band. In addition, radiated emissions which fall in the restricted bands must also comply with the FCC section 15.209 limits as below.

Frequency (MHz)	Field Strength (microvolts/meter)	Measurement Distance (meters)
0.009 – 0.490	2400/F(kHz)	300
0.490 – 1.705	24000/F(kHz)	30
1.705 – 30.0	30	30
30 – 88	100	3
88 – 216	150	3
216 - 960	200	3
Above 960	500	3

3.8.2 Measuring Instruments

The measuring equipment is listed in the section 4 of this test report.



3.8.3 Test Procedures

1. The EUT was placed on a turntable with 0.8 meter for frequency below 1GHz and 1.5 meter for frequency above 1GHz respectively above ground.
2. The EUT was set 3 meters from the interference receiving antenna, which was mounted on the top of a variable height antenna tower.
3. For each suspected emission, the EUT was arranged to its worst case and then tune the Antenna tower (from 1 m to 4 m) and turntable (from 0 degree to 360 degrees) to find the maximum reading. A pre-amp and a high pass filter are used for the test in order to get better signal level to comply with the guidelines.
4. Set to the maximum power setting and enable the EUT transmit continuously.
5. Use the following spectrum analyzer settings:
 - (1) Span shall wide enough to fully capture the emission being measured;
 - (2) Set RBW=100 kHz for $f < 1 \text{ GHz}$, RBW=1MHz for $f > 1\text{GHz}$; VBW \geq RBW; Sweep = auto; Detector function = peak; Trace = max hold for peak
 - (3) For average measurement: use duty cycle correction factor method per 15.35(c).
Duty cycle = On time/100 milliseconds
On time = $N_1 * L_1 + N_2 * L_2 + \dots + N_{n-1} * L_{n-1} + N_n * L_n$
Where N_1 is number of type 1 pulses, L_1 is length of type 1 pulses, etc.
Average Emission Level = Peak Emission Level + $20 * \log(\text{Duty cycle})$
6. Corrected Reading: Antenna Factor + Cable Loss + Read Level - Preamp Factor = Level

Note: The average levels were calculated from the peak level corrected with duty cycle correction factor (24.82dB) derived from $20 \log (\text{dwell time}/100\text{ms})$. This correction is only for signals that hop with the fundamental signal, such as band-edge and harmonic. Other spurious signals that are independent of the hopping signal would not use this correction.

3.8.4 Test Setup

For radiated emissions below 30MHz

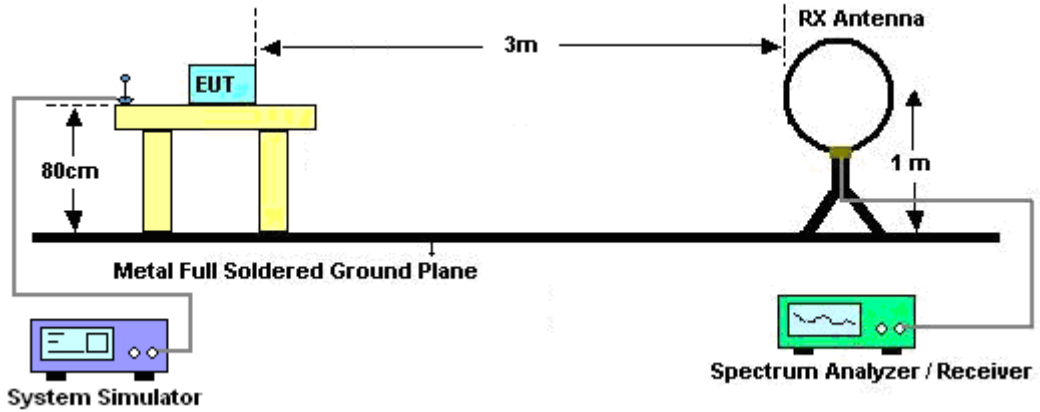

For radiated emissions from 30MHz to 1GHz

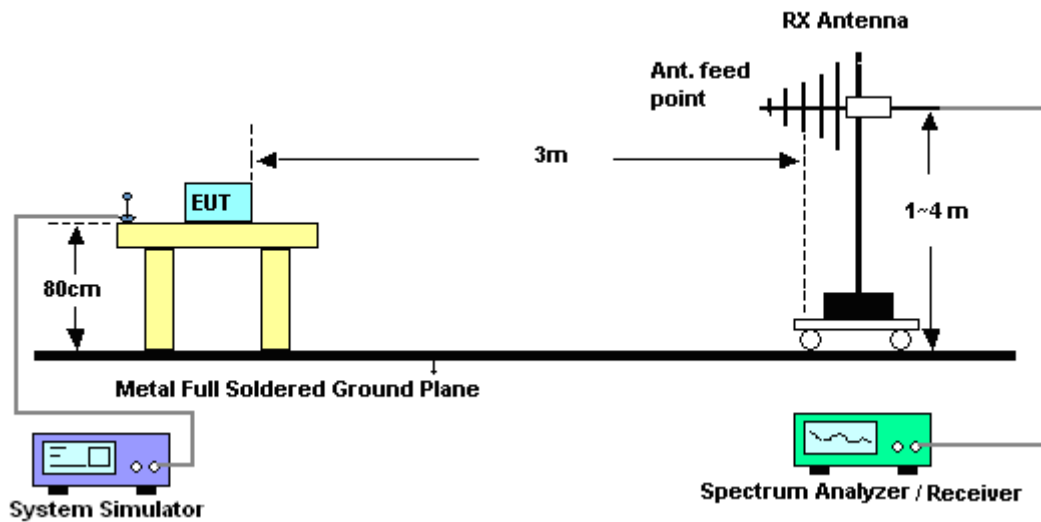

For radiated emissions above 1GHz

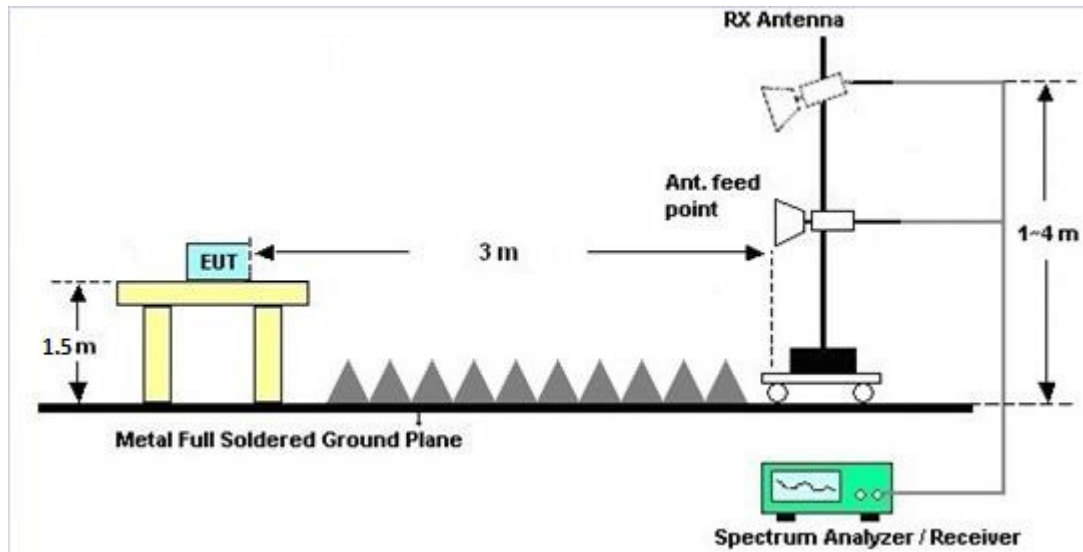

3.8.5 Test Results of Radiated Spurious Emissions (9 kHz ~ 30 MHz)

The low frequency, which started from 9 kHz to 30MHz, was pre-scanned and the result which was 20dB lower than the limit line per 15.31(o) was not reported.



3.8.6 Duty cycle correction factor for average measurement

<1Mbps>

DH5 on time (One Pulse) Plot on Channel 39

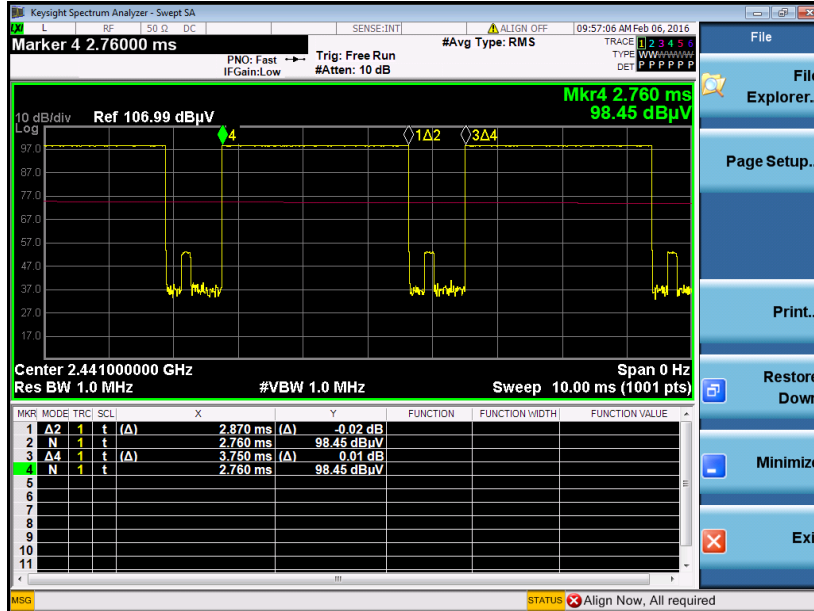

DH5 on time (Count Pulses) Plot on Channel 39

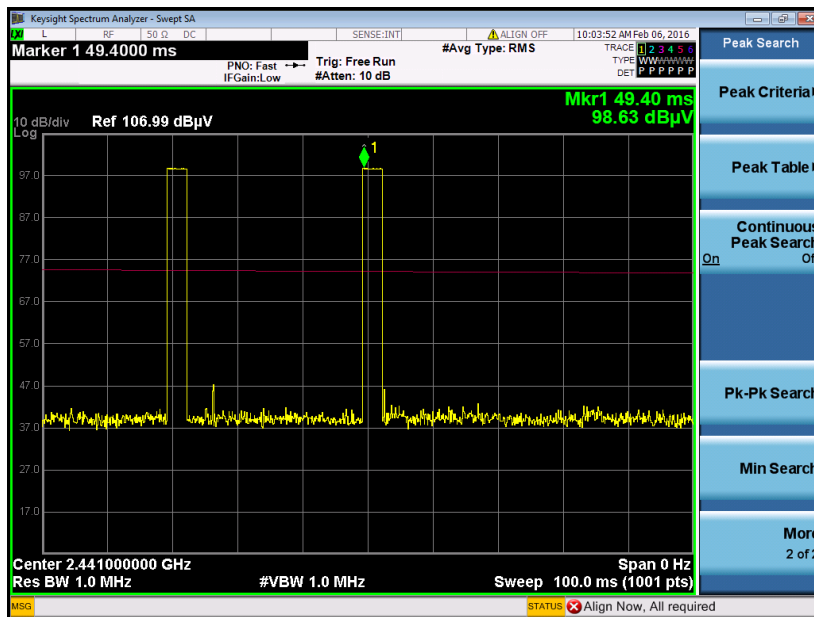

Note:

1. Worst case Duty cycle = on time/100 milliseconds = $2 * 2.87 / 100 = 5.74 \%$
2. Worst case Duty cycle correction factor = $20 * \log(\text{Duty cycle}) = -24.82 \text{ dB}$
3. DH5 has the highest duty cycle worst case and is reported.



<2Mbps>

2DH5 on time (One Pulse) Plot on Channel 39

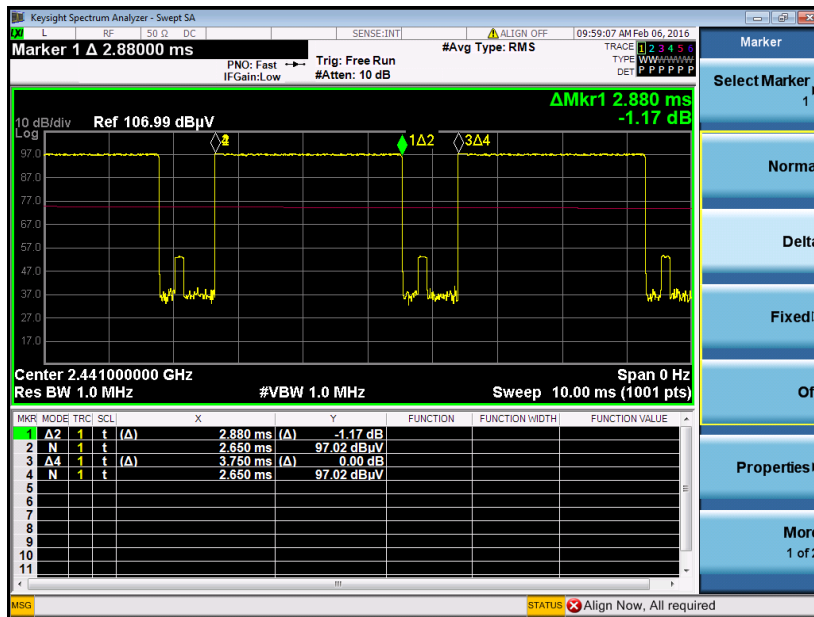

2DH5 on time (Count Pulses) Plot on Channel 39

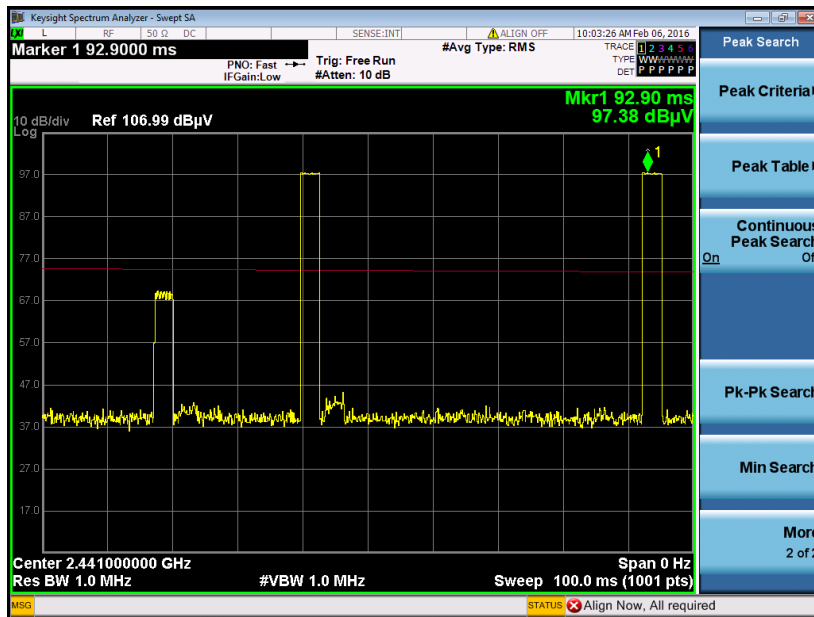

Note:

1. Worst case Duty cycle = on time/100 milliseconds = 2 * 2.88 / 100 = 5.76 %
2. Worst case Duty cycle correction factor = 20*log(Duty cycle) = -24.79 dB
3. DH5 has the highest duty cycle worst case and is reported.



<3Mbps>

3DH5 on time (One Pulse) Plot on Channel 39

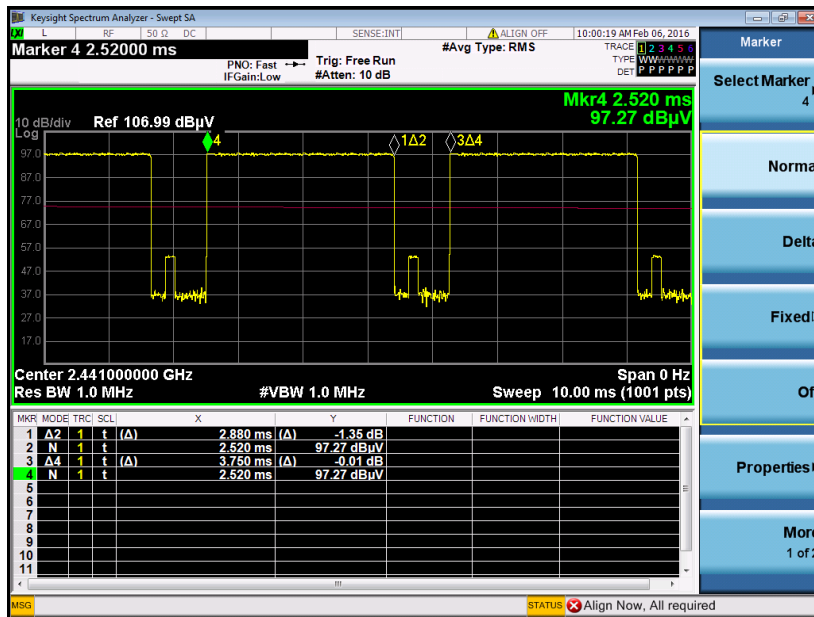

3DH5 on time (Count Pulses) Plot on Channel 39

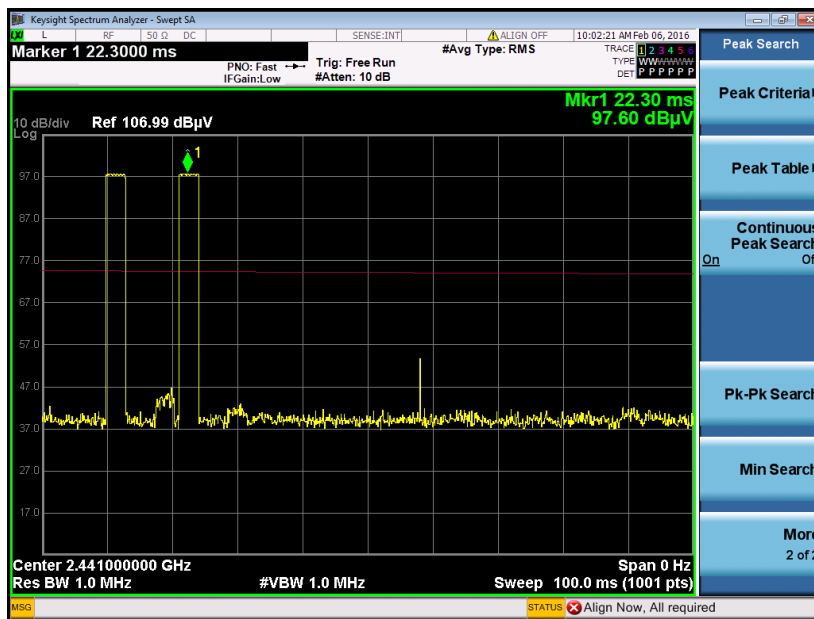

Note:

1. Worst case Duty cycle = on time/100 milliseconds = 2 * 2.88 / 100 = 5.76 %
2. Worst case Duty cycle correction factor = 20*log(Duty cycle) = -24.79 dB
3. DH5 has the highest duty cycle worst case and is reported.



Duty Cycle Correction Factor Consideration for AFH mode:

Bluetooth normal hopping rate is 1600Hz and reduced to 800Hz in AFH mode; due to the reduced number of hopping frequencies, with the same packet configuration the dwell time in each channel frequency within 100msec period is longer in AFH mode than normal mode.

In AFH mode, the minimum hopping frequencies are 20, to get the longest dwell time DH5 packet is observed; the period to have DH5 packet completing one hopping sequence is

$$2.88 \text{ ms} \times 20 \text{ channels} = 57.6 \text{ ms}$$

There cannot be 2 complete hopping sequences within 100ms period, considering the random hopping behavior, maximum 2 hops can be possibly observed within the period. $[100\text{ms} / 57.6\text{ms}] = 2 \text{ hops}$

Thus, the maximum possible ON time:

$$2.88 \text{ ms} \times 2 = 5.76 \text{ ms}$$

Worst case Duty Cycle Correction factor, which is derived from the maximum possible ON time,

$$20 \times \log(5.76 \text{ ms}/100\text{ms}) = -24.79 \text{ dB}$$

3.8.7 Test Result of Radiated Spurious at Band Edges

Please refer to Appendix A and B.

3.8.8 Test Result of Radiated Spurious Emission (30MHz ~ 10th Harmonic)

Please refer to Appendix A and B.



3.9 AC Conducted Emission Measurement

3.9.1 Limit of AC Conducted Emission

For equipment that is designed to be connected to the public utility (AC) power line, the radio frequency voltage that is conducted back onto the AC power line on any frequency or frequencies within the band 150 kHz to 30 MHz shall not exceed the limits in the following table.

Frequency of emission (MHz)	Conducted limit (dBµV)	
	Quasi-peak	Average
0.15-0.5	66 to 56*	56 to 46*
0.5-5	56	46
5-30	60	50

*Decreases with the logarithm of the frequency.

3.9.2 Measuring Instruments

The measuring equipment is listed in the section 4 of this test report.

3.9.3 Test Procedures

1. The EUT was placed 0.4 meter from the conducting wall of the shielding room was kept at least 80 centimeters from any other grounded conducting surface.
2. Connect EUT to the power mains through a line impedance stabilization network (LISN).
3. All the support units are connecting to the other LISN.
4. The LISN provides 50 ohm coupling impedance for the measuring instrument.
5. The FCC states that a 50 ohm, 50 microhenry LISN should be used.
6. Both sides of AC line were checked for maximum conducted interference.
7. The frequency range from 150 kHz to 30 MHz was searched.
8. Set the test-receiver system to Peak Detect Function and specified bandwidth (IF Bandwidth = 9kHz) with Maximum Hold Mode. Then measurement is also conducted by Average Detector and Quasi-Peak Detector Function respectively.

3.9.4 Test Setup

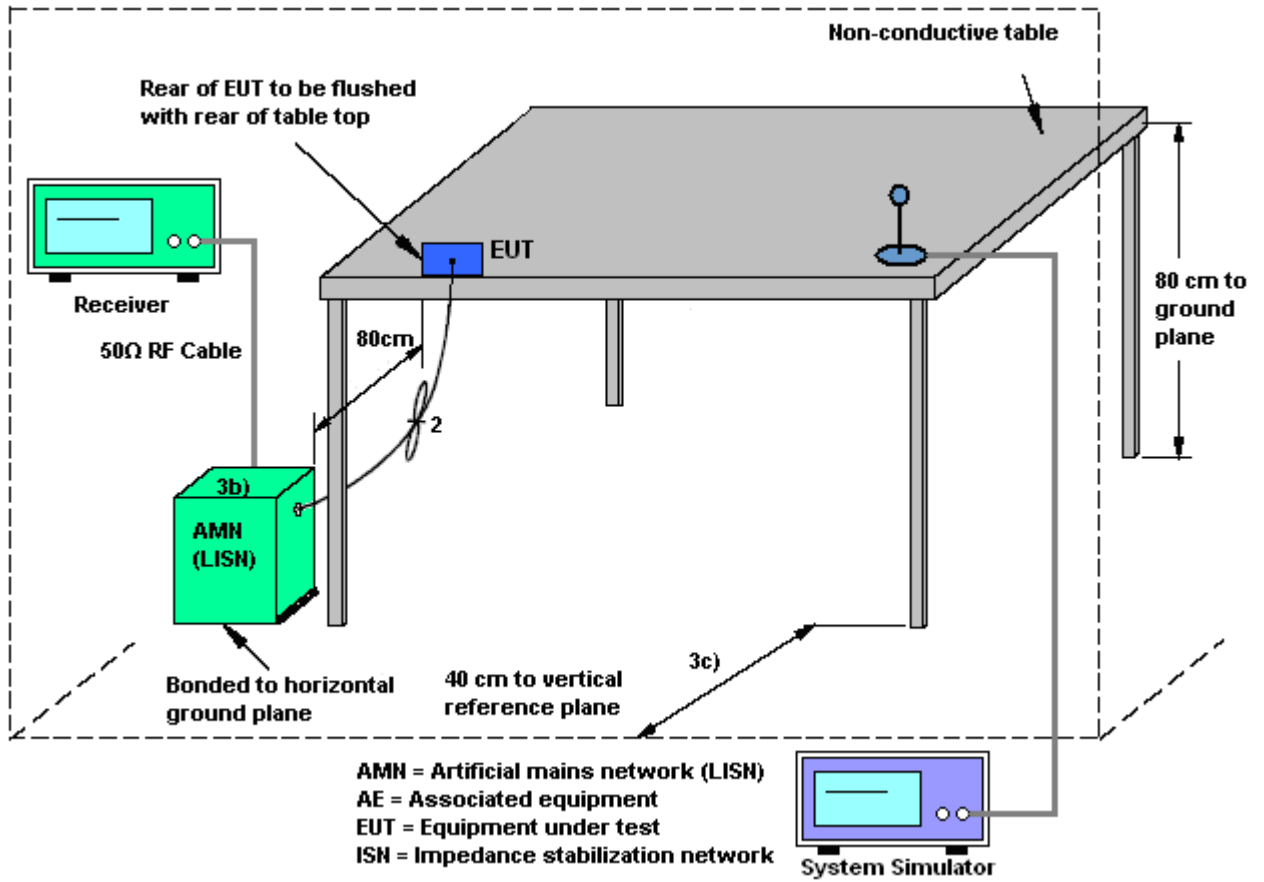

3.9.5 Test Result of AC Conducted Emission

Test Mode :	Mode 1	Temperature :	24~25°C
Test Engineer :	Kai-Chun Chu	Relative Humidity :	47~48%
Test Voltage :	120Vac / 60Hz	Phase :	Line
Function Type :	GSM1900 Idle + Bluetooth Link + WLAN (2.4GHz) Link + MP3 + Earphone + Battery 2 + USB Cable (Charging from Adapter)		

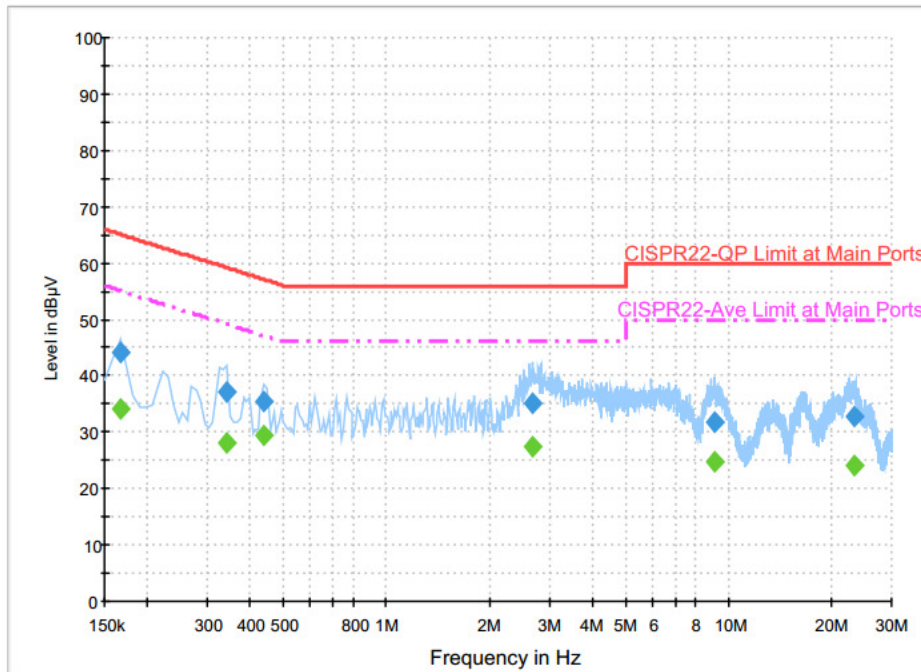

Final Result : Quasi-Peak

Frequency (MHz)	Quasi-Peak (dBμV)	Filter	Line	Corr. (dB)	Margin (dB)	Limit (dBμV)
0.166000	44.1	Off	L1	19.6	21.1	65.2
0.342000	37.2	Off	L1	19.6	22.0	59.2
0.438000	35.4	Off	L1	19.6	21.7	57.1
2.678000	35.2	Off	L1	19.4	20.8	56.0
9.174000	31.7	Off	L1	19.7	28.3	60.0
23.438000	32.8	Off	L1	19.9	27.2	60.0

Final Result : Average

Frequency (MHz)	Average (dBμV)	Filter	Line	Corr. (dB)	Margin (dB)	Limit (dBμV)
0.166000	34.2	Off	L1	19.6	21.0	55.2
0.342000	28.2	Off	L1	19.6	21.0	49.2
0.438000	29.4	Off	L1	19.6	17.7	47.1
2.678000	27.3	Off	L1	19.4	18.7	46.0
9.174000	24.8	Off	L1	19.7	25.2	50.0
23.438000	24.2	Off	L1	19.9	25.8	50.0



Test Mode :	Mode 1	Temperature :	24~25°C
Test Engineer :	Kai-Chun Chu	Relative Humidity :	47~48%
Test Voltage :	120Vac / 60Hz	Phase :	Neutral
Function Type :	GSM1900 Idle + Bluetooth Link + WLAN (2.4GHz) Link + MP3 + Earphone + Battery 2 + USB Cable (Charging from Adapter)		

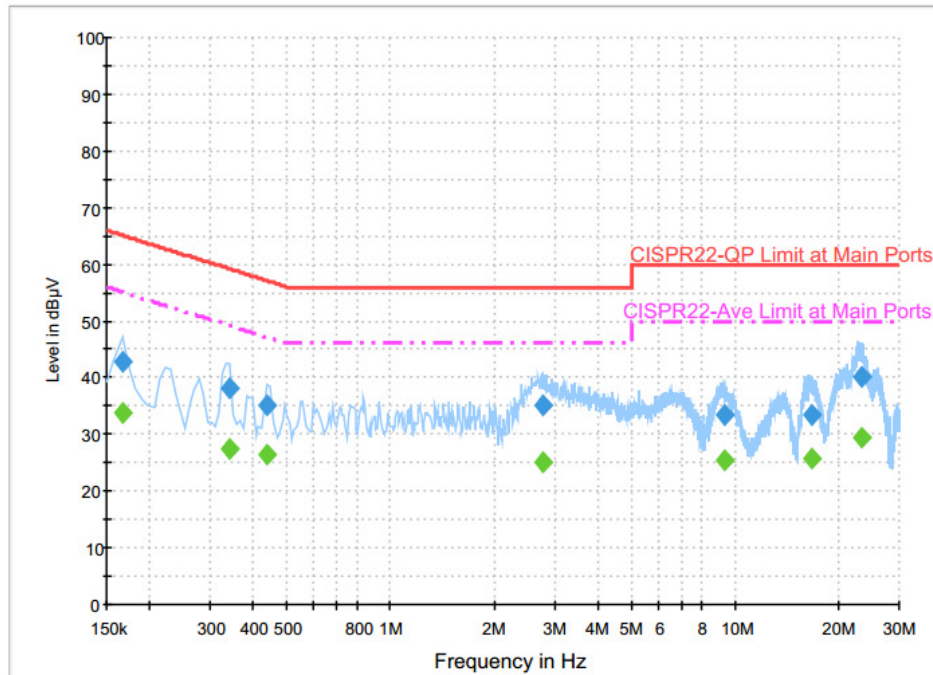

Final Result : Quasi-Peak

Frequency (MHz)	Quasi-Peak (dBµV)	Filter	Line	Corr. (dB)	Margin (dB)	Limit (dBµV)
0.166000	43.0	Off	N	19.6	22.2	65.2
0.342000	38.2	Off	N	19.6	21.0	59.2
0.438000	35.2	Off	N	19.6	21.9	57.1
2.758000	35.2	Off	N	19.5	20.8	56.0
9.286000	33.4	Off	N	19.8	26.6	60.0
16.774000	33.5	Off	N	19.9	26.5	60.0
23.262000	40.0	Off	N	20.0	20.0	60.0

Final Result : Average

Frequency (MHz)	Average (dBµV)	Filter	Line	Corr. (dB)	Margin (dB)	Limit (dBµV)
0.166000	33.7	Off	N	19.6	21.5	55.2
0.342000	27.5	Off	N	19.6	21.7	49.2
0.438000	26.4	Off	N	19.6	20.7	47.1
2.758000	25.1	Off	N	19.5	20.9	46.0
9.286000	25.3	Off	N	19.8	24.7	50.0
16.774000	25.7	Off	N	19.9	24.3	50.0
23.262000	29.3	Off	N	20.0	20.7	50.0



3.10 Antenna Requirements

3.10.1 Standard Applicable

If directional gain of transmitting antennas is greater than 6dBi, the power shall be reduced by the same level in dB comparing to gain minus 6dBi. The use of a permanently attached antenna or of an antenna that uses a unique coupling to the intentional radiator shall be considered sufficient to comply with the FCC rule.

3.10.2 Antenna Anti-Replacement Construction

An embedded-in antenna design is used.

3.10.3 Antenna Gain

The antenna peak gain of EUT is less than 6 dBi. Therefore, it is not necessary to reduce maximum peak output power limit.



4 List of Measuring Equipment

Instrument	Manufacturer	Model No.	Serial No.	Characteristics	Calibration Date	Test Date	Due Date	Remark
Power Meter	Agilent	E4416A	GB412923 44	300MHz~40GHz	Jan. 08, 2016	Feb. 05, 2016 ~ Feb. 06, 2016	Jan. 07, 2017	Conducted (TH05-HY)
Power Sensor	Agilent	E9327A	US404415 48	300MHz~40GHz	Jan. 07, 2016	Feb. 05, 2016 ~ Feb. 06, 2016	Jan. 06, 2017	Conducted (TH05-HY)
Hygrometer	Testo	608-H2	41410069	N/A	Aug. 27, 2015	Feb. 05, 2016 ~ Feb. 06, 2016	Aug. 26, 2016	Conducted (TH05-HY)
Spectrum Analyzer	Rohde & Schwarz	FSP40	100057	9kHz-40GHz	Nov. 23, 2015	Feb. 05, 2016 ~ Feb. 06, 2016	Nov. 22, 2016	Conducted (TH05-HY)
RF Cable	JYEBAO	K30K30-5003 -1.5M40	N/A	0.1MHz~40GHz	Mar. 18, 2015	Feb. 05, 2016 ~ Feb. 06, 2016	Mar. 17, 2016	Conducted (TH05-HY)
AC Power Source	ChainTek	APC-1000W	N/A	N/A	N/A	Feb. 10, 2016	N/A	Conduction (CO05-HY)
EMI Test Receiver	Rohde & Schwarz	ESCI 7	100724	9kHz~7GHz	Aug. 26, 2015	Feb. 10, 2016	Aug. 25, 2016	Conduction (CO05-HY)
Hygrometer	Testo	608-H1	34913912	N/A	Apr. 20, 2015	Feb. 10, 2016	Apr. 19, 2016	Conduction (CO05-HY)
LISN	Rohde & Schwarz	ENV216	100080	9kHz~30MHz	Dec. 02, 2015	Feb. 10, 2016	Dec. 01, 2016	Conduction (CO05-HY)
LF Cable	HUBER + SUHNER	RG-214/U	LF01	N/A	Jan. 06, 2016	Feb. 10, 2016	Jan. 05, 2017	Conduction (CO05-HY)
Loop Antenna	Rohde & Schwarz	HFH2-Z2	100315	9 kHz~30 MHz	Sep. 02, 2015	Feb. 06, 2016~ Feb. 09, 2016	Sep. 01, 2016	Radiation (03CH11-HY)
Horn Antenna	SCHWARZBE CK	BBHA 9170	BBHA9170 584	18GHz- 40GHz	Nov. 02, 2015	Feb. 06, 2016~ Feb. 09, 2016	Nov. 01, 2016	Radiation (03CH11-HY)
Bilog Antenna	TESEQ	CBL 6111D	35414	30MHz~1GHz	Nov. 17, 2015	Feb. 06, 2016~ Feb. 09, 2016	Nov. 16, 2016	Radiation (03CH11-HY)
Horn Antenna	SCHWARZBE CK	BBHA 9120 D	9120D-132 6	1GHz ~ 18GHz	Oct. 08, 2015	Feb. 06, 2016~ Feb. 09, 2016	Oct. 07, 2016	Radiation (03CH11-HY)
Preamplifier	MITEQ	JS44-180040 00-33-8P	1840917	18GHz ~ 40GHz	Jun. 02, 2015	Feb. 06, 2016~ Feb. 09, 2016	Jun. 01, 2016	Radiation (03CH11-HY)
Amplifier	SONOMA	310N	187312	9kHz~1GHz	Nov. 20, 2015	Feb. 06, 2016~ Feb. 09, 2016	Nov. 19, 2016	Radiation (03CH11-HY)
Preamplifier	Keysight	83017A	MY532700 80	1GHz~26.5GHz	Nov. 19, 2015	Feb. 06, 2016~ Feb. 09, 2016	Nov. 18, 2016	Radiation (03CH11-HY)
Preamplifier	MITEQ	AMF-7D-0010 1800-30-10P	1902247	1GHz~18GHz	Jul. 01, 2015	Feb. 06, 2016~ Feb. 09, 2016	Jun. 30, 2016	Radiation (03CH11-HY)
Hygrometer	TECPEL	DTN-303B	TP140325	N/A	Nov. 17, 2015	Feb. 06, 2016~ Feb. 09, 2016	Nov. 16, 2016	Radiation (03CH11-HY)
Spectrum Analyzer	Keysight	N9010A	MY542004 86	10Hz ~ 44GHz	Sep. 24, 2015	Feb. 06, 2016~ Feb. 09, 2016	Sep. 23, 2016	Radiation (03CH11-HY)
EMI Test Receiver	Agilent	N9038A(MXE)	MY532900 53	20Hz to 26.5GHz	Jan. 20, 2016	Feb. 06, 2016~ Feb. 09, 2016	Jan. 19, 2017	Radiation (03CH11-HY)



Instrument	Manufacturer	Model No.	Serial No.	Characteristics	Calibration Date	Test Date	Due Date	Remark
RF Cable	HUBER + SUHNER	SUCOFLEX 104	MY9837/4 MY28419/ 4MY28654 /4	9KHz~30MHz	Sep. 14, 2015	Feb. 06, 2016~ Feb. 09, 2016	Sep. 13, 2016	Radiation (03CH11-HY)
RF Cable	HUBER + SUHNER	SUCOFLEX 104	MY9837/4 MY28419/ 4MY28654 /4	30MHz~40GHz	Nov. 05, 2015	Feb. 06, 2016~ Feb. 09, 2016	Nov. 04, 2016	Radiation (03CH11-HY)
Antenna Mast	EMEC	AM-BS-4500-B	N/A	1~4m	N/A	Feb. 06, 2016~ Feb. 09, 2016	N/A	Radiation (03CH11-HY)
Turn Table	EMEC	TT 2000	N/A	0-360 degree	N/A	Feb. 06, 2016~ Feb. 09, 2016	N/A	Radiation (03CH11-HY)
Filter	Wainwright	WLKS1200-8 SS	SN3	1.2G Low Pass	Oct. 01, 2015	Feb. 06, 2016~ Feb. 09, 2016	Sep. 30, 2016	Radiation (03CH11-HY)
Filter	Microwave	H3G018G1	SN477220	3.0G High Pass	Oct. 01, 2015	Feb. 06, 2016~ Feb. 09, 2016	Sep. 30, 2016	Radiation (03CH11-HY)



5 Uncertainty of Evaluation

Uncertainty of Conducted Emission Measurement (150 kHz ~ 30 MHz)

Measuring Uncertainty for a Level of Confidence of 95% ($U = 2Uc(y)$)	2.26
---	------

Uncertainty of Radiated Emission Measurement (30 MHz ~ 1000 MHz)

Measuring Uncertainty for a Level of Confidence of 95% ($U = 2Uc(y)$)	4.90
---	------



Appendix A. Radiated Spurious Emission

Test Engineer :	Ken Wu and J.C. Liang	Temperature :	20~22°C
		Relative Humidity :	50~54%

<1Mbps>

2.4GHz 2400~2483.5MHz

BT (Band Edge @ 3m)

BT	Note	Frequency (MHz)	Level (dBμV/m)	Over Limit (dB)	Limit Line (dBμV/m)	Read Level (dBμV)	Antenna Factor (dB/m)	Cable Loss (dB)	Preamp Factor (dB)	Ant Pos (cm)	Table Pos (deg)	Peak Avg. (P/A)	Pol. (H/V)	
BT CH00 2402MHz		2372.27	42.71	-31.29	74	43.09	26.96	6.65	33.99	334	27	P	H	
		2372.27	17.89	-36.11	54	-	-	-	-	-	-	A	H	
	*	2402	97.61	-	-	97.87	27.01	6.71	33.98	334	27	P	H	
	*	2402	72.79	-	-	-	-	-	-	-	-	A	H	
													H	
														H
			2371.49	43.22	-30.78	74	43.6	26.96	6.65	33.99	100	73	P	V
			2371.49	18.4	-35.6	54	-	-	-	-	-	-	A	V
	*		2402	98.2	-	-	98.46	27.01	6.71	33.98	100	73	P	V
	*		2402	73.38	-	-	-	-	-	-	-	-	A	V
														V
														V
BT CH 39 2441MHz		2321.97	43.17	-30.83	74	43.77	26.82	6.58	34	323	26	P	H	
		2321.97	18.35	-35.65	54	-	-	-	-	-	-	A	H	
	*	2441.29	98.3	-	-	98.36	27.16	6.74	33.96	323	26	P	H	
	*	2441.29	73.48	-	-	-	-	-	-	-	-	A	H	
			2499.05	42.77	-31.23	74	42.64	27.3	6.77	33.94	323	26	P	H
			2499.05	17.95	-36.05	54	-	-	-	-	-	-	A	H
			2357.88	42.39	-31.61	74	42.82	26.91	6.65	33.99	100	74	P	V
			2357.88	17.57	-36.43	54	-	-	-	-	-	-	A	V
	*		2441.29	99.08	-	-	99.14	27.16	6.74	33.96	100	74	P	V
	*		2441.29	74.26	-	-	-	-	-	-	-	-	A	V
			2491.07	42.53	-31.47	74	42.41	27.3	6.77	33.95	100	74	P	V
			2491.07	17.71	-36.29	54	-	-	-	-	-	-	A	V



BT CH 78 2480MHz	*	2480	96.15	-	-	96.08	27.25	6.77	33.95	315	24	P	H
	*	2480	71.33	-	-	-	-	-	-	-	-	A	H
		2493.07	43.34	-30.66	74	43.21	27.3	6.77	33.94	315	24	P	H
		2493.07	18.52	-35.48	54	-	-	-	-	-	-	A	H
													H
													H
	*	2480	96.86	-	-	96.79	27.25	6.77	33.95	100	76	P	V
	*	2480	72.04	-	-	-	-	-	-	-	-	A	V
		2483.9	48.28	-25.72	74	48.21	27.25	6.77	33.95	100	76	P	V
		2483.9	23.46	-30.54	54	-	-	-	-	-	-	A	V
													V
													V
Remark	1. No other spurious found. 2. All results are PASS against Peak and Average limit line.												



2.4GHz 2400~2483.5MHz

BT (Harmonic @ 3m)

BT	Note	Frequency (MHz)	Level (dBμV/m)	Over Limit (dB)	Limit Line (dBμV/m)	Read Level (dBμV)	Antenna Factor (dB/m)	Cable Loss (dB)	Preamp Factor (dB)	Ant Pos (cm)	Table Pos (deg)	Peak Avg. (P/A)	Pol. (H/V)	
BT CH 00 2402MHz		4804	35.58	-38.42	74	58.89	31.1	10.68	65.09	100	0	P	H	
		4804	10.76	-43.24	54	-	-	-	-	-	-	A	H	
													H	
													H	
		4804	34.41	-39.59	74	57.72	31.1	10.68	65.09	100	0	P	V	
		4804	9.59	-44.41	54	-	-	-	-	-	-	-	A	V
														V
														V
BT CH 39 2441MHz		4882	35.16	-38.84	74	58.49	31.21	10.48	65.02	100	0	P	H	
		4882	10.34	-43.66	54	-	-	-	-	-	-	A	H	
		7323	38.23	-35.77	74	54.9	36.12	12.28	65.07	100	0	P	H	
		7323	13.41	-40.59	54	-	-	-	-	-	-	A	H	
		4882	33.62	-40.38	74	56.95	31.21	10.48	65.02	100	0	P	V	
		4882	8.8	-45.2	54	-	-	-	-	-	-	-	A	V
		7323	39.04	-34.96	74	55.71	36.12	12.28	65.07	100	0	P	V	
		7323	14.22	-39.78	54	-	-	-	-	-	-	-	A	V
BT CH 78 2480MHz		4960	35.55	-38.45	74	58.85	31.34	10.29	64.93	100	0	P	H	
		4960	10.73	-43.27	54	-	-	-	-	-	-	A	H	
		7440	39.69	-34.31	74	55.84	36.39	12.55	65.09	100	0	P	H	
		7440	14.87	-39.13	54	-	-	-	-	-	-	A	H	
		4960	34.55	-39.45	74	57.85	31.34	10.29	64.93	100	0	P	V	
		4960	9.73	-44.27	54	-	-	-	-	-	-	A	V	
		7440	39.57	-34.43	74	55.72	36.39	12.55	65.09	100	0	P	V	
		7440	14.75	-39.25	54	-	-	-	-	-	-	-	A	V
Remark	1. No other spurious found. 2. All results are PASS against Peak and Average limit line.													



Note symbol

*	Fundamental Frequency which can be ignored. However, the level of any unwanted emissions shall not exceed the level of the fundamental frequency.
!	Test result is over limit line.
P/A	Peak or Average
H/V	Horizontal or Vertical



A calculation example for radiated spurious emission is shown as below:

WIFI	Note	Frequency	Level	Over	Limit	Read	Antenna	Cable	Preamp	Ant	Table	Peak	Pol.
Ant.				Limit	Line	Level	Factor	Loss	Factor	Pos	Pos	Avg.	
1+2		(MHz)	(dBμV/m)	(dB)	(dBμV/m)	(dBμV)	(dB/m)	(dB)	(dB)	(cm)	(deg)	(P/A)	(H/V)
802.11b		2390	55.45	-18.55	74	54.51	32.22	4.58	35.86	103	308	P	H
CH 01													
2412MHz		2390	43.54	-10.46	54	42.6	32.22	4.58	35.86	103	308	A	H

- Level(dBμV/m) =
Antenna Factor(dB/m) + Cable Loss(dB) + Read Level(dBμV) - Preamp Factor(dB)
- Over Limit(dB) = Level(dBμV/m) – Limit Line(dBμV/m)

For Peak Limit @ 2390MHz:

- Level(dBμV/m)
= Antenna Factor(dB/m) + Cable Loss(dB) + Read Level(dBμV) - Preamp Factor(dB)
= 32.22(dB/m) + 4.58(dB) + 54.51(dBμV) – 35.86 (dB)
= 55.45 (dBμV/m)
- Over Limit(dB)
= Level(dBμV/m) – Limit Line(dBμV/m)
= 55.45(dBμV/m) – 74(dBμV/m)
= -18.55(dB)

For Average Limit @ 2390MHz:

- Level(dBμV/m)
= Antenna Factor(dB/m) + Cable Loss(dB) + Read Level(dBμV) - Preamp Factor(dB)
= 32.22(dB/m) + 4.58(dB) + 42.6(dBμV) – 35.86 (dB)
= 43.54 (dBμV/m)
- Over Limit(dB)
= Level(dBμV/m) – Limit Line(dBμV/m)
= 43.54(dBμV/m) – 54(dBμV/m)
= -10.46(dB)

Both peak and average measured complies with the limit line, so test result is “PASS”.



<2Mbps>

2.4GHz 2400~2483.5MHz

BT (Band Edge @ 3m)

BT	Note	Frequency	Level	Over Limit	Limit Line	Read Level	Antenna Factor	Cable Loss	Preamp Factor	Ant Pos	Table Pos	Peak Avg.	Pol.	
		(MHz)	(dBμV/m)	(dB)	(dBμV/m)	(dBμV)	(dB/m)	(dB)	(dB)	(cm)	(deg)	(P/A)	(H/V)	
BT CH00 2402MHz		2362.65	43.11	-30.89	74	43.54	26.91	6.65	33.99	334	27	P	H	
		2362.65	18.32	-35.68	54	-	-	-	-	-	-	A	H	
	*	2402	96.43	-	-	96.69	27.01	6.71	33.98	334	27	P	H	
	*	2402	71.64	-	-	-	-	-	-	-	-	A	H	
													H	
													H	
			2384.1	42.9	-31.1	74	43.22	26.96	6.71	33.99	100	73	P	V
			2384.1	18.11	-35.89	54	-	-	-	-	-	-	A	V
	*		2402	96.85	-	-	97.11	27.01	6.71	33.98	100	73	P	V
	*		2402	72.06	-	-	-	-	-	-	-	-	A	V
													V	
													V	
BT CH 39 2441MHz		2367.57	42.85	-31.15	74	43.28	26.91	6.65	33.99	323	26	P	H	
		2367.57	18.06	-35.94	54	-	-	-	-	-	-	A	H	
	*	2441.1	97.23	-	-	97.29	27.16	6.74	33.96	323	26	P	H	
	*	2441.1	72.44	-	-	-	-	-	-	-	-	A	H	
			2496.77	42.8	-31.2	74	42.67	27.3	6.77	33.94	323	26	P	H
			2496.77	18.01	-35.99	54	-	-	-	-	-	-	A	H
			2364.34	42.74	-31.26	74	43.17	26.91	6.65	33.99	100	74	P	V
			2364.34	17.95	-36.05	54	-	-	-	-	-	-	A	V
	*		2441.29	98.14	-	-	98.2	27.16	6.74	33.96	100	74	P	V
	*		2441.29	73.35	-	-	-	-	-	-	-	-	A	V
			2498.67	42.74	-31.26	74	42.61	27.3	6.77	33.94	100	74	P	V
			2498.67	17.95	-36.05	54	-	-	-	-	-	-	A	V



BT CH 78 2480MHz	*	2480	95.04	-	-	94.97	27.25	6.77	33.95	315	24	P	H
	*	2480	70.25	-	-	-	-	-	-	-	-	A	H
		2483.69	43.37	-30.63	74	43.3	27.25	6.77	33.95	315	24	P	H
		2483.69	18.58	-35.42	54	-	-	-	-	-	-	A	H
													H
													H
	*	2480	95.85	-	-	95.78	27.25	6.77	33.95	100	76	P	V
	*	2480	71.06	-	-	-	-	-	-	-	-	A	V
		2484.18	48.85	-25.15	74	48.78	27.25	6.77	33.95	100	76	P	V
		2484.18	24.06	-29.94	54	-	-	-	-	-	-	A	V
													V
													V
Remark	<ol style="list-style-type: none"> 1. No other spurious found. 2. All results are PASS against Peak and Average limit line. 												



2.4GHz 2400~2483.5MHz

BT (Harmonic @ 3m)

BT	Note	Frequency (MHz)	Level (dBµV/m)	Over Limit (dB)	Limit Line (dBµV/m)	Read Level (dBµV)	Antenna Factor (dB/m)	Cable Loss (dB)	Preamp Factor (dB)	Ant Pos (cm)	Table Pos (deg)	Peak Avg. (P/A)	Pol. (H/V)	
BT CH 00 2402MHz		4804	35.13	-38.87	74	58.44	31.1	10.68	65.09	100	0	P	H	
		4804	10.34	-43.66	54	-	-	-	-	-	-	A	H	
													H	
													H	
		4804	34.71	-39.29	74	58.02	31.1	10.68	65.09	100	0	P	V	
		4804	9.92	-44.08	54	-	-	-	-	-	-	-	A	V
														V
														V
BT CH 39 2441MHz		4882	35.5	-38.5	74	58.83	31.21	10.48	65.02	100	0	P	H	
		4882	10.71	-43.29	54	-	-	-	-	-	-	A	H	
		7323	39.29	-34.71	74	55.96	36.12	12.28	65.07	100	0	P	H	
		7323	14.5	-39.5	54	-	-	-	-	-	-	A	H	
		4882	34.64	-39.36	74	57.97	31.21	10.48	65.02	100	0	P	V	
		4882	9.85	-44.15	54	-	-	-	-	-	-	-	A	V
		7323	38.12	-35.88	74	54.79	36.12	12.28	65.07	100	0	P	V	
		7323	13.33	-40.67	54	-	-	-	-	-	-	-	A	V
BT CH 78 2480MHz		4960	35.49	-38.51	74	58.79	31.34	10.29	64.93	100	0	P	H	
		4960	10.7	-43.3	54	-	-	-	-	-	-	A	H	
		7440	38.38	-35.62	74	54.53	36.39	12.55	65.09	100	0	P	H	
		7440	13.59	-40.41	54	-	-	-	-	-	-	A	H	
		4960	34.63	-39.37	74	57.93	31.34	10.29	64.93	100	0	P	V	
		4960	9.84	-44.16	54	-	-	-	-	-	-	-	A	V
		7440	38.44	-35.56	74	54.59	36.39	12.55	65.09	100	0	P	V	
		7440	13.65	-40.35	54	-	-	-	-	-	-	-	A	V
Remark	1. No other spurious found. 2. All results are PASS against Peak and Average limit line.													



Note symbol

*	Fundamental Frequency which can be ignored. However, the level of any unwanted emissions shall not exceed the level of the fundamental frequency.
!	Test result is over limit line.
P/A	Peak or Average
H/V	Horizontal or Vertical



A calculation example for radiated spurious emission is shown as below:

WIFI	Note	Frequency	Level	Over	Limit	Read	Antenna	Cable	Preamp	Ant	Table	Peak	Pol.
Ant.				Limit	Line	Level	Factor	Loss	Factor	Pos	Pos	Avg.	
1+2		(MHz)	(dBμV/m)	(dB)	(dBμV/m)	(dBμV)	(dB/m)	(dB)	(dB)	(cm)	(deg)	(P/A)	(H/V)
802.11b		2390	55.45	-18.55	74	54.51	32.22	4.58	35.86	103	308	P	H
CH 01													
2412MHz		2390	43.54	-10.46	54	42.6	32.22	4.58	35.86	103	308	A	H

- Level(dBμV/m) =
Antenna Factor(dB/m) + Cable Loss(dB) + Read Level(dBμV) - Preamp Factor(dB)
- Over Limit(dB) = Level(dBμV/m) – Limit Line(dBμV/m)

For Peak Limit @ 2390MHz:

- Level(dBμV/m)
= Antenna Factor(dB/m) + Cable Loss(dB) + Read Level(dBμV) - Preamp Factor(dB)
= 32.22(dB/m) + 4.58(dB) + 54.51(dBμV) – 35.86 (dB)
= 55.45 (dBμV/m)
- Over Limit(dB)
= Level(dBμV/m) – Limit Line(dBμV/m)
= 55.45(dBμV/m) – 74(dBμV/m)
= -18.55(dB)

For Average Limit @ 2390MHz:

- Level(dBμV/m)
= Antenna Factor(dB/m) + Cable Loss(dB) + Read Level(dBμV) - Preamp Factor(dB)
= 32.22(dB/m) + 4.58(dB) + 42.6(dBμV) – 35.86 (dB)
= 43.54 (dBμV/m)
- Over Limit(dB)
= Level(dBμV/m) – Limit Line(dBμV/m)
= 43.54(dBμV/m) – 54(dBμV/m)
= -10.46(dB)

Both peak and average measured complies with the limit line, so test result is “PASS”.



<3Mbps>

2.4GHz 2400~2483.5MHz

BT (Band Edge @ 3m)

BT	Note	Frequency	Level	Over Limit	Limit Line	Read Level	Antenna Factor	Cable Loss	Preamp Factor	Ant Pos	Table Pos	Peak Avg.	Pol.	
		(MHz)	(dBμV/m)	(dB)	(dBμV/m)	(dBμV)	(dB/m)	(dB)	(dB)	(cm)	(deg)	(P/A)	(H/V)	
BT CH00 2402MHz		2364.08	42.66	-31.34	74	43.09	26.91	6.65	33.99	334	27	P	H	
		2364.08	17.87	-36.13	54	-	-	-	-	-	-	A	H	
	*	2402	96.67	-	-	96.93	27.01	6.71	33.98	334	27	P	H	
	*	2402	71.88	-	-	-	-	-	-	-	-	A	H	
													H	
													H	
			2368.24	43.15	-30.85	74	43.58	26.91	6.65	33.99	100	73	P	V
			2368.24	18.36	-35.64	54	-	-	-	-	-	-	A	V
	*		2402	97.01	-	-	97.27	27.01	6.71	33.98	100	73	P	V
	*		2402	72.22	-	-	-	-	-	-	-	-	A	V
													V	
													V	
BT CH 39 2441MHz		2383.15	42.68	-31.32	74	43	26.96	6.71	33.99	323	26	P	H	
		2383.15	17.89	-36.11	54	-	-	-	-	-	-	A	H	
	*	2441.1	97.32	-	-	97.38	27.16	6.74	33.96	323	26	P	H	
	*	2441.1	72.53	-	-	-	-	-	-	-	-	A	H	
			2492.02	43.15	-30.85	74	43.02	27.3	6.77	33.94	323	26	P	H
			2492.02	18.36	-35.64	54	-	-	-	-	-	-	A	H
			2365.48	43.37	-30.63	74	43.8	26.91	6.65	33.99	100	74	P	V
			2365.48	18.58	-35.42	54	-	-	-	-	-	-	A	V
	*		2441.1	97.98	-	-	98.04	27.16	6.74	33.96	100	74	P	V
	*		2441.1	73.19	-	-	-	-	-	-	-	-	A	V
			2487.84	42.04	-31.96	74	41.92	27.3	6.77	33.95	100	74	P	V
			2487.84	17.25	-36.75	54	-	-	-	-	-	-	A	V



BT CH 78 2480MHz	*	2480	95.42	-	-	95.35	27.25	6.77	33.95	315	24	P	H
	*	2480	70.63	-	-	-	-	-	-	-	-	A	H
		2483.55	43.94	-30.06	74	43.87	27.25	6.77	33.95	315	24	P	H
		2483.55	19.15	-34.85	54	-	-	-	-	-	-	A	H
													H
													H
	*	2480	95.92	-	-	95.85	27.25	6.77	33.95	100	76	P	V
	*	2480	71.13	-	-	-	-	-	-	-	-	A	V
		2483.76	49.13	-24.87	74	49.06	27.25	6.77	33.95	100	76	P	V
		2483.76	24.34	-29.66	54	-	-	-	-	-	-	A	V
													V
													V
Remark	<ol style="list-style-type: none"> 1. No other spurious found. 2. All results are PASS against Peak and Average limit line. 												



2.4GHz 2400~2483.5MHz

BT (Harmonic @ 3m)

BT	Note	Frequency (MHz)	Level (dBμV/m)	Over Limit (dB)	Limit Line (dBμV/m)	Read Level (dBμV)	Antenna Factor (dB/m)	Cable Loss (dB)	Preamp Factor (dB)	Ant Pos (cm)	Table Pos (deg)	Peak Avg. (P/A)	Pol. (H/V)	
BT CH 00 2402MHz		4804	35.24	-38.76	74	58.55	31.1	10.68	65.09	100	0	P	H	
		4804	10.45	-43.55	54	-	-	-	-	-	-	A	H	
													H	
													H	
		4804	34.31	-39.69	74	57.62	31.1	10.68	65.09	100	0	P	V	
		4804	9.52	-44.48	54	-	-	-	-	-	-	-	A	V
														V
														V
BT CH 39 2441MHz		4882	35.4	-38.6	74	58.73	31.21	10.48	65.02	100	0	P	H	
		4882	10.61	-43.39	54	-	-	-	-	-	-	A	H	
		7323	38.38	-35.62	74	55.05	36.12	12.28	65.07	100	0	P	H	
		7323	13.59	-40.41	54	-	-	-	-	-	-	A	H	
		4882	34.79	-39.21	74	58.12	31.21	10.48	65.02	100	0	P	V	
		4882	10	-44	54	-	-	-	-	-	-	-	A	V
		7323	38.19	-35.81	74	54.86	36.12	12.28	65.07	100	0	P	V	
		7323	13.4	-40.6	54	-	-	-	-	-	-	-	A	V
BT CH 78 2480MHz		4960	34.99	-39.01	74	58.29	31.34	10.29	64.93	100	0	P	H	
		4960	10.2	-43.8	54	-	-	-	-	-	-	A	H	
		7440	39.42	-34.58	74	55.57	36.39	12.55	65.09	100	0	P	H	
		7440	14.63	-39.37	54	-	-	-	-	-	-	A	H	
		4960	34.65	-39.35	74	57.95	31.34	10.29	64.93	100	0	P	V	
		4960	9.86	-44.14	54	-	-	-	-	-	-	-	A	V
		7440	38.81	-35.19	74	54.96	36.39	12.55	65.09	100	0	P	V	
		7440	14.02	-39.98	54	-	-	-	-	-	-	-	A	V
Remark	1. No other spurious found. 2. All results are PASS against Peak and Average limit line.													



Emission below 1GHz

2.4GHz BT (LF)

BT	Note	Frequency	Level	Over	Limit	Read	Antenna	Cable	Preamp	Ant	Table	Peak	Pol.	
		(MHz)	(dBμV/m)	(dB)	(dBμV/m)	(dBμV)	(dB/m)	(dB)	(dB)	(cm)	(deg)	(P/A)	(H/V)	
2.4GHz BT LF		30.27	24.14	-15.86	40	29.34	25.7	0.93	31.83			P	H	
		100.74	24.94	-18.56	43.5	39.03	16.21	1.48	31.78			P	H	
		220.62	21.2	-24.8	46	34.73	16.27	1.98	31.78			P	H	
		535.9	26.21	-19.79	46	30.59	24.61	2.95	31.94			P	H	
		845.3	30.86	-15.14	46	29.94	28.85	3.77	31.7	318	192	P	H	
		969.2	33.95	-20.05	54	30.38	30.56	3.89	30.88			P	H	
													H	
													H	
													H	
													H	
													H	
													H	
			30.54	30.78	-9.22	40	36.5	25.18	0.93	31.83	248	68	P	V
			41.07	30.71	-9.29	40	41.86	19.74	0.93	31.82			P	V
			111	25.59	-17.91	43.5	38.6	17.29	1.48	31.78			P	V
			554.8	26.58	-19.42	46	30.63	24.89	3.03	31.97			P	V
			704.6	28.54	-17.46	46	30.25	26.78	3.54	32.03			P	V
			799.8	30.28	-15.72	46	30.2	28.3	3.7	31.92			P	V
													V	
													V	
												V		
												V		
												V		
												V		
Remark	1. No other spurious found. 2. All results are PASS against limit line.													



Note symbol

*	Fundamental Frequency which can be ignored. However, the level of any unwanted emissions shall not exceed the level of the fundamental frequency.
!	Test result is over limit line.
P/A	Peak or Average
H/V	Horizontal or Vertical



A calculation example for radiated spurious emission is shown as below:

WIFI	Note	Frequency	Level	Over	Limit	Read	Antenna	Cable	Preamp	Ant	Table	Peak	Pol.
Ant.				Limit	Line	Level	Factor	Loss	Factor	Pos	Pos	Avg.	
1+2		(MHz)	(dBμV/m)	(dB)	(dBμV/m)	(dBμV)	(dB/m)	(dB)	(dB)	(cm)	(deg)	(P/A)	(H/V)
802.11b		2390	55.45	-18.55	74	54.51	32.22	4.58	35.86	103	308	P	H
CH 01													
2412MHz		2390	43.54	-10.46	54	42.6	32.22	4.58	35.86	103	308	A	H

- 1. Level(dBμV/m) =
Antenna Factor(dB/m) + Cable Loss(dB) + Read Level(dBμV) - Preamp Factor(dB)
- 2. Over Limit(dB) = Level(dBμV/m) – Limit Line(dBμV/m)

For Peak Limit @ 2390MHz:

- 1. Level(dBμV/m)
= Antenna Factor(dB/m) + Cable Loss(dB) + Read Level(dBμV) - Preamp Factor(dB)
= 32.22(dB/m) + 4.58(dB) + 54.51(dBμV) – 35.86 (dB)
= 55.45 (dBμV/m)
- 2. Over Limit(dB)
= Level(dBμV/m) – Limit Line(dBμV/m)
= 55.45(dBμV/m) – 74(dBμV/m)
= -18.55(dB)

For Average Limit @ 2390MHz:

- 1. Level(dBμV/m)
= Antenna Factor(dB/m) + Cable Loss(dB) + Read Level(dBμV) - Preamp Factor(dB)
= 32.22(dB/m) + 4.58(dB) + 42.6(dBμV) – 35.86 (dB)
= 43.54 (dBμV/m)
- 2. Over Limit(dB)
= Level(dBμV/m) – Limit Line(dBμV/m)
= 43.54(dBμV/m) – 54(dBμV/m)
= -10.46(dB)

Both peak and average measured complies with the limit line, so test result is “PASS”.



Appendix B. Radiated Spurious Emission Plots

Test Engineer :	Ken Wu and J.C. Liang	Temperature :	20~22°C
		Relative Humidity :	50~54%

<1Mbps>

2.4GHz 2400~2483.5MHz

BT (Band Edge @ 3m)

BT	2.4GHz 2400~2483.5MHz Band Edge @ 3m	
ANT	BT CH00 2402MHz	
1	Horizontal	Vertical
Peak	<p>Site : 03CH11-HY Condition : FCC CLASS-B 3m HORN 91200-HF HORIZONTAL RBW:1000.000KHz VBW:3000.000KHz SWT:Auto Detector : Peak</p>	<p>Site : 03CH11-HY Condition : FCC CLASS-B 3m HORN 91200-HF VERTICAL RBW:1000.000KHz VBW:3000.000KHz SWT:Auto Detector : Peak</p>

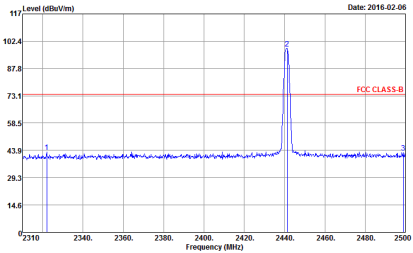
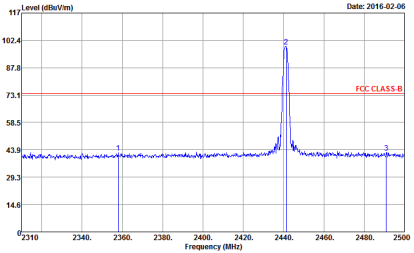

BT	2.4GHz 2400~2483.5MHz Band Edge @ 3m	
ANT	BT CH39 2441MHz	
1	Horizontal	Vertical
Peak	 <p>Site : 03CH11-HY Condition : FCC CLASS-B 3m HORN 9120D-HF HORIZONTAL RBW:1000.000KHz VBW:3000.000KHz SWT:Auto Detector : Peak</p>	 <p>Site : 03CH11-HY Condition : FCC CLASS-B 3m HORN 9120D-HF VERTICAL RBW:1000.000KHz VBW:3000.000KHz SWT:Auto Detector : Peak</p>

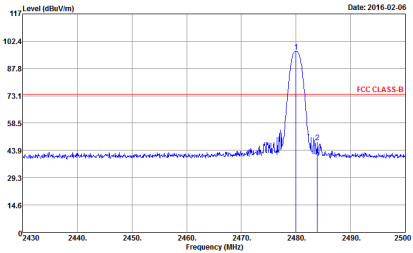
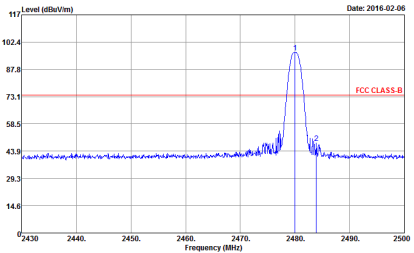

BT	2.4GHz 2400~2483.5MHz Band Edge @ 3m	
ANT	BT CH78 2480MHz	
1	Horizontal	Vertical
Peak	 <p data-bbox="347 900 762 952">Site : 03CH11-HY Condition : FCC CLASS-B 3m HORN 9120D-HF VERTICAL RBW:1000.000KHz VBW:3000.000KHz SWT:Auto Detector : Peak</p>	 <p data-bbox="944 900 1359 952">Site : 03CH11-HY Condition : FCC CLASS-B 3m HORN 9120D-HF VERTICAL RBW:1000.000KHz VBW:3000.000KHz SWT:Auto Detector : Peak</p>



2.4GHz 2400~2483.5MHz

BT (Harmonic @ 3m)

BT	2.4GHz 2400~2483.5MHz Harmonic @ 3m	
ANT	BT CH00 2402MHz	
1	Horizontal	Vertical
Peak Avg.	<p>Site : 03CH11-HY Condition : FCC CLASS-B 3m 9170 SHF HORM_150809 HORIZONTAL Detector : Peak</p>	<p>Site : 03CH11-HY Condition : FCC CLASS-B 3m 9170 SHF HORM_150809 VERTICAL Detector : Peak</p>



BT	2.4GHz 2400~2483.5MHz Harmonic @ 3m	
ANT	BT CH39 2441MHz	
1	Horizontal	Vertical
Peak Avg.	<p>Site : 03CH11-HY Condition : FCC CLASS-B 3m 9170 SHF HORM_150809 HORIZONTAL Detector : Peak</p>	<p>Site : 03CH11-HY Condition : FCC CLASS-B 3m 9170 SHF HORM_150809 VERTICAL Detector : Peak</p>



BT	2.4GHz 2400~2483.5MHz Harmonic @ 3m	
ANT	BT CH78 2480MHz	
1	Horizontal	Vertical
Peak Avg.	<p>Site : 03CH11-HY Condition : FCC CLASS-B 3m 9170 SHF HORM_150809 HORIZONTAL Detector : Peak</p>	<p>Site : 03CH11-HY Condition : FCC CLASS-B 3m 9170 SHF HORM_150809 VERTICAL Detector : Peak</p>



<2Mbps>

2.4GHz 2400~2483.5MHz

BT (Band Edge @ 3m)

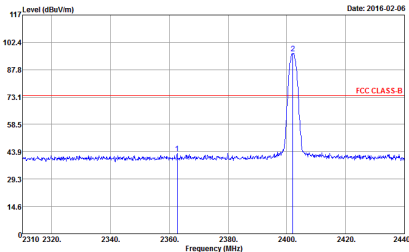
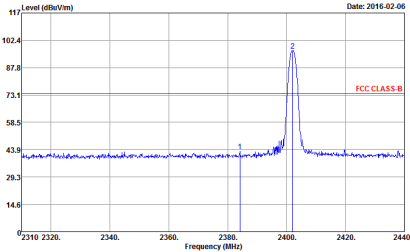
BT	2.4GHz 2400~2483.5MHz Band Edge @ 3m	
ANT	BT CH00 2402MHz	
1	Horizontal	Vertical
Peak	 <p>Site : 03CH11-HY Condition : FCC CLASS-B 3m HORN 9120D-HF HORIZONTAL RBW:1000.000KHz VBW:3000.000KHz SWT:Auto Detector : Peak</p>	 <p>Site : 03CH11-HY Condition : FCC CLASS-B 3m HORN 9120D-HF VERTICAL RBW:1000.000KHz VBW:3000.000KHz SWT:Auto Detector : Peak</p>



BT	2.4GHz 2400~2483.5MHz Band Edge @ 3m	
ANT	BT CH39 2441MHz	
1	Horizontal	Vertical
Peak	<p> Site : 03CH11-HY Condition : FCC CLASS-B 3m HORN 9120D-HF HORIZONTAL RBW:1000.000KHz VBW:3000.000KHz SWT:Auto Detector : Peak </p>	<p> Site : 03CH11-HY Condition : FCC CLASS-B 3m HORN 9120D-HF VERTICAL RBW:1000.000KHz VBW:3000.000KHz SWT:Auto Detector : Peak </p>

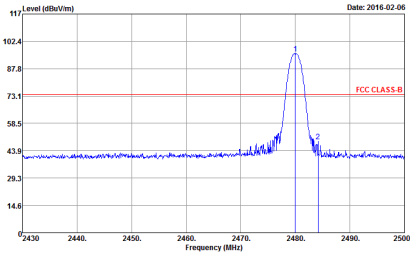
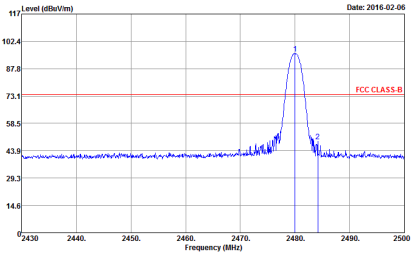

BT	2.4GHz 2400~2483.5MHz Band Edge @ 3m	
ANT	BT CH78 2480MHz	
1	Horizontal	Vertical
Peak	 <p data-bbox="347 900 638 952">Site : 03CH11-HY Condition : FCC CLASS-B 3m HORN 9120D-HF VERTICAL RBW:1000.000KHz VBW:3000.000KHz SWT:Auto Detector : Peak</p>	 <p data-bbox="944 900 1235 952">Site : 03CH11-HY Condition : FCC CLASS-B 3m HORN 9120D-HF VERTICAL RBW:1000.000KHz VBW:3000.000KHz SWT:Auto Detector : Peak</p>



2.4GHz 2400~2483.5MHz

BT (Harmonic @ 3m)

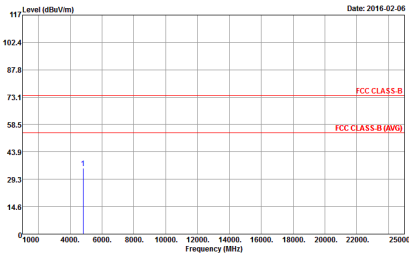
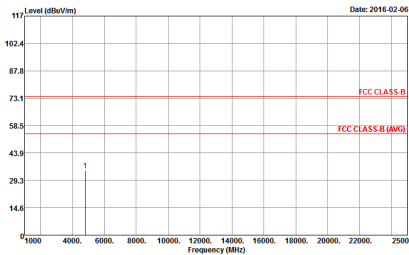
BT	2.4GHz 2400~2483.5MHz Harmonic @ 3m	
ANT	BT CH00 2402MHz	
1	Horizontal	Vertical
Peak Avg.	 <p>Site : 03CH11-HY Condition : FCC CLASS-B 3m 9170 SHF HORM_150809 HORIZONTAL Detector : Peak</p>	 <p>Site : 03CH11-HY Condition : FCC CLASS-B 3m 9170 SHF HORM_150809 VERTICAL Detector : Peak</p>

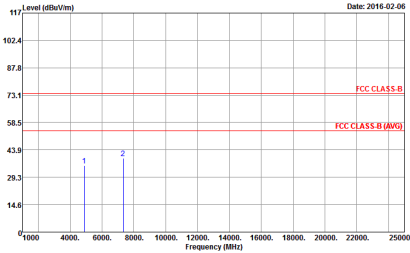
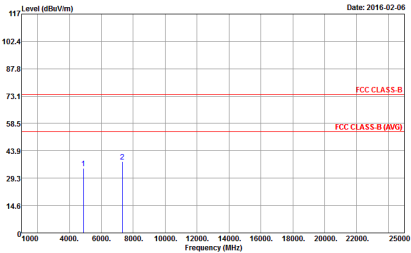

BT	2.4GHz 2400~2483.5MHz Harmonic @ 3m	
ANT	BT CH39 2441MHz	
1	Horizontal	Vertical
<p>Peak Avg.</p>	 <p>Site : 03CH11-HY Condition : FCC CLASS-B 3m 9170 SHF HORM_150809 HORIZONTAL Detector : Peak</p>	 <p>Site : 03CH11-HY Condition : FCC CLASS-B 3m 9170 SHF HORM_150809 VERTICAL Detector : Peak</p>



BT	2.4GHz 2400~2483.5MHz Harmonic @ 3m	
ANT	BT CH78 2480MHz	
1	Horizontal	Vertical
Peak Avg.	<p>Site : 03CH11-HY Condition : FCC CLASS-B 3m 9170 SHF HORM_150809 HORIZONTAL Detector : Peak</p>	<p>Site : 03CH11-HY Condition : FCC CLASS-B 3m 9170 SHF HORM_150809 VERTICAL Detector : Peak</p>



<3Mbps>

2.4GHz 2400~2483.5MHz

BT (Band Edge @ 3m)

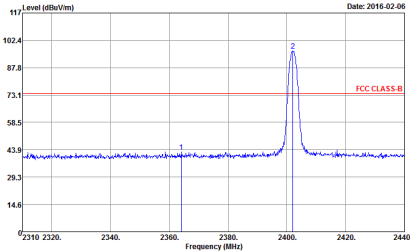
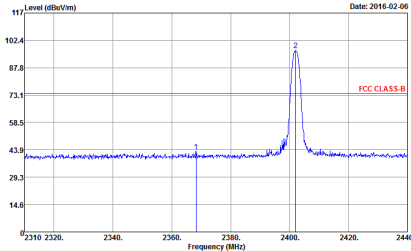
BT	2.4GHz 2400~2483.5MHz Band Edge @ 3m	
ANT	BT CH00 2402MHz	
1	Horizontal	Vertical
Peak	 <p>Site : 03CH11-HY Condition : FCC CLASS-B 3m HORN 9120D-HF HORIZONTAL RBW:1000.000KHz VBW:3000.000KHz SWT:Auto Detector : Peak</p>	 <p>Site : 03CH11-HY Condition : FCC CLASS-B 3m HORN 9120D-HF VERTICAL RBW:1000.000KHz VBW:3000.000KHz SWT:Auto Detector : Peak</p>

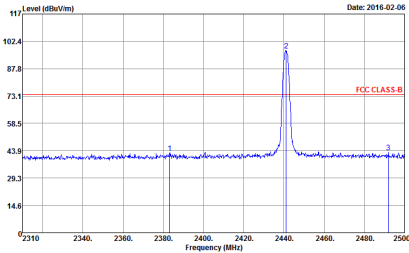
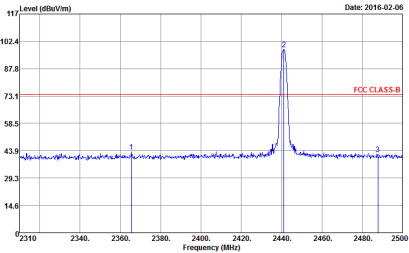

BT	2.4GHz 2400~2483.5MHz Band Edge @ 3m	
ANT	BT CH39 2441MHz	
1	Horizontal	Vertical
Peak	 <p>Site : 03CH11-HY Condition : FCC CLASS-B 3m HORN 9120D-HF HORIZONTAL RBW:1000.000KHz VBW:3000.000KHz SWT:Auto Detector : Peak</p>	 <p>Site : 03CH11-HY Condition : FCC CLASS-B 3m HORN 9120D-HF VERTICAL RBW:1000.000KHz VBW:3000.000KHz SWT:Auto Detector : Peak</p>

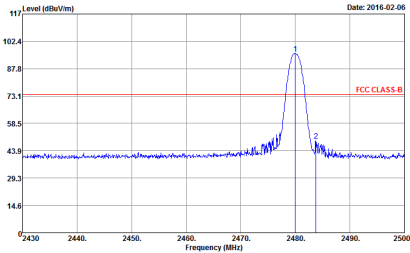
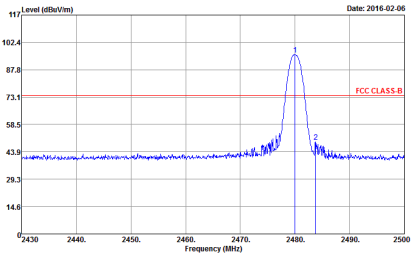

BT	2.4GHz 2400~2483.5MHz Band Edge @ 3m	
ANT	BT CH78 2480MHz	
1	Horizontal	Vertical
Peak	 <p data-bbox="347 900 638 952">Site : 03CH11-HY Condition : FCC CLASS-B 3m HORN 9120D-HF VERTICAL RBW:1000.000KHz VBW:3000.000KHz SWT:Auto Detector : Peak</p>	 <p data-bbox="944 900 1235 952">Site : 03CH11-HY Condition : FCC CLASS-B 3m HORN 9120D-HF VERTICAL RBW:1000.000KHz VBW:3000.000KHz SWT:Auto Detector : Peak</p>



2.4GHz 2400~2483.5MHz

BT (Harmonic @ 3m)

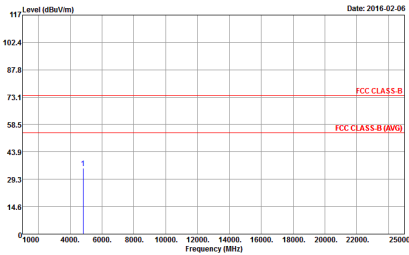
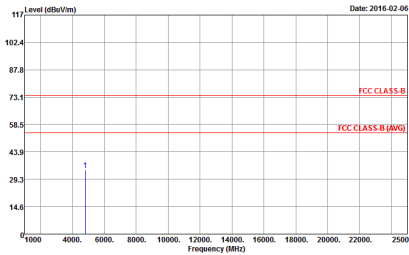
BT	2.4GHz 2400~2483.5MHz Harmonic @ 3m	
ANT	BT CH00 2402MHz	
1	Horizontal	Vertical
<p>Peak</p> <p>Avg.</p>	 <p>Site : 03CH11-1#Y Condition : FCC CLASS-B 3m 9170 SHF HORM_150809 HORIZONTAL Detector : Peak</p>	 <p>Site : 03CH11-1#Y Condition : FCC CLASS-B 3m 9170 SHF HORM_150809 VERTICAL Detector : Peak</p>



BT	2.4GHz 2400~2483.5MHz Harmonic @ 3m	
ANT	BT CH39 2441MHz	
1	Horizontal	Vertical
Peak Avg.	<p>Site : 03CH11-HY Condition : FCC CLASS-B 3m 9170 SHF HORM_150809 HORIZONTAL Detector : Peak</p>	<p>Site : 03CH11-HY Condition : FCC CLASS-B 3m 9170 SHF HORM_150809 VERTICAL Detector : Peak</p>

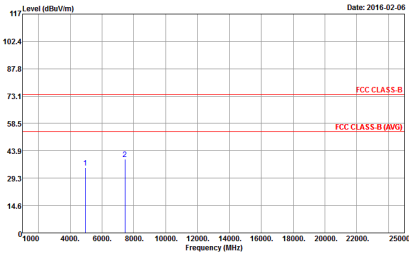
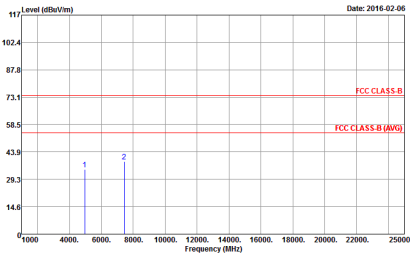

BT	2.4GHz 2400~2483.5MHz Harmonic @ 3m	
ANT	BT CH78 2480MHz	
1	Horizontal	Vertical
<p>Peak Avg.</p>	 <p>Site : 03CH11-HY Condition : FCC CLASS-B 3m 9170 SHF HORM_150809 HORIZONTAL Detector : Peak</p>	 <p>Site : 03CH11-HY Condition : FCC CLASS-B 3m 9170 SHF HORM_150809 VERTICAL Detector : Peak</p>



Emission below 1GHz

2.4GHz BT (LF)

BT	2.4GHz 2400~2483.5MHz	
ANT	BT LF	
1	Horizontal	Vertical
QP / Peak	<p>Site : 03CH11-1#Y Condition : FCC CLASS-B 3m BT-L06 6111D-LF_ETC HORIZONTAL Detector : Peak</p>	<p>Site : 03CH11-1#Y Condition : FCC CLASS-B 3m BT-L06 6111D-LF_ETC VERTICAL Detector : Peak</p>