



FCC RF Test Report

APPLICANT : Sony Mobile Communications Inc.
EQUIPMENT : GSM/WCDMA/LTE Phone+Bluetooth,
DTS/UNII a/b/g/n and NFC
BRAND NAME : Sony
FCC ID : PY7-PM0961
STANDARD : 47 CFR Part 2, 22(H), 24(E), 27
CLASSIFICATION : PCS Licensed Transmitter Held to Ear (PCE)

The product was received on Jan. 22, 2016 and completely tested on Mar. 25, 2016. We, SPORTON INTERNATIONAL INC., would like to declare that the tested sample has been evaluated in accordance with the test procedures given in ANSI / TIA / EIA-603-D-2010 and the testing has shown the tested sample to be in compliance with the applicable technical standards.

The test results in this report apply exclusively to the tested model / sample. Without written approval of SPORTON INTERNATIONAL INC., the test report shall not be reproduced except in full.

Reviewed by: Joseph Lin / Supervisor

Approved by: Jones Tsai / Manager



SPORTON INTERNATIONAL INC.

No. 52, Hwa Ya 1st Rd., Hwa Ya Technology Park, Kwei-Shan District, Tao Yuan City, Taiwan, R.O.C.

SPORTON INTERNATIONAL INC.

TEL : 886-3-327-3456

FAX : 886-3-328-4978

FCC ID : PY7-PM0961

Page Number : 1 of 28

Report Issued Date : May 09, 2016

Report Version : Rev. 03

Report Template No.: BU5-FGLTE Version 1.5



TABLE OF CONTENTS

REVISION HISTORY.....3
SUMMARY OF TEST RESULT4
1 GENERAL DESCRIPTION5
1.1 Applicant5
1.2 Manufacturer.....5
1.3 Product Feature of Equipment Under Test.....5
1.4 Modification of EUT5
1.5 Emission Designator.....6
1.6 Testing Location8
1.7 Applicable Standards.....8
2 TEST CONFIGURATION OF EQUIPMENT UNDER TEST9
2.1 Test Mode.....9
2.2 Connection Diagram of Test System.....11
2.3 Support Unit used in test configuration and system11
2.4 Measurement Results Explanation Example.....11
2.5 Frequency List of Low/Middle/High Channels12
3 CONDUCTED TEST ITEMS15
3.1 Measuring Instruments15
3.2 Test Setup15
3.3 Test Result of Conducted Test15
3.4 Conducted Output Power16
3.5 Peak-to-Average Ratio16
3.6 Occupied Bandwidth.....17
3.7 Conducted Band Edge18
3.8 Conducted Spurious Emission20
3.9 Frequency Stability21
4 RADIATED TEST ITEMS22
4.1 Measuring Instruments22
4.2 Test Setup22
4.3 Test Result of Radiated Test22
4.4 Effective Radiated Power and Effective Isotropic Radiated Power23
4.5 Radiated Spurious Emission25
5 LIST OF MEASURING EQUIPMENT26
6 UNCERTAINTY OF EVALUATION28

APPENDIX A. TEST RESULTS OF CONDUCTED TEST

APPENDIX B. TEST RESULTS OF RADIATED TEST



REVISION HISTORY

REPORT NO.	VERSION	DESCRIPTION	ISSUED DATE
FG612118-01B	Rev. 01	Initial issue of report	Apr. 05, 2016
FG612118-01B	Rev. 02	Revising Effective Radiated Power and Effective Isotropic Radiated Power Measurement test watts in section 1.5 and Appendix B.	Apr. 15, 2016
FG612118-01B	Rev. 03	Updating the SW Version.	May 09, 2016



SUMMARY OF TEST RESULT

Report Section	FCC Rule	Description	Limit	Result	Remark
3.4	§2.1046	Conducted Output Power	Reporting Only	PASS	-
3.5	§24.232(d)	Peak-to-Average Ratio	<13 dB	PASS	-
3.6	§2.1049	Occupied Bandwidth	Reporting Only	PASS	-
3.7	§2.1051 §22.917(a) §24.238(a) §27.53(g) §27.53(h)	Conducted Band Edge Measurement (Band 2) (Band 4) (Band 5) (Band 12) (Band 17)	< 43+10log ₁₀ (P[Watts])	PASS	-
	§27.53(m)(4)	Conducted Band Edge Measurement (Band 7)	§27.53(m)(4)		
3.8	§2.1051 §22.917(a) §24.238(a) §27.53(g) §27.53(h)	Conducted Spurious Emission (Band 2) (Band 4) (Band 5) (Band 12) (Band 17)	< 43+10log ₁₀ (P[Watts])	PASS	-
	§2.1051 §27.53(m)(4)	Conducted Spurious Emission (Band 7)	< 55+10log ₁₀ (P[Watts])		
3.9	§2.1055 §22.355	Frequency Stability Temperature & Voltage	< 2.5 ppm for Part 22	PASS	-
	§2.1055 §24.235 §27.54		Within Authorized Band		
4.4	§22.913(a)(2)	Effective Radiated Power (Band 5)	ERP < 7 Watt	PASS	-
	§27.50(c)(10)	Effective Radiated Power (Band 12) (Band 17)	ERP < 3 Watt		
	§24.232(c) §27.50(h)(2)	Equivalent Isotropic Radiated Power (Band 2) (Band 7)	EIRP < 2Watt		
	§27.50(d)(4)	Equivalent Isotropic Radiated Power (Band 4)	EIRP < 1Watt		
4.5	§2.1053 §22.917(a) §24.238(a) §27.53(g) §27.53(h)	Radiated Spurious Emission (Band 2) (Band 4) (Band 5) (Band 12) (Band 17)	< 43+10log ₁₀ (P[Watts])	PASS	Under limit 13.60 dB at 7656.000 MHz
	§2.1053 §27.53(m)(4)	Radiated Spurious Emission (Band 7)	< 55+10log ₁₀ (P[Watts])		



1 General Description

1.1 Applicant

Sony Mobile Communications Inc.

4-12-3 Higashi-Shinagawa, Shinagawa-ku, Tokyo, 140-0002, Japan

1.2 Manufacturer

Sony Mobile Communications Inc.

4-12-3 Higashi-Shinagawa, Shinagawa-ku, Tokyo, 140-0002, Japan

1.3 Product Feature of Equipment Under Test

GSM/WCDMA/LTE, Bluetooth, DTS/UNII, a/b/g/n, GPS and NFC

Product Specification subjective to this standard	
Antenna Type	Coupling type (LDS) Antenna

EUT Information List				
IMEI	HW Version	SW Version	S/N	Performed Test Item
004402456009731	A	37.0.A.0.19	RQ3000DUYB	Conducted Measurement Radiated Spurious Emission ERP/EIRP Test

Accessory List	
AC Adapter	Model No. : EP800
	Type No. : CAA-0002016-US B
	S/N : 3113W22608039
Earphone	Model No. : MH410c
	Type No. : AG-1100
	S/N : 13511E570075F40
USB Cable	Model No. : UCB16
	Type No. : AI-0142
	S/N : N/A

Note:

1. Above EUT list and accessory list used are electrically identical per declared by manufacturer.
2. Above the accessories list are used to exercise the EUT during test.
3. For other wireless features of this EUT, test report will be issued separately.

1.4 Modification of EUT

No modifications are made to the EUT during all test items.



1.5 Emission Designator

LTE Band 2		QPSK			16QAM		
BW(MHz)	Emission Designator (99%OBW)	Frequency Tolerance (ppm)	Maximum EIRP(W)	Emission Designator (99%OBW)	Frequency Tolerance (ppm)	Maximum EIRP(W)	
1.4	1M10G7D	-	0.2018	1M10W7D	-	0.1648	
3	2M73G7D	-	0.1919	2M74W7D	-	0.1618	
5	4M51G7D	-	0.1959	4M51W7D	-	0.1648	
10	9M15G7D	0.0045	0.1950	9M07W7D	-	0.1637	
15	13M5G7D	-	0.1977	13M5W7D	-	0.1656	
20	18M4G7D	-	0.2042	18M5W7D	-	0.1702	
LTE Band 4		QPSK			16QAM		
BW(MHz)	Emission Designator (99%OBW)	Frequency Tolerance (ppm)	Maximum EIRP(W)	Emission Designator (99%OBW)	Frequency Tolerance (ppm)	Maximum EIRP(W)	
1.4	1M10G7D	-	0.2168	1M10W7D	-	0.1660	
3	2M73G7D	-	0.2004	2M72W7D	-	0.1637	
5	4M52G7D	-	0.2061	4M53W7D	-	0.1714	
10	9M07G7D	0.0055	0.1862	9M05W7D	-	0.1567	
15	13M5G7D	-	0.1774	13M5W7D	-	0.1466	
20	18M5G7D	-	0.1977	18M5W7D	-	0.1648	
LTE Band 5		QPSK			16QAM		
BW(MHz)	Emission Designator (99%OBW)	Frequency Tolerance (ppm)	Maximum ERP(W)	Emission Designator (99%OBW)	Frequency Tolerance (ppm)	Maximum ERP(W)	
1.4	1M09G7D	-	0.0668	1M10W7D	-	0.0507	
3	2M72G7D	-	0.0656	2M72W7D	-	0.0520	
5	4M52G7D	-	0.0662	4M51W7D	-	0.0546	
10	9M05G7D	0.0037	0.0646	9M07W7D	-	0.0541	



LTE Band 7		QPSK			16QAM		
BW(MHz)	Emission Designator (99%OBW)	Frequency Tolerance (ppm)	Maximum EIRP(W)	Emission Designator (99%OBW)	Frequency Tolerance (ppm)	Maximum EIRP(W)	
5	4M52G7D	-	0.1009	4M51W7D	-	0.0830	
10	9M07G7D	0.0049	0.0964	9M03W7D	-	0.0778	
15	13M5G7D	-	0.1023	13M5W7D	-	0.0813	
20	18M6G7D	-	0.0962	18M6W7D	-	0.0813	
LTE Band 12		QPSK			16QAM		
BW(MHz)	Emission Designator (99%OBW)	Frequency Tolerance (ppm)	Maximum ERP(W)	Emission Designator (99%OBW)	Frequency Tolerance (ppm)	Maximum ERP(W)	
1.4	1M10G7D	-	0.0381	1M10W7D	-	0.0325	
3	2M72G7D	-	0.0380	2M73W7D	-	0.0327	
5	4M51G7D	-	0.0402	4M53W7D	-	0.0376	
10	9M11G7D	0.0064	0.0400	9M07W7D	-	0.0340	
LTE Band 17		QPSK			16QAM		
BW(MHz)	Emission Designator (99%OBW)	Frequency Tolerance (ppm)	Maximum ERP(W)	Emission Designator (99%OBW)	Frequency Tolerance (ppm)	Maximum ERP(W)	
5	4M54G7D	-	0.0387	4M51W7D	-	0.0333	
10	9M05G7D	0.0065	0.0394	9M09W7D	-	0.0323	



1.6 Testing Location

Sporton Lab is accredited to ISO 17025 by Taiwan Accreditation Foundation (TAF code : 1190) and the FCC designation No. TW1022 under the FCC 2.948(e) by Mutual Recognition Agreement (MRA) in FCC Test.

Test Site	SPORTON INTERNATIONAL INC.
Test Site Location	No. 52, Hwa Ya 1 st Rd., Hwa Ya Technology Park, Kwei-Shan District, Tao Yuan City, Taiwan, R.O.C. TEL: +886-3-327-3456 FAX: +886-3-328-4978
Test Site No.	Sporton Site No.
	TH05-HY

Test Site	SPORTON INTERNATIONAL INC.
Test Site Location	No.58, Aly. 75, Ln. 564, Wenhua 3rd Rd. Guishan Dist, Taoyuan City, Taiwan (R.O.C.) TEL: +886-3-327-0868 FAX: +886-3-327-0855
Test Site No.	Sporton Site No.
	03CH11-HY

1.7 Applicable Standards

According to the specifications of the manufacturer, the EUT must comply with the requirements of the following standards:

- ♦ 47 CFR Part 2, 22(H), 24(E), 27
- ♦ ANSI / TIA / EIA-603-D-2010
- ♦ FCC KDB 971168 D01 Power Meas. License Digital Systems v02r02

Remark:

1. All test items were verified and recorded according to the standards and without any deviation during the test.
2. This EUT has also been tested and complied with the requirements of FCC Part 15, Subpart B, recorded in a separate test report.



2 Test Configuration of Equipment Under Test

2.1 Test Mode

Antenna port conducted and radiated test items listed below are performed according to KDB 971168 D01 Power Meas. License Digital Systems v02r02 with maximum output power.

Radiated measurements are performed by rotating the EUT in three different orthogonal test planes to find the maximum emission.

Test Items	Band	Bandwidth (MHz)						Modulation		RB #			Test Channel		
		1.4	3	5	10	15	20	QPSK	16QAM	1	Half	Full	L	M	H
Max. Output Power	2	✓	✓	✓	✓	✓	✓	✓	✓	✓	✓	✓	✓	✓	✓
	4	✓	✓	✓	✓	✓	✓	✓	✓	✓	✓	✓	✓	✓	✓
	5	✓	✓	✓	✓	-	-	✓	✓	✓	✓	✓	✓	✓	✓
	7	-	-	✓	✓	✓	✓	✓	✓	✓	✓	✓	✓	✓	✓
	12	✓	✓	✓	✓	-	-	✓	✓	✓	✓	✓	✓	✓	✓
	17	-	-	✓	✓	-	-	✓	✓	✓	✓	✓	✓	✓	✓
Peak-to-Average Ratio	2						✓	✓	✓	✓		✓	✓	✓	✓
	4						✓	✓	✓	✓		✓	✓	✓	✓
	5				✓	-	-	✓	✓	✓		✓	✓	✓	✓
	7	-	-				✓	✓	✓	✓		✓	✓	✓	✓
	12				✓	-	-	✓	✓	✓		✓	✓	✓	✓
	17	-	-		✓	-	-	✓	✓	✓		✓	✓	✓	✓
26dB and 99% Bandwidth	2	✓	✓	✓	✓	✓	✓	✓	✓			✓	✓	✓	✓
	4	✓	✓	✓	✓	✓	✓	✓	✓			✓	✓	✓	✓
	5	✓	✓	✓	✓	-	-	✓	✓			✓	✓	✓	✓
	7	-	-	✓	✓	✓	✓	✓	✓			✓	✓	✓	✓
	12	✓	✓	✓	✓	-	-	✓	✓			✓	✓	✓	✓
	17	-	-	✓	✓	-	-	✓	✓			✓	✓	✓	✓
Conducted Band Edge	2	✓	✓	✓	✓	✓	✓	✓	✓	✓		✓	✓		✓
	4	✓	✓	✓	✓	✓	✓	✓	✓	✓		✓	✓		✓
	5	✓	✓	✓	✓	-	-	✓	✓	✓		✓	✓		✓
	7	-	-	✓	✓	✓	✓	✓	✓	✓		✓	✓		✓
	12	✓	✓	✓	✓	-	-	✓	✓	✓		✓	✓		✓
	17	-	-	✓	✓	-	-	✓	✓	✓		✓	✓		✓



Test Items	Band	Bandwidth (MHz)						Modulation		RB #			Test Channel		
		1.4	3	5	10	15	20	QPSK	16QAM	1	Half	Full	L	M	H
Conducted Spurious Emission	2	√	√	√	√	√	√	√	√	√			√	√	√
	4	√	√	√	√	√	√	√	√	√			√	√	√
	5	√	√	√	√	-	-	√	√	√			√	√	√
	7	-	-	√	√	√	√	√	√	√			√	√	√
	12	√	√	√	√	-	-	√	√	√			√	√	√
	17	-	-	√	√	-	-	√	√	√			√	√	√
Frequency Stability	2				√			√				√		√	
	4				√			√				√		√	
	5				√	-	-	√				√		√	
	7	-	-		√			√				√		√	
	12				√	-	-	√				√		√	
	17	-	-		√	-	-	√				√		√	
E.R.P./ E.I.R.P.	2	√	√	√	√	√	√	√	√	√			√	√	√
	4	√	√	√	√	√	√	√	√	√			√	√	√
	5	√	√	√	√	-	-	√	√	√			√	√	√
	7	-	-	√	√	√	√	√	√	√			√	√	√
	12	√	√	√	√	√	√	√	√	√			√	√	√
	17	-	-	√	√	-	-	√	√	√			√	√	√
Radiated Spurious Emission	2	√	√	√	√	√	√	√		√			√	√	√
	4	√	√	√	√	√	√	√		√			√	√	√
	5	√	√	√	√	-	-	√		√			√	√	√
	7	-	-	√	√	√	√	√		√			√	√	√
	12	√	√	√	√	-	-	√		√			√	√	√
	17	-	-	√	√	-	-	√		√			√	√	√
Note	<p>1. The mark "√" means that this configuration is chosen for testing</p> <p>2. The mark "-" means that this bandwidth is not supported.</p> <p>3. The device is investigated from 30MHz to 10 times of fundamental signal for radiated spurious emission test under different RB size/offset and modulations in exploratory test. Subsequently, only the worst case emissions are reported.</p>														

2.2 Connection Diagram of Test System

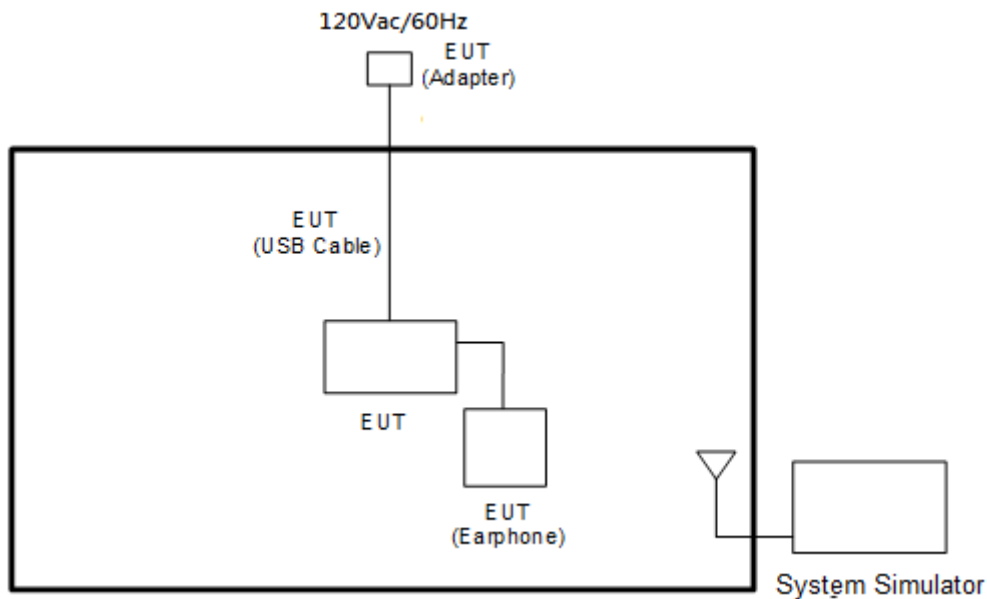

2.3 Support Unit used in test configuration and system

Item	Equipment	Trade Name	Model No.	FCC ID	Data Cable	Power Cord
1.	LTE Base Station	Anritsu	MT8820C	N/A	N/A	Unshielded, 1.8 m

2.4 Measurement Results Explanation Example

For all conducted test items:

The offset level is set in the spectrum analyzer to compensate the RF cable loss and attenuator factor between EUT conducted output port and spectrum analyzer. With the offset compensation, the spectrum analyzer reading level is exactly the EUT RF output level.

The spectrum analyzer offset is derived from RF cable loss and attenuator factor.

Offset = RF cable loss + attenuator factor.

Following shows an offset computation example with cable loss 4.2 dB and 10dB attenuator.

Example :

$$\begin{aligned} \text{Offset(dB)} &= \text{RF cable loss(dB)} + \text{attenuator factor(dB)} \\ &= 4.2 + 10 = 14.2 \text{ (dB)} \end{aligned}$$



2.5 Frequency List of Low/Middle/High Channels

LTE Band 2 Channel and Frequency List				
BW [MHz]	Channel/Frequency(MHz)	Lowest	Middle	Highest
20	Channel	18700	18900	19100
	Frequency	1860	1880	1900
15	Channel	18675	18900	19125
	Frequency	1857.5	1880	1902.5
10	Channel	18650	18900	19150
	Frequency	1855	1880	1905
5	Channel	18625	18900	19175
	Frequency	1852.5	1880	1907.5
3	Channel	18615	18900	19185
	Frequency	1851.5	1880	1908.5
1.4	Channel	18607	18900	19193
	Frequency	1850.7	1880	1909.3

LTE Band 4 Channel and Frequency List				
BW [MHz]	Channel/Frequency(MHz)	Lowest	Middle	Highest
20	Channel	20050	20175	20300
	Frequency	1720	1732.5	1745
15	Channel	20025	20175	20325
	Frequency	1717.5	1732.5	1747.5
10	Channel	20000	20175	20350
	Frequency	1715	1732.5	1750
5	Channel	19975	20175	20375
	Frequency	1712.5	1732.5	1752.5
3	Channel	19965	20175	20385
	Frequency	1711.5	1732.5	1753.5
1.4	Channel	19957	20175	20393
	Frequency	1710.7	1732.5	1754.3



LTE Band 5 Channel and Frequency List				
BW [MHz]	Channel/Frequency(MHz)	Lowest	Middle	Highest
10	Channel	20450	20525	20600
	Frequency	829	836.5	844
5	Channel	20425	20525	20625
	Frequency	826.5	836.5	846.5
3	Channel	20415	20525	20635
	Frequency	825.5	836.5	847.5
1.4	Channel	20407	20525	20643
	Frequency	824.7	836.5	848.3

LTE Band 7 Channel and Frequency List				
BW [MHz]	Channel/Frequency(MHz)	Lowest	Middle	Highest
20	Channel	20850	21100	21350
	Frequency	2510	2535	2560
15	Channel	20825	21100	21375
	Frequency	2507.5	2535	2562.5
10	Channel	20800	21100	21400
	Frequency	2505	2535	2565
5	Channel	20775	21100	21425
	Frequency	2502.5	2535	2567.5

LTE Band 12 Channel and Frequency List				
BW [MHz]	Channel/Frequency(MHz)	Lowest	Middle	Highest
10	Channel	23060	23095	23130
	Frequency	704	707.5	711
5	Channel	23035	23095	23155
	Frequency	701.5	707.5	713.5
3	Channel	23025	23095	23165
	Frequency	700.5	707.5	714.5
1.4	Channel	23017	23095	23173
	Frequency	699.7	707.5	715.3



LTE Band 17 Channel and Frequency List				
BW [MHz]	Channel/Frequency(MHz)	Lowest	Middle	Highest
10	Channel	23780	23790	23800
	Frequency	709	710	711
5	Channel	23755	23790	23825
	Frequency	706.5	710	713.5

3 Conducted Test Items

3.1 Measuring Instruments

See list of measuring instruments of this test report.

3.2 Test Setup

3.2.1 Conducted Output Power

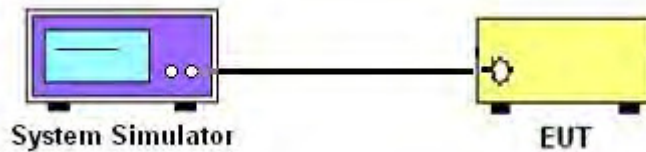

3.2.2 Peak-to-Average Ratio, Occupied Bandwidth ,Conducted Band-Edge and Conducted Spurious Emission

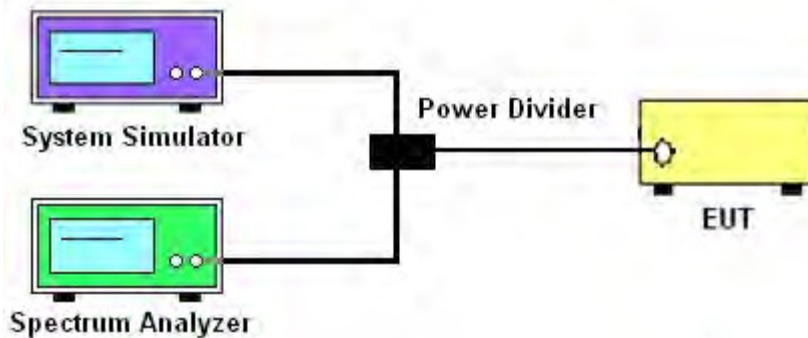

3.2.3 Frequency Stability

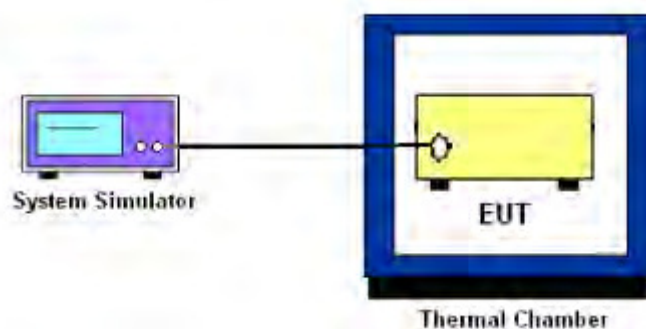

3.3 Test Result of Conducted Test

Please refer to Appendix A.



3.4 Conducted Output Power

3.4.1 Description of the Conducted Output Power Measurement

A system simulator was used to establish communication with the EUT. Its parameters were set to force the EUT transmitting at maximum output power. The measured power in the radio frequency on the transmitter output terminals shall be reported.

3.4.2 Test Procedures

1. The transmitter output port was connected to the system simulator.
2. Set EUT at maximum power through the system simulator.
3. Select lowest, middle, and highest channels for each band and different modulation.
4. Measure and record the power level from the system simulator.

3.5 Peak-to-Average Ratio

3.5.1 Description of the PAR Measurement

Power Complementary Cumulative Distribution Function (CCDF) curves provide a means for characterizing the power peaks of a digitally modulated signal on a statistical basis. A CCDF curve depicts the probability of the peak signal amplitude exceeding the average power level. Most contemporary measurement instrumentation include the capability to produce CCDF curves for an input signal provided that the instrument's resolution bandwidth can be set wide enough to accommodate the entire input signal bandwidth. In measuring transmissions in this band using an average power technique, the peak-to-average ratio (PAR) of the transmission may not exceed 13 dB.

3.5.2 Test Procedures

1. The testing follows FCC KDB 971168 v02r02 Section 5.7.1.
2. The EUT was connected to spectrum and system simulator via a power divider.
3. Set the CCDF (Complementary Cumulative Distribution Function) option in spectrum analyzer.
4. The highest RF powers were measured and recorded the maximum PAPR level associated with a probability of 0.1 %.
5. Record the deviation as Peak to Average Ratio.



3.6 Occupied Bandwidth

3.6.1 Description of Occupied Bandwidth Measurement

The occupied bandwidth is the width of a frequency band such that, below the lower and above the upper frequency limits, the mean powers emitted are each equal to a specified percentage 0.5% of the total mean transmitted power.

The 26 dB emission bandwidth is defined as the frequency range between two points, one above and one below the carrier frequency, at which the spectral density of the emission is attenuated 26 dB below the maximum in-band spectral density of the modulated signal. Spectral density (power per unit bandwidth) is to be measured with a detector of resolution bandwidth equal to approximately 1.0% of the emission bandwidth.

3.6.2 Test Procedures

1. The testing follows FCC KDB 971168 v02r02 Section 4.2.
2. The EUT was connected to spectrum analyzer and system simulator via a power divider.
3. The spectrum analyzer center frequency is set to the nominal EUT channel center frequency. The span range for the spectrum analyzer shall be between two and five times the anticipated OBW.
4. The nominal resolution bandwidth (RBW) shall be in the range of 1 to 5 % of the anticipated OBW, and the VBW shall be at least 3 times the RBW.
5. Set the detection mode to peak, and the trace mode to max hold.
6. Determine the reference value: Set the EUT to transmit a modulated signal. Allow the trace to stabilize. Set the spectrum analyzer marker to the highest level of the displayed trace.
(this is the reference value)
7. Determine the “-26 dB down amplitude” as equal to (Reference Value – X).
8. Place two markers, one at the lowest and the other at the highest frequency of the envelope of the spectral display such that each marker is at or slightly below the “-X dB down amplitude” determined in step 6. If a marker is below this “-X dB down amplitude” value it shall be placed as close as possible to this value. The OBW is the positive frequency difference between the two markers.
9. Use the 99 % power bandwidth function of the spectrum analyzer and report the measured bandwidth.



3.7 Conducted Band Edge

3.7.1 Description of Conducted Band Edge Measurement

22.917(a) for Band 5

For operations in the 824 – 849 MHz band, the FCC limit is $43 + 10\log_{10}(P[\text{Watts}])$ dB below the transmitter power $P(\text{Watts})$ in a 100kHz bandwidth. However, in the 1MHz bands immediately outside and adjacent to the licensee's frequency block, a resolution bandwidth of at least one percent of the emission bandwidth of the fundamental emission of the transmitter may be employed.

24.238 (a) for Band 2

For operations in the 1850-1910 and 1930-1990 MHz band, the FCC limit is $43 + 10\log_{10}(P[\text{Watts}])$ dB below the transmitter power $P(\text{Watts})$ in a 1MHz bandwidth. However, in the 1 MHz bands immediately outside and adjacent to the frequency block a resolution bandwidth of at least one percent of the emission bandwidth of the fundamental emission of the transmitter may be employed.

27.53 (g) for Band 12,17

For operations in the 698 -746 MHz band, the FCC limit is $43 + 10\log_{10}(P[\text{Watts}])$ dB below the transmitter power $P(\text{Watts})$ in a 100 kHz bandwidth. However, in the 100 kilohertz bands immediately outside and adjacent to a licensee's frequency block, a resolution bandwidth of at least 30 kHz may be employed.

27.53 (h) for Band 4

For operations in the 1710 – 1755 MHz band, the FCC limit is $43 + 10\log_{10}(P[\text{Watts}])$ dB below the transmitter power $P(\text{Watts})$ in a 1 MHz bandwidth. However, in the 1MHz bands immediately outside and adjacent to the licensee's frequency block, a resolution bandwidth of at least one percent of the emission bandwidth of the fundamental emission of the transmitter may be employed.



27.53(m)(4) for FCC Band 7:

For mobile digital stations, the attenuation factor shall be not less than $40 + 10 \log (P)$ dB on all frequencies between the channel edge and 5 megahertz from the channel edge, $43 + 10 \log (P)$ dB on all frequencies between 5 megahertz and X megahertz from the channel edge, and $55 + 10 \log (P)$ dB on all frequencies more than X megahertz from the channel edge, where X is the greater of 6 megahertz or the actual emission bandwidth as defined in paragraph (m)(6) of this section. In addition, the attenuation factor shall not be less that $43 + 10 \log (P)$ dB on all frequencies between 2490.5 MHz and 2496 MHz and $55 + 10 \log (P)$ dB at or below 2490.5 MHz. Mobile Satellite Service licensees operating on frequencies below 2495 MHz may also submit a documented interference complaint against BRS licensees operating on channel BRS Channel 1 on the same terms and conditions as adjacent channel BRS or EBS licensees.

3.7.2 Test Procedures

1. The testing follows FCC KDB 971168 v02r02 Section 6.0.
2. The EUT was connected to spectrum analyzer and system simulator via a power divider.
3. The band edges of low and high channels for the highest RF powers were measured.
4. Set RBW \geq 1% EBW in the 1MHz band immediately outside and adjacent to the band edge.
5. Beyond the 1 MHz band from the band edge, RBW=1MHz was used.
6. Set spectrum analyzer with RMS detector.
7. The RF fundamental frequency should be excluded against the limit line in the operating frequency band.
8. Checked that all the results comply with the emission limit line.

Example:

The limit line is derived from $43 + 10\log(P)$ dB below the transmitter power P(Watts)
= $P(W) - [43 + 10\log(P)]$ (dB)
= $[30 + 10\log(P)]$ (dBm) - $[43 + 10\log(P)]$ (dB) = -13dBm.

9. For LTE Band 7, the other 40 dB, and 55 dB have additionally applied same calculation above.



3.8 Conducted Spurious Emission

3.8.1 Description of Conducted Spurious Emission Measurement

The power of any emission outside of the authorized operating frequency ranges must be lower than the transmitter power (P) by a factor of at least $43 + 10 \log (P)$ dB.

For Band 7:

The power of any emission outside of the authorized operating frequency ranges must be lower than the transmitter power (P) by a factor of at least $55 + 10 \log (P)$ dB.

It is measured by means of a calibrated spectrum analyzer and scanned from 30 MHz up to a frequency including its 10th harmonic.

3.8.2 Test Procedures

1. The testing follows FCC KDB 971168 v02r02 Section 6.0.
2. The EUT was connected to spectrum analyzer and system simulator via a power divider.
3. The RF output of EUT was connected to the spectrum analyzer by RF cable and attenuator. The path loss was compensated to the results for each measurement.
4. The middle channel for the highest RF power within the transmitting frequency was measured.
5. The conducted spurious emission for the whole frequency range was taken.
6. Make the measurement with the spectrum analyzer's RBW = 1MHz, VBW = 3MHz.
7. Set spectrum analyzer with RMS detector.
8. Taking the record of maximum spurious emission.
9. The RF fundamental frequency should be excluded against the limit line in the operating frequency band.
10. The limit line is derived from $43 + 10\log(P)$ dB below the transmitter power P(Watts)
 $= P(W) - [43 + 10\log(P)]$ (dB)
 $= [30 + 10\log(P)]$ (dBm) - $[43 + 10\log(P)]$ (dB)
 $= -13$ dBm.
11. For Band 7
The limit line is derived from $55 + 10\log(P)$ dB below the transmitter power P(Watts)
 $= P(W) - [55 + 10\log(P)]$ (dB)
 $= [30 + 10\log(P)]$ (dBm) - $[55 + 10\log(P)]$ (dB)
 $= -25$ dBm.



3.9 Frequency Stability

3.9.1 Description of Frequency Stability Measurement

The frequency stability shall be measured by variation of ambient temperature and variation of primary supply voltage to ensure that the fundamental emission stays within the authorized frequency block. The frequency stability of the transmitter shall be maintained within $\pm 0.00025\%$ ($\pm 2.5\text{ppm}$) of the center frequency.

3.9.2 Test Procedures for Temperature Variation

1. The testing follows FCC KDB 971168 v02r02 Section 9.0.
2. The EUT was set up in the thermal chamber and connected with the system simulator.
3. With power OFF, the temperature was decreased to -30°C and the EUT was stabilized before testing. Power was applied and the maximum change in frequency was recorded within one minute.
4. With power OFF, the temperature was raised in 10°C step up to 50°C . The EUT was stabilized at each step for at least half an hour. Power was applied and the maximum frequency change was recorded within one minute.

3.9.3 Test Procedures for Voltage Variation

1. The testing follows FCC KDB 971168 v02r02 Section 9.0.
2. The EUT was placed in a temperature chamber at $25\pm 5^{\circ}\text{C}$ and connected with the system simulator.
3. The power supply voltage to the EUT was varied from 85% to 115% of the nominal value measured at the input to the EUT.
4. The variation in frequency was measured for the worst case.

4 Radiated Test Items

4.1 Measuring Instruments

See list of measuring instruments of this test report.

4.2 Test Setup

4.2.1 For radiated test from 30MHz to 1GHz

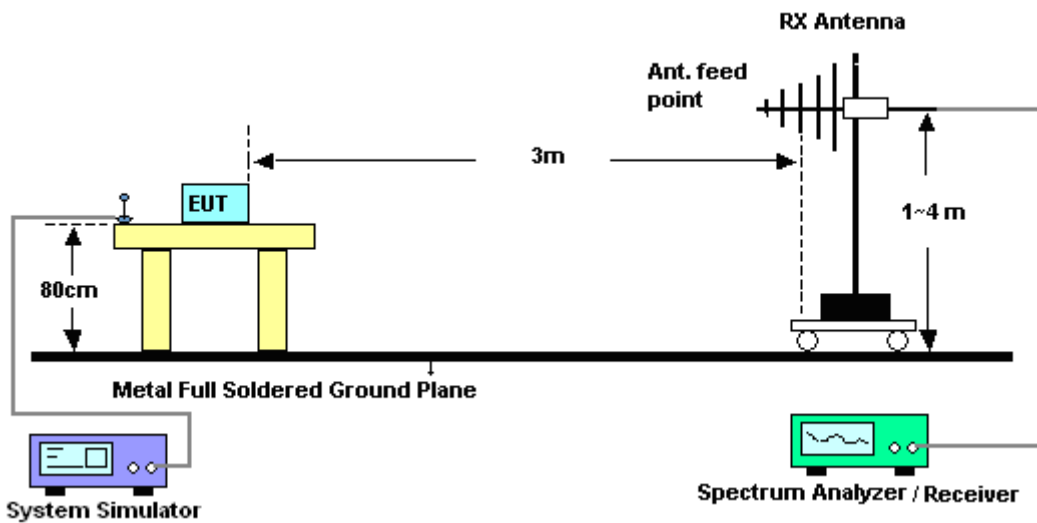

4.2.2 For radiated test above 1GHz

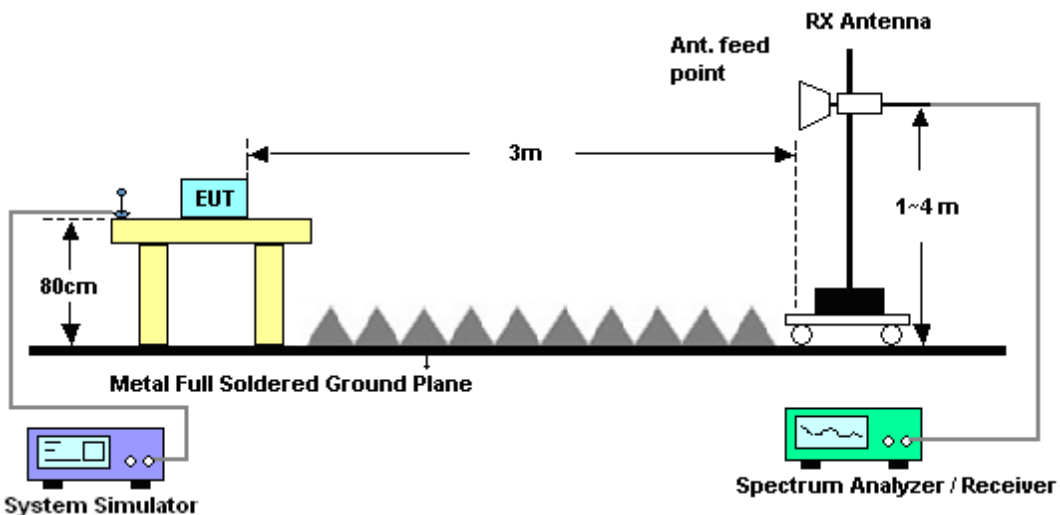

4.3 Test Result of Radiated Test

Please refer to Appendix B.



4.4 Effective Radiated Power and Effective Isotropic Radiated Power

4.4.1 Description of the ERP/EIRP Measurement

Effective radiated power output measurements by substitution method according to ANSI / TIA / EIA-603-D-2010, and the spectrum analyzer configuration follows KDB 971168 D01 Power Meas. License Digital Systems v02r02. Mobile and portable (hand-held) stations operating are limited to average ERP of 7 watts with LTE band 5 and 3 watts with LTE band 12 / 17.

Equivalent isotropic radiated power output measurements by substitution method according to ANSI / TIA / EIA-603-D-2010, and the spectrum analyzer configuration follows KDB 971168 D01 Power Meas. License Digital Systems v02r02. Mobile and portable (hand-held) stations operating are limited to average EIRP of 2 watts with LTE band 2 / 7 and 1 watt with LTE band 4.

4.4.2 Test Procedures

1. The EUT was placed on a non-conductive rotating platform 0.8 meters high in a semi-anechoic chamber. The radiated emission at the fundamental frequency was measured at 3 m with a test antenna and a spectrum analyzer with RMS detector per section 5. of KDB 971168 D01.
2. During the measurement, the system simulator parameters were set to force the EUT transmitting at maximum output power. The maximum emission was recorded from analyzer power level (LVL) from the 360 degrees rotation of the turntable and the test antenna raised and lowered over a range from 1 to 4 meters in both horizontally and vertically polarized orientations.
3. Effective Isotropic Radiated Power (EIRP) was measured by substitution method according to TIA/EIA-603-D. The EUT was replaced by the substitution antenna at same location, and then a known power from S.G. was applied into the dipole antenna through a Tx cable, and then recorded the maximum Analyzer reading through raised and lowered the test antenna. The correction factor (in dB) = S.G. - Tx Cable loss + Substitution antenna gain - Analyzer reading. Then the EUT's EIRP was calculated with the correction factor, $EIRP = LVL + \text{Correction factor}$ and $ERP = EIRP - 2.15$. Take the record of the output power at substitution antenna.



	LTE Average					
LTE BW	1.4M	3M	5M	10M	15M	20M
Span	3MHz	6MHz	10MHz	20MHz	30MHz	40MHz
RBW	30kHz	100kHz	100kHz	300kHz	300kHz	300kHz
VBW	100kHz	300kHz	300kHz	1MHz	1MHz	1MHz
Detector	RMS	RMS	RMS	RMS	RMS	RMS
Trace	Average	Average	Average	Average	Average	Average
Average Type	Power	Power	Power	Power	Power	Power
Sweep Count	100	100	100	100	100	100



4.5 Radiated Spurious Emission

4.5.1 Description of Radiated Spurious Emission

The radiated spurious emission was measured by substitution method according to ANSI / TIA / EIA-603-D-2010. The power of any emission outside of the authorized operating frequency ranges must be attenuated below the transmitter power (P) by a factor of at least $43 + 10 \log (P)$ dB.

For Band 7

The power of any emission outside of the authorized operating frequency ranges must be attenuated below the transmitter power (P) by a factor of at least $55 + 10 \log (P)$ dB.

For LTE Band 12,17

For operations in the 746-758 MHz, 775-788 MHz, and 805-806 MHz bands, emissions in the band 1559-1610 MHz shall be limited to -70 dBW/MHz equivalent isotropically radiated power (EIRP) for wideband signals, and -80 dBW EIRP for discrete emissions of less than 700 Hz bandwidth.

The spectrum is scanned from 30 MHz up to a frequency including its 10th harmonic.

4.5.2 Test Procedures

1. The testing follows FCC KDB 971168 v02r02 Section 5.8 and ANSI / TIA-603-D-2010 Section 2.2.12.
2. The EUT was placed on a rotatable wooden table with 0.8 meter above ground.
3. The EUT was set 3 meters from the receiving antenna, which was mounted on the antenna tower.
4. The table was rotated 360 degrees to determine the position of the highest spurious emission.
5. The height of the receiving antenna is varied between one meter and four meters to search the maximum spurious emission for both horizontal and vertical polarizations.
6. Make the measurement with the spectrum analyzer's RBW = 1MHz, VBW = 3MHz, taking the record of maximum spurious emission.
7. A horn antenna was substituted in place of the EUT and was driven by a signal generator.
8. Tune the output power of signal generator to the same emission level with EUT maximum spurious emission.
9. Taking the record of output power at antenna port.
10. Repeat step 7 to step 8 for another polarization.
11. The RF fundamental frequency should be excluded against the limit line in the operating frequency band.

The limit line is derived from $43 + 10\log(P)$ dB below the transmitter power P(Watts)
 $= P(W) - [43 + 10\log(P)]$ (dB)
 $= [30 + 10\log(P)]$ (dBm) - $[43 + 10\log(P)]$ (dB)
 $= -13$ dBm.

For Band 7:

The limit line is derived from $55 + 10\log(P)$ dB below the transmitter power P(Watts)

12. EIRP (dBm) = S.G. Power – Tx Cable Loss + Tx Antenna Gain
13. ERP (dBm) = EIRP - 2.15



5 List of Measuring Equipment

Instrument	Manufacturer	Model No.	Serial No.	Characteristics	Calibration Date	Test Date	Due Date	Remark
LTE Base Station	Anritsu	MT8820C	6201432821	GSM/GPRS /WCDMA/LTE	Oct. 16, 2015	Jan. 22, 2016 ~ Mar. 25, 2016	Oct. 15, 2016	Conducted (TH05-HY)
Spectrum Analyzer	Rohde & Schwarz	FSV40	101397	10Hz~40GHz	Sep. 11, 2015	Jan. 22, 2016 ~ Mar. 25, 2016	Sep. 10, 2016	Conducted (TH05-HY)
Temperature Chamber	ESPEC	SH-641	92013720	-30°C ~70°C	Sep. 08, 2015	Jan. 22, 2016 ~ Mar. 25, 2016	Sep. 07, 2016	Conducted (TH05-HY)
Hygrometer	Testo	608-H1	34897199	N/A	May 04, 2015	Jan. 22, 2016 ~ Mar. 25, 2016	May 03, 2016	Conducted (TH05-HY)
RF Cable	JYEBAO	K30K30-5003-0.5M40	N/A	0.1MHz~40GHz	Mar. 23, 2015	Jan. 22, 2016 ~ Mar. 21, 2016	Mar. 22, 2016	Conducted (TH05-HY)
RF Cable	JYEBAO	K30K30-5003-0.5M40	N/A	0.1MHz~40GHz	Mar. 22, 2016	Mar. 23, 2016 ~ Mar. 25, 2016	Mar. 21, 2017	Conducted (TH05-HY)
Amplifier	SONOMA	310N	187312	9kHz~1GHz	Nov. 20, 2015	Feb. 16, 2016 ~ Mar. 24, 2016	Nov. 19, 2016	Radiation (03CH11-HY)
Bilog Antenna	TESEQ	CBL 6111D	35414	30MHz~1GHz	Nov. 17, 2015	Feb. 16, 2016 ~ Mar. 24, 2016	Nov. 16, 2016	Radiation (03CH11-HY)
Horn Antenna	SCHWARZBECK	BBHA 9120 D	9120D-1326	1GHz ~ 18GHz	Oct. 08, 2015	Feb. 16, 2016 ~ Mar. 24, 2016	Oct. 07, 2016	Radiation (03CH11-HY)
SHF-EHF Horn Antenna	SCHWARZBECK	BBHA 9170	BBHA9170584	18GHz- 40GHz	Nov. 02, 2015	Feb. 16, 2016 ~ Mar. 24, 2016	Nov. 01, 2016	Radiation (03CH11-HY)
Hygrometer	TECPEL	DTN-303B	TP140325	N/A	Nov. 17, 2015	Feb. 16, 2016 ~ Mar. 24, 2016	Nov. 16, 2016	Radiation (03CH11-HY)
Preamplifier	Keysight	83017A	MY53270080	1GHz~26.5GHz	Nov. 19, 2015	Feb. 16, 2016 ~ Mar. 24, 2016	Nov. 18, 2016	Radiation (03CH11-HY)
Preamplifier	MITEQ	AMF-7D-0010 1800-30-10P	1902247	1GHz~18GHz	Jul. 01, 2015	Feb. 16, 2016 ~ Mar. 24, 2016	Jun. 30, 2016	Radiation (03CH11-HY)
Spectrum Analyzer	Keysight	N9010A	MY54200486	10Hz ~ 44GHz	Sep. 24, 2015	Feb. 16, 2016 ~ Mar. 24, 2016	Sep. 23, 2016	Radiation (03CH11-HY)
Controller	EMEC	EM 1000	N/A	Control Turn table & Ant Mast	N/A	Feb. 16, 2016 ~ Mar. 24, 2016	N/A	Radiation (03CH11-HY)
Antenna Mast	EMEC	AM-BS-4500-B	N/A	1~4m	N/A	Feb. 16, 2016 ~ Mar. 24, 2016	N/A	Radiation (03CH11-HY)
Turn Table	EMEC	TT 2000	N/A	0-360 degree	N/A	Feb. 16, 2016 ~ Mar. 24, 2016	N/A	Radiation (03CH11-HY)
Preamplifier	MITEQ	JS44-1800400 0-33-8P	1840917	18GHz ~ 40GHz	Jun. 02, 2015	Feb. 16, 2016 ~ Mar. 24, 2016	Jun. 01, 2016	Radiation (03CH11-HY)
RF Cable	HUBER + SUHNER	SUCOFLEX 104	MY9837/4 MY28419/4MY 28654/4	30MHz~40GHz	Nov. 05, 2015	Feb. 16, 2016 ~ Mar. 24, 2016	Nov. 04, 2016	Radiation (03CH11-HY)
RF Cable	HUBER + SUHNER	SUCOFLEX 104	MY9837/4 MY28419/4MY 28654/4	9kHz~30MHz	Sep. 14, 2015	Feb. 16, 2016 ~ Mar. 24, 2016	Sep. 13, 2016	Radiation (03CH11-HY)



Instrument	Manufacturer	Model No.	Serial No.	Characteristics	Calibration Date	Test Date	Due Date	Remark
Filter	Wainwright	WLKS1200-8S S	SN3	1.2G Low Pass	Sep. 29, 2015	Feb. 16, 2016 ~ Mar.. 24, 2016	Sep. 28, 2016	Radiation (03CH11-HY)
Filter	Wainwright	WHK1.5/15G-1 0SS	SN32	1.5G High Pass	Sep. 29, 2015	Feb. 16, 2016 ~ Mar.. 24, 2016	Sep. 28, 2016	Radiation (03CH11-HY)
Filter	Microwave	H3G018G1	SN477220	3.0G High Pass	Sep. 29, 2015	Feb. 16, 2016 ~ Mar.. 24, 2016	Sep. 28, 2016	Radiation (03CH11-HY)
Notch Filter	Wainwright	WRCT/800/96 0-0.2/40-8SSK	SN11	GSM850	Sep. 29, 2015	Feb. 16, 2016 ~ Mar.. 24, 2016	Sep. 28, 2016	Radiation (03CH11-HY)
Notch Filter	Wainwright	WRCG1710/17 55-1690/1755- 45/7SS	SN2	AWS Band	Sep. 29, 2015	Feb. 16, 2016 ~ Mar.. 24, 2016	Sep. 28, 2016	Radiation (03CH11-HY)
Notch Filter	Wainwright	WRCT1850/19 10-40/8SS	SN21	1900	Sep. 29, 2015	Feb. 16, 2016 ~ Mar.. 24, 2016	Sep. 28, 2016	Radiation (03CH11-HY)
Notch Filter	Wainwright	WRCT2500/25 70-10/40-10SS K	SN1 R	LTE Band7	Sep. 29, 2015	Feb. 16, 2016 ~ Mar.. 24, 2016	Sep. 28, 2016	Radiation (03CH11-HY)
Notch Filter	Wainwright	WRCT698/798 -10/40-8SSK	SN1	700	Sep. 29, 2015	Feb. 16, 2016 ~ Mar.. 24, 2016	Sep. 28, 2016	Radiation (03CH11-HY)
Test Software	N/A	E3	6.2009-8-24	N/A	N/A	Feb. 16, 2016 ~ Mar.. 24, 2016	N/A	Radiation (03CH11-HY)



6 Uncertainty of Evaluation

Uncertainty of Radiated Emission Measurement (30 MHz ~ 1000 MHz)

Measuring Uncertainty for a Level of Confidence of 95% ($U = 2Uc(y)$)	4.90
---	------



Appendix A. Test Results of Conducted Test

Conducted Output Power(Average power)

LTE Band 2 Maximum Average Power [dBm]						
BW [MHz]	RB Size	RB Offset	Mod	Lowest	Middle	Highest
20	1	0	QPSK	23.23	23.15	23.16
20	1	49		23.12	23.07	22.82
20	1	99		22.90	22.77	22.35
20	50	0		22.21	22.21	22.18
20	50	24		22.20	22.16	22.08
20	50	50		22.19	22.00	21.91
20	100	0		22.19	22.15	22.12
20	1	0	16-QAM	22.47	22.28	22.38
20	1	49		22.34	22.32	22.15
20	1	99		22.24	22.11	21.67
20	50	0		21.23	21.20	21.23
20	50	24		21.19	21.21	21.16
20	50	50		21.19	21.08	21.01
20	100	0		21.20	21.17	21.19
15	1	0	QPSK	23.19	23.13	23.14
15	1	37		23.11	23.12	22.81
15	1	74		23.09	22.95	22.50
15	36	0		22.20	22.18	22.19
15	36	20		21.99	22.18	22.10
15	36	39		22.17	22.12	21.93
15	75	0		22.16	22.17	22.10
15	1	0	16-QAM	22.42	22.26	22.30
15	1	37		22.31	22.31	22.10
15	1	74		22.24	22.24	21.81
15	36	0		21.23	21.19	21.23
15	36	20		21.20	21.20	21.18
15	36	39		21.18	21.17	21.03
15	75	0		21.19	21.20	21.18



LTE Band 2 Maximum Average Power [dBm]						
BW [MHz]	RB Size	RB Offset	Mod	Lowest	Middle	Highest
10	1	0	QPSK	23.15	23.11	22.82
10	1	25		23.11	23.06	22.78
10	1	49		23.02	22.74	22.30
10	25	0		22.17	22.12	22.09
10	25	12		22.11	22.10	22.02
10	25	25		22.08	22.11	21.92
10	50	0		22.13	22.15	22.03
10	1	0	16-QAM	22.39	22.28	22.09
10	1	25		22.31	22.29	22.06
10	1	49		22.24	22.03	21.60
10	25	0		21.21	21.15	21.14
10	25	12		21.14	21.13	21.11
10	25	25		21.10	21.14	21.01
10	50	0		21.18	21.16	21.12
5	1	0	QPSK	23.13	23.09	23.02
5	1	12		23.12	23.07	22.60
5	1	24		23.00	23.01	22.67
5	12	0		22.18	22.14	21.95
5	12	7		22.17	22.13	21.81
5	12	13		22.15	22.13	21.78
5	25	0		22.13	22.11	21.85
5	1	0	16-QAM	22.34	22.25	22.24
5	1	12		22.33	22.29	21.83
5	1	24		22.22	22.22	21.99
5	12	0		21.23	21.17	21.01
5	12	7		21.23	21.16	20.87
5	12	13		21.19	21.18	20.85
5	25	0		21.16	21.13	20.92



LTE Band 2 Maximum Average Power [dBm]						
BW [MHz]	RB Size	RB Offset	Mod	Lowest	Middle	Highest
3	1	0	QPSK	23.01	22.93	22.77
3	1	8		22.99	22.98	22.54
3	1	14		22.92	22.93	22.46
3	8	0		22.08	22.06	21.87
3	8	4		22.05	22.03	21.84
3	8	7		22.05	22.03	21.81
3	15	0		22.07	22.05	21.82
3	1	0	16-QAM	22.20	22.10	21.99
3	1	8		22.17	22.16	21.78
3	1	14		22.11	22.11	21.72
3	8	0		21.17	21.11	20.95
3	8	4		21.14	21.09	20.93
3	8	7		21.13	21.10	20.94
3	15	0		21.11	21.09	20.93
1.4	1	0	QPSK	23.11	22.95	22.43
1.4	1	3		23.09	23.03	22.34
1.4	1	5		22.98	22.97	22.38
1.4	3	0		23.01	23.05	22.38
1.4	3	1		23.07	23.03	22.34
1.4	3	3		23.05	23.02	22.34
1.4	6	0		22.06	22.03	21.58
1.4	1	0	16-QAM	22.27	22.11	21.66
1.4	1	3		22.20	22.20	21.61
1.4	1	5		22.16	22.12	21.67
1.4	3	0		22.08	22.00	21.48
1.4	3	1		22.03	21.97	21.46
1.4	3	3		22.02	21.95	21.47
1.4	6	0		21.18	21.13	20.74



LTE Band 4 Maximum Average Power [dBm]						
BW [MHz]	RB Size	RB Offset	Mod	Lowest	Middle	Highest
20	1	0	QPSK	23.69	23.35	23.28
20	1	49		23.49	23.17	23.12
20	1	99		23.34	23.03	22.97
20	50	0		22.68	22.41	22.27
20	50	24		22.61	22.32	22.20
20	50	50		22.55	22.20	22.12
20	100	0		22.61	22.31	22.16
20	1	0	16-QAM	22.78	22.46	22.37
20	1	49		22.61	22.30	22.27
20	1	99		22.42	22.14	22.05
20	50	0		21.60	21.28	21.26
20	50	24		21.54	21.23	21.19
20	50	50		21.44	21.17	21.12
20	100	0		21.51	21.21	21.15
15	1	0	QPSK	23.05	23.29	23.08
15	1	37		22.95	23.11	23.07
15	1	74		22.89	23.02	22.99
15	36	0		22.01	22.27	22.21
15	36	20		22.06	22.22	22.14
15	36	39		21.97	22.14	22.09
15	75	0		21.89	22.32	22.15
15	1	0	16-QAM	22.20	22.37	22.29
15	1	37		22.26	22.24	22.26
15	1	74		21.89	22.16	22.06
15	36	0		21.17	21.26	21.20
15	36	20		21.02	21.18	21.17
15	36	39		21.03	21.12	21.06
15	75	0		21.06	21.14	21.16



LTE Band 4 Maximum Average Power [dBm]						
BW [MHz]	RB Size	RB Offset	Mod	Lowest	Middle	Highest
10	1	0	QPSK	23.07	23.05	23.14
10	1	25		23.00	22.98	23.04
10	1	49		22.93	22.89	22.97
10	25	0		22.07	22.07	22.14
10	25	12		22.05	22.02	22.09
10	25	25		22.01	22.00	22.05
10	50	0		22.11	22.05	22.13
10	1	0	16-QAM	22.26	22.12	22.30
10	1	25		22.20	22.07	22.21
10	1	49		22.08	22.02	22.08
10	25	0		21.09	21.03	21.17
10	25	12		21.04	20.99	21.09
10	25	25		21.01	20.98	21.05
10	50	0		21.08	21.03	21.13
5	1	0	QPSK	22.96	23.01	23.04
5	1	12		22.95	22.99	23.03
5	1	24		22.83	22.88	22.93
5	12	0		22.03	22.05	22.08
5	12	7		21.99	22.03	22.07
5	12	13		21.97	22.02	22.07
5	25	0		21.95	22.02	22.05
5	1	0	16-QAM	22.14	22.10	22.21
5	1	12		22.13	22.08	22.20
5	1	24		22.01	22.01	22.06
5	12	0		21.05	21.03	21.09
5	12	7		21.02	21.00	21.06
5	12	13		20.99	21.00	21.06
5	25	0		20.95	20.98	21.05



LTE Band 4 Maximum Average Power [dBm]						
BW [MHz]	RB Size	RB Offset	Mod	Lowest	Middle	Highest
3	1	0	QPSK	22.83	23.14	22.97
3	1	8		22.88	23.09	23.02
3	1	14		22.84	23.08	22.91
3	8	0		21.99	22.24	22.05
3	8	4		21.91	22.23	22.06
3	8	7		21.95	22.21	22.06
3	15	0		22.01	22.19	22.05
3	1	0	16-QAM	22.11	22.26	22.10
3	1	8		22.15	22.24	22.10
3	1	14		22.07	22.19	22.03
3	8	0		21.04	21.19	21.11
3	8	4		21.08	21.19	21.05
3	8	7		21.10	21.17	21.06
3	15	0		20.95	21.18	21.12
1.4	1	0	QPSK	22.92	23.23	23.01
1.4	1	3		22.99	23.21	23.07
1.4	1	5		22.89	23.11	22.99
1.4	3	0		23.02	23.13	23.11
1.4	3	1		22.97	23.18	23.07
1.4	3	3		22.97	23.18	23.06
1.4	6	0		21.98	22.22	22.08
1.4	1	0	16-QAM	22.11	22.32	22.12
1.4	1	3		22.19	22.22	22.19
1.4	1	5		22.07	22.20	22.09
1.4	3	0		21.96	22.13	22.01
1.4	3	1		21.93	22.06	21.96
1.4	3	3		21.91	22.06	21.95
1.4	6	0		21.05	21.23	21.13



LTE Band 5 Maximum Average Power [dBm]						
BW [MHz]	RB Size	RB Offset	Mod	Lowest	Middle	Highest
10	1	0	QPSK	23.22	23.39	23.16
10	1	25		23.21	23.24	23.23
10	1	49		23.24	23.18	23.18
10	25	0		22.49	22.33	22.41
10	25	12		22.45	22.36	22.39
10	25	25		22.53	22.37	22.45
10	50	0		22.23	22.21	22.14
10	1	0	16-QAM	22.55	22.68	22.39
10	1	25		22.50	22.44	22.49
10	1	49		22.58	22.44	22.46
10	25	0		21.89	21.73	21.90
10	25	12		21.86	21.65	21.89
10	25	25		21.80	21.55	21.78
10	50	0		21.53	21.25	21.36
5	1	0	QPSK	23.30	23.16	23.18
5	1	12		23.26	23.21	23.10
5	1	24		23.20	23.05	23.21
5	12	0		22.55	22.50	22.50
5	12	7		22.42	22.42	22.41
5	12	13		22.58	22.45	22.37
5	25	0		22.35	22.26	22.31
5	1	0	16-QAM	22.59	22.33	22.46
5	1	12		22.56	22.37	22.51
5	1	24		22.51	22.45	22.40
5	12	0		21.79	21.68	21.69
5	12	7		21.72	21.51	21.60
5	12	13		21.68	21.54	21.62
5	25	0		21.43	21.31	21.48



LTE Band 5 Maximum Average Power [dBm]						
BW [MHz]	RB Size	RB Offset	Mod	Lowest	Middle	Highest
3	1	0	QPSK	23.29	23.13	23.18
3	1	8		23.26	23.28	23.12
3	1	14		23.28	23.12	23.18
3	8	0		22.41	22.30	22.35
3	8	4		22.45	22.20	22.27
3	8	7		22.47	22.29	22.40
3	15	0		22.41	22.22	22.25
3	1	0	16-QAM	22.42	22.27	22.53
3	1	8		22.52	22.51	22.35
3	1	14		22.38	22.43	22.48
3	8	0		21.56	21.53	21.53
3	8	4		21.65	21.55	21.53
3	8	7		21.51	21.37	21.47
3	15	0		21.40	21.30	21.35
1.4	1	0	QPSK	23.30	23.09	23.11
1.4	1	3		23.20	23.18	23.20
1.4	1	5		23.20	23.11	23.14
1.4	3	0		22.48	22.35	22.39
1.4	3	1		22.43	22.31	22.37
1.4	3	3		22.44	22.30	22.36
1.4	6	0		22.33	22.20	22.23
1.4	1	0	16-QAM	22.60	22.36	22.44
1.4	1	3		22.50	22.45	22.56
1.4	1	5		22.48	22.39	22.47
1.4	3	0		21.65	21.52	21.61
1.4	3	1		21.62	21.48	21.59
1.4	3	3		21.60	21.45	21.56
1.4	6	0		21.45	21.30	21.38



LTE Band 7 Maximum Average Power [dBm]						
BW [MHz]	RB Size	RB Offset	Mod	Lowest	Middle	Highest
20	1	0	QPSK	23.31	23.60	23.34
20	1	49		23.30	23.42	23.39
20	1	99		23.36	23.50	23.41
20	50	0		22.39	22.42	22.45
20	50	24		22.38	22.46	22.47
20	50	50		22.40	22.50	22.48
20	100	0		22.36	22.43	22.44
20	1	0	16-QAM	22.44	22.70	22.54
20	1	49		22.48	22.64	22.62
20	1	99		22.53	22.66	22.61
20	50	0		21.41	21.42	21.46
20	50	24		21.38	21.47	21.47
20	50	50		21.39	21.49	21.49
20	100	0		21.38	21.42	21.44
15	1	0	QPSK	23.16	23.01	22.78
15	1	37		23.15	23.12	22.85
15	1	74		23.14	23.14	22.89
15	36	0		22.22	22.12	21.92
15	36	20		22.24	22.16	21.96
15	36	39		22.22	22.19	21.96
15	75	0		22.21	22.13	21.93
15	1	0	16-QAM	22.31	22.39	22.06
15	1	37		22.35	22.35	22.14
15	1	74		22.32	22.38	22.13
15	36	0		21.23	21.11	20.93
15	36	20		21.24	21.17	20.98
15	36	39		21.24	21.20	20.99
15	75	0		21.22	21.12	20.94



LTE Band 7 Maximum Average Power [dBm]						
BW [MHz]	RB Size	RB Offset	Mod	Lowest	Middle	Highest
10	1	0	QPSK	22.85	23.03	22.73
10	1	25		22.88	23.00	22.76
10	1	49		22.86	23.01	22.73
10	25	0		21.92	22.01	21.82
10	25	12		21.92	22.05	21.82
10	25	25		21.94	22.07	21.86
10	50	0		21.97	22.07	21.86
10	1	0	16-QAM	22.05	22.29	22.01
10	1	25		22.08	22.24	22.05
10	1	49		22.07	22.28	21.97
10	25	0		20.93	21.01	20.84
10	25	12		20.93	21.04	20.83
10	25	25		20.94	21.07	20.87
10	50	0		20.97	21.07	20.87
5	1	0	QPSK	22.90	23.06	22.74
5	1	12		22.93	23.05	22.77
5	1	24		22.85	23.01	22.70
5	12	0		22.02	22.12	21.89
5	12	7		21.99	22.12	21.89
5	12	13		22.00	22.14	21.90
5	25	0		21.97	22.08	21.83
5	1	0	16-QAM	22.04	22.28	22.00
5	1	12		22.08	22.26	22.02
5	1	24		22.02	22.22	21.92
5	12	0		21.03	21.12	20.92
5	12	7		21.02	21.13	20.91
5	12	13		21.03	21.15	20.91
5	25	0		20.98	21.08	20.85



LTE Band 12 Maximum Average Power [dBm]						
BW [MHz]	RB Size	RB Offset	Mod	Lowest	Middle	Highest
10	1	0	QPSK	23.13	23.29	23.09
10	1	25		23.19	23.16	23.11
10	1	49		23.17	23.12	23.06
10	25	0		22.21	22.21	22.18
10	25	12		22.24	22.23	22.17
10	25	25		22.28	22.22	22.19
10	50	0		22.27	22.23	22.18
10	1	0	16-QAM	22.41	22.62	22.40
10	1	25		22.50	22.51	22.45
10	1	49		22.52	22.41	22.30
10	25	0		21.21	21.25	21.22
10	25	12		21.24	21.27	21.18
10	25	25		21.33	21.25	21.17
10	50	0		21.26	21.25	21.19
5	1	0	QPSK	23.21	23.12	23.04
5	1	12		23.19	23.16	23.07
5	1	24		23.15	23.07	23.01
5	12	0		22.27	22.29	22.19
5	12	7		22.28	22.29	22.19
5	12	13		22.31	22.28	22.18
5	25	0		22.25	22.21	22.15
5	1	0	16-QAM	22.45	22.56	22.40
5	1	12		22.48	22.51	22.36
5	1	24		22.43	22.42	22.28
5	12	0		21.27	21.34	21.18
5	12	7		21.29	21.36	21.18
5	12	13		21.33	21.36	21.18
5	25	0		21.24	21.25	21.14



LTE Band 12 Maximum Average Power [dBm]						
BW [MHz]	RB Size	RB Offset	Mod	Lowest	Middle	Highest
3	1	0	QPSK	23.21	23.07	23.02
3	1	8		23.16	23.14	23.01
3	1	14		23.12	23.04	23.01
3	8	0		22.25	22.25	22.13
3	8	4		22.26	22.26	22.15
3	8	7		22.26	22.23	22.12
3	15	0		22.26	22.25	22.14
3	1	0	16-QAM	22.41	22.50	22.23
3	1	8		22.45	22.48	22.24
3	1	14		22.43	22.41	22.21
3	8	0		21.30	21.36	21.18
3	8	4		21.29	21.37	21.20
3	8	7		21.30	21.36	21.17
3	15	0		21.25	21.30	21.15
1.4	1	0	QPSK	23.27	23.10	23.00
1.4	1	3		23.23	23.18	23.07
1.4	1	5		23.15	23.09	23.00
1.4	3	0		23.25	23.23	23.09
1.4	3	1		23.19	23.18	23.05
1.4	3	3		23.18	23.17	23.05
1.4	6	0		22.27	22.22	22.11
1.4	1	0	16-QAM	22.46	22.59	22.27
1.4	1	3		22.55	22.58	22.35
1.4	1	5		22.42	22.48	22.28
1.4	3	0		22.28	22.32	22.09
1.4	3	1		22.25	22.27	22.06
1.4	3	3		22.22	22.26	22.07
1.4	6	0		21.32	21.36	21.17



LTE Band 17 Maximum Average Power [dBm]						
BW [MHz]	RB Size	RB Offset	Mod	Lowest	Middle	Highest
10	1	0	QPSK	23.20	23.27	23.18
10	1	25		23.22	23.20	23.19
10	1	49		23.15	23.15	23.14
10	25	0		22.28	22.28	22.26
10	25	12		22.29	22.25	22.25
10	25	25		22.28	22.25	22.26
10	50	0		22.32	22.31	22.28
10	1	0	16-QAM	22.51	22.65	22.53
10	1	25		22.60	22.57	22.53
10	1	49		22.44	22.41	22.43
10	25	0		21.32	21.33	21.31
10	25	12		21.34	21.28	21.27
10	25	25		21.29	21.26	21.25
10	50	0		21.34	21.32	21.28
5	1	0	QPSK	23.29	23.17	23.15
5	1	12		23.26	23.21	23.13
5	1	24		23.18	23.12	23.10
5	12	0		22.36	22.33	22.28
5	12	7		22.39	22.32	22.24
5	12	13		22.39	22.33	22.27
5	25	0		22.30	22.25	22.25
5	1	0	16-QAM	22.69	22.56	22.51
5	1	12		22.66	22.60	22.44
5	1	24		22.57	22.47	22.42
5	12	0		21.40	21.38	21.26
5	12	7		21.45	21.36	21.25
5	12	13		21.45	21.35	21.27
5	25	0		21.34	21.28	21.22



LTE Band 2

Peak-to-Average Ratio

Mode	LTE Band 2 / 20MHz				
Mod.	QPSK		16QAM		Limit: 13dB
RB Size	1RB	Full RB	1RB	Full RB	Result
Lowest CH	3.48	4.46	4.7	5.48	PASS
Middle CH	3.13	4.67	3.8	5.62	
Highest CH	3.19	4.12	4.41	5.01	



LTE Band 2 / 20MHz / QPSK

Lowest Channel / 1RB

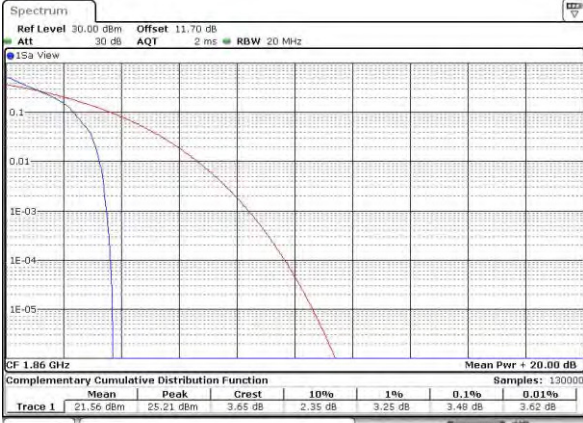

Date: 19 FEB 2016 22:45:29

Lowest Channel / Full RB



Date: 19 FEB 2016 22:45:48

Middle Channel / 1RB



Date: 19 FEB 2016 22:45:59

Middle Channel / Full RB

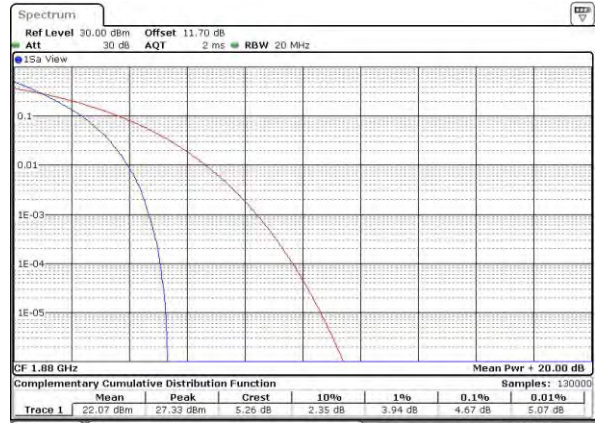

Date: 19 FEB 2016 22:46:12

Highest Channel / 1RB



Date: 19 FEB 2016 22:46:22

Highest Channel / Full RB



Date: 19 FEB 2016 22:46:32



LTE Band 2 / 20MHz / 16QAM

Lowest Channel / 1RB

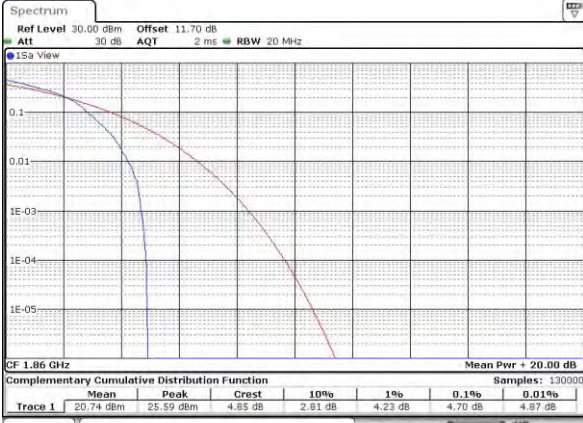

Date: 19 FEB 2016 22:43:48

Lowest Channel / Full RB

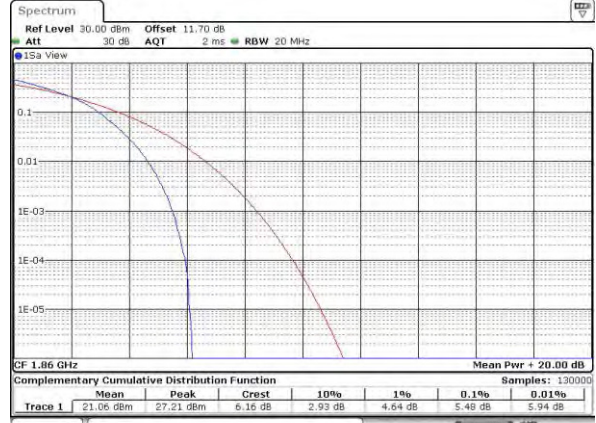

Date: 19 FEB 2016 22:43:58

Middle Channel / 1RB



Date: 19 FEB 2016 22:44:08

Middle Channel / Full RB



Date: 19 FEB 2016 22:44:32

Highest Channel / 1RB



Date: 19 FEB 2016 22:44:47

Highest Channel / Full RB



Date: 19 FEB 2016 22:45:02



26dB Bandwidth

Mode	LTE Band 2 : 26dB BW(MHz)											
	1.4MHz		3MHz		5MHz		10MHz		15MHz		20MHz	
BW	QPSK	16QAM	QPSK	16QAM	QPSK	16QAM	QPSK	16QAM	QPSK	16QAM	QPSK	16QAM
Lowest CH	1.23	1.25	3	2.99	4.94	4.96	9.73	9.81	14.69	14.3	20.42	20.14
Middle CH	1.25	1.27	2.99	2.96	4.96	4.99	9.95	9.71	14.39	14.54	20.22	20.26
Highest CH	1.31	1.28	3	3.02	4.97	4.97	9.89	9.95	14.78	14.45	21.46	20.38



LTE Band 2

Lowest Channel / 1.4MHz / QPSK

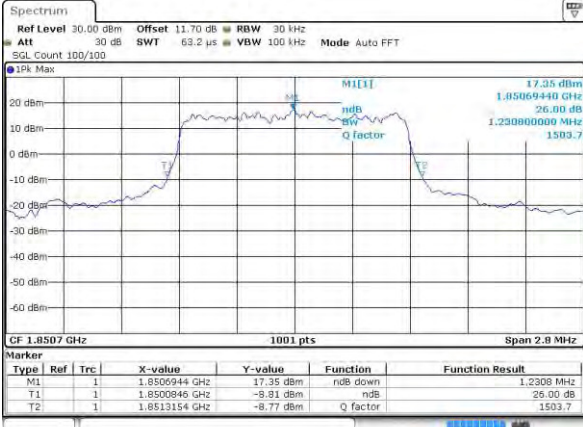

Date: 19 FEB 2016 22:27:14

Lowest Channel / 1.4MHz / 16QAM

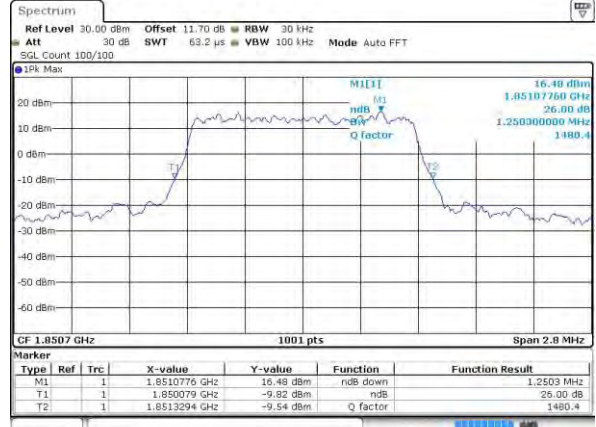

Date: 19 FEB 2016 22:27:25

Middle Channel / 1.4MHz / QPSK

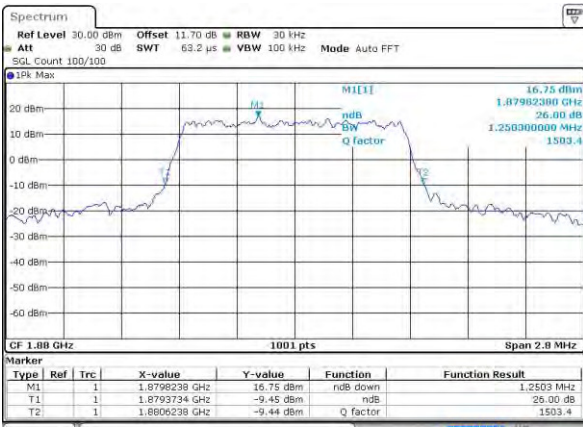

Date: 19 FEB 2016 22:34:23

Middle Channel / 1.4MHz / 16QAM

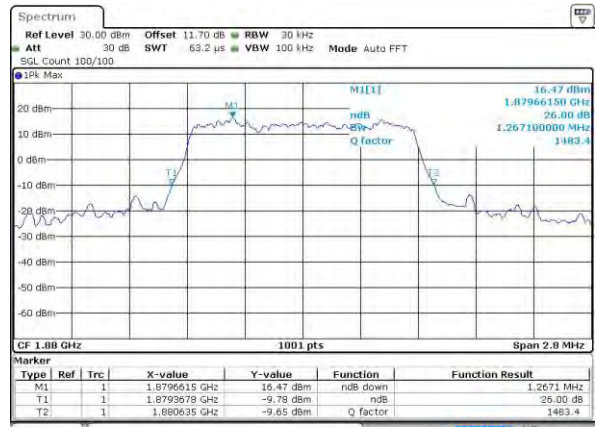

Date: 19 FEB 2016 22:34:34

Highest Channel / 1.4MHz / QPSK

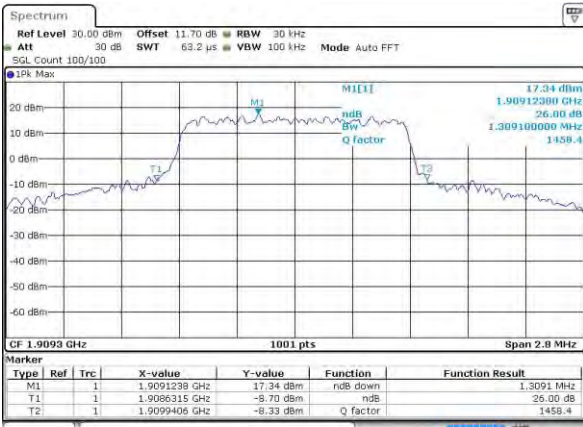

Date: 19 FEB 2016 22:36:55

Highest Channel / 1.4MHz / 16QAM

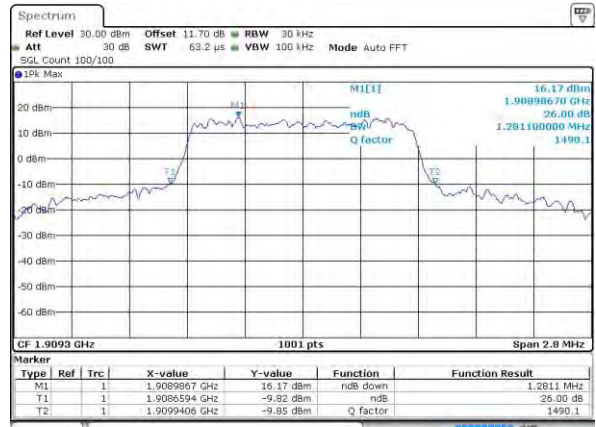

Date: 19 FEB 2016 22:37:06



LTE Band 2

Lowest Channel / 3MHz / QPSK

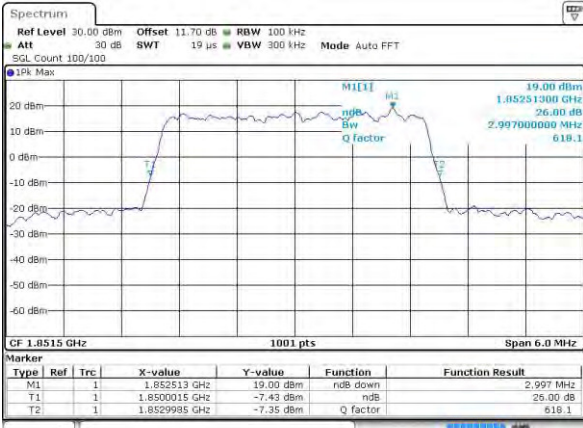

Date: 19 FEB 2016 21:03:05

Lowest Channel / 3MHz / 16QAM

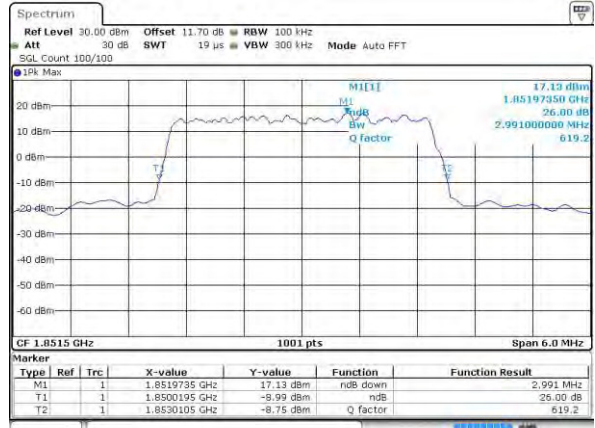

Date: 19 FEB 2016 21:03:16

Middle Channel / 3MHz / QPSK

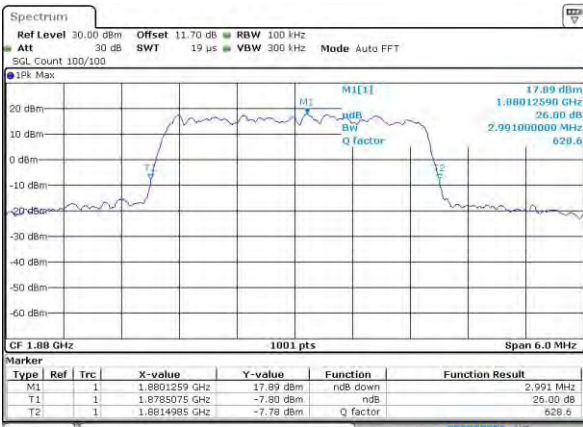

Date: 19 FEB 2016 21:10:15

Middle Channel / 3MHz / 16QAM

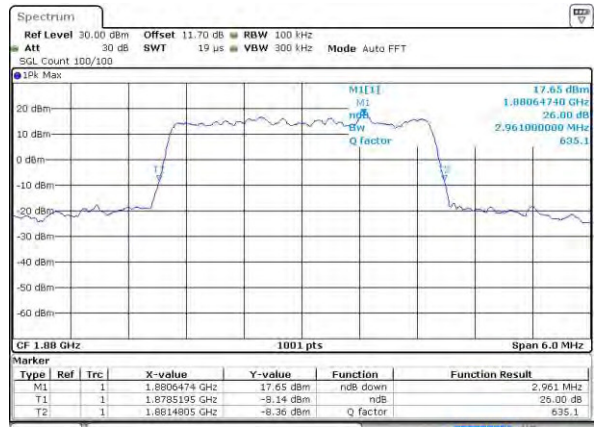

Date: 19 FEB 2016 21:10:25

Highest Channel / 3MHz / QPSK

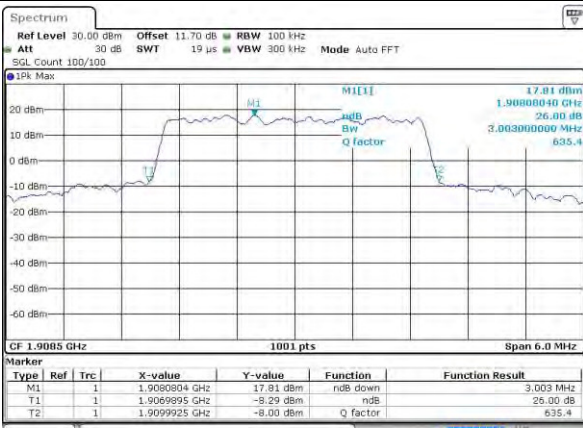

Date: 19 FEB 2016 21:12:46

Highest Channel / 3MHz / 16QAM

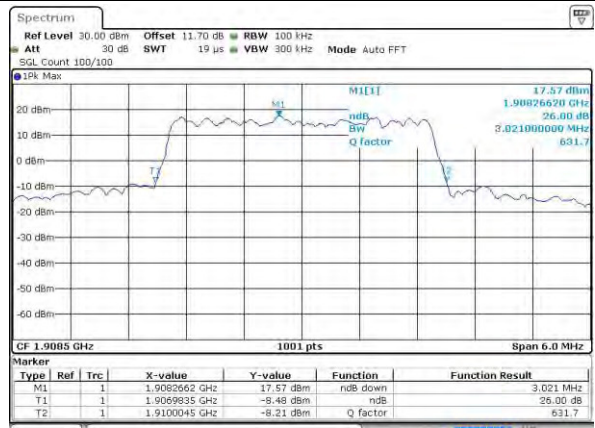

Date: 19 FEB 2016 21:12:57



LTE Band 2

Lowest Channel / 5MHz / QPSK

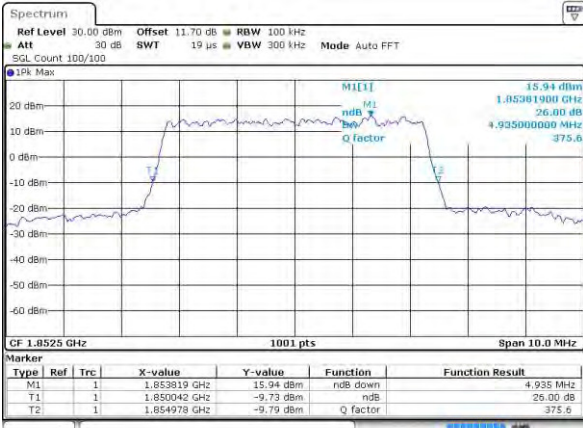

Date: 19 FEB 2016 21:19:55

Lowest Channel / 5MHz / 16QAM

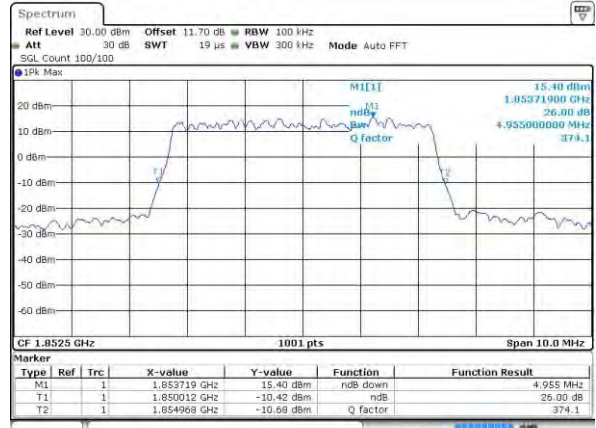

Date: 19 FEB 2016 21:20:06

Middle Channel / 5MHz / QPSK

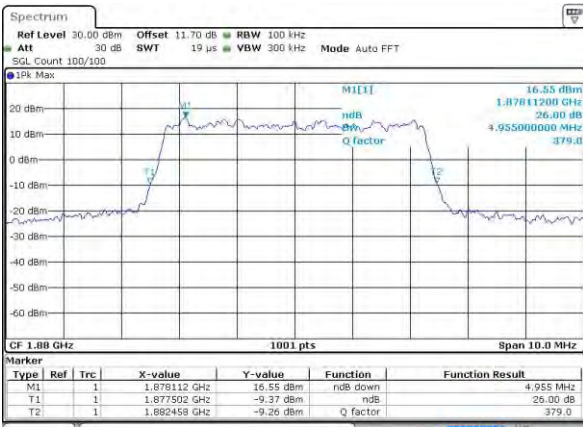

Date: 19 FEB 2016 21:27:04

Middle Channel / 5MHz / 16QAM

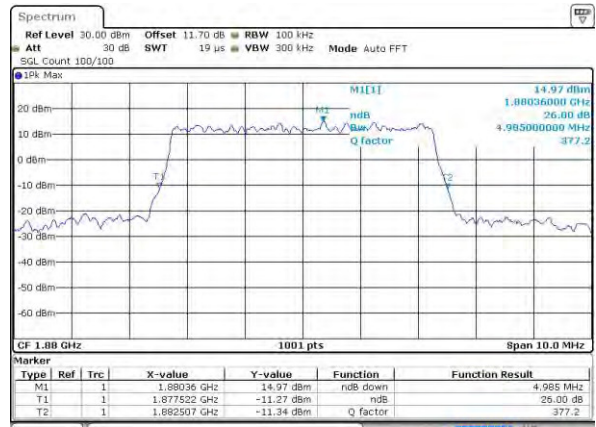

Date: 19 FEB 2016 21:27:15

Highest Channel / 5MHz / QPSK

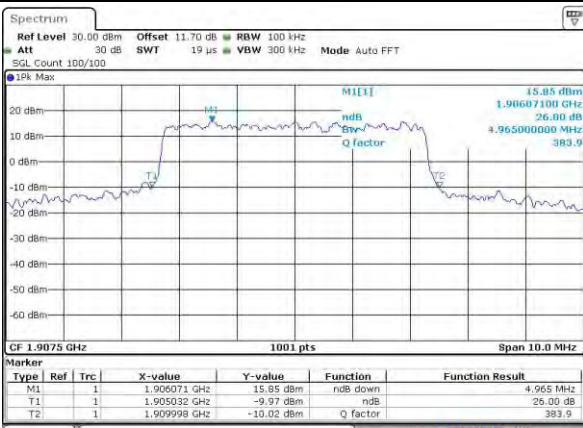

Date: 19 FEB 2016 21:29:36

Highest Channel / 5MHz / 16QAM

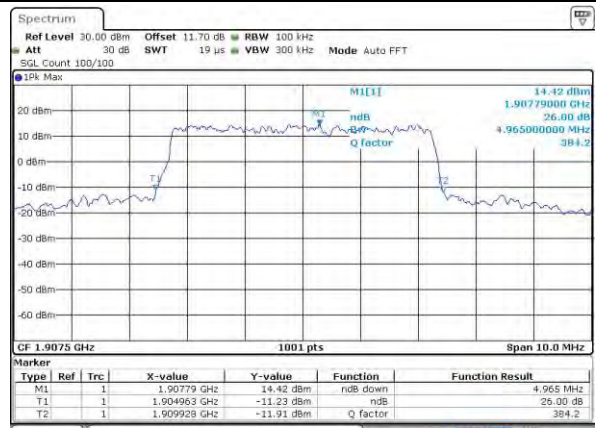

Date: 19 FEB 2016 21:29:46



LTE Band 2

Lowest Channel / 10MHz / QPSK

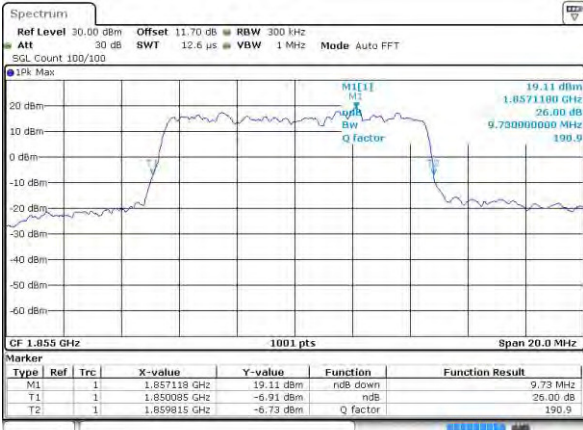

Date: 19 FEB 2016 21:38:45

Lowest Channel / 10MHz / 16QAM

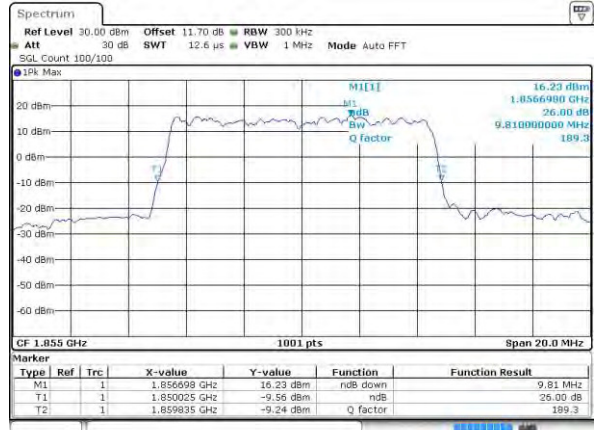

Date: 19 FEB 2016 21:38:55

Middle Channel / 10MHz / QPSK

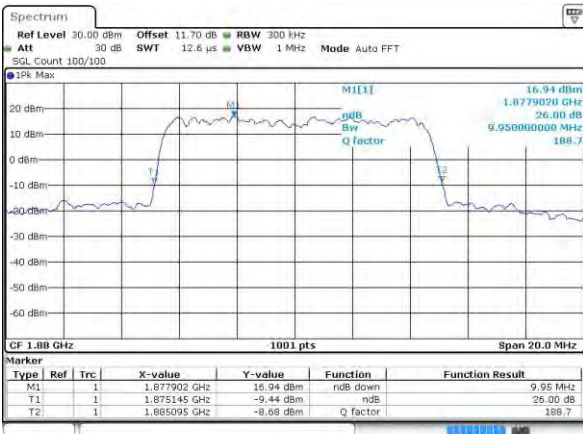

Date: 19 FEB 2016 21:43:54

Middle Channel / 10MHz / 16QAM

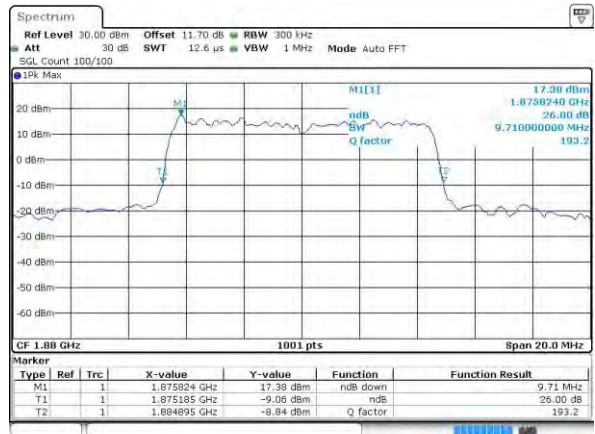

Date: 19 FEB 2016 21:44:05

Highest Channel / 10MHz / QPSK

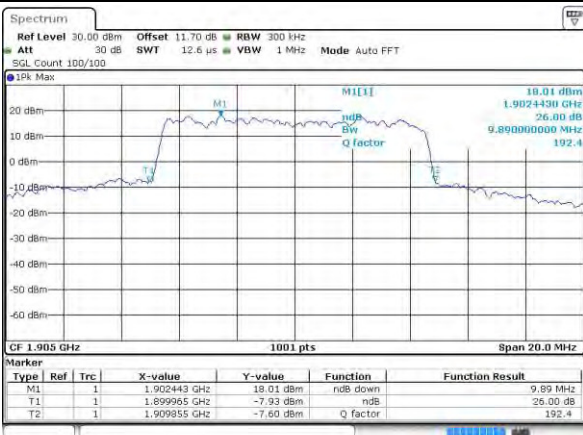

Date: 19 FEB 2016 21:46:28

Highest Channel / 10MHz / 16QAM

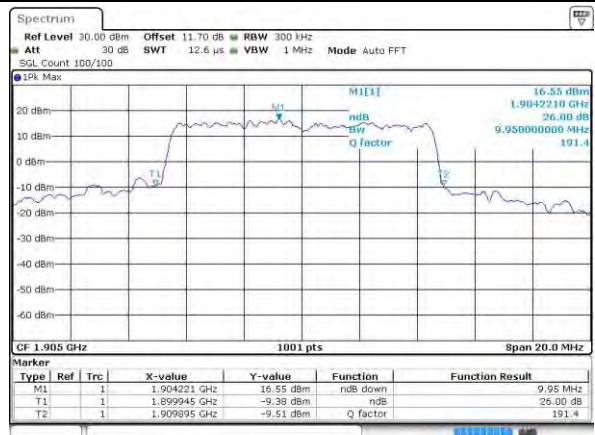

Date: 19 FEB 2016 21:46:36



LTE Band 2

Lowest Channel / 15MHz / QPSK

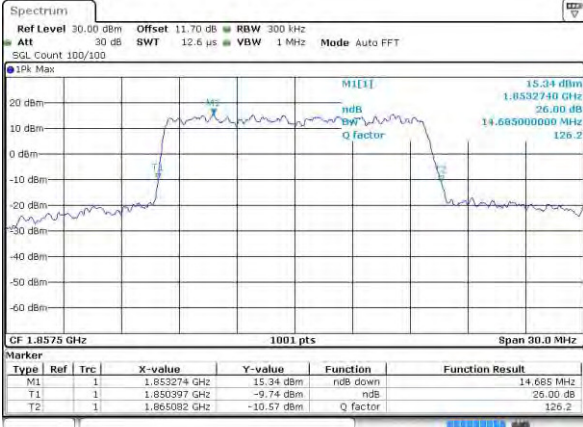

Date: 19 FEB 2016 21:53:35

Lowest Channel / 15MHz / 16QAM

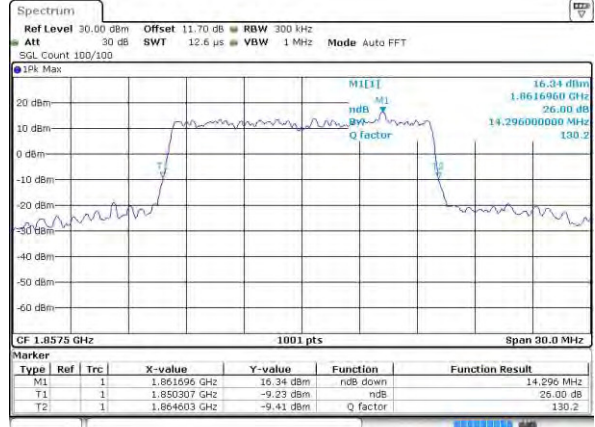

Date: 19 FEB 2016 21:53:45

Middle Channel / 15MHz / QPSK

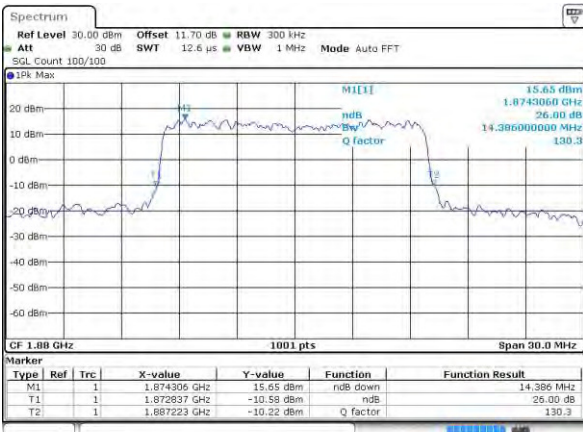

Date: 19 FEB 2016 22:00:44

Middle Channel / 15MHz / 16QAM

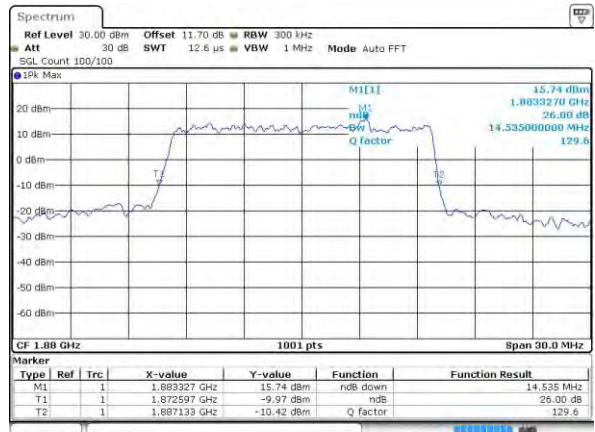

Date: 19 FEB 2016 22:00:54

Highest Channel / 15MHz / QPSK

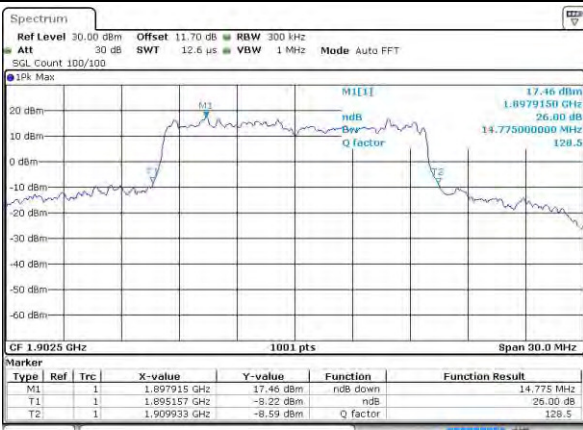

Date: 19 FEB 2016 22:03:16

Highest Channel / 15MHz / 16QAM

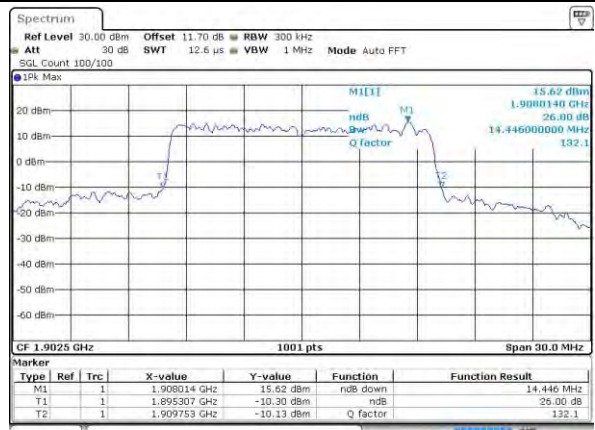

Date: 19 FEB 2016 22:03:26



LTE Band 2

Lowest Channel / 20MHz / QPSK

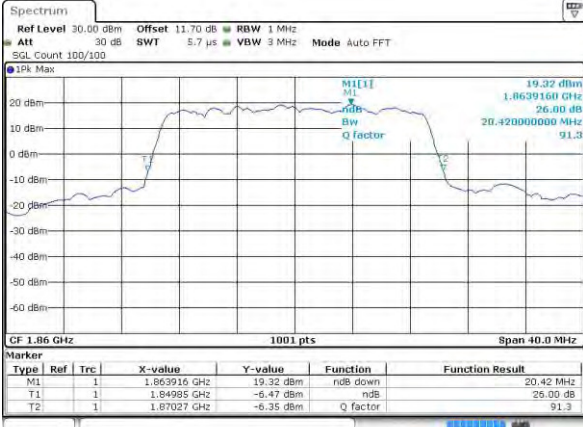

Date: 19 FEB 2016 22:10:25

Lowest Channel / 20MHz / 16QAM

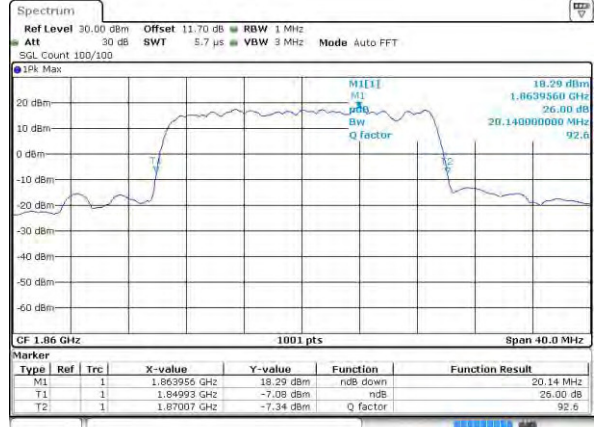

Date: 19 FEB 2016 22:10:35

Middle Channel / 20MHz / QPSK

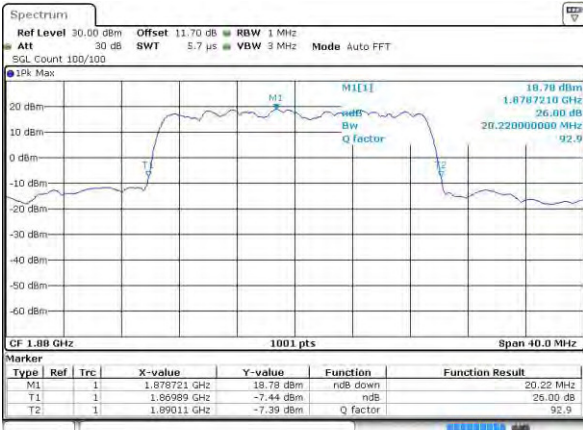

Date: 19 FEB 2016 22:17:33

Middle Channel / 20MHz / 16QAM

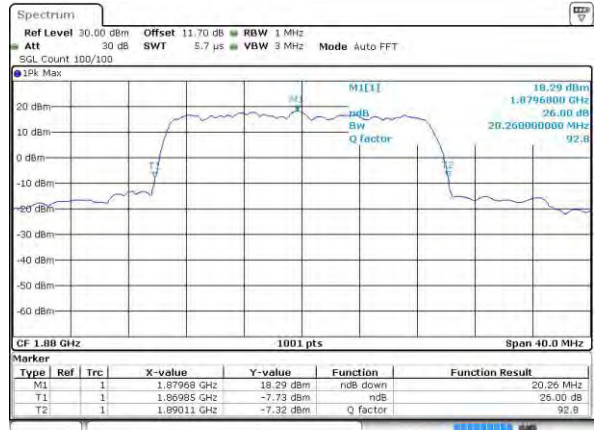

Date: 19 FEB 2016 22:17:44

Highest Channel / 20MHz / QPSK

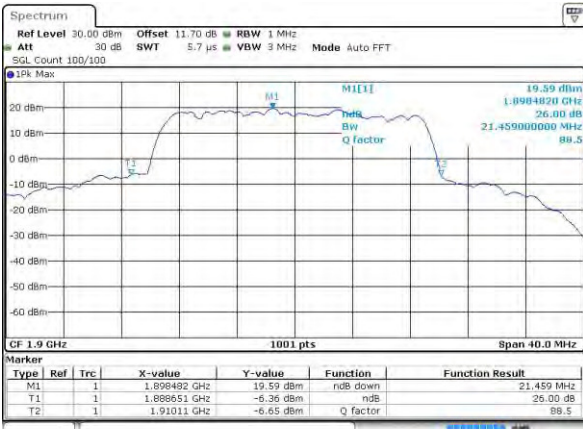

Date: 19 FEB 2016 22:20:05

Highest Channel / 20MHz / 16QAM

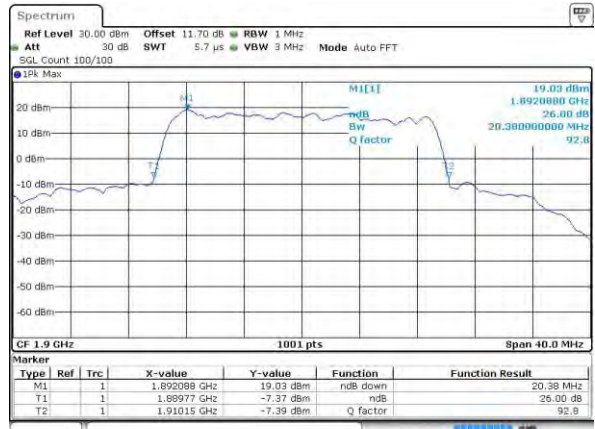

Date: 19 FEB 2016 22:20:16



Occupied Bandwidth

Mode	LTE Band 2 : 99%OBW(MHz)											
	1.4MHz		3MHz		5MHz		10MHz		15MHz		20MHz	
BW	QPSK	16QAM	QPSK	16QAM	QPSK	16QAM	QPSK	16QAM	QPSK	16QAM	QPSK	16QAM
Lowest CH	1.1	1.1	2.73	2.73	4.5	4.47	9.05	9.07	13.49	13.4	18.34	18.3
Middle CH	1.1	1.1	2.72	2.71	4.5	4.48	9.07	9.01	13.49	13.46	18.38	18.46
Highest CH	1.1	1.09	2.73	2.74	4.51	4.51	9.15	9.07	13.49	13.46	18.42	18.46



LTE Band 2

Lowest Channel / 1.4MHz / QPSK

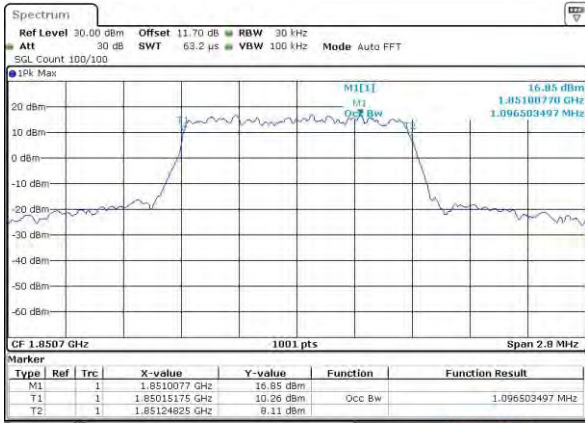

Date: 19 FEB 2016 22:28:53

Lowest Channel / 1.4MHz / 16QAM

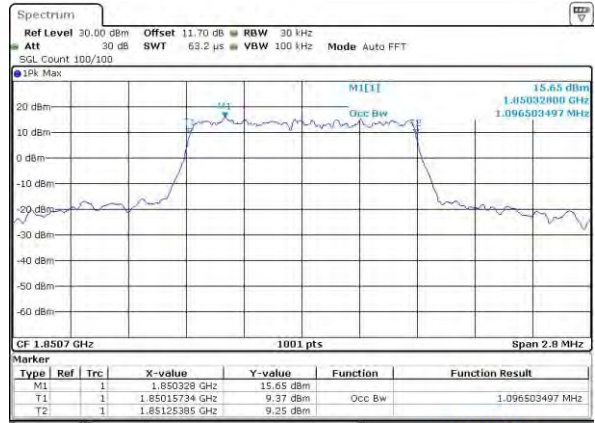

Date: 19 FEB 2016 22:27:04

Middle Channel / 1.4MHz / QPSK

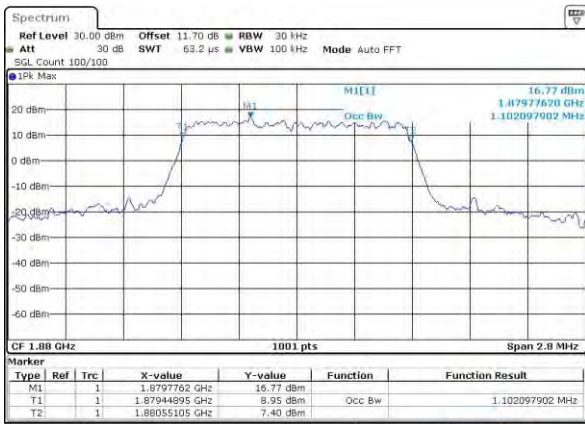

Date: 19 FEB 2016 22:34:02

Middle Channel / 1.4MHz / 16QAM

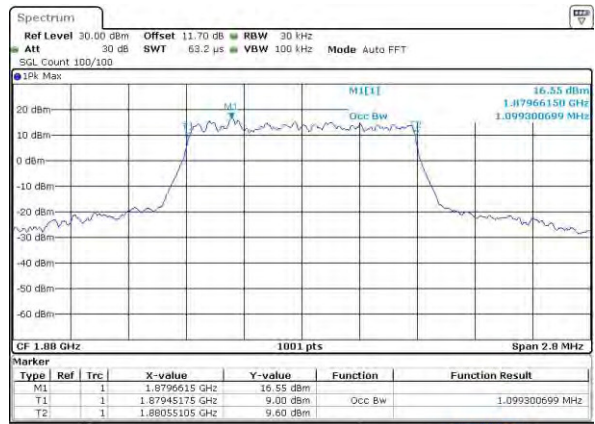

Date: 19 FEB 2016 22:34:13

Highest Channel / 1.4MHz / QPSK

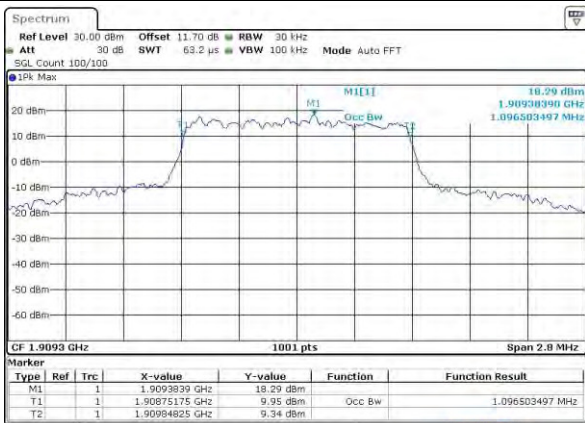

Date: 19 FEB 2016 22:36:34

Highest Channel / 1.4MHz / 16QAM

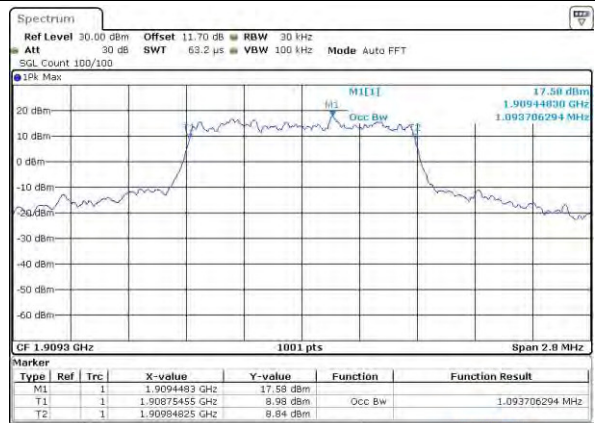

Date: 19 FEB 2016 22:36:45



LTE Band 2

Lowest Channel / 3MHz / QPSK

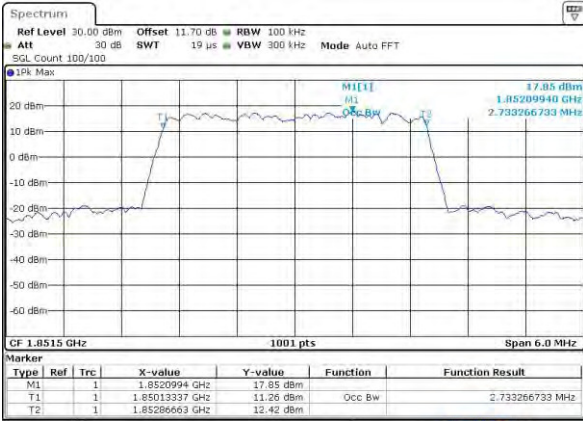

Date: 19 FEB 2016 21:02:44

Lowest Channel / 3MHz / 16QAM

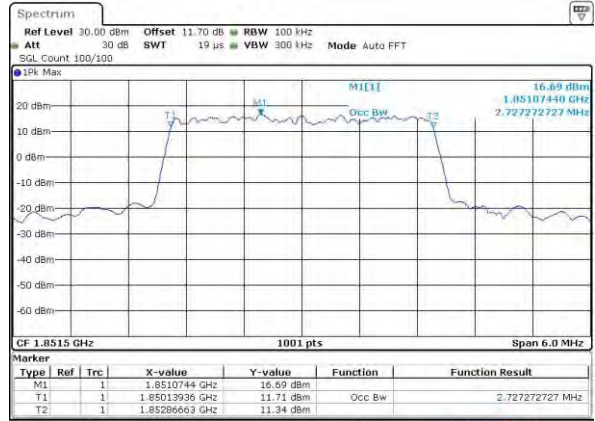

Date: 19 FEB 2016 21:02:55

Middle Channel / 3MHz / QPSK

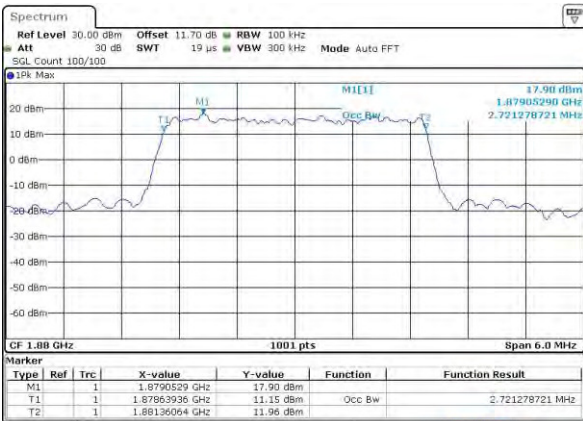

Date: 19 FEB 2016 21:09:53

Middle Channel / 3MHz / 16QAM

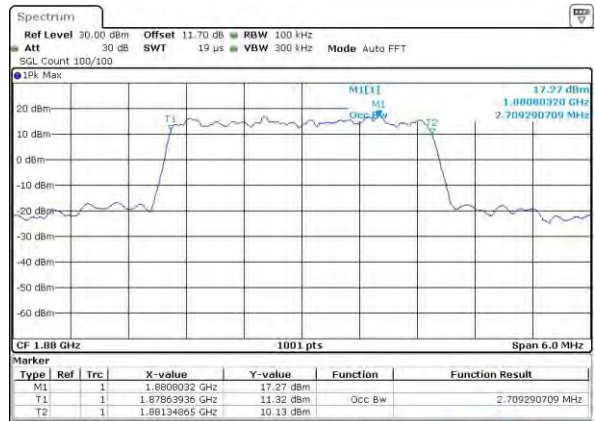

Date: 19 FEB 2016 21:10:04

Highest Channel / 3MHz / QPSK

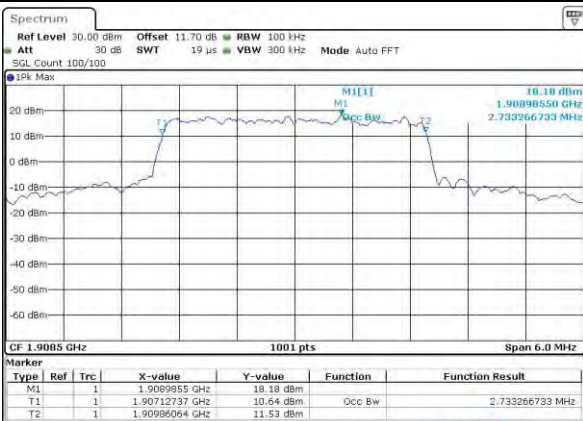

Date: 19 FEB 2016 21:12:25

Highest Channel / 3MHz / 16QAM

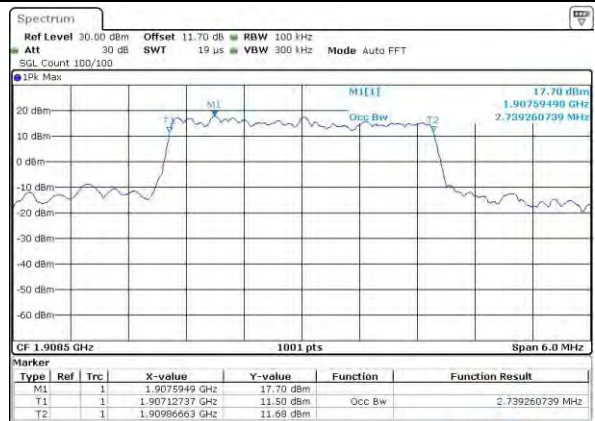

Date: 19 FEB 2016 21:12:36



LTE Band 2

Lowest Channel / 5MHz / QPSK

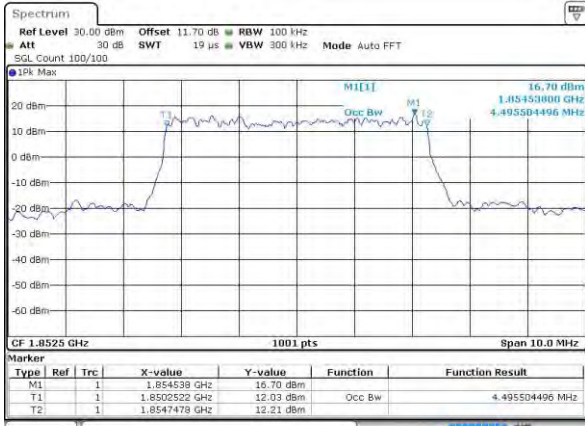

Date: 19 FEB 2016 21:19:34

Lowest Channel / 5MHz / 16QAM

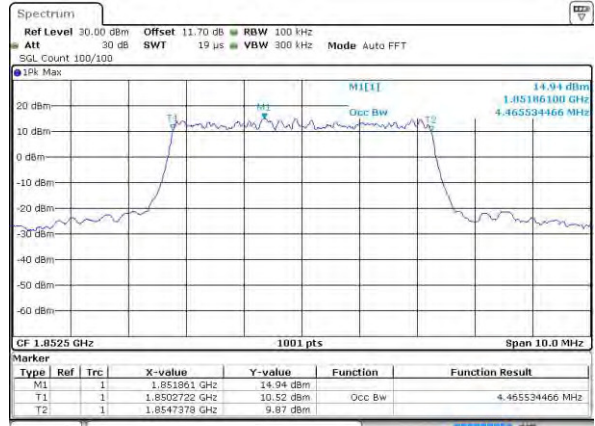

Date: 19 FEB 2016 21:19:45

Middle Channel / 5MHz / QPSK

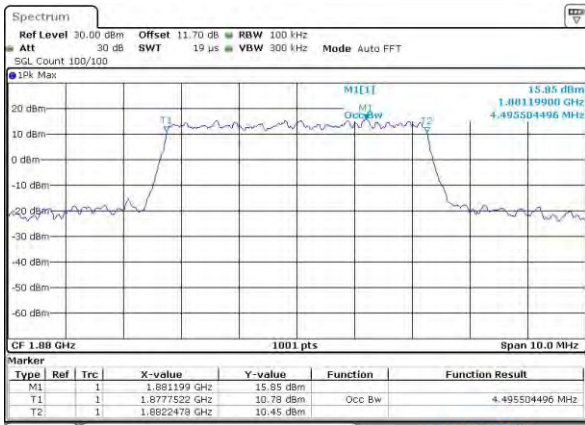

Date: 19 FEB 2016 21:28:43

Middle Channel / 5MHz / 16QAM

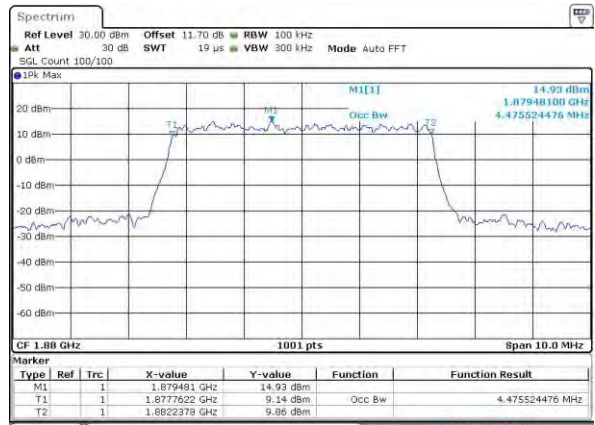

Date: 19 FEB 2016 21:28:54

Highest Channel / 5MHz / QPSK

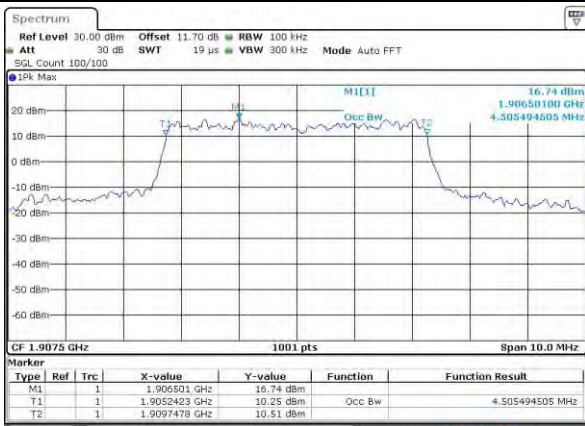

Date: 19 FEB 2016 21:29:15

Highest Channel / 5MHz / 16QAM

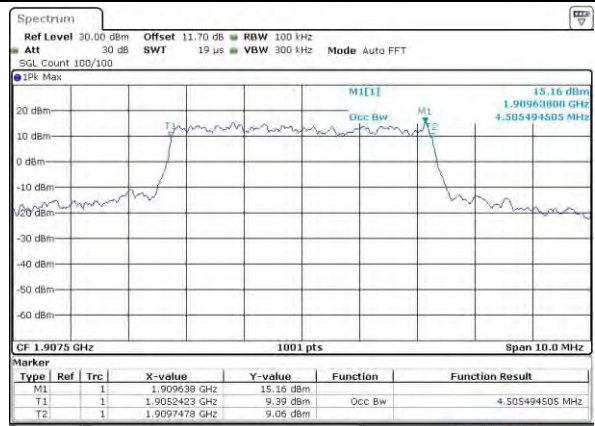

Date: 19 FEB 2016 21:29:25



LTE Band 2

Lowest Channel / 10MHz / QPSK

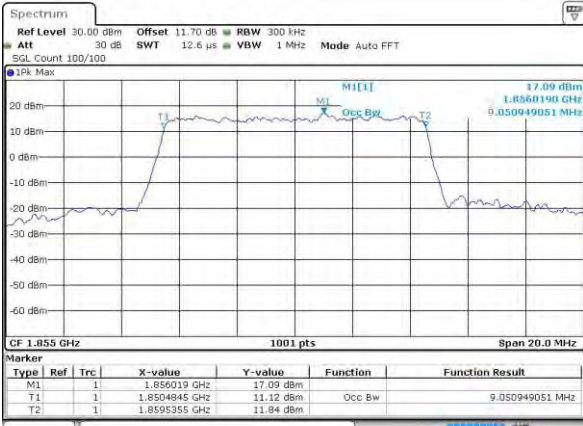

Date: 19 FEB 2016 21:38:24

Lowest Channel / 10MHz / 16QAM

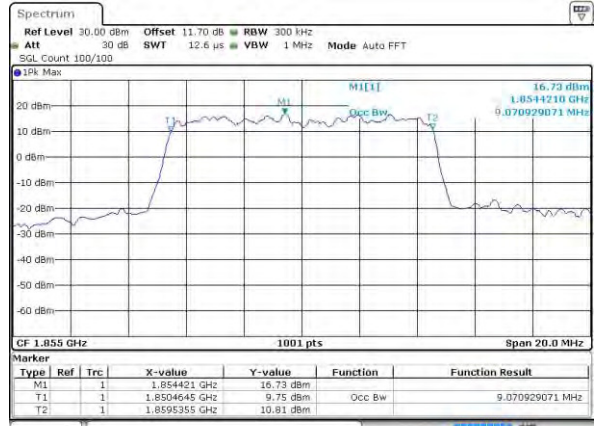

Date: 19 FEB 2016 21:38:34

Middle Channel / 10MHz / QPSK

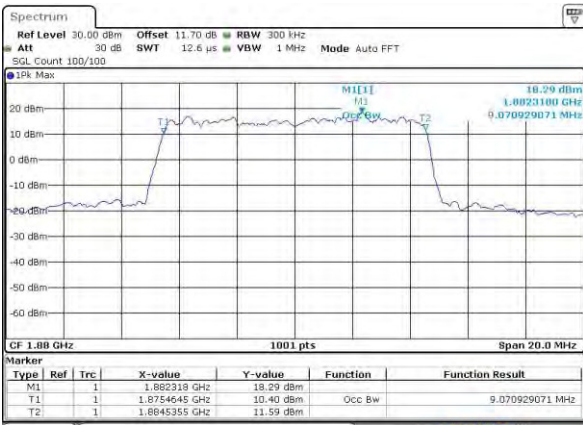

Date: 19 FEB 2016 21:43:33

Middle Channel / 10MHz / 16QAM

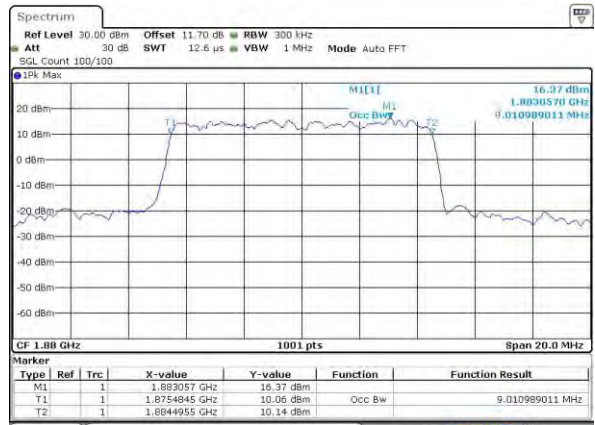

Date: 19 FEB 2016 21:43:44

Highest Channel / 10MHz / QPSK

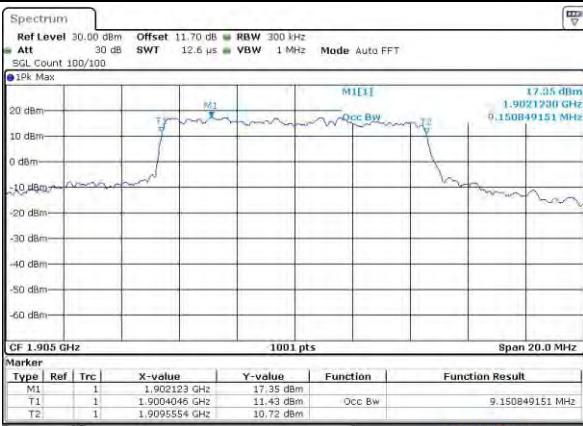

Date: 19 FEB 2016 21:46:05

Highest Channel / 10MHz / 16QAM

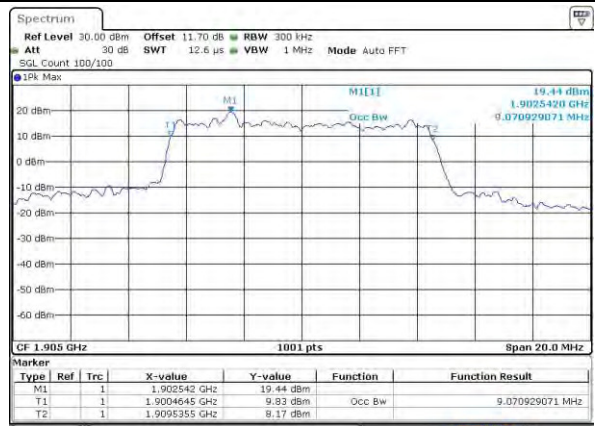

Date: 19 FEB 2016 21:46:15



LTE Band 2

Lowest Channel / 15MHz / QPSK

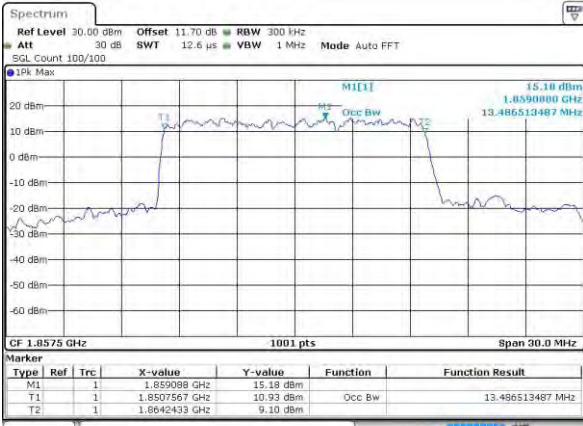

Date: 19 FEB 2016 21:53:13

Lowest Channel / 15MHz / 16QAM

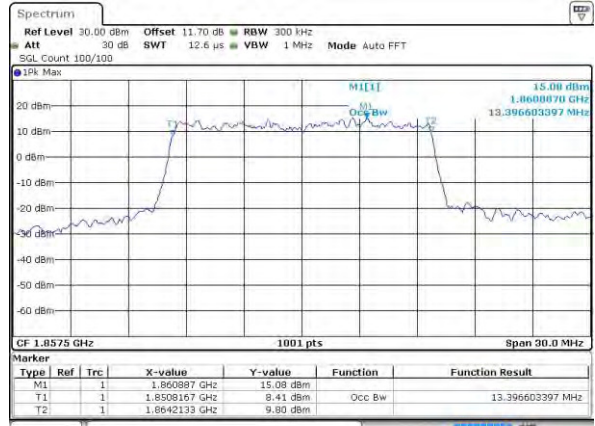

Date: 19 FEB 2016 21:53:24

Middle Channel / 15MHz / QPSK

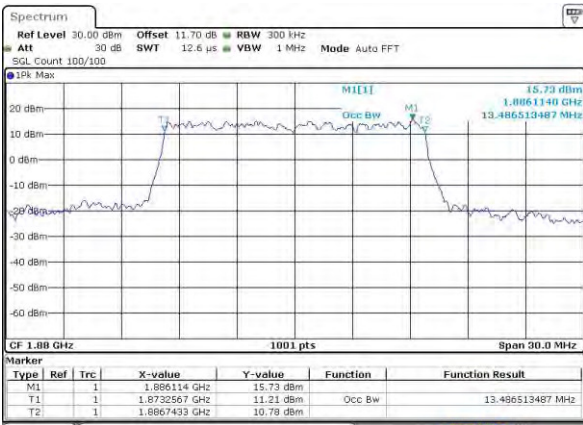

Date: 19 FEB 2016 22:00:23

Middle Channel / 15MHz / 16QAM

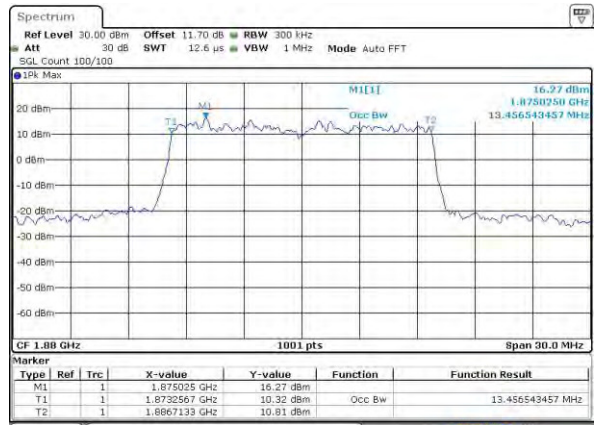

Date: 19 FEB 2016 22:00:33

Highest Channel / 15MHz / QPSK

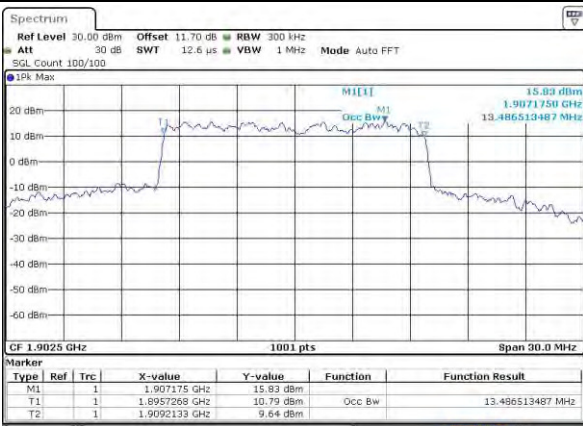

Date: 19 FEB 2016 22:02:54

Highest Channel / 15MHz / 16QAM

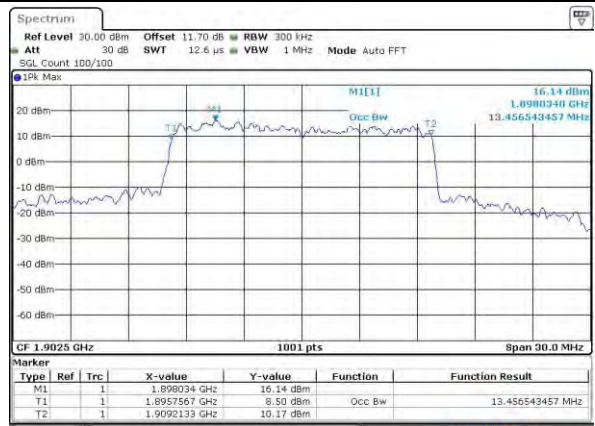

Date: 19 FEB 2016 22:03:05



LTE Band 2

Lowest Channel / 20MHz / QPSK

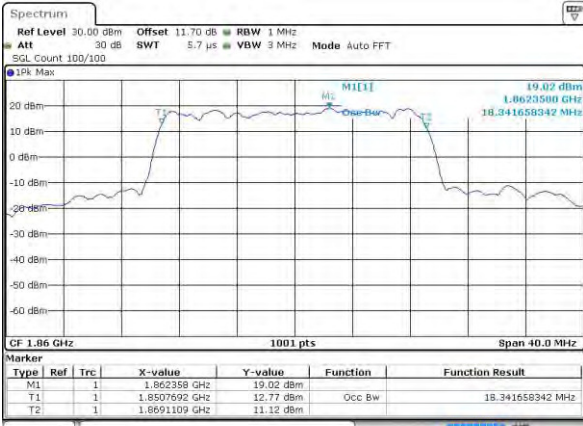

Date: 19 FEB 2016 22:10:04

Lowest Channel / 20MHz / 16QAM

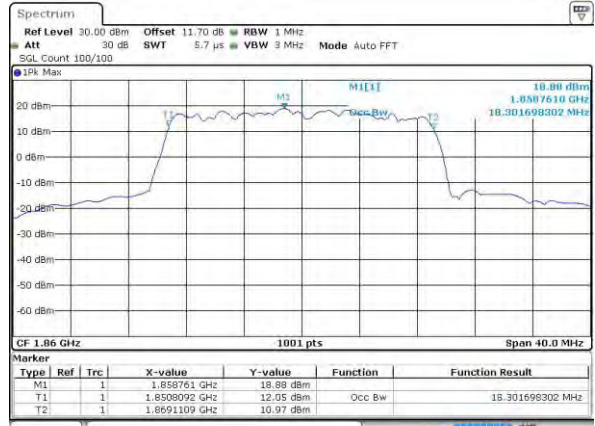

Date: 19 FEB 2016 22:10:14

Middle Channel / 20MHz / QPSK

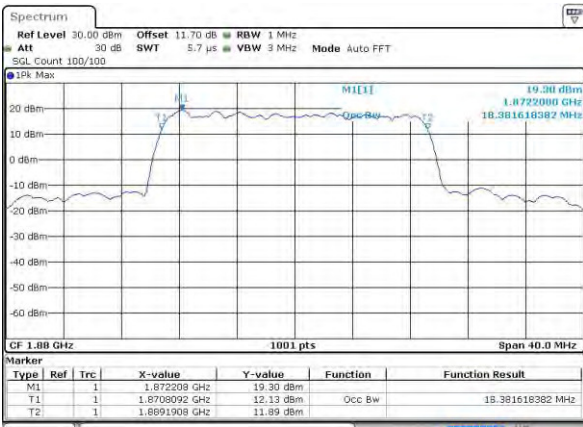

Date: 19 FEB 2016 22:17:12

Middle Channel / 20MHz / 16QAM

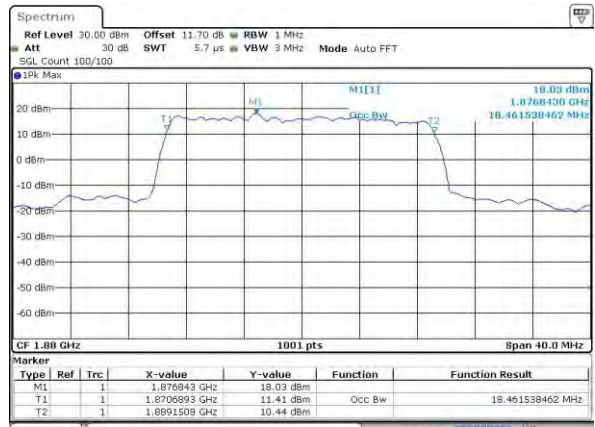

Date: 19 FEB 2016 22:17:23

Highest Channel / 20MHz / QPSK

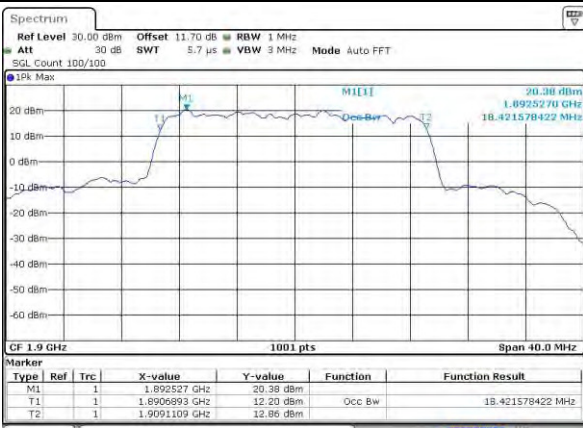

Date: 19 FEB 2016 22:19:44

Highest Channel / 20MHz / 16QAM

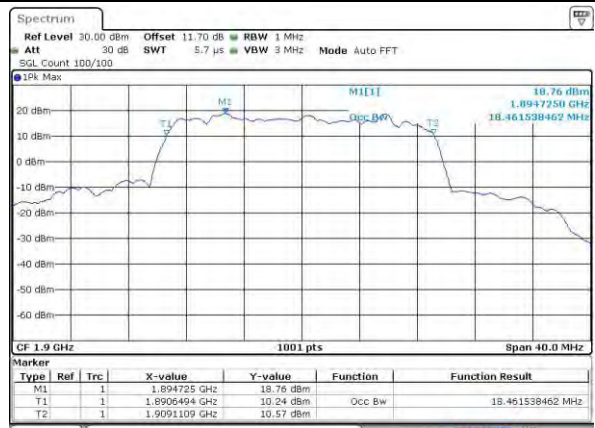

Date: 19 FEB 2016 22:19:55



Conducted Band Edge



LTE Band 2 / 1.4MHz / QPSK

Lowest Band Edge / 1RB

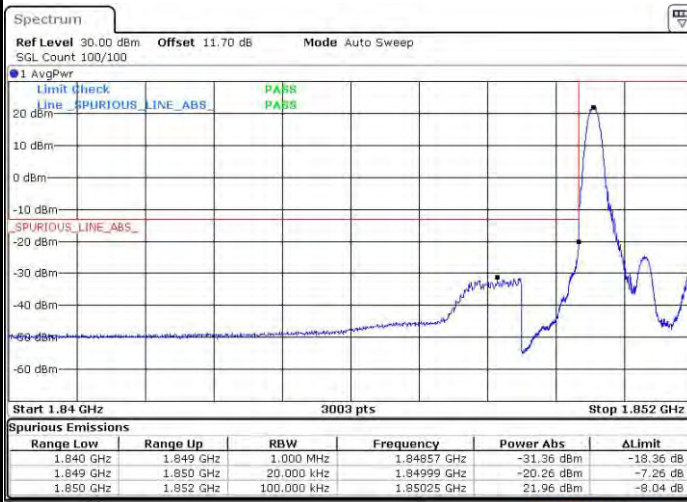

Date: 19.FEB.2016 22:52:12

Highest Band Edge / 1RB



Date: 19.FEB.2016 22:38:15

Lowest Band Edge / Full RB

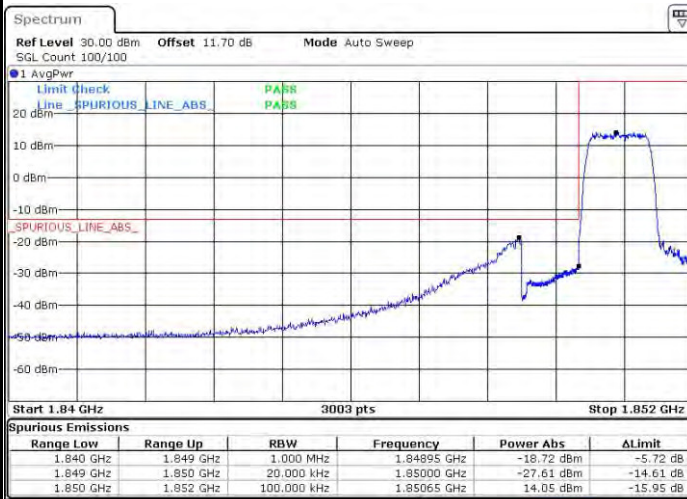

Date: 19.FEB.2016 22:30:52

Highest Band Edge / Full RB



Date: 19.FEB.2016 22:40:33



LTE Band 2 / 1.4MHz / 16QAM

Lowest Band Edge / 1 RB

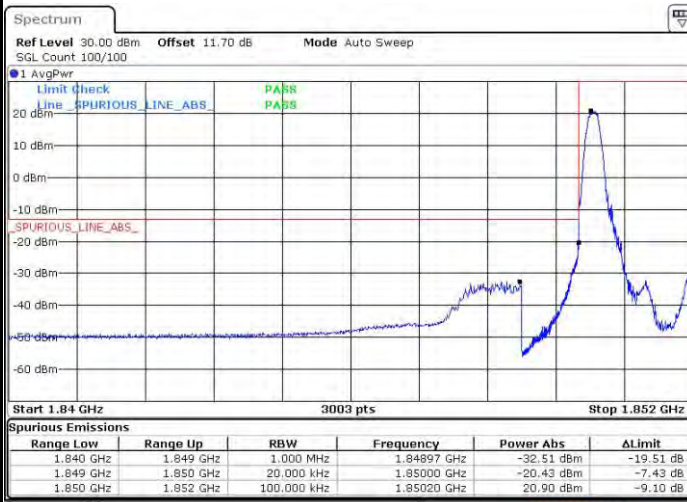

Date: 19.FEB.2016 22:29:43

Highest Band Edge / 1 RB



Date: 19.FEB.2016 22:39:24

Lowest Band Edge / Full RB

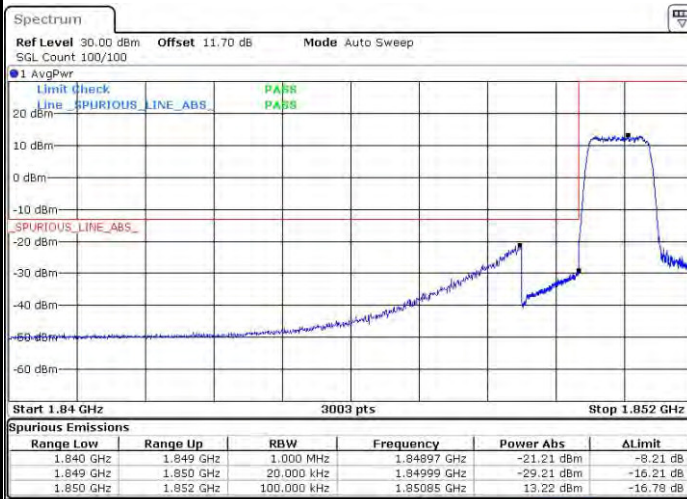

Date: 19.FEB.2016 22:32:02

Highest Band Edge / Full RB



Date: 19.FEB.2016 22:41:43



LTE Band 2 / 3MHz / QPSK

Lowest Band Edge / 1RB

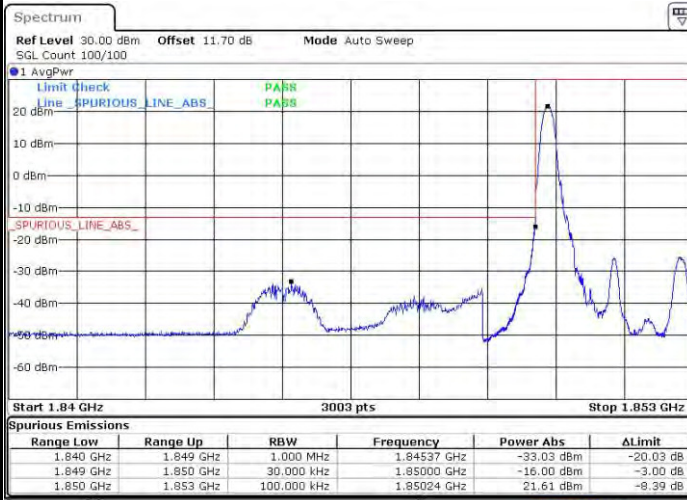

Date: 19.FEB.2016 21:04:25

Highest Band Edge / 1 RB

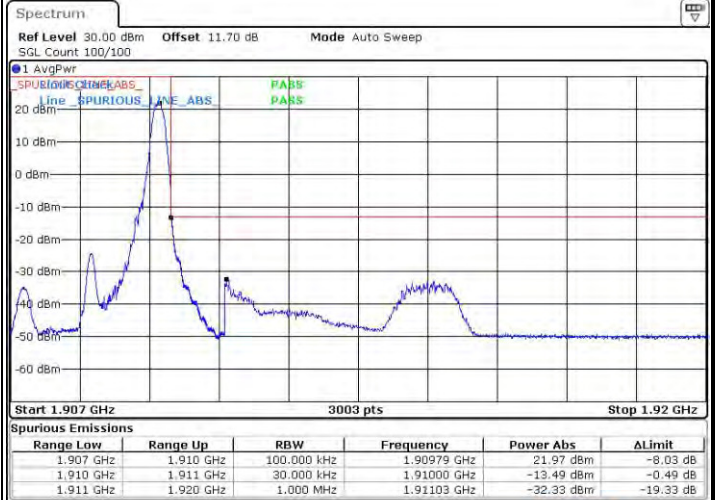

Date: 19.FEB.2016 23:22:06

Lowest Band Edge / Full RB

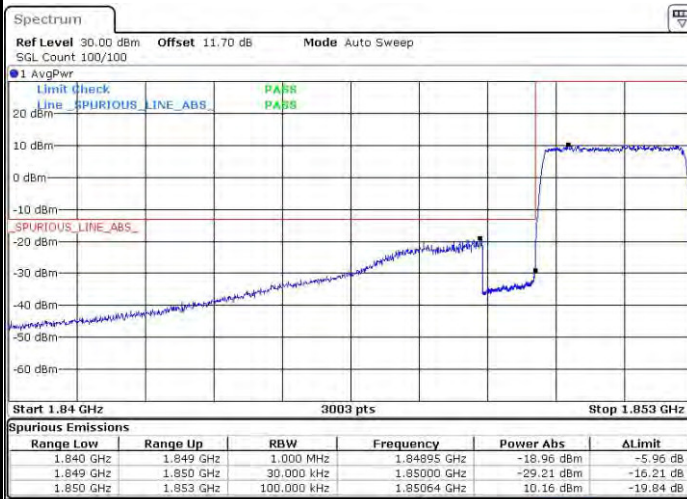

Date: 19.FEB.2016 21:06:44

Highest Band Edge / Full RB



Date: 19.FEB.2016 23:22:57



LTE Band 2 / 3MHz / 16QAM

Lowest Band Edge / 1 RB

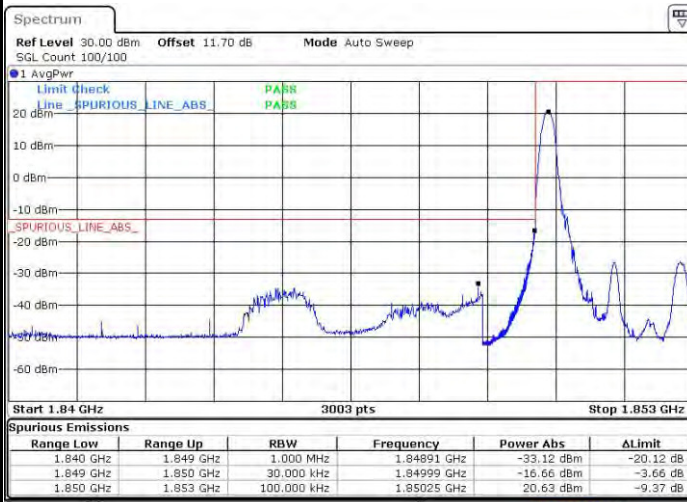

Date: 19.FEB.2016 21:05:34

Highest Band Edge / 1 RB

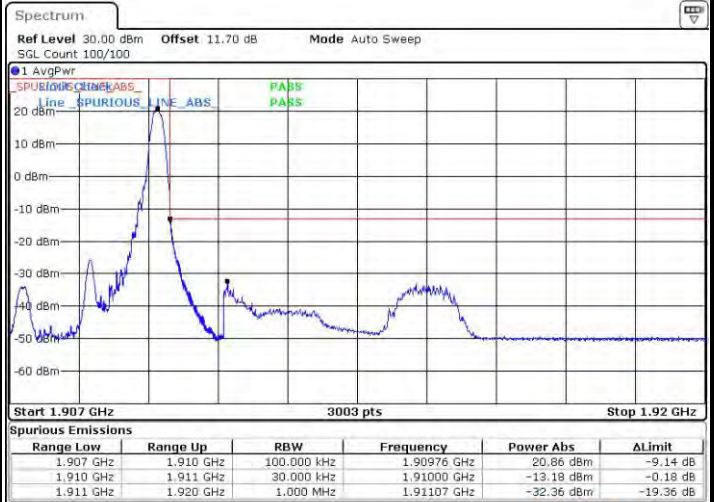

Date: 19.FEB.2016 21:15:15

Lowest Band Edge / Full RB

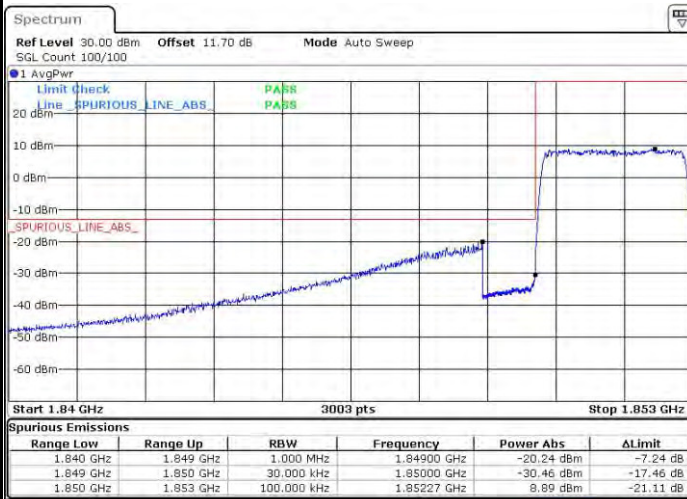

Date: 19.FEB.2016 21:07:53

Highest Band Edge / Full RB



Date: 19.FEB.2016 23:23:48



LTE Band 2 / 5MHz / QPSK

Lowest Band Edge / 1 RB

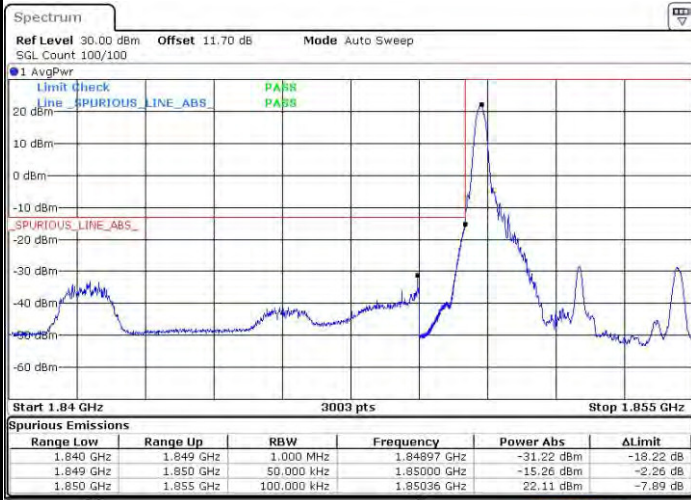

Date: 19.FEB.2016 21:21:14

Highest Band Edge / 1 RB



Date: 19.FEB.2016 21:30:55

Lowest Band Edge / Full RB

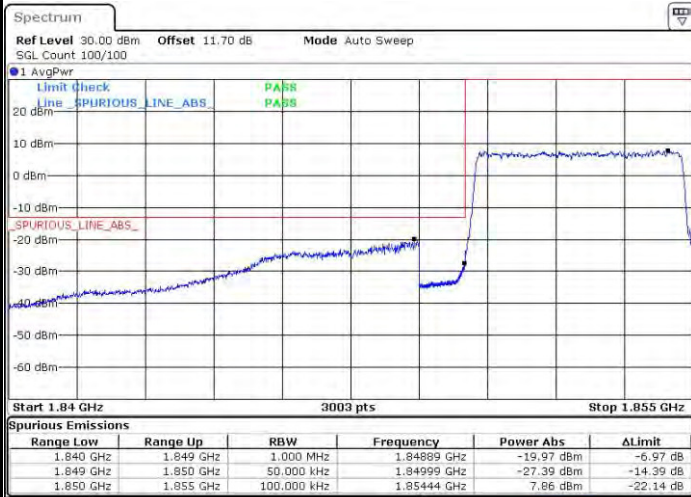

Date: 19.FEB.2016 21:23:33

Highest Band Edge / Full RB



Date: 19.FEB.2016 23:26:20



LTE Band 2 / 5MHz / 16QAM

Lowest Band Edge / 1RB

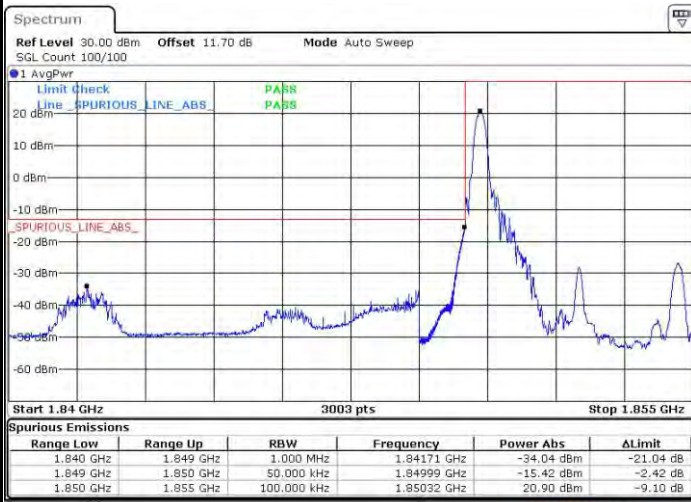

Date: 19.FEB.2016 23:24:57

Highest Band Edge / 1 RB

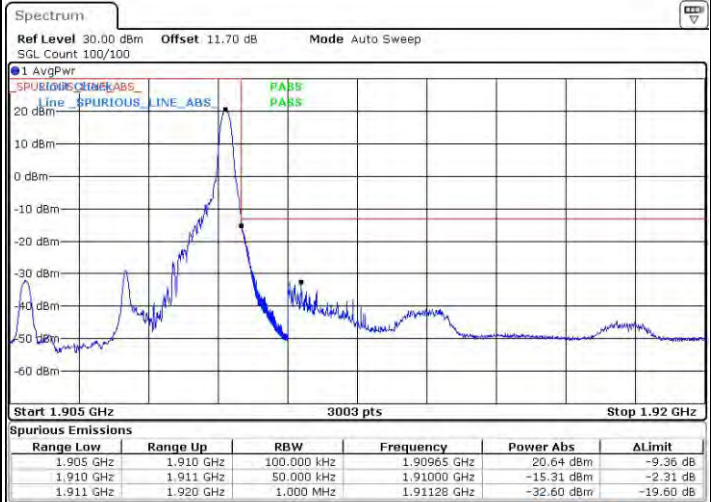

Date: 19.FEB.2016 21:32:04

Lowest Band Edge / Full RB

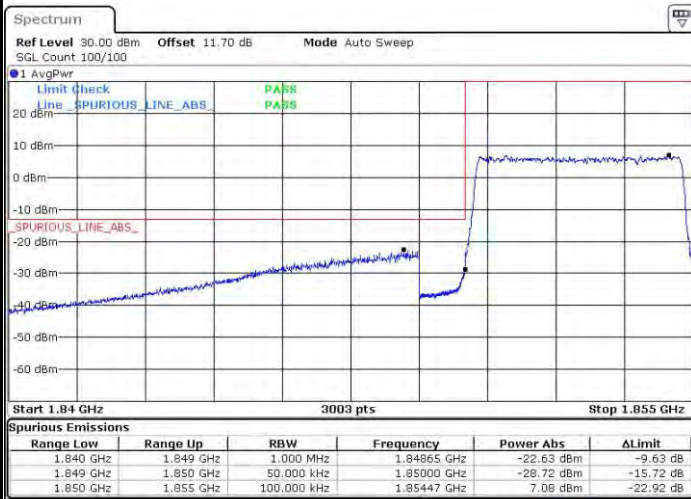

Date: 19.FEB.2016 21:24:42

Highest Band Edge / Full RB



Date: 19.FEB.2016 23:25:45



LTE Band 2 / 10MHz / QPSK

Lowest Band Edge / 1 RB

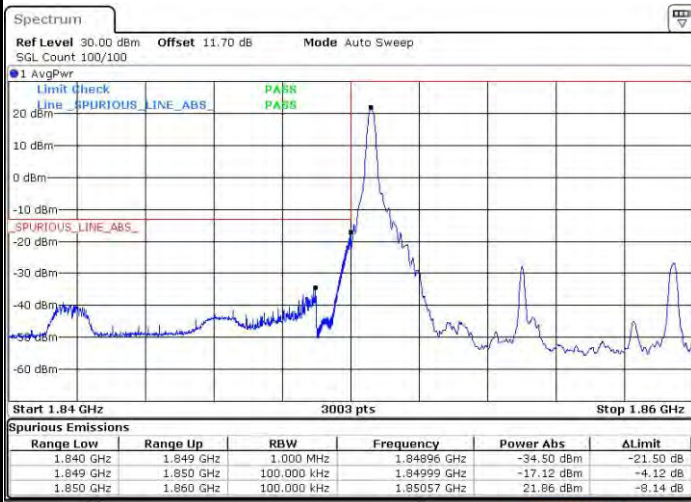

Date: 19.FEB.2016 21:38:04

Highest Band Edge / 1 RB

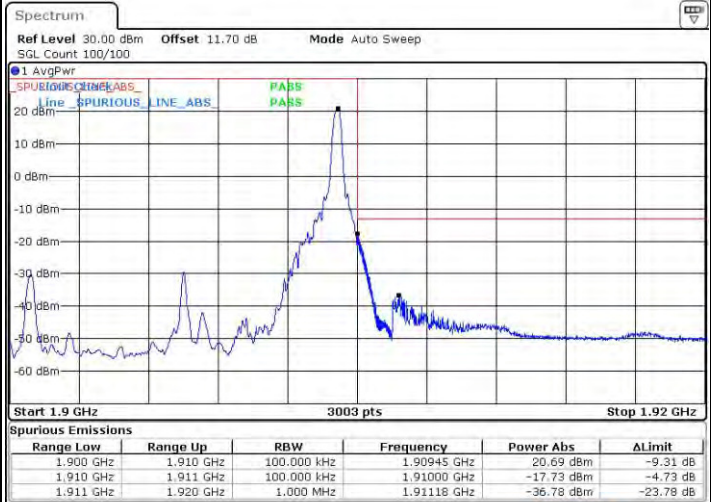

Date: 19.FEB.2016 21:47:45

Lowest Band Edge / Full RB

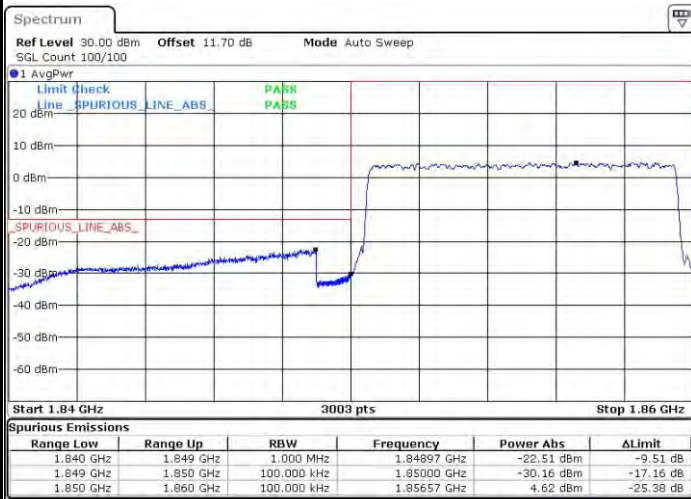

Date: 19.FEB.2016 21:40:23

Highest Band Edge / Full RB

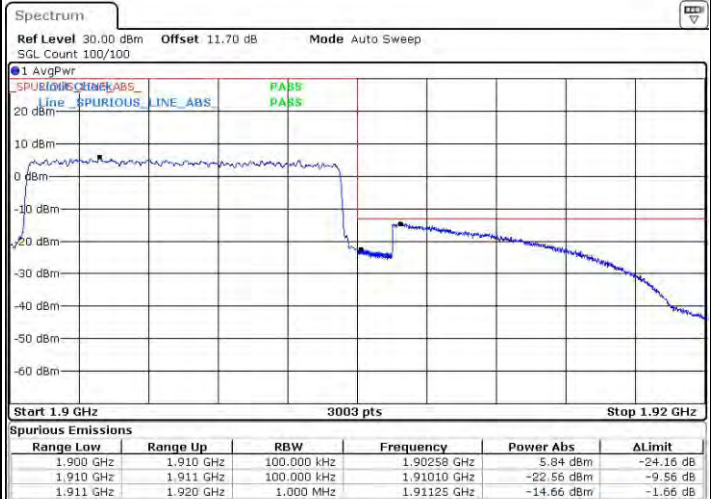

Date: 19.FEB.2016 23:27:32



LTE Band 2 / 10MHz / 16QAM

Lowest Band Edge / 1 RB

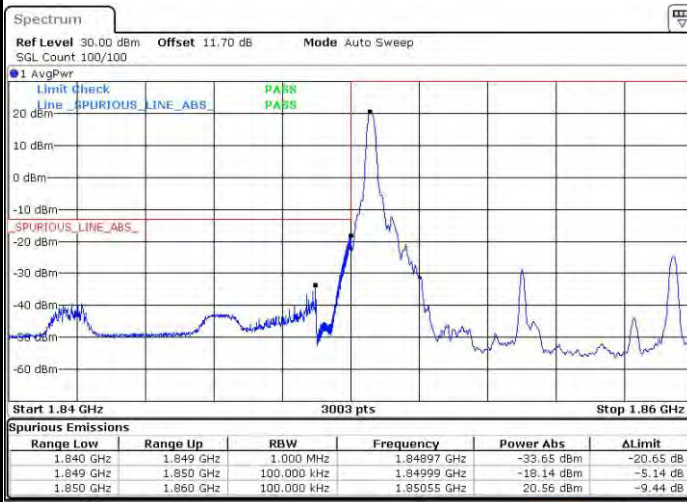

Date: 19.FEB.2016 23:26:55

Highest Band Edge / 1 RB

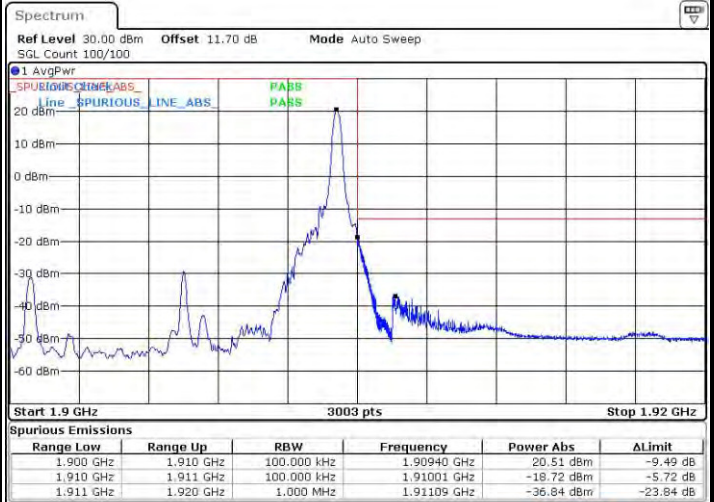

Date: 19.FEB.2016 21:48:55

Lowest Band Edge / Full RB

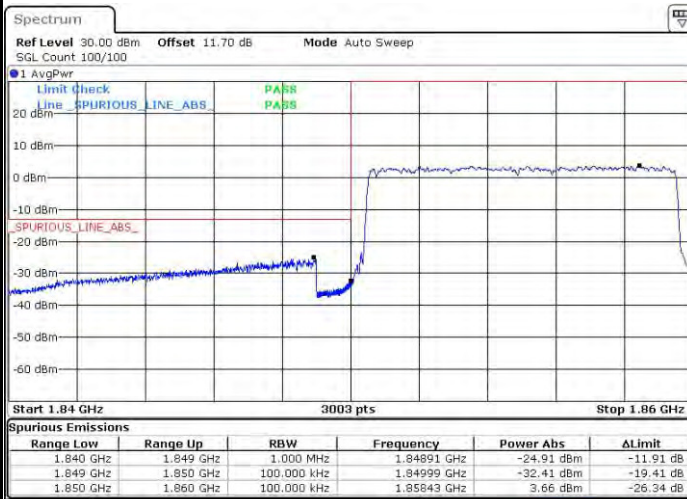

Date: 19.FEB.2016 21:41:32

Highest Band Edge / Full RB

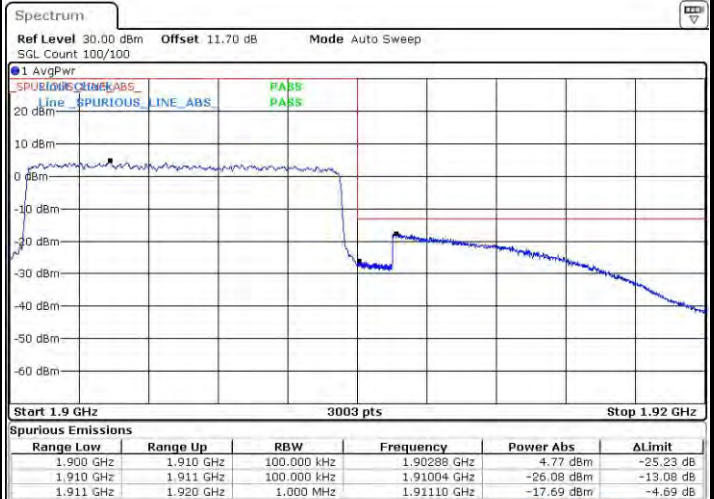

Date: 19.FEB.2016 23:28:16



LTE Band 2 / 15MHz / QPSK

Lowest Band Edge / 1 RB

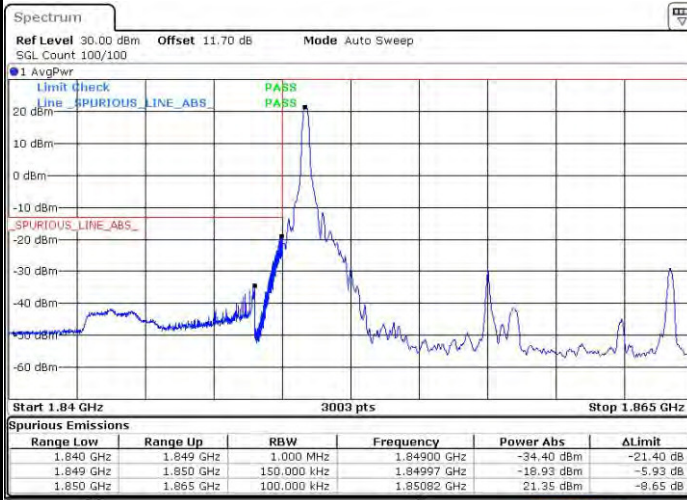

Date: 19.FEB.2016 21:54:54

Highest Band Edge / 1 RB

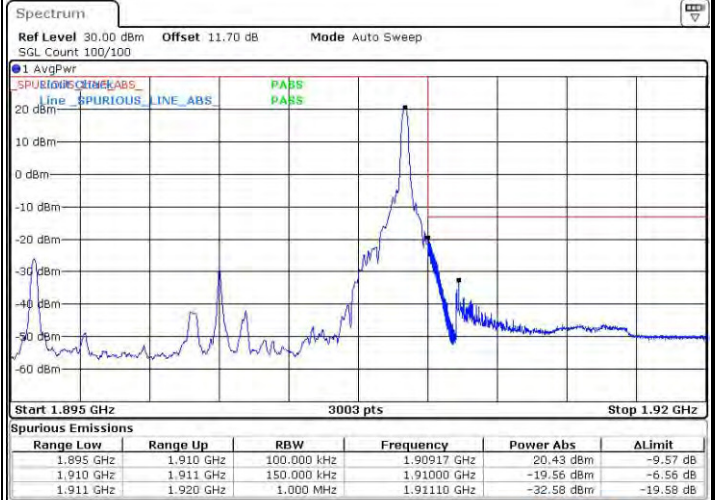

Date: 19.FEB.2016 22:04:35

Lowest Band Edge / Full RB

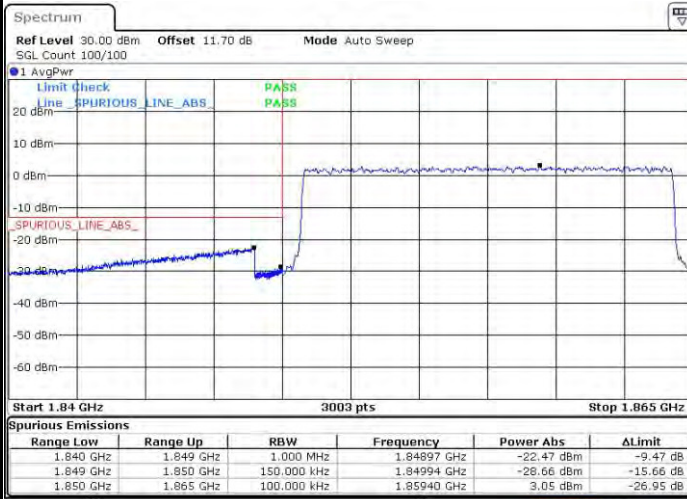

Date: 19.FEB.2016 21:57:12

Highest Band Edge / Full RB

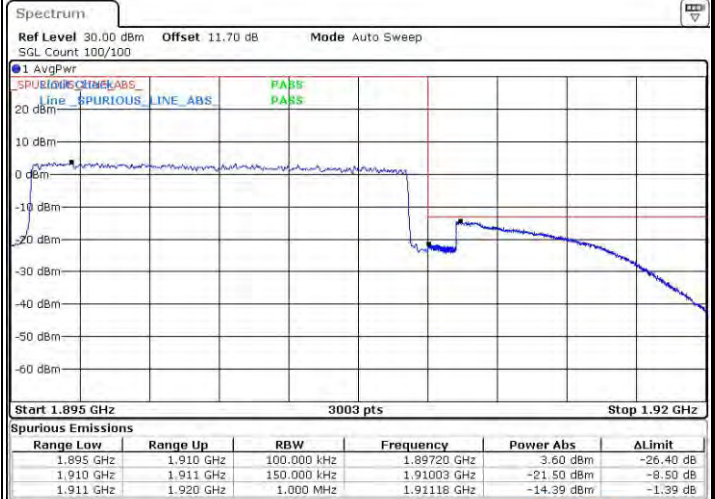

Date: 19.FEB.2016 22:06:54



LTE Band 2 / 15MHz / 16QAM

Lowest Band Edge / 1 RB

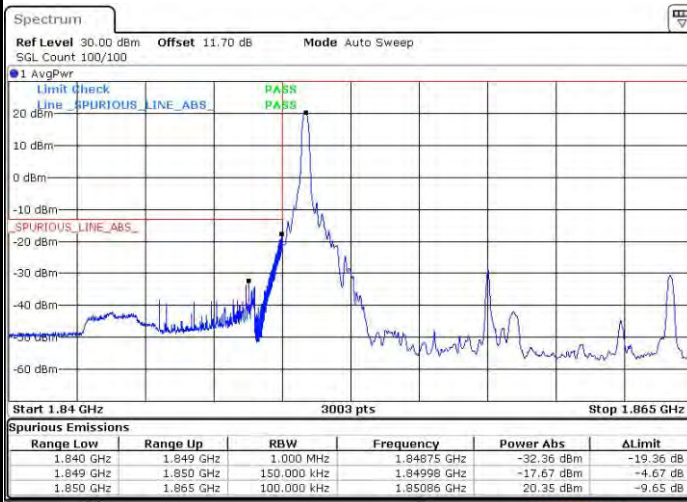

Date: 19.FEB.2016 21:56:03

Highest Band Edge / 1 RB

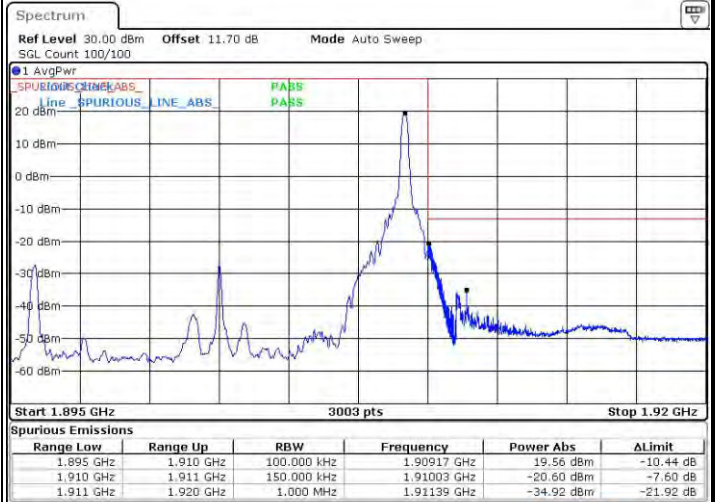

Date: 19.FEB.2016 22:05:44

Lowest Band Edge / Full RB

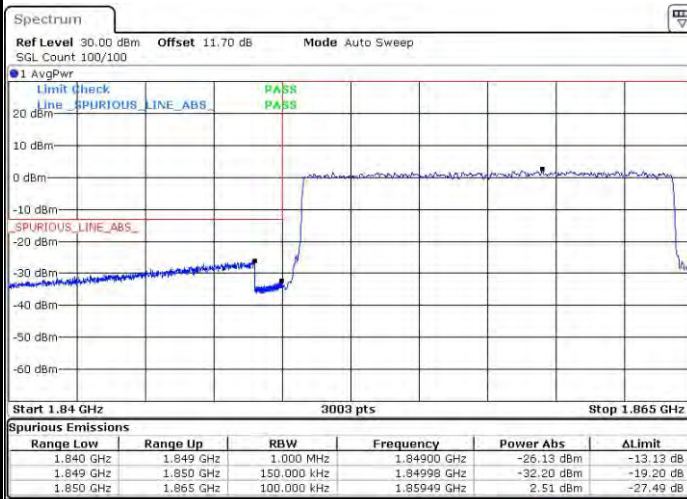

Date: 19.FEB.2016 21:58:22

Highest Band Edge / Full RB

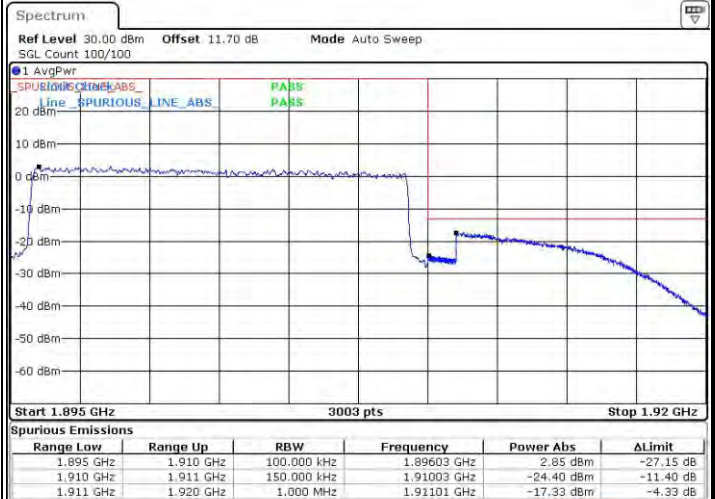

Date: 19.FEB.2016 22:08:03



LTE Band 2 / 20MHz / QPSK

Lowest Band Edge / 1 RB

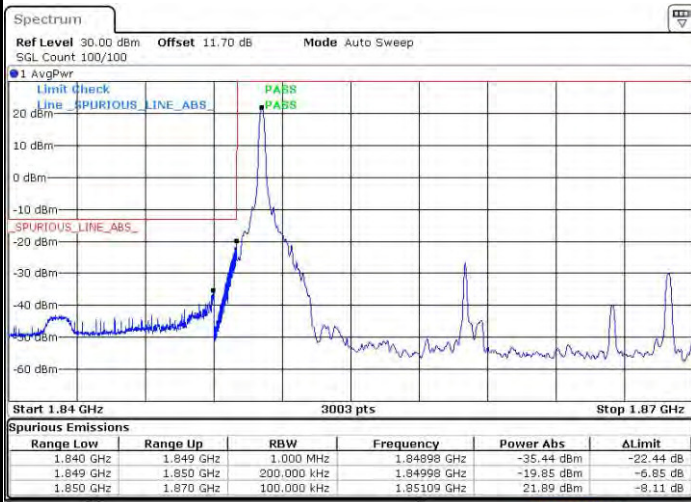

Date: 19.FEB.2016 22:11:44

Highest Band Edge / 1 RB

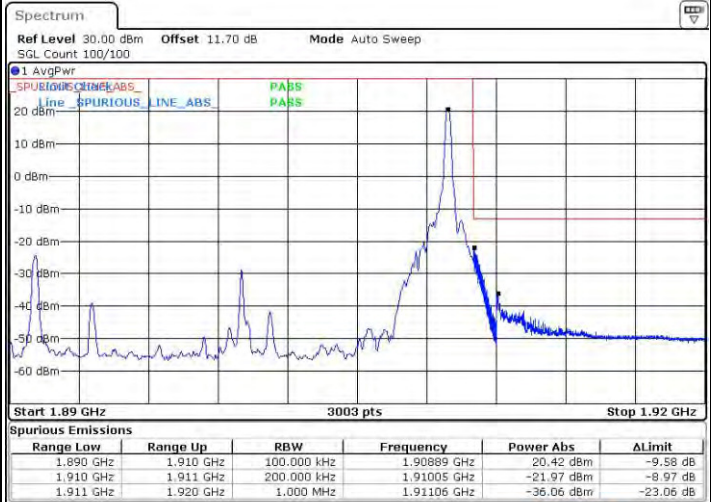

Date: 19.FEB.2016 22:21:25

Lowest Band Edge / Full RB

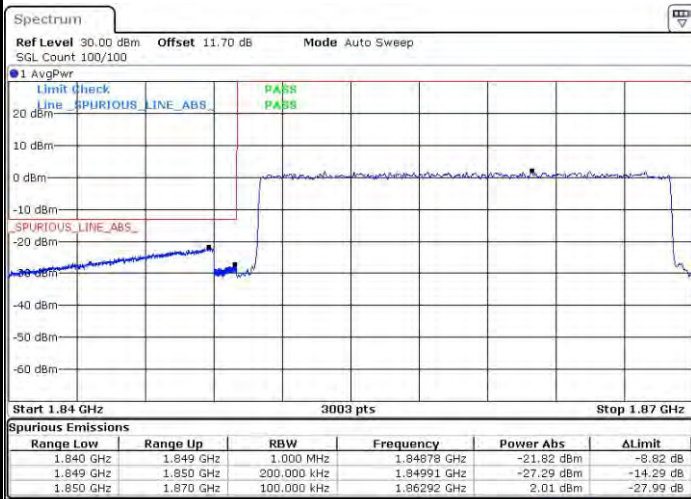

Date: 19.FEB.2016 22:14:02

Highest Band Edge / Full RB



Date: 19.FEB.2016 22:23:43



LTE Band 2 / 20MHz / 16QAM

Lowest Band Edge / 1 RB

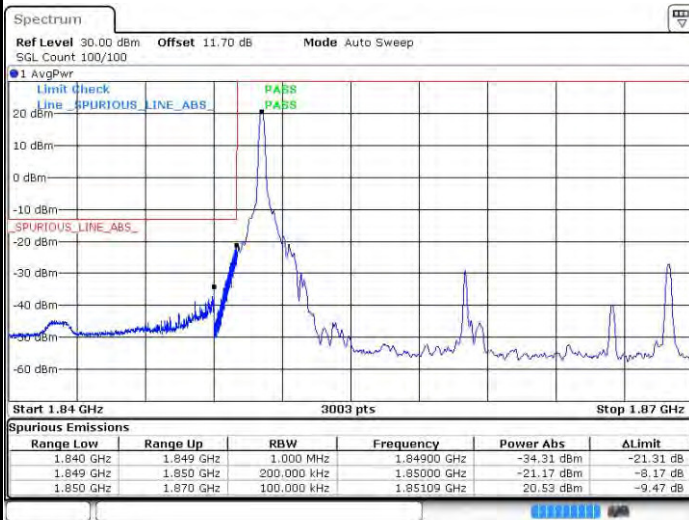

Date: 19.FEB.2016 22:12:53

Highest Band Edge / 1 RB

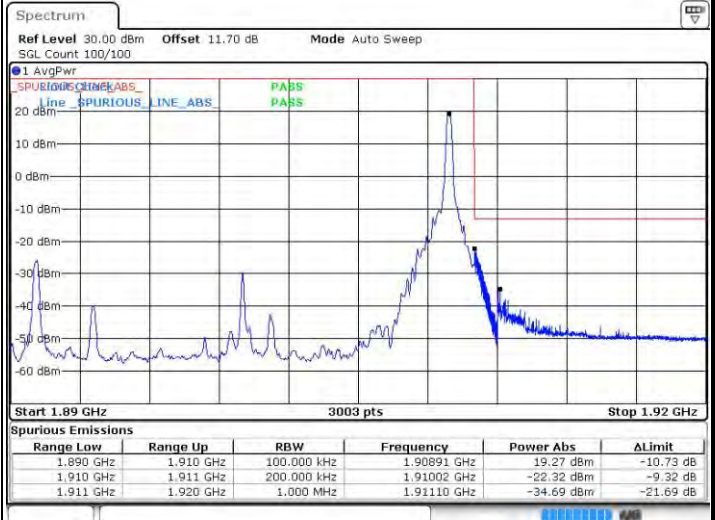

Date: 19.FEB.2016 22:22:34

Lowest Band Edge / Full RB

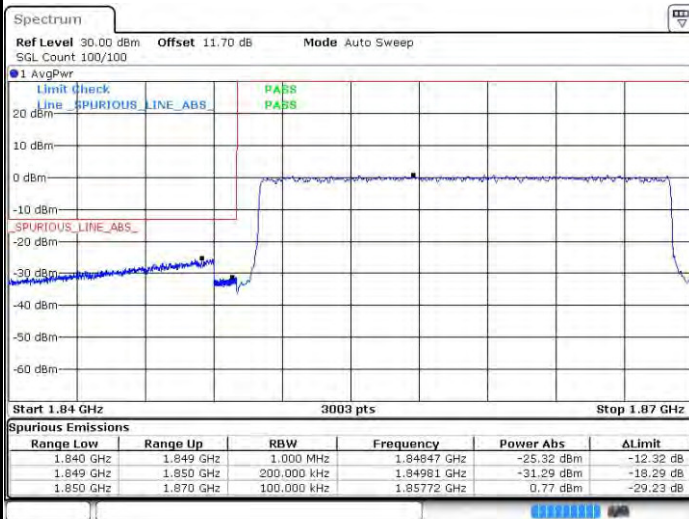

Date: 19.FEB.2016 22:15:12

Highest Band Edge / Full RB

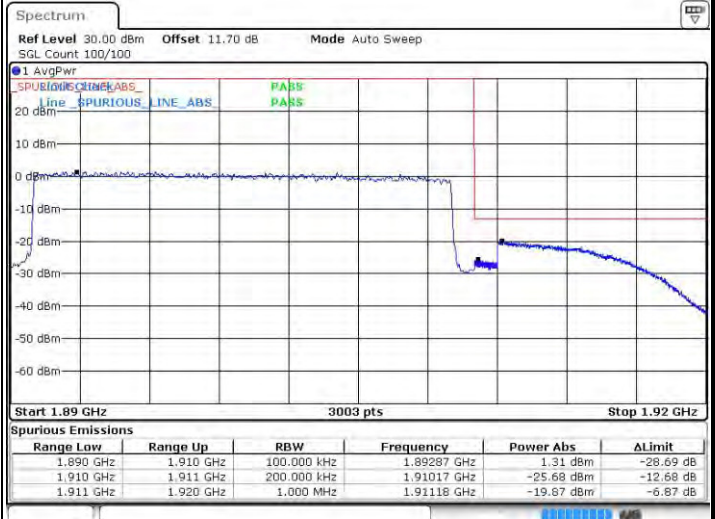

Date: 19.FEB.2016 22:24:53



Conducted Spurious Emission



LTE Band 2 / 1.4MHz

Lowest Channel / QPSK

Lowest Channel / 16QAM

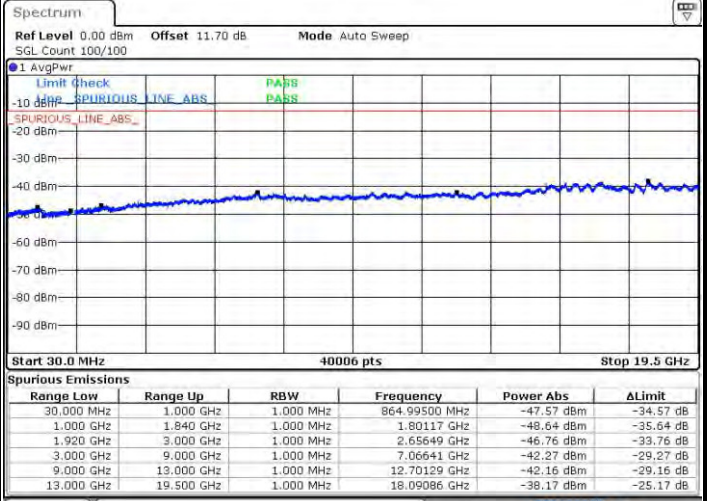
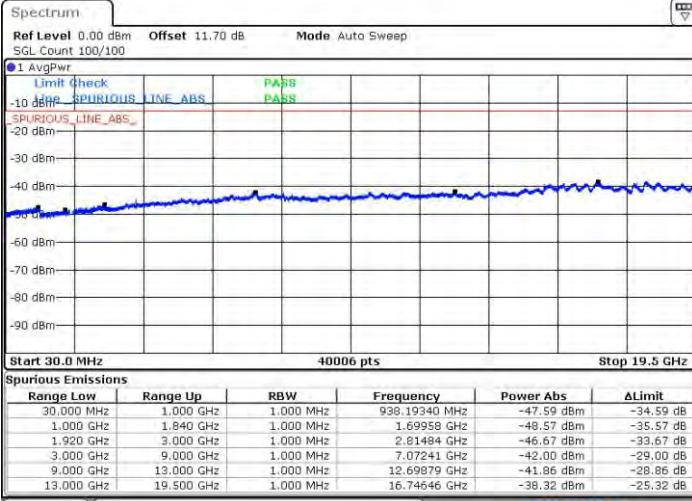

Date: 19.FEB.2016 22:32:57

Date: 19.FEB.2016 22:33:52

Middle Channel / QPSK

Middle Channel / 16QAM

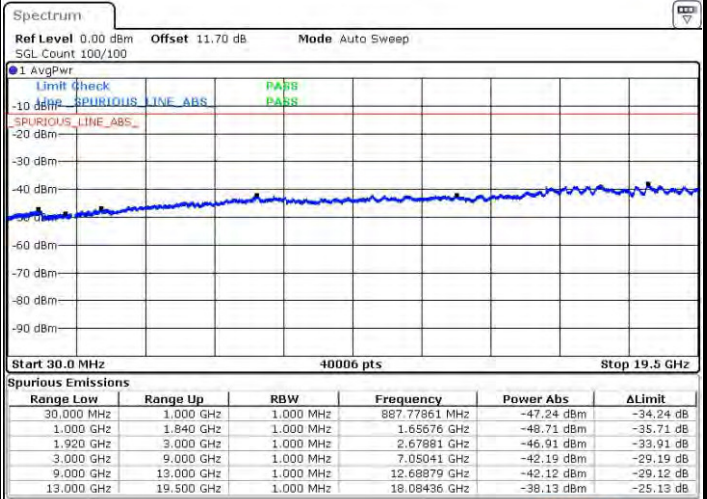
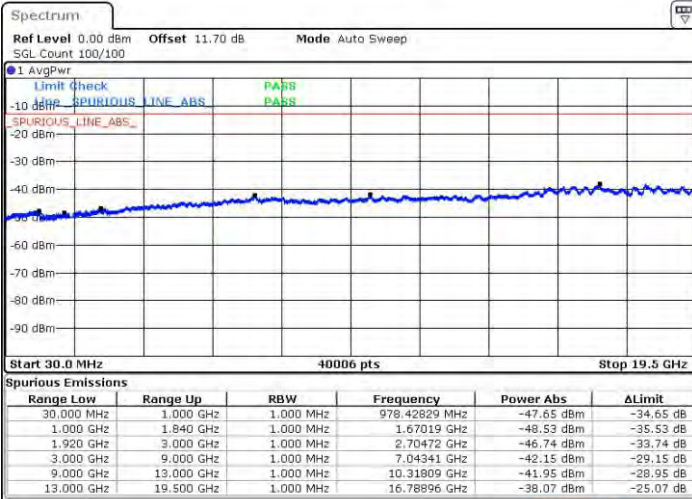

Date: 19.FEB.2016 22:35:29

Date: 19.FEB.2016 22:36:23