



FCC RF Test Report

APPLICANT : Sony Mobile Communications Inc.
EQUIPMENT : GSM/WCDMA/LTE Phone+Bluetooth, DTS/UNII
a/b/g/n and NFC
BRAND NAME : Sony
FCC ID : PY7-PM0961
STANDARD : FCC Part 15 Subpart E §15.407
CLASSIFICATION : (NII) Unlicensed National Information Infrastructure

The product was received on Jan. 22, 2016 and testing was completed on Feb. 18, 2016. We, SPORTON INTERNATIONAL INC., would like to declare that the tested sample has been evaluated in accordance with the test procedures and has been in compliance with the applicable technical standards.

The test results in this report apply exclusively to the tested model / sample. Without written approval of SPORTON INTERNATIONAL INC., the test report shall not be reproduced except in full.

Reviewed by: Joseph Lin / Supervisor

Approved by: Jones Tsai / Manager



SPORTON INTERNATIONAL INC.

No. 52, Hwa Ya 1st Rd., Hwa Ya Technology Park, Kwei-Shan District, Tao Yuan City, Taiwan, R.O.C.

SPORTON INTERNATIONAL INC.

TEL : 886-3-327-3456

FAX : 886-3-328-4978

FCC ID : PY7-PM0961

Page Number : 1 of 35

Report Issued Date : Apr. 15, 2016

Report Version : Rev. 02

Report Template No.: BU5-FR15EWL AC Version 1.3



TABLE OF CONTENTS

REVISION HISTORY..... 3

SUMMARY OF TEST RESULT 4

1 GENERAL DESCRIPTION 5

 1.1 Applicant 5

 1.2 Manufacturer..... 5

 1.3 Product Feature of Equipment Under Test..... 5

 1.4 Modification of EUT 6

 1.5 Testing Location 7

 1.6 Applicable Standards..... 7

2 TEST CONFIGURATION OF EQUIPMENT UNDER TEST 8

 2.1 Carrier Frequency Channel 8

 2.2 Pre-Scanned RF Power..... 9

 2.3 Test Mode..... 9

 2.4 Connection Diagram of Test System..... 11

 2.5 Support Unit used in test configuration and system 12

 2.6 EUT Operation Test Setup 12

 2.7 Measurement Results Explanation Example..... 12

3 TEST RESULT 13

 3.1 26dB & 99% Occupied Bandwidth Measurement 13

 3.2 Maximum Conducted Output Power Measurement 15

 3.3 Power Spectral Density Measurement 17

 3.4 Unwanted Radiated Emission Measurement 20

 3.5 AC Conducted Emission Measurement..... 26

 3.6 Frequency Stability Measurement 30

 3.7 Automatically Discontinue Transmission 31

 3.8 Antenna Requirements 32

4 LIST OF MEASURING EQUIPMENTS..... 33

5 UNCERTAINTY OF EVALUATION 35

APPENDIX A. CONDUCTED TEST RESULTS

APPENDIX B. RADIATED SPURIOUS EMISSION

APPENDIX C. RADIATED SPURIOUS EMISSION PLOTS



REVISION HISTORY

REPORT NO.	VERSION	DESCRIPTION	ISSUED DATE
FR612118-01E	Rev. 01	Initial issue of report	Apr. 07, 2016
FR612118-01E	Rev. 02	Adding the Duty Cycle data in section 3.4.8.	Apr. 15, 2016



SUMMARY OF TEST RESULT

Report Section	FCC Rule	Description	Limit	Result	Remark
3.1	2.1049 15.403(i)	26dB & 99% Bandwidth	-	Pass	-
3.2	15.407(a)	Maximum Conducted Output Power	≤ 24 dBm (depend on band)	Pass	-
3.3	15.407(a)	Power Spectral Density	≤ 11 dBm (depend on band)	Pass	-
3.4	15.407(b)	Unwanted Emissions	≤ -17, -27 dBm (depend on band)&15.209(a)	Pass	Under limit 3.69 dB at 5350.000 MHz
3.5	15.207	AC Conducted Emission	15.207(a)	Pass	Under limit 17.80 dB at 0.438 MHz
3.6	15.407(g)	Frequency Stability	Within Operation Band	Pass	-
3.7	15.407(c)	Automatically Discontinue Transmission	Discontinue Transmission	Pass	-
3.8	15.203 & 15.407(a)	Antenna Requirement	N/A	Pass	-

Remark: The FCC ID: PY7-PM0960 and FCC ID: PY7-PM0961 is similar device, in this report all the test result are referred to PY7-PM0960, Sporton Report No: FR612117-01E.



1 General Description

1.1 Applicant

Sony Mobile Communications Inc.

4-12-3 Higashi-Shinagawa, Shinagawa-ku, Tokyo, 140-0002, Japan

1.2 Manufacturer

Sony Mobile Communications Inc.

4-12-3 Higashi-Shinagawa, Shinagawa-ku, Tokyo, 140-0002, Japan

1.3 Product Feature of Equipment Under Test

GSM/WCDMA/LTE, Bluetooth, DTS/UNII a/b/g/n, GPS, and NFC

Product Specification subjective to this standard	
Antenna Type	PIFA Antenna
Antenna Gain	<5150 MHz ~ 5250 MHz> -2.00 dBi
	<5250 MHz ~ 5350 MHz> -1.20 dBi
	<5470 MHz ~ 5725 MHz> -2.50 dBi

EUT Information List				
IMEI	HW Version	SW Version	S/N	Performed Test Item
004402455898886	A	33.2.A.0.19	RQ3000DQQZ	RF conducted measurement
004402455893739			RQ3000DQHV	Radiated Spurious Emission
004402455895585			RQ3000DQQU	Conducted Emission



Accessory List	
AC Adapter	Model No. : EP800
	Type No. : CAA-0002016-US B
	S/N :
	3113W22608082 (for radiated spurious emission) 3113W22608092 (for conducted emission)
Earphone	Model No. : MH410c
	Type No. : AG-1110
	S/N :
	1541A8180036F24 (for radiated spurious emission) 1541A81B0036C26 (for conducted emission)
USB Cable	Model No. : UCB16
	Type No. : AI-0142
	S/N : N/A

Note:

1. Above EUT list and accessory list used are electrically identical per declared by manufacturer.
2. Above the accessories list are used to exercise the EUT during test.
3. For other wireless features of this EUT, test report will be issued separately.

1.4 Modification of EUT

No modifications are made to the EUT during all test items.



1.5 Testing Location

Sporton Lab is accredited to ISO 17025 by Taiwan Accreditation Foundation (TAF code : 1190) and the FCC designation No. TW1022 under the FCC 2.948(e) by Mutual Recognition Agreement (MRA) in FCC Test.

Test Site	SPORTON INTERNATIONAL INC.	
Test Site Location	No. 52, Hwa Ya 1 st Rd., Hwa Ya Technology Park, Kwei-Shan District, Tao Yuan City, Taiwan, R.O.C. TEL: +886-3-327-3456 FAX: +886-3-328-4978	
Test Site No.	Sporton Site No.	
	TH05-HY	CO05-HY

Note: The test site complies with ANSI C63.4 2014 requirement.

Test Site	SPORTON INTERNATIONAL INC.	
Test Site Location	No.58, Aly. 75, Ln. 564, Wenhua 3rd Rd. Guishan Dist, Taoyuan City, Taiwan (R.O.C.) TEL: +886-3-327-0868 FAX: +886-3-327-0855	
Test Site No.	Sporton Site No.	
	03CH11-HY	

Note: The test site complies with ANSI C63.4 2014 requirement.

1.6 Applicable Standards

According to the specifications of the manufacturer, the EUT must comply with the requirements of the following standards:

- ♦ FCC Part 15 Subpart E
- ♦ FCC KDB 789033 D02 General UNII Test Procedures New Rules v01r01
- ♦ ANSI C63.10-2013

Remark:

1. All test items were verified and recorded according to the standards and without any deviation during the test.
2. This EUT has also been tested and complied with the requirements of FCC Part 15, Subpart B, recorded in a separate test report.



2 Test Configuration of Equipment Under Test

The EUT has been associated with peripherals and configuration operated in a manner tended to maximize its emission characteristics in a typical application. Frequency range investigated: conducted emission (150 kHz to 30 MHz) and radiated emission (9 kHz to the 10th harmonic of the highest fundamental frequency or to 40 GHz, whichever is lower). For radiated measurement, pre-scanned in three orthogonal panels, X, Y, Z. The worst cases (Z plane) were recorded in this report.

The final configuration from all the combinations and the worst-case data rates were investigated by measuring the maximum power across all the data rates and modulation modes under section 2.2.

Based on the worst configuration found above, the RF power setting is set individually to meet FCC compliance limit for the final conducted and radiated tests shown in section 2.3.

2.1 Carrier Frequency Channel

Frequency Band	Channel	Freq. (MHz)	Channel	Freq. (MHz)
5150-5250 MHz Band 1 (U-NII-1)	36	5180	44	5220
	38	5190	46	5230
	40	5200	48	5240

Frequency Band	Channel	Freq. (MHz)	Channel	Freq. (MHz)
5250-5350 MHz Band 2 (U-NII-2A)	52	5260	60	5300
	54	5270	62	5310
	56	5280	64	5320

Frequency Band	Channel	Freq. (MHz)	Channel	Freq. (MHz)
5470-5600 MHz and 5650-5725 MHz Band 3 (U-NII-2C)	100	5500	116	5580
	102	5510	132	5660
	104	5520	134	5670
	108	5540	136	5680
	110	5550	140	5700
	112	5560		

Note: The above Frequency and Channel in boldface were 802.11n HT40.



2.2 Pre-Scanned RF Power

Preliminary tests were performed in different data rate and data rate associated with the highest power were chosen for full test in the following tables.

5GHz 802.11a mode								
Data Rate (MHz)	6M bps	9M bps	12M bps	18M bps	24M bps	36M bps	48M bps	54M bps
Avg. Power (dBm)	13.99	13.82	13.83	13.85	13.81	13.87	13.90	13.88

5GHz 802.11n HT20 mode								
Data Rate (MHz)	MCS0	MCS1	MCS2	MCS3	MCS4	MCS5	MCS6	MCS7
Avg. Power (dBm)	12.98	12.85	12.86	12.88	12.96	12.90	12.72	12.80

5GHz 802.11n HT40mode								
Data Rate (MHz)	MCS0	MCS1	MCS2	MCS3	MCS4	MCS5	MCS6	MCS7
Avg. Power (dBm)	12.98	12.96	12.94	12.80	12.75	12.90	12.85	12.92

2.3 Test Mode

Final test mode of conducted test items and radiated spurious emissions are considering the modulation and worse data rates from the power table described in section 2.2.

Modulation	Data Rate
802.11a	6 Mbps
802.11n HT20	MCS0
802.11n HT40	MCS0

Test Cases	
AC Conducted Emission	Mode 1 : GSM1900 Idle + Bluetooth Link + WLAN (5GHz) Link + MP3 + Earphone + Battery 2 + USB Cable (Charging from Adapter)



Ch. #		Band I : 5150-5250 MHz	Band II : 5250-5350 MHz	Band III : 5470-5600 MHz and 5650-5725MHz
		802.11a	802.11a	802.11a
L	Low	36	52	100
M	Middle	44	60	116
H	High	48	64	140

Ch. #		Band I : 5150-5250 MHz	Band II : 5250-5350 MHz	Band III : 5470-5600 MHz and 5650-5725MHz
		802.11n HT20	802.11n HT20	802.11n HT20
L	Low	36	52	100
M	Middle	44	60	116
H	High	48	64	140

Ch. #		Band I : 5150-5250 MHz	Band II : 5250-5350 MHz	Band III : 5470-5600 MHz and 5650-5725MHz
		802.11n HT40	802.11n HT40	802.11n HT40
L	Low	38	54	102
M	Middle	-	-	110
H	High	46	62	134

2.4 Connection Diagram of Test System

<Radiated Emission Mode>

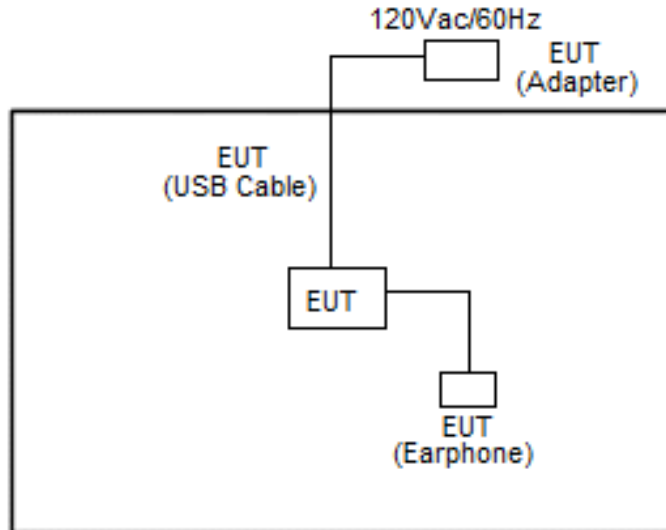

<AC Conducted Emission Mode>

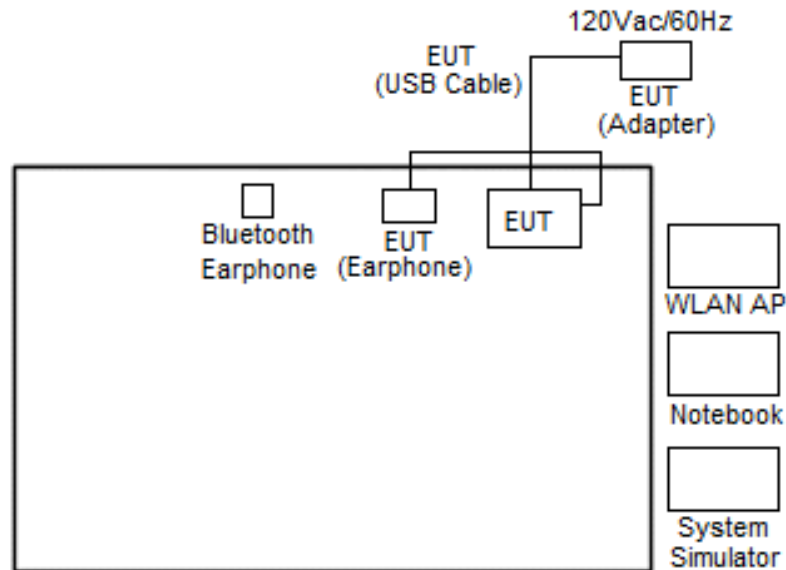



2.5 Support Unit used in test configuration and system

Item	Equipment	Trade Name	Model Name	FCC ID	Data Cable	Power Cord
1.	System Simulator	Anritsu	MT8820C	N/A	N/A	Unshielded, 1.8 m
2.	WLAN AP	D-Link	DIR-865L	KA2IR865LA1	N/A	Unshielded, 1.8 m
3.	Bluetooth Earphone	Samsung	SBH20	PY7-RD0010	Unshielded, 0.75 m	N/A
4.	Notebook	DELL	Latitude E6320	FCC DoC/ Contains FCC ID: QDS-BRCM1054	N/A	AC I/P: Unshielded, 1.2 m DC O/P: Shielded, 1.8 m
5.	SD Card	SanDisk	MicroSD HC	FCC DoC	N/A	N/A

2.6 EUT Operation Test Setup

For WLAN RF test items, an engineering test program was provided and enabled to make EUT continuous transmit/receive.

2.7 Measurement Results Explanation Example

For all conducted test items:

The offset level is set in the spectrum analyzer to compensate the RF cable loss and attenuator factor between EUT conducted output port and spectrum analyzer. With the offset compensation, the spectrum analyzer reading level is exactly the EUT RF output level.

Example :

The spectrum analyzer offset is derived from RF cable loss and attenuator factor.

Offset = RF cable loss + attenuator factor.

Following shows an offset computation example with cable loss 4.2 dB and 10dB attenuator.

$$\begin{aligned} \text{Offset(dB)} &= \text{RF cable loss(dB)} + \text{attenuator factor(dB)}. \\ &= 4.2 + 10 = 14.2 \text{ (dB)} \end{aligned}$$

3 Test Result

3.1 26dB & 99% Occupied Bandwidth Measurement

3.1.1 Description of 26dB & 99% Occupied Bandwidth

This section is for reporting purpose only.

There is no restriction limits for bandwidth.

3.1.2 Measuring Instruments

The measuring equipment is listed in the section 4 of this test report.

3.1.3 Test Procedures

1. The testing follows FCC KDB 789033 D02 General UNII Test Procedures New Rules v01r01.
Section C) Emission bandwidth
2. Set RBW = approximately 1% of the emission bandwidth.
3. Set the VBW > RBW.
4. Detector = Peak.
5. Trace mode = max hold
6. Measure the maximum width of the emission that is 26 dB down from the peak of the emission.
Compare this with the RBW setting of the analyzer. Readjust RBW and repeat measurement as needed until the RBW/EBW ratio is approximately 1%.
7. For 99% Bandwidth Measurement, the spectrum analyzer's resolution bandwidth (RBW) is set 1MHz and set the Video bandwidth (VBW) $\geq 3 * RBW$.
8. Measure and record the results in the test report.

3.1.4 Test Setup

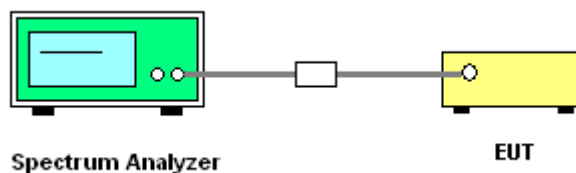



3.1.5 Test Result of 26dB & 99% Occupied Bandwidth Plots

Please refer to Appendix A.

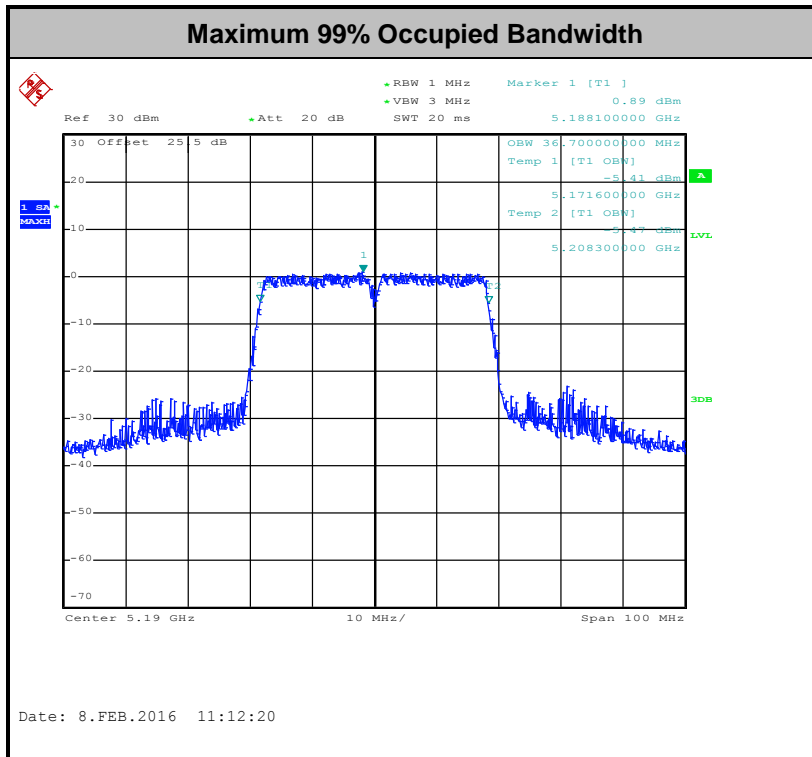
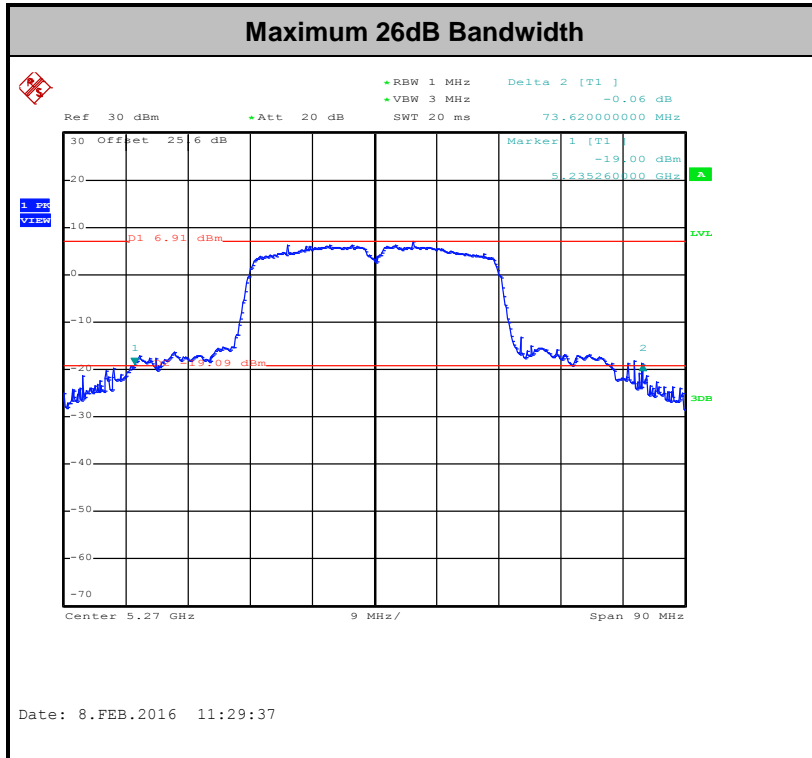

Note: The occupied channel bandwidth is maintained within the band of operation for all of the modulations.



3.2 Maximum Conducted Output Power Measurement

3.2.1 Limit of Maximum Conducted Output Power

For mobile and portable client devices in the 5.15–5.25 GHz band, the maximum conducted output power over the frequency band of operation shall not exceed 250 mW.

For the 5.25–5.35 GHz and 5.47–5.725 GHz bands, the maximum conducted output power over the frequency bands of operation shall not exceed the lesser of 250 mW or 11 dBm 10 log B, where B is the 26 dB emission bandwidth in megahertz.

If transmitting antennas of directional gain greater than 6 dBi are used, the peak output power shall be reduced by the amount in dB that the directional gain of the antenna exceeds 6 dBi.

Note that U-NII-2 band, devices with a maximum e.i.r.p. greater than 500 mW shall implement TPC in order to have the capability to operate at least 6 dB below the maximum permitted e.i.r.p. of 1 W.

3.2.2 Measuring Instruments

The measuring equipment is listed in the section 4 of this test report.

3.2.3 Test Procedures

The testing follows Method PM of FCC KDB 789033 D02 General UNII Test Procedures New Rules v01r01.

Method PM (Measurement using an RF average power meter):

1. Measurement is performed using a wideband RF power meter.
2. The EUT is configured to transmit continuously with a consistent duty cycle at its maximum power control level.
3. Measure the average power of the transmitter, and the average power is corrected with duty factor, $10 \log(1/x)$, where x is the duty cycle.

3.2.4 Test Setup

For normal channel:

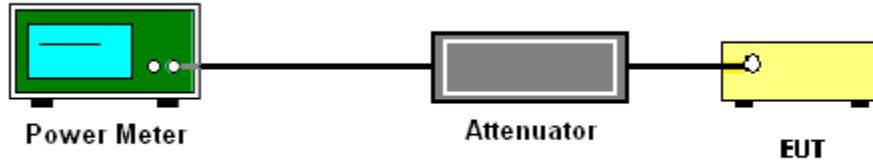

3.2.5 Test Result of Maximum Conducted Output Power

Please refer to Appendix A.



3.3 Power Spectral Density Measurement

3.3.1 Limit of Power Spectral Density

For mobile and portable client devices in the 5.15–5.25 GHz band, the maximum power spectral density shall not exceed 11dBm in any 1 megahertz band.

For the 5.25–5.35 GHz and 5.47–5.725 GHz bands, the maximum power spectral density shall not exceed 11 dBm in any 1 megahertz band.

If transmitting antennas of directional gain greater than 6 dBi are used, the peak output power shall be reduced by the amount in dB that the directional gain of the antenna exceeds 6 dBi.

3.3.2 Measuring Instruments

The measuring equipment is listed in the section 4 of this test report.

3.3.3 Test Procedures

The testing follows FCC KDB 789033 D02 General UNII Test Procedures New Rules v01r01.
Section F) Maximum power spectral density.

Method SA-2

(trace averaging across on and off times of the EUT transmissions, followed by duty cycle correction).

1. The testing follows Method SA-2 of FCC KDB 789033 D02 General UNII Test Procedures New Rules v01r01.
 - Measure the duty cycle.
 - Set span to encompass the entire emission bandwidth (EBW) of the signal.
 - Set RBW = 1 MHz.
 - Set VBW \geq 3 MHz.
 - Number of points in sweep \geq 2 Span / RBW.
 - Sweep time = auto.
 - Detector = RMS
 - Trace average at least 100 traces in power averaging mode.
 - Add $10 \log(1/x)$, where x is the duty cycle, to the measured power in order to compute the average power during the actual transmission times. For example, add $10 \log(1/0.25) = 6$ dB if the duty cycle is 25 percent.
2. The RF output of EUT was connected to the spectrum analyzer by a low loss cable.
3. Each plot has already offset with cable loss, and attenuator loss. Measure the PPSD and record it.

3.3.4 Test Setup

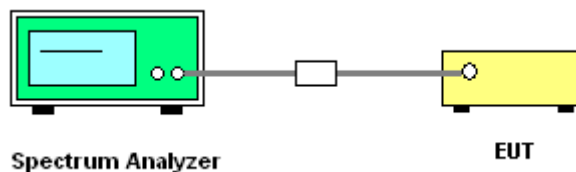



3.3.5 Test Result of Power Spectral Density

Please refer to Appendix A.

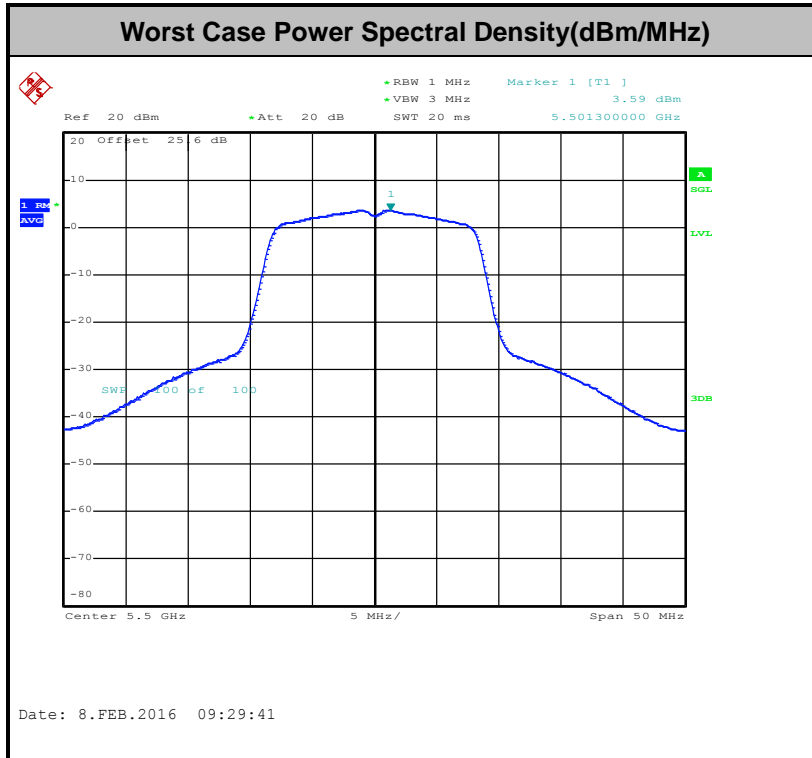

Note: Average Power Density (dB) = Measured value+ Duty Factor



3.4 Unwanted Radiated Emission Measurement

This section as specified in FCC Part 15.407(b) is to measure unwanted emissions through radiated measurement for band edge spurious emissions and out of band emissions measurement. The unwanted emissions shall comply with 15.407(b)(1) to (6), and restricted bands per FCC Part15.205.

3.4.1 Limit of Unwanted Emissions

(1) For transmitters operating in the 5150-5250 MHz band: all emissions outside of the 5150-5350 MHz band shall not exceed an EIRP of -27dBm/MHz.

For transmitters operating in the 5250-5350 MHz band: all emissions outside of the 5150-5350 MHz band shall not exceed an EIRP of -27 dBm/MHz. Devices operating in the 5250-5350 MHz band that generate emissions in the 5150-5250 MHz band must meet all applicable technical requirements for operation in the 5150-5250 MHz band (including indoor use) or alternatively meet an out-of-band emission EIRP limit of -27 dBm/MHz in the 5150-5250 MHz band.

For transmitters operating in the 5470-5600 MHz and 5650-5725MHz band: all emissions outside of the 5470-5600 MHz and 5650-5725MHz band shall not exceed an EIRP of -27 dBm/MHz

(2) Unwanted spurious emissions fallen in restricted bands per FCC Part15.205 shall comply with the general field strength limits set forth in § 15.209 as below table,

Frequency (MHz)	Field Strength (microvolts/meter)	Measurement Distance (meters)
0.009 – 0.490	2400/F(kHz)	300
0.490 – 1.705	24000/F(kHz)	30
1.705 – 30.0	30	30
30 – 88	100	3
88 – 216	150	3
216 - 960	200	3
Above 960	500	3

Note: The following formula is used to convert the EIRP to field strength.

$$E = \frac{1000000\sqrt{30P}}{3} \mu\text{V/m, where P is the eirp (Watts)}$$

EIRP (dBm)	Field Strength at 3m (dBμV/m)
-17	78.3
- 27	68.3



- (3) KDB789033 D02 v01r01 G)2)c) As specified in 15.407(b), emissions above 1000 MHz that are outside of the restricted bands are subject to a peak emission limit of -27 dBm/MHz (or -17 dBm/MHz as specified in 15.407(b)(4)). However, an out-of-band emission that complies with both the average and peak limits of 15.209 is not required to satisfy the -27 dBm/MHz or -17 dBm/MHz peak emission limit.

3.4.2 Measuring Instruments

The measuring equipment is listed in the section 4 of this test report.

3.4.3 Test Procedures

- 1. The testing follows FCC KDB 789033 D02 General UNII Test Procedures New Rules v01r01. Section G) Unwanted emissions measurement.

(1) Procedure for Unwanted Emissions Measurements Below 1000MHz

- RBW = 120 kHz
- VBW = 300 kHz
- Detector = Peak
- Trace mode = max hold

(2) Procedure for Peak Unwanted Emissions Measurements Above 1000 MHz

- RBW = 1 MHz
- VBW ≥ 3 MHz
- Detector = Peak
- Sweep time = auto
- Trace mode = max hold

(3) Procedures for Average Unwanted Emissions Measurements Above 1000MHz

- RBW = 1 MHz
- VBW = 10 Hz, when duty cycle is no less than 98 percent.
- $VBW \geq 1/T$, when duty cycle is less than 98 percent where T is the minimum transmission duration over which the transmitter is on and is transmitting at its maximum power control level for the tested mode of operation.

Band	Duty Cycle(%)	T(μs)	1/T(kHz)	VBW Setting
802.11a	97.2	1390	0.72	1kHz
802.11n HT20	97.02	1300	0.77	1kHz
802.11n HT40	94.74	648	1.54	3kHz

2. The EUT was placed on a turntable with 0.8 meter for frequency below 1GHz and 1.5 meter for frequency above 1GHz respectively above ground.
3. The EUT was set 3 meters from the interference receiving antenna which was mounted on the top of a variable height antenna tower.
4. The antenna is a broadband antenna and its height is adjusted between one meter and four meters above ground to find the maximum value of the field strength for both horizontal polarization and vertical polarization of the antenna.
5. For each suspected emission, the EUT was arranged to its worst case and then adjust the antenna tower (from 1 m to 4 m) and turntable (from 0 degree to 360 degrees) to find the maximum reading.
6. For testing below 1GHz, if the emission level of the EUT in peak mode was 3 dB lower than the limit specified, then peak values of EUT will be reported, otherwise, the emissions will be repeated one by one using the CISPR quasi-peak method and reported.
7. For testing above 1GHz, the emission level of the EUT in peak mode was 20dB lower than average limit (that means the emission level in average mode also complies with the limit in average mode), then peak values of EUT will be reported, otherwise, the emissions will be measured in average mode again and reported.

3.4.4 Test Setup

For radiated emissions below 30MHz

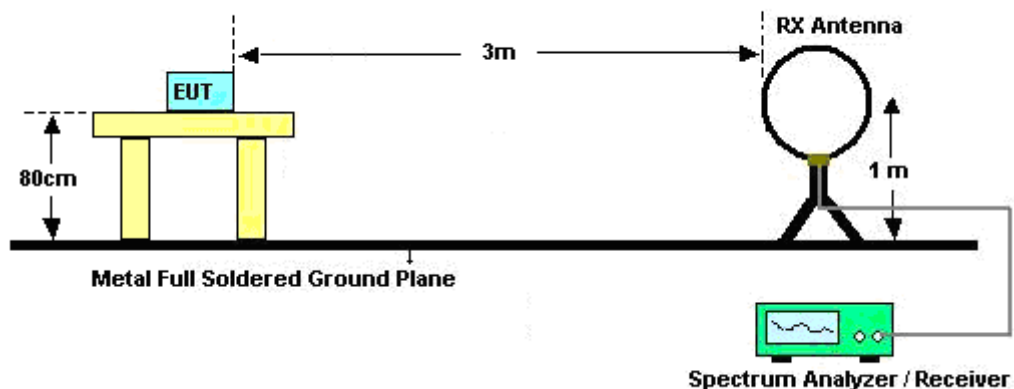

For radiated emissions from 30MHz to 1GHz

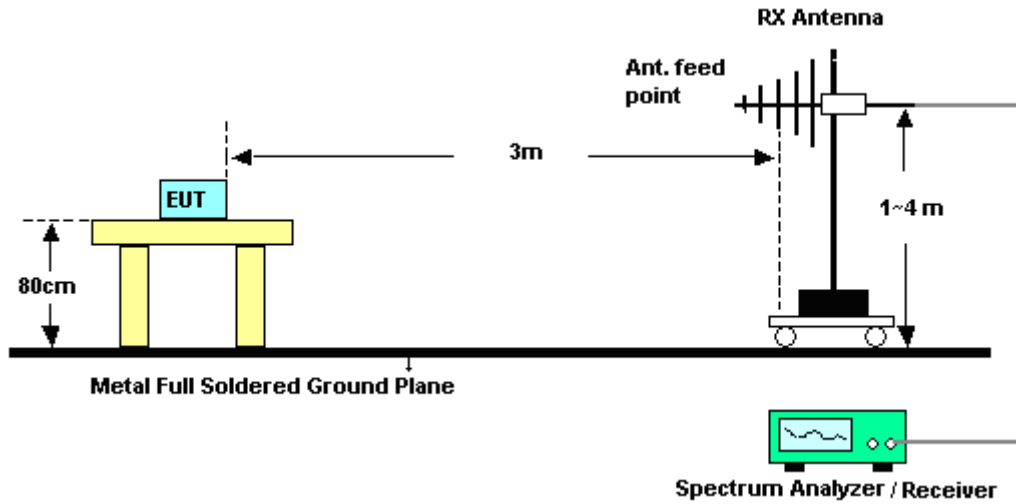

For radiated emissions above 1GHz

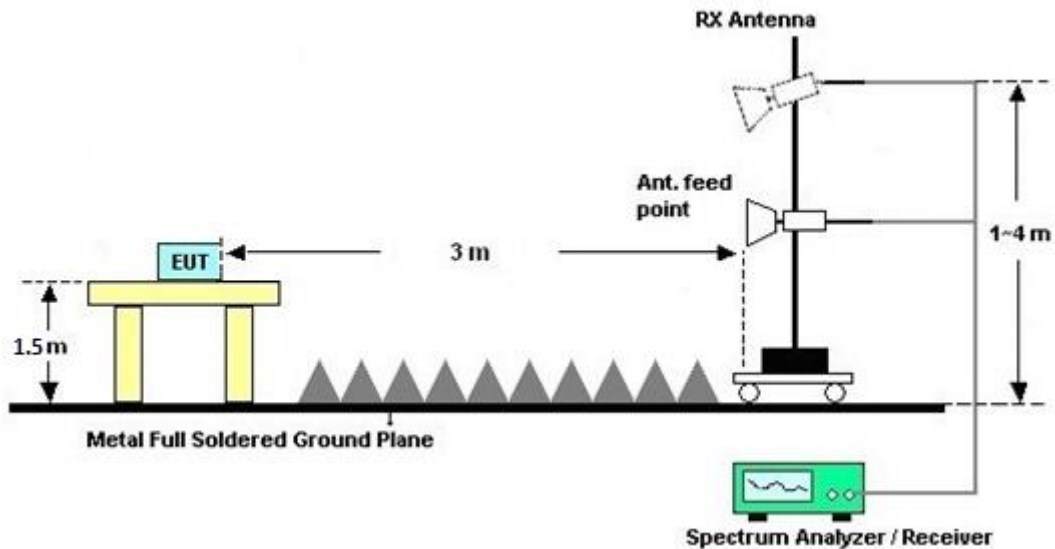

3.4.5 Test Results of Radiated Emissions (9 kHz ~ 30 MHz)

The low frequency, which started from 9 kHz to 30MHz, was pre-scanned and the result which was 20dB lower than the limit line per 15.31(o) was not reported.

3.4.6 Test Result of Radiated Band Edges

Please refer to Appendix B and C.

3.4.7 Test Result of Unwanted Radiated Emission (30MHz ~ 10th Harmonic)

Please refer to Appendix B and C.



3.4.8 Duty Cycle

802.11a

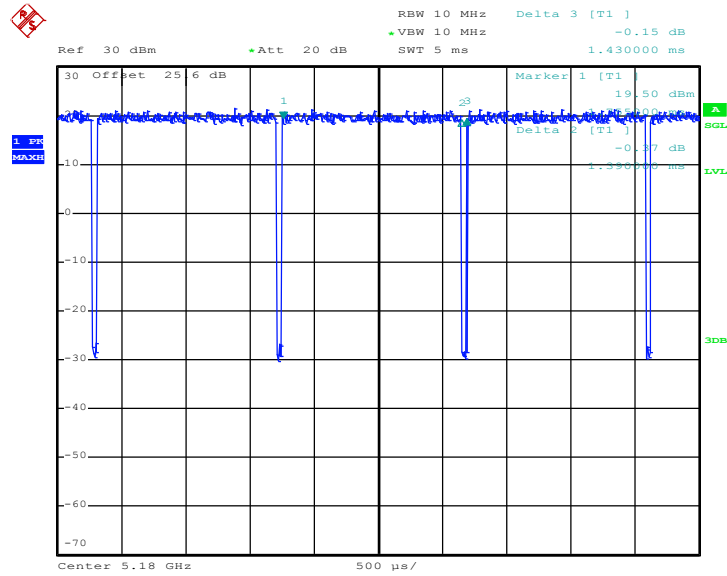

Date: 5.FEB.2016 13:59:25

802.11n HT20

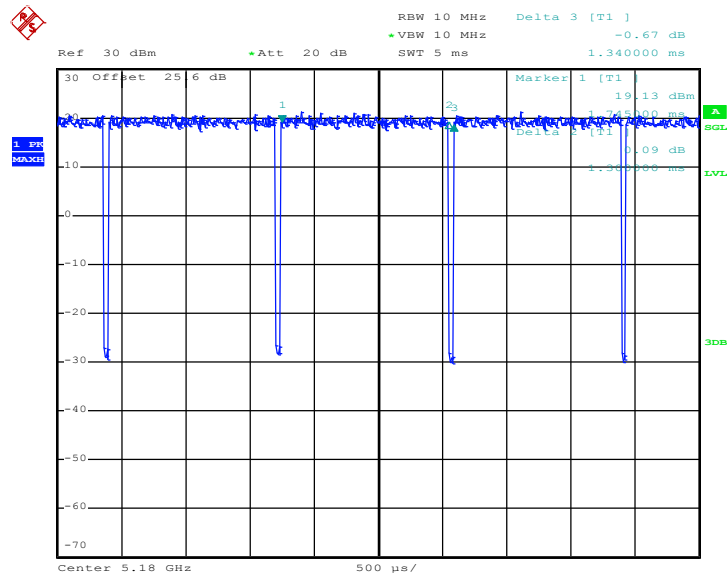

Date: 5.FEB.2016 14:00:48



802.11n HT40

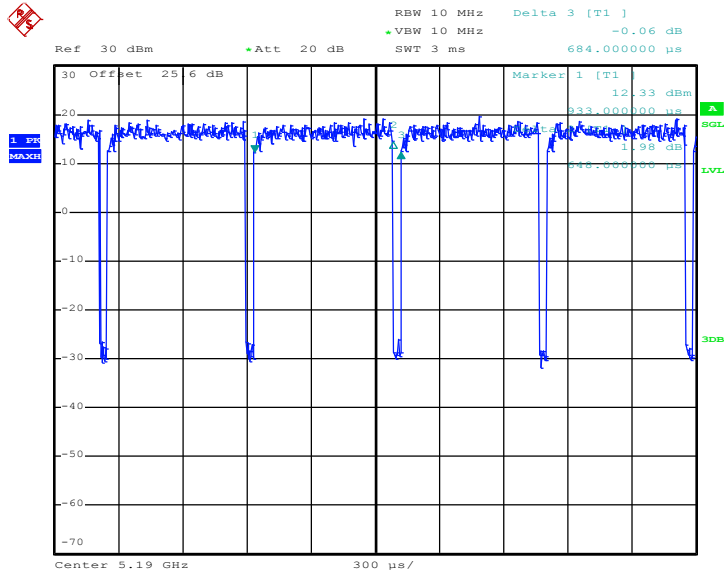

Date: 5.FEB.2016 14:03:21



3.5 AC Conducted Emission Measurement

3.5.1 Limit of AC Conducted Emission

For equipment that is designed to be connected to the public utility (AC) power line, the radio frequency voltage that is conducted back onto the AC power line on any frequency or frequencies within the band 150 kHz to 30 MHz shall not exceed the limits in the following table.

Frequency of emission (MHz)	Conducted limit (dB μ V)	
	Quasi-peak	Average
0.15-0.5	66 to 56*	56 to 46*
0.5-5	56	46
5-30	60	50

*Decreases with the logarithm of the frequency.

3.5.2 Measuring Instruments

The measuring equipment is listed in the section 4 of this test report.

3.5.3 Test Procedures

1. The EUT was placed 0.4 meter from the conducting wall of the shielding room was kept at least 80 centimeters from any other grounded conducting surface.
2. Connect EUT to the power mains through a line impedance stabilization network (LISN).
3. All the support units are connecting to the other LISN.
4. The LISN provides 50 ohm coupling impedance for the measuring instrument.
5. The FCC states that a 50 ohm, 50 microhenry LISN should be used.
6. Both sides of AC line were checked for maximum conducted interference.
7. The frequency range from 150 kHz to 30 MHz was searched.
8. Set the test-receiver system to Peak Detect Function and specified bandwidth with Maximum Hold Mode.

3.5.4 Test Setup

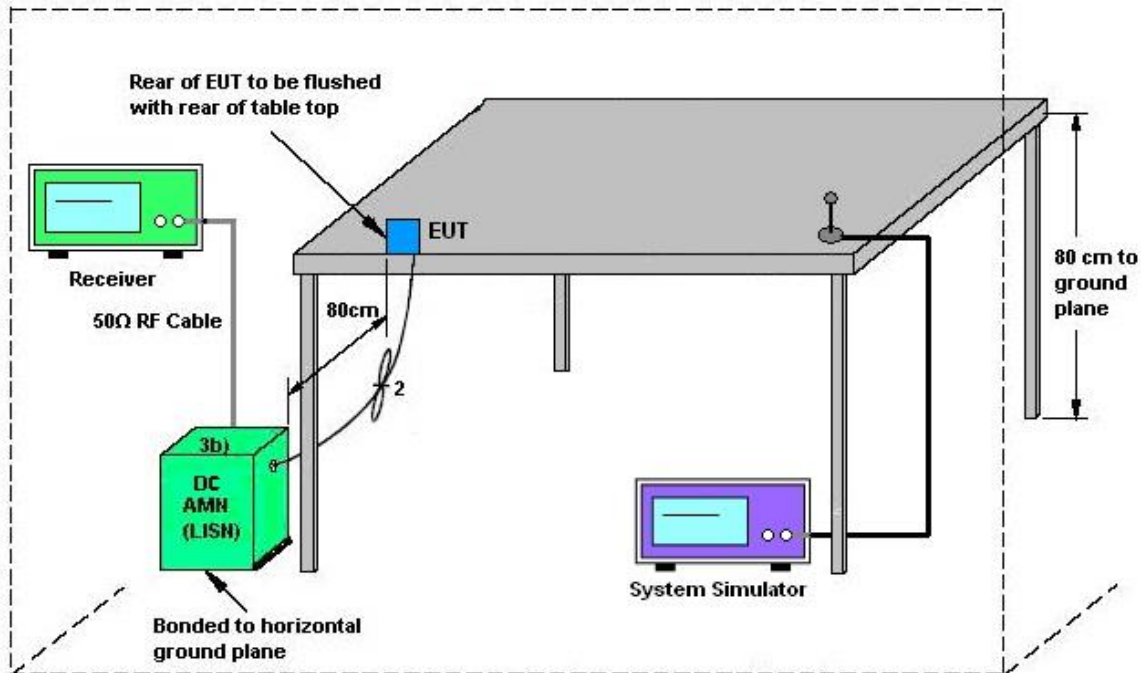

AMN = Artificial mains network (LISN)
AE = Associated equipment
EUT = Equipment under test
ISN = Impedance stabilization network



3.5.5 Test Result of AC Conducted Emission

Test Mode :	Mode 1	Temperature :	21~22°C
Test Engineer :	Eric Jeng	Relative Humidity :	51~53%
Test Voltage :	120Vac / 60Hz	Phase :	Line
Function Type :	GSM1900 Idle + Bluetooth Link + WLAN (5GHz) Link + MP3 + Earphone + Battery 2 + USB Cable (Charging from Adapter)		

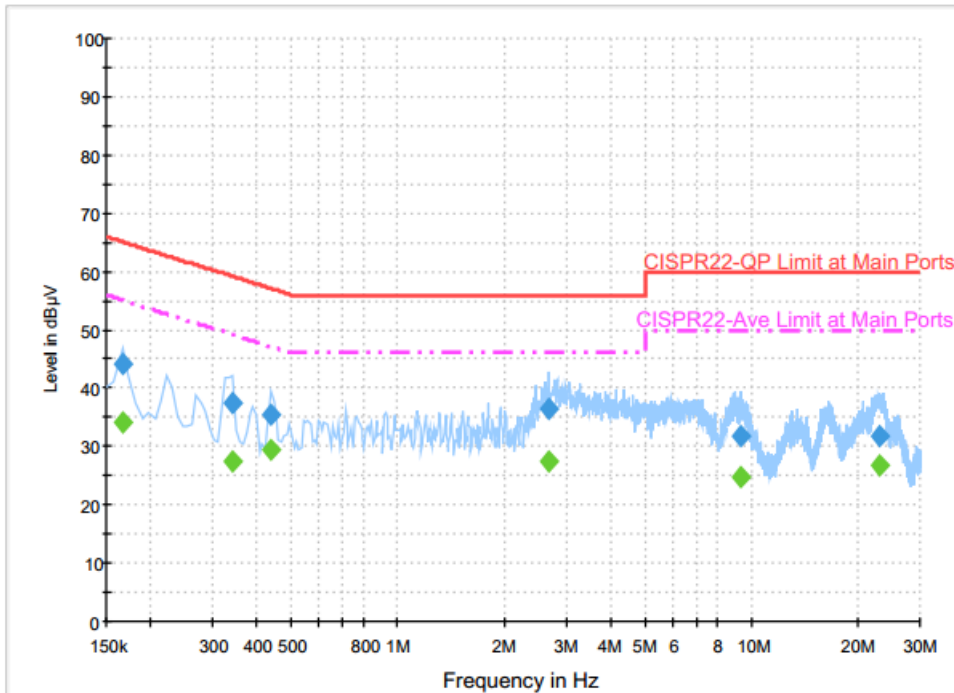

Final Result : QuasiPeak

Frequency (MHz)	QuasiPeak (dBµV)	Filter	Line	Corr. (dB)	Margin (dB)	Limit (dBµV)
0.166000	44.2	Off	L1	19.6	21.0	65.2
0.342000	37.6	Off	L1	19.6	21.6	59.2
0.438000	35.4	Off	L1	19.6	21.7	57.1
2.678000	36.4	Off	L1	19.4	19.6	56.0
9.326000	31.8	Off	L1	19.7	28.2	60.0
23.062000	31.8	Off	L1	19.9	28.2	60.0

Final Result : Average

Frequency (MHz)	Average (dBµV)	Filter	Line	Corr. (dB)	Margin (dB)	Limit (dBµV)
0.166000	34.3	Off	L1	19.6	20.9	55.2
0.342000	27.3	Off	L1	19.6	21.9	49.2
0.438000	29.3	Off	L1	19.6	17.8	47.1
2.678000	27.4	Off	L1	19.4	18.6	46.0
9.326000	24.8	Off	L1	19.7	25.2	50.0
23.062000	26.7	Off	L1	19.9	23.3	50.0



Test Mode :	Mode 1	Temperature :	21~22°C
Test Engineer :	Eric Jeng	Relative Humidity :	51~53%
Test Voltage :	120Vac / 60Hz	Phase :	Neutral
Function Type :	GSM1900 Idle + Bluetooth Link + WLAN (5GHz) Link + MP3 + Earphone + Battery 2 + USB Cable (Charging from Adapter)		

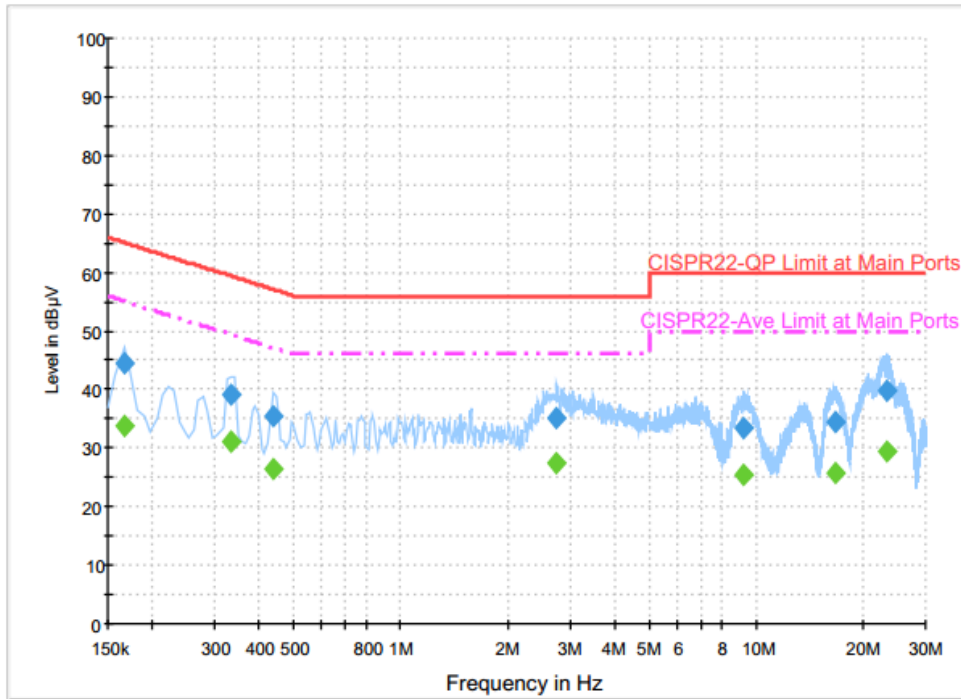

Final Result : QuasiPeak

Frequency (MHz)	QuasiPeak (dBµV)	Filter	Line	Corr. (dB)	Margin (dB)	Limit (dBµV)
0.166000	44.4	Off	N	19.6	20.8	65.2
0.334000	39.0	Off	N	19.6	20.4	59.4
0.438000	35.4	Off	N	19.6	21.7	57.1
2.734000	35.2	Off	N	19.5	20.8	56.0
9.222000	33.4	Off	N	19.8	26.6	60.0
16.678000	34.5	Off	N	19.9	25.5	60.0
23.230000	39.9	Off	N	20.0	20.1	60.0

Final Result : Average

Frequency (MHz)	Average (dBµV)	Filter	Line	Corr. (dB)	Margin (dB)	Limit (dBµV)
0.166000	33.7	Off	N	19.6	21.5	55.2
0.334000	31.0	Off	N	19.6	18.4	49.4
0.438000	26.4	Off	N	19.6	20.7	47.1
2.734000	27.6	Off	N	19.5	18.4	46.0
9.222000	25.4	Off	N	19.8	24.6	50.0
16.678000	25.8	Off	N	19.9	24.2	50.0
23.230000	29.5	Off	N	20.0	20.5	50.0

3.6 Frequency Stability Measurement

3.6.1 Limit of Frequency Stability

Manufacturers of U-NII devices are responsible for ensuring frequency stability such that an emission is maintained within the band of operation under all conditions of normal operation as specified in the user's manual.

3.6.2 Measuring Instruments

The measuring equipment is listed in the section 4 of this test report.

3.6.3 Test Procedures

1. To ensure emission at the band edge is maintained within the authorized band, those values shall be measured by radiation emissions at upper and lower frequency points, and finally compensated by frequency deviation as procedures below.
2. The EUT was operated at the maximum output power, and connected to the spectrum analyzer, which is set to maximum hold function and peak detector. The peak value of the power envelope was measured and noted. The upper and lower frequency points were respectively measured relatively 10dB lower than the measured peak value.
3. The frequency deviation was calculated by adding the upper frequency point and the lower frequency point divided by two. Those detailed values of frequency deviation are provided in table below.

3.6.4 Test Setup



3.6.5 Test Result of Frequency Stability

Please refer to Appendix A.



3.7 Automatically Discontinue Transmission

3.7.1 Limit of Automatically Discontinue Transmission

The device shall automatically discontinue transmission in case of either absence of information to transmit or operational failure. These provisions are not intended to preclude the transmission of control or signaling information or the use of repetitive codes used by certain digital technologies to complete frame or burst intervals. Applicants shall include in their application for equipment authorization to describe how this requirement is met.

3.7.2 Measuring Instruments

The measuring equipment is listed in the section 4 of this test report.

3.7.3 Test Result of Automatically Discontinue Transmission

While the EUT is not transmitting any information, the EUT can automatically discontinue transmission and become standby mode for power saving. The EUT can detect the controlling signal of ACK message transmitting from remote device and verify whether it shall resend or discontinue transmission.



3.8 Antenna Requirements

3.8.1 Standard Applicable

According to FCC 47 CFR Section 15.407(a)(1)(2) ,if transmitting antenna directional gain is greater than 6 dBi, both the peak transmit power and the peak power spectral density shall be reduced by the amount in dB that the directional gain of the antenna exceeds 6 dBi.

3.8.2 Antenna Anti-Replacement Construction

An embedded-in antenna design is used.

3.8.3 Antenna Gain

The antenna gain is less than 6 dBi. Therefore, it is not necessary to reduce maximum peak output power limit.



4 List of Measuring Equipments

Instrument	Manufacturer	Model No.	Serial No.	Characteristics	Calibration Date	Test Date	Due Date	Remark
Hygrometer	Testo	608-H2	41410069	N/A	Aug. 27, 2015	Feb. 05, 2016 ~ Feb. 18, 2016	Aug. 26, 2016	Conducted (TH05-HY)
Power Meter	Anritsu	ML2495A	1132003	300MHz~40GHz	Aug. 12, 2015	Feb. 05, 2016 ~ Feb. 18, 2016	Aug. 11, 2016	Conducted (TH05-HY)
Power Sensor	Anritsu	MA2411B	1126017	300MHz~40GHz	Aug. 12, 2015	Feb. 05, 2016 ~ Feb. 18, 2016	Aug. 11, 2016	Conducted (TH05-HY)
Spectrum Analyzer	Rohde & Schwarz	FSP40	100057	9kHz-40GHz	Nov. 23, 2015	Feb. 05, 2016 ~ Feb. 18, 2016	Nov. 22, 2016	Conducted (TH05-HY)
Temperature Chamber	ESPEC	SH-641	92013720	-40°C ~90°C	Sep. 08, 2015	Feb. 05, 2016 ~ Feb. 18, 2016	Sep. 07, 2016	Conducted (TH05-HY)
RF Cable	JYEBAO	K30K30-5003-1.5M40	N/A	0.1MHz~40GHz	Mar. 18, 2015	Feb. 05, 2016 ~ Feb. 18, 2016	Mar. 17, 2016	Conducted (TH05-HY)
Loop Antenna	Rohde & Schwarz	HFH2-Z2	100315	9 kHz~30 MHz	Sep. 02, 2015	Feb. 06, 2016 ~ Feb. 09, 2016	Sep. 01, 2016	Radiation (03CH11-HY)
Horn Antenna	SCHWARZBECK	BBHA 9170	BBHA9170584	18GHz- 40GHz	Nov. 02, 2015	Feb. 06, 2016 ~ Feb. 09, 2016	Nov. 01, 2016	Radiation (03CH11-HY)
Bilog Antenna	TESEQ	CBL 6111D	35414	30MHz~1GHz	Nov. 17, 2015	Feb. 06, 2016 ~ Feb. 09, 2016	Nov. 16, 2016	Radiation (03CH11-HY)
Horn Antenna	SCHWARZBECK	BBHA 9120 D	9120D-1326	1GHz ~ 18GHz	Oct. 08, 2015	Feb. 06, 2016 ~ Feb. 09, 2016	Oct. 07, 2016	Radiation (03CH11-HY)
Preamplifier	MITEQ	JS44-1800400 0-33-8P	1840917	18GHz ~ 40GHz	Jun. 02, 2015	Feb. 06, 2016 ~ Feb. 09, 2016	Jun. 01, 2016	Radiation (03CH11-HY)
Amplifier	SONOMA	310N	187312	9kHz~1GHz	Nov. 20, 2015	Feb. 06, 2016 ~ Feb. 09, 2016	Nov. 19, 2016	Radiation (03CH11-HY)
Preamplifier	Keysight	83017A	MY53270080	1GHz~26.5GHz	Nov. 19, 2015	Feb. 06, 2016 ~ Feb. 09, 2016	Nov. 18, 2016	Radiation (03CH11-HY)
Preamplifier	MITEQ	AMF-7D-0010 1800-30-10P	1902247	1GHz~18GHz	Jul. 01, 2015	Feb. 06, 2016 ~ Feb. 09, 2016	Jun. 30, 2016	Radiation (03CH11-HY)
Hygrometer	TECPEL	DTN-303B	TP140325	N/A	Nov. 17, 2015	Feb. 06, 2016 ~ Feb. 09, 2016	Nov. 16, 2016	Radiation (03CH11-HY)
Spectrum Analyzer	Keysight	N9010A	MY54200486	10Hz ~ 44GHZ	Sep. 24, 2015	Feb. 06, 2016 ~ Feb. 09, 2016	Sep. 23, 2016	Radiation (03CH11-HY)
EMI Test Receiver	Agilent	N9038A(MXE)	MY53290053	20Hz to 26.5GHz	Jan. 20, 2016	Feb. 06, 2016 ~ Feb. 09, 2016	Jan. 19, 2017	Radiation (03CH11-HY)
RF Cable	HUBER + SUHNER	SUCOFLEX 104	MY9837/4 MY28419/4MY 28654/4	9KHz~30MHz	Sep. 14, 2015	Feb. 06, 2016 ~ Feb. 09, 2016	Sep. 13, 2016	Radiation (03CH11-HY)
RF Cable	HUBER + SUHNER	SUCOFLEX 104	MY9837/4 MY28419/4MY 28654/4	30MHz~40GHz	Nov. 05, 2015	Feb. 06, 2016 ~ Feb. 09, 2016	Nov. 04, 2016	Radiation (03CH11-HY)
Filter	Wainwright	WLKS4500-8S S	SN19	4.5G Low Pass	Oct. 01, 2015	Feb. 06, 2016 ~ Feb. 09, 2016	Sep. 30, 2016	Radiation (03CH11-HY)
Filter	Microwave Circuits	H07G18G3	SN8009-01	7GHz HPF	Oct. 01, 2015	Feb. 06, 2016 ~ Feb. 09, 2016	Sep. 30, 2016	Radiation (03CH11-HY)
Controller	EMEC	EM 1000	N/A	Control Turn table & Ant Mast	N/A	Feb. 06, 2016 ~ Feb. 09, 2016	N/A	Radiation (03CH11-HY)



Instrument	Manufacturer	Model No.	Serial No.	Characteristics	Calibration Date	Test Date	Due Date	Remark
Antenna Mast	EMEC	AM-BS-4500-B	N/A	1~4m	N/A	Feb. 06, 2016 ~ Feb. 09, 2016	N/A	Radiation (03CH11-HY)
Turn Table	EMEC	TT 2000	N/A	0-360 degree	N/A	Feb. 06, 2016 ~ Feb. 09, 2016	N/A	Radiation (03CH11-HY)
Test Software	Audix	E3	6.2009-8-24	N/A	N/A	Feb. 06, 2016 ~ Feb. 09, 2016	N/A	Radiation (03CH11-HY)
AC Power Source	ChainTek	APC-1000W	N/A	N/A	N/A	Feb. 10, 2016	N/A	Conduction (CO05-HY)
EMI Test Receiver	Rohde & Schwarz	ESCI 7	100724	9kHz~7GHz	Aug. 26, 2015	Feb. 10, 2016	Aug. 25, 2016	Conduction (CO05-HY)
Hygrometer	Testo	608-H1	34913912	N/A	Apr. 20, 2015	Feb. 10, 2016	Apr. 19, 2016	Conduction (CO05-HY)
LISN	Rohde & Schwarz	ENV216	100080	9kHz~30MHz	Dec. 02, 2015	Feb. 10, 2016	Dec. 01, 2016	Conduction (CO05-HY)
LF Cable	HUBER + SUHNER	RG-214/U	LF01	N/A	Jan. 06, 2016	Feb. 10, 2016	Jan. 05, 2017	Conduction (CO05-HY)
Test Software	N/A	EMC32	8.40.0	N/A	N/A	Feb. 10, 2016	N/A	Conduction (CO05-HY)



5 Uncertainty of Evaluation

Uncertainty of Conducted Emission Measurement (150kHz ~ 30MHz)

Measuring Uncertainty for a Level of Confidence of 95% ($U = 2Uc(y)$)	2.26
---	------

Uncertainty of Radiated Emission Measurement (30 MHz ~ 1000 MHz)

Measuring Uncertainty for a Level of Confidence of 95% ($U = 2Uc(y)$)	4.90
---	------



Appendix A. Conducted Test Results

Test Engineer:	Osolemio Chang	Temperature:	21.7~23.9	°C
Test Date:	2016/2/5 ~ 2016/2/18	Relative Humidity:	51.8-53.4	%

TEST RESULTS DATA
26dB and 99% OBW

Band I										
Mod.	Data Rate	NTX	CH.	Freq. (MHz)	99% Bandwidth (MHz)	26 dB Bandwidth (MHz)	IC 99% Bandwidth Power Limit (dBm)	IC 99% Bandwidth EIRP Limit (dBm)		
11a	6Mbps	1	36	5180	18.00	40.60	-	22.55		
11a	6Mbps	1	44	5220	17.65	37.80	-	22.47		
11a	6Mbps	1	48	5240	17.85	39.20	-	22.52		
HT20	MCS0	1	36	5180	18.45	36.50	-	22.66		
HT20	MCS0	1	44	5220	18.30	32.50	-	22.62		
HT20	MCS0	1	48	5240	18.45	36.30	-	22.66		
HT40	MCS0	1	38	5190	36.70	68.58	-	23.01		
HT40	MCS0	1	46	5230	36.50	68.22	-	23.01		

TEST RESULTS DATA
Average Power Table

FCC Band I										
Mod.	Data Rate	NTX	CH.	Freq. (MHz)	Duty Factor (dB)	Average Conducted Power (dBm)	FCC Conducted Power Limit (dBm)	DG (dBi)		Pass/Fail
11a	6Mbps	1	36	5180	0.12	13.93	24.00	-2.00		Pass
11a	6Mbps	1	44	5220	0.12	13.91	24.00	-2.00		Pass
11a	6Mbps	1	48	5240	0.12	13.70	24.00	-2.00		Pass
HT20	MCS0	1	36	5180	0.13	12.95	24.00	-2.00		Pass
HT20	MCS0	1	44	5220	0.13	12.90	24.00	-2.00		Pass
HT20	MCS0	1	48	5240	0.13	12.94	24.00	-2.00		Pass
HT40	MCS0	1	38	5190	0.23	10.33	24.00	-2.00		Pass
HT40	MCS0	1	46	5230	0.23	12.98	24.00	-2.00		Pass

TEST RESULTS DATA
Power Spectral Density

FCC Band I										
Mod.	Data Rate	NTX	CH.	Freq. (MHz)	Duty Factor (dB)	Average Power Density (dBm/MHz)	Average PSD Limit (dBm/MHz)	DG (dBi)	-	Pass/Fail
11a	6Mbps	1	36	5180	0.12	3.06	11.00	-2.00		Pass
11a	6Mbps	1	44	5220	0.12	2.88	11.00	-2.00		Pass
11a	6Mbps	1	48	5240	0.12	3.20	11.00	-2.00		Pass
HT20	MCS0	1	36	5180	0.13	0.90	11.00	-2.00		Pass
HT20	MCS0	1	44	5220	0.13	1.26	11.00	-2.00		Pass
HT20	MCS0	1	48	5240	0.13	1.41	11.00	-2.00		Pass
HT40	MCS0	1	38	5190	0.23	-5.95	11.00	-2.00		Pass
HT40	MCS0	1	46	5230	0.23	-2.69	11.00	-2.00		Pass

TEST RESULTS DATA
26dB and 99% OBW

Band II										
Mod.	Data Rate	NTX	CH.	Freq. (MHz)	99% Bandwidth (MHz)	26 dB Bandwidth (MHz)	IC 99% Bandwidth Power Limit (dBm)	IC 99% Bandwidth EIRP Limit (dBm)	FCC 26dB Bandwidth Power Limit (dBm)	Note
11a	6M bps	1	52	5260	17.85	38.1	23.52	29.52	23.98	
11a	6M bps	1	60	5300	17.85	37.7	23.52	29.52	23.98	
11a	6M bps	1	64	5320	18.15	34.7	23.59	29.59	23.98	
HT20	MCS 0	1	52	5260	18.4	36.4	23.65	29.65	23.98	
HT20	MCS 0	1	60	5300	18.4	36.6	23.65	29.65	23.98	
HT20	MCS 0	1	64	5320	18.45	36.1	23.66	29.66	23.98	
HT40	MCS 0	1	54	5270	36.6	73.62	23.98	30.00	23.98	
HT40	MCS 0	1	62	5310	36.4	67.14	23.98	30.00	23.98	

TEST RESULTS DATA
Average Power Table

FCC Band II										
Mod.	Data Rate	NTX	CH.	Freq. (MHz)	Duty Factor (dB)	Average Conducted Power (dBm)	FCC Conducted Power Limit (dBm)	DG (dBi)		Pass/Fail
11a	6M bps	1	52	5260	0.12	13.72	23.98	-1.20		Pass
11a	6M bps	1	60	5300	0.12	13.98	23.98	-1.20		Pass
11a	6M bps	1	64	5320	0.12	13.99	23.98	-1.20		Pass
HT20	MCS 0	1	52	5260	0.13	12.73	23.98	-1.20		Pass
HT20	MCS 0	1	60	5300	0.13	12.97	23.98	-1.20		Pass
HT20	MCS 0	1	64	5320	0.13	12.98	23.98	-1.20		Pass
HT40	MCS 0	1	54	5270	0.23	12.95	23.98	-1.20		Pass
HT40	MCS 0	1	62	5310	0.23	11.47	23.98	-1.20		Pass

TEST RESULTS DATA
Power Spectral Density

Band II										
Mod.	Data Rate	NTX	CH.	Freq. (MHz)	Duty Factor (dB)	Average Power Density (dBm/MHz)	Average PSD Limit (dBm/MHz)	DG (dBi)		Pass/Fail
11a	6M bps	1	52	5260	0.12	2.74	11.00	-1.20		Pass
11a	6M bps	1	60	5300	0.12	3.39	11.00	-1.20		Pass
11a	6M bps	1	64	5320	0.12	3.04	11.00	-1.20		Pass
HT20	MCS 0	1	52	5260	0.13	1.45	11.00	-1.20		Pass
HT20	MCS 0	1	60	5300	0.13	1.61	11.00	-1.20		Pass
HT20	MCS 0	1	64	5320	0.13	1.54	11.00	-1.20		Pass
HT40	MCS 0	1	54	5270	0.23	-2.39	11.00	-1.20		Pass
HT40	MCS 0	1	62	5310	0.23	-2.46	11.00	-1.20		Pass

TEST RESULTS DATA
26dB and 99% OBW

Band III										
Mod.	Data Rate	NTX	CH.	Freq. (MHz)	99% Bandwidth (MHz)	26 dB Bandwidth (MHz)	IC 99% Bandwidth Power Limit (dBm)	IC 99% Bandwidth EIRP Limit (dBm)	FCC 26dB Bandwidth Power Limit (dBm)	Note
11a	6M bps	1	100	5500	17.45	31.7	23.42	29.42	23.98	
11a	6M bps	1	116	5580	17.35	26.9	23.39	29.39	23.98	
11a	6M bps	1	140	5700	17.25	24.6	23.37	29.37	23.98	
HT20	MCS 0	1	100	5500	18.15	29	23.59	29.59	23.98	
HT20	MCS 0	1	116	5580	18.3	28.3	23.62	29.62	23.98	
HT20	MCS 0	1	140	5700	18.25	24.5	23.61	29.61	23.98	
HT40	MCS 0	1	102	5510	36.3	53.82	23.98	30.00	23.98	
HT40	MCS 0	1	110	5550	36.3	60.48	23.98	30.00	23.98	
HT40	MCS 0	1	134	5670	36.3	49.86	23.98	30.00	23.98	

TEST RESULTS DATA
Average Power Table

FCC Band III										
Mod.	Data Rate	NTX	CH.	Freq. (MHz)	Duty Factor (dB)	Average Conducted Power (dBm)	FCC Conducted Power Limit (dBm)	DG (dBi)		Pass/Fail
11a	6M bps	1	100	5500	0.12	13.70	23.98	-2.50		Pass
11a	6M bps	1	116	5580	0.12	13.92	23.98	-2.50		Pass
11a	6M bps	1	140	5700	0.12	13.94	23.98	-2.50		Pass
HT20	MCS 0	1	100	5500	0.13	12.96	23.98	-2.50		Pass
HT20	MCS 0	1	116	5580	0.13	12.91	23.98	-2.50		Pass
HT20	MCS 0	1	140	5700	0.13	12.97	23.98	-2.50		Pass
HT40	MCS 0	1	102	5510	0.23	12.89	23.98	-2.50		Pass
HT40	MCS 0	1	110	5550	0.23	12.88	23.98	-2.50		Pass
HT40	MCS 0	1	134	5670	0.23	12.73	23.98	-2.50		Pass

TEST RESULTS DATA
Power Spectral Density

Band III										
Mod.	Data Rate	NTX	CH.	Freq. (MHz)	Duty Factor (dB)	Average Power Density (dBm/MHz)	Average PSD Limit (dBm/MHz)	DG (dBi)		Pass/Fail
11a	6M bps	1	100	5500	0.12	3.71	11.00	-2.50		Pass
11a	6M bps	1	116	5580	0.12	3.63	11.00	-2.50		Pass
11a	6M bps	1	140	5700	0.12	2.59	11.00	-2.50		Pass
HT20	MCS 0	1	100	5500	0.13	2.18	11.00	-2.50		Pass
HT20	MCS 0	1	116	5580	0.13	2.25	11.00	-2.50		Pass
HT20	MCS 0	1	140	5700	0.13	0.61	11.00	-2.50		Pass
HT40	MCS 0	1	102	5510	0.23	-1.55	11.00	-2.50		Pass
HT40	MCS 0	1	110	5550	0.23	-1.33	11.00	-2.50		Pass
HT40	MCS 0	1	134	5670	0.23	-2.87	11.00	-2.50		Pass

TEST RESULTS DATA
Frequency Stability

Band I										
Mod.	Data Rate	NTX	CH.	Freq. (MHz)	Center Frequency (MHz)	Frequency Deviation (MHz)	Frequency Stability (ppm)	Temperature (°C)	Voltage (V)	Note
11a	6Mbps	1	36	5180	5180.000	0.000	0.00	20	3.5	
11a	6Mbps	1	36	5180	5180.000	0.000	0.00	20	4.35	
11a	6Mbps	1	36	5180	5180.000	0.000	0.00	20	3.8	
11a	6Mbps	1	36	5180	5180.000	0.000	0.00	-30	3.8	
11a	6Mbps	1	36	5180	5180.000	0.000	0.00	55	3.8	

Band II										
Mod.	Data Rate	NTX	CH.	Freq. (MHz)	Center Frequency (MHz)	Frequency Deviation (MHz)	Frequency Stability (ppm)	Temperature (°C)	Voltage (V)	Note
11a	6Mbps	1	64	5320	5320.000	0.000	0.00	20	3.5	
11a	6Mbps	1	64	5320	5320.000	0.000	0.00	20	4.35	
11a	6Mbps	1	64	5320	5320.000	0.000	0.00	20	3.8	
11a	6Mbps	1	64	5320	5320.000	0.000	0.00	-30	3.8	
11a	6Mbps	1	64	5320	5320.000	0.000	0.00	55	3.8	

Band III										
Mod.	Data Rate	NTX	CH.	Freq. (MHz)	Center Frequency (MHz)	Frequency Deviation (MHz)	Frequency Stability (ppm)	Temperature (°C)	Voltage (V)	Note
11a	6Mbps	1	100	5500	5500.000	0.000	0.00	20	3.5	
11a	6Mbps	1	100	5500	5500.000	0.000	0.00	20	4.35	
11a	6Mbps	1	100	5500	5500.000	0.000	0.00	20	3.8	
11a	6Mbps	1	100	5500	5500.000	0.000	0.00	-30	3.8	
11a	6Mbps	1	100	5500	5500.000	0.000	0.00	55	3.8	



Appendix B. Radiated Spurious Emission

Test Engineer :	J.C. Liang and Ken Wu	Temperature :	20~22°C
		Relative Humidity :	50~54%

Band 1 - 5150~5250MHz

WIFI 802.11a (Band Edge @ 3m)

WIFI Ant.	Note	Frequency (MHz)	Level (dBμV/m)	Over Limit (dB)	Limit Line (dBμV/m)	Read Level (dBμV)	Antenna Factor (dB/m)	Cable Loss (dB)	Preamp Factor (dB)	Ant Pos (cm)	Table Pos (deg)	Peak Avg. (P/A)	Pol. (H/V)	
802.11a CH 36 5180MHz		5141.15	50.29	-23.71	74	41.95	31.58	10.23	33.47	237	68	P	H	
		5149.7	43.35	-10.65	54	35.01	31.58	10.23	33.47	237	68	A	H	
	*	5180	105.26	-	-	96.88	31.62	10.23	33.47	237	68	P	H	
	*	5180	98.39	-	-	90.01	31.62	10.23	33.47	237	68	A	H	
													H	
														H
			5118.05	49.89	-24.11	74	41.6	31.54	10.22	33.47	100	101	P	V
			5149.7	41.26	-12.74	54	32.92	31.58	10.23	33.47	100	101	A	V
	*		5180	101.78	-	-	93.4	31.62	10.23	33.47	100	101	P	V
	*		5180	94.66	-	-	86.28	31.62	10.23	33.47	100	101	A	V
														V
														V
802.11a CH 44 5220MHz		5148.8	48.84	-25.16	74	40.5	31.58	10.23	33.47	227	72	P	H	
		5139.95	42.76	-11.24	54	34.43	31.58	10.22	33.47	227	72	A	H	
	*	5220	104.85	-	-	96.42	31.66	10.24	33.47	227	72	P	H	
	*	5220	96.96	-	-	88.53	31.66	10.24	33.47	227	72	A	H	
			5354.51	48.26	-25.74	74	39.17	31.82	10.75	33.48	227	72	P	H
			5373.54	39.61	-14.39	54	30.5	31.84	10.75	33.48	227	72	A	H
			5138.45	49.35	-24.65	74	41.04	31.56	10.22	33.47	100	114	P	V
			5139.95	41.4	-12.6	54	33.07	31.58	10.22	33.47	100	114	A	V
	*		5220	100.74	-	-	92.31	31.66	10.24	33.47	100	114	P	V
	*		5220	93.41	-	-	84.98	31.66	10.24	33.47	100	114	A	V
			5436.57	47.11	-26.89	74	37.83	31.92	10.84	33.48	100	114	P	V
			5428.98	38.96	-15.04	54	29.68	31.92	10.84	33.48	100	114	A	V



802.11a CH 48 5240MHz		5148.5	49.21	-24.79	74	40.87	31.58	10.23	33.47	235	69	P	H
		5149.4	40.74	-13.26	54	32.4	31.58	10.23	33.47	235	69	A	H
	*	5240	104.08	-	-	95.5	31.68	10.37	33.47	235	69	P	H
	*	5240	97.07	-	-	88.49	31.68	10.37	33.47	235	69	A	H
		5403.79	47.78	-26.22	74	38.51	31.88	10.87	33.48	235	69	P	H
		5392.79	40.01	-13.99	54	30.76	31.86	10.87	33.48	235	69	A	H
		5111.45	48.59	-25.41	74	40.3	31.54	10.22	33.47	107	109	P	V
		5149.7	39.87	-14.13	54	31.53	31.58	10.23	33.47	107	109	A	V
	*	5240	101	-	-	92.42	31.68	10.37	33.47	107	109	P	V
	*	5240	93.19	-	-	84.61	31.68	10.37	33.47	107	109	A	V
		5354.4	48.67	-25.33	74	39.58	31.82	10.75	33.48	107	109	P	V
		5394.11	39.15	-14.85	54	29.9	31.86	10.87	33.48	107	109	A	V
Remark	1. No other spurious found. 2. All results are PASS against Peak and Average limit line.												



Band 1 5150~5250MHz
WIFI 802.11a (Harmonic @ 3m)

WIFI Ant. 1	Note	Frequency (MHz)	Level (dBμV/m)	Over Limit (dB)	Limit Line (dBμV/m)	Read Level (dBμV)	Antenna Factor (dB/m)	Cable Loss (dB)	Preamp Factor (dB)	Ant Pos (cm)	Table Pos (deg)	Peak Avg. (P/A)	Pol. (H/V)
802.11a CH 36 5180MHz		10360	43.01	-30.99	74	55.86	39.79	14.86	67.5	100	0	P	H
		15540	49.2	-24.8	74	58.1	38.6	17.89	65.39	100	0	P	H
													H
													H
		10360	44.18	-29.82	74	57.03	39.79	14.86	67.5	100	0	P	V
		15540	57.84	-16.16	74	66.74	38.6	17.89	65.39	201	62	P	V
		15540	47.2	-6.8	54	56.1	38.6	17.89	65.39	201	62	A	V
													V
802.11a CH 44 5220MHz		10440	42.92	-31.08	74	55.62	39.89	14.91	67.5	100	0	P	H
		15660	48.67	-25.33	74	57.87	38.23	17.94	65.37	100	0	P	H
													H
													H
		10440	41.88	-32.12	74	54.58	39.89	14.91	67.5	100	0	P	V
		15660	60.46	-13.54	74	69.66	38.23	17.94	65.37	195	78	P	V
		15660	49.16	-4.84	54	58.36	38.23	17.94	65.37	195	78	A	V
													V
802.11a CH 48 5240MHz		10480	41.81	-32.19	74	54.4	39.97	14.94	67.5	100	0	P	H
		15720	49.55	-24.45	74	58.91	38.03	17.97	65.36	100	0	P	H
													H
													H
		10480	42.73	-31.27	74	55.32	39.97	14.94	67.5	100	0	P	V
		15720	59.85	-14.15	74	69.21	38.03	17.97	65.36	199	72	P	V
		15720	48.29	-5.71	54	57.65	38.03	17.97	65.36	199	72	A	V
													V
Remark	1. No other spurious found. 2. All results are PASS against Peak and Average limit line.												



Band 1 5150~5250MHz
WIFI 802.11n HT20 (Band Edge @ 3m)

WIFI Ant. 1	Note	Frequency (MHz)	Level (dBμV/m)	Over Limit (dB)	Limit Line (dBμV/m)	Read Level (dBμV)	Antenna Factor (dB/m)	Cable Loss (dB)	Preamp Factor (dB)	Ant Pos (cm)	Table Pos (deg)	Peak Avg. (P/A)	Pol. (H/V)	
802.11n HT20 CH 36 5180MHz		5144.6	52.25	-21.75	74	43.91	31.58	10.23	33.47	235	69	P	H	
		5149.55	44	-10	54	35.66	31.58	10.23	33.47	235	69	A	H	
	*	5180	104.31	-	-	95.93	31.62	10.23	33.47	235	69	P	H	
	*	5180	97.29	-	-	88.91	31.62	10.23	33.47	235	69	A	H	
													H	
													H	
			5146.55	49.97	-24.03	74	41.63	31.58	10.23	33.47	104	113	P	V
			5149.1	41.39	-12.61	54	33.05	31.58	10.23	33.47	104	113	A	V
		*	5180	99.94	-	-	91.56	31.62	10.23	33.47	104	113	P	V
		*	5180	93.06	-	-	84.68	31.62	10.23	33.47	104	113	A	V
													V	
													V	
802.11n HT20 CH 44 5220MHz		5147.15	50.57	-23.43	74	42.23	31.58	10.23	33.47	233	68	P	H	
		5140.1	42.25	-11.75	54	33.91	31.58	10.23	33.47	233	68	A	H	
		*	5220	103.15	-	-	94.72	31.66	10.24	33.47	233	68	P	H
		*	5220	95.34	-	-	86.91	31.66	10.24	33.47	233	68	A	H
			5383.22	47.42	-26.58	74	38.17	31.86	10.87	33.48	233	68	P	H
			5371.67	39.74	-14.26	54	30.63	31.84	10.75	33.48	233	68	A	H
			5139.95	48.45	-25.55	74	40.12	31.58	10.22	33.47	100	101	P	V
			5139.8	40.09	-13.91	54	31.76	31.58	10.22	33.47	100	101	A	V
		*	5220	99.02	-	-	90.59	31.66	10.24	33.47	100	101	P	V
		*	5220	91.15	-	-	82.72	31.66	10.24	33.47	100	101	A	V
		5421.61	47.57	-26.43	74	38.31	31.9	10.84	33.48	100	101	P	V	
		5459.01	38.91	-15.09	54	29.61	31.94	10.84	33.48	100	101	A	V	



802.11n HT20 CH 48 5240MHz		5095.55	49.39	-24.61	74	41.13	31.52	10.21	33.47	231	71	P	H
		5149.25	40.36	-13.64	54	32.02	31.58	10.23	33.47	231	71	A	H
	*	5240	102.69	-	-	94.11	31.68	10.37	33.47	231	71	P	H
	*	5240	86.27	-	-	77.69	31.68	10.37	33.47	231	71	A	H
		5379.7	48.66	-25.34	74	39.53	31.86	10.75	33.48	231	71	P	H
		5391.91	39.6	-14.4	54	30.35	31.86	10.87	33.48	231	71	A	H
		5105.45	48.13	-25.87	74	39.86	31.52	10.22	33.47	105	113	P	V
		5086.25	39.53	-14.47	54	31.29	31.5	10.21	33.47	105	113	A	V
	*	5240	97.14	-	-	88.56	31.68	10.37	33.47	105	113	P	V
	*	5240	90.72	-	-	82.14	31.68	10.37	33.47	105	113	A	V
		5378.93	47.29	-26.71	74	38.16	31.86	10.75	33.48	105	113	P	V
		5439.76	38.95	-15.05	54	29.67	31.92	10.84	33.48	105	113	A	V
Remark	1. No other spurious found. 2. All results are PASS against Peak and Average limit line.												



Band 1 5150~5250MHz
WIFI 802.11n HT20 (Harmonic @ 3m)

WIFI Ant. 1	Note	Frequency (MHz)	Level (dBμV/m)	Over Limit (dB)	Limit Line (dBμV/m)	Read Level (dBμV)	Antenna Factor (dB/m)	Cable Loss (dB)	Preamp Factor (dB)	Ant Pos (cm)	Table Pos (deg)	Peak Avg. (P/A)	Pol. (H/V)	
802.11n HT20 CH 36 5180MHz		10360	43.41	-30.59	74	56.26	39.79	14.86	67.5	100	0	P	H	
		15540	45.83	-28.17	74	54.73	38.6	17.89	65.39	100	0	P	H	
													H	
													H	
			10360	43.12	-30.88	74	55.97	39.79	14.86	67.5	100	0	P	V
			15540	55.99	-18.01	74	64.89	38.6	17.89	65.39	192	66	P	V
			15540	43.77	-10.23	54	52.67	38.6	17.89	65.39	192	66	A	V
													V	
802.11n HT20 CH 44 5220MHz		10440	43.13	-30.87	74	55.83	39.89	14.91	67.5	100	0	P	H	
		15660	46.77	-27.23	74	55.97	38.23	17.94	65.37	100	0	P	H	
													H	
													H	
			10440	42.86	-31.14	74	55.56	39.89	14.91	67.5	100	0	P	V
			15660	54.99	-19.01	74	64.19	38.23	17.94	65.37	196	68	P	V
			15660	45.81	-8.19	54	55.01	38.23	17.94	65.37	196	68	A	V
													V	
802.11n HT20 CH 48 5240MHz		10480	42.22	-31.78	74	54.81	39.97	14.94	67.5	100	0	P	H	
		15720	46.74	-27.26	74	56.1	38.03	17.97	65.36	100	0	P	H	
													H	
													H	
			10480	42.14	-31.86	74	54.73	39.97	14.94	67.5	100	0	P	V
			15720	59.45	-14.55	74	68.81	38.03	17.97	65.36	200	63	P	V
			15720	47.21	-6.79	54	56.57	38.03	17.97	65.36	200	63	A	V
													V	
Remark	1. No other spurious found. 2. All results are PASS against Peak and Average limit line.													



Band 1 5150~5250MHz
WIFI 802.11n HT40 (Band Edge @ 3m)

Table with 14 columns: WIFI Ant. 1, Note, Frequency (MHz), Level (dBµV/m), Over Limit (dB), Limit Line (dBµV/m), Read Level (dBµV), Antenna Factor (dB/m), Cable Loss (dB), Preamp Factor (dB), Ant Pos (cm), Table Pos (deg), Peak Avg. (P/A), Pol. (H/V). Rows include test data for 802.11n HT40 CH 38 (5190MHz) and 802.11n HT40 CH 46 (5230MHz).



Band 1 5150~5250MHz
WIFI 802.11n HT40 (Harmonic @ 3m)

WIFI Ant. 1	Note	Frequency (MHz)	Level (dBμV/m)	Over Limit (dB)	Limit Line (dBμV/m)	Read Level (dBμV)	Antenna Factor (dB/m)	Cable Loss (dB)	Preamp Factor (dB)	Ant Pos (cm)	Table Pos (deg)	Peak Avg. (P/A)	Pol. (H/V)
802.11n HT40 CH 38 5190MHz		10380	43.06	-30.94	74	55.89	39.81	14.86	67.5	100	0	P	H
		15570	40.9	-33.1	74	49.9	38.49	17.9	65.39	100	0	P	H
													H
													H
		10380	42.07	-31.93	74	54.9	39.81	14.86	67.5	100	0	P	V
		15570	45.14	-28.86	74	54.14	38.49	17.9	65.39	100	0	P	V
													V
802.11n HT40 CH 46 5230MHz		10460	41.38	-32.62	74	54.05	39.92	14.91	67.5	100	0	P	H
		15690	43.94	-30.06	74	53.21	38.13	17.96	65.36	100	0	P	H
													H
													H
		10460	41.87	-32.13	74	54.54	39.92	14.91	67.5	100	0	P	V
		15690	49.24	-24.76	74	58.51	38.13	17.96	65.36	100	0	P	V
													V
Remark	1. No other spurious found.												
	2. All results are PASS against Peak and Average limit line.												



Band 2 - 5250~5350MHz
WIFI 802.11a (Band Edge @ 3m)

WIFI	Note	Frequency	Level	Over	Limit	Read	Antenna	Cable	Preamp	Ant	Table	Peak	Pol.
Ant.				Limit	Line	Level	Factor	Loss	Factor	Pos	Pos	Avg.	
1		(MHz)	(dBμV/m)	(dB)	(dBμV/m)	(dBμV)	(dB/m)	(dB)	(dB)	(cm)	(deg)	(P/A)	(H/V)
802.11a CH 52 5260MHz		5078.9	49.24	-24.76	74	41	31.5	10.21	33.47	231	68	P	H
		5106.2	40.78	-13.22	54	32.49	31.54	10.22	33.47	231	68	A	H
	*	5260	105.43	-	-	96.82	31.72	10.37	33.48	231	68	P	H
	*	5260	97.36	-	-	88.75	31.72	10.37	33.48	231	68	A	H
		5388.17	48.77	-25.23	74	39.52	31.86	10.87	33.48	231	68	P	H
		5350.33	40.5	-13.5	54	31.41	31.82	10.75	33.48	231	68	A	H
		5003.15	48.41	-25.59	74	40.29	31.4	10.19	33.47	102	102	P	V
		5106.65	39.72	-14.28	54	31.43	31.54	10.22	33.47	102	102	A	V
	*	5260	100.97	-	-	92.36	31.72	10.37	33.48	102	102	P	V
	*	5260	92.97	-	-	84.36	31.72	10.37	33.48	102	102	A	V
		5425.35	48.36	-25.64	74	39.1	31.9	10.84	33.48	102	102	P	V
		5455.49	39.2	-14.8	54	29.9	31.94	10.84	33.48	102	102	A	V
802.11a CH 60 5300MHz		5132	48.32	-25.68	74	40.01	31.56	10.22	33.47	224	68	P	H
		5146.55	40.84	-13.16	54	32.5	31.58	10.23	33.47	224	68	A	H
	*	5300	104.71	-	-	95.94	31.76	10.49	33.48	224	68	P	H
	*	5300	97.03	-	-	88.26	31.76	10.49	33.48	224	68	A	H
		5373.43	49.97	-24.03	74	40.86	31.84	10.75	33.48	224	68	P	H
		5350.55	42.31	-11.69	54	33.22	31.82	10.75	33.48	224	68	A	H
		5073.95	48.64	-25.36	74	40.4	31.5	10.21	33.47	107	95	P	V
		5147.75	39.7	-14.3	54	31.36	31.58	10.23	33.47	107	95	A	V
	*	5300	98.53	-	-	89.76	31.76	10.49	33.48	107	95	P	V
	*	5300	90.85	-	-	82.08	31.76	10.49	33.48	107	95	A	V
		5447.24	48.92	-25.08	74	39.62	31.94	10.84	33.48	107	95	P	V
		5351.54	39.94	-14.06	54	30.85	31.82	10.75	33.48	107	95	A	V



802.11a CH 64 5320MHz	*	5320	103.19	-	-	94.27	31.78	10.62	33.48	221	67	P	H
	*	5320	96.47	-	-	87.55	31.78	10.62	33.48	221	67	A	H
		5363.09	51.7	-22.3	74	42.59	31.84	10.75	33.48	221	67	P	H
		5350.22	43.4	-10.6	54	34.31	31.82	10.75	33.48	221	67	A	H
													H
													H
	*	5320	97.72	-	-	88.8	31.78	10.62	33.48	100	95	P	V
	*	5320	90.99	-	-	82.07	31.78	10.62	33.48	100	95	A	V
		5350.66	48.58	-25.42	74	39.49	31.82	10.75	33.48	100	95	P	V
		5350.55	40.17	-13.83	54	31.08	31.82	10.75	33.48	100	95	A	V
													V
													V
Remark	1. No other spurious found. 2. All results are PASS against Peak and Average limit line.												



Band 2 5250~5350MHz
WIFI 802.11a (Harmonic @ 3m)

WIFI Ant. 1	Note	Frequency (MHz)	Level (dBµV/m)	Over Limit (dB)	Limit Line (dBµV/m)	Read Level (dBµV)	Antenna Factor (dB/m)	Cable Loss (dB)	Preamp Factor (dB)	Ant Pos (cm)	Table Pos (deg)	Peak Avg. (P/A)	Pol. (H/V)
802.11a CH 52 5260MHz		10520	43.13	-30.87	74	55.64	40.01	14.96	67.48	100	0	P	H
		15780	46.07	-27.93	74	55.55	37.87	17.99	65.34	100	0	P	H
													H
													H
		10520	44.68	-29.32	74	57.19	40.01	14.96	67.48	100	0	P	V
		15780	59.7	-14.3	74	69.18	37.87	17.99	65.34	196	63	P	V
		15780	48.86	-5.14	54	58.34	37.87	17.99	65.34	196	63	A	V
													V
802.11a CH 60 5300MHz		10600	44.1	-29.9	74	56.42	40.06	15.02	67.4	100	0	P	H
		15900	47.04	-26.96	74	56.81	37.51	18.04	65.32	100	0	P	H
													H
													H
		10600	44.27	-29.73	74	56.59	40.06	15.02	67.4	100	0	P	V
		15900	59.03	-14.97	74	68.8	37.51	18.04	65.32	194	63	P	V
		15900	47.48	-6.52	54	57.25	37.51	18.04	65.32	194	63	A	V
													V
802.11a CH 64 5320MHz		10640	44.52	-29.48	74	56.76	40.08	15.04	67.36	100	0	P	H
		15960	47.74	-26.26	74	57.67	37.3	18.08	65.31	100	0	P	H
													H
													H
		10640	44.79	-29.21	74	57.03	40.08	15.04	67.36	100	0	P	V
		15960	58.28	-15.72	74	68.21	37.3	18.08	65.31	196	63	P	V
		15960	48.21	-5.79	54	58.14	37.3	18.08	65.31	196	63	A	V
													V
Remark	1. No other spurious found. 2. All results are PASS against Peak and Average limit line.												



Band 2 5250~5350MHz
WIFI 802.11n HT20 (Band Edge @ 3m)

WIFI Ant. 1	Note	Frequency (MHz)	Level (dBμV/m)	Over Limit (dB)	Limit Line (dBμV/m)	Read Level (dBμV)	Antenna Factor (dB/m)	Cable Loss (dB)	Preamp Factor (dB)	Ant Pos (cm)	Table Pos (deg)	Peak Avg. (P/A)	Pol. (H/V)
802.11n HT20 CH 52 5260MHz		5077.7	48	-26	74	39.76	31.5	10.21	33.47	239	67	P	H
		5106.8	39.96	-14.04	54	31.67	31.54	10.22	33.47	239	67	A	H
	*	5260	102.07	-	-	93.46	31.72	10.37	33.48	239	67	P	H
	*	5260	94.86	-	-	86.25	31.72	10.37	33.48	239	67	A	H
		5353.52	47.98	-26.02	74	38.89	31.82	10.75	33.48	239	67	P	H
		5350.33	39.68	-14.32	54	30.59	31.82	10.75	33.48	239	67	A	H
		5098.7	49.17	-24.83	74	40.91	31.52	10.21	33.47	100	100	P	V
		5104.7	39.29	-14.71	54	31.02	31.52	10.22	33.47	100	100	A	V
	*	5260	98.14	-	-	89.53	31.72	10.37	33.48	100	100	P	V
	*	5260	90.09	-	-	81.48	31.72	10.37	33.48	100	100	A	V
		5428.32	47.6	-26.4	74	38.34	31.9	10.84	33.48	100	100	P	V
		5458.35	38.89	-15.11	54	29.59	31.94	10.84	33.48	100	100	A	V
802.11n HT20 CH 60 5300MHz		5093.15	48.65	-25.35	74	40.39	31.52	10.21	33.47	225	68	P	H
		5147.45	39.99	-14.01	54	31.65	31.58	10.23	33.47	225	68	A	H
	*	5300	103.31	-	-	94.54	31.76	10.49	33.48	225	68	P	H
	*	5300	95.3	-	-	86.53	31.76	10.49	33.48	225	68	A	H
		5351.43	48.61	-25.39	74	39.52	31.82	10.75	33.48	225	68	P	H
		5379.92	40.98	-13.02	54	31.85	31.86	10.75	33.48	225	68	A	H
		5100.2	48.51	-25.49	74	40.24	31.52	10.22	33.47	100	101	P	V
		5148.65	39.29	-14.71	54	30.95	31.58	10.23	33.47	100	101	A	V
	*	5300	98.23	-	-	89.46	31.76	10.49	33.48	100	101	P	V
	*	5300	89.88	-	-	81.11	31.76	10.49	33.48	100	101	A	V
	5438.77	47.97	-26.03	74	38.69	31.92	10.84	33.48	100	101	P	V	
	5351.87	39.27	-14.73	54	30.18	31.82	10.75	33.48	100	101	A	V	



802.11n HT20 CH 64 5320MHz	*	5320	101.83	-	-	92.91	31.78	10.62	33.48	224	71	P	H
	*	5320	94.52	-	-	85.6	31.78	10.62	33.48	224	71	A	H
		5353.19	49.08	-24.92	74	39.99	31.82	10.75	33.48	224	71	P	H
		5350.33	41.78	-12.22	54	32.69	31.82	10.75	33.48	224	71	A	H
													H
													H
	*	5320	97.07	-	-	88.15	31.78	10.62	33.48	100	101	P	V
	*	5320	90.01	-	-	81.09	31.78	10.62	33.48	100	101	A	V
		5361	48.27	-25.73	74	39.16	31.84	10.75	33.48	100	101	P	V
		5350.99	39.5	-14.5	54	30.41	31.82	10.75	33.48	100	101	A	V
													V
													V
Remark	1. No other spurious found. 2. All results are PASS against Peak and Average limit line.												



Band 2 5250~5350MHz
WIFI 802.11n HT20 (Harmonic @ 3m)

WIFI Ant. 1	Note	Frequency (MHz)	Level (dBμV/m)	Over Limit (dB)	Limit Line (dBμV/m)	Read Level (dBμV)	Antenna Factor (dB/m)	Cable Loss (dB)	Preamp Factor (dB)	Ant Pos (cm)	Table Pos (deg)	Peak Avg. (P/A)	Pol. (H/V)	
802.11n HT20 CH 52 5260MHz		10520	43	-31	74	55.51	40.01	14.96	67.48	100	0	P	H	
		15780	46.58	-27.42	74	56.06	37.87	17.99	65.34	100	0	P	H	
													H	
													H	
			10520	43.25	-30.75	74	55.76	40.01	14.96	67.48	100	0	P	V
			15780	58	-16	74	67.48	37.87	17.99	65.34	201	61	P	V
			15780	46.76	-7.24	54	56.24	37.87	17.99	65.34	201	61	A	V
													V	
802.11n HT20 CH 60 5300MHz		10600	42.6	-31.4	74	54.92	40.06	15.02	67.4	100	0	P	H	
		15900	43.91	-30.09	74	53.68	37.51	18.04	65.32	100	0	P	H	
													H	
													H	
			10600	42.65	-31.35	74	54.97	40.06	15.02	67.4	100	0	P	V
			15900	58.68	-15.32	74	68.45	37.51	18.04	65.32	199	63	P	V
			15900	46.22	-7.78	54	55.99	37.51	18.04	65.32	199	63	A	V
													V	
802.11n HT20 CH 64 5320MHz		10640	42.89	-31.11	74	55.13	40.08	15.04	67.36	100	0	P	H	
		15960	44.96	-29.04	74	54.89	37.3	18.08	65.31	100	0	P	H	
													H	
													H	
			10640	42.95	-31.05	74	55.19	40.08	15.04	67.36	100	0	P	V
			15960	57.05	-16.95	74	66.98	37.3	18.08	65.31	199	62	P	V
			15960	46.48	-7.52	54	56.41	37.3	18.08	65.31	199	62	A	V
													V	
Remark	1. No other spurious found. 2. All results are PASS against Peak and Average limit line.													



Band 2 5250~5350MHz
WIFI 802.11n HT40 (Band Edge @ 3m)

WIFI Ant. 1	Note	Frequency (MHz)	Level (dBμV/m)	Over Limit (dB)	Limit Line (dBμV/m)	Read Level (dBμV)	Antenna Factor (dB/m)	Cable Loss (dB)	Preamp Factor (dB)	Ant Pos (cm)	Table Pos (deg)	Peak Avg. (P/A)	Pol. (H/V)	
802.11n HT40 CH 54 5270MHz		5087	48.52	-25.48	74	40.28	31.5	10.21	33.47	233	70	P	H	
		5119.85	40.7	-13.3	54	32.41	31.54	10.22	33.47	233	70	A	H	
	*	5270	99.41	-	-	90.68	31.72	10.49	33.48	233	70	P	H	
	*	5270	90.97	-	-	82.24	31.72	10.49	33.48	233	70	A	H	
		5350.22	48.81	-25.19	74	39.72	31.82	10.75	33.48	233	70	P	H	
		5350.22	40.81	-13.19	54	31.72	31.82	10.75	33.48	233	70	A	H	
		5072.9	49.1	-24.9	74	40.86	31.5	10.21	33.47	100	113	P	V	
		5124.5	40	-14	54	31.69	31.56	10.22	33.47	100	113	A	V	
	*	5270	93.96	-	-	85.23	31.72	10.49	33.48	100	113	P	V	
	*	5270	85.95	-	-	77.22	31.72	10.49	33.48	100	113	A	V	
		5354.4	47.14	-26.86	74	38.05	31.82	10.75	33.48	100	113	P	V	
		5438.88	39.42	-14.58	54	30.14	31.92	10.84	33.48	100	113	A	V	
	802.11n HT40 CH 62 5310MHz		5086.85	48.48	-25.52	74	40.24	31.5	10.21	33.47	227	72	P	H
			5090.15	39.81	-14.19	54	31.55	31.52	10.21	33.47	227	72	A	H
*		5310	98.6	-	-	89.68	31.78	10.62	33.48	227	72	P	H	
*		5310	90.91	-	-	81.99	31.78	10.62	33.48	227	72	A	H	
		5351.21	56.71	-17.29	74	47.62	31.82	10.75	33.48	227	72	P	H	
		5350	50.31	-3.69	54	41.22	31.82	10.75	33.48	227	72	A	H	
		5035.4	47.82	-26.18	74	39.65	31.44	10.2	33.47	100	113	P	V	
		5128.85	39.77	-14.23	54	31.46	31.56	10.22	33.47	100	113	A	V	
*		5310	93.03	-	-	84.11	31.78	10.62	33.48	100	113	P	V	
*		5310	85.21	-	-	76.29	31.78	10.62	33.48	100	113	A	V	
	5350.22	52.59	-21.41	74	43.5	31.82	10.75	33.48	100	113	P	V		
	5350.11	45.46	-8.54	54	36.37	31.82	10.75	33.48	100	113	A	V		
Remark	1. No other spurious found. 2. All results are PASS against Peak and Average limit line.													



Band 2 5250~5350MHz
WIFI 802.11n HT40 (Harmonic @ 3m)

WIFI Ant. 1	Note	Frequency (MHz)	Level (dBμV/m)	Over Limit (dB)	Limit Line (dBμV/m)	Read Level (dBμV)	Antenna Factor (dB/m)	Cable Loss (dB)	Preamp Factor (dB)	Ant Pos (cm)	Table Pos (deg)	Peak Avg. (P/A)	Pol. (H/V)
802.11n HT40 CH 54 5270MHz		10540	43.15	-30.85	74	55.64	40.02	14.96	67.47	100	0	P	H
		15810	42.33	-31.67	74	51.89	37.77	18.01	65.34	100	0	P	H
													H
													H
		10540	42.54	-31.46	74	55.03	40.02	14.96	67.47	100	0	P	V
		15810	50.06	-23.94	74	59.62	37.77	18.01	65.34	100	0	P	V
													V
													V
802.11n HT40 CH 62 5310MHz		10620	41.4	-32.6	74	53.69	40.07	15.02	67.38	100	0	P	H
		15930	38.75	-35.25	74	48.59	37.41	18.06	65.31	100	0	P	H
													H
													H
		10620	40.81	-33.19	74	53.1	40.07	15.02	67.38	100	0	P	V
		15930	44.45	-29.55	74	54.29	37.41	18.06	65.31	100	0	P	V
													V
													V
Remark	1. No other spurious found. 2. All results are PASS against Peak and Average limit line.												



Band 3 - 5470~5725MHz
WIFI 802.11a (Band Edge @ 3m)

WIFI	Note	Frequency	Level	Over	Limit	Read	Antenna	Cable	Preamp	Ant	Table	Peak	Pol.	
Ant.				Limit	Line	Level	Factor	Loss	Factor	Pos	Pos	Avg.		
1		(MHz)	(dBμV/m)	(dB)	(dBμV/m)	(dBμV)	(dB/m)	(dB)	(dB)	(cm)	(deg)	(P/A)	(H/V)	
802.11a CH 100 5500MHz		5464.4	51.07	-22.93	74	41.78	31.96	10.81	33.48	226	66	P	H	
		5467.6	42.43	-11.57	54	33.14	31.96	10.81	33.48	226	66	A	H	
	*	5500	102.76	-	-	93.43	32	10.81	33.48	226	66	P	H	
	*	5500	95.5	-	-	86.17	32	10.81	33.48	226	66	A	H	
													H	
													H	
			5468.08	48.4	-25.6	74	39.11	31.96	10.81	33.48	100	95	P	V
			5467.92	40.57	-13.43	54	31.28	31.96	10.81	33.48	100	95	A	V
	*		5500	97.35	-	-	88.02	32	10.81	33.48	100	95	P	V
	*		5500	90.18	-	-	80.85	32	10.81	33.48	100	95	A	V
													V	
													V	
802.11a CH 116 5580MHz		5441.04	48.21	-25.79	74	38.93	31.92	10.84	33.48	257	2	P	H	
		5457.52	39.84	-14.16	54	30.54	31.94	10.84	33.48	257	2	A	H	
	*	5580	101.02	-	-	91.7	32.1	10.74	33.52	257	2	P	H	
	*	5580	93.89	-	-	84.57	32.1	10.74	33.52	257	2	A	H	
			5748.28	47.96	-26.04	74	38.56	32.34	10.63	33.57	257	2	P	H
			5733.4	40.02	-13.98	54	30.63	32.31	10.65	33.57	257	2	A	H
			5456.4	47.9	-26.1	74	38.6	31.94	10.84	33.48	100	268	P	V
			5467.12	39.38	-14.62	54	30.09	31.96	10.81	33.48	100	268	A	V
	*		5580	97.01	-	-	87.69	32.1	10.74	33.52	100	268	P	V
	*		5580	89.13	-	-	79.81	32.1	10.74	33.52	100	268	A	V
			5727.32	47.96	-26.04	74	38.57	32.31	10.65	33.57	100	268	P	V
			5739.32	39.6	-14.4	54	30.18	32.34	10.65	33.57	100	268	A	V



802.11a CH 140 5700MHz	*	5700	100.36	-	-	90.98	32.27	10.67	33.56	225	66	P	H
	*	5700	92.16	-	-	82.78	32.27	10.67	33.56	225	66	A	H
		5725.8	60.4	-13.6	74	51.01	32.31	10.65	33.57	225	66	P	H
		5725.08	43.85	-10.15	54	34.46	32.31	10.65	33.57	225	66	A	H
													H
													H
	*	5700	94.58	-	-	85.2	32.27	10.67	33.56	100	278	P	V
	*	5700	87.6	-	-	78.22	32.27	10.67	33.56	100	278	A	V
		5727.4	48.13	-25.87	74	38.74	32.31	10.65	33.57	100	278	P	V
		5726.44	40.67	-13.33	54	31.28	32.31	10.65	33.57	100	278	A	V
													V
													V
Remark	1. No other spurious found. 2. All results are PASS against Peak and Average limit line.												



Band 3 - 5470~5725MHz
WIFI 802.11a (Harmonic @ 3m)

WIFI Ant. 1	Note	Frequency (MHz)	Level (dBμV/m)	Over Limit (dB)	Limit Line (dBμV/m)	Read Level (dBμV)	Antenna Factor (dB/m)	Cable Loss (dB)	Preamp Factor (dB)	Ant Pos (cm)	Table Pos (deg)	Peak Avg. (P/A)	Pol. (H/V)
802.11a CH 100 5500MHz		11000	43.12	-30.88	74	54.55	40.3	15.27	67	100	0	P	H
		16500	45.44	-28.56	74	52.25	38.9	18.29	64	100	0	P	H
													H
													H
		11000	43.47	-30.53	74	54.9	40.3	15.27	67	100	0	P	V
		16500	55.3	-18.7	74	62.11	38.9	18.29	64	194	26	P	V
		16500	44.69	-9.31	54	51.5	38.9	18.29	64	194	26	A	V
													V
802.11a CH 116 5580MHz		11160	45	-29	74	56.02	40.17	15.38	66.57	100	0	P	H
		16740	45.27	-28.73	74	51.2	39.58	18.39	63.9	100	0	P	H
													H
													H
		11160	44.99	-29.01	74	56.01	40.17	15.38	66.57	100	0	P	V
		16740	46.71	-27.29	74	52.64	39.58	18.39	63.9	100	0	P	V
													V
													V
802.11a CH 140 5700MHz		11400	43.85	-30.15	74	54.3	39.98	15.53	65.96	100	0	P	H
		17100	50.55	-23.45	74	55.34	40.6	18.53	63.92	100	0	P	H
													H
													H
		11400	42.4	-31.6	74	52.85	39.98	15.53	65.96	100	0	P	V
		17100	57.31	-16.69	74	62.1	40.6	18.53	63.92	229	58	P	V
		17100	45.17	-8.83	54	49.96	40.6	18.53	63.92	229	58	A	V
													V
Remark	1. No other spurious found. 2. All results are PASS against Peak and Average limit line.												



**Band 3 - 5470~5725MHz
WIFI 802.11n HT20 (Band Edge @ 3m)**

WIFI Ant. 1	Note	Frequency (MHz)	Level (dBμV/m)	Over Limit (dB)	Limit Line (dBμV/m)	Read Level (dBμV)	Antenna Factor (dB/m)	Cable Loss (dB)	Preamp Factor (dB)	Ant Pos (cm)	Table Pos (deg)	Peak Avg. (P/A)	Pol. (H/V)	
802.11n HT20 CH 100 5500MHz		5420.4	48.95	-25.05	74	39.69	31.9	10.84	33.48	235	71	P	H	
		5468.24	41.23	-12.77	54	31.94	31.96	10.81	33.48	235	71	A	H	
	*	5500	100.88	-	-	91.55	32	10.81	33.48	235	71	P	H	
	*	5500	93.94	-	-	84.61	32	10.81	33.48	235	71	A	H	
													H	
													H	
			5465.36	48.13	-25.87	74	38.84	31.96	10.81	33.48	100	97	P	V
			5469.36	39.84	-14.16	54	30.55	31.96	10.81	33.48	100	97	A	V
		*	5500	95.06	-	-	85.73	32	10.81	33.48	100	97	P	V
		*	5500	87.31	-	-	77.98	32	10.81	33.48	100	97	A	V
													V	
													V	
802.11n HT20 CH 116 5580MHz		5421.84	48.35	-25.65	74	39.09	31.9	10.84	33.48	232	71	P	H	
		5427.12	39.56	-14.44	54	30.3	31.9	10.84	33.48	232	71	A	H	
		*	5580	98.74	-	-	89.42	32.1	10.74	33.52	232	71	P	H
		*	5580	91.89	-	-	82.57	32.1	10.74	33.52	232	71	A	H
			5753.8	47.69	-26.31	74	38.27	32.36	10.63	33.57	232	71	P	H
			5733.8	39.65	-14.35	54	30.26	32.31	10.65	33.57	232	71	A	H
			5459.44	47.22	-26.78	74	37.92	31.94	10.84	33.48	100	94	P	V
			5469.04	38.88	-15.12	54	29.59	31.96	10.81	33.48	100	94	A	V
		*	5580	92.62	-	-	83.3	32.1	10.74	33.52	100	94	P	V
		*	5580	85.75	-	-	76.43	32.1	10.74	33.52	100	94	A	V
		5730.6	47.41	-26.59	74	38.02	32.31	10.65	33.57	100	94	P	V	
		5758.2	39.29	-14.71	54	29.88	32.36	10.63	33.58	100	94	A	V	



802.11n HT20 CH 140 5700MHz	*	5700	98.41	-	-	89.03	32.27	10.67	33.56	231	63	P	H
	*	5700	91.33	-	-	81.95	32.27	10.67	33.56	231	63	A	H
		5725.08	53.33	-20.67	74	43.94	32.31	10.65	33.57	231	63	P	H
		5725	43.5	-10.5	54	34.11	32.31	10.65	33.57	231	63	A	H
													H
													H
	*	5700	91.06	-	-	81.68	32.27	10.67	33.56	100	99	P	V
	*	5700	84.25	-	-	74.87	32.27	10.67	33.56	100	99	A	V
		5725.72	48.32	-25.68	74	38.93	32.31	10.65	33.57	100	99	P	V
		5725.08	40.13	-13.87	54	30.74	32.31	10.65	33.57	100	99	A	V
													V
													V
Remark	1. No other spurious found. 2. All results are PASS against Peak and Average limit line.												



Band 3 - 5470~5725MHz
WIFI 802.11n HT20 (Harmonic @ 3m)

WIFI Ant. 1	Note	Frequency (MHz)	Level (dBμV/m)	Over Limit (dB)	Limit Line (dBμV/m)	Read Level (dBμV)	Antenna Factor (dB/m)	Cable Loss (dB)	Preamp Factor (dB)	Ant Pos (cm)	Table Pos (deg)	Peak Avg. (P/A)	Pol. (H/V)	
802.11n HT20 CH 100 5500MHz		11000	42.42	-31.58	74	53.85	40.3	15.27	67	100	0	P	H	
		16500	40.58	-33.42	74	47.39	38.9	18.29	64	100	0	P	H	
													H	
													H	
			11000	42.72	-31.28	74	54.15	40.3	15.27	67	100	0	P	V
			16500	47.79	-26.21	74	54.6	38.9	18.29	64	100	0	P	V
														V
802.11n HT20 CH 116 5580MHz		11160	42.62	-31.38	74	53.64	40.17	15.38	66.57	100	0	P	H	
		16740	41.56	-32.44	74	47.49	39.58	18.39	63.9	100	0	P	H	
													H	
													H	
			11160	42.13	-31.87	74	53.15	40.17	15.38	66.57	100	0	P	V
			16740	46.81	-27.19	74	52.74	39.58	18.39	63.9	100	0	P	V
														V
802.11n HT20 CH 140 5700MHz		11400	42.53	-31.47	74	52.98	39.98	15.53	65.96	100	0	P	H	
		17100	49.19	-24.81	74	53.98	40.6	18.53	63.92	100	0	P	H	
													H	
													H	
			11400	42.52	-31.48	74	52.97	39.98	15.53	65.96	100	0	P	V
			17100	56.99	-17.01	74	61.78	40.6	18.53	63.92	225	60	P	V
			17100	45.1	-8.9	54	49.89	40.6	18.53	63.92	225	60	A	V
													V	
Remark	1. No other spurious found. 2. All results are PASS against Peak and Average limit line.													



Band 3 - 5470~5725MHz
WIFI 802.11n HT40 (Band Edge @ 3m)

WIFI Ant. 1	Note	Frequency (MHz)	Level (dBμV/m)	Over Limit (dB)	Limit Line (dBμV/m)	Read Level (dBμV)	Antenna Factor (dB/m)	Cable Loss (dB)	Preamp Factor (dB)	Ant Pos (cm)	Table Pos (deg)	Peak Avg. (P/A)	Pol. (H/V)
802.11n HT40 CH 102 5510MHz		5469.36	56.36	-17.64	74	47.07	31.96	10.81	33.48	237	70	P	H
		5469.84	49.19	-4.81	54	39.9	31.96	10.81	33.48	237	70	A	H
	*	5510	96.81	-	-	87.53	32	10.77	33.49	237	70	P	H
	*	5510	89.04	-	-	79.76	32	10.77	33.49	237	70	A	H
		5746.76	47.55	-26.45	74	38.15	32.34	10.63	33.57	237	70	P	H
		5739.8	39.85	-14.15	54	30.43	32.34	10.65	33.57	237	70	A	H
		5467.44	51.53	-22.47	74	42.24	31.96	10.81	33.48	100	102	P	V
		5469.68	44.46	-9.54	54	35.17	31.96	10.81	33.48	100	102	A	V
	*	5510	90.92	-	-	81.64	32	10.77	33.49	100	102	P	V
	*	5510	81.88	-	-	72.6	32	10.77	33.49	100	102	A	V
		5732.76	48.36	-25.64	74	38.97	32.31	10.65	33.57	100	102	P	V
		5743.08	39.64	-14.36	54	30.24	32.34	10.63	33.57	100	102	A	V
802.11n HT40 CH 110 5550MHz		5459.6	47.59	-26.41	74	38.29	31.94	10.84	33.48	244	71	P	H
		5466.64	40.06	-13.94	54	30.77	31.96	10.81	33.48	244	71	A	H
	*	5550	96.77	-	-	87.46	32.07	10.74	33.5	244	71	P	H
	*	5550	88.25	-	-	78.94	32.07	10.74	33.5	244	71	A	H
		5739.96	48.44	-25.56	74	39.02	32.34	10.65	33.57	244	71	P	H
		5726.52	40.18	-13.82	54	30.79	32.31	10.65	33.57	244	71	A	H
		5382.8	47.96	-26.04	74	38.71	31.86	10.87	33.48	100	100	P	V
		5469.2	39.65	-14.35	54	30.36	31.96	10.81	33.48	100	100	A	V
	*	5550	89.37	-	-	80.06	32.07	10.74	33.5	100	100	P	V
	*	5550	81.03	-	-	71.72	32.07	10.74	33.5	100	100	A	V
	5734.44	47.13	-26.87	74	37.74	32.31	10.65	33.57	100	100	P	V	
	5758.44	39.6	-14.4	54	30.19	32.36	10.63	33.58	100	100	A	V	



802.11n HT40 CH 134 5670MHz		5470	47.13	-26.87	74	37.84	31.96	10.81	33.48	221	64	P	H
		5467.28	39.44	-14.56	54	30.15	31.96	10.81	33.48	221	64	A	H
	*	5670	95.16	-	-	85.8	32.24	10.67	33.55	221	64	P	H
	*	5670	86.95	-	-	77.59	32.24	10.67	33.55	221	64	A	H
		5725.16	55.88	-18.12	74	46.49	32.31	10.65	33.57	221	64	P	H
		5725.48	42.46	-11.54	54	33.07	32.31	10.65	33.57	221	64	A	H
		5469.84	46.76	-27.24	74	37.47	31.96	10.81	33.48	100	100	P	V
		5452.88	39.29	-14.71	54	29.99	31.94	10.84	33.48	100	100	A	V
	*	5670	88.42	-	-	79.06	32.24	10.67	33.55	100	100	P	V
	*	5670	80.82	-	-	71.46	32.24	10.67	33.55	100	100	A	V
		5743.72	47.86	-26.14	74	38.46	32.34	10.63	33.57	100	100	P	V
		5727.16	39.64	-14.36	54	30.25	32.31	10.65	33.57	100	100	A	V
Remark	1. No other spurious found. 2. All results are PASS against Peak and Average limit line.												



Band 3 - 5470~5725MHz
WIFI 802.11n HT40 (Harmonic @ 3m)

WIFI Ant. 1	Note	Frequency (MHz)	Level (dBμV/m)	Over Limit (dB)	Limit Line (dBμV/m)	Read Level (dBμV)	Antenna Factor (dB/m)	Cable Loss (dB)	Preamp Factor (dB)	Ant Pos (cm)	Table Pos (deg)	Peak Avg. (P/A)	Pol. (H/V)	
802.11n HT40 CH 102 5510MHz		11020	41.41	-32.59	74	52.81	40.29	15.27	66.96	100	0	P	H	
		16530	39.19	-34.81	74	45.87	39	18.31	63.99	100	0	P	H	
													H	
													H	
			11020	41.78	-32.22	74	53.18	40.29	15.27	66.96	100	0	P	V
			16530	41.8	-32.2	74	48.48	39	18.31	63.99	100	0	P	V
														V
802.11n HT40 CH 110 5550MHz		11100	42.78	-31.22	74	53.97	40.22	15.33	66.74	100	0	P	H	
		16650	39.95	-34.05	74	46.2	39.33	18.36	63.94	100	0	P	H	
													H	
													H	
			11100	41.29	-32.71	74	52.48	40.22	15.33	66.74	100	0	P	V
			16650	42.58	-31.42	74	48.83	39.33	18.36	63.94	100	0	P	V
														V
802.11n HT40 CH 134 5670MHz		11340	42.32	-31.68	74	52.94	40.03	15.48	66.13	100	0	P	H	
		17010	42.51	-31.49	74	47.48	40.35	18.5	63.82	100	0	P	H	
													H	
													H	
			11340	42.33	-31.67	74	52.95	40.03	15.48	66.13	100	0	P	V
			17010	45.18	-28.82	74	50.15	40.35	18.5	63.82	100	0	P	V
														V
Remark	1. No other spurious found.													
	2. All results are PASS against Peak and Average limit line.													



Emission below 1GHz

WIFI 802.11a (LF @ 3m)

WIFI	Note	Frequency	Level	Over	Limit	Read	Antenna	Cable	Preamp	Ant	Table	Peak	Pol.	
Ant.				Limit	Line	Level	Factor	Loss	Factor	Pos	Pos	Avg.		
1		(MHz)	(dBμV/m)	(dB)	(dBμV/m)	(dBμV)	(dB/m)	(dB)	(dB)	(cm)	(deg)	(P/A)	(H/V)	
802.11a LF		31.08	23.51	-16.49	40	29.23	25.18	0.93	31.83	-	-	P	H	
		111.54	25.64	-17.86	43.5	38.65	17.29	1.48	31.78	-	-	P	H	
		228.18	22.23	-23.77	46	35.26	16.76	1.98	31.77	-	-	P	H	
		715.1	29.06	-16.94	46	30.55	26.99	3.54	32.02	-	-	P	H	
		825	31.08	-14.92	46	30.5	28.61	3.77	31.8	100	283	P	H	
		965	32.88	-21.12	54	29.34	30.57	3.89	30.92	-	-	P	H	
														H
														H
														H
														H
														H
														H
			31.62	33.49	-6.51	40	39.73	24.66	0.93	31.83	283	145	P	V
			41.61	30.93	-9.07	40	42.63	19.18	0.93	31.81	-	-	P	V
			113.97	24.99	-18.51	43.5	37.86	17.43	1.48	31.78	-	-	P	V
			637.4	27.87	-18.13	46	30.48	26.07	3.36	32.04	-	-	P	V
			924.4	32.6	-13.4	46	30.09	29.89	3.86	31.24	-	-	P	V
			979.7	32.96	-21.04	54	29.33	30.54	3.89	30.8	-	-	P	V
													V	
													V	
													V	
													V	
													V	
													V	
Remark	1. No other spurious found. 2. All results are PASS against limit line.													



Emission below 1GHz
WIFI 802.11n HT20 (LF @ 3m)

WIFI	Note	Frequency	Level	Over	Limit	Read	Antenna	Cable	Preamp	Ant	Table	Peak	Pol.		
Ant.				Limit	Line	Level	Factor	Loss	Factor	Pos	Pos	Avg.			
1		(MHz)	(dBμV/m)	(dB)	(dBμV/m)	(dBμV)	(dB/m)	(dB)	(dB)	(cm)	(deg)	(P/A)	(H/V)		
802.11n HT20 LF		30.54	25.27	-14.73	40	30.99	25.18	0.93	31.83	-	-	P	H		
		102.09	25.08	-18.42	43.5	39.06	16.32	1.48	31.78	-	-	P	H		
		234.12	20.95	-25.05	46	33.52	17.22	1.98	31.77	-	-	P	H		
		422.5	24.38	-21.62	46	29.7	22.82	3.68	31.82	-	-	P	H		
		677.3	27.82	-18.18	46	29.94	26.47	3.45	32.04	-	-	P	H		
		952.4	33.45	-12.55	46	29.99	30.59	3.89	31.02	115	84	P	H		
													P	H	
														H	
														H	
														H	
														H	
														H	
			30	31.36	-8.64	40	36.56	25.7	0.93	31.83	287	95	P	V	
			40.8	30.46	-9.54	40	41.61	19.74	0.93	31.82	-	-	P	V	
			119.37	26.3	-17.2	43.5	38.95	17.65	1.48	31.78	-	-	P	V	
			773.2	30.1	-15.9	46	30.45	27.98	3.62	31.95	-	-	P	V	
			873.3	32.05	-13.95	46	30.73	29.04	3.84	31.56	-	-	P	V	
			987.4	32.7	-21.3	54	29	30.52	3.92	30.74	-	-	P	V	
														P	V
														V	
													V		
													V		
													V		
													V		
Remark	1. No other spurious found. 2. All results are PASS against limit line.														



Emission below 1GHz
WIFI 802.11n HT40 (LF @ 3m)

WIFI	Note	Frequency	Level	Over	Limit	Read	Antenna	Cable	Preamp	Ant	Table	Peak	Pol.		
Ant.				Limit	Line	Level	Factor	Loss	Factor	Pos	Pos	Avg.			
1		(MHz)	(dBμV/m)	(dB)	(dBμV/m)	(dBμV)	(dB/m)	(dB)	(dB)	(cm)	(deg)	(P/A)	(H/V)		
802.11n HT40 LF		30	24.07	-15.93	40	29.27	25.7	0.93	31.83	-	-	P	H		
		102.09	25.59	-17.91	43.5	39.57	16.32	1.48	31.78	-	-	P	H		
		137.46	23.29	-20.21	43.5	35.67	17.92	1.48	31.78	-	-	P	H		
		705.3	28.73	-17.27	46	30.42	26.8	3.54	32.03	-	-	P	H		
		875.4	31.12	-14.88	46	29.77	29.06	3.84	31.55	-	-	P	H		
		957.3	33.06	-12.94	46	29.57	30.58	3.89	30.98	286	193	P	H		
													P	H	
														H	
														H	
														H	
														H	
														H	
			30.27	31.86	-8.14	40	37.06	25.7	0.93	31.83	172	295	P	V	
			120.72	26.73	-16.77	43.5	39.3	17.73	1.48	31.78	-	-	P	V	
			154.47	23.43	-20.07	43.5	36.33	17.2	1.68	31.78	-	-	P	V	
			750.8	29.28	-16.72	46	29.93	27.71	3.62	31.98	-	-	P	V	
			836.9	31.2	-14.8	46	30.42	28.75	3.77	31.74	-	-	P	V	
			965	32.86	-21.14	54	29.32	30.57	3.89	30.92	-	-	P	V	
														P	V
														V	
													V		
													V		
													V		
													V		
Remark	1. No other spurious found. 2. All results are PASS against limit line.														



Note symbol

*	Fundamental Frequency which can be ignored. However, the level of any unwanted emissions shall not exceed the level of the fundamental frequency.
!	Test result is over limit line.
P/A	Peak or Average
H/V	Horizontal or Vertical



A calculation example for radiated spurious emission is shown as below:

WIFI	Note	Frequency	Level	Over	Limit	Read	Antenna	Cable	Preamp	Ant	Table	Peak	Pol.
Ant.				Limit	Line	Level	Factor	Loss	Factor	Pos	Pos	Avg.	
1		(MHz)	(dBμV/m)	(dB)	(dBμV/m)	(dBμV)	(dB/m)	(dB)	(dB)	(cm)	(deg)	(P/A)	(H/V)
802.11b		2390	55.45	-18.55	74	54.51	32.22	4.58	35.86	103	308	P	H
CH 01													
2412MHz		2390	43.54	-10.46	54	42.6	32.22	4.58	35.86	103	308	A	H

- Level(dBμV/m) =
Antenna Factor(dB/m) + Cable Loss(dB) + Read Level(dBμV) - Preamp Factor(dB)
- Over Limit(dB) = Level(dBμV/m) – Limit Line(dBμV/m)

For Peak Limit @ 2390MHz:

- Level(dBμV/m)
= Antenna Factor(dB/m) + Cable Loss(dB) + Read Level(dBμV) - Preamp Factor(dB)
= 32.22(dB/m) + 4.58(dB) + 54.51(dBμV) – 35.86 (dB)
= 55.45 (dBμV/m)
- Over Limit(dB)
= Level(dBμV/m) – Limit Line(dBμV/m)
= 55.45(dBμV/m) – 74(dBμV/m)
= -18.55(dB)

For Average Limit @ 2390MHz:

- Level(dBμV/m)
= Antenna Factor(dB/m) + Cable Loss(dB) + Read Level(dBμV) - Preamp Factor(dB)
= 32.22(dB/m) + 4.58(dB) + 42.6(dBμV) – 35.86 (dB)
= 43.54 (dBμV/m)
- Over Limit(dB)
= Level(dBμV/m) – Limit Line(dBμV/m)
= 43.54(dBμV/m) – 54(dBμV/m)
= -10.46(dB)

Both peak and average measured complies with the limit line, so test result is “PASS”.



Appendix C. Radiated Spurious Emission

Test Engineer :	J.C. Liang and Ken Wu	Temperature :	20~22°C
		Relative Humidity :	50~54%

Note symbol

-L	Low channel location
-R	High channel location



Band 1 - 5150~5250MHz
WIFI 802.11a (Band Edge @ 3m)

WIFI	Band 1 5150~5250MHz Band Edge @ 3m	
ANT	802.11a CH36 5180MHz	
1	Horizontal	Vertical
Peak	<p>Site : 03CH11-HY Condition : FCC CLASS-B 3m HORN 9120D-HF HORIZONTAL Detector : Peak</p>	<p>Site : 03CH11-HY Condition : FCC CLASS-B 3m HORN 9120D-HF VERTICAL Detector : Peak</p>
Avg.	<p>Site : 03CH11-HY Condition : FCC CLASS-B (AVG) 3m HORN 9120D-HF HORIZONTAL Detector : Peak</p>	<p>Site : 03CH11-HY Condition : FCC CLASS-B (AVG) 3m HORN 9120D-HF VERTICAL Detector : Peak</p>



WIFI	Band 1 5150~5250MHz Band Edge @ 3m	
ANT	802.11a CH44 5220MHz - L	
1	Horizontal	Vertical
Peak	<p>Site : 03CH11-HY Condition : FCC CLASS-B 3m HORN 9120D-HF HORIZONTAL Detector : Peak</p>	<p>Site : 03CH11-HY Condition : FCC CLASS-B 3m HORN 9120D-HF VERTICAL Detector : Peak</p>
Avg.	<p>Site : 03CH11-HY Condition : FCC CLASS-B (AVG) 3m HORN 9120D-HF HORIZONTAL Detector : Peak</p>	<p>Site : 03CH11-HY Condition : FCC CLASS-B (AVG) 3m HORN 9120D-HF VERTICAL Detector : Peak</p>



WIFI	Band 1 5150~5250MHz Band Edge @ 3m	
ANT	802.11a CH44 5220MHz - R	
1	Horizontal	Vertical
Peak	<p>Site : 03CH11-HY Condition : FCC CLASS-B 3m HORN 9120D-HF HORIZONTAL RBW:1000.000KHz VBW:3000.000KHz SWT:Auto Detector : Peak</p>	<p>Site : 03CH11-HY Condition : FCC CLASS-B 3m HORN 9120D-HF VERTICAL RBW:1000.000KHz VBW:3000.000KHz SWT:Auto Detector : Peak</p>
Avg.	<p>Site : 03CH11-HY Condition : FCC CLASS-B (AVG) 3m HORN 9120D-HF HORIZONTAL RBW:1000.000KHz VBW:1000KHz SWT:Auto Detector : Peak</p>	<p>Site : 03CH11-HY Condition : FCC CLASS-B (AVG) 3m HORN 9120D-HF VERTICAL RBW:1000.000KHz VBW:1000KHz SWT:Auto Detector : Peak</p>

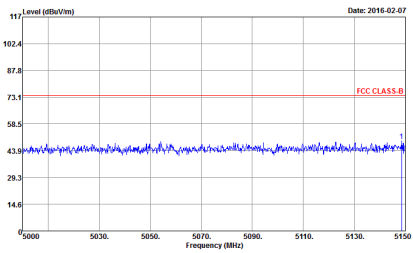
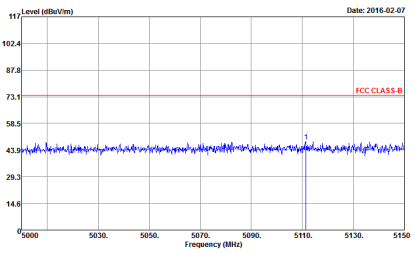
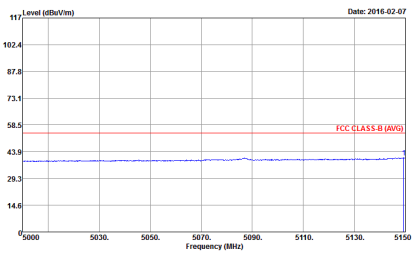
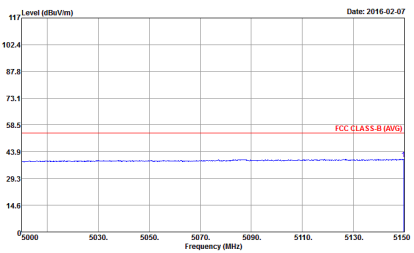

WIFI	Band 1 5150~5250MHz Band Edge @ 3m	
ANT	802.11a CH48 5240MHz - L	
1	Horizontal	Vertical
Peak	 <p>Site : 03CH11-HY Condition : FCC CLASS-B 3m HORN 9120D-HF HORIZONTAL RBW:1000.000KHz VBW:3000.000KHz SWT:Auto Detector : Peak</p>	 <p>Site : 03CH11-HY Condition : FCC CLASS-B 3m HORN 9120D-HF VERTICAL RBW:1000.000KHz VBW:3000.000KHz SWT:Auto Detector : Peak</p>
Avg.	 <p>Site : 03CH11-HY Condition : FCC CLASS-B (AVG) 3m HORN 9120D-HF HORIZONTAL RBW:1000.000KHz VBW:1000KHz SWT:Auto Detector : Peak</p>	 <p>Site : 03CH11-HY Condition : FCC CLASS-B (AVG) 3m HORN 9120D-HF VERTICAL RBW:1000.000KHz VBW:1000KHz SWT:Auto Detector : Peak</p>

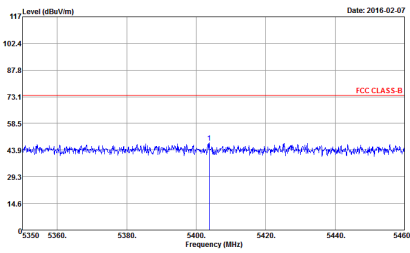
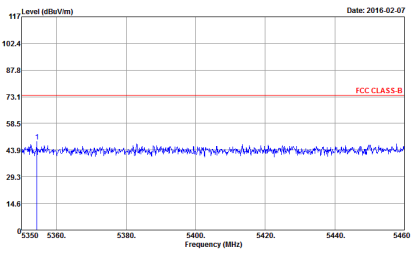
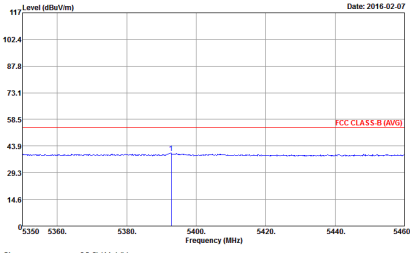
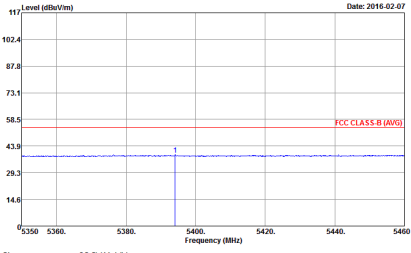

WIFI	Band 1 5150~5250MHz Band Edge @ 3m	
ANT	802.11a CH48 5240MHz - R	
1	Horizontal	Vertical
Peak	 <p>Site : 03CH11-HY Condition : FCC CLASS-B 3m HORN 9120D-HF HORIZONTAL Detector : Peak</p>	 <p>Site : 03CH11-HY Condition : FCC CLASS-B 3m HORN 9120D-HF VERTICAL Detector : Peak</p>
Avg.	 <p>Site : 03CH11-HY Condition : FCC CLASS-B (AVG) 3m HORN 9120D-HF HORIZONTAL Detector : Peak</p>	 <p>Site : 03CH11-HY Condition : FCC CLASS-B (AVG) 3m HORN 9120D-HF VERTICAL Detector : Peak</p>



**Band 1 5150~5250MHz
WIFI 802.11n HT20 (Band Edge @ 3m)**

WIFI	Band 1 5150~5250MHz Band Edge @ 3m	
ANT	802.11n HT20 CH36 5180MHz	
1	Horizontal	Vertical
Peak	<p>Site : 03CH11-HY Condition : FCC CLASS-B 3m HORN 9120D-HF HORIZONTAL Detector : Peak</p>	<p>Site : 03CH11-HY Condition : FCC CLASS-B 3m HORN 9120D-HF VERTICAL Detector : Peak</p>
Avg.	<p>Site : 03CH11-HY Condition : FCC CLASS-B (AVG) 3m HORN 9120D-HF HORIZONTAL Detector : Peak</p>	<p>Site : 03CH11-HY Condition : FCC CLASS-B (AVG) 3m HORN 9120D-HF VERTICAL Detector : Peak</p>

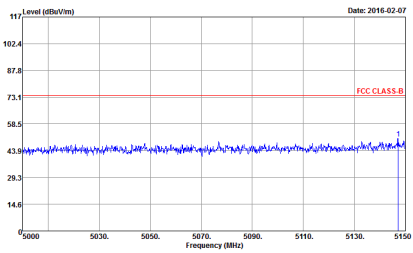
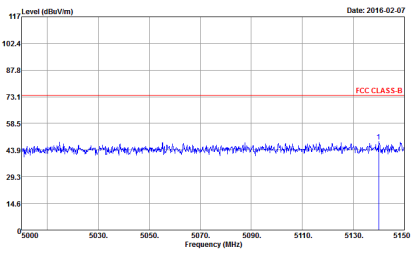
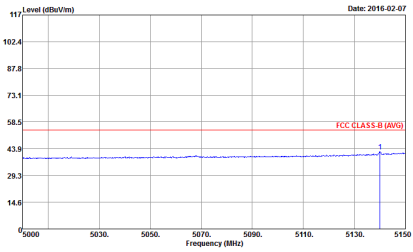
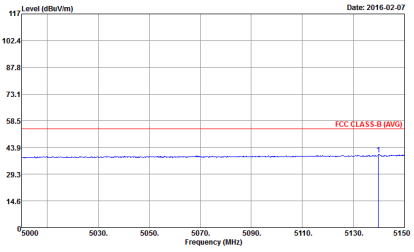

WIFI	Band 1 5150~5250MHz Band Edge @ 3m	
ANT	802.11n HT20 CH44 5220MHz - L	
1	Horizontal	Vertical
Peak	 <p>Site : 03CH11-HY Condition : FCC CLASS-B 3m HORN 9120D-HF HORIZONTAL RBW:1000.000KHz VBW:3000.000KHz SWT:Auto Detector : Peak</p>	 <p>Site : 03CH11-HY Condition : FCC CLASS-B 3m HORN 9120D-HF VERTICAL RBW:1000.000KHz VBW:3000.000KHz SWT:Auto Detector : Peak</p>
Avg.	 <p>Site : 03CH11-HY Condition : FCC CLASS-B (AVG) 3m HORN 9120D-HF HORIZONTAL RBW:1000.000KHz VBW:1000KHz SWT:Auto Detector : Peak</p>	 <p>Site : 03CH11-HY Condition : FCC CLASS-B (AVG) 3m HORN 9120D-HF VERTICAL RBW:1000.000KHz VBW:1000KHz SWT:Auto Detector : Peak</p>



WIFI	Band 1 5150~5250MHz Band Edge @ 3m	
ANT	802.11n HT20 CH44 5220MHz - R	
1	Horizontal	Vertical
Peak	<p>Site : 03CH11-HY Condition : FCC CLASS-B 3m HORN 9120D-HF HORIZONTAL Detector : Peak</p>	<p>Site : 03CH11-HY Condition : FCC CLASS-B 3m HORN 9120D-HF VERTICAL Detector : Peak</p>
Avg.	<p>Site : 03CH11-HY Condition : FCC CLASS-B (AVG) 3m HORN 9120D-HF HORIZONTAL Detector : Peak</p>	<p>Site : 03CH11-HY Condition : FCC CLASS-B (AVG) 3m HORN 9120D-HF VERTICAL Detector : Peak</p>

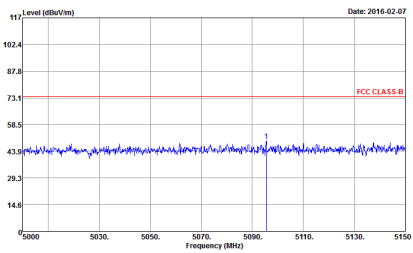
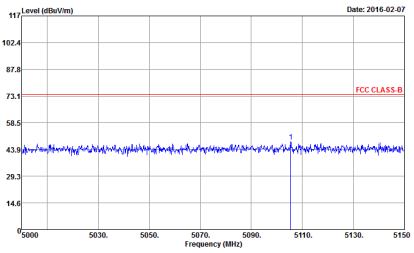
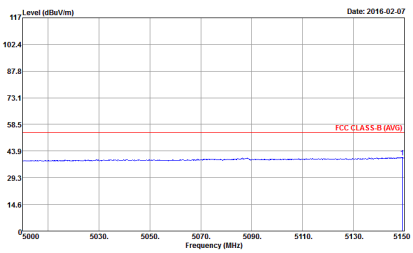
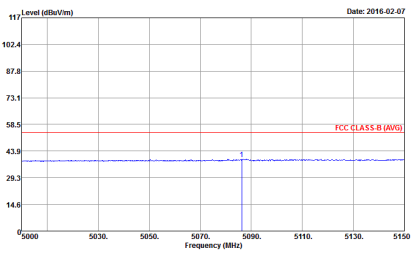

WIFI	Band 1 5150~5250MHz Band Edge @ 3m	
ANT	802.11n HT20 CH48 5240MHz - L	
1	Horizontal	Vertical
Peak	 <p>Site : 03CH11-HY Condition : FCC CLASS-B 3m HORN 9120D-HF HORIZONTAL RBW:1000.000KHz VBW:3000.000KHz SWT:Auto Detector : Peak</p>	 <p>Site : 03CH11-HY Condition : FCC CLASS-B 3m HORN 9120D-HF VERTICAL RBW:1000.000KHz VBW:3000.000KHz SWT:Auto Detector : Peak</p>
Avg.	 <p>Site : 03CH11-HY Condition : FCC CLASS-B (AVG) 3m HORN 9120D-HF HORIZONTAL RBW:1000.000KHz VBW:1000KHz SWT:Auto Detector : Peak</p>	 <p>Site : 03CH11-HY Condition : FCC CLASS-B (AVG) 3m HORN 9120D-HF VERTICAL RBW:1000.000KHz VBW:1000KHz SWT:Auto Detector : Peak</p>

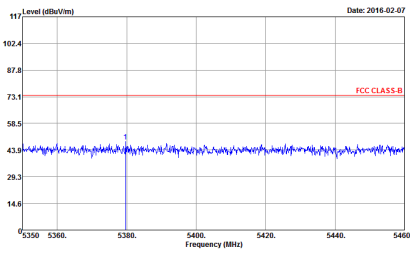
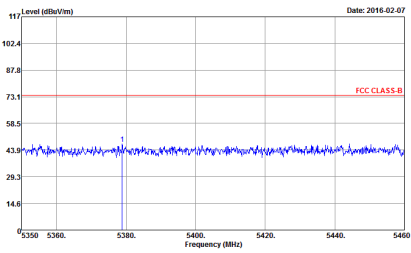
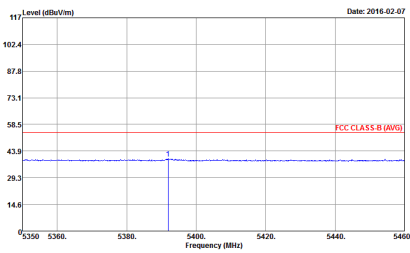
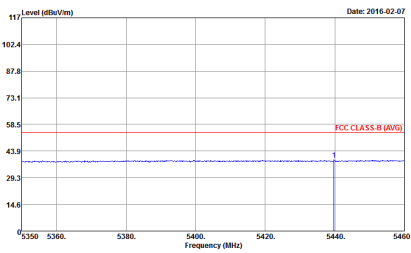

WIFI	Band 1 5150~5250MHz Band Edge @ 3m	
ANT	802.11n HT20 CH48 5240MHz - R	
1	Horizontal	Vertical
Peak	 <p>Date: 2016-02-07</p> <p>Site : 03CH11-HY Condition : FCC CLASS-B 3m HORN 9120D-HF HORIZONTAL RBW:1000.000KHz VBW:3000.000KHz SWT:Auto Detector : Peak</p>	 <p>Date: 2016-02-07</p> <p>Site : 03CH11-HY Condition : FCC CLASS-B 3m HORN 9120D-HF VERTICAL RBW:1000.000KHz VBW:3000.000KHz SWT:Auto Detector : Peak</p>
Avg.	 <p>Date: 2016-02-07</p> <p>Site : 03CH11-HY Condition : FCC CLASS-B (AVG) 3m HORN 9120D-HF HORIZONTAL RBW:1000.000KHz VBW:1000KHz SWT:Auto Detector : Peak</p>	 <p>Date: 2016-02-07</p> <p>Site : 03CH11-HY Condition : FCC CLASS-B (AVG) 3m HORN 9120D-HF VERTICAL RBW:1000.000KHz VBW:1000KHz SWT:Auto Detector : Peak</p>



**Band 1 5150~5250MHz
WIFI 802.11n HT40 (Band Edge @ 3m)**

WIFI	Band 1 5150~5250MHz Band Edge @ 3m	
ANT	802.11n HT40 CH38 5190MHz - L	
1	Horizontal	Vertical
Peak	<p>Site : 03CH11-HY Condition : FCC CLASS-B 3m HORN 9120D-HF HORIZONTAL RBW:1000.000KHz VBW:3000.000KHz SWT:Auto Detector : Peak</p>	<p>Site : 03CH11-HY Condition : FCC CLASS-B 3m HORN 9120D-HF VERTICAL RBW:1000.000KHz VBW:3000.000KHz SWT:Auto Detector : Peak</p>
Avg.	<p>Site : 03CH11-HY Condition : FCC CLASS-B (AVG) 3m HORN 9120D-HF HORIZONTAL RBW:1000.000KHz VBW:3000KHz SWT:Auto Detector : Peak</p>	<p>Site : 03CH11-HY Condition : FCC CLASS-B (AVG) 3m HORN 9120D-HF VERTICAL RBW:1000.000KHz VBW:3000KHz SWT:Auto Detector : Peak</p>

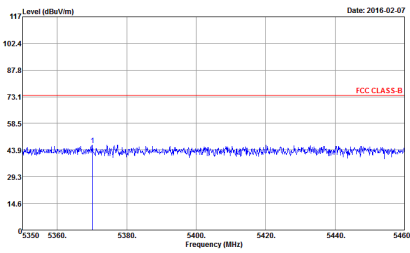
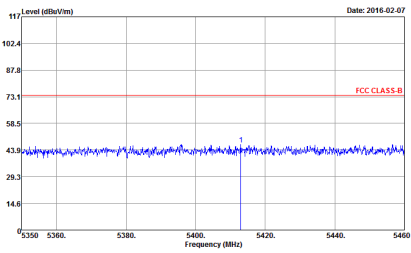
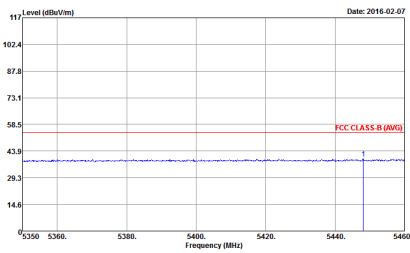
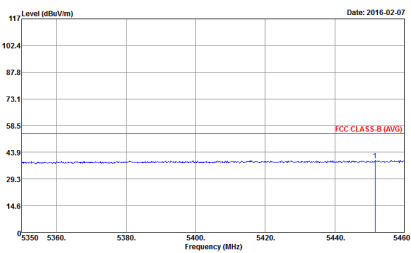

WIFI	Band 1 5150~5250MHz Band Edge @ 3m	
ANT	802.11n HT40 CH38 5190MHz - R	
1	Horizontal	Vertical
Peak	 <p>Date: 2016-02-07</p> <p>Site : 03CH11-HY Condition : FCC CLASS-B 3m HORN 9120D-HF HORIZONTAL RBW:1000.000KHz VBW:3000.000KHz SWT:Auto Detector : Peak</p>	 <p>Date: 2016-02-07</p> <p>Site : 03CH11-HY Condition : FCC CLASS-B 3m HORN 9120D-HF VERTICAL RBW:1000.000KHz VBW:3000.000KHz SWT:Auto Detector : Peak</p>
Avg.	 <p>Date: 2016-02-07</p> <p>Site : 03CH11-HY Condition : FCC CLASS-B (AVG) 3m HORN 9120D-HF HORIZONTAL RBW:1000.000KHz VBW:3.000KHz SWT:Auto Detector : Peak</p>	 <p>Date: 2016-02-07</p> <p>Site : 03CH11-HY Condition : FCC CLASS-B (AVG) 3m HORN 9120D-HF VERTICAL RBW:1000.000KHz VBW:3.000KHz SWT:Auto Detector : Peak</p>

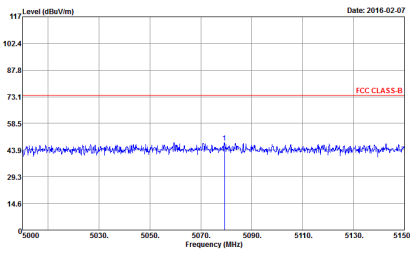
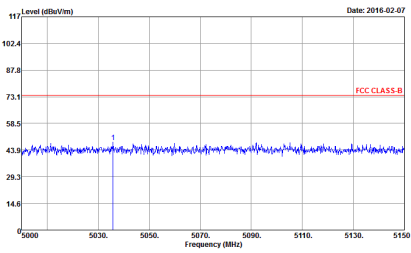
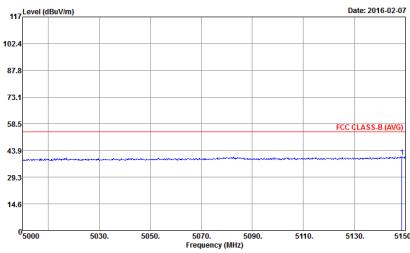
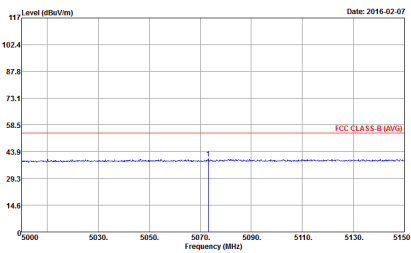

WIFI	Band 1 5150~5250MHz Band Edge @ 3m	
ANT	802.11n HT40 CH46 5230MHz - L	
1	Horizontal	Vertical
Peak	 <p>Date: 2016-02-07</p> <p>Site : 03CH11-HY Condition : FCC CLASS-B 3m HORN 9120D-HF HORIZONTAL Detector : Peak</p>	 <p>Date: 2016-02-07</p> <p>Site : 03CH11-HY Condition : FCC CLASS-B 3m HORN 9120D-HF VERTICAL Detector : Peak</p>
Avg.	 <p>Date: 2016-02-07</p> <p>Site : 03CH11-HY Condition : FCC CLASS-B (AVG) 3m HORN 9120D-HF HORIZONTAL Detector : Peak</p>	 <p>Date: 2016-02-07</p> <p>Site : 03CH11-HY Condition : FCC CLASS-B (AVG) 3m HORN 9120D-HF VERTICAL Detector : Peak</p>



WIFI	Band 1 5150~5250MHz Band Edge @ 3m	
ANT	802.11n HT40 CH46 5230MHz - R	
1	Horizontal	Vertical
Peak	<p>Site : 03CH11-HY Condition : FCC CLASS-B 3m HORN 9120D-HF HORIZONTAL RBW:1000.000KHz VBW:3000.000KHz SWT:Auto Detector : Peak</p>	<p>Site : 03CH11-HY Condition : FCC CLASS-B 3m HORN 9120D-HF VERTICAL RBW:1000.000KHz VBW:3000.000KHz SWT:Auto Detector : Peak</p>
Avg.	<p>Site : 03CH11-HY Condition : FCC CLASS-B (AVG) 3m HORN 9120D-HF HORIZONTAL RBW:1000.000KHz VBW:3.000KHz SWT:Auto Detector : Peak</p>	<p>Site : 03CH11-HY Condition : FCC CLASS-B (AVG) 3m HORN 9120D-HF VERTICAL RBW:1000.000KHz VBW:3.000KHz SWT:Auto Detector : Peak</p>

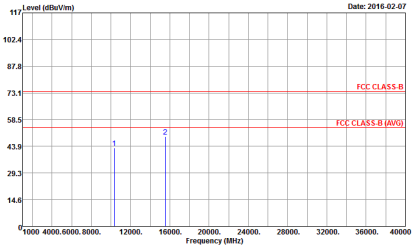
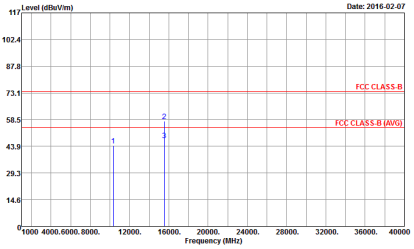

**Band 1 - 5150~5250MHz
WIFI 802.11a (Harmonic @ 3m)**

WIFI	Band 1 5150~5250MHz Harmonic @ 3m	
ANT	802.11a CH36 5180MHz	
1	Horizontal	Vertical
<p>Peak Avg.</p>	 <p>Site : 03CH11-HY Condition : FCC CLASS-B 3m 9170 SHF HORM_150809 HORIZONTAL Detector : Peak</p>	 <p>Site : 03CH11-HY Condition : FCC CLASS-B 3m 9170 SHF HORM_150809 VERTICAL Detector : Peak</p>



WIFI	Band 1 5150-5250MHz Harmonic @ 3m	
ANT	802.11a CH44 5220MHz	
1	Horizontal	Vertical
<p>Peak</p> <p>Avg.</p>	<p>Site : 03CH11-HY Condition : FCC CLASS-B 3m 9170 SHF HORM_150809 HORIZONTAL Detector : Peak</p>	<p>Site : 03CH11-HY Condition : FCC CLASS-B 3m 9170 SHF HORM_150809 VERTICAL Detector : Peak</p>



WIFI	Band 1 5150-5250MHz Harmonic @ 3m	
ANT	802.11a CH48 5240MHz	
1	Horizontal	Vertical
<p>Peak</p> <p>Avg.</p>	<p>Site : 03CH11-HY Condition : FCC CLASS-B 3m 9170 SHF HORM_150809 HORIZONTAL Detector : Peak</p>	<p>Site : 03CH11-HY Condition : FCC CLASS-B 3m 9170 SHF HORM_150809 VERTICAL Detector : Peak</p>



**Band 1 5150~5250MHz
WIFI 802.11n HT20 (Harmonic @ 3m)**

WIFI	Band 1 5150~5250MHz Harmonic @ 3m	
ANT	802.11n HT20 CH36 5180MHz	
1	Horizontal	Vertical
<p>Peak Avg.</p>	<p>Site : 03CHI1-HY Condition : FCC CLASS-B 3m 9170 SHF HORM_150809 HORIZONTAL Detector : Peak</p>	<p>Site : 03CHI1-HY Condition : FCC CLASS-B 3m 9170 SHF HORM_150809 VERTICAL Detector : Peak</p>



WIFI	Band 1 5150-5250MHz Harmonic @ 3m	
ANT	802.11n HT20 CH44 5220MHz	
1	Horizontal	Vertical
<p>Peak</p> <p>Avg.</p>	<p>Site : 03CH11-HY Condition : FCC CLASS-B 3m 9170 SHF HORM_150809 HORIZONTAL Detector : Peak</p>	<p>Site : 03CH11-HY Condition : FCC CLASS-B 3m 9170 SHF HORM_150809 VERTICAL Detector : Peak</p>



WIFI	Band 1 5150-5250MHz Harmonic @ 3m	
ANT	802.11n HT20 CH48 5240MHz	
1	Horizontal	Vertical
<p>Peak</p> <p>Avg.</p>	<p>Site : 03CH11-HY Condition : FCC CLASS-B 3m 9170 SHF HORM_150809 HORIZONTAL Detector : Peak</p>	<p>Site : 03CH11-HY Condition : FCC CLASS-B 3m 9170 SHF HORM_150809 VERTICAL Detector : Peak</p>



**Band 1 5150~5250MHz
WIFI 802.11n HT40 (Harmonic @ 3m)**

WIFI	Band 1 5150~5250MHz Harmonic @ 3m	
ANT	802.11n HT40 CH38 5190MHz	
1	Horizontal	Vertical
Peak Avg.	<p>Site : 03CH11-HY Condition : FCC CLASS-B 3m 9170 SHF HORM_150809 HORIZONTAL Detector : Peak</p>	<p>Site : 03CH11-HY Condition : FCC CLASS-B 3m 9170 SHF HORM_150809 VERTICAL Detector : Peak</p>



WIFI	Band 1 5150-5250MHz Harmonic @ 3m	
ANT	802.11n HT40 CH46 5230MHz	
1	Horizontal	Vertical
Peak Avg.	<p>Site : 03CH11-HY Condition : FCC CLASS-B 3m 9170 SHF HORM_150809 HORIZONTAL Detector : Peak</p>	<p>Site : 03CH11-HY Condition : FCC CLASS-B 3m 9170 SHF HORM_150809 VERTICAL Detector : Peak</p>



Band 2 - 5250~5350MHz
WIFI 802.11a (Band Edge @ 3m)

WIFI	Band 2 5250~5350MHz Band Edge @ 3m	
ANT	802.11a CH52 5260MHz - L	
1	Horizontal	Vertical
Peak	<p>Site : 03CH11-HY Condition : FCC CLASS-B 3m HORN 9120D-HF HORIZONTAL Detector : Peak</p>	<p>Site : 03CH11-HY Condition : FCC CLASS-B 3m HORN 9120D-HF VERTICAL Detector : Peak</p>
Avg.	<p>Site : 03CH11-HY Condition : FCC CLASS-B (AVG) 3m HORN 9120D-HF HORIZONTAL Detector : Peak</p>	<p>Site : 03CH11-HY Condition : FCC CLASS-B (AVG) 3m HORN 9120D-HF VERTICAL Detector : Peak</p>

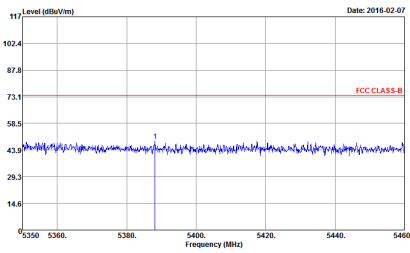
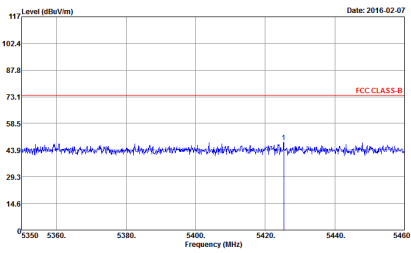
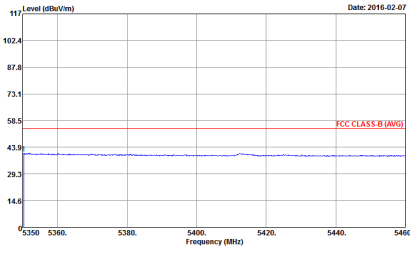
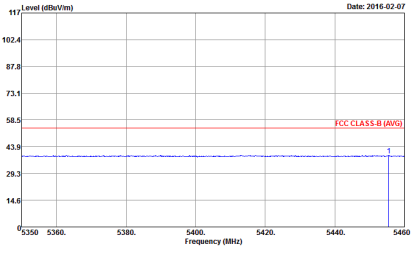

WIFI	Band 2 5250~5350MHz Band Edge @ 3m	
ANT	802.11a CH52 5260MHz - R	
1	Horizontal	Vertical
Peak	 <p>Date: 2016-02-07</p> <p>Site : 03CH11-HY Condition : FCC CLASS-B 3m HORN 9120D-HF HORIZONTAL RBW:1000.000KHz VBW:3000.000KHz SWT:Auto Detector : Peak</p>	 <p>Date: 2016-02-07</p> <p>Site : 03CH11-HY Condition : FCC CLASS-B 3m HORN 9120D-HF VERTICAL RBW:1000.000KHz VBW:3000.000KHz SWT:Auto Detector : Peak</p>
Avg.	 <p>Date: 2016-02-07</p> <p>Site : 03CH11-HY Condition : FCC CLASS-B (AVG) 3m HORN 9120D-HF HORIZONTAL RBW:1000.000KHz VBW:1000KHz SWT:Auto Detector : Peak</p>	 <p>Date: 2016-02-07</p> <p>Site : 03CH11-HY Condition : FCC CLASS-B (AVG) 3m HORN 9120D-HF VERTICAL RBW:1000.000KHz VBW:1000KHz SWT:Auto Detector : Peak</p>



WIFI	Band 2 5250~5350MHz Band Edge @ 3m	
ANT	802.11a CH60 5300MHz - L	
1	Horizontal	Vertical
Peak	<p>Site : 03CH11-HY Condition : FCC CLASS-B 3m HORN 9120D-HF HORIZONTAL Detector : Peak</p>	<p>Site : 03CH11-HY Condition : FCC CLASS-B 3m HORN 9120D-HF VERTICAL Detector : Peak</p>
Avg.	<p>Site : 03CH11-HY Condition : FCC CLASS-B (AVG) 3m HORN 9120D-HF HORIZONTAL Detector : Peak</p>	<p>Site : 03CH11-HY Condition : FCC CLASS-B (AVG) 3m HORN 9120D-HF VERTICAL Detector : Peak</p>



WIFI	Band 2 5250~5350MHz Band Edge @ 3m	
ANT	802.11a CH60 5300MHz - R	
1	Horizontal	Vertical
Peak	<p>Site : 03CH11-HY Condition : FCC CLASS-B 3m HORN 9120D-HF HORIZONTAL RBW:1000.000KHz VBW:3000.000KHz SWT:Auto Detector : Peak</p>	<p>Site : 03CH11-HY Condition : FCC CLASS-B 3m HORN 9120D-HF VERTICAL RBW:1000.000KHz VBW:3000.000KHz SWT:Auto Detector : Peak</p>
Avg.	<p>Site : 03CH11-HY Condition : FCC CLASS-B (AVG) 3m HORN 9120D-HF HORIZONTAL RBW:1000.000KHz VBW:1000KHz SWT:Auto Detector : Peak</p>	<p>Site : 03CH11-HY Condition : FCC CLASS-B (AVG) 3m HORN 9120D-HF VERTICAL RBW:1000.000KHz VBW:1000KHz SWT:Auto Detector : Peak</p>



WIFI	Band 2 5250~5350MHz Band Edge @ 3m	
ANT	802.11a CH64 5320MHz	
1	Horizontal	Vertical
Peak	<p>Site : 03CH11-HY Condition : FCC CLASS-B 3m HORN 9120D-HF HORIZONTAL Detector : Peak</p>	<p>Site : 03CH11-HY Condition : FCC CLASS-B 3m HORN 9120D-HF VERTICAL Detector : Peak</p>
Avg.	<p>Site : 03CH11-HY Condition : FCC CLASS-B (AVG) 3m HORN 9120D-HF HORIZONTAL Detector : Peak</p>	<p>Site : 03CH11-HY Condition : FCC CLASS-B (AVG) 3m HORN 9120D-HF VERTICAL Detector : Peak</p>



**Band 2 5250~5350MHz
WIFI 802.11n HT20 (Band Edge @ 3m)**

WIFI	Band 2 5250~5350MHz Band Edge @ 3m	
ANT	802.11n HT20 CH52 5260MHz - L	
1	Horizontal	Vertical
Peak	<p>Site : 03CH11-HY Condition : FCC CLASS-B 3m HORN 9120D-HF HORIZONTAL Detector : Peak</p>	<p>Site : 03CH11-HY Condition : FCC CLASS-B 3m HORN 9120D-HF VERTICAL Detector : Peak</p>
Avg.	<p>Site : 03CH11-HY Condition : FCC CLASS-B (AVG) 3m HORN 9120D-HF HORIZONTAL Detector : Peak</p>	<p>Site : 03CH11-HY Condition : FCC CLASS-B (AVG) 3m HORN 9120D-HF VERTICAL Detector : Peak</p>

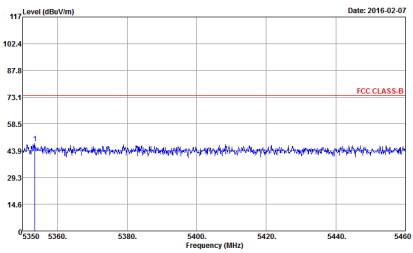
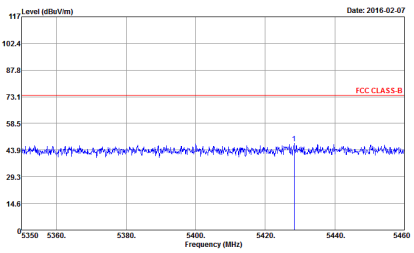
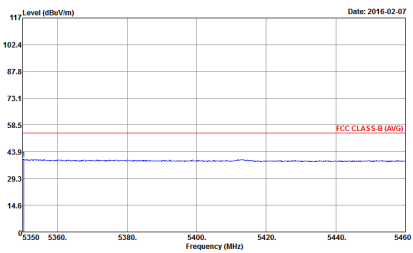
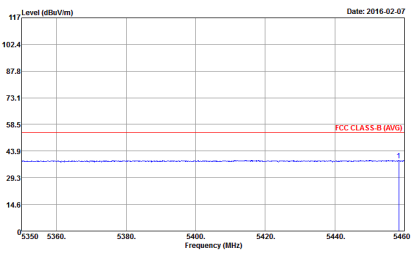

WIFI	Band 2 5250~5350MHz Band Edge @ 3m	
ANT	802.11n HT20 CH52 5260MHz - R	
1	Horizontal	Vertical
Peak	 <p>Date: 2016-02-07</p> <p>Site : 03CH11-HY Condition : FCC CLASS-B 3m HORN 9120D-HF HORIZONTAL RBW:1000.000KHz VBW:3000.000KHz SWT:Auto Detector : Peak</p>	 <p>Date: 2016-02-07</p> <p>Site : 03CH11-HY Condition : FCC CLASS-B 3m HORN 9120D-HF VERTICAL RBW:1000.000KHz VBW:3000.000KHz SWT:Auto Detector : Peak</p>
Avg.	 <p>Date: 2016-02-07</p> <p>Site : 03CH11-HY Condition : FCC CLASS-B (AVG) 3m HORN 9120D-HF HORIZONTAL RBW:1000.000KHz VBW:1000KHz SWT:Auto Detector : Peak</p>	 <p>Date: 2016-02-07</p> <p>Site : 03CH11-HY Condition : FCC CLASS-B (AVG) 3m HORN 9120D-HF VERTICAL RBW:1000.000KHz VBW:1000KHz SWT:Auto Detector : Peak</p>

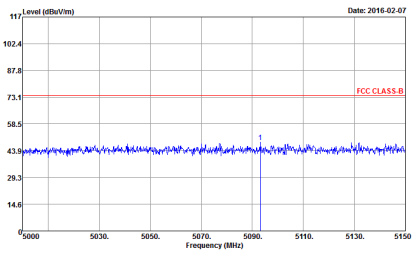
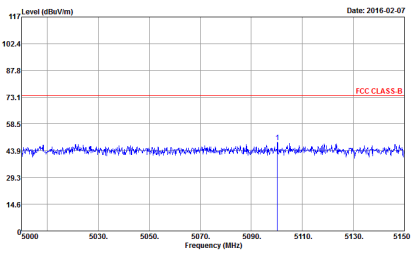
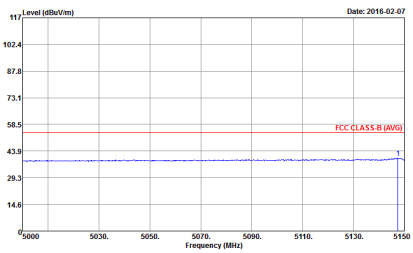
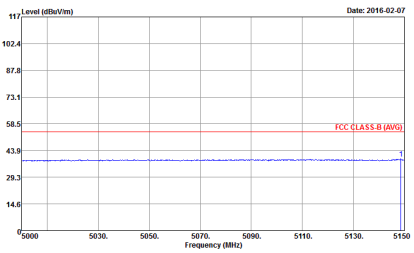

WIFI	Band 2 5250~5350MHz Band Edge @ 3m	
ANT	802.11n HT20 CH60 5300MHz - L	
1	Horizontal	Vertical
Peak	 <p>Date: 2016-02-07</p> <p>Site : 03CH11-HY Condition : FCC CLASS-B 3m HORN 9120D-HF HORIZONTAL RBW:1000.000KHz VBW:3000.000KHz SWT:Auto Detector : Peak</p>	 <p>Date: 2016-02-07</p> <p>Site : 03CH11-HY Condition : FCC CLASS-B 3m HORN 9120D-HF VERTICAL RBW:1000.000KHz VBW:3000.000KHz SWT:Auto Detector : Peak</p>
Avg.	 <p>Date: 2016-02-07</p> <p>Site : 03CH11-HY Condition : FCC CLASS-B (AVG) 3m HORN 9120D-HF HORIZONTAL RBW:1000.000KHz VBW:1000KHz SWT:Auto Detector : Peak</p>	 <p>Date: 2016-02-07</p> <p>Site : 03CH11-HY Condition : FCC CLASS-B (AVG) 3m HORN 9120D-HF VERTICAL RBW:1000.000KHz VBW:1000KHz SWT:Auto Detector : Peak</p>



WIFI	Band 2 5250~5350MHz Band Edge @ 3m	
ANT	802.11n HT20 CH60 5300MHz - R	
1	Horizontal	Vertical
Peak	<p>Site : 03CH11-HY Condition : FCC CLASS-B 3m HORN 9120D-HF HORIZONTAL RBW:1000.000KHz VBW:3000.000KHz SWT:Auto Detector : Peak</p>	<p>Site : 03CH11-HY Condition : FCC CLASS-B 3m HORN 9120D-HF VERTICAL RBW:1000.000KHz VBW:3000.000KHz SWT:Auto Detector : Peak</p>
Avg.	<p>Site : 03CH11-HY Condition : FCC CLASS-B (AVG) 3m HORN 9120D-HF HORIZONTAL RBW:1000.000KHz VBW:1000KHz SWT:Auto Detector : Peak</p>	<p>Site : 03CH11-HY Condition : FCC CLASS-B (AVG) 3m HORN 9120D-HF VERTICAL RBW:1000.000KHz VBW:1000KHz SWT:Auto Detector : Peak</p>



WIFI	Band 2 5250~5350MHz Band Edge @ 3m	
ANT	802.11n HT20 CH64 5320MHz	
1	Horizontal	Vertical
Peak	<p>Site : 03CH11-HY Condition : FCC CLASS-B 3m HORN 9120D-HF HORIZONTAL Detector : Peak</p>	<p>Site : 03CH11-HY Condition : FCC CLASS-B 3m HORN 9120D-HF VERTICAL Detector : Peak</p>
Avg.	<p>Site : 03CH11-HY Condition : FCC CLASS-B (AVG) 3m HORN 9120D-HF HORIZONTAL Detector : Peak</p>	<p>Site : 03CH11-HY Condition : FCC CLASS-B (AVG) 3m HORN 9120D-HF VERTICAL Detector : Peak</p>



**Band 2 5250~5350MHz
WIFI 802.11n HT40 (Band Edge @ 3m)**

WIFI	Band 2 5250~5350MHz Band Edge @ 3m	
ANT	802.11n HT40 CH54 5270 - L	
1	Horizontal	Vertical
Peak	<p>Site : 03CH11-HY Condition : FCC CLASS-B 3m HORN 9120D-HF HORIZONTAL Detector : Peak</p>	<p>Site : 03CH11-HY Condition : FCC CLASS-B 3m HORN 9120D-HF VERTICAL Detector : Peak</p>
Avg.	<p>Site : 03CH11-HY Condition : FCC CLASS-B (AVG) 3m HORN 9120D-HF HORIZONTAL Detector : Peak</p>	<p>Site : 03CH11-HY Condition : FCC CLASS-B (AVG) 3m HORN 9120D-HF VERTICAL Detector : Peak</p>

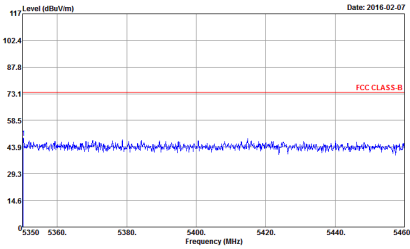
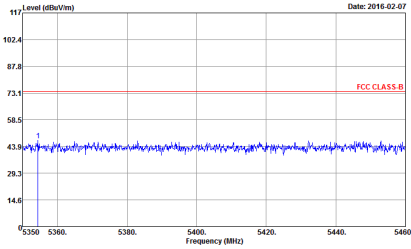
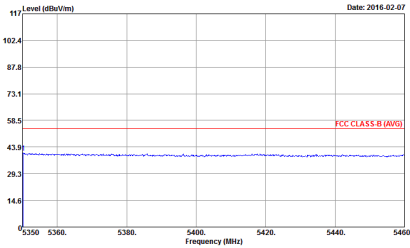
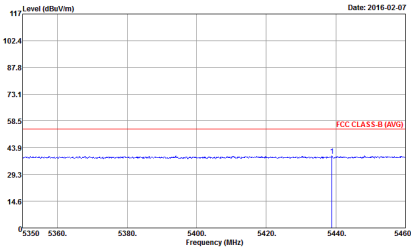

WIFI	Band 2 5250~5350MHz Band Edge @ 3m	
ANT	802.11n HT40 CH54 5270 - R	
1	Horizontal	Vertical
Peak	 <p>Date: 2016-02-07</p> <p>Site : 03CH11-HY Condition : FCC CLASS-B 3m HORN 9120D-HF HORIZONTAL Detector : Peak</p>	 <p>Date: 2016-02-07</p> <p>Site : 03CH11-HY Condition : FCC CLASS-B 3m HORN 9120D-HF VERTICAL Detector : Peak</p>
Avg.	 <p>Date: 2016-02-07</p> <p>Site : 03CH11-HY Condition : FCC CLASS-B (AVG) 3m HORN 9120D-HF HORIZONTAL Detector : Peak</p>	 <p>Date: 2016-02-07</p> <p>Site : 03CH11-HY Condition : FCC CLASS-B (AVG) 3m HORN 9120D-HF VERTICAL Detector : Peak</p>

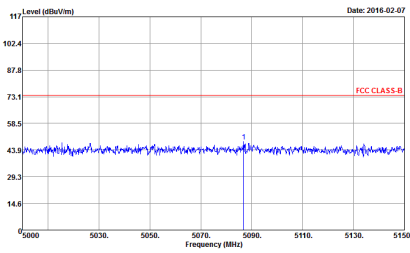
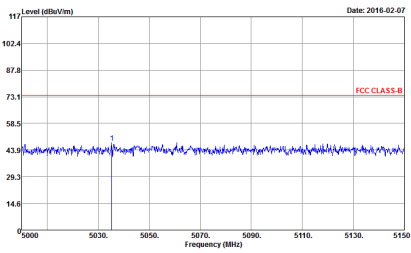
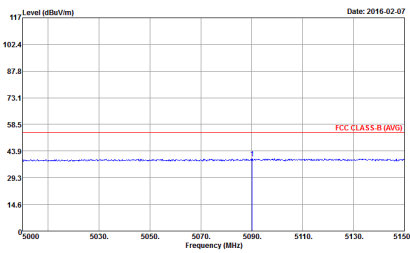
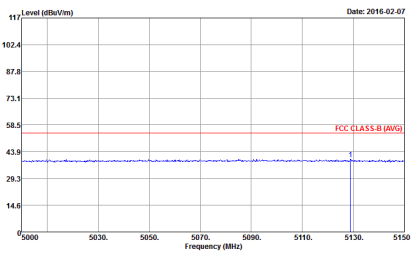

WIFI	Band 2 5250~5350MHz Band Edge @ 3m	
ANT	802.11n HT40 CH62 5310 - L	
1	Horizontal	Vertical
Peak	 <p>Date: 2016-02-07</p> <p>Site : 03CH11-HY Condition : FCC CLASS-B 3m HORN 9120D-HF HORIZONTAL RBW:1000.000KHz VBW:3000.000KHz SWT:Auto Detector : Peak</p>	 <p>Date: 2016-02-07</p> <p>Site : 03CH11-HY Condition : FCC CLASS-B 3m HORN 9120D-HF VERTICAL RBW:1000.000KHz VBW:3000.000KHz SWT:Auto Detector : Peak</p>
Avg.	 <p>Date: 2016-02-07</p> <p>Site : 03CH11-HY Condition : FCC CLASS-B (AVG) 3m HORN 9120D-HF HORIZONTAL RBW:1000.000KHz VBW:3.000KHz SWT:Auto Detector : Peak</p>	 <p>Date: 2016-02-07</p> <p>Site : 03CH11-HY Condition : FCC CLASS-B (AVG) 3m HORN 9120D-HF VERTICAL RBW:1000.000KHz VBW:3.000KHz SWT:Auto Detector : Peak</p>



WIFI	Band 2 5250~5350MHz Band Edge @ 3m	
ANT	802.11n HT40 CH62 5310 - R	
1	Horizontal	Vertical
Peak	<p>Date: 2016-02-07</p> <p>Site : 03CH11-HY Condition : FCC CLASS-B 3m HORN 9120D-HF HORIZONTAL RBW:1000.000KHz VBW:3000.000KHz SWT:Auto Detector : Peak</p>	<p>Date: 2016-02-07</p> <p>Site : 03CH11-HY Condition : FCC CLASS-B 3m HORN 9120D-HF VERTICAL RBW:1000.000KHz VBW:3000.000KHz SWT:Auto Detector : Peak</p>
Avg.	<p>Date: 2016-02-07</p> <p>Site : 03CH11-HY Condition : FCC CLASS-B (AVG) 3m HORN 9120D-HF HORIZONTAL RBW:1000.000KHz VBW:3.000KHz SWT:Auto Detector : Peak</p>	<p>Date: 2016-02-07</p> <p>Site : 03CH11-HY Condition : FCC CLASS-B (AVG) 3m HORN 9120D-HF VERTICAL RBW:1000.000KHz VBW:3.000KHz SWT:Auto Detector : Peak</p>



Band 2 - 5250~5350MHz
WIFI 802.11a (Harmonic @ 3m)

WIFI	Band 2 5250~5350MHz Harmonic @ 3m	
ANT	802.11a CH52 5260MHz	
1	Horizontal	Vertical
Peak Avg.	<p>Site : 03CH11-HY Condition : FCC CLASS-B 3m 9170 SHF HORM_150809 HORIZONTAL Detector : Peak</p>	<p>Site : 03CH11-HY Condition : FCC CLASS-B 3m 9170 SHF HORM_150809 VERTICAL Detector : Peak</p>



WIFI	Band 2 5250-5350MHz Harmonic @ 3m	
ANT	802.11a CH60 5300MHz	
1	Horizontal	Vertical
<p>Peak</p> <p>Avg.</p>	<p>Site : 03CH11-HY Condition : FCC CLASS-B 3m 9170 SHF HORM_150809 HORIZONTAL Detector : Peak</p>	<p>Site : 03CH11-HY Condition : FCC CLASS-B 3m 9170 SHF HORM_150809 VERTICAL Detector : Peak</p>



WIFI	Band 2 5250-5350MHz Harmonic @ 3m	
ANT	802.11a CH64 5320MHz	
1	Horizontal	Vertical
<p>Peak</p> <p>Avg.</p>	<p>Site : 03CH11-HY Condition : FCC CLASS-B 3m 9170 SHF HORM_150809 HORIZONTAL Detector : Peak</p>	<p>Site : 03CH11-HY Condition : FCC CLASS-B 3m 9170 SHF HORM_150809 VERTICAL Detector : Peak</p>



Band 2 5250~5350MHz
WIFI 802.11n HT20 (Harmonic @ 3m)

Table with 2 columns: Horizontal and Vertical. It contains two graphs showing Level (dBuV/m) vs Frequency (MHz) for Peak and Avg. measurements. The graphs include FCC CLASS-B and FCC CLASS-B (AVG) limits. Site information: 03CH11-HY, FCC CLASS-B 3m 9170 SHF HORM_150809 HORIZONTAL/VERTICAL.



WIFI	Band 2 5250-5350MHz Harmonic @ 3m	
ANT	802.11n HT20 CH60 5300MHz	
1	Horizontal	Vertical
<p>Peak</p> <p>Avg.</p>	<p>Site : 03CH11-HY Condition : FCC CLASS-B 3m 9170 SHF HORM_150809 HORIZONTAL Detector : Peak</p>	<p>Site : 03CH11-HY Condition : FCC CLASS-B 3m 9170 SHF HORM_150809 VERTICAL Detector : Peak</p>



WIFI	Band 2 5250-5350MHz Harmonic @ 3m	
ANT	802.11n HT20 CH64 5320MHz	
1	Horizontal	Vertical
Peak Avg.	<p>Site : 03CH11-HY Condition : FCC CLASS-B 3m 9170 SHF HORM_150809 HORIZONTAL Detector : Peak</p>	<p>Site : 03CH11-HY Condition : FCC CLASS-B 3m 9170 SHF HORM_150809 VERTICAL Detector : Peak</p>



**Band 2 5250~5350MHz
WIFI 802.11n HT40 (Harmonic @ 3m)**

WIFI	Band 2 5250~5350MHz Harmonic @ 3m	
ANT	802.11n HT40 CH54 5270	
1	Horizontal	Vertical
<p>Peak Avg.</p>	<p>Site : 03CH11-HY Condition : FCC CLASS-B 3m 9170 SHF HORM_150809 HORIZONTAL Detector : Peak</p>	<p>Site : 03CH11-HY Condition : FCC CLASS-B 3m 9170 SHF HORM_150809 VERTICAL Detector : Peak</p>



WIFI	Band 2 5250-5350MHz Harmonic @ 3m	
ANT	802.11n HT40 CH62 5310	
1	Horizontal	Vertical
Peak Avg.	<p>Site : 03CH11-HY Condition : FCC CLASS-B 3m 9170 SHF HORM_150809 HORIZONTAL Detector : Peak</p>	<p>Site : 03CH11-HY Condition : FCC CLASS-B 3m 9170 SHF HORM_150809 VERTICAL Detector : Peak</p>



Band 3 - 5470~5725MHz
WIFI 802.11a (Band Edge @ 3m)

WIFI	Band 3 5470~5725MHz Band Edge @ 3m	
ANT	802.11a CH100 5500MHz	
1	Horizontal	Vertical
Peak	<p>Site : 03CH11-HY Condition : FCC CLASS-B 3m HORN 9120D-HF HORIZONTAL Detector : Peak</p>	<p>Site : 03CH11-HY Condition : FCC CLASS-B 3m HORN 9120D-HF VERTICAL Detector : Peak</p>
Avg.	<p>Site : 03CH11-HY Condition : FCC CLASS-B (AVG) 3m HORN 9120D-HF HORIZONTAL Detector : Peak</p>	<p>Site : 03CH11-HY Condition : FCC CLASS-B (AVG) 3m HORN 9120D-HF VERTICAL Detector : Peak</p>



WIFI	Band 3 5470~5725MHz Band Edge @ 3m	
ANT	802.11a CH116 5580MHz - L	
1	Horizontal	Vertical
Peak	<p>Site : 03CH11-HY Condition : FCC CLASS-B 3m HORN 9120D-HF HORIZONTAL Detector : Peak</p>	<p>Site : 03CH11-HY Condition : FCC CLASS-B 3m HORN 9120D-HF VERTICAL Detector : Peak</p>
Avg.	<p>Site : 03CH11-HY Condition : FCC CLASS-B (AVG) 3m HORN 9120D-HF HORIZONTAL Detector : Peak</p>	<p>Site : 03CH11-HY Condition : FCC CLASS-B (AVG) 3m HORN 9120D-HF VERTICAL Detector : Peak</p>



WIFI	Band 3 5470~5725MHz Band Edge @ 3m	
ANT	802.11a CH116 5580MHz - R	
1	Horizontal	Vertical
Peak	<p>Date: 2016-02-06</p> <p>Site : 03CH11-HY Condition : FCC CLASS-B 3m HORN 9120D-HF HORIZONTAL Detector : Peak</p>	<p>Date: 2016-02-06</p> <p>Site : 03CH11-HY Condition : FCC CLASS-B 3m HORN 9120D-HF VERTICAL Detector : Peak</p>
Avg.	<p>Date: 2016-02-06</p> <p>Site : 03CH11-HY Condition : FCC CLASS-B (AVG) 3m HORN 9120D-HF HORIZONTAL Detector : Peak</p>	<p>Date: 2016-02-06</p> <p>Site : 03CH11-HY Condition : FCC CLASS-B (AVG) 3m HORN 9120D-HF VERTICAL Detector : Peak</p>



WIFI	Band 3 5470~5725MHz Band Edge @ 3m	
ANT	802.11a CH140 5700MHz	
1	Horizontal	Vertical
Peak	<p>Site : 03CH11-HY Condition : FCC CLASS-B 3m HORN 9120D-HF HORIZONTAL Detector : Peak</p>	<p>Site : 03CH11-HY Condition : FCC CLASS-B 3m HORN 9120D-HF VERTICAL Detector : Peak</p>
Avg.	<p>Site : 03CH11-HY Condition : FCC CLASS-B (AVG) 3m HORN 9120D-HF HORIZONTAL Detector : Peak</p>	<p>Site : 03CH11-HY Condition : FCC CLASS-B (AVG) 3m HORN 9120D-HF VERTICAL Detector : Peak</p>



**Band 3 5470~5725MHz
WIFI 802.11n HT20 (Band Edge @ 3m)**

WIFI	Band 3 5470~5725MHz Band Edge @ 3m	
ANT	802.11n HT20 CH100 5500MHz	
1	Horizontal	Vertical
Peak	<p>Site : 03CH11-HY Condition : FCC CLASS-B 3m HORN 9120D-HF HORIZONTAL Detector : Peak</p>	<p>Site : 03CH11-HY Condition : FCC CLASS-B 3m HORN 9120D-HF VERTICAL Detector : Peak</p>
Avg.	<p>Site : 03CH11-HY Condition : FCC CLASS-B (AVG) 3m HORN 9120D-HF HORIZONTAL Detector : Peak</p>	<p>Site : 03CH11-HY Condition : FCC CLASS-B (AVG) 3m HORN 9120D-HF VERTICAL Detector : Peak</p>

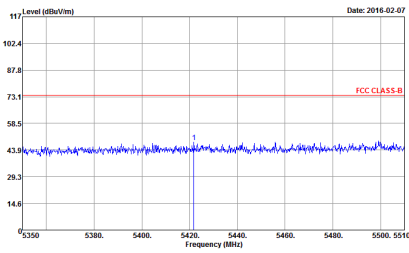
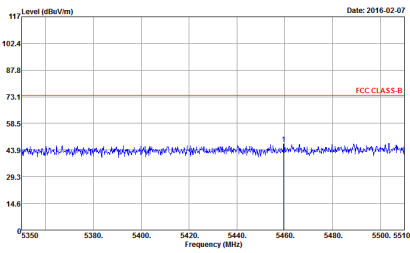
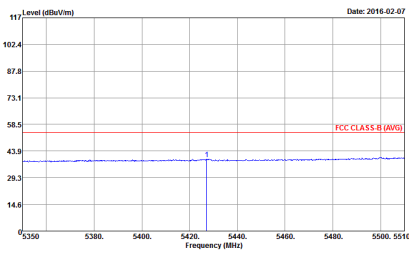
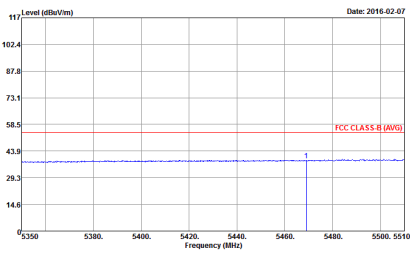

WIFI	Band 3 5470~5725MHz Band Edge @ 3m	
ANT	802.11n HT20 CH116 5580MHz - L	
1	Horizontal	Vertical
Peak	 <p>Site : 03CH11-HY Condition : FCC CLASS-B 3m HORN 9120D-HF HORIZONTAL Detector : Peak</p>	 <p>Site : 03CH11-HY Condition : FCC CLASS-B 3m HORN 9120D-HF VERTICAL Detector : Peak</p>
Avg.	 <p>Site : 03CH11-HY Condition : FCC CLASS-B (AVG) 3m HORN 9120D-HF HORIZONTAL Detector : Peak</p>	 <p>Site : 03CH11-HY Condition : FCC CLASS-B (AVG) 3m HORN 9120D-HF VERTICAL Detector : Peak</p>

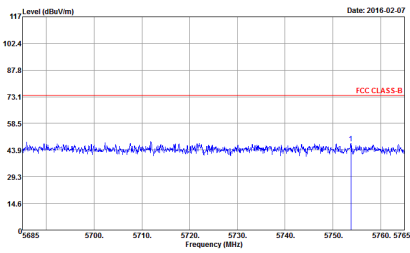
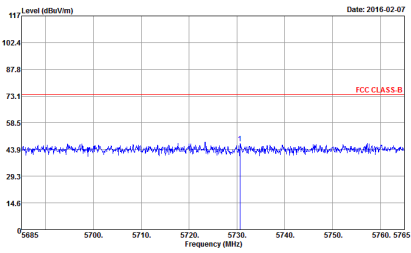
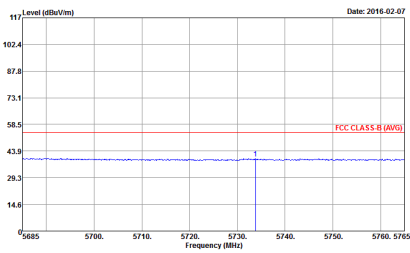
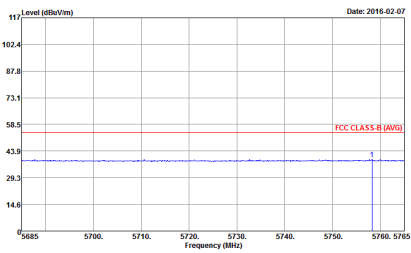

WIFI	Band 3 5470~5725MHz Band Edge @ 3m	
ANT	802.11n HT20 CH116 5580MHz - R	
1	Horizontal	Vertical
Peak	 <p>Date: 2016-02-07</p> <p>Site : 03CH11-HY Condition : FCC CLASS-B 3m HORN 9120D-HF HORIZONTAL Detector : Peak</p>	 <p>Date: 2016-02-07</p> <p>Site : 03CH11-HY Condition : FCC CLASS-B 3m HORN 9120D-HF VERTICAL Detector : Peak</p>
Avg.	 <p>Date: 2016-02-07</p> <p>Site : 03CH11-HY Condition : FCC CLASS-B (AVG) 3m HORN 9120D-HF HORIZONTAL Detector : Peak</p>	 <p>Date: 2016-02-07</p> <p>Site : 03CH11-HY Condition : FCC CLASS-B (AVG) 3m HORN 9120D-HF VERTICAL Detector : Peak</p>



WIFI	Band 3 5470~5725MHz Band Edge @ 3m	
ANT	802.11n HT20 CH140 5700MHz	
1	Horizontal	Vertical
Peak	<p>Date: 2016-02-07</p> <p>Site : 03CH11-HY Condition : FCC CLASS-B 3m HORN 9120D-HF HORIZONTAL RBW:1000.000KHz VBW:3000.000KHz SWT:Auto Detector : Peak</p>	<p>Date: 2016-02-07</p> <p>Site : 03CH11-HY Condition : FCC CLASS-B 3m HORN 9120D-HF VERTICAL RBW:1000.000KHz VBW:3000.000KHz SWT:Auto Detector : Peak</p>
Avg.	<p>Date: 2016-02-07</p> <p>Site : 03CH11-HY Condition : FCC CLASS-B (AVG) 3m HORN 9120D-HF HORIZONTAL RBW:1000.000KHz VBW:1000KHz SWT:Auto Detector : Peak</p>	<p>Date: 2016-02-07</p> <p>Site : 03CH11-HY Condition : FCC CLASS-B (AVG) 3m HORN 9120D-HF VERTICAL RBW:1000.000KHz VBW:1000KHz SWT:Auto Detector : Peak</p>



**Band 3 5470~5725MHz
WIFI 802.11n HT40 (Band Edge @ 3m)**

WIFI	Band 3 5470~5725MHz Band Edge @ 3m	
ANT	802.11n HT40 CH102 5510MHz - L	
1	Horizontal	Vertical
Peak	<p>Site : 03CH11-HY Condition : FCC CLASS-B 3m HORN 9120D-HF HORIZONTAL RBW:1000.000KHz VBW:3000.000KHz SWT:Auto Detector : Peak</p>	<p>Site : 03CH11-HY Condition : FCC CLASS-B 3m HORN 9120D-HF VERTICAL RBW:1000.000KHz VBW:3000.000KHz SWT:Auto Detector : Peak</p>
Avg.	<p>Site : 03CH11-HY Condition : FCC CLASS-B (AVG) 3m HORN 9120D-HF HORIZONTAL RBW:1000.000KHz VBW:3.000KHz SWT:Auto Detector : Peak</p>	<p>Site : 03CH11-HY Condition : FCC CLASS-B (AVG) 3m HORN 9120D-HF VERTICAL RBW:1000.000KHz VBW:3.000KHz SWT:Auto Detector : Peak</p>

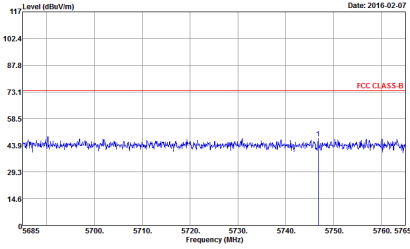
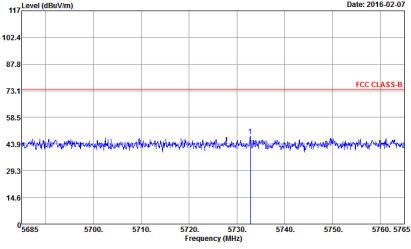
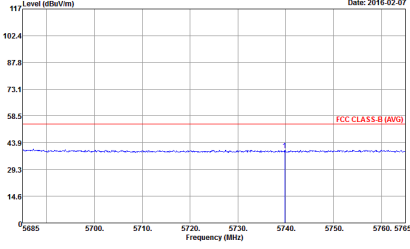
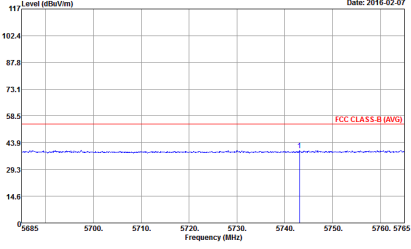

WIFI	Band 3 5470~5725MHz Band Edge @ 3m	
ANT	802.11n HT40 CH102 5510MHz - R	
1	Horizontal	Vertical
Peak	 <p>Date: 2016-02-07</p> <p>Site : 03CH11-HY Condition : FCC CLASS-B 3m HORN 9120D-HF HORIZONTAL RBW:1000.000KHz VBW:3000.000KHz SWT:Auto Detector : Peak</p>	 <p>Date: 2016-02-07</p> <p>Site : 03CH11-HY Condition : FCC CLASS-B 3m HORN 9120D-HF VERTICAL RBW:1000.000KHz VBW:3000.000KHz SWT:Auto Detector : Peak</p>
Avg.	 <p>Date: 2016-02-07</p> <p>Site : 03CH11-HY Condition : FCC CLASS-B (AVG) 3m HORN 9120D-HF HORIZONTAL RBW:1000.000KHz VBW:3.000KHz SWT:Auto Detector : Peak</p>	 <p>Date: 2016-02-07</p> <p>Site : 03CH11-HY Condition : FCC CLASS-B (AVG) 3m HORN 9120D-HF VERTICAL RBW:1000.000KHz VBW:3.000KHz SWT:Auto Detector : Peak</p>

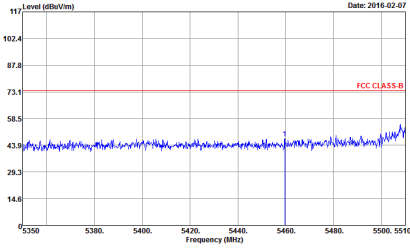
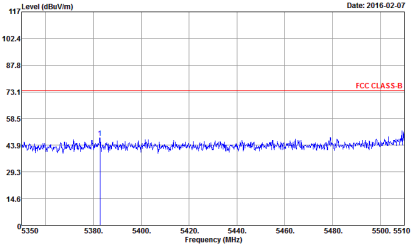
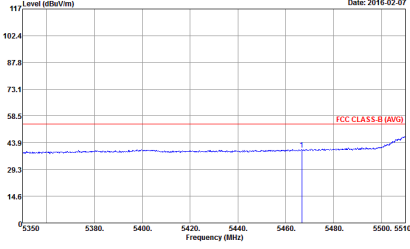
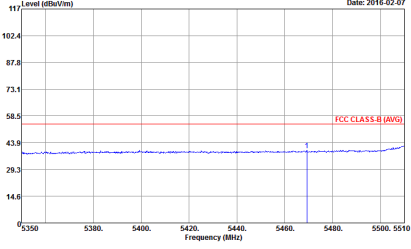

WIFI	Band 3 5470~5725MHz Band Edge @ 3m	
ANT	802.11n HT40 CH110 5550MHz - L	
1	Horizontal	Vertical
Peak	 <p>Site : 03CH11-HY Condition : FCC CLASS-B 3m HORN 9120D-HF HORIZONTAL RBW:1000.000KHz VBW:3000.000KHz SWT:Auto Detector : Peak</p>	 <p>Site : 03CH11-HY Condition : FCC CLASS-B 3m HORN 9120D-HF VERTICAL RBW:1000.000KHz VBW:3000.000KHz SWT:Auto Detector : Peak</p>
Avg.	 <p>Site : 03CH11-HY Condition : FCC CLASS-B (AVG) 3m HORN 9120D-HF HORIZONTAL RBW:1000.000KHz VBW:3.000KHz SWT:Auto Detector : Peak</p>	 <p>Site : 03CH11-HY Condition : FCC CLASS-B (AVG) 3m HORN 9120D-HF VERTICAL RBW:1000.000KHz VBW:3.000KHz SWT:Auto Detector : Peak</p>

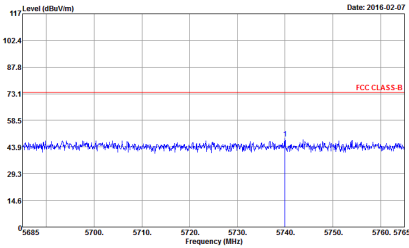
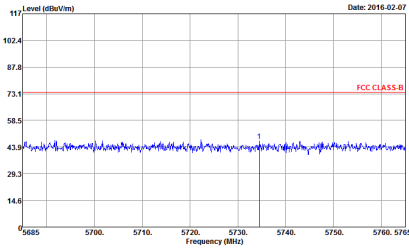
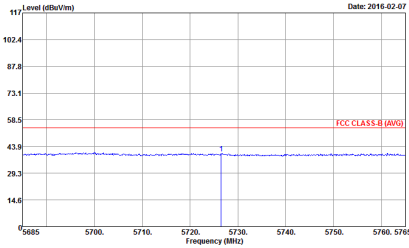
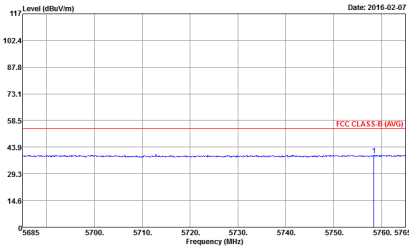

WIFI	Band 3 5470~5725MHz Band Edge @ 3m	
ANT	802.11n HT40 CH110 5550MHz - R	
1	Horizontal	Vertical
Peak	 <p>Site : 03CH11-HY Condition : FCC CLASS-B 3m HORN 9120D-HF HORIZONTAL Detector : Peak</p>	 <p>Site : 03CH11-HY Condition : FCC CLASS-B 3m HORN 9120D-HF VERTICAL Detector : Peak</p>
Avg.	 <p>Site : 03CH11-HY Condition : FCC CLASS-B (AVG) 3m HORN 9120D-HF HORIZONTAL Detector : Peak</p>	 <p>Site : 03CH11-HY Condition : FCC CLASS-B (AVG) 3m HORN 9120D-HF VERTICAL Detector : Peak</p>



WIFI	Band 3 5470~5725MHz Band Edge @ 3m	
ANT	802.11n HT40 CH134 5670MHz - L	
1	Horizontal	Vertical
Peak	<p>Date: 2016-02-07</p> <p>Site : 03CH11-HY Condition : FCC CLASS-B 3m HORN 9120D-HF HORIZONTAL Detector : Peak</p>	<p>Date: 2016-02-07</p> <p>Site : 03CH11-HY Condition : FCC CLASS-B 3m HORN 9120D-HF VERTICAL Detector : Peak</p>
Avg.	<p>Date: 2016-02-07</p> <p>Site : 03CH11-HY Condition : FCC CLASS-B (AVG) 3m HORN 9120D-HF HORIZONTAL Detector : Peak</p>	<p>Date: 2016-02-07</p> <p>Site : 03CH11-HY Condition : FCC CLASS-B (AVG) 3m HORN 9120D-HF VERTICAL Detector : Peak</p>

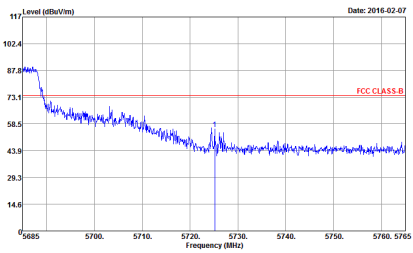
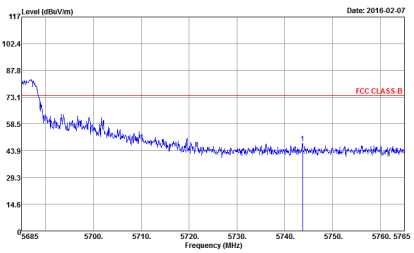
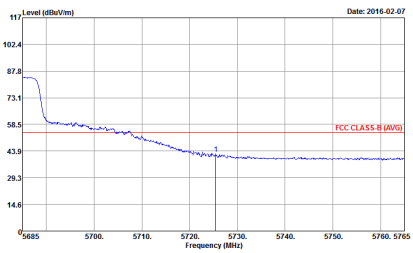
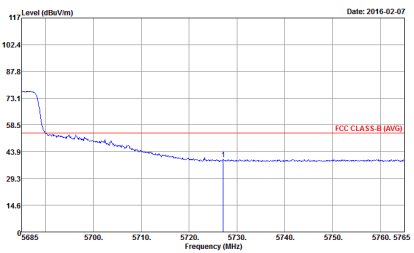

WIFI	Band 3 5470~5725MHz Band Edge @ 3m	
ANT	802.11n HT40 CH134 5670MHz - R	
1	Horizontal	Vertical
Peak	 <p>Site : 03CH11-HY Condition : FCC CLASS-B 3m HORN 9120D-HF HORIZONTAL RBW:1000.000KHz VBW:3000.000KHz SWT:Auto Detector : Peak</p>	 <p>Site : 03CH11-HY Condition : FCC CLASS-B 3m HORN 9120D-HF VERTICAL RBW:1000.000KHz VBW:3000.000KHz SWT:Auto Detector : Peak</p>
Avg.	 <p>Site : 03CH11-HY Condition : FCC CLASS-B (AVG) 3m HORN 9120D-HF HORIZONTAL RBW:1000.000KHz VBW:3.000KHz SWT:Auto Detector : Peak</p>	 <p>Site : 03CH11-HY Condition : FCC CLASS-B (AVG) 3m HORN 9120D-HF VERTICAL RBW:1000.000KHz VBW:3.000KHz SWT:Auto Detector : Peak</p>



**Band 3 - 5470~5725MHz
WIFI 802.11a (Harmonic @ 3m)**

WIFI	Band 3 5470~5725MHz Harmonic @ 3m	
ANT	802.11a CH100 5500MHz	
1	Horizontal	Vertical
Peak Avg.	<p>Site : 03CH11-HY Condition : FCC CLASS-B 3m 9170 SHF HORM_150809 HORIZONTAL Detector : Peak</p>	<p>Site : 03CH11-HY Condition : FCC CLASS-B 3m 9170 SHF HORM_150809 VERTICAL Detector : Peak</p>



WIFI	Band 3 5470-5725MHz Harmonic @ 3m	
ANT	802.11a CH116 5580MHz	
1	Horizontal	Vertical
Peak Avg.	<p>Site : 03CH11-HY Condition : FCC CLASS-B 3m 9170 SHF HORM_150809 HORIZONTAL Detector : Peak</p>	<p>Site : 03CH11-HY Condition : FCC CLASS-B 3m 9170 SHF HORM_150809 VERTICAL Detector : Peak</p>

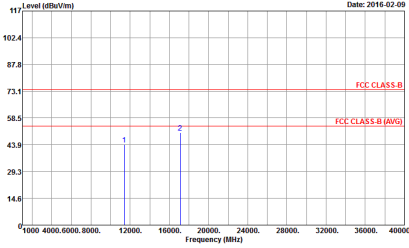
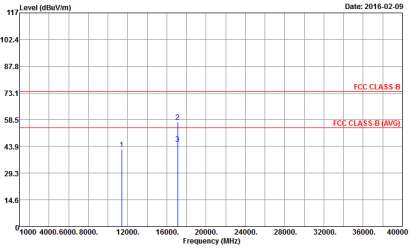

WIFI	Band 3 5470-5725MHz Harmonic @ 3m	
ANT	802.11a CH140 5700MHz	
1	Horizontal	Vertical
<p>Peak Avg.</p>	 <p>Site : 03CH11-HY Condition : FCC CLASS-B 3m 9170 SHF HORM_150809 HORIZONTAL Detector : Peak</p>	 <p>Site : 03CH11-HY Condition : FCC CLASS-B 3m 9170 SHF HORM_150809 VERTICAL Detector : Peak</p>



Band 3 5470~5725MHz
WIFI 802.11n HT20 (Harmonic @ 3m)

Table with 3 columns: WIFI, ANT, and 1. It contains two graphs showing Peak and Avg. levels for Horizontal and Vertical orientations. The graphs plot Level (dBuV/m) against Frequency (MHz) from 0 to 40000. Two red lines indicate FCC CLASS-B and FCC CLASS-B (AVG) limits. Two blue peaks are labeled 1 and 2.



WIFI	Band 3 5470-5725MHz Harmonic @ 3m	
ANT	802.11n HT20 CH116 5580MHz	
1	Horizontal	Vertical
Peak Avg.	<p>Site : 03CH11-HY Condition : FCC CLASS-B 3m 9170 SHF HORM_150809 HORIZONTAL Detector : Peak</p>	<p>Site : 03CH11-HY Condition : FCC CLASS-B 3m 9170 SHF HORM_150809 VERTICAL Detector : Peak</p>



WIFI	Band 3 5470-5725MHz Harmonic @ 3m	
ANT	802.11n HT20 CH140 5700MHz	
1	Horizontal	Vertical
Peak Avg.	<p>Site : 03CH11-HY Condition : FCC CLASS-B 3m 9170 SHF HORM_150809 HORIZONTAL Detector : Peak</p>	<p>Site : 03CH11-HY Condition : FCC CLASS-B 3m 9170 SHF HORM_150809 VERTICAL Detector : Peak</p>



**Band 3 5470~5725MHz
WIFI 802.11n HT40 (Harmonic @ 3m)**

WIFI	Band 3 5470~5725MHz Harmonic @ 3m	
ANT	802.11n HT40 CH102 5510MHz	
1	Horizontal	Vertical
<p>Peak Avg.</p>	<p>Site : 03CH11-HY Condition : FCC CLASS-B 3m 9170 SHF HORM_150809 HORIZONTAL Detector : Peak</p>	<p>Site : 03CH11-HY Condition : FCC CLASS-B 3m 9170 SHF HORM_150809 VERTICAL Detector : Peak</p>



WIFI	Band 3 5470-5725MHz Harmonic @ 3m	
ANT	802.11n HT40 CH110 5550MHz	
1	Horizontal	Vertical
Peak Avg.	<p>Site : 03CH11-HY Condition : FCC CLASS-B_BAND 4 3m 9170 SHF HORM_150809 HORIZONTAL Detector : Peak</p>	<p>Site : 03CH11-HY Condition : FCC CLASS-B_BAND 4 3m 9170 SHF HORM_150809 VERTICAL Detector : Peak</p>



WIFI	Band 3 5470-5725MHz Harmonic @ 3m	
ANT	802.11n HT40 CH134 5670MHz	
1	Horizontal	Vertical
Peak Avg.	<p>Site : 03CH11-HY Condition : FCC CLASS-B 3m 9170 SHF HORM_150809 HORIZONTAL Detector : Peak</p>	<p>Site : 03CH11-HY Condition : FCC CLASS-B 3m 9170 SHF HORM_150809 VERTICAL Detector : Peak</p>



Emission below 1GHz
5GHz WIFI 802.11a (LF)

WIFI	5GHz WIFI	
ANT	802.11a LF	
1	Horizontal	Vertical
QP / Peak	<p>Site : 03CH11-HY Condition : FCC CLASS-B 3m BI-LOG 6111D-LF_ETC HORIZONTAL Detector : Peak</p>	<p>Site : 03CH11-HY Condition : FCC CLASS-B 3m BI-LOG 6111D-LF_ETC VERTICAL Detector : Peak</p>



Emission below 1GHz
5GHz WIFI 802.11n HT20 (LF)

WIFI	5GHz WIFI	
ANT	802.11n HT20 LF	
1	Horizontal	Vertical
QP / Peak	<p>Site : 03CH11-HY Condition : FCC CLASS-B 3m BI-LOG 6111D-LF_ETC HORIZONTAL Detector : Peak</p>	<p>Site : 03CH11-HY Condition : FCC CLASS-B 3m BI-LOG 6111D-LF_ETC VERTICAL Detector : Peak</p>



Emission below 1GHz
5GHz WIFI 802.11n HT40 (LF)

Table with 3 columns: WIFI, ANT, and test results for Horizontal and Vertical orientations. Includes two graphs showing Level (dBuV/m) vs Frequency (MHz) with FCC CLASS B limits and peak markers.