



FCC RF Test Report

APPLICANT : Sony Mobile Communications Inc.
EQUIPMENT : GSM/WCDMA/LTE Phone+Bluetooth,
DTS/UNII a/b/g/n and NFC
BRAND NAME : Sony
FCC ID : PY7-PM0961
STANDARD : FCC Part 15 Subpart C §15.247
CLASSIFICATION : (DTS) Digital Transmission System

The product was received on Jan. 22, 2016 and testing was completed on Feb. 10, 2016. We, SPORTON INTERNATIONAL INC., would like to declare that the tested sample has been evaluated in accordance with the test procedures and has been in compliance with the applicable technical standards.

The test results in this report apply exclusively to the tested model / sample. Without written approval of SPORTON INTERNATIONAL INC., the test report shall not be reproduced except in full.

Reviewed by: Joseph Lin / Supervisor

Approved by: Jones Tsai / Manager



SPORTON INTERNATIONAL INC.

No. 52, Hwa Ya 1st Rd., Hwa Ya Technology Park, Kwei-Shan District, Tao Yuan City, Taiwan, R.O.C.

SPORTON INTERNATIONAL INC.

TEL : 886-3-327-3456

FAX : 886-3-328-4978

FCC ID : PY7-PM0961

Page Number : 1 of 46

Report Issued Date : Apr. 15, 2016

Report Version : Rev. 02

Report Template No.: BU5-FR15CWL Version 1.2



TABLE OF CONTENTS

REVISION HISTORY..... 3

SUMMARY OF TEST RESULT 4

1 GENERAL DESCRIPTION 5

 1.1 Applicant 5

 1.2 Manufacturer 5

 1.3 Product Feature of Equipment Under Test..... 5

 1.4 Modification of EUT 6

 1.5 Testing Location 7

 1.6 Applicable Standards..... 8

2 TEST CONFIGURATION OF EQUIPMENT UNDER TEST 9

 2.1 Carrier Frequency Channel 9

 2.2 Pre-Scanned RF Power 10

 2.3 Test Mode..... 11

 2.4 Connection Diagram of Test System..... 12

 2.5 Support Unit used in test configuration and system 13

 2.6 EUT Operation Test Setup 13

 2.7 Measurement Results Explanation Example..... 13

3 TEST RESULT 14

 3.1 6dB and 99% Bandwidth Measurement 14

 3.2 Output Power Measurement..... 16

 3.3 Power Spectral Density Measurement 18

 3.4 Conducted Band Edges and Spurious Emission Measurement 20

 3.5 Radiated Band Edges and Spurious Emission Measurement 33

 3.6 AC Conducted Emission Measurement..... 39

 3.7 Antenna Requirements 43

4 LIST OF MEASURING EQUIPMENT 44

5 UNCERTAINTY OF EVALUATION 46

APPENDIX A. CONDUTED TEST RESULTS

APPENDIX A. RADIATED SPURIOUS EMISSION

APPENDIX B. RADIATED SPURIOUS EMISSION PLOT



REVISION HISTORY

REPORT NO.	VERSION	DESCRIPTION	ISSUED DATE
FR612118-01C	Rev. 01	Initial issue of report	Apr. 01, 2016
FR612118-01C	Rev. 02	Adding the Duty Cycle data in section 3.5.8.	Apr. 15, 2016



SUMMARY OF TEST RESULT

Report Section	FCC Rule	Description	Limit	Result	Remark
3.1	15.247(a)(2)	6dB Bandwidth	$\geq 0.5\text{MHz}$	Pass	-
3.1	-	99% Bandwidth	-	Pass	-
3.2	15.247(b)	Power Output Measurement	$\leq 30\text{dBm}$	Pass	-
3.3	15.247(e)	Power Spectral Density	$\leq 8\text{dBm}/3\text{kHz}$	Pass	-
3.4	15.247(d)	Conducted Band Edges	$\leq 20\text{dBc}$	Pass	-
		Conducted Spurious Emission		Pass	-
3.5	15.247(d)	Radiated Band Edges and Radiated Spurious Emission	15.209(a) & 15.247(d)	Pass	Under limit 5.60 dB at 2483.560 MHz
3.6	15.207	AC Conducted Emission	15.207(a)	Pass	Under limit 17.70 dB at 0.438 MHz
3.7	15.203 & 15.247(b)	Antenna Requirement	N/A	Pass	-
<p>Remark: The FCC ID: PY7-PM0960 and FCC ID: PY7-PM0961 is similar device, in this report all the test result are referred to PY7-PM0960, Sporton Report No: FR612117-01C.</p>					



1 General Description

1.1 Applicant

Sony Mobile Communications Inc.

4-12-3 Higashi-Shinagawa, Shinagawa-ku, Tokyo, 140-0002, Japan

1.2 Manufacturer

Sony Mobile Communications Inc.

4-12-3 Higashi-Shinagawa, Shinagawa-ku, Tokyo, 140-0002, Japan

1.3 Product Feature of Equipment Under Test

GSM/WCDMA/LTE, Bluetooth, DTS/UNII, a/b/g/n, GPS, and NFC

Product Specification subjective to this standard	
Antenna Type	PIFA Antenna type with gain -0.30 dBi

EUT Information List				
IMEI	HW Version	SW Version	S/N	Performed Test Item
004402455898886	A	33.2.A.0.19	RQ3000DQQZ	RF conducted measurement
004402455893739			RQ3000DQHV	Radiated Spurious Emission
004402455895585			RQ3000DQQU	Conducted Emission



Accessory List	
AC Adapter	Model No. : EP800
	Type No. : CAA-0002016-US B
	S/N : 3113W22608082 (for Radiated spurious emission) 3113W22608092 (for Conducted emission)
Earphone	Model No. : MH410c
	Type No. : AG-1110
	S/N : 1541A8180036F24 (for Radiated spurious emission) 1541A81B0036C26 (for Conducted emission)
USB Cable	Model No. : UCB16
	Type No. : AI-0142
	S/N : N/A (for Radiated spurious emission) N/A (for Conducted emission)

Note:

1. Above EUT list and accessory list used are electrically identical per declared by manufacturer.
2. Above the accessories list are used to exercise the EUT during test.
3. For other wireless features of this EUT, test report will be issued separately.

1.4 Modification of EUT

No modifications are made to the EUT during all test items.



1.5 Testing Location

Sporton Lab is accredited to ISO 17025 by Taiwan Accreditation Foundation (TAF code : 1190) and the FCC designation No. TW1022 under the FCC 2.948(e) by Mutual Recognition Agreement (MRA) in FCC Test.

Test Site	SPORTON INTERNATIONAL INC.	
Test Site Location	No. 52, Hwa Ya 1 st Rd., Hwa Ya Technology Park, Kwei-Shan District, Tao Yuan City, Taiwan, R.O.C. TEL: +886-3-327-3456 FAX: +886-3-328-4978	
Test Site No.	Sporton Site No.	
	TH05-HY	CO05-HY

Note: The test site complies with ANSI C63.4 2014 requirement.

Test Site	SPORTON INTERNATIONAL INC.	
Test Site Location	No.58, Aly. 75, Ln. 564, Wenhua 3rd Rd. Guishan Dist, Taoyuan City, Taiwan (R.O.C.) TEL: +886-3-327-0868 FAX: +886-3-327-0855	
Test Site No.	Sporton Site No.	
	03CH11-HY	

Note: The test site complies with ANSI C63.4 2014 requirement.



1.6 Applicable Standards

According to the specifications of the manufacturer, the EUT must comply with the requirements of the following standards:

- ♦ FCC Part 15 Subpart C §15.247
- ♦ FCC KDB Publication No. 558074 D01 DTS Meas. Guidance v03r04
- ♦ ANSI C63.10-2013

Remark:

4. All test items were verified and recorded according to the standards and without any deviation during the test.
5. This EUT has also been tested and complied with the requirements of FCC Part 15, Subpart B, recorded in a separate test report.



2 Test Configuration of Equipment Under Test

The EUT has been associated with peripherals and configuration operated in a manner tended to maximize its emission characteristics in a typical application. Frequency range investigated: conducted emission (150 kHz to 30 MHz) and radiated emission (9 kHz to the 10th harmonic of the highest fundamental frequency or to 40 GHz, whichever is lower). For radiated measurement, pre-scanned in three orthogonal panels, X, Y, Z. The worst cases (X plane) were recorded in this report.

The final configuration from all the combinations and the worst-case data rates were investigated by measuring the maximum power across all the data rates and modulation modes under section 2.2.

Based on the worst configuration found above, the RF power setting is set individually to meet FCC compliance limit for the final conducted and radiated tests shown in section 2.3.

2.1 Carrier Frequency Channel

Frequency Band	Channel	Freq. (MHz)	Channel	Freq. (MHz)
2400-2483.5 MHz	1	2412	7	2442
	2	2417	8	2447
	3	2422	9	2452
	4	2427	10	2457
	5	2432	11	2462
	6	2437	-	-



2.2 Pre-Scanned RF Power

Preliminary tests were performed in different data rate and data rate associated with the highest power were chosen for full test shown in the following tables.

2.4GHz 802.11b mode				
Data Rate (MHz)	1M bps	2M bps	5.5M bps	11M bps
Peak Power (dBm)	20.75	20.73	20.58	20.65

2.4GHz 802.11g mode								
Data Rate (MHz)	6M bps	9M bps	12M bps	18M bps	24M bps	36M bps	48M bps	54M bps
Peak Power (dBm)	22.62	22.56	22.61	22.58	20.77	21.27	22.61	22.57

2.4GHz 802.11n HT20 mode								
Data Rate (MHz)	MCS0	MCS1	MCS2	MCS3	MCS4	MCS5	MCS6	MCS7
Peak Power (dBm)	20.98	20.86	20.67	20.85	20.87	20.95	20.91	20.75

2.4GHz 802.11n HT40 mode								
Data Rate (MHz)	MCS0	MCS1	MCS2	MCS3	MCS4	MCS5	MCS6	MCS7
Peak Power (dBm)	20.99	20.39	20.81	20.61	20.88	20.88	20.95	20.97



2.3 Test Mode

Final test mode of conducted test items and radiated spurious emissions are considering the modulation and worse data rates from the power table described in section 2.2.

<2.4GHz>

Modulation	Data Rate
802.11b	1 Mbps
802.11g	6 Mbps
802.11n HT20	MCS0
802.11n HT40	MCS0

Test Cases	
AC Conducted Emission	Mode 1 : GSM1900 Idle + Bluetooth Link + WLAN (2.4GHz) Link + MP3 + Earphone + Battery 2 + USB Cable (Charging from Adapter)

2.4 Connection Diagram of Test System

<WLAN Tx Mode>

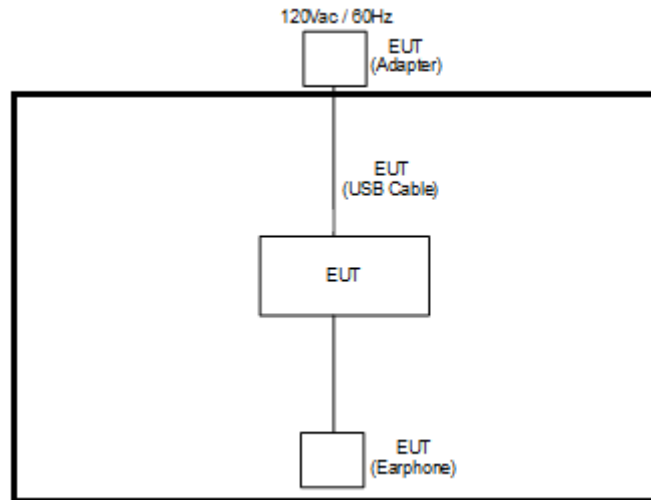

<AC Conducted Emission Mode>

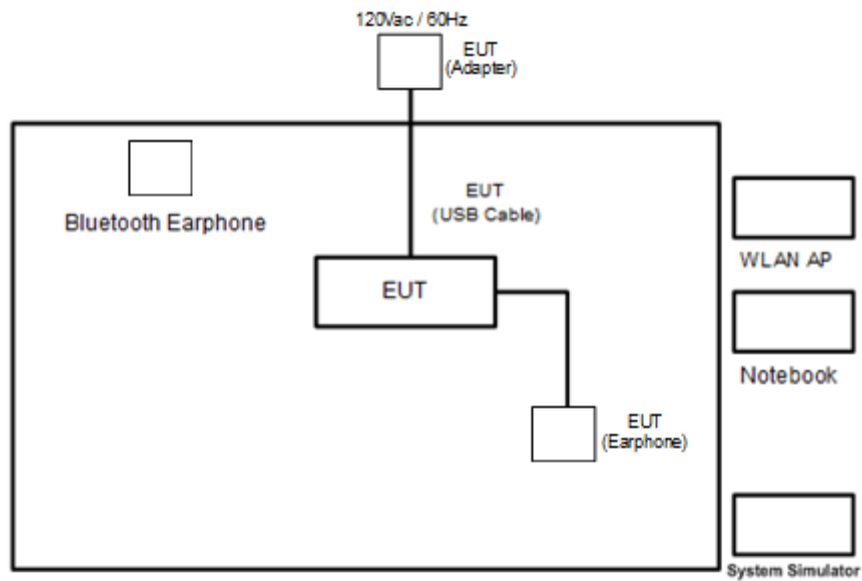



2.5 Support Unit used in test configuration and system

Item	Equipment	Trade Name	Model Name	FCC ID	Data Cable	Power Cord
1.	System Simulator	Anritsu	MT8820C	N/A	N/A	Unshielded, 1.8 m
2.	WLAN AP	D-Link	DIR-865L	KA2IR865LA1	N/A	Unshielded, 1.8 m
3.	Bluetooth Earphone	Samsung	SBH20	PY7-RD0010	Unshielded, 0.75 m	N/A
4.	Notebook	DELL	Latitude E6320	FCC DoC/ Contains FCC ID: QDS-BRCM1054	N/A	AC I/P: Unshielded, 1.2 m DC O/P: Shielded, 1.8 m
5.	SD Card	SanDisk	MicroSD HC	FCC DoC	N/A	N/A

2.6 EUT Operation Test Setup

For WLAN RF test items, an engineering test program was provided and enabled to make EUT continuous transmit/receive.

2.7 Measurement Results Explanation Example

For all conducted test items:

The offset level is set in the spectrum analyzer to compensate the RF cable loss and attenuator factor between EUT conducted output port and spectrum analyzer. With the offset compensation, the spectrum analyzer reading level is exactly the EUT RF output level.

Example :

The spectrum analyzer offset is derived from RF cable loss and attenuator factor.

Offset = RF cable loss + attenuator factor.

Following shows an offset computation example with cable loss 4.2 dB and 10dB attenuator.

$$\begin{aligned} \text{Offset(dB)} &= \text{RF cable loss(dB)} + \text{attenuator factor(dB)}. \\ &= 4.2 + 10 = 14.2 \text{ (dB)} \end{aligned}$$

3 Test Result

3.1 6dB and 99% Bandwidth Measurement

3.1.1 Limit of 6dB and 99% Bandwidth

The minimum 6 dB bandwidth shall be at least 500 kHz.

3.1.2 Measuring Instruments

The measuring equipment is listed in the section 4 of this test report.

3.1.3 Test Procedures

1. The testing follows FCC KDB Publication No. 558074 DTS D01 Meas. Guidance v03r04.
2. The RF output of EUT was connected to the spectrum analyzer by RF cable and attenuator. The path loss was compensated to the results for each measurement.
3. Set to the maximum power setting and enable the EUT transmit continuously.
4. Make the measurement with the spectrum analyzer's resolution bandwidth (RBW) = 100 kHz. Set the Video bandwidth (VBW) = 300 kHz. In order to make an accurate measurement. The 6 dB bandwidth must be greater than 500 kHz.
5. For 99% Bandwidth Measurement, the spectrum analyzer's resolution bandwidth (RBW) = 1MHz and set the Video bandwidth (VBW) = 3MHz.
6. Measure and record the results in the test report.

3.1.4 Test Setup

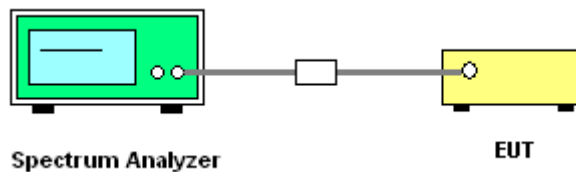



3.1.5 Test Result of 6dB and 99% Occupied Bandwidth

Please refer to Appendix A of this test report.

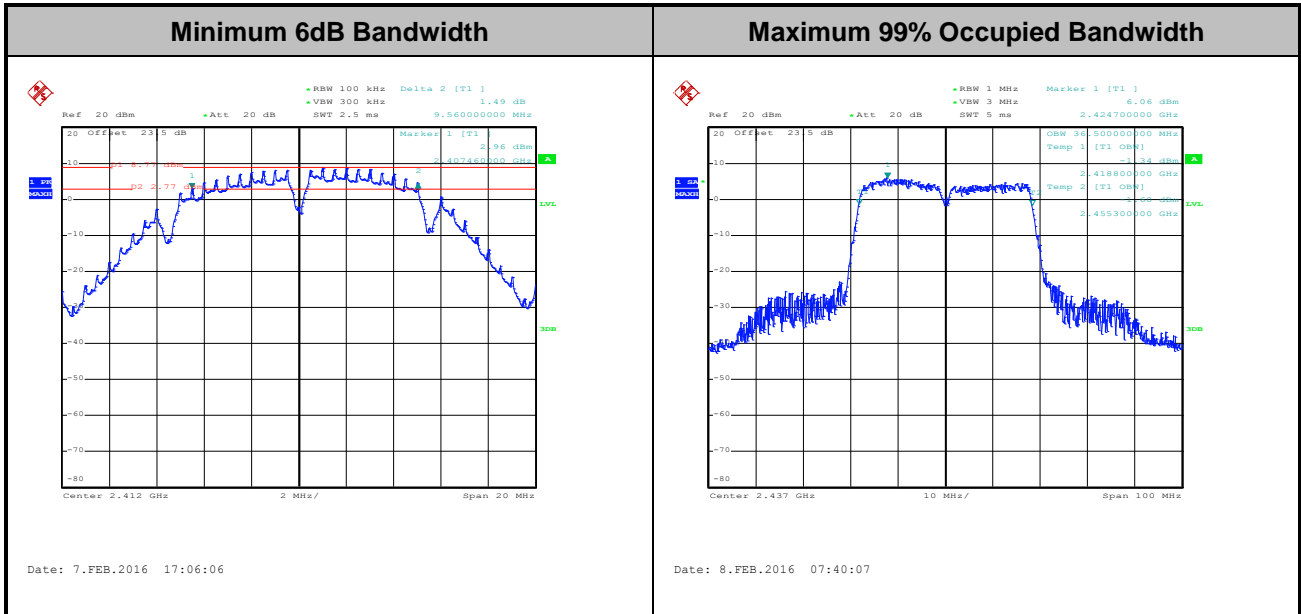

Note : The occupied channel bandwidth is maintained within the band of operation for all of the modulations.

3.2 Output Power Measurement

3.2.1 Limit of Output Power

For systems using digital modulation in the 2400-2483.5MHz, the limit for peak output power is 30dBm. If transmitting Antenna of directional gain greater than 6dBi are used the peak output power from the intentional radiator shall be reduced below the above stated value by the amount in dB that the directional gain of the Antenna exceeds 6 dBi. In case of point-to-point operation, the limit has to be reduced by 1dB for every 3dB that the directional gain of the Antenna exceeds 6dBi.

3.2.2 Measuring Instruments

The measuring equipment is listed in the section 4 of this test report.

3.2.3 Test Procedures

1. The testing follows the Measurement Procedure of FCC KDB No. 558074 DTS D01 Meas. Guidance v03r04 section 9.1.2 PKPM1 Peak power meter method.
2. The RF output of EUT was connected to the power meter by RF cable and attenuator. The path loss was compensated to the results for each measurement.
3. Set to the maximum power setting and enable the EUT transmit continuously.
4. Measure the conducted output power and record the results in the test report.

3.2.4 Test Setup

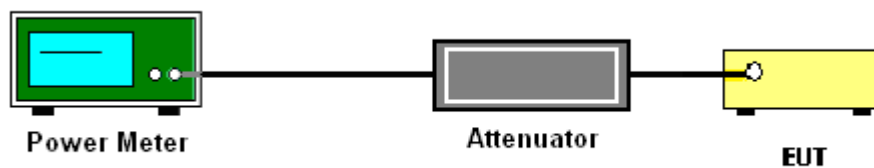



3.2.5 Test Result of Peak Output Power

Please refer to Appendix A of this test report.

3.2.6 Test Result of Average output Power (Reporting Only)

Please refer to Appendix A of this test report.

3.3 Power Spectral Density Measurement

3.3.1 Limit of Power Spectral Density

The peak power spectral density shall not be greater than 8dBm in any 3kHz band at any time interval of continuous transmission.

3.3.2 Measuring Instruments

The measuring equipment is listed in the section 4 of this test report.

3.3.3 Test Procedures

1. The testing follows Measurement Procedure 10.2 Method PKPSD of FCC KDB Publication No. 558074 D01 DTS Meas. Guidance v03r04
2. The RF output of EUT was connected to the spectrum analyzer by RF cable and attenuator. The path loss was compensated to the results for each measurement.
3. Set to the maximum power setting and enable the EUT transmit continuously.
4. Make the measurement with the spectrum analyzer's resolution bandwidth (RBW) = 3 kHz. Video bandwidth VBW = 10 kHz In order to make an accurate measurement, set the span to 1.5 times DTS Channel Bandwidth. (6dB BW)
5. Detector = peak, Sweep time = auto couple, Trace mode = max hold, Allow trace to fully stabilize. Use the peak marker function to determine the maximum power level.
6. Measure and record the results in the test report.

3.3.4 Test Setup

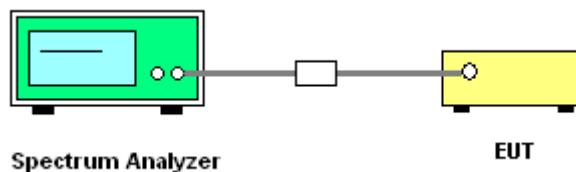



3.3.5 Test Result of Power Spectral Density

Please refer to Appendix A of this test report.

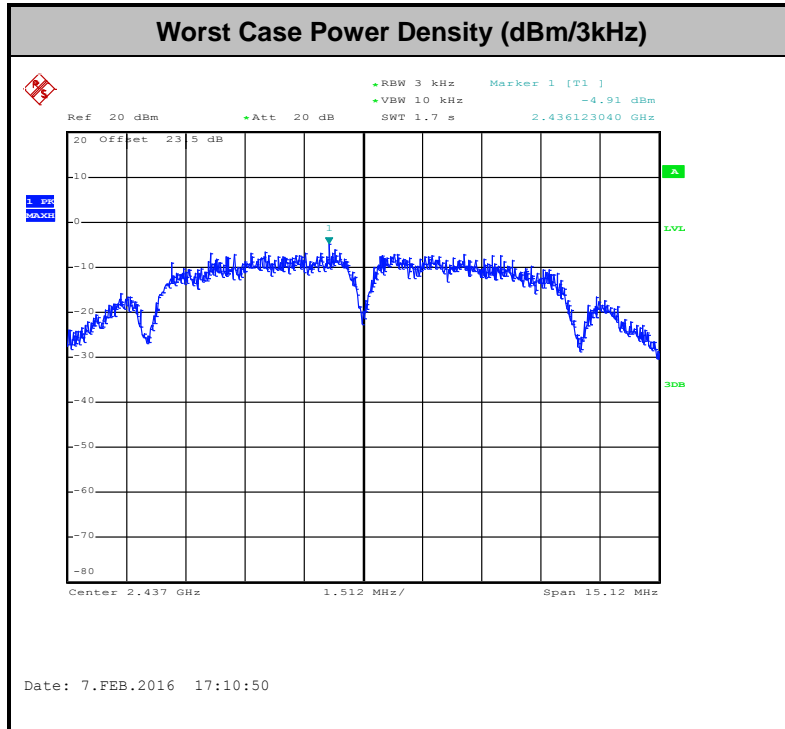

3.4 Conducted Band Edges and Spurious Emission Measurement

3.4.1 Limit of Conducted Band Edges and Spurious Emission Measurement

In any 100 kHz bandwidth outside of the authorized frequency band, the emissions which fall in the non-restricted bands shall be attenuated at least 20 dB / 30dB relative to the maximum PSD level in 100 kHz by RF conducted measurement and radiated emissions which fall in the restricted bands, as defined in Section 15.205(a), must also comply with the radiated emission limits specified in Section 15.209(a).

3.4.2 Measuring Instruments

The measuring equipment is listed in the section 4 of this test report.

3.4.3 Test Procedures

1. The testing follows FCC KDB Publication No. 558074 D01 DTS Meas. Guidance v03r04.
2. The RF output of EUT was connected to the spectrum analyzer by RF cable and attenuator. The path loss was compensated to the results for each measurement.
3. Set to the maximum power setting and enable the EUT transmit continuously.
4. Set RBW = 100 kHz, VBW=300 kHz, Peak Detector. Unwanted Emissions measured in any 100 kHz bandwidth outside of the authorized frequency band shall be attenuated by at least 20 dB relative to the maximum in-band peak PSD level in 100 kHz when maximum peak conducted output power procedure is used. If the transmitter complies with the conducted power limits based on the use of RMS averaging over a time interval, the attenuation required under this paragraph shall be 30 dB instead of 20 dB per 15.247(d).
5. Measure and record the results in the test report.
6. The RF fundamental frequency should be excluded against the limit line in the operating frequency band.

3.4.4 Test Setup

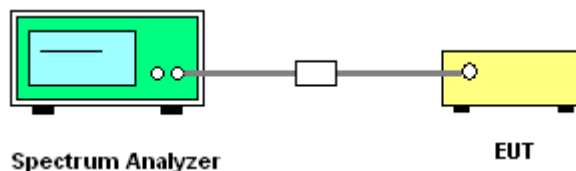



3.4.5 Test Result of Conducted Band Edges and Spurious Emission

Test Mode :	802.11b	Temperature :	21~24°C
Test Band :	2.4GHz Low	Relative Humidity :	51~54%
Test Channel :	01	Test Engineer :	Osolemio Chang

WLAN 802.11b Channel 01

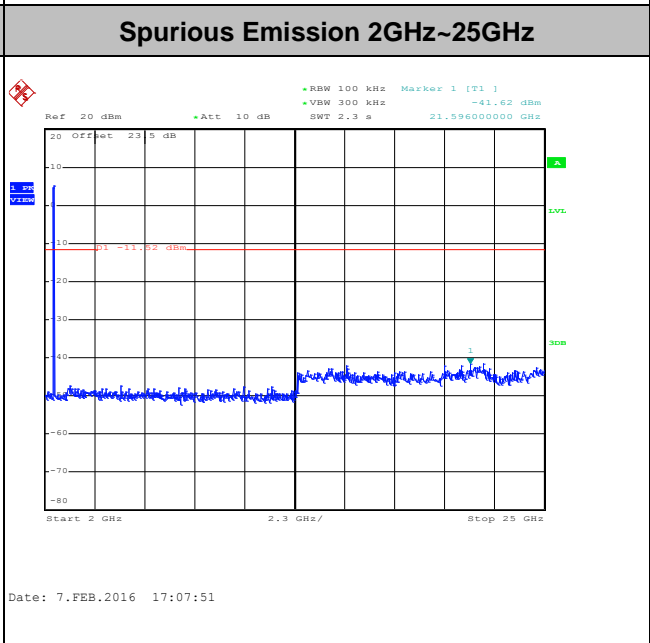
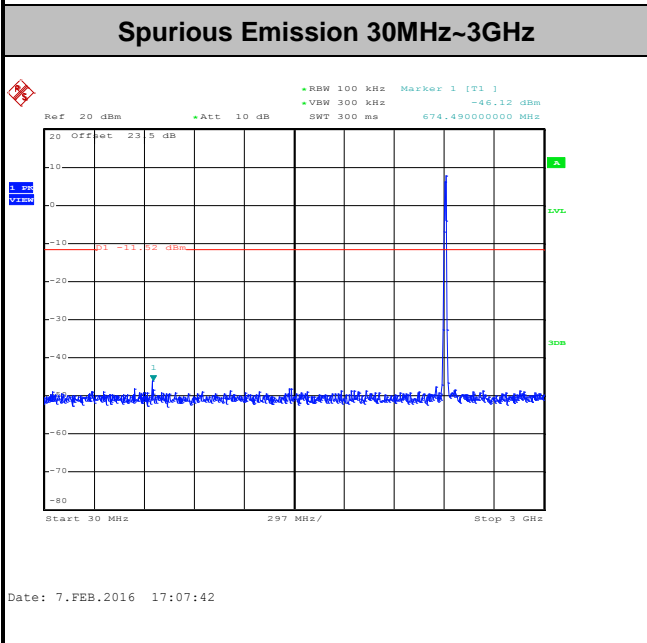
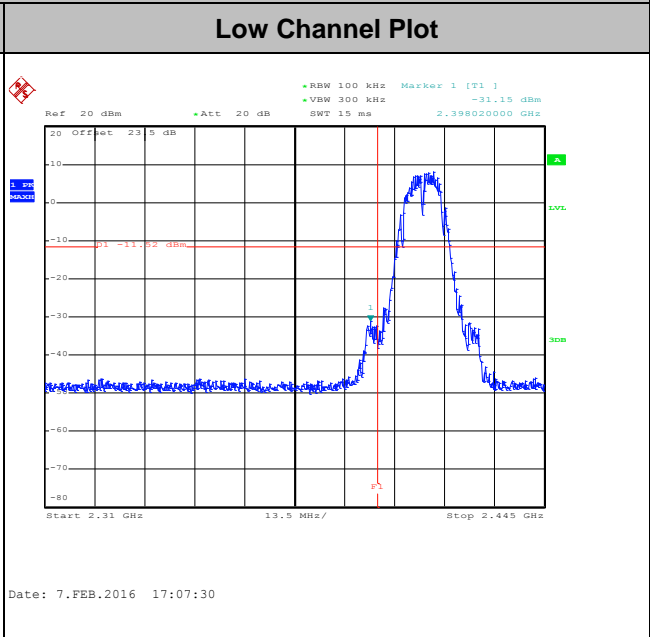
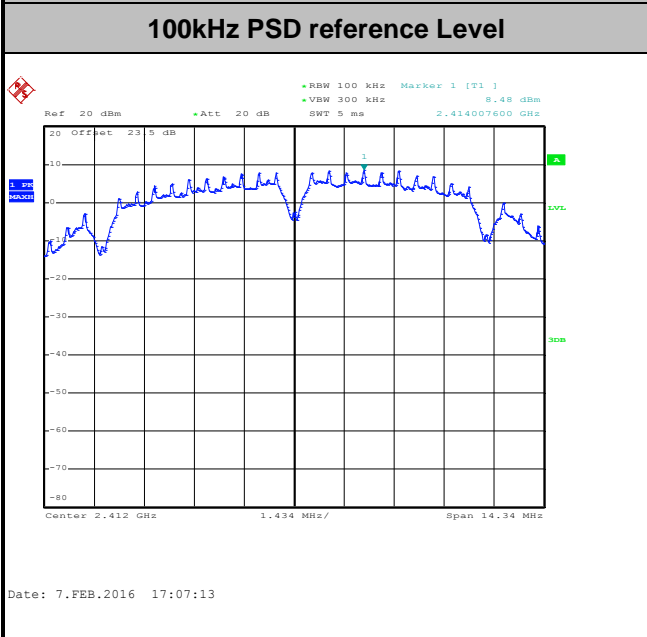



Test Mode :	802.11b	Temperature :	21~24°C
Test Band :	2.4GHz Mid	Relative Humidity :	51~54%
Test Channel :	06	Test Engineer :	Osolemio Chang

WLAN 802.11b Channel 06

100kHz PSD reference Level

Mid Channel Plot

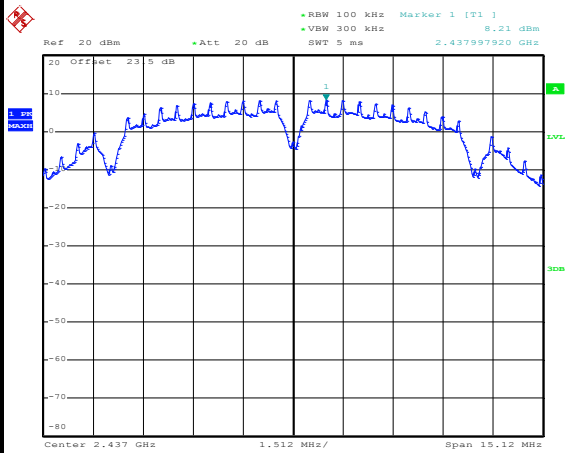

Date: 7.FEB.2016 17:11:51

Spurious Emission 30MHz~3GHz

Spurious Emission 2GHz~25GHz

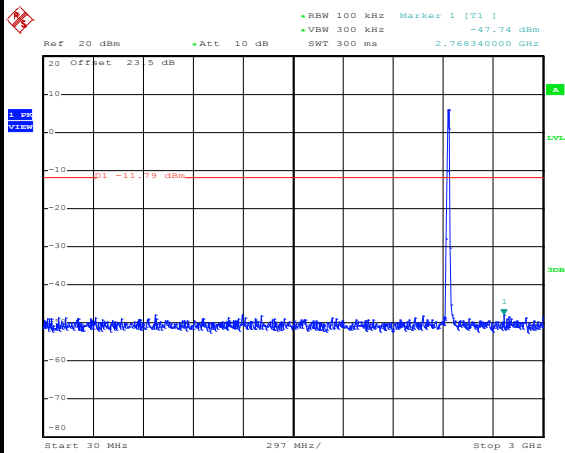

Date: 7.FEB.2016 17:12:03

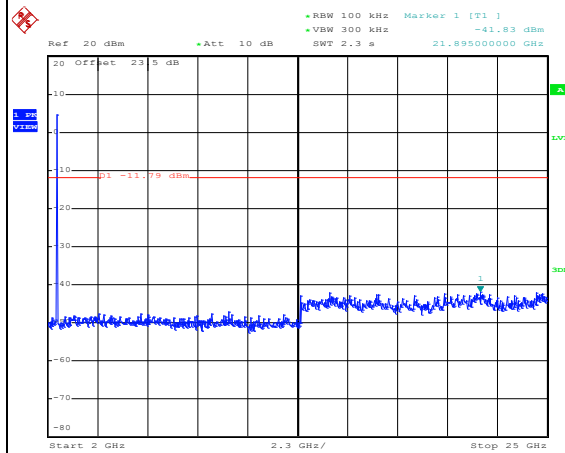

Date: 7.FEB.2016 17:12:11



Test Mode :	802.11b	Temperature :	21~24°C
Test Band :	2.4GHz High	Relative Humidity :	51~54%
Test Channel :	11	Test Engineer :	Osolemio Chang

WLAN 802.11b Channel 11

100kHz PSD reference Level

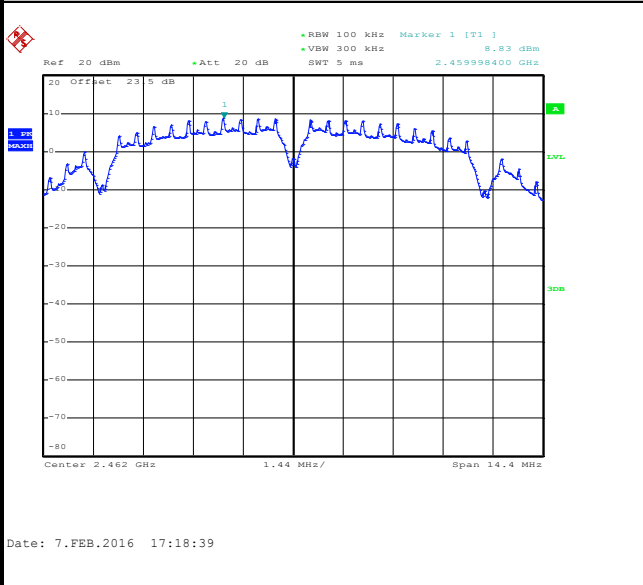

High Channel Plot

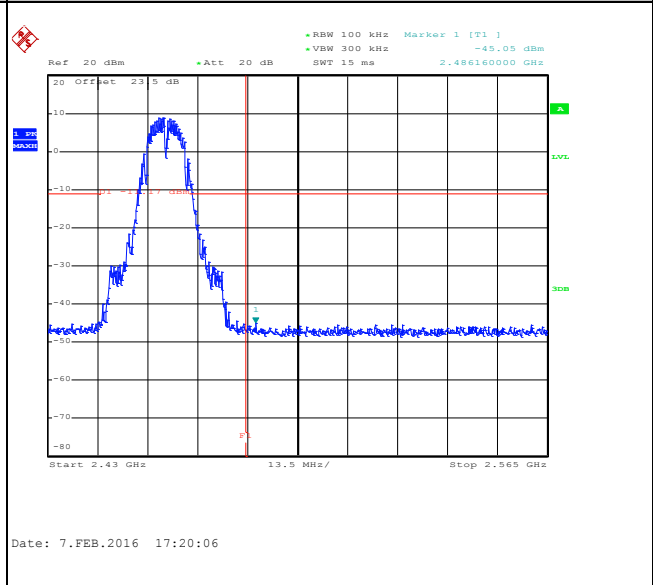

Spurious Emission 30MHz~3GHz

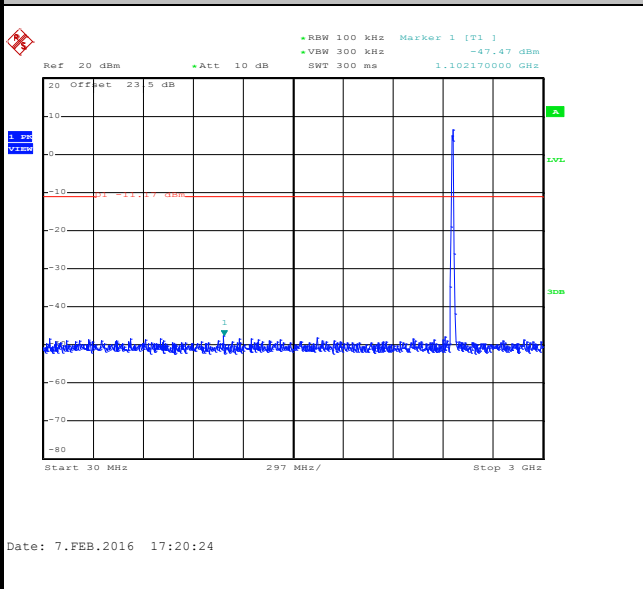

Spurious Emission 2GHz~25GHz

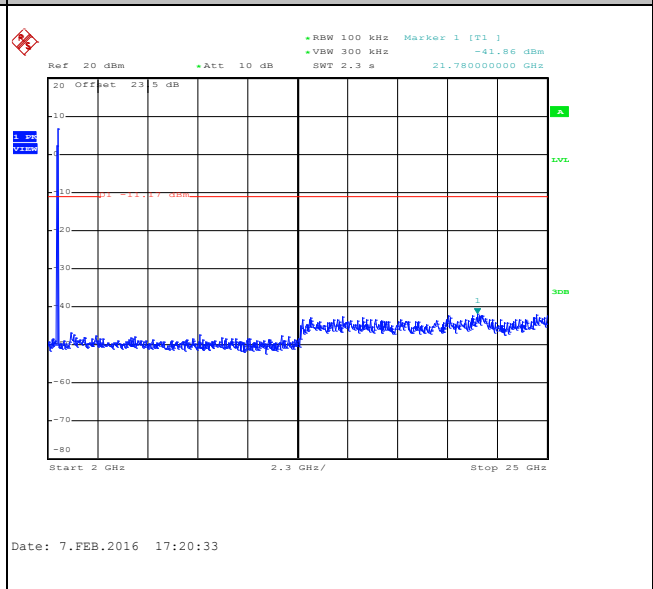



Test Mode :	802.11g	Temperature :	21~24°C
Test Band :	2.4GHz Low	Relative Humidity :	51~54%
Test Channel :	01	Test Engineer :	Osolemio Chang

WLAN 802.11g Channel 01

100kHz PSD reference Level

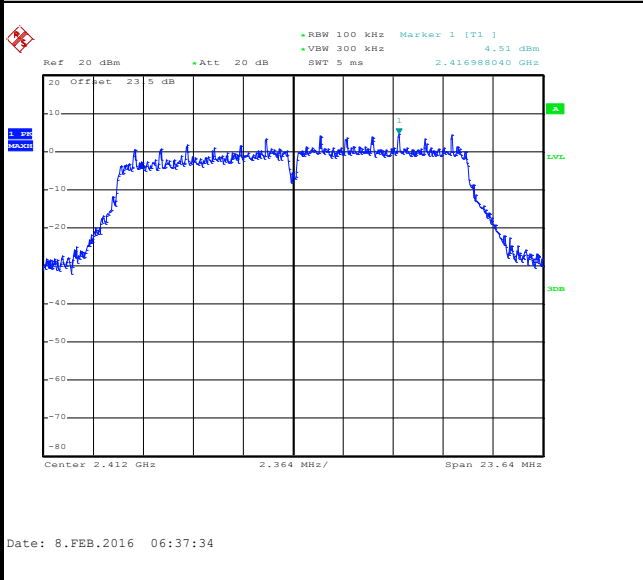

Low Channel Plot

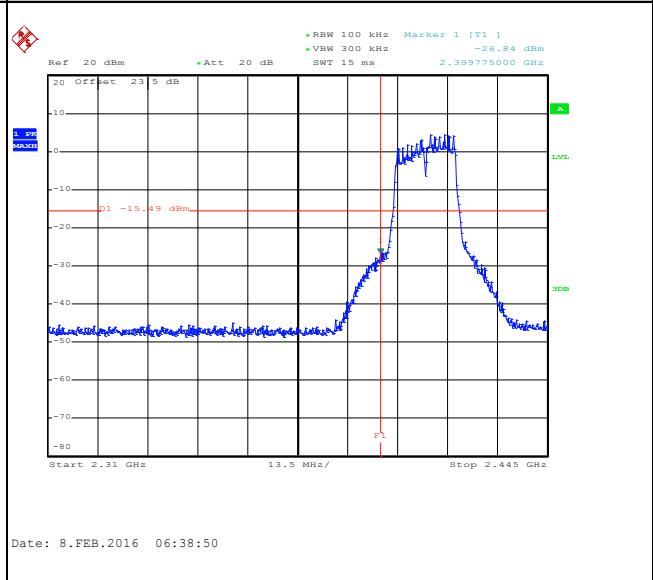

Spurious Emission 30MHz~3GHz

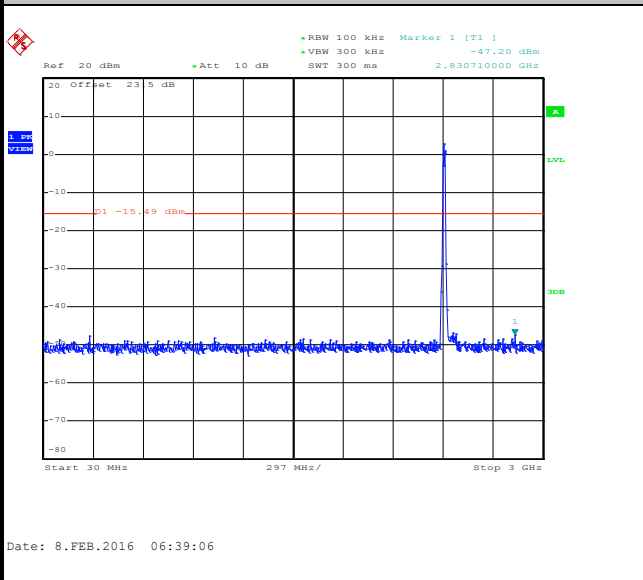

Spurious Emission 2GHz~25GHz

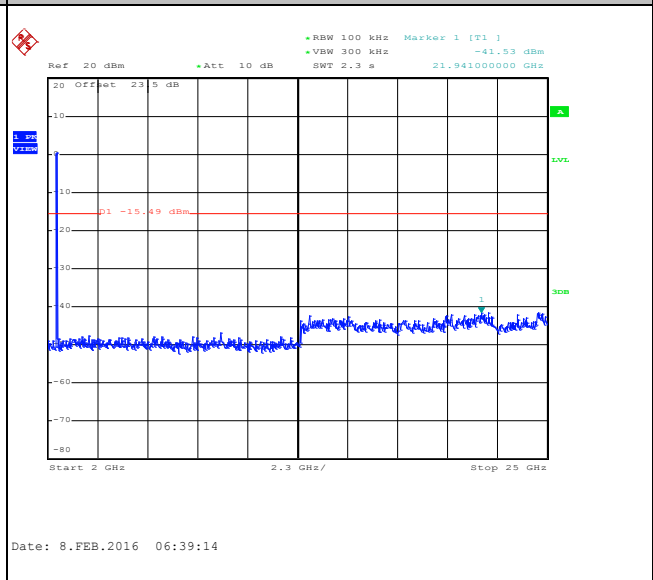



Test Mode :	802.11g	Temperature :	21~24°C
Test Band :	2.4GHz Mid	Relative Humidity :	51~54%
Test Channel :	06	Test Engineer :	Osolemio Chang

WLAN 802.11g Channel 06

100kHz PSD reference Level

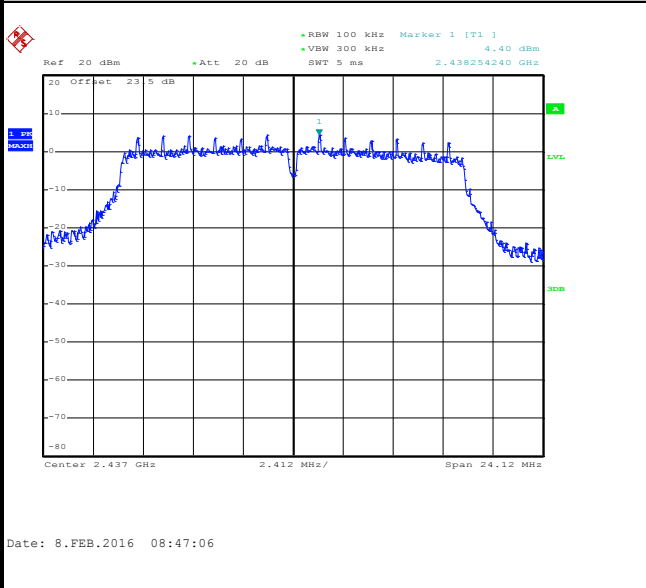

Mid Channel Plot



Spurious Emission 30MHz~3GHz

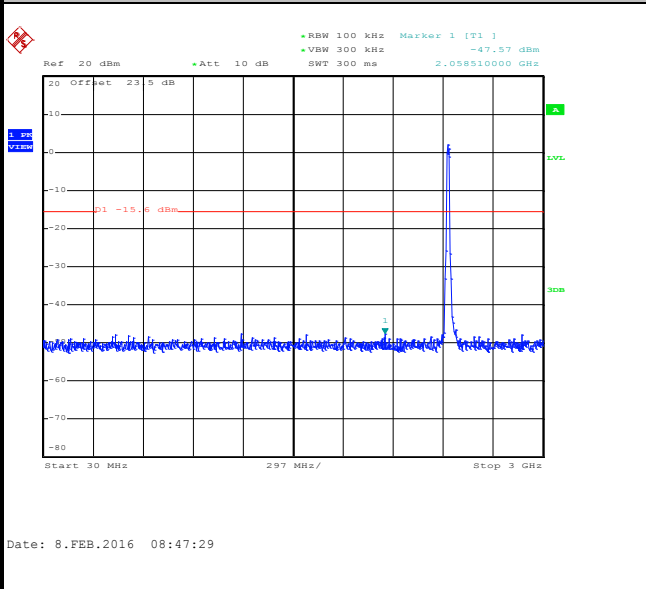

Spurious Emission 2GHz~25GHz

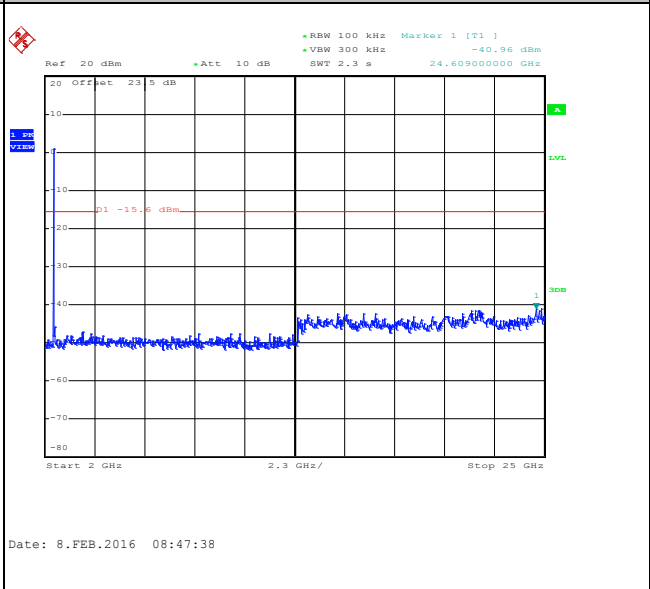



Test Mode :	802.11g	Temperature :	21~24°C
Test Band :	2.4GHz High	Relative Humidity :	51~54%
Test Channel :	11	Test Engineer :	Osolemio Chang

WLAN 802.11g Channel 11

100kHz PSD reference Level

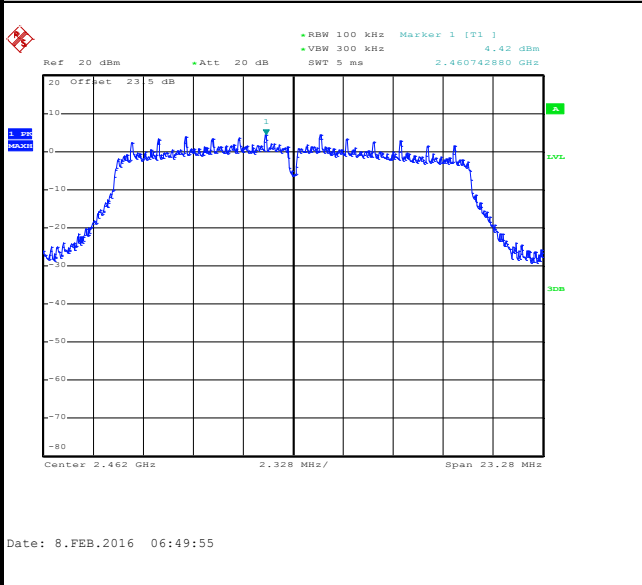

High Channel Plot

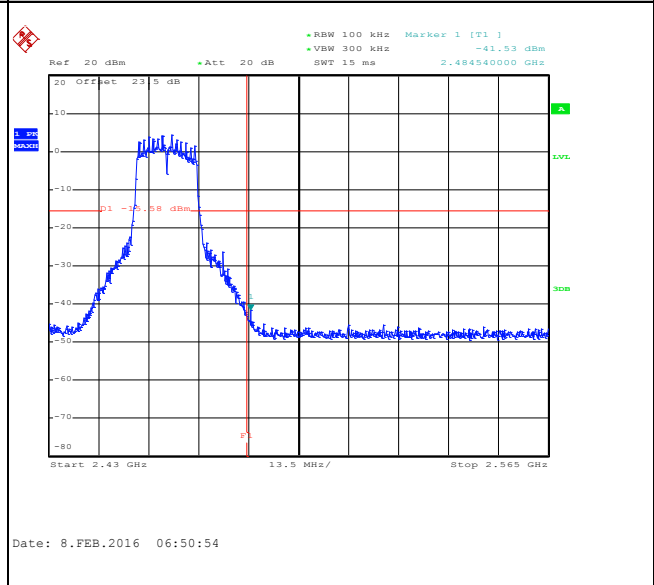

Spurious Emission 30MHz~3GHz

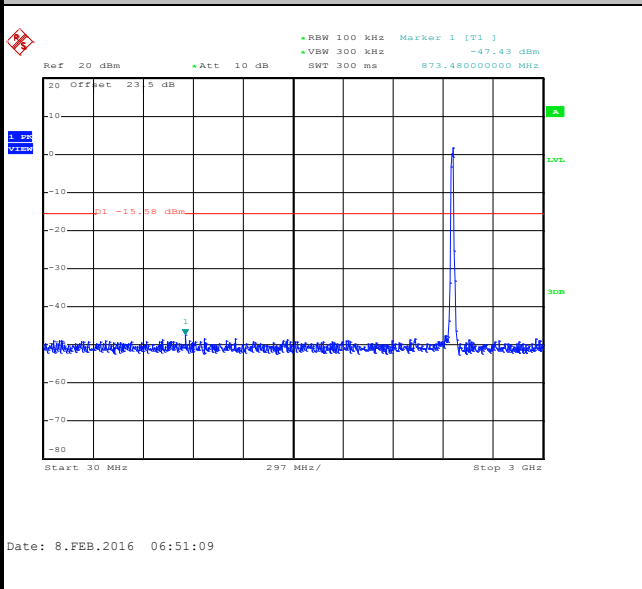

Spurious Emission 2GHz~25GHz

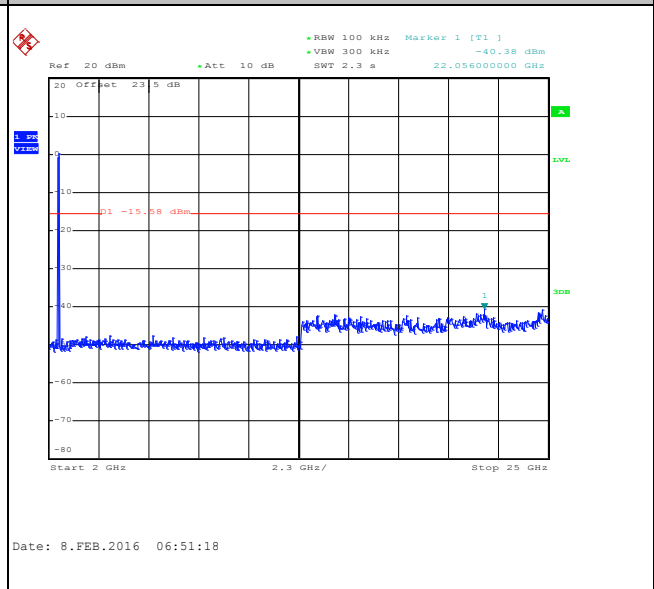



Test Mode :	802.11n HT20	Temperature :	21~24°C
Test Band :	2.4GHz Low	Relative Humidity :	51~54%
Test Channel :	01	Test Engineer :	Osolemio Chang

WLAN 802.11n HT20 Channel 01

100kHz PSD reference Level

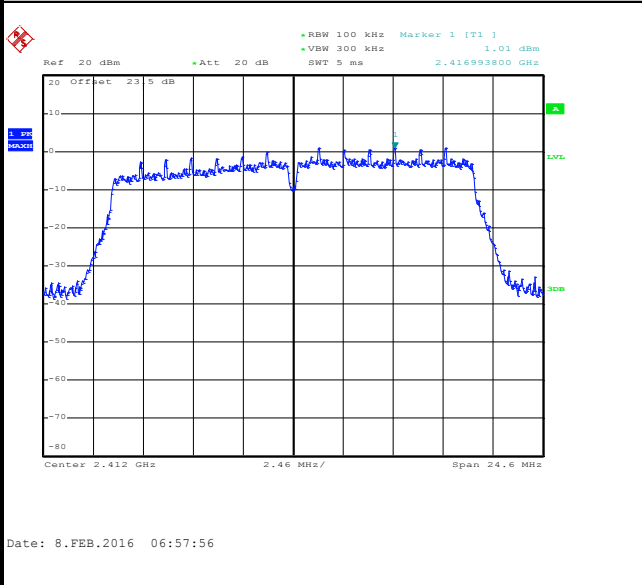

Low Channel Plot

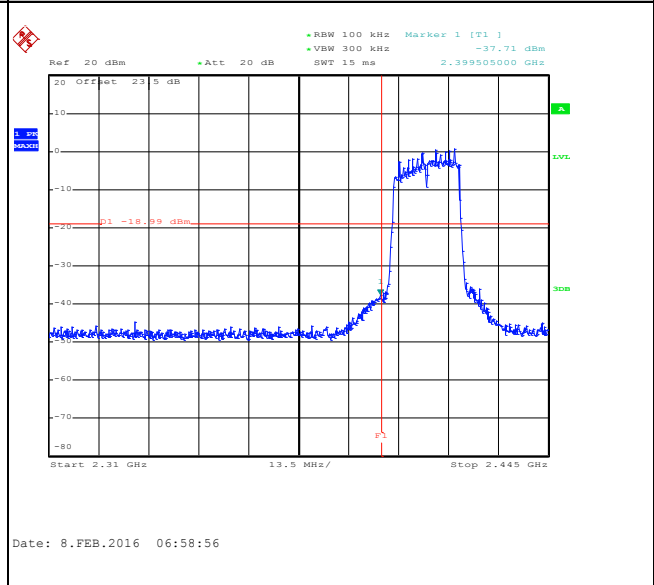

Spurious Emission 30MHz~3GHz

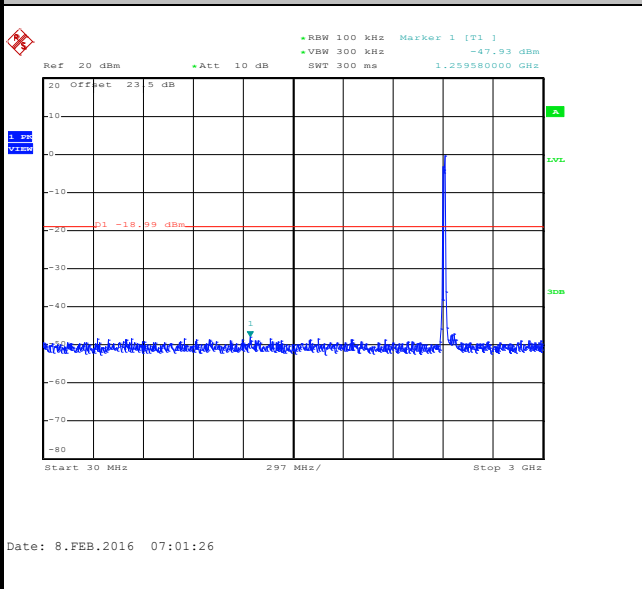

Spurious Emission 2GHz~25GHz

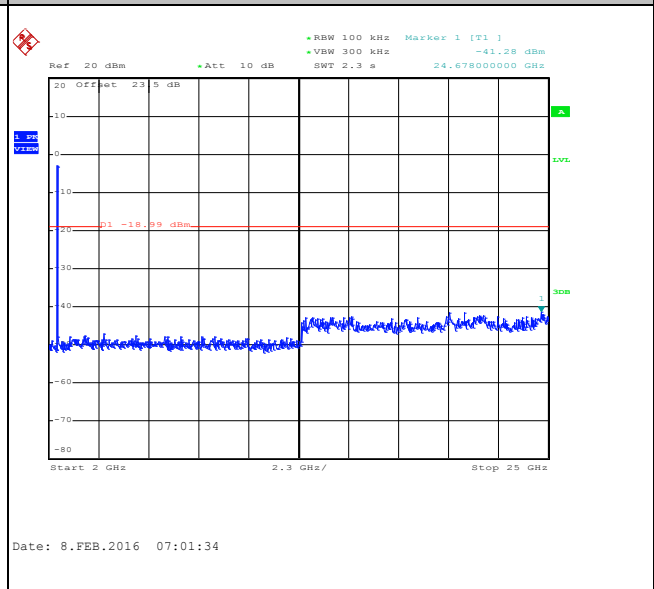



Test Mode :	802.11n HT20	Temperature :	21~24°C
Test Band :	2.4GHz Mid	Relative Humidity :	51~54%
Test Channel :	06	Test Engineer :	Osolemio Chang

WLAN 802.11n HT20 Channel 06

100kHz PSD reference Level

Mid Channel Plot

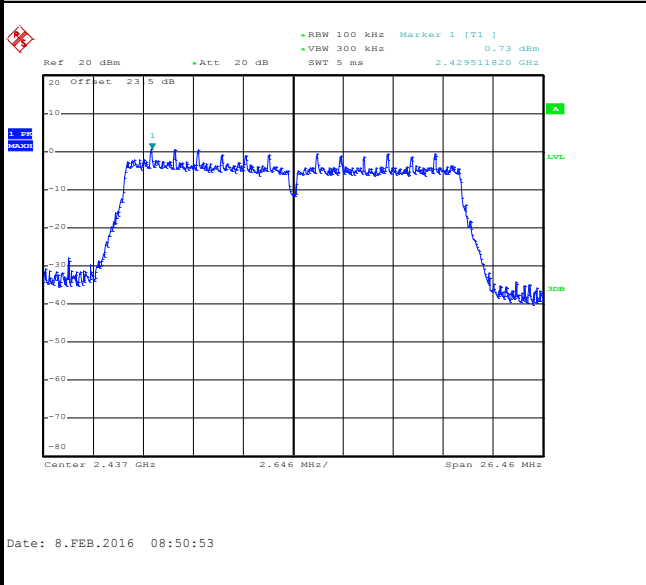

Spurious Emission 30MHz~3GHz

Spurious Emission 2GHz~25GHz

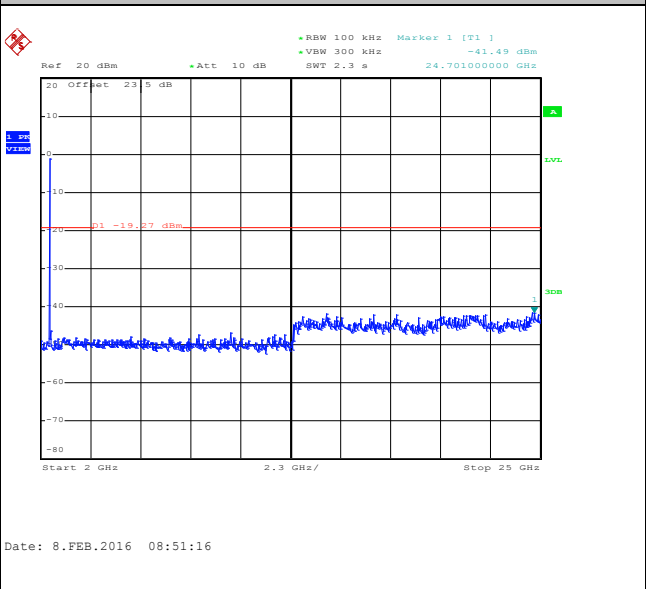
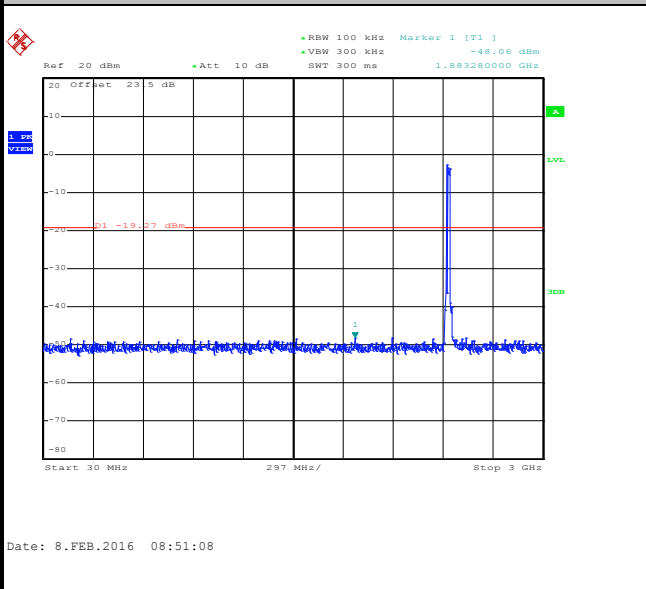



Test Mode :	802.11n HT20	Temperature :	21~24°C
Test Band :	2.4GHz High	Relative Humidity :	51~54%
Test Channel :	11	Test Engineer :	Osolemio Chang

WLAN 802.11n HT20 Channel 11

100kHz PSD reference Level

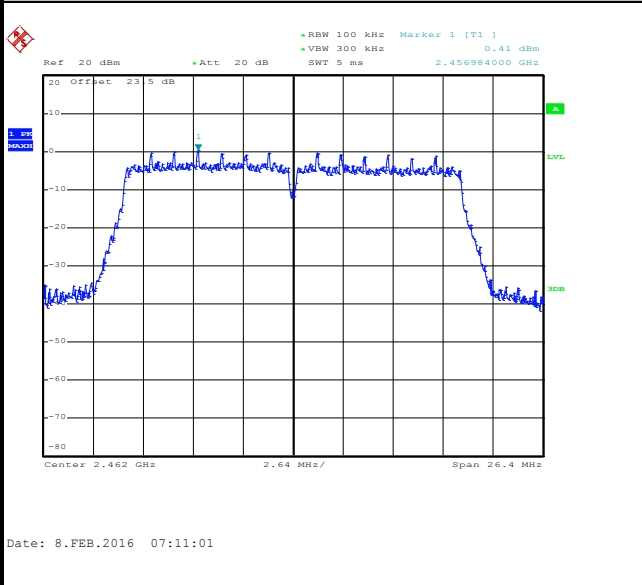

High Channel Plot

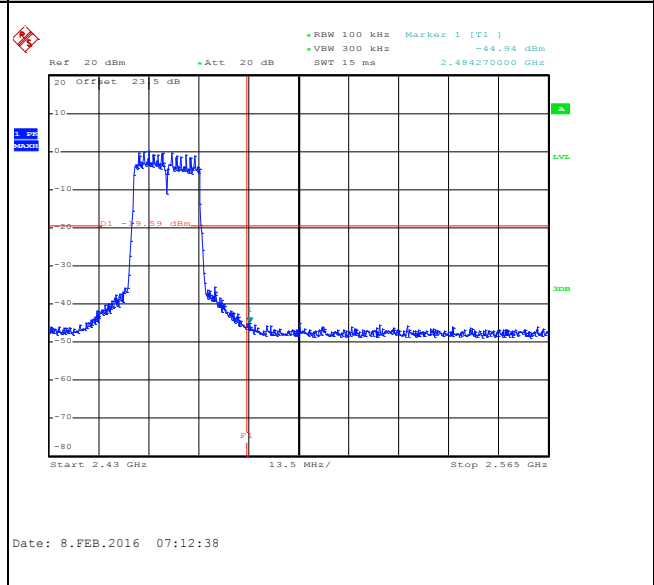

Spurious Emission 30MHz~3GHz

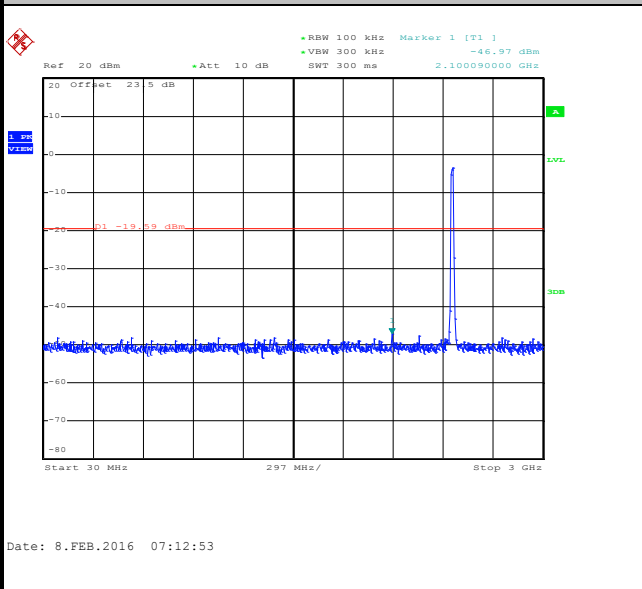

Spurious Emission 2GHz~25GHz

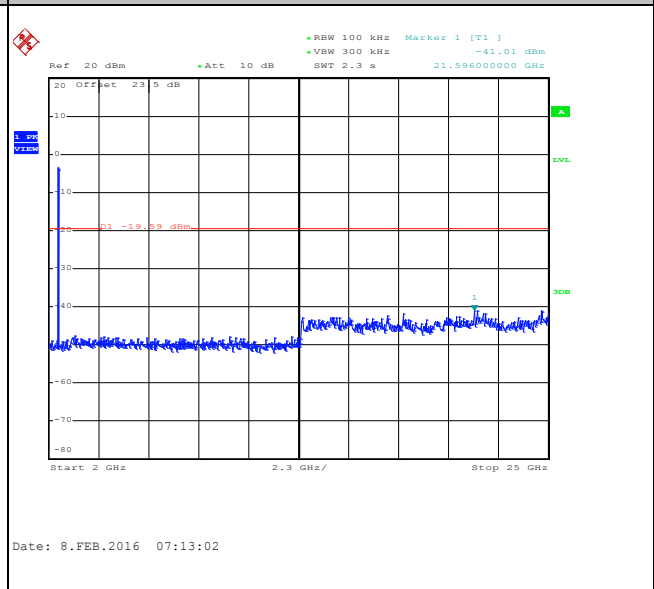



Test Mode :	802.11n HT40	Temperature :	21~24°C
Test Band :	2.4GHz Low	Relative Humidity :	51~54%
Test Channel :	03	Test Engineer :	Osolemio Chang

WLAN 802.11n HT40 Channel 03

100kHz PSD reference Level

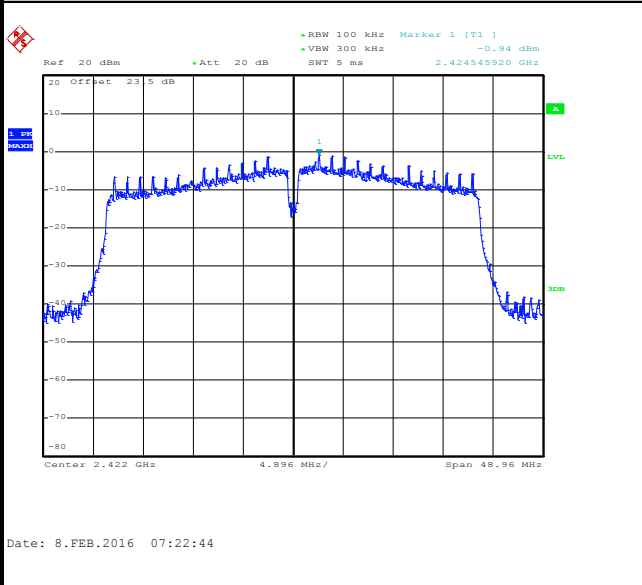

Low Channel Plot

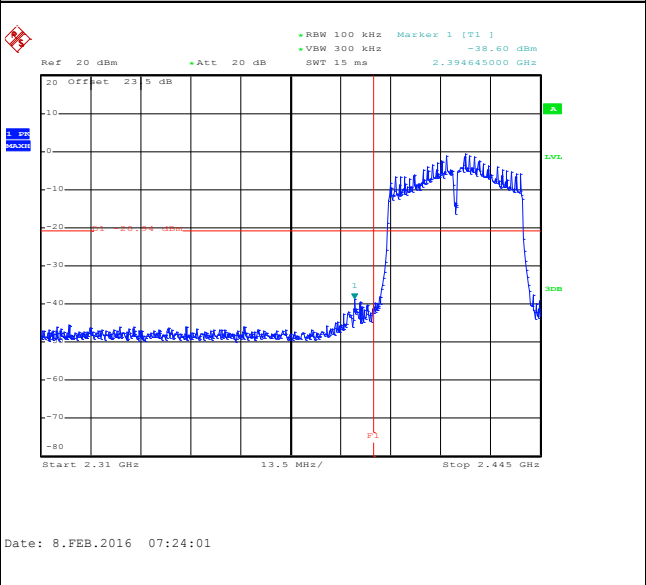

Spurious Emission 30MHz~3GHz

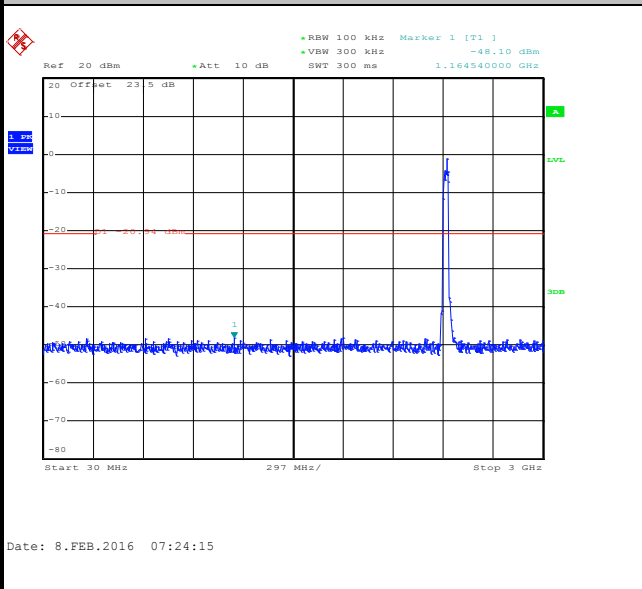

Spurious Emission 2GHz~25GHz

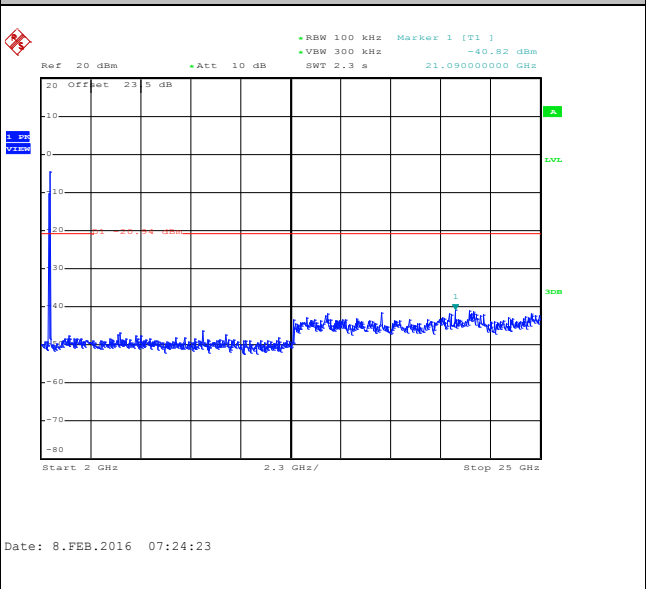



Test Mode :	802.11n HT40	Temperature :	21~24°C
Test Band :	2.4GHz Mid	Relative Humidity :	51~54%
Test Channel :	06	Test Engineer :	Osolemio Chang

WLAN 802.11n HT40 Channel 06

100kHz PSD reference Level

Mid Channel Plot

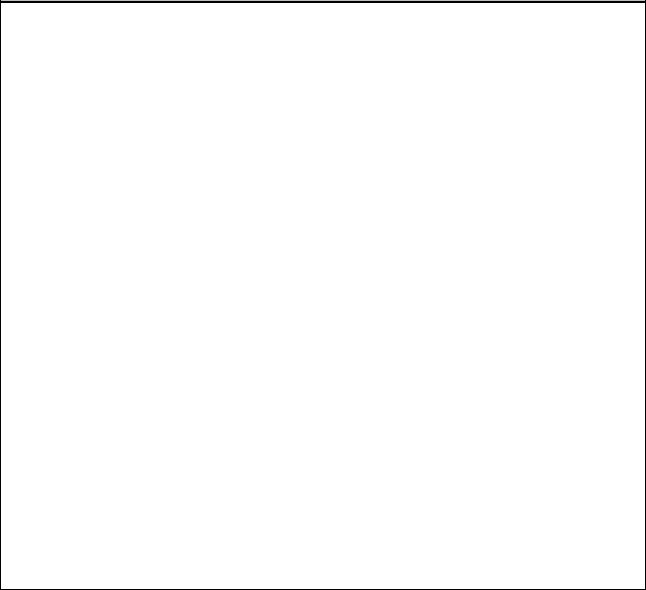
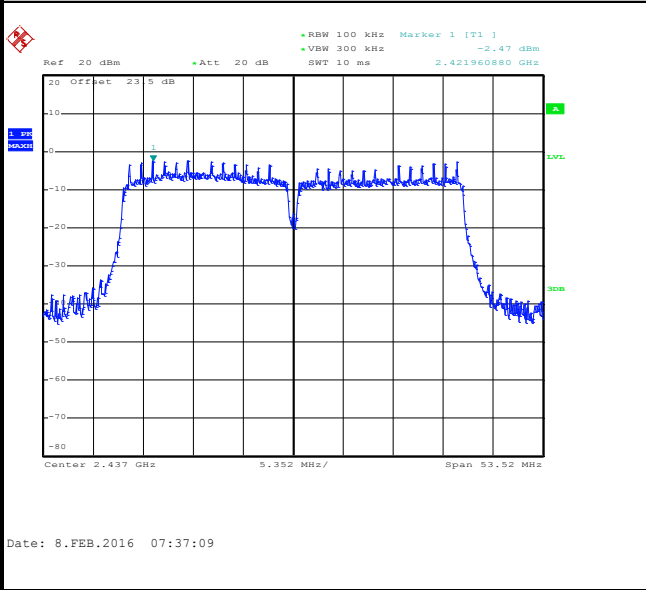

Spurious Emission 30MHz~3GHz

Spurious Emission 2GHz~25GHz

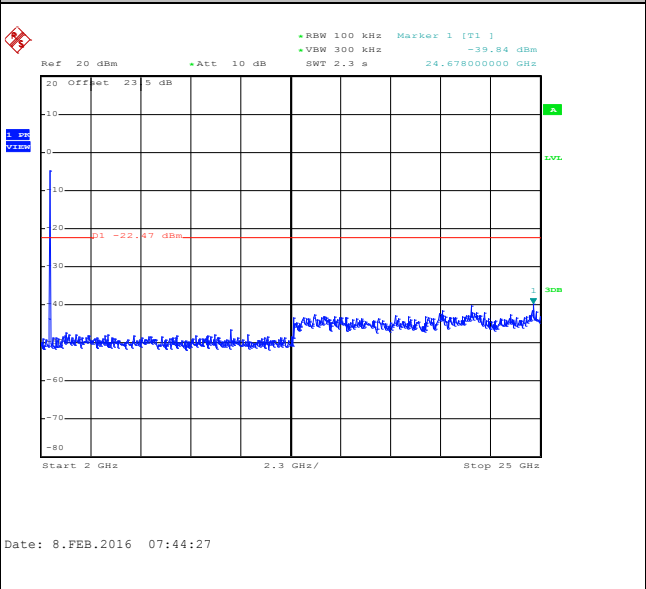
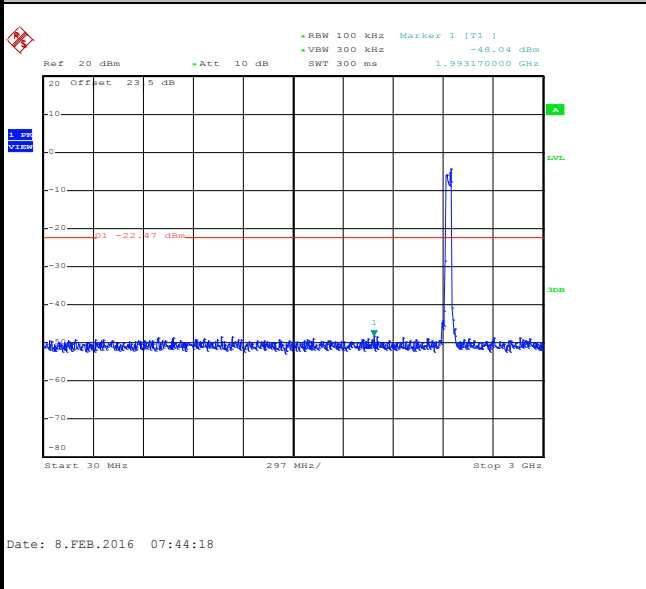



Test Mode :	802.11n HT40	Temperature :	21~24°C
Test Band :	2.4GHz High	Relative Humidity :	51~54%
Test Channel :	09	Test Engineer :	Osolemio Chang

WLAN 802.11n HT40 Channel 09

100kHz PSD reference Level

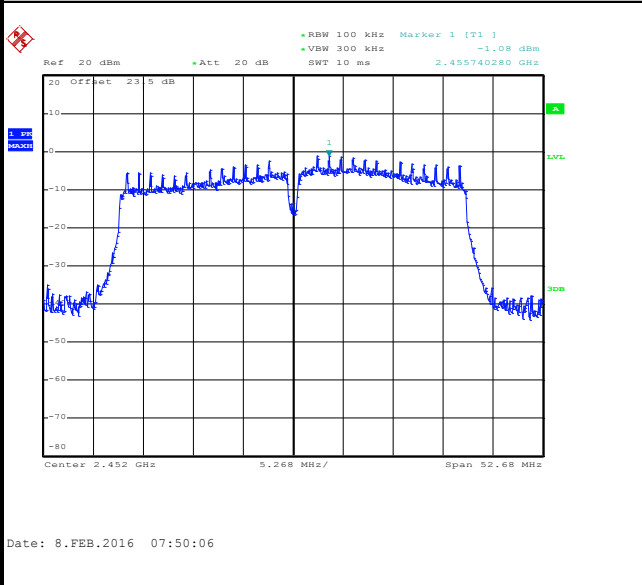

High Channel Plot

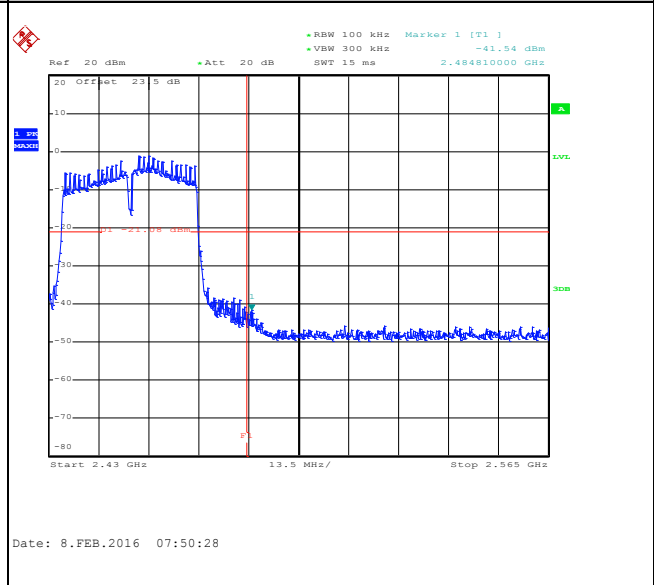

Spurious Emission 30MHz~3GHz

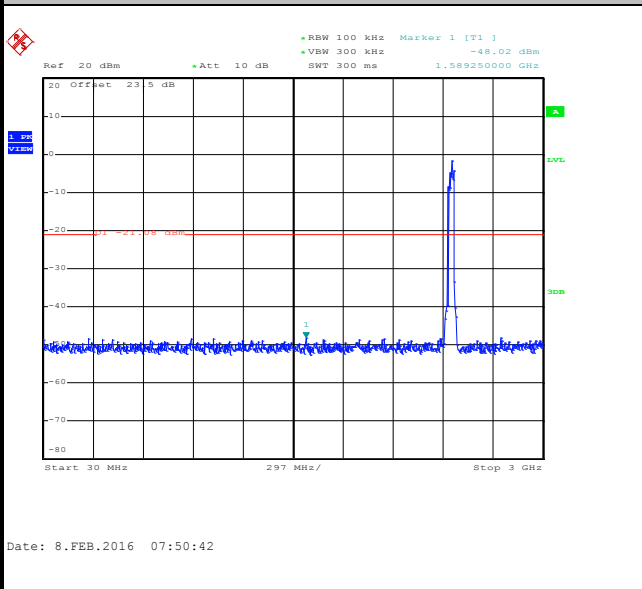

Spurious Emission 2GHz~25GHz

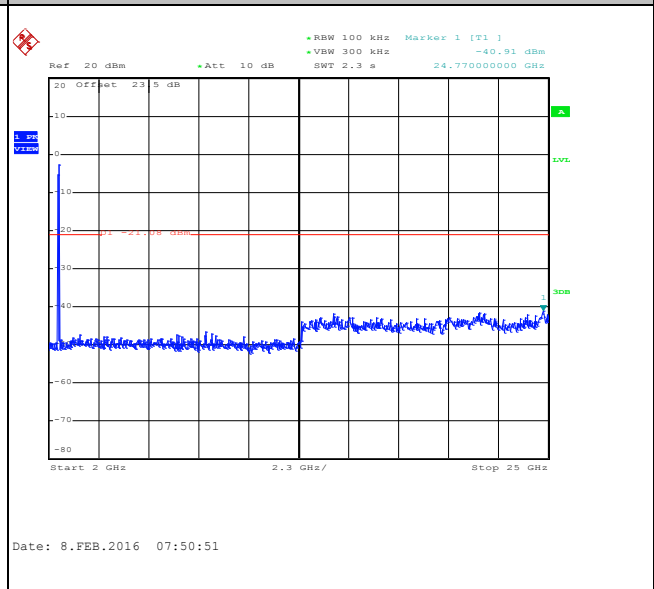



3.5 Radiated Band Edges and Spurious Emission Measurement

3.5.1 Limit of Radiated band edge and Spurious Emission Measurement

In any 100 kHz bandwidth outside the intentional radiator frequency band, all harmonics/spurious must be at least 20 dB below the highest emission level within the authorized band. If the output power of this device was measured by spectrum analyzer, the attenuation under this paragraph shall be 30 dB instead of 20 dB. In addition, radiated emissions which fall in the restricted bands must also comply with the FCC section 15.209 limits as below.

Frequency (MHz)	Field Strength (microvolts/meter)	Measurement Distance (meters)
0.009 – 0.490	2400/F(kHz)	300
0.490 – 1.705	24000/F(kHz)	30
1.705 – 30.0	30	30
30 – 88	100	3
88 – 216	150	3
216 - 960	200	3
Above 960	500	3

3.5.2 Measuring Instruments

The measuring equipment is listed in the section 4 of this test report.



3.5.3 Test Procedures

1. The testing follows FCC KDB Publication No. 558074 D01 DTS Meas. Guidance v03r04.
2. The EUT was arranged to its worst case and then tune the antenna tower (from 1 m to 4 m) and turntable (from 0 degree to 360 degrees) to find the maximum reading. A pre-amp and a high pass filter are used for the test in order to get better signal level.
3. The EUT was placed on a turntable with 0.8 meter for frequency below 1GHz and 1.5 meter for frequency above 1GHz respectively above ground.
4. The EUT was set 3 meters from the interference receiving antenna, which was mounted on the top of a variable height antenna tower.
5. Corrected Reading: Antenna Factor + Cable Loss + Read Level - Preamp Factor = Level
6. For measurement below 1GHz, If the emission level of the EUT measured by the peak detector is 3 dB lower than the applicable limit, the peak emission level will be reported. Otherwise, the emission measurement will be repeated using the quasi-peak detector and reported.
7. Use the following spectrum analyzer settings:
 - (1) Span shall wide enough to fully capture the emission being measured;
 - (2) Set RBW=100 kHz for $f < 1 \text{ GHz}$; $\text{VBW} \geq \text{RBW}$; Sweep = auto; Detector function = peak; Trace = max hold;
 - (3) Set RBW = 1 MHz, VBW= 3MHz for $f \geq 1 \text{ GHz}$ for peak measurement.

For average measurement:

 - $\text{VBW} = 10 \text{ Hz}$, when duty cycle is no less than 98 percent.
 - $\text{VBW} \geq 1/T$, when duty cycle is less than 98 percent where T is the minimum transmission duration over which the transmitter is on and is transmitting at its maximum power control level for the tested mode of operation.

Band	Duty Cycle(%)	T(μs)	1/T(kHz)	VBW Setting
802.11b	100	-	-	10Hz
802.11g	97.22	1400	0.714285714	1kHz
2.4GHz 802.11n HT20	97.02	1300	0.769230769	1kHz
2.4GHz 802.11n HT40	94.74	648	1.543209877	3kHz

3.5.4 Test Setup

For radiated emissions below 30MHz

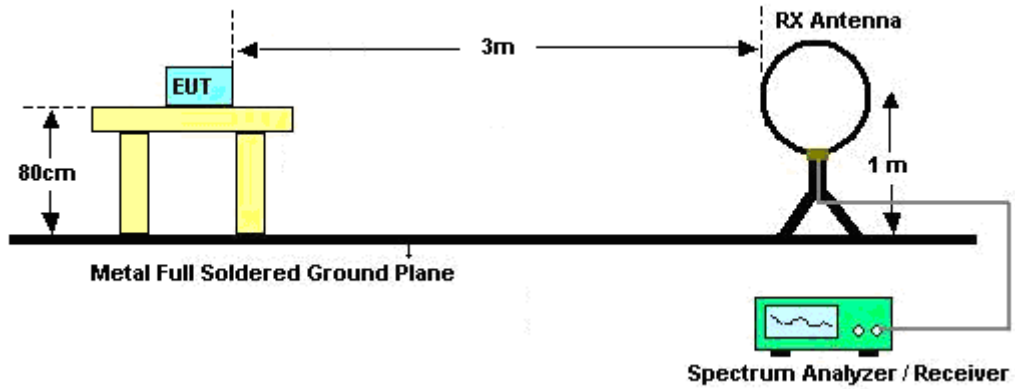

For radiated emissions from 30MHz to 1GHz

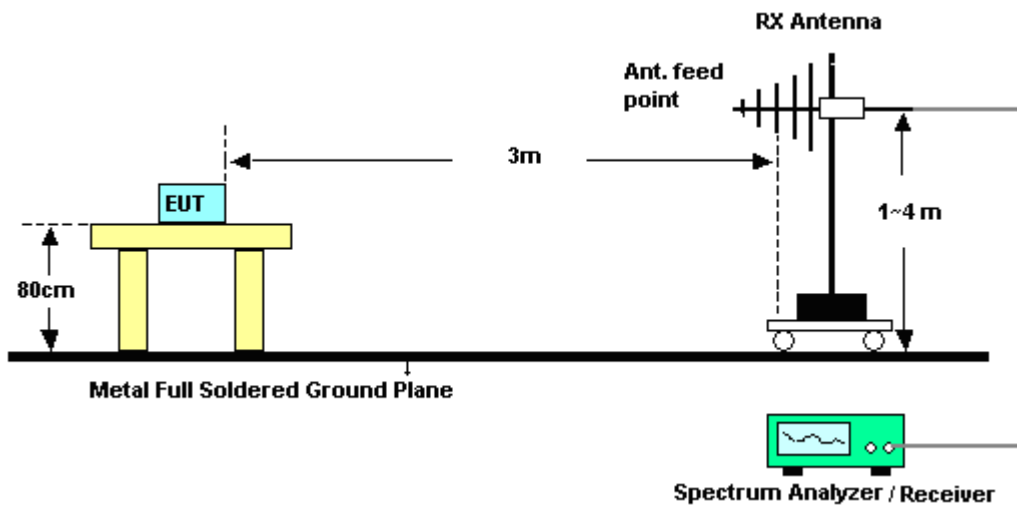

For radiated emissions above 1GHz

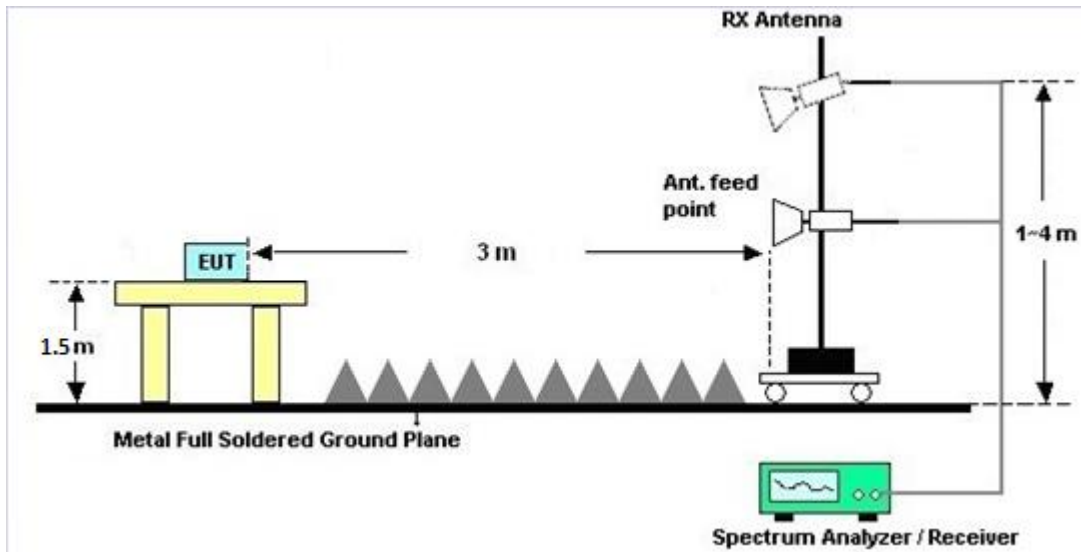

3.5.5 Test Results of Radiated Spurious Emissions (9kHz ~ 30MHz)

The low frequency, which started from 9 kHz to 30MHz, was pre-scanned and the result which was 20dB lower than the limit line per 15.31(o) was not reported.

3.5.6 Test Result of Radiated Spurious at Band Edges

Please refer to Appendix B and C.

3.5.7 Test Result of Radiated Spurious Emission (30MHz ~ 10th Harmonic)

Please refer to Appendix B and C.



3.5.8 Duty Cycle

802.11b

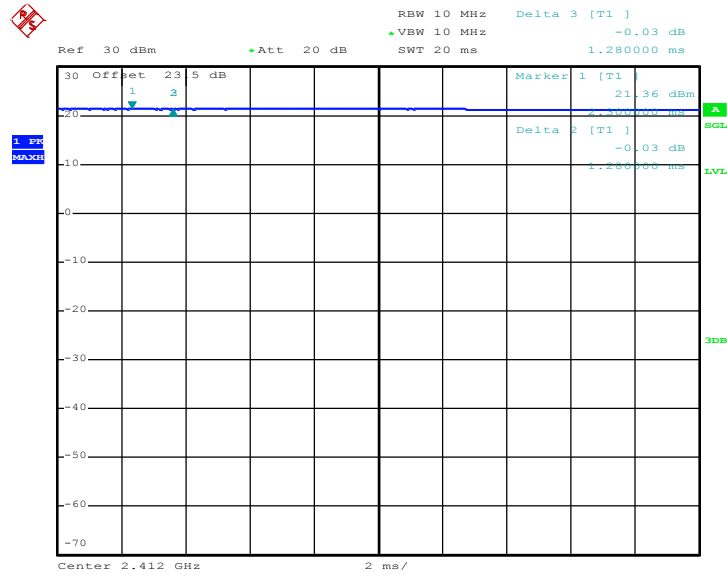

Date: 5.FEB.2016 16:20:59

802.11g

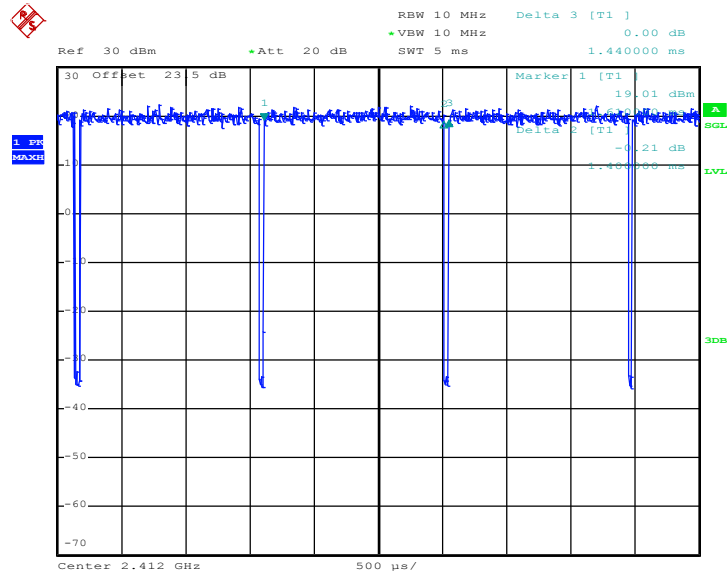

Date: 5.FEB.2016 16:21:59



802.11n HT20

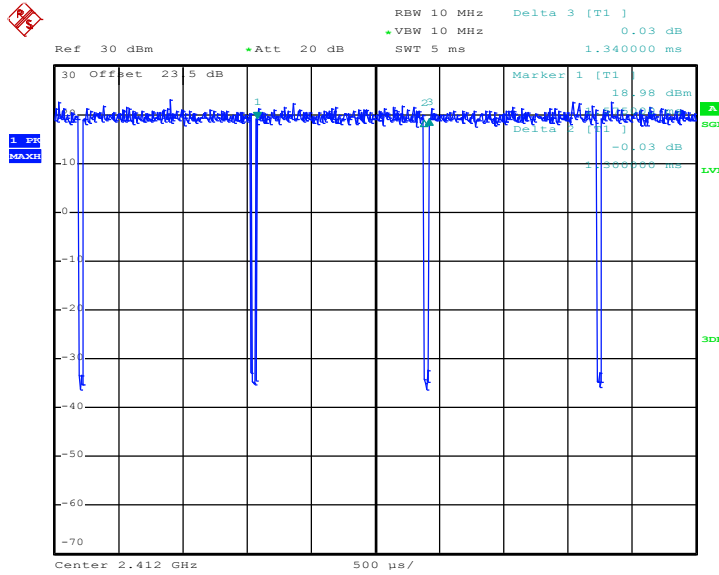

Date: 5.FEB.2016 16:24:01

802.11n HT40

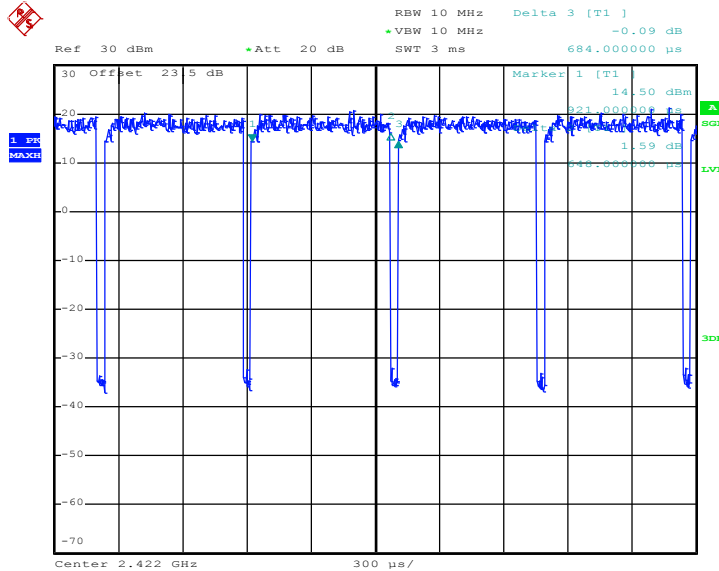

Date: 5.FEB.2016 16:25:05



3.6 AC Conducted Emission Measurement

3.6.1 Limit of AC Conducted Emission

For equipment that is designed to be connected to the public utility (AC) power line, the radio frequency voltage that is conducted back onto the AC power line on any frequency or frequencies within the band 150 kHz to 30 MHz shall not exceed the limits in the following table.

Frequency of Emission (MHz)	Conducted Limit (dB μ V)	
	Quasi-Peak	Average
0.15-0.5	66 to 56*	56 to 46*
0.5-5	56	46
5-30	60	50

*Decreases with the logarithm of the frequency.

3.6.2 Measuring Instruments

The measuring equipment is listed in the section 4 of this test report.

3.6.3 Test Procedures

1. The EUT was placed 0.4 meter from the conducting wall of the shielding room, and it was kept at least 80 centimeters from any other grounded conducting surface.
2. Connect EUT to the power mains through a line impedance stabilization network (LISN).
3. All the support units are connecting to the other LISN.
4. The LISN provides 50 ohm coupling impedance for the measuring instrument.
5. The FCC states that a 50 ohm, 50 microhenry LISN should be used.
6. Both sides of AC line were checked for maximum conducted interference.
7. The frequency range from 150 kHz to 30 MHz was searched.
8. Set the test-receiver system to Peak Detect Function and specified bandwidth (IF bandwidth = 9kHz) with Maximum Hold Mode.

3.6.4 Test Setup

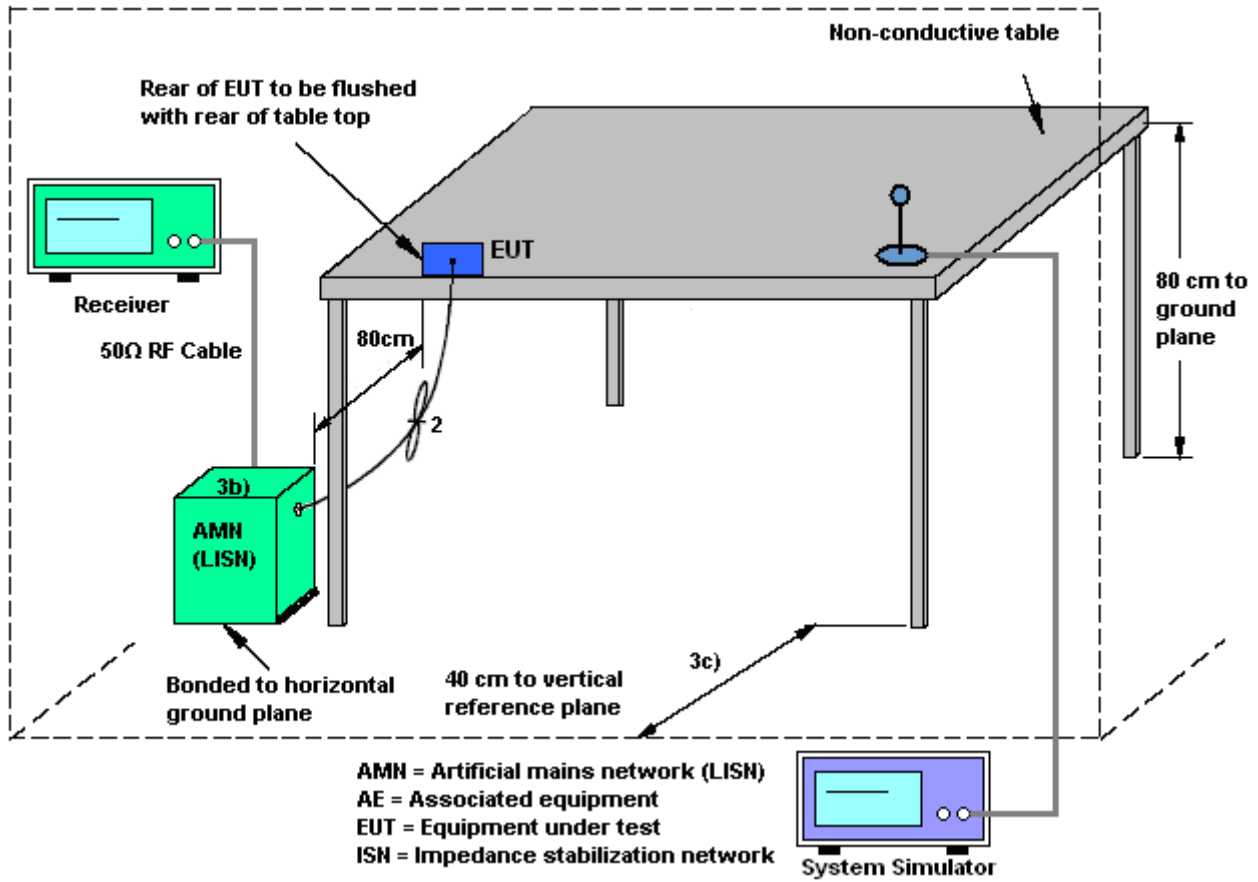

3.6.5 Test Result of AC Conducted Emission

Test Mode :	Mode 1	Temperature :	24~25°C
Test Engineer :	Kai-Chun Chu	Relative Humidity :	47~48%
Test Voltage :	120Vac / 60Hz	Phase :	Line
Function Type :	GSM1900 Idle + Bluetooth Link + WLAN (2.4GHz) Link + MP3 + Earphone + Battery 2 + USB Cable (Charging from Adapter)		

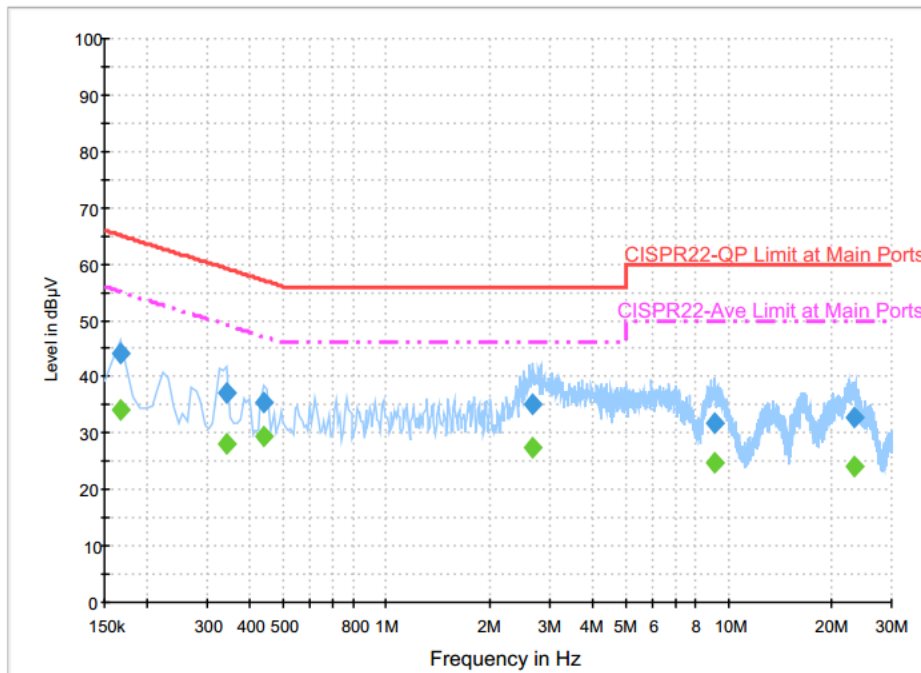

Final Result : Quasi-Peak

Frequency (MHz)	Quasi-Peak (dBµV)	Filter	Line	Corr. (dB)	Margin (dB)	Limit (dBµV)
0.166000	44.1	Off	L1	19.6	21.1	65.2
0.342000	37.2	Off	L1	19.6	22.0	59.2
0.438000	35.4	Off	L1	19.6	21.7	57.1
2.678000	35.2	Off	L1	19.4	20.8	56.0
9.174000	31.7	Off	L1	19.7	28.3	60.0
23.438000	32.8	Off	L1	19.9	27.2	60.0

Final Result : Average

Frequency (MHz)	Average (dBµV)	Filter	Line	Corr. (dB)	Margin (dB)	Limit (dBµV)
0.166000	34.2	Off	L1	19.6	21.0	55.2
0.342000	28.2	Off	L1	19.6	21.0	49.2
0.438000	29.4	Off	L1	19.6	17.7	47.1
2.678000	27.3	Off	L1	19.4	18.7	46.0
9.174000	24.8	Off	L1	19.7	25.2	50.0
23.438000	24.2	Off	L1	19.9	25.8	50.0



Test Mode :	Mode 1	Temperature :	24~25°C
Test Engineer :	Kai-Chun Chu	Relative Humidity :	47~48%
Test Voltage :	120Vac / 60Hz	Phase :	Neutral
Function Type :	GSM1900 Idle + Bluetooth Link + WLAN (2.4GHz) Link + MP3 + Earphone + Battery 2 + USB Cable (Charging from Adapter)		

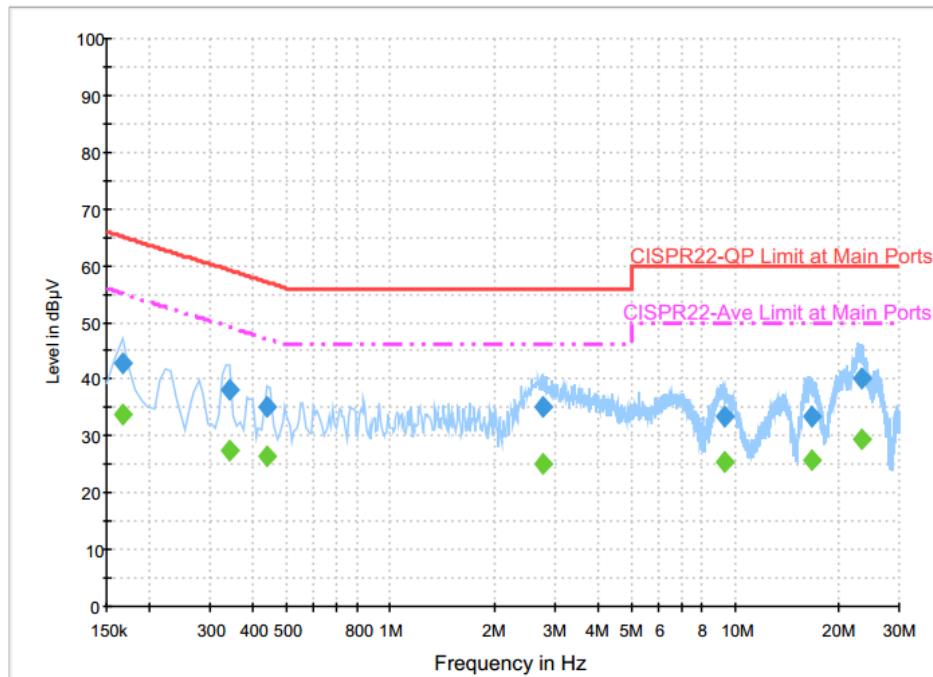

Final Result : Quasi-Peak

Frequency (MHz)	Quasi-Peak (dBµV)	Filter	Line	Corr. (dB)	Margin (dB)	Limit (dBµV)
0.166000	43.0	Off	N	19.6	22.2	65.2
0.342000	38.2	Off	N	19.6	21.0	59.2
0.438000	35.2	Off	N	19.6	21.9	57.1
2.758000	35.2	Off	N	19.5	20.8	56.0
9.286000	33.4	Off	N	19.8	26.6	60.0
16.774000	33.5	Off	N	19.9	26.5	60.0
23.262000	40.0	Off	N	20.0	20.0	60.0

Final Result : Average

Frequency (MHz)	Average (dBµV)	Filter	Line	Corr. (dB)	Margin (dB)	Limit (dBµV)
0.166000	33.7	Off	N	19.6	21.5	55.2
0.342000	27.5	Off	N	19.6	21.7	49.2
0.438000	26.4	Off	N	19.6	20.7	47.1
2.758000	25.1	Off	N	19.5	20.9	46.0
9.286000	25.3	Off	N	19.8	24.7	50.0
16.774000	25.7	Off	N	19.9	24.3	50.0
23.262000	29.3	Off	N	20.0	20.7	50.0



3.7 Antenna Requirements

3.7.1 Standard Applicable

If directional gain of transmitting antennas is greater than 6dBi, the power shall be reduced by the same level in dB comparing to gain minus 6dBi. For the fixed point-to-point operation, the power shall be reduced by one dB for every 3 dB that the directional gain of the antenna exceeds 6 dBi. The use of a permanently attached antenna or of an antenna that uses a unique coupling to the intentional radiator shall be considered sufficient to comply with the FCC rule.

3.7.2 Antenna Anti-Replacement Construction

An embedded-in antenna design is used.

3.7.3 Antenna Gain

The antenna peak gain of EUT is less than 6 dBi. Therefore, it is not necessary to reduce maximum peak output power limit.



4 List of Measuring Equipment

Instrument	Manufacturer	Model No.	Serial No.	Characteristics	Calibration Date	Test Date	Due Date	Remark
Hygrometer	Testo	608-H2	41410069	N/A	Aug. 27, 2015	Feb. 05, 2016 ~ Feb. 08, 2016	Aug. 26, 2016	Conducted (TH05-HY)
Power Meter	Anritsu	ML2495A	1132003	300MHz~40GHz	Aug. 12, 2015	Feb. 05, 2016 ~ Feb. 08, 2016	Aug. 11, 2016	Conducted (TH05-HY)
Power Sensor	Anritsu	MA2411B	1126017	300MHz~40GHz	Aug. 12, 2015	Feb. 05, 2016 ~ Feb. 08, 2016	Aug. 11, 2016	Conducted (TH05-HY)
Spectrum Analyzer	Rohde & Schwarz	FSP40	100057	9kHz-40GHz	Nov. 23, 2015	Feb. 05, 2016 ~ Feb. 08, 2016	Nov. 22, 2016	Conducted (TH05-HY)
RF Cable	JYEBAO	K30K30-5003-1.5M40	N/A	0.1MHz~40GHz	Mar. 18, 2015	Feb. 05, 2016 ~ Feb. 08, 2016	Mar. 17, 2016	Conducted (TH05-HY)
AC Power Source	ChainTek	APC-1000W	N/A	N/A	N/A	Feb. 10, 2016	N/A	Conduction (CO05-HY)
EMI Test Receiver	Rohde & Schwarz	ESCI 7	100724	9kHz~7GHz	Aug. 26, 2015	Feb. 10, 2016	Aug. 25, 2016	Conduction (CO05-HY)
Hygrometer	Testo	608-H1	34913912	N/A	Apr. 20, 2015	Feb. 10, 2016	Apr. 19, 2016	Conduction (CO05-HY)
LISN	Rohde & Schwarz	ENV216	100080	9kHz~30MHz	Dec. 02, 2015	Feb. 10, 2016	Dec. 01, 2016	Conduction (CO05-HY)
LF Cable	HUBER + SUHNER	RG-214/U	LF01	N/A	Jan. 06, 2016	Feb. 10, 2016	Jan. 05, 2017	Conduction (CO05-HY)
Loop Antenna	Rohde & Schwarz	HFH2-Z2	100315	9 kHz~30 MHz	Sep. 02, 2015	Feb. 06, 2016~ Feb. 09, 2016	Sep. 01, 2016	Radiation (03CH11-HY)
Horn Antenna	SCHWARZBECK	BBHA 9170	BBHA9170584	18GHz- 40GHz	Nov. 02, 2015	Feb. 06, 2016~ Feb. 09, 2016	Nov. 01, 2016	Radiation (03CH11-HY)
Bilog Antenna	TESEQ	CBL 6111D	35414	30MHz~1GHz	Nov. 17, 2015	Feb. 06, 2016~ Feb. 09, 2016	Nov. 16, 2016	Radiation (03CH11-HY)
Horn Antenna	SCHWARZBECK	BBHA 9120 D	9120D-1326	1GHz ~ 18GHz	Oct. 08, 2015	Feb. 06, 2016~ Feb. 09, 2016	Oct. 07, 2016	Radiation (03CH11-HY)
Preamplifier	MITEQ	JS44-18004000-33-8P	1840917	18GHz ~ 40GHz	Jun. 02, 2015	Feb. 06, 2016~ Feb. 09, 2016	Jun. 01, 2016	Radiation (03CH11-HY)
Amplifier	SONOMA	310N	187312	9kHz~1GHz	Nov. 20, 2015	Feb. 06, 2016~ Feb. 09, 2016	Nov. 19, 2016	Radiation (03CH11-HY)
Preamplifier	Keysight	83017A	MY53270080	1GHz~26.5GHz	Nov. 19, 2015	Feb. 06, 2016~ Feb. 09, 2016	Nov. 18, 2016	Radiation (03CH11-HY)
Preamplifier	MITEQ	AMF-7D-00101800-30-10P	1902247	1GHz~18GHz	Jul. 01, 2015	Feb. 06, 2016~ Feb. 09, 2016	Jun. 30, 2016	Radiation (03CH11-HY)
Hygrometer	TECPEL	DTN-303B	TP140325	N/A	Nov. 17, 2015	Feb. 06, 2016~ Feb. 09, 2016	Nov. 16, 2016	Radiation (03CH11-HY)
Spectrum Analyzer	Keysight	N9010A	MY54200486	10Hz ~ 44GHz	Sep. 24, 2015	Feb. 06, 2016~ Feb. 09, 2016	Sep. 23, 2016	Radiation (03CH11-HY)
EMI Test Receiver	Agilent	N9038A(MXE)	MY53290053	20Hz to 26.5GHz	Jan. 20, 2016	Feb. 06, 2016~ Feb. 09, 2016	Jan. 19, 2017	Radiation (03CH11-HY)



Instrument	Manufacturer	Model No.	Serial No.	Characteristics	Calibration Date	Test Date	Due Date	Remark
RF Cable	HUBER + SUHNER	SUCOFLEX 104	MY9837/4 MY28419/ 4MY28654 /4	9KHz~30MHz	Sep. 14, 2015	Feb. 06, 2016~ Feb. 09, 2016	Sep. 13, 2016	Radiation (03CH11-HY)
RF Cable	HUBER + SUHNER	SUCOFLEX 104	MY9837/4 MY28419/ 4MY28654 /4	30MHz~40GHz	Nov. 05, 2015	Feb. 06, 2016~ Feb. 09, 2016	Nov. 04, 2016	Radiation (03CH11-HY)
Antenna Mast	EMEC	AM-BS-4500-B	N/A	1~4m	N/A	Feb. 06, 2016~ Feb. 09, 2016	N/A	Radiation (03CH11-HY)
Turn Table	EMEC	TT 2000	N/A	0-360 degree	N/A	Feb. 06, 2016~ Feb. 09, 2016	N/A	Radiation (03CH11-HY)
Filter	Wainwright	WLKS1200-8 SS	SN3	1.2G Low Pass	Oct. 01, 2015	Feb. 06, 2016~ Feb. 09, 2016	Sep. 30, 2016	Radiation (03CH11-HY)
Filter	Microwave	H3G018G1	SN477220	3.0G High Pass	Oct. 01, 2015	Feb. 06, 2016~ Feb. 09, 2016	Sep. 30, 2016	Radiation (03CH11-HY)



5 Uncertainty of Evaluation

Uncertainty of Conducted Emission Measurement (150kHz ~ 30MHz)

Measuring Uncertainty for a Level of Confidence of 95% ($U = 2Uc(y)$)	2.26
---	------

Uncertainty of Radiated Emission Measurement (30 MHz ~ 1000 MHz)

Measuring Uncertainty for a Level of Confidence of 95% ($U = 2Uc(y)$)	4.90
---	------



Appendix A. Conducted Test Results

A1 - DTS Part

Test Engineer:	Osolemio Chang	Temperature:	21~24	°C
Test Date:	2016/2/5 ~ 2016/2/8	Relative Humidity:	51~54	%

TEST RESULTS DATA
6dB and 99% Occupied Bandwidth

2.4GHz Band								
Mod.	Data Rate	N _{TX}	CH.	Freq. (MHz)	99% Occupied BW (MHz)	6dB BW (MHz)	6dB BW Limit (MHz)	Pass/Fail
11b	1Mbps	1	1	2412	13.00	9.56	0.50	Pass
11b	1Mbps	1	6	2437	13.45	10.08	0.50	Pass
11b	1Mbps	1	11	2462	13.10	9.60	0.50	Pass
11g	6Mbps	1	1	2412	17.60	15.76	0.50	Pass
11g	6Mbps	1	6	2437	17.95	16.08	0.50	Pass
11g	6Mbps	1	11	2462	17.35	15.52	0.50	Pass
HT20	MCS0	1	1	2412	18.50	16.40	0.50	Pass
HT20	MCS0	1	6	2437	18.70	17.64	0.50	Pass
HT20	MCS0	1	11	2462	18.45	17.60	0.50	Pass
HT40	MCS0	1	3	2422	35.80	32.64	0.50	Pass
HT40	MCS0	1	6	2437	36.50	35.68	0.50	Pass
HT40	MCS0	1	9	2452	36.20	35.12	0.50	Pass

TEST RESULTS DATA
Peak Power Table

2.4GHz Band										
Mod.	Data Rate	N _{TX}	CH.	Freq. (MHz)	Peak Conducted Power (dBm)	Conducted Power Limit (dBm)	DG (dBi)	EIRP Power (dBm)	EIRP Power Limit (dBm)	Pass /Fail
11b	1Mbps	1	1	2412	20.75	30.00	-0.30	20.45	36.00	Pass
11b	1Mbps	1	6	2437	20.49	30.00	-0.30	20.19	36.00	Pass
11b	1Mbps	1	11	2462	20.52	30.00	-0.30	20.22	36.00	Pass
11g	6Mbps	1	1	2412	22.61	30.00	-0.30	22.31	36.00	Pass
11g	6Mbps	1	6	2437	22.62	30.00	-0.30	22.32	36.00	Pass
11g	6Mbps	1	11	2462	22.50	30.00	-0.30	22.20	36.00	Pass
HT20	MCS0	1	1	2412	20.98	30.00	-0.30	20.68	36.00	Pass
HT20	MCS0	1	6	2437	20.67	30.00	-0.30	20.37	36.00	Pass
HT20	MCS0	1	11	2462	20.96	30.00	-0.30	20.66	36.00	Pass
HT40	MCS0	1	3	2422	20.99	30.00	-0.30	20.69	36.00	Pass
HT40	MCS0	1	6	2437	20.89	30.00	-0.30	20.59	36.00	Pass
HT40	MCS0	1	9	2452	20.50	30.00	-0.30	20.20	36.00	Pass

TEST RESULTS DATA
Average Power Table
(Reporting Only)

2.4GHz Band						
Mod.	Data Rate	N _{TX}	CH.	Freq. (MHz)	Duty Factor (dB)	Average Conducted Power (dBm)
11b	1Mbps	1	1	2412	0.00	17.95
11b	1Mbps	1	6	2437	0.00	17.92
11b	1Mbps	1	11	2462	0.00	17.83
11g	6Mbps	1	1	2412	0.12	14.70
11g	6Mbps	1	6	2437	0.12	14.90
11g	6Mbps	1	11	2462	0.12	14.77
HT20	MCS0	1	1	2412	0.13	11.48
HT20	MCS0	1	6	2437	0.13	11.46
HT20	MCS0	1	11	2462	0.13	11.35
HT40	MCS0	1	3	2422	0.23	11.39
HT40	MCS0	1	6	2437	0.23	11.25
HT40	MCS0	1	9	2452	0.23	11.23

TEST RESULTS DATA
Peak Power Density

2.4GHz Band								
Mod.	Data Rate	N _{TX}	CH.	Freq. (MHz)	Peak PSD (dBm /3kHz)	DG (dBi)	Peak PSD Limit (dBm /3kHz)	Pass/Fail
11b	1Mbps	1	1	2412	-5.64	-0.30	8.00	Pass
11b	1Mbps	1	6	2437	-4.91	-0.30	8.00	Pass
11b	1Mbps	1	11	2462	-5.50	-0.30	8.00	Pass
11g	6Mbps	1	1	2412	-9.56	-0.30	8.00	Pass
11g	6Mbps	1	6	2437	-8.62	-0.30	8.00	Pass
11g	6Mbps	1	11	2462	-9.92	-0.30	8.00	Pass
HT20	MCS0	1	1	2412	-13.13	-0.30	8.00	Pass
HT20	MCS0	1	6	2437	-14.49	-0.30	8.00	Pass
HT20	MCS0	1	11	2462	-14.40	-0.30	8.00	Pass
HT40	MCS0	1	3	2422	-13.49	-0.30	8.00	Pass
HT40	MCS0	1	6	2437	-16.15	-0.30	8.00	Pass
HT40	MCS0	1	9	2452	-15.00	-0.30	8.00	Pass



Appendix B. Radiated Spurious Emission

Test Engineer :	Ken Wu and J.C. Liang	Temperature :	20~22°C
		Relative Humidity :	50~54%

2.4GHz 2400~2483.5MHz

WIFI 802.11b (Band Edge @ 3m)

WIFI Ant. 1	Note	Frequency (MHz)	Level (dBμV/m)	Over Limit (dB)	Limit Line (dBμV/m)	Read Level (dBμV)	Antenna Factor (dB/m)	Cable Loss (dB)	Preamp Factor (dB)	Ant Pos (cm)	Table Pos (deg)	Peak Avg. (P/A)	Pol. (H/V)	
802.11b CH 01 2412MHz		2389.83	53.57	-20.43	74	53.83	27.01	6.71	33.98	177	152	P	H	
		2390	43.61	-10.39	54	43.87	27.01	6.71	33.98	177	152	A	H	
	*	2413.36	106.85	-	-	107.06	27.06	6.71	33.98	177	152	P	H	
	*	2413.36	104.34	-	-	104.55	27.06	6.71	33.98	177	152	A	H	
													H	
														H
			2373.72	51.72	-22.28	74	52.1	26.96	6.65	33.99	352	44	P	V
			2390	42.12	-11.88	54	42.38	27.01	6.71	33.98	352	44	A	V
		*	2413.36	103.5	-	-	103.71	27.06	6.71	33.98	352	44	P	V
		*	2413.36	100.97	-	-	101.18	27.06	6.71	33.98	352	44	A	V
														V
														V
802.11b CH 06 2437MHz		2354.91	51.1	-22.9	74	51.53	26.91	6.65	33.99	140	147	P	H	
		2389.92	41.18	-12.82	54	41.44	27.01	6.71	33.98	140	147	A	H	
		*	2438.41	105.21	-	-	105.28	27.16	6.74	33.97	140	147	P	H
		*	2438.33	102.73	-	-	102.8	27.16	6.74	33.97	140	147	A	H
			2499.6	51.61	-22.39	74	51.48	27.3	6.77	33.94	140	147	P	H
			2483.56	41.21	-12.79	54	41.14	27.25	6.77	33.95	140	147	A	H
			2375.79	50.84	-23.16	74	51.22	26.96	6.65	33.99	387	47	P	V
			2390	40.52	-13.48	54	40.78	27.01	6.71	33.98	387	47	A	V
		*	2438.33	102.86	-	-	102.93	27.16	6.74	33.97	387	47	P	V
		*	2435.74	100.34	-	-	100.46	27.11	6.74	33.97	387	47	A	V
			2491.12	50.94	-23.06	74	50.82	27.3	6.77	33.95	387	47	P	V
			2483.68	40.72	-13.28	54	40.65	27.25	6.77	33.95	387	47	A	V



802.11b CH 11 2462MHz	*	2463.46	105.22	-	-	105.21	27.2	6.77	33.96	116	148	P	H
	*	2463.46	102.77	-	-	102.76	27.2	6.77	33.96	116	148	A	H
		2484.4	51.68	-22.32	74	51.61	27.25	6.77	33.95	116	148	P	H
		2483.52	42	-12	54	41.93	27.25	6.77	33.95	116	148	A	H
													H
													H
	*	2463.38	103.06	-	-	103.05	27.2	6.77	33.96	379	49	P	V
	*	2463.38	100.57	-	-	100.56	27.2	6.77	33.96	379	49	A	V
		2487.04	51.4	-22.6	74	51.33	27.25	6.77	33.95	379	49	P	V
		2483.52	41.3	-12.7	54	41.23	27.25	6.77	33.95	379	49	A	V
													V
													V
Remark	1. No other spurious found. 2. All results are PASS against Peak and Average limit line.												



2.4GHz 2400~2483.5MHz

WIFI 802.11b (Harmonic @ 3m)

WIFI Ant. 1	Note	Frequency (MHz)	Level (dBμV/m)	Over Limit (dB)	Limit Line (dBμV/m)	Read Level (dBμV)	Antenna Factor (dB/m)	Cable Loss (dB)	Preamp Factor (dB)	Ant Pos (cm)	Table Pos (deg)	Peak Avg. (P/A)	Pol. (H/V)	
802.11b CH 01 2412MHz		4824	35	-39	74	58.37	31.12	10.58	65.07	100	0	P	H	
													H	
													H	
													H	
			4824	35.18	-38.82	74	58.55	31.12	10.58	65.07	100	0	P	V
														V
														V
802.11b CH 06 2437MHz		4874	36.6	-37.4	74	59.93	31.21	10.48	65.02	100	0	P	H	
		7311	38.2	-35.8	74	54.9	36.08	12.28	65.06	100	0	P	H	
													H	
													H	
			4874	34.62	-39.38	74	57.95	31.21	10.48	65.02	100	0	P	V
			7311	38.26	-35.74	74	54.96	36.08	12.28	65.06	100	0	P	V
														V
802.11b CH 11 2462MHz		4926	34.35	-39.65	74	57.64	31.29	10.39	64.97	100	0	P	H	
		7386	38.71	-35.29	74	55.03	36.27	12.49	65.08	100	0	P	H	
													H	
													H	
			4924	32.55	-41.45	74	55.84	31.29	10.39	64.97	100	0	P	V
			7386	39.49	-34.51	74	55.81	36.27	12.49	65.08	100	0	P	V
														V
Remark	1. No other spurious found.													
	2. All results are PASS against Peak and Average limit line.													



2.4GHz 2400~2483.5MHz

WIFI 802.11g (Band Edge @ 3m)

WIFI Ant. 1	Note	Frequency (MHz)	Level (dBμV/m)	Over Limit (dB)	Limit Line (dBμV/m)	Read Level (dBμV)	Antenna Factor (dB/m)	Cable Loss (dB)	Preamp Factor (dB)	Ant Pos (cm)	Table Pos (deg)	Peak Avg. (P/A)	Pol. (H/V)	
802.11g CH 01 2412MHz		2389.74	59.5	-14.5	74	59.77	27.01	6.71	33.99	122	151	P	H	
		2390	47.03	-6.97	54	47.29	27.01	6.71	33.98	122	151	A	H	
	*	2412	105.8	-	-	106.01	27.06	6.71	33.98	122	151	P	H	
	*	2412	97.74	-	-	97.95	27.06	6.71	33.98	122	151	A	H	
													H	
														H
			2389.83	55.92	-18.08	74	56.18	27.01	6.71	33.98	392	48	P	V
			2390	44	-10	54	44.26	27.01	6.71	33.98	392	48	A	V
	*		2412	101.56	-	-	101.77	27.06	6.71	33.98	392	48	P	V
	*		2412	94.24	-	-	94.45	27.06	6.71	33.98	392	48	A	V
														V
														V
802.11g CH 06 2437MHz		2388.84	51.13	-22.87	74	51.4	27.01	6.71	33.99	142	149	P	H	
		2389.65	41.85	-12.15	54	42.12	27.01	6.71	33.99	142	149	A	H	
	*	2437	105.49	-	-	105.56	27.16	6.74	33.97	142	149	P	H	
	*	2437	98.19	-	-	98.26	27.16	6.74	33.97	142	149	A	H	
			2484.64	52.39	-21.61	74	52.32	27.25	6.77	33.95	142	149	P	H
			2483.56	43.17	-10.83	54	43.1	27.25	6.77	33.95	142	149	A	H
			2360.22	51.21	-22.79	74	51.64	26.91	6.65	33.99	384	50	P	V
			2389.92	41.28	-12.72	54	41.54	27.01	6.71	33.98	384	50	A	V
	*		2437	102.47	-	-	102.54	27.16	6.74	33.97	384	50	P	V
	*		2437	94.78	-	-	94.85	27.16	6.74	33.97	384	50	A	V
			2498.08	51.68	-22.32	74	51.55	27.3	6.77	33.94	384	50	P	V
			2483.6	41.99	-12.01	54	41.92	27.25	6.77	33.95	384	50	A	V



802.11g CH 11 2462MHz	*	2462	105.12	-	-	105.11	27.2	6.77	33.96	226	153	P	H
	*	2462	97.77	-	-	97.76	27.2	6.77	33.96	226	153	A	H
		2483.68	62.13	-11.87	74	62.06	27.25	6.77	33.95	226	153	P	H
		2483.56	48.4	-5.6	54	48.33	27.25	6.77	33.95	226	153	A	H
													H
													H
	*	2462	102.63	-	-	102.62	27.2	6.77	33.96	379	50	P	V
	*	2462	95.32	-	-	95.31	27.2	6.77	33.96	379	50	A	V
		2484.28	58.14	-15.86	74	58.07	27.25	6.77	33.95	379	50	P	V
		2483.52	46.13	-7.87	54	46.06	27.25	6.77	33.95	379	50	A	V
													V
													V
Remark	1. No other spurious found. 2. All results are PASS against Peak and Average limit line.												



2.4GHz 2400~2483.5MHz

WIFI 802.11g (Harmonic @ 3m)

WIFI Ant. 1	Note	Frequency (MHz)	Level (dBµV/m)	Over Limit (dB)	Limit Line (dBµV/m)	Read Level (dBµV)	Antenna Factor (dB/m)	Cable Loss (dB)	Preamp Factor (dB)	Ant Pos (cm)	Table Pos (deg)	Peak Avg. (P/A)	Pol. (H/V)
802.11g CH 01 2412MHz		4824	33.82	-40.18	74	57.19	31.12	10.58	65.07	100	0	P	H
													H
													H
													H
		4824	33.74	-40.26	74	57.11	31.12	10.58	65.07	100	0	P	V
													V
													V
802.11g CH 06 2437MHz		4874	34.45	-39.55	74	57.78	31.21	10.48	65.02	100	0	P	H
		7311	38.21	-35.79	74	54.91	36.08	12.28	65.06	100	0	P	H
													H
													H
		4874	35.33	-38.67	74	58.66	31.21	10.48	65.02	100	0	P	V
		7311	37.43	-36.57	74	54.13	36.08	12.28	65.06	100	0	P	V
													V
802.11g CH 11 2462MHz		4924	33.08	-40.92	74	56.37	31.29	10.39	64.97	100	0	P	H
		7386	39.87	-34.13	74	56.19	36.27	12.49	65.08	100	0	P	H
													H
													H
		4924	33.28	-40.72	74	56.57	31.29	10.39	64.97	100	0	P	V
		7386	39.21	-34.79	74	55.53	36.27	12.49	65.08	100	0	P	V
													V
Remark	1. No other spurious found.												
	2. All results are PASS against Peak and Average limit line.												



2.4GHz 2400~2483.5MHz

WIFI 802.11n HT20 (Band Edge @ 3m)

WIFI Ant. 1	Note	Frequency (MHz)	Level (dBμV/m)	Over Limit (dB)	Limit Line (dBμV/m)	Read Level (dBμV)	Antenna Factor (dB/m)	Cable Loss (dB)	Preamp Factor (dB)	Ant Pos (cm)	Table Pos (deg)	Peak Avg. (P/A)	Pol. (H/V)	
802.11n HT20 CH 01 2412MHz		2389.47	53.63	-20.37	74	53.9	27.01	6.71	33.99	176	150	P	H	
		2390	43.26	-10.74	54	43.52	27.01	6.71	33.98	176	150	A	H	
	*	2412.69	102.45	-	-	102.66	27.06	6.71	33.98	176	150	P	H	
	*	2413.28	94.56	-	-	94.77	27.06	6.71	33.98	176	150	A	H	
													H	
														H
			2390	51.34	-22.66	74	51.6	27.01	6.71	33.98	353	44	P	V
			2389.92	42.68	-11.32	54	42.94	27.01	6.71	33.98	353	44	A	V
		*	2413.78	99.51	-	-	99.72	27.06	6.71	33.98	353	44	P	V
		*	2413.19	92.15	-	-	92.36	27.06	6.71	33.98	353	44	A	V
													V	
													V	
802.11n HT20 CH 06 2437MHz		2328.99	51.16	-22.84	74	51.76	26.82	6.58	34	145	150	P	H	
		2389.92	41.63	-12.37	54	41.89	27.01	6.71	33.98	145	150	A	H	
	*	2437	101.07	-	-	101.14	27.16	6.74	33.97	145	150	P	H	
	*	2437	93.35	-	-	93.42	27.16	6.74	33.97	145	150	A	H	
			2484.44	51.92	-22.08	74	51.85	27.25	6.77	33.95	145	150	P	H
			2483.92	42.39	-11.61	54	42.32	27.25	6.77	33.95	145	150	A	H
			2365.62	50.87	-23.13	74	51.3	26.91	6.65	33.99	385	43	P	V
			2385.24	41.05	-12.95	54	41.37	26.96	6.71	33.99	385	43	A	V
		*	2437	97.45	-	-	97.52	27.16	6.74	33.97	385	43	P	V
		*	2437	89.53	-	-	89.6	27.16	6.74	33.97	385	43	A	V
		2497.68	50.93	-23.07	74	50.8	27.3	6.77	33.94	385	43	P	V	
		2484.4	41.57	-12.43	54	41.5	27.25	6.77	33.95	385	43	A	V	



802.11n HT20 CH 11 2462MHz	*	2462	100.79	-	-	100.78	27.2	6.77	33.96	224	154	P	H
	*	2462	93	-	-	92.99	27.2	6.77	33.96	224	154	A	H
		2484.76	54.47	-19.53	74	54.4	27.25	6.77	33.95	224	154	P	H
		2483.68	43.63	-10.37	54	43.56	27.25	6.77	33.95	224	154	A	H
													H
													H
	*	2462	98.7	-	-	98.69	27.2	6.77	33.96	377	48	P	V
	*	2462	90.93	-	-	90.92	27.2	6.77	33.96	377	48	A	V
		2483.92	52.84	-21.16	74	52.77	27.25	6.77	33.95	377	48	P	V
		2483.76	42.84	-11.16	54	42.77	27.25	6.77	33.95	377	48	A	V
													V
													V
Remark	1. No other spurious found. 2. All results are PASS against Peak and Average limit line.												



2.4GHz 2400~2483.5MHz

WIFI 802.11n HT20 (Harmonic @ 3m)

WIFI Ant. 1	Note	Frequency (MHz)	Level (dBμV/m)	Over Limit (dB)	Limit Line (dBμV/m)	Read Level (dBμV)	Antenna Factor (dB/m)	Cable Loss (dB)	Preamp Factor (dB)	Ant Pos (cm)	Table Pos (deg)	Peak Avg. (P/A)	Pol. (H/V)	
802.11n HT20 CH 01 2412MHz		4824	34.06	-39.94	74	57.43	31.12	10.58	65.07	100	0	P	H	
													H	
													H	
													H	
			4824	33.37	-40.63	74	56.74	31.12	10.58	65.07	100	0	P	V
														V
														V
802.11n HT20 CH 06 2437MHz		4874	33.6	-40.4	74	56.93	31.21	10.48	65.02	100	0	P	H	
		7311	38.32	-35.68	74	55.02	36.08	12.28	65.06	100	0	P	H	
													H	
													H	
			4874	34.26	-39.74	74	57.59	31.21	10.48	65.02	100	0	P	V
			7311	37.39	-36.61	74	54.09	36.08	12.28	65.06	100	0	P	V
														V
802.11n HT20 CH 11 2462MHz		4924	33.65	-40.35	74	56.94	31.29	10.39	64.97	100	0	P	H	
		7386	39.57	-34.43	74	55.89	36.27	12.49	65.08	100	0	P	H	
													H	
													H	
			4924	34.28	-39.72	74	57.57	31.29	10.39	64.97	100	0	P	V
			7386	38.65	-35.35	74	54.97	36.27	12.49	65.08	100	0	P	V
														V
Remark	1. No other spurious found.													
	2. All results are PASS against Peak and Average limit line.													



2.4GHz 2400~2483.5MHz

WIFI 802.11n HT40 (Band Edge @ 3m)

WIFI Ant. 1	Note	Frequency (MHz)	Level (dBμV/m)	Over Limit (dB)	Limit Line (dBμV/m)	Read Level (dBμV)	Antenna Factor (dB/m)	Cable Loss (dB)	Preamp Factor (dB)	Ant Pos (cm)	Table Pos (deg)	Peak Avg. (P/A)	Pol. (H/V)
802.11n HT40 CH 03 2422MHz		2389.65	60.15	-13.85	74	60.42	27.01	6.71	33.99	202	153	P	H
		2389.47	46.16	-7.84	54	46.43	27.01	6.71	33.99	202	153	A	H
	*	2422	98.82	-	-	98.94	27.11	6.74	33.97	202	153	P	H
	*	2422	91.3	-	-	91.42	27.11	6.74	33.97	202	153	A	H
		2483.8	51.55	-22.45	74	51.48	27.25	6.77	33.95	202	153	P	H
		2483.52	42.65	-11.35	54	42.58	27.25	6.77	33.95	202	153	A	H
		2390	56.39	-17.61	74	56.65	27.01	6.71	33.98	394	51	P	V
		2390	44.01	-9.99	54	44.27	27.01	6.71	33.98	394	51	A	V
	*	2422	96.04	-	-	96.16	27.11	6.74	33.97	394	51	P	V
	*	2422	88.52	-	-	88.64	27.11	6.74	33.97	394	51	A	V
		2496.56	51.56	-22.44	74	51.43	27.3	6.77	33.94	394	51	P	V
		2494.96	42.3	-11.7	54	42.17	27.3	6.77	33.94	394	51	A	V
802.11n HT40 CH 06 2437MHz		2382.45	51.28	-22.72	74	51.6	26.96	6.71	33.99	145	152	P	H
		2390	42.18	-11.82	54	42.44	27.01	6.71	33.98	145	152	A	H
	*	2437	98.93	-	-	99	27.16	6.74	33.97	145	152	P	H
	*	2437	91.22	-	-	91.29	27.16	6.74	33.97	145	152	A	H
		2487.48	51.48	-22.52	74	51.41	27.25	6.77	33.95	145	152	P	H
		2484.56	43.44	-10.56	54	43.37	27.25	6.77	33.95	145	152	A	H
		2370.12	51.3	-22.7	74	51.68	26.96	6.65	33.99	393	48	P	V
		2389.92	42.22	-11.78	54	42.48	27.01	6.71	33.98	393	48	A	V
	*	2437	96.92	-	-	96.99	27.16	6.74	33.97	393	48	P	V
	*	2437	88.78	-	-	88.85	27.16	6.74	33.97	393	48	A	V
		2486.88	51.86	-22.14	74	51.79	27.25	6.77	33.95	393	48	P	V
		2484.36	42.39	-11.61	54	42.32	27.25	6.77	33.95	393	48	A	V



802.11n HT40 CH 09 2452MHz		2343.39	51.12	-22.88	74	51.59	26.87	6.65	33.99	146	150	P	H
		2389.83	42.26	-11.74	54	42.52	27.01	6.71	33.98	146	150	A	H
	*	2452	98.98	-	-	99.04	27.16	6.74	33.96	146	150	P	H
	*	2452	90.96	-	-	91.02	27.16	6.74	33.96	146	150	A	H
		2483.56	60.65	-13.35	74	60.58	27.25	6.77	33.95	146	150	P	H
		2483.84	46.54	-7.46	54	46.47	27.25	6.77	33.95	146	150	A	H
		2331.24	51.01	-22.99	74	51.61	26.82	6.58	34	337	43	P	V
		2372.37	42.02	-11.98	54	42.4	26.96	6.65	33.99	337	43	A	V
	*	2452	94.82	-	-	94.88	27.16	6.74	33.96	337	43	P	V
	*	2452	87.17	-	-	87.23	27.16	6.74	33.96	337	43	A	V
		2483.52	57.15	-16.85	74	57.08	27.25	6.77	33.95	337	43	P	V
		2483.72	45.02	-8.98	54	44.95	27.25	6.77	33.95	337	43	A	V
Remark	1. No other spurious found. 2. All results are PASS against Peak and Average limit line.												



2.4GHz 2400~2483.5MHz

WIFI 802.11n HT40 (Harmonic @ 3m)

WIFI Ant. 1	Note	Frequency (MHz)	Level (dBµV/m)	Over Limit (dB)	Limit Line (dBµV/m)	Read Level (dBµV)	Antenna Factor (dB/m)	Cable Loss (dB)	Preamp Factor (dB)	Ant Pos (cm)	Table Pos (deg)	Peak Avg. (P/A)	Pol. (H/V)
802.11n HT40 CH 03 2422MHz		4844	36.1	-37.9	74	59.43	31.15	10.58	65.06	100	0	P	H
		7266	39.06	-34.94	74	55.94	36.01	12.17	65.06	100	0	P	H
													H
													H
		4844	33.2	-40.8	74	56.53	31.15	10.58	65.06	100	0	P	V
		7266	37.9	-36.1	74	54.78	36.01	12.17	65.06	100	0	P	V
													V
802.11n HT40 CH 06 2437MHz		4874	34.08	-39.92	74	57.41	31.21	10.48	65.02	100	0	P	H
		7311	38.9	-35.1	74	55.6	36.08	12.28	65.06	100	0	P	H
													H
													H
		4874	34.33	-39.67	74	57.66	31.21	10.48	65.02	100	0	P	V
		7311	37.66	-36.34	74	54.36	36.08	12.28	65.06	100	0	P	V
													V
802.11n HT40 CH 09 2452MHz		4904	34.31	-39.69	74	57.65	31.26	10.39	64.99	100	0	P	H
		7356	40.23	-33.77	74	56.72	36.2	12.38	65.07	100	0	P	H
													H
													H
		4904	34.09	-39.91	74	57.43	31.26	10.39	64.99	100	0	P	V
		7356	40.16	-33.84	74	56.65	36.2	12.38	65.07	100	0	P	V
													V
Remark	1. No other spurious found.												
	2. All results are PASS against Peak and Average limit line.												



Emission below 1GHz

2.4GHz WIFI 802.11b (LF)

WIFI	Note	Frequency	Level	Over	Limit	Read	Antenna	Cable	Preamp	Ant	Table	Peak	Pol.	
Ant.				Limit	Line	Level	Factor	Loss	Factor	Pos	Pos	Avg.		
1		(MHz)	(dBμV/m)	(dB)	(dBμV/m)	(dBμV)	(dB/m)	(dB)	(dB)	(cm)	(deg)	(P/A)	(H/V)	
2.4GHz 802.11b LF		101.01	24.84	-18.66	43.5	38.93	16.21	1.48	31.78			P	H	
		163.92	22.3	-21.2	43.5	35.9	16.5	1.68	31.78			P	H	
		217.65	22.61	-23.39	46	36.45	16.2	1.74	31.78			P	H	
		626.9	26.79	-19.21	46	29.51	25.96	3.36	32.04			P	H	
		802.6	30.65	-15.35	46	30.54	28.32	3.7	31.91			P	H	
		943.3	32.42	-13.58	46	29.18	30.44	3.89	31.09	149	247	P	H	
													H	
													H	
													H	
													H	
													H	
													H	
			30.54	31.63	-8.37	40	37.35	25.18	0.93	31.83	247	35	P	V
			41.61	31.3	-8.7	40	43	19.18	0.93	31.81			P	V
			116.67	27.06	-16.44	43.5	39.84	17.52	1.48	31.78			P	V
			593.3	26.43	-19.57	46	29.72	25.58	3.16	32.03			P	V
			793.5	30.38	-15.62	46	30.39	28.22	3.7	31.93			P	V
			943.3	32.87	-13.13	46	29.63	30.44	3.89	31.09			P	V
														V
														V
													V	
													V	
													V	
													V	
Remark	1. No other spurious found. 2. All results are PASS against limit line.													



Emission below 1GHz

2.4GHz WIFI 802.11g (LF)

WIFI	Note	Frequency	Level	Over	Limit	Read	Antenna	Cable	Preamp	Ant	Table	Peak	Pol.	
Ant.				Limit	Line	Level	Factor	Loss	Factor	Pos	Pos	Avg.		
1		(MHz)	(dBμV/m)	(dB)	(dBμV/m)	(dBμV)	(dB/m)	(dB)	(dB)	(cm)	(deg)	(P/A)	(H/V)	
2.4GHz 802.11g LF		100.47	26.66	-16.84	43.5	40.75	16.21	1.48	31.78			P	H	
		135.57	25.72	-17.78	43.5	38.08	17.94	1.48	31.78			P	H	
		174.99	24.12	-19.38	43.5	38.64	15.58	1.68	31.78			P	H	
		600.3	26.56	-19.44	46	29.74	25.7	3.16	32.04			P	H	
		822.9	30.7	-15.3	46	30.17	28.57	3.77	31.81	147	68	P	H	
		993	33.35	-20.65	54	29.62	30.51	3.92	30.7			P	H	
													H	
													H	
													H	
													H	
													H	
													H	
			31.62	34.29	-5.71	40	40.53	24.66	0.93	31.83	247	315	P	V
			116.4	31.19	-12.31	43.5	43.97	17.52	1.48	31.78			P	V
			165.54	27.42	-16.08	43.5	41.22	16.3	1.68	31.78			P	V
			736.1	29.33	-16.67	46	30.36	27.43	3.54	32			P	V
			856.5	32.57	-13.43	46	31.51	28.94	3.77	31.65			P	V
			972.7	33.28	-20.72	54	29.69	30.55	3.89	30.85			P	V
														V
														V
													V	
													V	
													V	
													V	
Remark	1. No other spurious found. 2. All results are PASS against limit line.													



Emission below 1GHz

2.4GHz WIFI 802.11n HT20 (LF)

WIFI	Note	Frequency	Level	Over	Limit	Read	Antenna	Cable	Preamp	Ant	Table	Peak	Pol.	
Ant.				Limit	Line	Level	Factor	Loss	Factor	Pos	Pos	Avg.		
1		(MHz)	(dBμV/m)	(dB)	(dBμV/m)	(dBμV)	(dB/m)	(dB)	(dB)	(cm)	(deg)	(P/A)	(H/V)	
2.4GHz 802.11n HT20 LF		101.28	26.88	-16.62	43.5	40.97	16.21	1.48	31.78			P	H	
		136.38	25.93	-17.57	43.5	38.3	17.93	1.48	31.78			P	H	
		234.12	21.15	-24.85	46	33.72	17.22	1.98	31.77			P	H	
		771.8	30.01	-15.99	46	30.37	27.97	3.62	31.95			P	H	
		888.7	31.47	-14.53	46	29.98	29.13	3.84	31.48			P	H	
		939.1	32.76	-13.24	46	29.72	30.3	3.86	31.12	100	17	P	H	
													H	
													H	
													H	
													H	
													H	
													H	
			31.35	34.12	-5.88	40	39.84	25.18	0.93	31.83	267	95	P	V
			125.04	31.74	-11.76	43.5	44.19	17.85	1.48	31.78			P	V
			163.11	20.76	-22.74	43.5	34.26	16.6	1.68	31.78			P	V
			797.7	30.29	-15.71	46	30.24	28.27	3.7	31.92			P	V
			836.9	31.26	-14.74	46	30.48	28.75	3.77	31.74			P	V
			972.7	33.05	-20.95	54	29.46	30.55	3.89	30.85			P	V
												V		
												V		
												V		
												V		
												V		
												V		
Remark	1. No other spurious found. 2. All results are PASS against limit line.													



Emission below 1GHz

2.4GHz WIFI 802.11n HT40 (LF)

WIFI	Note	Frequency	Level	Over	Limit	Read	Antenna	Cable	Preamp	Ant	Table	Peak	Pol.
Ant.				Limit	Line	Level	Factor	Loss	Factor	Pos	Pos	Avg.	
1		(MHz)	(dBµV/m)	(dB)	(dBµV/m)	(dBµV)	(dB/m)	(dB)	(dB)	(cm)	(deg)	(P/A)	(H/V)
		103.71	25.14	-18.36	43.5	38.9	16.54	1.48	31.78			P	H
		136.92	25.31	-18.19	43.5	37.68	17.93	1.48	31.78			P	H
		174.72	23.23	-20.27	43.5	37.75	15.58	1.68	31.78			P	H
		576.5	27.4	-18.6	46	31.1	25.27	3.03	32			P	H
		752.9	29.55	-16.45	46	30.18	27.73	3.62	31.98			P	H
		955.2	33.39	-12.61	46	29.91	30.59	3.89	31	100	68	P	H
													H
													H
													H
													H
													H
2.4GHz													H
802.11n													H
HT40													
LF		31.35	34.28	-5.72	40	40	25.18	0.93	31.83	241	317	P	V
		77.52	21.38	-18.62	40	38.65	13.35	1.17	31.79			P	V
		131.25	23.82	-19.68	43.5	36.13	17.99	1.48	31.78			P	V
		557.6	25.72	-20.28	46	29.73	24.94	3.03	31.98			P	V
		661.9	28.74	-17.26	46	31.01	26.32	3.45	32.04			P	V
		948.2	32.69	-13.31	46	29.28	30.57	3.89	31.05			P	V
													V
													V
													V
													V
													V
													V
													V
													V
													V
Remark	<ol style="list-style-type: none"> No other spurious found. All results are PASS against limit line. 												



Note symbol

*	Fundamental Frequency which can be ignored. However, the level of any unwanted emissions shall not exceed the level of the fundamental frequency.
!	Test result is over limit line.
P/A	Peak or Average
H/V	Horizontal or Vertical



A calculation example for radiated spurious emission is shown as below:

WIFI	Note	Frequency	Level	Over	Limit	Read	Antenna	Cable	Preamp	Ant	Table	Peak	Pol.
Ant.				Limit	Line	Level	Factor	Loss	Factor	Pos	Pos	Avg.	
1		(MHz)	(dBμV/m)	(dB)	(dBμV/m)	(dBμV)	(dB/m)	(dB)	(dB)	(cm)	(deg)	(P/A)	(H/V)
802.11b		2390	55.45	-18.55	74	54.51	32.22	4.58	35.86	103	308	P	H
CH 01													
2412MHz		2390	43.54	-10.46	54	42.6	32.22	4.58	35.86	103	308	A	H

- Level(dBμV/m) =
Antenna Factor(dB/m) + Cable Loss(dB) + Read Level(dBμV) - Preamp Factor(dB)
- Over Limit(dB) = Level(dBμV/m) – Limit Line(dBμV/m)

For Peak Limit @ 2390MHz:

- Level(dBμV/m)
= Antenna Factor(dB/m) + Cable Loss(dB) + Read Level(dBμV) - Preamp Factor(dB)
= 32.22(dB/m) + 4.58(dB) + 54.51(dBμV) – 35.86 (dB)
= 55.45 (dBμV/m)
- Over Limit(dB)
= Level(dBμV/m) – Limit Line(dBμV/m)
= 55.45(dBμV/m) – 74(dBμV/m)
= -18.55(dB)

For Average Limit @ 2390MHz:

- Level(dBμV/m)
= Antenna Factor(dB/m) + Cable Loss(dB) + Read Level(dBμV) - Preamp Factor(dB)
= 32.22(dB/m) + 4.58(dB) + 42.6(dBμV) – 35.86 (dB)
= 43.54 (dBμV/m)
- Over Limit(dB)
= Level(dBμV/m) – Limit Line(dBμV/m)
= 43.54(dBμV/m) – 54(dBμV/m)
= -10.46(dB)

Both peak and average measured complies with the limit line, so test result is “PASS”.



Appendix C. Radiated Spurious Emission Plots

Test Engineer :	Ken Wu and J.C. Liang	Temperature :	20~22°C
		Relative Humidity :	50~54%

Note symbol

-L	Low channel location
-R	High channel location



2.4GHz 2400~2483.5MHz
WIFI 802.11b (Band Edge @ 3m)

Table with 4 columns: WIFI, ANT, 1, and two sub-columns for Horizontal and Vertical. Rows are labeled Peak and Avg. Each cell contains a spectral plot and technical details like Site, Condition, and Detector.



WIFI	2.4GHz 2400~2483.5MHz Band Edge @ 3m	
ANT	802.11b CH06 2437MHz - L	
1	Horizontal	Vertical
Peak	<p>Site : 03CH11-HY Condition : FCC CLASS-B 3m HORN 9120D-HF HORIZONTAL Detector : Peak</p>	<p>Site : 03CH11-HY Condition : FCC CLASS-B 3m HORN 9120D-HF VERTICAL Detector : Peak</p>
Avg.	<p>Site : 03CH11-HY Condition : FCC CLASS-B (AVG) 3m HORN 9120D-HF HORIZONTAL Detector : Peak</p>	<p>Site : 03CH11-HY Condition : FCC CLASS-B (AVG) 3m HORN 9120D-HF VERTICAL Detector : Peak</p>



WIFI	2.4GHz 2400~2483.5MHz Band Edge @ 3m	
ANT	802.11b CH06 2437MHz - R	
1	Horizontal	Vertical
Peak	<p>Site : 03CH11-HY Condition : FCC CLASS-B 3m HORN 9120D-HF HORIZONTAL RBW:1000.000KHz VBW:3000.000KHz SWT:Auto Detector : Peak</p>	<p>Site : 03CH11-HY Condition : FCC CLASS-B 3m HORN 9120D-HF VERTICAL RBW:1000.000KHz VBW:3000.000KHz SWT:Auto Detector : Peak</p>
Avg.	<p>Site : 03CH11-HY Condition : FCC CLASS-B (AVG) 3m HORN 9120D-HF HORIZONTAL RBW:1000.000KHz VBW:0.010KHz SWT:Auto Detector : Peak</p>	<p>Site : 03CH11-HY Condition : FCC CLASS-B (AVG) 3m HORN 9120D-HF VERTICAL RBW:1000.000KHz VBW:0.010KHz SWT:Auto Detector : Peak</p>



WIFI	2.4GHz 2400~2483.5MHz Band Edge @ 3m	
ANT	802.11b CH11 2462MHz	
1	Horizontal	Vertical
Peak	<p>Site : 03CH11-HY Condition : FCC CLASS-B 3m HORN 9120D-HF HORIZONTAL Detector : Peak</p>	<p>Site : 03CH11-HY Condition : FCC CLASS-B 3m HORN 9120D-HF VERTICAL Detector : Peak</p>
Avg.	<p>Site : 03CH11-HY Condition : FCC CLASS-B (AVG) 3m HORN 9120D-HF HORIZONTAL Detector : Peak</p>	<p>Site : 03CH11-HY Condition : FCC CLASS-B (AVG) 3m HORN 9120D-HF VERTICAL Detector : Peak</p>



2.4GHz 2400~2483.5MHz
WIFI 802.11g (Band Edge @ 3m)

WIFI	2.4GHz 2400~2483.5MHz Band Edge @ 3m	
ANT	802.11g CH01 2412MHz	
1	Horizontal	Vertical
Peak	<p>Site : 03CH11-HY Condition : FCC CLASS-B 3m HORN 9120D-HF HORIZONTAL Detector : Peak</p>	<p>Site : 03CH11-HY Condition : FCC CLASS-B 3m HORN 9120D-HF VERTICAL Detector : Peak</p>
Avg.	<p>Site : 03CH11-HY Condition : FCC CLASS-B (AVG) 3m HORN 9120D-HF HORIZONTAL Detector : Peak</p>	<p>Site : 03CH11-HY Condition : FCC CLASS-B (AVG) 3m HORN 9120D-HF VERTICAL Detector : Peak</p>



WIFI	2.4GHz 2400~2483.5MHz Band Edge @ 3m	
ANT	802.11g CH06 2437MHz - L	
1	Horizontal	Vertical
Peak	<p>Site : 03CH11-HY Condition : FCC CLASS-B 3m HORN 9120D-HF HORIZONTAL Detector : Peak</p>	<p>Site : 03CH11-HY Condition : FCC CLASS-B 3m HORN 9120D-HF VERTICAL Detector : Peak</p>
Avg.	<p>Site : 03CH11-HY Condition : FCC CLASS-B (AVG) 3m HORN 9120D-HF HORIZONTAL Detector : Peak</p>	<p>Site : 03CH11-HY Condition : FCC CLASS-B (AVG) 3m HORN 9120D-HF VERTICAL Detector : Peak</p>



WIFI	2.4GHz 2400~2483.5MHz Band Edge @ 3m	
ANT	802.11g CH06 2437MHz - R	
1	Horizontal	Vertical
Peak	<p>Site : 03CH11-HY Condition : FCC CLASS-B 3m HORN 9120D-HF HORIZONTAL RBW:1000.000KHz VBW:3000.000KHz SWT:Auto Detector : Peak</p>	<p>Site : 03CH11-HY Condition : FCC CLASS-B 3m HORN 9120D-HF VERTICAL RBW:1000.000KHz VBW:3000.000KHz SWT:Auto Detector : Peak</p>
Avg.	<p>Site : 03CH11-HY Condition : FCC CLASS-B (AVG) 3m HORN 9120D-HF HORIZONTAL RBW:1000.000KHz VBW:1.000KHz SWT:Auto Detector : Peak</p>	<p>Site : 03CH11-HY Condition : FCC CLASS-B (AVG) 3m HORN 9120D-HF VERTICAL RBW:1000.000KHz VBW:1.000KHz SWT:Auto Detector : Peak</p>



WIFI	2.4GHz 2400~2483.5MHz Band Edge @ 3m	
ANT	802.11g CH11 2462MHz	
1	Horizontal	Vertical
Peak	<p>Site : 03CH11-HY Condition : FCC CLASS-B 3m HORN 9120D-HF HORIZONTAL RBW:1000.000KHz VBW:3000.000KHz SWT:Auto Detector : Peak</p>	<p>Site : 03CH11-HY Condition : FCC CLASS-B 3m HORN 9120D-HF VERTICAL RBW:1000.000KHz VBW:3000.000KHz SWT:Auto Detector : Peak</p>
Avg.	<p>Site : 03CH11-HY Condition : FCC CLASS-B (AVG) 3m HORN 9120D-HF HORIZONTAL RBW:1000.000KHz VBW:1.000KHz SWT:Auto Detector : Peak</p>	<p>Site : 03CH11-HY Condition : FCC CLASS-B (AVG) 3m HORN 9120D-HF VERTICAL RBW:1000.000KHz VBW:1.000KHz SWT:Auto Detector : Peak</p>



2.4GHz 2400~2483.5MHz
WIFI 802.11n HT20 (Band Edge @ 3m)

Table with 4 columns: WIFI, ANT, 1, and two sub-columns for Horizontal and Vertical. Rows are labeled 'Peak' and 'Avg.' containing spectral plots and technical details like Site, Condition, and Detector.



WIFI	2.4GHz 2400~2483.5MHz Band Edge @ 3m	
ANT	802.11n HT20 CH06 2437MHz - L	
1	Horizontal	Vertical
Peak	<p>Site : 03CH11-HY Condition : FCC CLASS-B 3m HORN 9120D-HF HORIZONTAL RBW:1000.000KHz VBW:3000.000KHz SWT:Auto Detector : Peak</p>	<p>Site : 03CH11-HY Condition : FCC CLASS-B 3m HORN 9120D-HF VERTICAL RBW:1000.000KHz VBW:3000.000KHz SWT:Auto Detector : Peak</p>
Avg.	<p>Site : 03CH11-HY Condition : FCC CLASS-B (AVG) 3m HORN 9120D-HF HORIZONTAL RBW:1000.000KHz VBW:1.000KHz SWT:Auto Detector : Peak</p>	<p>Site : 03CH11-HY Condition : FCC CLASS-B (AVG) 3m HORN 9120D-HF VERTICAL RBW:1000.000KHz VBW:1.000KHz SWT:Auto Detector : Peak</p>

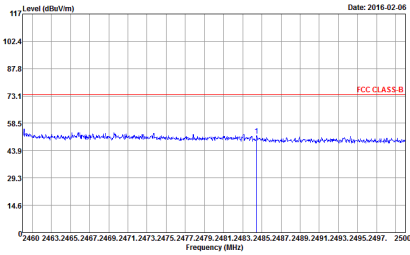
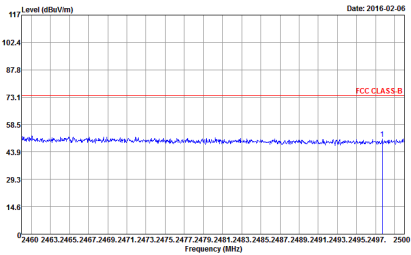
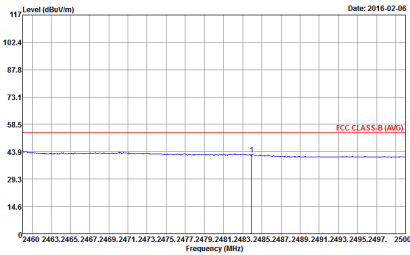
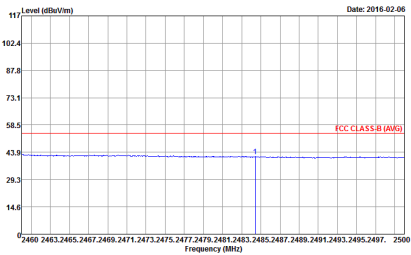

WIFI	2.4GHz 2400~2483.5MHz Band Edge @ 3m	
ANT	802.11n HT20 CH06 2437MHz - R	
1	Horizontal	Vertical
Peak	 <p>Site : 03CH11-HY Condition : FCC CLASS-B 3m HORN 9120D-HF HORIZONTAL Detector : Peak</p>	 <p>Site : 03CH11-HY Condition : FCC CLASS-B 3m HORN 9120D-HF VERTICAL Detector : Peak</p>
Avg.	 <p>Site : 03CH11-HY Condition : FCC CLASS-B (AVG) 3m HORN 9120D-HF HORIZONTAL Detector : Peak</p>	 <p>Site : 03CH11-HY Condition : FCC CLASS-B (AVG) 3m HORN 9120D-HF VERTICAL Detector : Peak</p>



WIFI	2.4GHz 2400~2483.5MHz Band Edge @ 3m	
ANT	802.11n HT20 CH11 2462MHz	
1	Horizontal	Vertical
Peak	<p>Site : 03CH11-HY Condition : FCC CLASS-B 3m HORN 9120D-HF HORIZONTAL RBW:1000.000KHz VBW:3000.000KHz SWT:Auto Detector : Peak</p>	<p>Site : 03CH11-HY Condition : FCC CLASS-B 3m HORN 9120D-HF VERTICAL RBW:1000.000KHz VBW:3000.000KHz SWT:Auto Detector : Peak</p>
Avg.	<p>Site : 03CH11-HY Condition : FCC CLASS-B (AVG) 3m HORN 9120D-HF HORIZONTAL RBW:1000.000KHz VBW:1.000KHz SWT:Auto Detector : Peak</p>	<p>Site : 03CH11-HY Condition : FCC CLASS-B (AVG) 3m HORN 9120D-HF VERTICAL RBW:1000.000KHz VBW:1.000KHz SWT:Auto Detector : Peak</p>



2.4GHz 2400~2483.5MHz
WIFI 802.11n HT40 (Band Edge @ 3m)

WIFI	2.4GHz 2400~2483.5MHz Band Edge @ 3m	
ANT	802.11n HT40 CH03 2422MHz - L	
1	Horizontal	Vertical
Peak	<p>Site : 03CH11-HY Condition : FCC CLASS-B 3m HORN 9120D-HF HORIZONTAL Detector : Peak</p>	<p>Site : 03CH11-HY Condition : FCC CLASS-B 3m HORN 9120D-HF VERTICAL Detector : Peak</p>
Avg.	<p>Site : 03CH11-HY Condition : FCC CLASS-B (AVG) 3m HORN 9120D-HF HORIZONTAL Detector : Peak</p>	<p>Site : 03CH11-HY Condition : FCC CLASS-B (AVG) 3m HORN 9120D-HF VERTICAL Detector : Peak</p>



WIFI	2.4GHz 2400~2483.5MHz Band Edge @ 3m	
ANT	802.11n HT40 CH03 2422MHz - R	
1	Horizontal	Vertical
Peak	<p>Site : 03CH11-HY Condition : FCC CLASS-B 3m HORN 9120D-HF HORIZONTAL Detector : Peak</p>	<p>Site : 03CH11-HY Condition : FCC CLASS-B 3m HORN 9120D-HF VERTICAL Detector : Peak</p>
Avg.	<p>Site : 03CH11-HY Condition : FCC CLASS-B (AVG) 3m HORN 9120D-HF HORIZONTAL Detector : Peak</p>	<p>Site : 03CH11-HY Condition : FCC CLASS-B (AVG) 3m HORN 9120D-HF VERTICAL Detector : Peak</p>

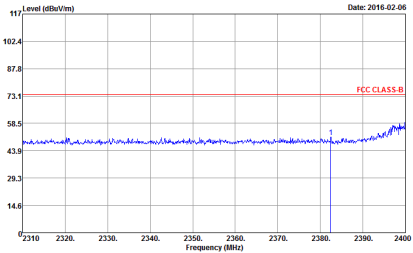
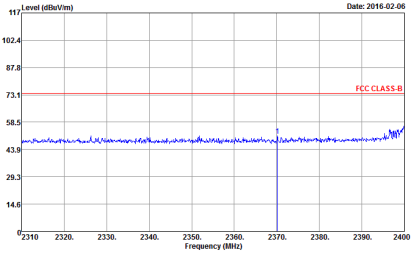
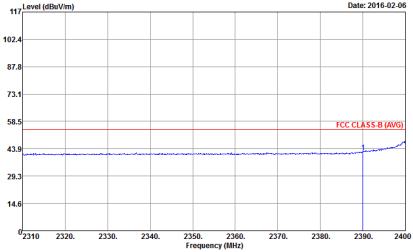
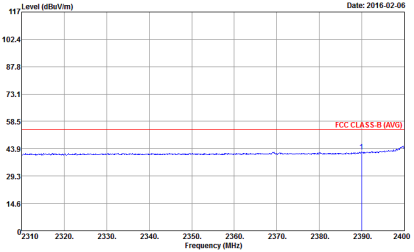

WIFI	2.4GHz 2400~2483.5MHz Band Edge @ 3m	
ANT	802.11n HT40 CH06 2437MHz - L	
1	Horizontal	Vertical
Peak	 <p>Site : 03CH11-HY Condition : FCC CLASS-B 3m HORN 9120D-HF HORIZONTAL RBW:1000.000KHz VBW:3000.000KHz SWT:Auto Detector : Peak</p>	 <p>Site : 03CH11-HY Condition : FCC CLASS-B 3m HORN 9120D-HF VERTICAL RBW:1000.000KHz VBW:3000.000KHz SWT:Auto Detector : Peak</p>
Avg.	 <p>Site : 03CH11-HY Condition : FCC CLASS-B (AVG) 3m HORN 9120D-HF HORIZONTAL RBW:1000.000KHz VBW:3.000KHz SWT:Auto Detector : Peak</p>	 <p>Site : 03CH11-HY Condition : FCC CLASS-B (AVG) 3m HORN 9120D-HF VERTICAL RBW:1000.000KHz VBW:3.000KHz SWT:Auto Detector : Peak</p>



WIFI	2.4GHz 2400~2483.5MHz Band Edge @ 3m	
ANT	802.11n HT40 CH06 2437MHz - R	
1	Horizontal	Vertical
Peak	<p>Site : 03CH11-HY Condition : FCC CLASS-B 3m HORN 9120D-HF HORIZONTAL RBW:1000.000KHz VBW:3000.000KHz SWT:Auto Detector : Peak</p>	<p>Site : 03CH11-HY Condition : FCC CLASS-B 3m HORN 9120D-HF VERTICAL RBW:1000.000KHz VBW:3000.000KHz SWT:Auto Detector : Peak</p>
Avg.	<p>Site : 03CH11-HY Condition : FCC CLASS-B (AVG) 3m HORN 9120D-HF HORIZONTAL RBW:1000.000KHz VBW:3.000KHz SWT:Auto Detector : Peak</p>	<p>Site : 03CH11-HY Condition : FCC CLASS-B (AVG) 3m HORN 9120D-HF VERTICAL RBW:1000.000KHz VBW:3.000KHz SWT:Auto Detector : Peak</p>

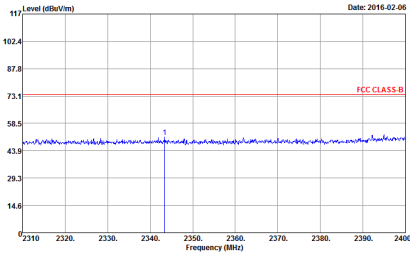
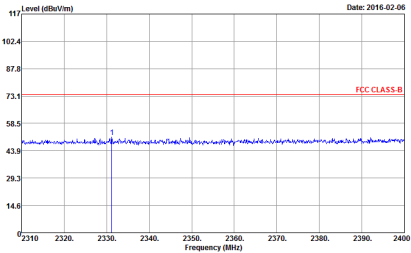
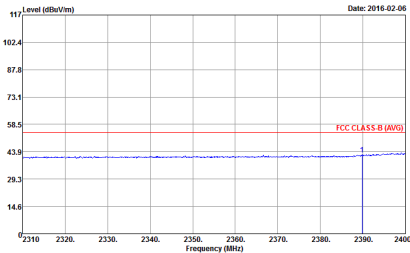
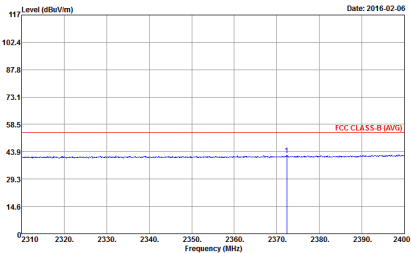

WIFI	2.4GHz 2400~2483.5MHz Band Edge @ 3m	
ANT	802.11n HT40 CH09 2452MHz - L	
1	Horizontal	Vertical
Peak	 <p>Date: 2016-02-06</p> <p>Site : 03CH11-HY Condition : FCC CLASS-B 3m HORN 9120D-HF HORIZONTAL RBW:1000.000KHz VBW:3000.000KHz SWT:Auto Detector : Peak</p>	 <p>Date: 2016-02-06</p> <p>Site : 03CH11-HY Condition : FCC CLASS-B 3m HORN 9120D-HF VERTICAL RBW:1000.000KHz VBW:3000.000KHz SWT:Auto Detector : Peak</p>
Avg.	 <p>Date: 2016-02-06</p> <p>Site : 03CH11-HY Condition : FCC CLASS-B (AVG) 3m HORN 9120D-HF HORIZONTAL RBW:1000.000KHz VBW:3.000KHz SWT:Auto Detector : Peak</p>	 <p>Date: 2016-02-06</p> <p>Site : 03CH11-HY Condition : FCC CLASS-B (AVG) 3m HORN 9120D-HF VERTICAL RBW:1000.000KHz VBW:3.000KHz SWT:Auto Detector : Peak</p>



WIFI	2.4GHz 2400~2483.5MHz Band Edge @ 3m	
ANT	802.11n HT40 CH09 2452MHz - R	
1	Horizontal	Vertical
Peak	<p>Site : 03CH11-HY Condition : FCC CLASS-B 3m HORN 9120D-HF HORIZONTAL Detector : Peak</p>	<p>Site : 03CH11-HY Condition : FCC CLASS-B 3m HORN 9120D-HF VERTICAL Detector : Peak</p>
Avg.	<p>Site : 03CH11-HY Condition : FCC CLASS-B (AVG) 3m HORN 9120D-HF HORIZONTAL Detector : Peak</p>	<p>Site : 03CH11-HY Condition : FCC CLASS-B (AVG) 3m HORN 9120D-HF VERTICAL Detector : Peak</p>



2.4GHz 2400~2483.5MHz
WIFI 802.11b (Harmonic @ 3m)

WIFI	2.4GHz 2400~2483.5MHz Harmonic @ 3m	
ANT	802.11b CH01 2412MHz	
1	Horizontal	Vertical
Peak Avg.	<p>Site : 03CH11-HY Condition : FCC CLASS-B 3m 9170 SHF HORM_150809 HORIZONTAL Detector : Peak</p>	<p>Site : 03CH11-HY Condition : FCC CLASS-B 3m 9170 SHF HORM_150809 VERTICAL Detector : Peak</p>

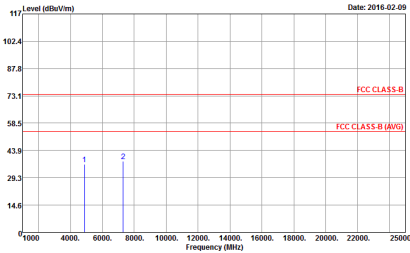
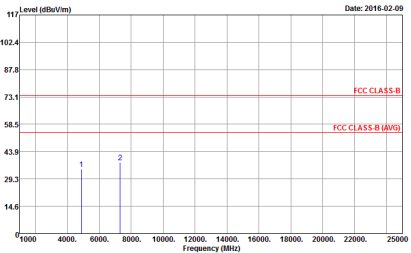

WIFI	2.4GHz 2400~2483.5MHz Harmonic @ 3m	
ANT	802.11b CH06 2437MHz	
1	Horizontal	Vertical
<p>Peak Avg.</p>	 <p>Site : 03CH11-HY Condition : FCC CLASS-B 3m 9170 SHF HORM_150809 HORIZONTAL Detector : Peak</p>	 <p>Site : 03CH11-HY Condition : FCC CLASS-B 3m 9170 SHF HORM_150809 VERTICAL Detector : Peak</p>

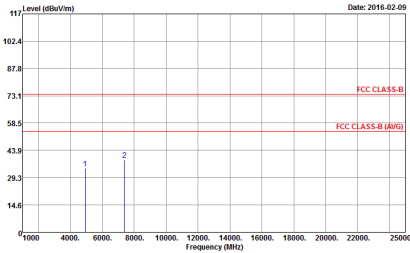
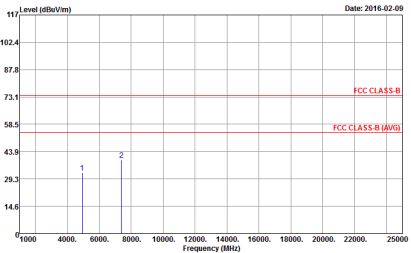

WIFI	2.4GHz 2400~2483.5MHz Harmonic @ 3m	
ANT	802.11b CH11 2462MHz	
1	Horizontal	Vertical
<p>Peak Avg.</p>	 <p>Site : 03CH11-HY Condition : FCC CLASS-B 3m 9170 SHF HORM_150809 HORIZONTAL Detector : Peak</p>	 <p>Site : 03CH11-VY Condition : FCC CLASS-B 3m 9170 SHF HORM_150809 VERTICAL Detector : Peak</p>



2.4GHz 2400~2483.5MHz
WIFI 802.11g (Harmonic @ 3m)

Table with 3 columns: WIFI, ANT, and 1. It contains two graphs showing Level (dBuV/m) vs Frequency (MHz) for Horizontal and Vertical orientations. The graphs include FCC CLASS-B and FCC CLASS-B (AVG) limits and a peak measurement at approximately 5.2 GHz.



WIFI	2.4GHz 2400~2483.5MHz Harmonic @ 3m	
ANT	802.11g CH06 2437MHz	
1	Horizontal	Vertical
Peak Avg.	<p>Site : 03CH11-HY Condition : FCC CLASS-B 3m 9170 SHF HORM_150809 HORIZONTAL Detector : Peak</p>	<p>Site : 03CH11-HY Condition : FCC CLASS-B 3m 9170 SHF HORM_150809 VERTICAL Detector : Peak</p>



WIFI	2.4GHz 2400~2483.5MHz Harmonic @ 3m	
ANT	802.11g CH11 2462MHz	
1	Horizontal	Vertical
Peak Avg.	<p>Site : 03CH11-HY Condition : FCC CLASS-B 3m 9170 SHF HORM_150809 HORIZONTAL Detector : Peak</p>	<p>Site : 03CH11-HY Condition : FCC CLASS-B 3m 9170 SHF HORM_150809 VERTICAL Detector : Peak</p>



2.4GHz 2400~2483.5MHz
WIFI 802.11n HT20 (Harmonic @ 3m)

WIFI	2.4GHz 2400~2483.5MHz Harmonic @ 3m	
ANT	802.11n HT20 CH01 2412MHz	
1	Horizontal	Vertical
Peak Avg.	<p>Site : 03CH11-HY Condition : FCC CLASS-B 3m 9170 SHF HORM_150809 HORIZONTAL Detector : Peak</p>	<p>Site : 03CH11-HY Condition : FCC CLASS-B 3m 9170 SHF HORM_150809 VERTICAL Detector : Peak</p>



WIFI	2.4GHz 2400~2483.5MHz Harmonic @ 3m	
ANT	802.11n HT20 CH06 2437MHz	
1	Horizontal	Vertical
<p>Peak</p> <p>Avg.</p>	<p>Site : 03CH11-HY Condition : FCC CLASS-B 3m 9170 SHF HORM_150809 HORIZONTAL Detector : Peak</p>	<p>Site : 03CH11-HY Condition : FCC CLASS-B 3m 9170 SHF HORM_150809 VERTICAL Detector : Peak</p>



WIFI	2.4GHz 2400~2483.5MHz Harmonic @ 3m	
ANT	802.11n HT20 CH11 2462MHz	
1	Horizontal	Vertical
Peak Avg.	<p>Site : 03CH11-HY Condition : FCC CLASS-B 3m 9170 SHF HORM_150809 HORIZONTAL Detector : Peak</p>	<p>Site : 03CH11-HY Condition : FCC CLASS-B 3m 9170 SHF HORM_150809 VERTICAL Detector : Peak</p>



2.4GHz 2400~2483.5MHz
WIFI 802.11n HT40 (Harmonic @ 3m)

WIFI	2.4GHz 2400~2483.5MHz Harmonic @ 3m	
ANT	802.11n HT40 CH03 2422MHz	
1	Horizontal	Vertical
Peak Avg.	<p>Site : 03CH11-HY Condition : FCC CLASS-B 3m 9170 SHF HORM_150809 HORIZONTAL Detector : Peak</p>	<p>Site : 03CH11-HY Condition : FCC CLASS-B 3m 9170 SHF HORM_150809 VERTICAL Detector : Peak</p>

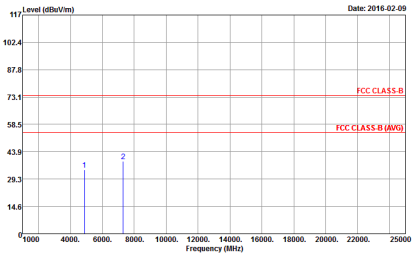
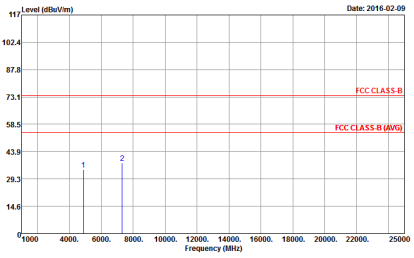

WIFI	2.4GHz 2400~2483.5MHz Harmonic @ 3m	
ANT	802.11n HT40 CH06 2437MHz	
1	Horizontal	Vertical
<p>Peak</p> <p>Avg.</p>	 <p>Site : 03CH11-HY Condition : FCC CLASS-B 3m 9170 SHF HORM_150809 HORIZONTAL Detector : Peak</p>	 <p>Site : 03CH11-HY Condition : FCC CLASS-B 3m 9170 SHF HORM_150809 VERTICAL Detector : Peak</p>



WIFI	2.4GHz 2400~2483.5MHz Harmonic @ 3m	
ANT	802.11n HT40 CH09 2452MHz	
1	Horizontal	Vertical
Peak Avg.	<p>Site : 03CH11-HY Condition : FCC CLASS-B 3m 9170 SHF HORM_150809 HORIZONTAL Detector : Peak</p>	<p>Site : 03CH11-HY Condition : FCC CLASS-B 3m 9170 SHF HORM_150809 VERTICAL Detector : Peak</p>



Emission below 1GHz
2.4GHz WIFI 802.11b (LF)

WIFI	2.4GHz 2400~2483.5MHz	
ANT	802.11b LF	
1	Horizontal	Vertical
QP / Peak	<p>Site : 03CH11-HY Condition : FCC CLASS-B 3m BI-LOG 6111D-LF_ETC HORIZONTAL Detector : Peak</p>	<p>Site : 03CH11-HY Condition : FCC CLASS-B 3m BI-LOG 6111D-LF_ETC VERTICAL Detector : Peak</p>



Emission below 1GHz
2.4GHz WIFI 802.11g (LF)

WIFI	2.4GHz 2400~2483.5MHz	
ANT	802.11g LF	
1	Horizontal	Vertical
QP / Peak	<p>Site : 03CH11-HY Condition : FCC CLASS-B 3m BT-LOG 6111D-LF_ETC HORIZONTAL Detector : Peak</p>	<p>Site : 03CH11-HY Condition : FCC CLASS-B 3m BT-LOG 6111D-LF_ETC VERTICAL Detector : Peak</p>

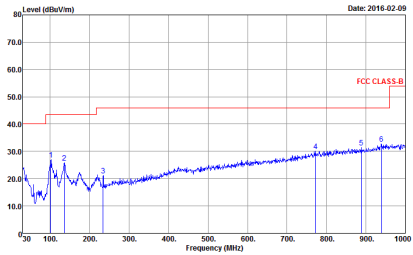
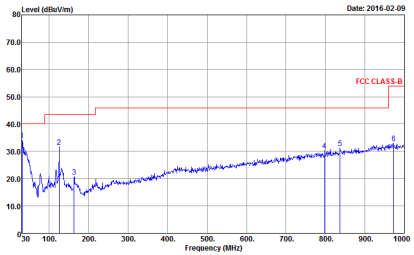

**Emission below 1GHz
2.4GHz WIFI 802.11n HT20 (LF)**

WIFI	2.4GHz 2400~2483.5MHz	
ANT	802.11n HT20 LF	
1	Horizontal	Vertical
<p align="center">QP / Peak</p>	 <p>Site : 03CH11-HY Condition : FCC CLASS-B 3m BI-LOG 6111D-LF_ETC HORIZONTAL Detector : Peak</p>	 <p>Site : 03CH11-HY Condition : FCC CLASS-B 3m BI-LOG 6111D-LF_ETC VERTICAL Detector : Peak</p>



Emission below 1GHz
2.4GHz WIFI 802.11n HT40 (LF)

Table with 3 columns: WIFI (2.4GHz 2400~2483.5MHz), ANT (802.11n HT40 LF), and 1 (Horizontal/Vertical). It contains two graphs showing Level (dBuV/m) vs Frequency (MHz) for Horizontal and Vertical orientations, with peak markers and FCC CLASS B limits.