



# FCC RF Test Report

**APPLICANT** : Sony Mobile Communications Inc.  
**EQUIPMENT** : GSM/WCDMA/LTE Phone+Bluetooth,  
DTS/UNII a/b/g/n and NFC  
**BRAND NAME** : Sony  
**FCC ID** : PY7-PM0961  
**STANDARD** : FCC Part 15 Subpart C §15.247  
**CLASSIFICATION** : (DTS) Digital Transmission System

The product was received on Jan. 22, 2016 and testing was completed on Feb. 10, 2016. We, SPORTON INTERNATIONAL INC., would like to declare that the tested sample has been evaluated in accordance with the test procedures and has been in compliance with the applicable technical standards.

The test results in this report apply exclusively to the tested model / sample. Without written approval of SPORTON INTERNATIONAL INC., the test report shall not be reproduced except in full.

Reviewed by: Joseph Lin / Supervisor

Approved by: Jones Tsai / Manager



**SPORTON INTERNATIONAL INC.**

No. 52, Hwa Ya 1<sup>st</sup> Rd., Hwa Ya Technology Park, Kwei-Shan District, Tao Yuan City, Taiwan, R.O.C.



# TABLE OF CONTENTS

**SUMMARY OF TEST RESULT ..... 4**

**1 GENERAL DESCRIPTION..... 5**

1.1 Applicant ..... 5

1.2 Manufacturer..... 5

1.3 Product Feature of Equipment Under Test..... 5

1.4 Modification of EUT ..... 6

1.5 Testing Location ..... 7

1.6 Applicable Standards..... 8

**2 TEST CONFIGURATION OF EQUIPMENT UNDER TEST..... 9**

2.1 Descriptions of Test Mode ..... 9

2.2 Test Mode..... 10

2.3 Connection Diagram of Test System..... 11

2.4 Support Unit used in test configuration and system ..... 12

2.5 EUT Operation Test Setup ..... 12

2.6 Measurement Results Explanation Example..... 12

**3 TEST RESULT ..... 13**

3.1 6dB and 99% Bandwidth Measurement ..... 13

3.2 Peak Output Power Measurement ..... 18

3.3 Power Spectral Density Measurement ..... 19

3.4 Conducted Band Edges and Spurious Emission Measurement ..... 24

3.5 Radiated Band Edges and Spurious Emission Measurement ..... 33

3.6 AC Conducted Emission Measurement..... 38

3.7 Antenna Requirements..... 42

**4 LIST OF MEASURING EQUIPMENT..... 43**

**5 UNCERTAINTY OF EVALUATION..... 45**

**APPENDIX A. CONDUTED TEST RESULTS**

**APPENDIX A. RADIATED SPURIOUS EMISSION**

**APPENDIX B. RADIATED SPURIOUS EMISSION PLOT**



## REVISION HISTORY

REPORT NO.	VERSION	DESCRIPTION	ISSUED DATE
FR612118-01B	Rev. 01	Initial issue of report	Apr. 01, 2016
FR612118-01B	Rev. 02	Adding duty cycle data in section 3.5.8.	Apr. 15, 2016



### SUMMARY OF TEST RESULT

Report Section	FCC Rule	Description	Limit	Result	Remark
3.1	15.247(a)(2)	6dB Bandwidth	≥ 0.5MHz	Pass	-
3.1	-	99% Bandwidth	-	Pass	-
3.2	15.247(b)(1)	Peak Output Power	≤ 30dBm	Pass	-
3.3	15.247(e)	Power Spectral Density	≤ 8dBm/3kHz	Pass	-
3.4	15.247(d)	Conducted Band Edges and Spurious Emission	≤ 20dBc	Pass	-
3.5	15.247(d)	Radiated Band Edges and Spurious Emission	15.209(a) & 15.247(d)	Pass	Under limit 8.66 dB at 41.070 MHz
3.6	15.207	AC Conducted Emission	15.207(a)	Pass	Under limit 17.70 dB at 0.438 MHz
3.7	15.203 & 15.247(b)	Antenna Requirement	N/A	Pass	-
<p><b>Remark:</b> The FCC ID: PY7-PM0960 and FCC ID: PY7-PM0961 is similar device, in this report all the test result are referred to PY7-PM0960, Sporton Report No: FR612117-01B.</p>					



# 1 General Description

## 1.1 Applicant

**Sony Mobile Communications Inc.**

4-12-3 Higashi-Shinagawa, Shinagawa-ku, Tokyo, 140-0002, Japan

## 1.2 Manufacturer

**Sony Mobile Communications Inc.**

4-12-3 Higashi-Shinagawa, Shinagawa-ku, Tokyo, 140-0002, Japan

## 1.3 Product Feature of Equipment Under Test

GSM/WCDMA/LTE, Bluetooth, DTS/UNII, a/b/g/n, GPS, and NFC

Product Specification subjective to this standard	
Antenna Type	Bluetooth : PIFA Antenna type with gain -0.30 dBi

EUT Information List				
IMEI	HW Version	SW Version	S/N	Performed Test Item
004402455898886	A	33.2.A.0.19	RQ3000DQQZ	RF conducted measurement
004402455893739			RQ3000DQHV	Radiated Spurious Emission
004402455895585			RQ3000DQQU	Conducted Emission



Accessory List	
<b>AC Adapter</b>	Model No. : EP800
	Type No. : CAA-0002016-US B
	S/N : 3113W22608082 (for Radiated spurious emission) 3113W22608092 (for Conducted emission)
<b>Earphone</b>	Model No. : MH410c
	Type No. : AG-1110
	S/N : 1541A8180036F24 (for Radiated spurious emission) 1541A81B0036C26 (for Conducted emission)
<b>USB Cable</b>	Model No. : UCB16
	Type No. : AI-0142
	S/N : N/A (for Radiated spurious emission) N/A (for Conducted emission)

**Note:**

1. Above EUT list and accessory list used are electrically identical per declared by manufacturer.
2. Above the accessories list are used to exercise the EUT during test.
3. For other wireless features of this EUT, test report will be issued separately.

### 1.4 Modification of EUT

No modifications are made to the EUT during all test items.



### 1.5 Testing Location

Sporton Lab is accredited to ISO 17025 by Taiwan Accreditation Foundation (TAF code : 1190) and the FCC designation No. TW1022 under the FCC 2.948(e) by Mutual Recognition Agreement (MRA) in FCC Test.

<b>Test Site</b>	SPORTON INTERNATIONAL INC.	
<b>Test Site Location</b>	No. 52, Hwa Ya 1 <sup>st</sup> Rd., Hwa Ya Technology Park, Kwei-Shan District, Tao Yuan City, Taiwan, R.O.C. TEL: +886-3-327-3456 FAX: +886-3-328-4978	
<b>Test Site No.</b>	<b>Sporton Site No.</b>	
	TH05-HY	CO05-HY

**Note:** The test site complies with ANSI C63.4 2014 requirement.

<b>Test Site</b>	SPORTON INTERNATIONAL INC.	
<b>Test Site Location</b>	No.58, Aly. 75, Ln. 564, Wenhua 3rd Rd. Guishan Dist, Taoyuan City, Taiwan (R.O.C.) TEL: +886-3-327-0868 FAX: +886-3-327-0855	
<b>Test Site No.</b>	<b>Sporton Site No.</b>	
	03CH11-HY	

**Note:** The test site complies with ANSI C63.4 2014 requirement.



## 1.6 Applicable Standards

According to the specifications of the manufacturer, the EUT must comply with the requirements of the following standards:

- ♦ FCC Part 15 Subpart C §15.247
- ♦ FCC KDB Publication No. 558074 D01 DTS Meas. Guidance v03r04
- ♦ ANSI C63.10-2013

### **Remark:**

1. All test items were verified and recorded according to the standards and without any deviation during the test.
2. This EUT has also been tested and complied with the requirements of FCC Part 15, Subpart B, recorded in a separate test report.





## 2 Test Configuration of Equipment Under Test

### 2.1 Descriptions of Test Mode

The RF output power was recorded in the following table:

Channel	Frequency	Bluetooth 4.0 – LE RF Output Power	
		Data Rate / Modulation	
		GFSK	
		1Mbps	
Ch00	2402MHz	0.28 dBm	
Ch19	2440MHz	0.99 dBm	
Ch39	2480MHz	-0.08 dBm	

- a. The EUT has been associated with peripherals and configuration operated in a manner tended to maximize its emission characteristics in a typical application. Frequency range investigated: conduction (150 kHz to 30 MHz), radiation (9 kHz to the 10th harmonic of the highest fundamental frequency or to 40 GHz, whichever is lower). Pre-scanned tests, X, Y, Z in three orthogonal panels to determine the final configuration (X plane as worst plane) from all possible combinations.
  
- b. AC power line Conducted Emission was tested under maximum output power.



## 2.2 Test Mode

The following summary table is showing all test modes to demonstrate in compliance with the standard.

Summary table of Test Cases	
Test Item	Data Rate / Modulation
	Bluetooth 4.0 – LE / GFSK
Conducted TCs	Mode 1: Bluetooth Tx CH00_2402 MHz_1Mbps Mode 2: Bluetooth Tx CH19_2440 MHz_1Mbps Mode 3: Bluetooth Tx CH39_2480 MHz_1Mbps
Radiated TCs	Mode 1: Bluetooth Tx CH00_2402 MHz_1Mbps Mode 2: Bluetooth Tx CH19_2440 MHz_1Mbps Mode 3: Bluetooth Tx CH39_2480 MHz_1Mbps
AC Conducted Emission	Mode 1: GSM1900 Idle + Bluetooth Link + WLAN (2.4GHz) Link + MP3 + Earphone + Battery 2 + USB Cable (Charging from Adapter)

## 2.3 Connection Diagram of Test System

<Bluetooth 4.0 – LE Tx Mode>

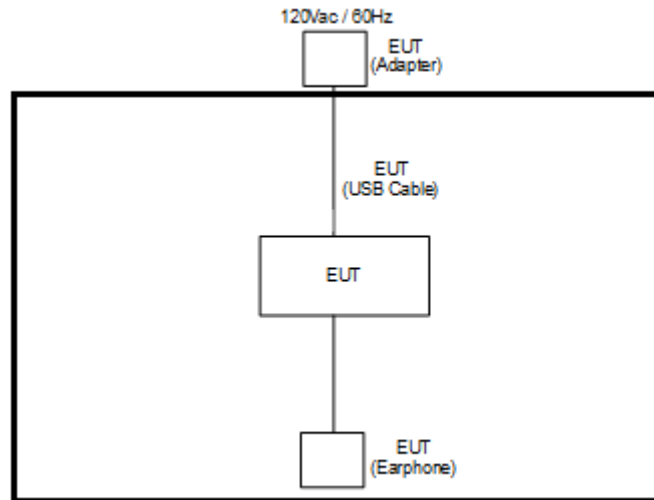

<AC Conducted Emission Mode>

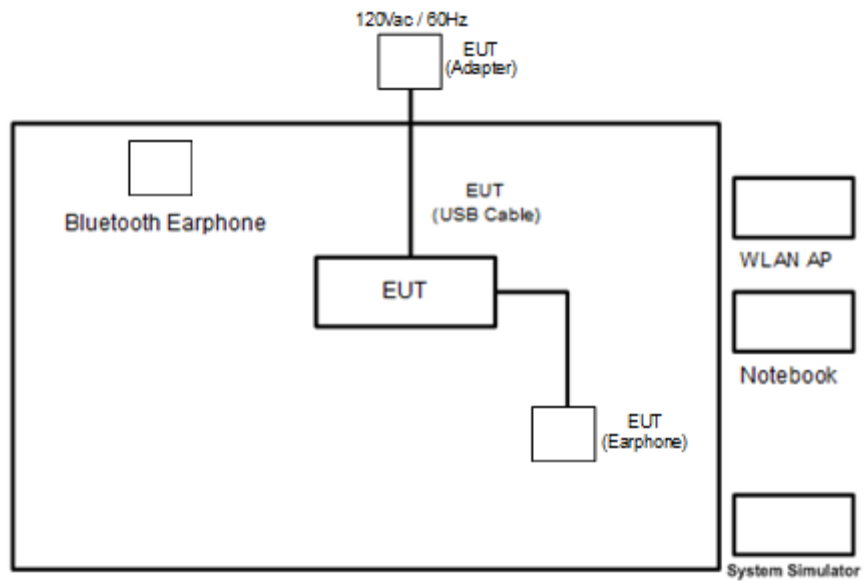



## 2.4 Support Unit used in test configuration and system

Item	Equipment	Trade Name	Model Name	FCC ID	Data Cable	Power Cord
1.	System Simulator	Anritsu	MT8820C	N/A	N/A	Unshielded, 1.8 m
2.	WLAN AP	D-Link	DIR-865L	KA2IR865LA1	N/A	Unshielded, 1.8 m
3.	Bluetooth Earphone	Sony	SBH20	PY7-RD0010	Unshielded, 0.75 m	N/A
4.	Notebook	DELL	Latitude E6320	FCC DoC/ Contains FCC ID: QDS-BRCM1054	N/A	AC I/P: Unshielded, 1.2 m DC O/P: Shielded, 1.8 m
5.	SD Card	SanDisk	MicroSD HC	FCC DoC	N/A	N/A

## 2.5 EUT Operation Test Setup

For WLAN RF test items, an engineering test program was provided and enabled to make EUT transmitting and receiving signals.

## 2.6 Measurement Results Explanation Example

For all conducted test items:

The offset level is set in the spectrum analyzer to compensate the RF cable loss and attenuator factor between EUT conducted output port and spectrum analyzer. With the offset compensation, the spectrum analyzer reading level is exactly the EUT RF output level.

Example :

The spectrum analyzer offset is derived from RF cable loss and attenuator factor.

*Offset = RF cable loss + attenuator factor.*

Following shows an offset computation example with cable loss 4.2 dB and 10dB attenuator.

$$\begin{aligned} \text{Offset}(dB) &= \text{RF cable loss}(dB) + \text{attenuator factor}(dB). \\ &= 4.2 + 10 = 14.2 \text{ (dB)} \end{aligned}$$

### 3 Test Result

#### 3.1 6dB and 99% Bandwidth Measurement

##### 3.1.1 Limit of 6dB and 99% Bandwidth

The minimum 6 dB bandwidth shall be at least 500 kHz.

##### 3.1.2 Measuring Instruments

The section 4.0 of List of Measuring Equipment of this test report is used for test.

##### 3.1.3 Test Procedures

1. The testing follows FCC KDB Publication No. 558074 D01 DTS Meas. Guidance v03r04.
2. The RF output of EUT was connected to the spectrum analyzer by RF cable and attenuator. The path loss was compensated to the results for each measurement.
3. Set to the maximum power setting and enable the EUT transmit continuously.
4. Make the measurement with the spectrum analyzer's resolution bandwidth (RBW) = 100 kHz. Set the Video bandwidth (VBW) = 300 kHz. In order to make an accurate measurement. The 6 dB bandwidth must be greater than 500 kHz.
5. For 99% Bandwidth Measurement, the spectrum analyzer's resolution bandwidth (RBW) is set 30kHz and set the Video bandwidth (VBW) = 100kHz.
6. Measure and record the results in the test report.

##### 3.1.4 Test Setup

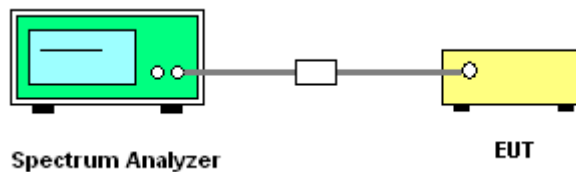



### 3.1.5 Test Result of 6dB Bandwidth

Test data refer to Appendix A.

6 dB Bandwidth Plot on Channel 00

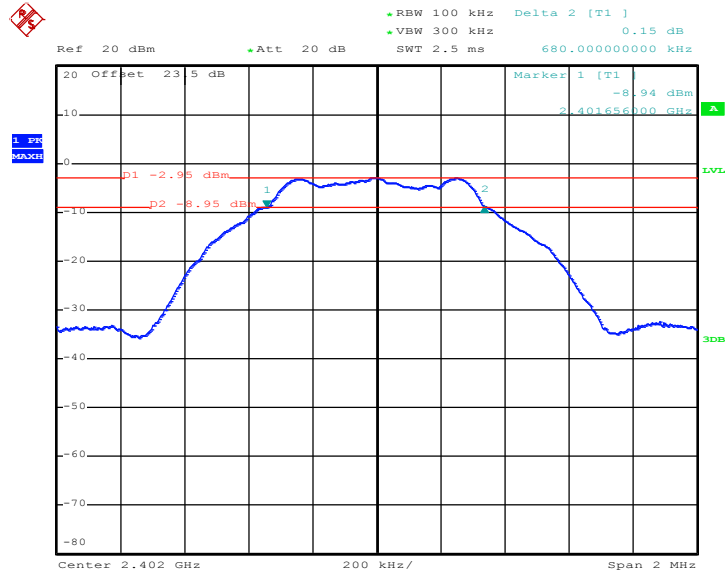

Date: 6.FEB.2016 01:12:46



### 6 dB Bandwidth Plot on Channel 19

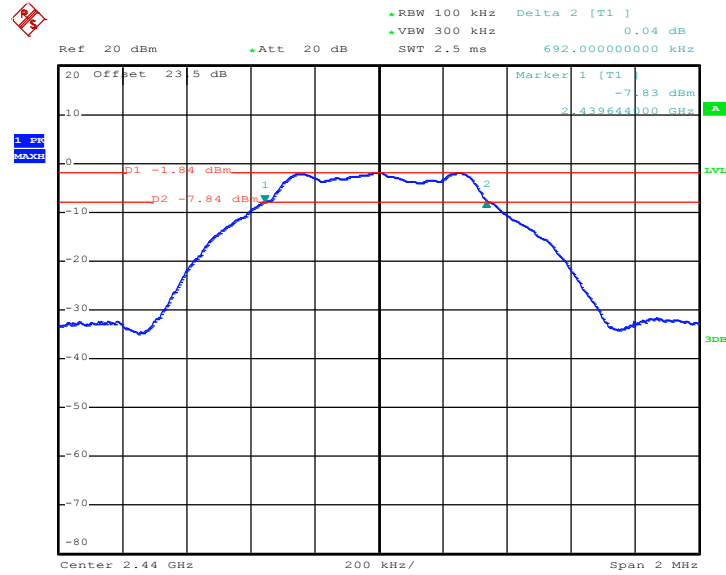

Date: 6.FEB.2016 01:22:35

### 6 dB Bandwidth Plot on Channel 39

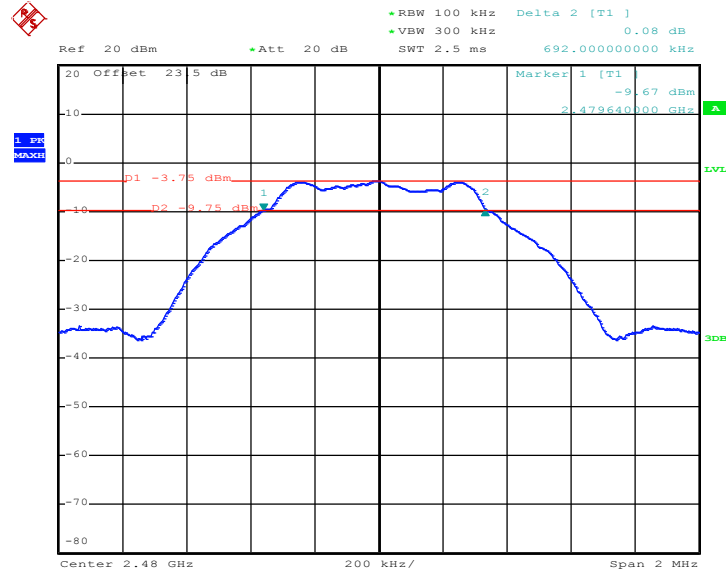

Date: 6.FEB.2016 01:26:40



### 3.1.6 Test Result of 99% Occupied Bandwidth

Test data refer to Appendix A.

99% Bandwidth Plot on Channel 00

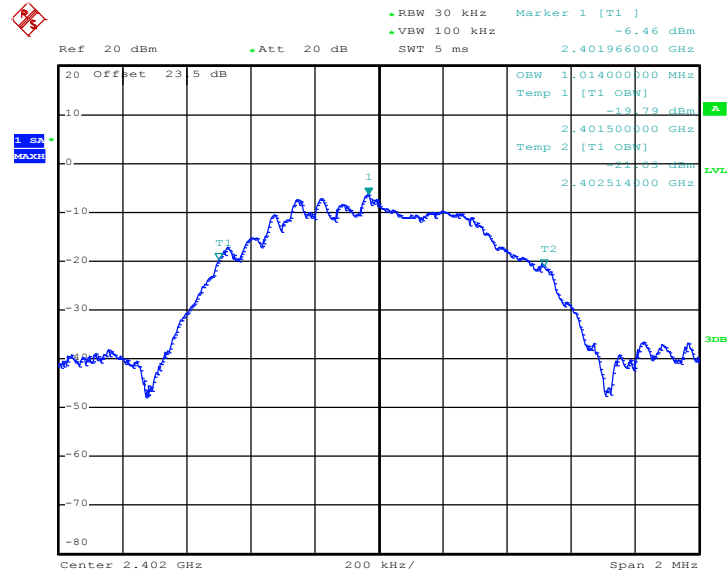

Date: 6.FEB.2016 01:17:16





99% Occupied Bandwidth Plot on Channel 19

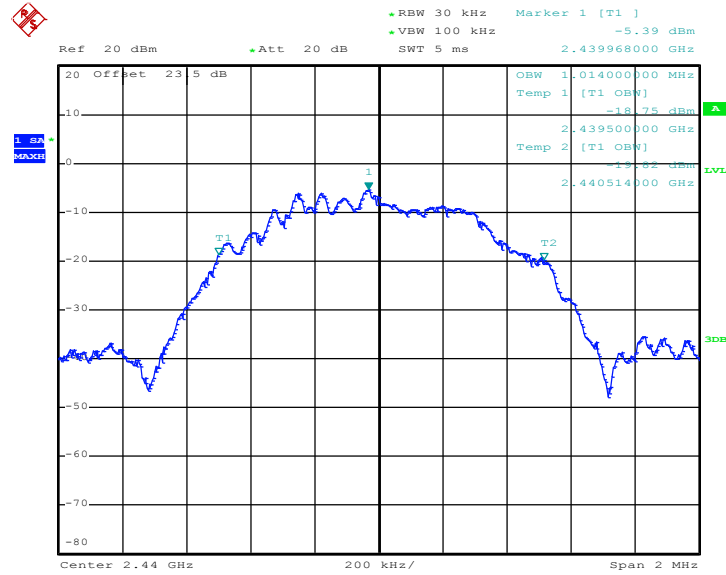

Date: 6.FEB.2016 01:25:16

99% Occupied Bandwidth Plot on Channel 39

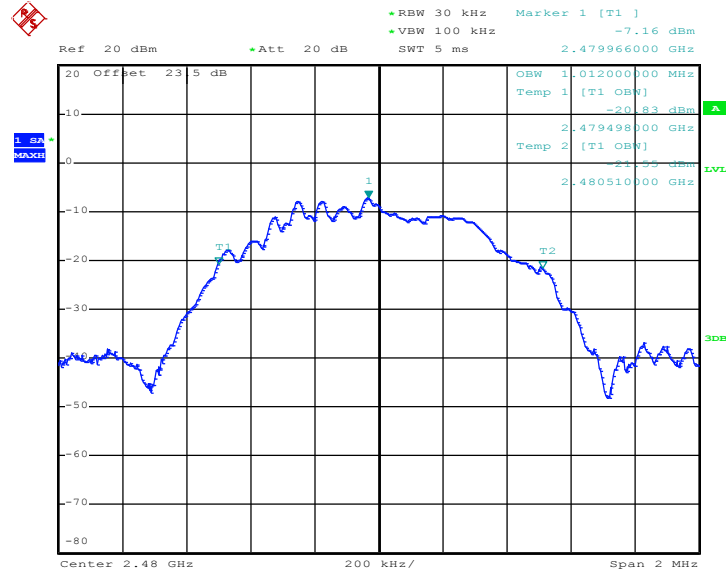

Date: 6.FEB.2016 01:29:38

Note : The occupied channel bandwidth is maintained within the band of operation for all of the modulations.

## 3.2 Peak Output Power Measurement

### 3.2.1 Limit of Peak Output Power

For systems using digital modulation in the 2400-2483.5MHz, the limit for peak output power is 30dBm. If transmitting antenna of directional gain greater than 6dBi is used, the peak output power from the intentional radiator shall be reduced below the above stated value by the amount in dB that the directional gain of the antenna exceeds 6 dBi. In case of point-to-point operation, the limit has to be reduced by 1dB for every 3dB that the directional gain of the antenna exceeds 6dBi.

### 3.2.2 Measuring Instruments

The section 4.0 of List of Measuring Equipment of this test report is used for test.

### 3.2.3 Test Procedures

1. The testing follows the Measurement Procedure of FCC KDB No. 558074 DTS D01 Meas. Guidance v03r04 section 9.1.2 PKPM1 Peak power meter method.
2. The RF output of EUT was connected to the power meter by RF cable and attenuator. The path loss was compensated to the results for each measurement.
3. Set to the maximum power setting and enable the EUT transmit continuously.
4. Measure the conducted output power and record the results in the test report.

### 3.2.4 Test Setup

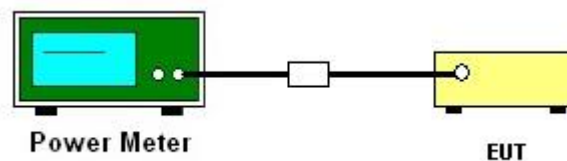

### 3.2.5 Test Result of Peak Output Power

Test data refers to Appendix A.

### 3.3 Power Spectral Density Measurement

#### 3.3.1 Limit of Power Spectral Density

The peak power spectral density shall not be greater than 8dBm in any 3kHz band at any time interval of continuous transmission.

#### 3.3.2 Measuring Instruments

The section 4.0 of List of Measuring Equipment of this test report is used for test.

#### 3.3.3 Test Procedures

1. The testing follows Measurement Procedure 10.2 Method PKPSD of FCC KDB Publication No. 558074 D01 DTS Meas. Guidance v03r04
2. The RF output of EUT was connected to the spectrum analyzer by RF cable and attenuator. The path loss was compensated to the results for each measurement.
3. Set to the maximum power setting and enable the EUT transmit continuously.
4. Make the measurement with the spectrum analyzer's resolution bandwidth (RBW) = 3 kHz. Video bandwidth VBW = 10 kHz In order to make an accurate measurement, set the span to 1.5 times DTS Channel Bandwidth. (6dB BW)
5. Detector = peak, Sweep time = auto couple, Trace mode = max hold, Allow trace to fully stabilize. Use the peak marker function to determine the maximum power level.
6. Measure and record the results in the test report.
7. The Measured power density (dBm)/ 100kHz is a reference level and used as 20dBc down limit line for Conducted Band Edges and Conducted Spurious Emission.

#### 3.3.4 Test Setup

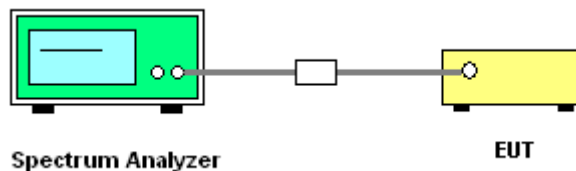



### 3.3.5 Test Result of Power Spectral Density

Test data refers to Appendix A.

### 3.3.6 Test Result of Power Spectral Density Plots (100kHz)

PSD 100kHz Plot on Channel 00

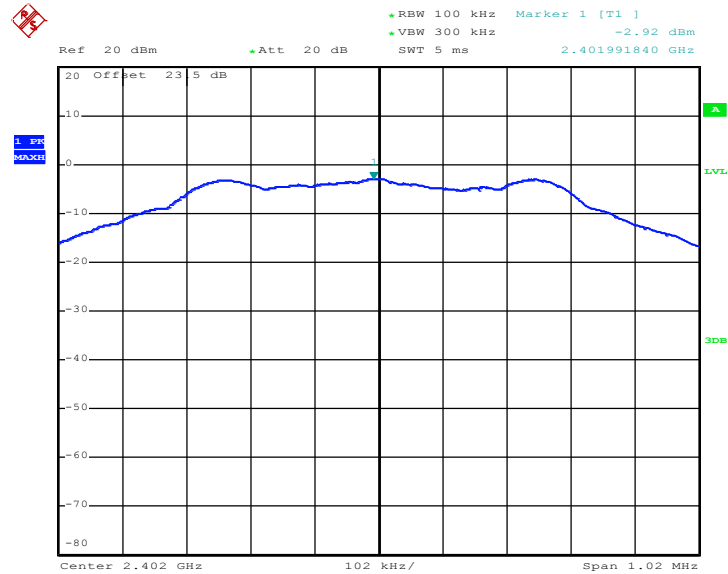

Date: 6.FEB.2016 01:13:57



PSD 100kHz Plot on Channel 19

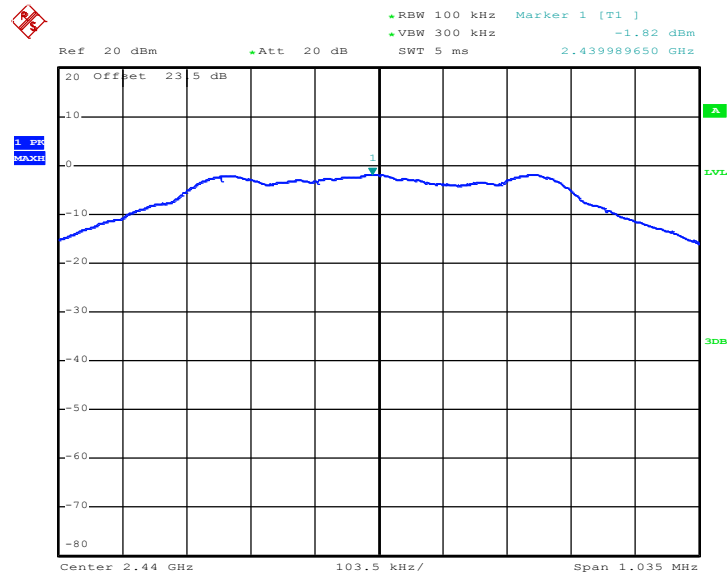

Date: 6.FEB.2016 01:23:08

PSD 100kHz Plot on Channel 39

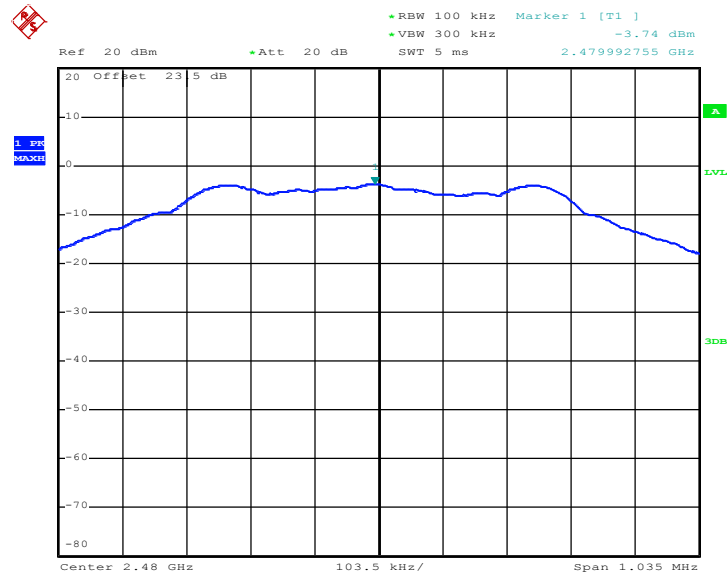

Date: 6.FEB.2016 01:27:29



### 3.3.7 Test Result of Power Spectral Density Plots (3kHz)

PSD 3kHz Plot on Channel 00

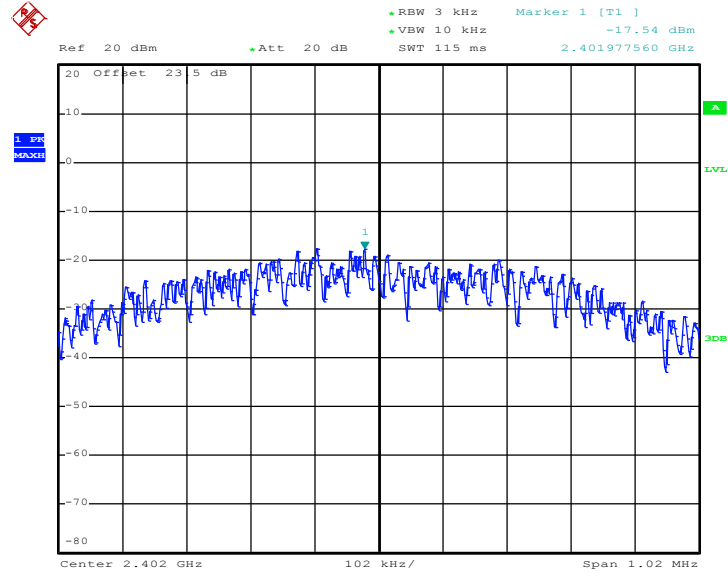

Date: 6.FEB.2016 01:13:26



PSD 3kHz Plot on Channel 19

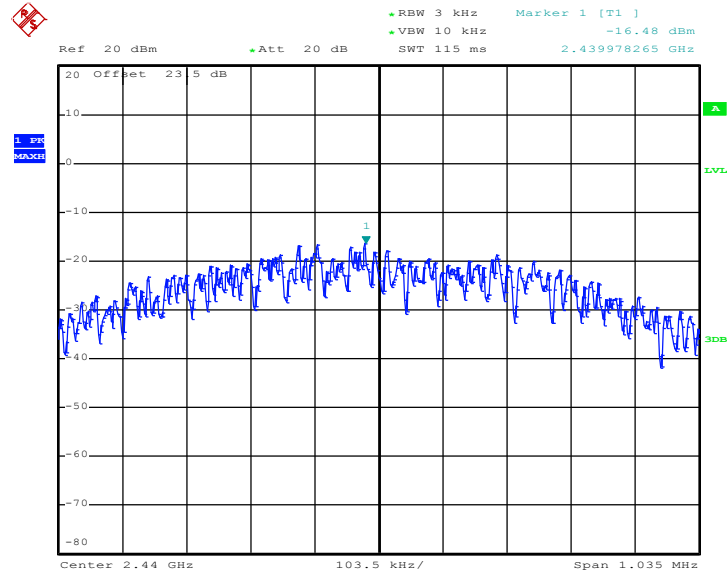

Date: 6.FEB.2016 01:22:55

PSD 3kHz Plot on Channel 39

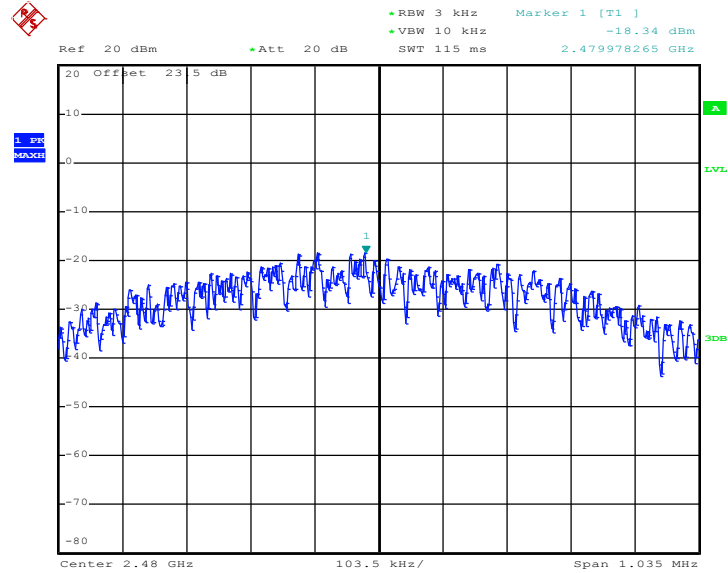

Date: 6.FEB.2016 01:27:11

## 3.4 Conducted Band Edges and Spurious Emission Measurement

### 3.4.1 Limit of Conducted Band Edges and Spurious Emission

All harmonics/spurious must be at least 20 dB down from the highest emission level within the authorized band.

### 3.4.2 Measuring Instruments

The section 4.0 of List of Measuring Equipment of this test report is used for test.

### 3.4.3 Test Procedure

1. The testing follows FCC KDB Publication No. 558074 D01 DTS Meas. Guidance v03r04.
2. The RF output of EUT was connected to the spectrum analyzer by RF cable and attenuator. The path loss was compensated to the results for each measurement.
3. Set to the maximum power setting and enable the EUT transmit continuously.
4. Set RBW = 100 kHz, VBW=300 kHz, Peak Detector. Unwanted Emissions measured in any 100 kHz bandwidth outside of the authorized frequency band shall be attenuated by at least 20 dB relative to the maximum in-band peak PSD level in 100 kHz when maximum peak conducted output power procedure is used. If the transmitter complies with the conducted power limits based on the use of RMS averaging over a time interval, the attenuation required under this paragraph shall be 30 dB instead of 20 dB per 15.247(d).
5. Measure and record the results in the test report.
6. The RF fundamental frequency should be excluded against the limit line in the operating frequency band.

### 3.4.4 Test Setup

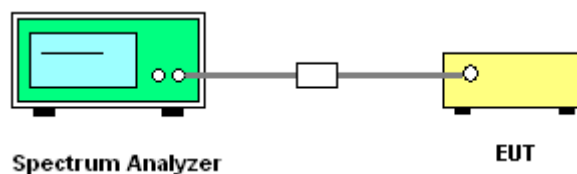





### 3.4.5 Test Result of Conducted Band Edges Plots

Low Band Edge Plot on Channel 00

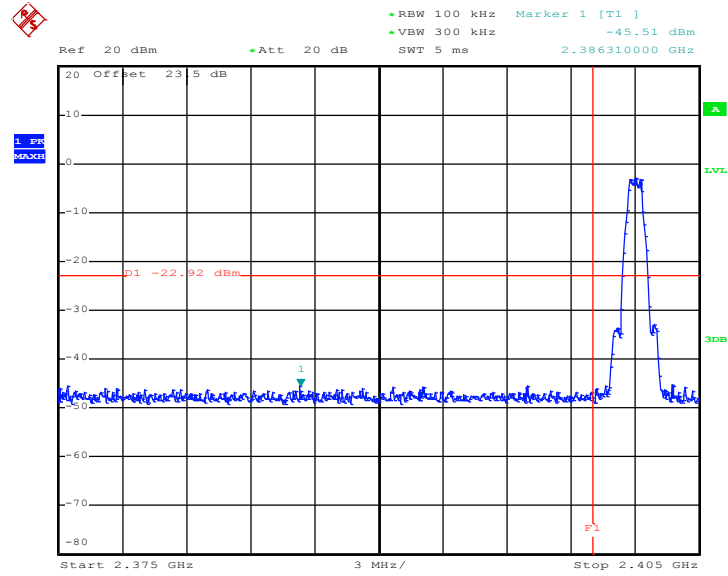

Date: 6.FEB.2016 01:14:56



High Band Edge Plot on Channel 39

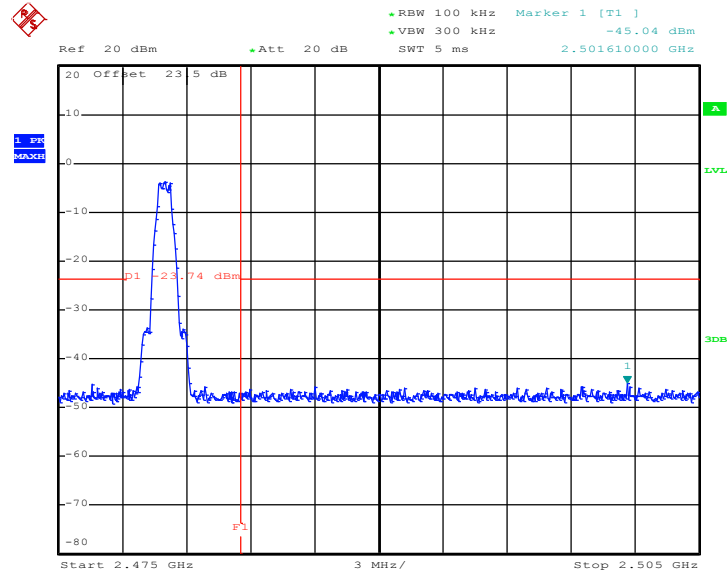

Date: 6.FEB.2016 01:28:53



### 3.4.6 Test Result of Conducted Spurious Emission Plots

#### Conducted Spurious Emission Plot on Bluetooth LE 1Mbps GFSK Channel 00

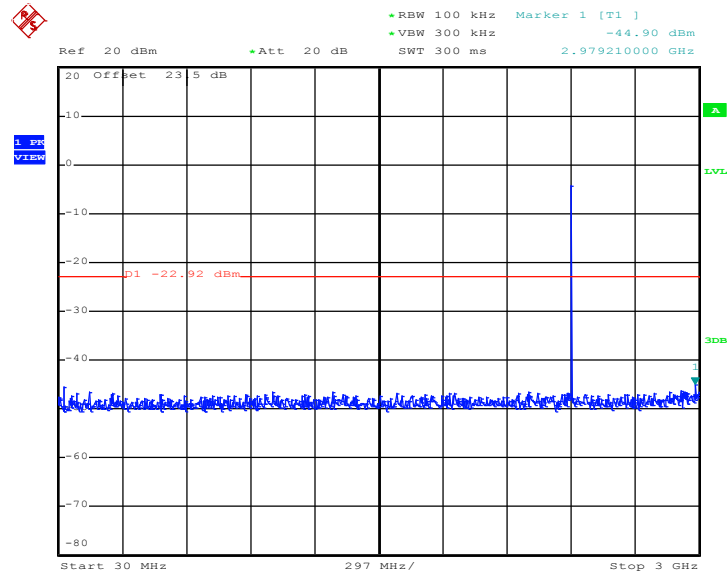

Date: 6.FEB.2016 01:16:36



### Conducted Spurious Emission Plot on Bluetooth LE 1Mbps GFSK Channel 00

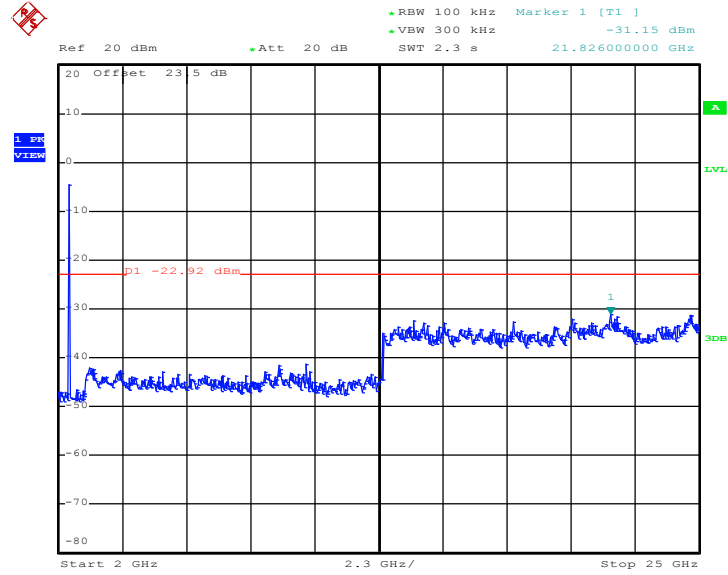

Date: 6.FEB.2016 01:16:44



### Conducted Spurious Emission Plot on Bluetooth LE 1Mbps GFSK Channel 19

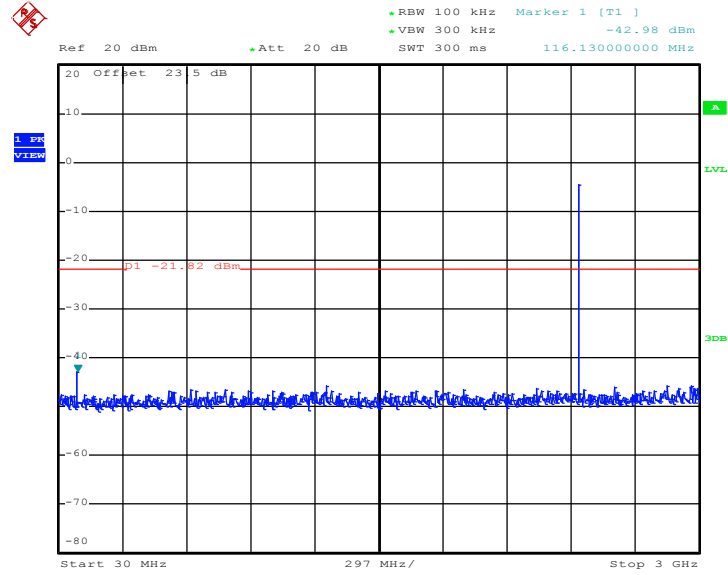

Date: 6.FEB.2016 01:24:51



Conducted Spurious Emission Plot on Bluetooth LE 1Mbps  
GFSK Channel 19

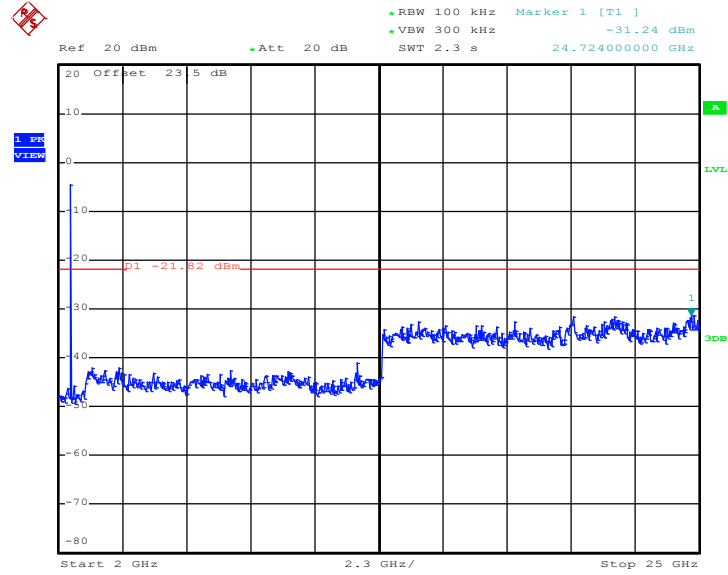

Date: 6.FEB.2016 01:24:59



### Conducted Spurious Emission Plot on Bluetooth LE 1Mbps GFSK Channel 39

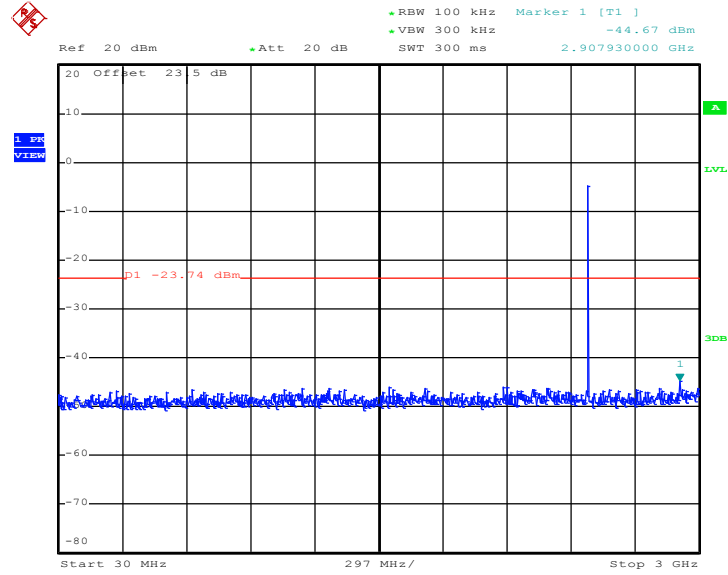

Date: 6.FEB.2016 01:29:05



### Conducted Spurious Emission Plot on Bluetooth LE 1Mbps GFSK Channel 39

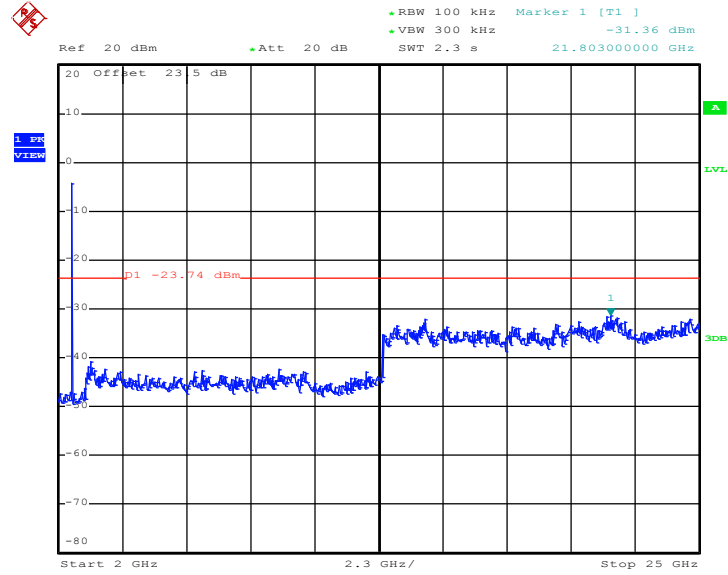

Date: 6.FEB.2016 01:29:14





### 3.5 Radiated Band Edges and Spurious Emission Measurement

#### 3.5.1 Limit of Radiated Band Edges and Spurious Emission

In any 100 kHz bandwidth outside the intentional radiator frequency band, all harmonics/spurious must be at least 20 dB below the highest emission level within the authorized band. If the output power of this device was measured by spectrum analyzer, the attenuation under this paragraph shall be 30 dB instead of 20 dB. In addition, radiated emissions which fall in the restricted bands must also comply with the FCC section 15.209 limits as below.

Frequency (MHz)	Field Strength (microvolts/meter)	Measurement Distance (meters)
0.009 – 0.490	2400/F(kHz)	300
0.490 – 1.705	24000/F(kHz)	30
1.705 – 30.0	30	30
30 – 88	100	3
88 – 216	150	3
216 - 960	200	3
Above 960	500	3

#### 3.5.2 Measuring Instruments

The section 4.0 of List of Measuring Equipment of this test report is used for test.



3.5.3 Test Procedures

1. The testing follows FCC KDB Publication No. 558074 D01 DTS Meas. Guidance v03r04.
2. The EUT was arranged to its worst case and then tune the antenna tower (from 1 m to 4 m) and turntable (from 0 degree to 360 degrees) to find the maximum reading. A pre-amp and a high pass filter are used for the test in order to get better signal level.
3. The EUT was placed on a turntable with 0.8 meter for frequency below 1GHz and 1.5 meter for frequency above 1GHz respectively above ground.
4. The EUT was set 3 meters from the interference receiving antenna, which was mounted on the top of a variable height antenna tower.
5. Corrected Reading: Antenna Factor + Cable Loss + Read Level - Preamp Factor = Level
6. For measurement below 1GHz, If the emission level of the EUT measured by the peak detector is 3 dB lower than the applicable limit, the peak emission level will be reported. Otherwise, the emission measurement will be repeated using the quasi-peak detector and reported.
7. Use the following spectrum analyzer settings:
  - (1) Span shall wide enough to fully capture the emission being measured;
  - (2) Set RBW=100 kHz for  $f < 1 \text{ GHz}$ ;  $\text{VBW} \geq \text{RBW}$ ; Sweep = auto; Detector function = peak; Trace = max hold;
  - (3) Set RBW = 1 MHz, VBW= 3MHz for  $f \geq 1 \text{ GHz}$  for peak measurement.
 

For average measurement:

    - $\text{VBW} = 10 \text{ Hz}$ , when duty cycle is no less than 98 percent.
    - $\text{VBW} \geq 1/T$ , when duty cycle is less than 98 percent where T is the minimum transmission duration over which the transmitter is on and is transmitting at its maximum power control level for the tested mode of operation.

Band	Duty Cycle(%)	T(μs)	1/T(kHz)	VBW Setting
Bluetooth 4.0 - LE	59.87	376	2.659574468	3kHz

### 3.5.4 Test Setup

For radiated emissions below 30MHz

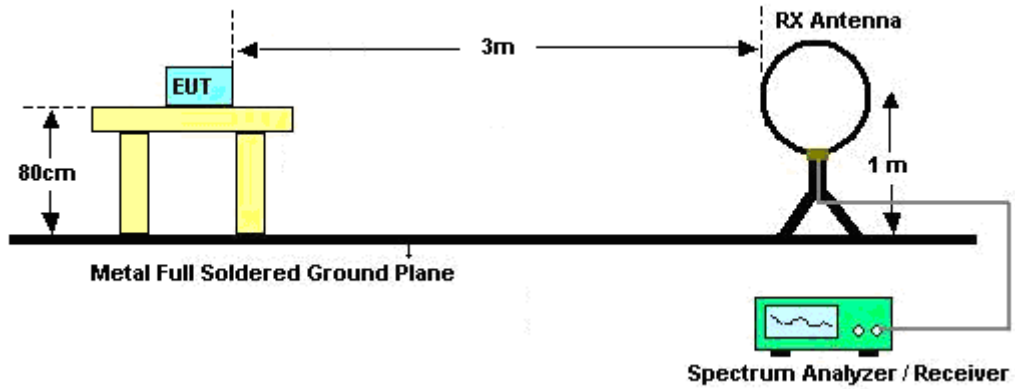

For radiated emissions from 30MHz to 1GHz

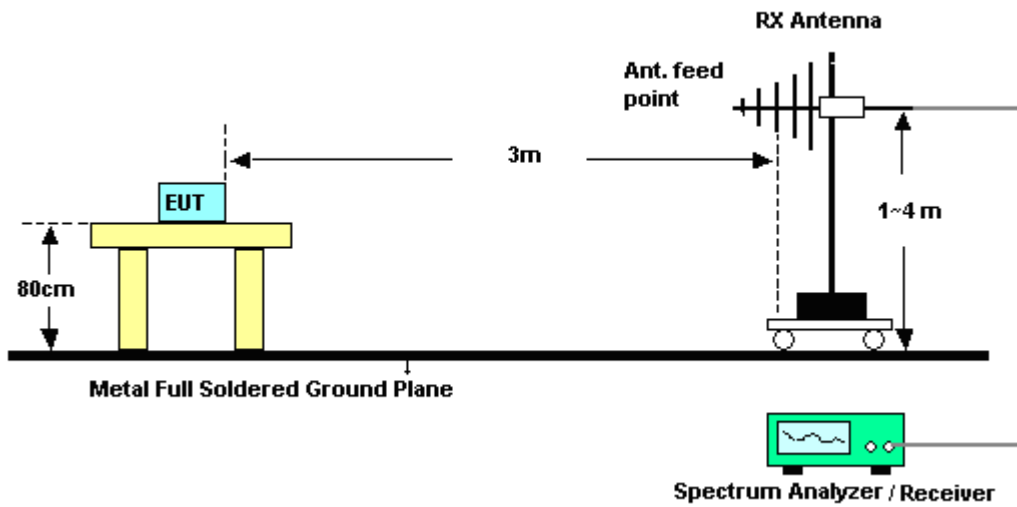

For radiated emissions above 1GHz

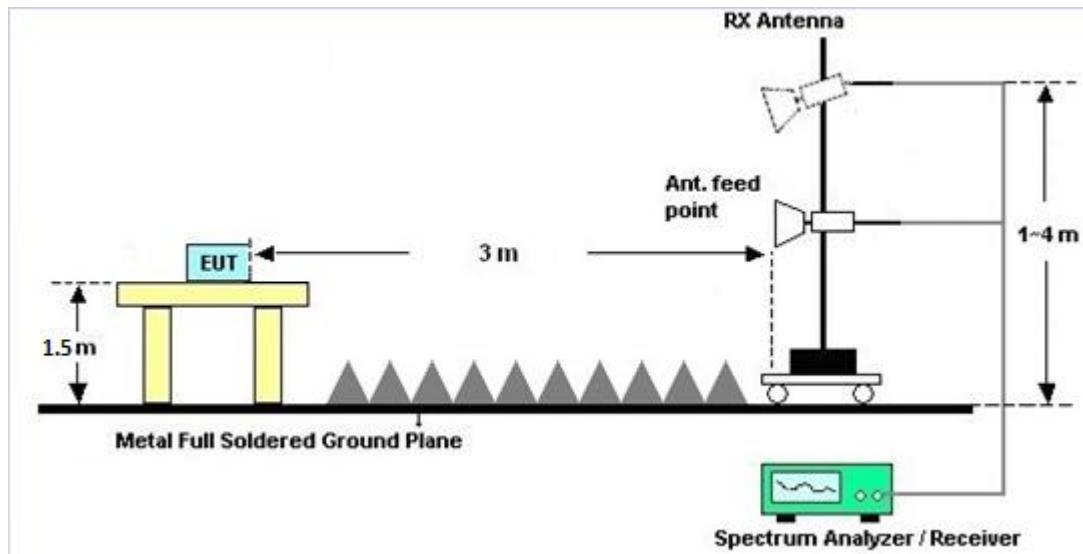

### 3.5.5 Test Results of Radiated Spurious Emissions (9 kHz ~ 30 MHz)

The low frequency, which started from 9 kHz to 30MHz, was pre-scanned and the result which was 20dB lower than the limit line per 15.31(o) was not reported.

### 3.5.6 Test Result of Radiated Spurious at Band Edges

Please refer to Appendix B and C.

### 3.5.7 Test Result of Radiated Spurious Emission (30MHz ~ 10<sup>th</sup> Harmonic)

Please refer to Appendix B and C.



### 3.5.8 Duty Cycle

#### Bluetooth 4.2 - LE

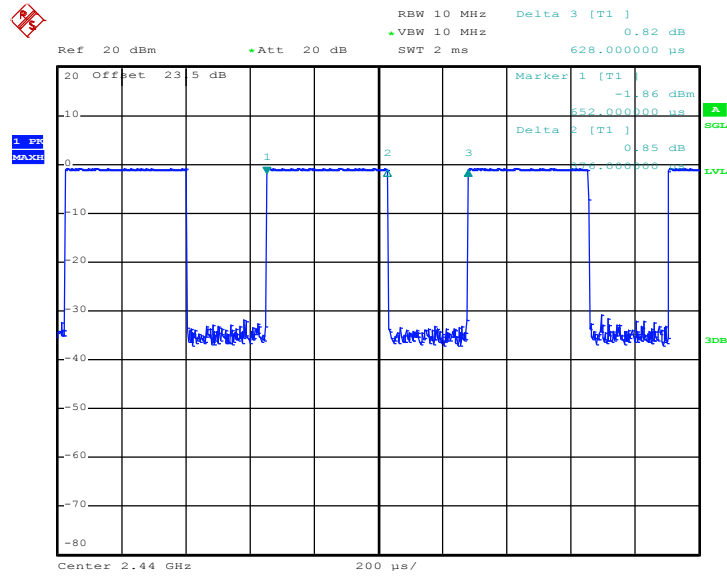

Date: 5.FEB.2016 17:48:43



### 3.6 AC Conducted Emission Measurement

#### 3.6.1 Limit of AC Conducted Emission

For equipment that is designed to be connected to the public utility (AC) power line, the radio frequency voltage that is conducted back onto the AC power line on any frequency or frequencies within the band 150 kHz to 30 MHz shall not exceed the limits in the following table.

Frequency of emission (MHz)	Conducted limit (dB $\mu$ V)	
	Quasi-peak	Average
0.15-0.5	66 to 56*	56 to 46*
0.5-5	56	46
5-30	60	50

\*Decreases with the logarithm of the frequency.

#### 3.6.2 Measuring Instruments

The section 4.0 of List of Measuring Equipment of this test report is used for test.

#### 3.6.3 Test Procedures

1. The EUT was placed 0.4 meter from the conducting wall of the shielding room was kept at least 80 centimeters from any other grounded conducting surface.
2. Connect EUT to the power mains through a line impedance stabilization network (LISN).
3. All the support units are connecting to the other LISN.
4. The LISN provides 50 ohm coupling impedance for the measuring instrument.
5. The FCC states that a 50 ohm, 50 microhenry LISN should be used.
6. Both sides of AC line were checked for maximum conducted interference.
7. The frequency range from 150 kHz to 30 MHz was searched.
8. Set the test-receiver system to Peak Detect Function and specified bandwidth (IF Bandwidth = 9kHz) with Maximum Hold Mode. Then measurement is also conducted by Average Detector and Quasi-Peak Detector Function respectively.

### 3.6.4 Test Setup

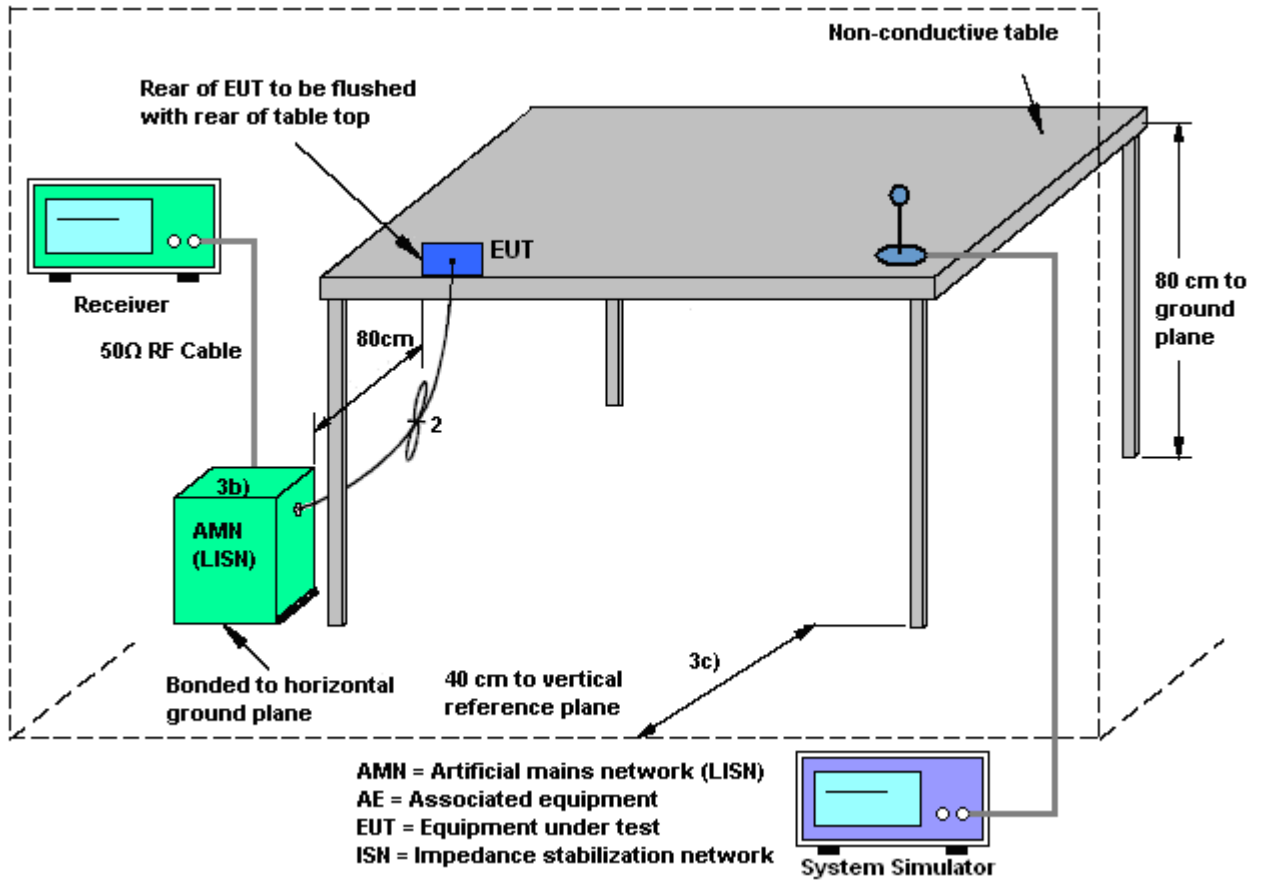



### 3.6.5 Test Result of AC Conducted Emission

Test Mode :	Mode 1	Temperature :	24~25°C
Test Engineer :	Kai-Chun Chu	Relative Humidity :	47~48%
Test Voltage :	120Vac / 60Hz	Phase :	Line
Function Type :	GSM1900 Idle + Bluetooth Link + WLAN (2.4GHz) Link + MP3 + Earphone + Battery 2 + USB Cable (Charging from Adapter)		

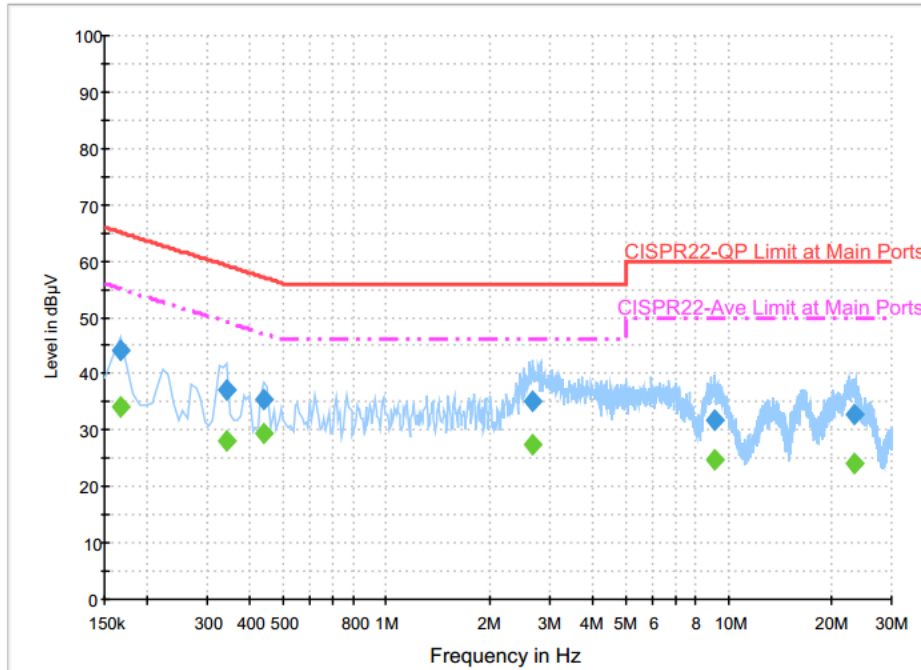

**Final Result : Quasi-Peak**

Frequency (MHz)	Quasi-Peak (dBµV)	Filter	Line	Corr. (dB)	Margin (dB)	Limit (dBµV)
0.166000	44.1	Off	L1	19.6	21.1	65.2
0.342000	37.2	Off	L1	19.6	22.0	59.2
0.438000	35.4	Off	L1	19.6	21.7	57.1
2.678000	35.2	Off	L1	19.4	20.8	56.0
9.174000	31.7	Off	L1	19.7	28.3	60.0
23.438000	32.8	Off	L1	19.9	27.2	60.0

**Final Result : Average**

Frequency (MHz)	Average (dBµV)	Filter	Line	Corr. (dB)	Margin (dB)	Limit (dBµV)
0.166000	34.2	Off	L1	19.6	21.0	55.2
0.342000	28.2	Off	L1	19.6	21.0	49.2
0.438000	29.4	Off	L1	19.6	17.7	47.1
2.678000	27.3	Off	L1	19.4	18.7	46.0
9.174000	24.8	Off	L1	19.7	25.2	50.0
23.438000	24.2	Off	L1	19.9	25.8	50.0





Test Mode :	Mode 1	Temperature :	24~25°C
Test Engineer :	Kai-Chun Chu	Relative Humidity :	47~48%
Test Voltage :	120Vac / 60Hz	Phase :	Neutral
Function Type :	GSM1900 Idle + Bluetooth Link + WLAN (2.4GHz) Link + MP3 + Earphone + Battery 2 + USB Cable (Charging from Adapter)		

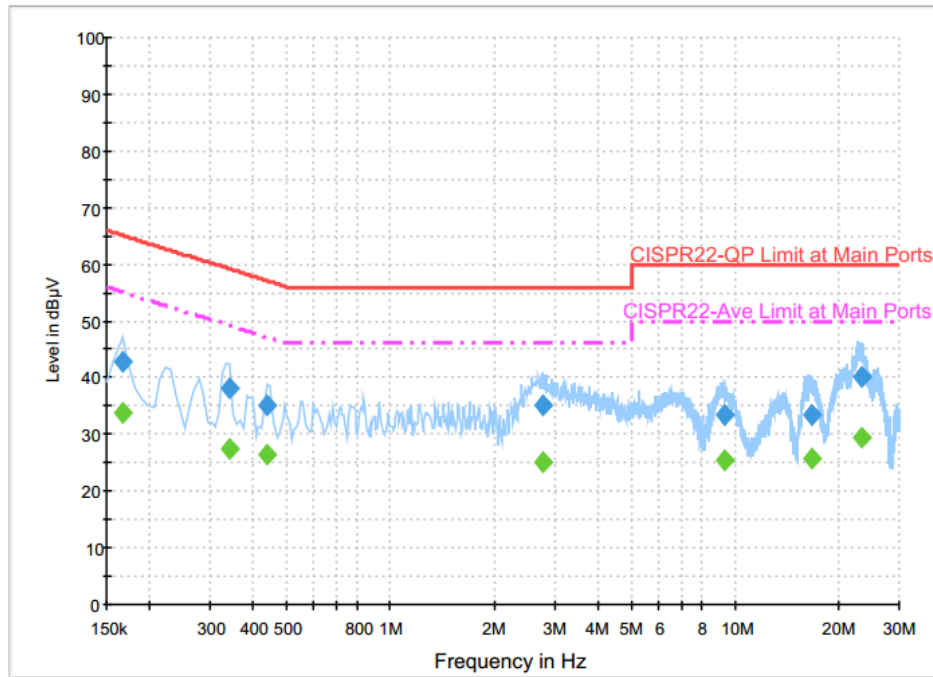

**Final Result : Quasi-Peak**

Frequency (MHz)	Quasi-Peak (dBµV)	Filter	Line	Corr. (dB)	Margin (dB)	Limit (dBµV)
0.166000	43.0	Off	N	19.6	22.2	65.2
0.342000	38.2	Off	N	19.6	21.0	59.2
0.438000	35.2	Off	N	19.6	21.9	57.1
2.758000	35.2	Off	N	19.5	20.8	56.0
9.286000	33.4	Off	N	19.8	26.6	60.0
16.774000	33.5	Off	N	19.9	26.5	60.0
23.262000	40.0	Off	N	20.0	20.0	60.0

**Final Result : Average**

Frequency (MHz)	Average (dBµV)	Filter	Line	Corr. (dB)	Margin (dB)	Limit (dBµV)
0.166000	33.7	Off	N	19.6	21.5	55.2
0.342000	27.5	Off	N	19.6	21.7	49.2
0.438000	26.4	Off	N	19.6	20.7	47.1
2.758000	25.1	Off	N	19.5	20.9	46.0
9.286000	25.3	Off	N	19.8	24.7	50.0
16.774000	25.7	Off	N	19.9	24.3	50.0
23.262000	29.3	Off	N	20.0	20.7	50.0



## **3.7 Antenna Requirements**

### **3.7.1 Standard Applicable**

If directional gain of transmitting antennas is greater than 6dBi, the power shall be reduced by the same level in dB comparing to gain minus 6dBi. The use of a permanently attached antenna or of an antenna that uses a unique coupling to the intentional radiator shall be considered sufficient to comply with the FCC rule.

### **3.7.2 Antenna Anti-Replacement Construction**

An embedded-in antenna design is used.

### **3.7.3 Antenna Gain**

The antenna peak gain of EUT is less than 6 dBi. Therefore, it is not necessary to reduce maximum peak output power limit.



## 4 List of Measuring Equipment

Instrument	Manufacturer	Model No.	Serial No.	Characteristics	Calibration Date	Test Date	Due Date	Remark
Power Meter	Agilent	E4416A	GB412923 44	300MHz~40GHz	Jan. 08, 2016	Feb. 05, 2016 ~ Feb. 06, 2016	Jan. 07, 2017	Conducted (TH05-HY)
Power Sensor	Agilent	E9327A	US404415 48	300MHz~40GHz	Jan. 07, 2016	Feb. 05, 2016 ~ Feb. 06, 2016	Jan. 06, 2017	Conducted (TH05-HY)
Hygrometer	Testo	608-H2	41410069	N/A	Aug. 27, 2015	Feb. 05, 2016 ~ Feb. 06, 2016	Aug. 26, 2016	Conducted (TH05-HY)
Spectrum Analyzer	Rohde & Schwarz	FSP40	100057	9kHz-40GHz	Nov. 23, 2015	Feb. 05, 2016 ~ Feb. 06, 2016	Nov. 22, 2016	Conducted (TH05-HY)
RF Cable	JYEBAO	K30K30-5003 -1.5M40	N/A	0.1MHz~40GHz	Mar. 18, 2015	Feb. 05, 2016 ~ Feb. 06, 2016	Mar. 17, 2016	Conducted (TH05-HY)
AC Power Source	ChainTek	APC-1000W	N/A	N/A	N/A	Feb. 10, 2016	N/A	Conduction (CO05-HY)
EMI Test Receiver	Rohde & Schwarz	ESCI 7	100724	9kHz~7GHz	Aug. 26, 2015	Feb. 10, 2016	Aug. 25, 2016	Conduction (CO05-HY)
Hygrometer	Testo	608-H1	34913912	N/A	Apr. 20, 2015	Feb. 10, 2016	Apr. 19, 2016	Conduction (CO05-HY)
LISN	Rohde & Schwarz	ENV216	100080	9kHz~30MHz	Dec. 02, 2015	Feb. 10, 2016	Dec. 01, 2016	Conduction (CO05-HY)
LF Cable	HUBER + SUHNER	RG-214/U	LF01	N/A	Jan. 06, 2016	Feb. 10, 2016	Jan. 05, 2017	Conduction (CO05-HY)
Loop Antenna	Rohde & Schwarz	HFH2-Z2	100315	9 kHz~30 MHz	Sep. 02, 2015	Feb. 06, 2016~ Feb. 09, 2016	Sep. 01, 2016	Radiation (03CH11-HY)
Horn Antenna	SCHWARZBE CK	BBHA 9170	BBHA9170 584	18GHz- 40GHz	Nov. 02, 2015	Feb. 06, 2016~ Feb. 09, 2016	Nov. 01, 2016	Radiation (03CH11-HY)
Bilog Antenna	TESEQ	CBL 6111D	35414	30MHz~1GHz	Nov. 17, 2015	Feb. 06, 2016~ Feb. 09, 2016	Nov. 16, 2016	Radiation (03CH11-HY)
Horn Antenna	SCHWARZBE CK	BBHA 9120 D	9120D-132 6	1GHz ~ 18GHz	Oct. 08, 2015	Feb. 06, 2016~ Feb. 09, 2016	Oct. 07, 2016	Radiation (03CH11-HY)
Preamplifier	MITEQ	JS44-180040 00-33-8P	1840917	18GHz ~ 40GHz	Jun. 02, 2015	Feb. 06, 2016~ Feb. 09, 2016	Jun. 01, 2016	Radiation (03CH11-HY)
Amplifier	SONOMA	310N	187312	9kHz~1GHz	Nov. 20, 2015	Feb. 06, 2016~ Feb. 09, 2016	Nov. 19, 2016	Radiation (03CH11-HY)
Preamplifier	Keysight	83017A	MY532700 80	1GHz~26.5GHz	Nov. 19, 2015	Feb. 06, 2016~ Feb. 09, 2016	Nov. 18, 2016	Radiation (03CH11-HY)
Preamplifier	MITEQ	AMF-7D-0010 1800-30-10P	1902247	1GHz~18GHz	Jul. 01, 2015	Feb. 06, 2016~ Feb. 09, 2016	Jun. 30, 2016	Radiation (03CH11-HY)
Hygrometer	TECPEL	DTN-303B	TP140325	N/A	Nov. 17, 2015	Feb. 06, 2016~ Feb. 09, 2016	Nov. 16, 2016	Radiation (03CH11-HY)
Spectrum Analyzer	Keysight	N9010A	MY542004 86	10Hz ~ 44GHz	Sep. 24, 2015	Feb. 06, 2016~ Feb. 09, 2016	Sep. 23, 2016	Radiation (03CH11-HY)
EMI Test Receiver	Agilent	N9038A(MXE )	MY532900 53	20Hz to 26.5GHz	Jan. 20, 2016	Feb. 06, 2016~ Feb. 09, 2016	Jan. 19, 2017	Radiation (03CH11-HY)



Instrument	Manufacturer	Model No.	Serial No.	Characteristics	Calibration Date	Test Date	Due Date	Remark
RF Cable	HUBER + SUHNER	SUCOFLEX 104	MY9837/4 MY28419/ 4MY28654 /4	9KHz~30MHz	Sep. 14, 2015	Feb. 06, 2016~ Feb. 09, 2016	Sep. 13, 2016	Radiation (03CH11-HY)
RF Cable	HUBER + SUHNER	SUCOFLEX 104	MY9837/4 MY28419/ 4MY28654 /4	30MHz~40GHz	Nov. 05, 2015	Feb. 06, 2016~ Feb. 09, 2016	Nov. 04, 2016	Radiation (03CH11-HY)
Antenna Mast	EMEC	AM-BS-4500-B	N/A	1~4m	N/A	Feb. 06, 2016~ Feb. 09, 2016	N/A	Radiation (03CH11-HY)
Turn Table	EMEC	TT 2000	N/A	0-360 degree	N/A	Feb. 06, 2016~ Feb. 09, 2016	N/A	Radiation (03CH11-HY)
Filter	Wainwright	WLKS1200-8 SS	SN3	1.2G Low Pass	Oct. 01, 2015	Feb. 06, 2016~ Feb. 09, 2016	Sep. 30, 2016	Radiation (03CH11-HY)
Filter	Microwave	H3G018G1	SN477220	3.0G High Pass	Oct. 01, 2015	Feb. 06, 2016~ Feb. 09, 2016	Sep. 30, 2016	Radiation (03CH11-HY)



## 5 Uncertainty of Evaluation

### Uncertainty of Conducted Emission Measurement (150 kHz ~ 30 MHz)

Measuring Uncertainty for a Level of Confidence of 95% ( $U = 2Uc(y)$ )	2.26
---	------

### Uncertainty of Radiated Emission Measurement (30 MHz ~ 1000 MHz)

Measuring Uncertainty for a Level of Confidence of 95% ( $U = 2Uc(y)$ )	4.90
---	------



## **Appendix A. Conducted Test Results**

**Bluetooth Low Energy**

Test Engineer:	Osolemio Chang	Temperature:	21~25	°C
Test Date:	2016/02/05 ~ 2016/02/06	Relative Humidity:	51~54	%

**TEST RESULTS DATA**  
**6dB and 99% Occupied Bandwidth**

Mod.	Data Rate	N <sub>TX</sub>	CH.	Freq. (MHz)	99% Occupied BW (MHz)	6dB BW (MHz)	6dB BW Limit (MHz)	Pass/Fail
BLE	1Mbps	1	0	2402	1.01	0.68	0.50	Pass
BLE	1Mbps	1	19	2440	1.01	0.69	0.50	Pass
BLE	1Mbps	1	39	2480	1.01	0.69	0.50	Pass

**TEST RESULTS DATA**  
**Peak Power Table**

Mod.	Data Rate	N <sub>TX</sub>	CH.	Freq. (MHz)	Peak Conducted Power (dBm)	Conducted Power Limit (dBm)	DG (dBi)	EIRP Power (dBm)	EIRP Power Limit (dBm)	Pass /Fail
BLE	1Mbps	1	0	2402	0.28	30.00	-0.30	-0.02	36.00	Pass
BLE	1Mbps	1	19	2440	0.99	30.00	-0.30	0.69	36.00	Pass
BLE	1Mbps	1	39	2480	-0.08	30.00	-0.30	-0.38	36.00	Pass

**TEST RESULTS DATA**  
**Average Power Table**  
**(Reporting Only)**

Mod.	Data Rate	N <sub>TX</sub>	CH.	Freq. (MHz)	Duty Factor (dB)	Average Conducted Power (dBm)
BLE	1Mbps	1	0	2402	2.23	-1.91
BLE	1Mbps	1	19	2440	2.23	-0.95
BLE	1Mbps	1	39	2480	2.23	-2.57

**TEST RESULTS DATA**  
**Peak Power Density**

Mod.	Data Rate	N <sub>TX</sub>	CH.	Freq. (MHz)	Peak PSD (dBm /100kHz)	Peak PSD (dBm /3kHz)	DG (dBi)	Peak PSD Limit (dBm /3kHz)	Pass/Fail
BLE	1Mbps	1	0	2402	-2.92	-17.54	-0.30	8.00	Pass
BLE	1Mbps	1	19	2440	-1.82	-16.48	-0.30	8.00	Pass
BLE	1Mbps	1	39	2480	-3.74	-18.34	-0.30	8.00	Pass

Note: PSD (dBm/ 100kHz) is a reference level used for Conducted Band Edges and Conducted Spurious Emission 20dBc limit.



## Appendix B. Radiated Spurious Emission

Test Engineer :	Ken Wu and J.C. Liang	Temperature :	20~22°C
		Relative Humidity :	50~54%

2.4GHz 2400~2483.5MHz

BLE (Band Edge @ 3m)

BLE	Note	Frequency ( MHz )	Level ( dBμV/m )	Over Limit ( dB )	Limit Line ( dBμV/m )	Read Level ( dBμV )	Antenna Factor ( dB/m )	Cable Loss ( dB )	Preamp Factor ( dB )	Ant Pos ( cm )	Table Pos ( deg )	Peak Avg. ( P/A )	Pol. ( H/V )	
BLE CH 00 2402MHz		2382.09	51.54	-22.46	74	51.86	26.96	6.71	33.99	149	155	P	H	
		2371.02	42	-12	54	42.38	26.96	6.65	33.99	149	155	A	H	
	*	2402.17	91.58	-	-	91.84	27.01	6.71	33.98	149	155	P	H	
	*	2402.09	91.36	-	-	91.62	27.01	6.71	33.98	149	155	A	H	
													H	
														H
			2369.04	50.62	-23.38	74	51	26.96	6.65	33.99	353	80	P	V
			2383.71	41.86	-12.14	54	42.18	26.96	6.71	33.99	353	80	A	V
	*		2402.25	87.81	-	-	88.07	27.01	6.71	33.98	353	80	P	V
	*		2402	87.51	-	-	87.77	27.01	6.71	33.98	353	80	A	V
														V
														V
BLE CH 19 2440MHz		2352.3	51.1	-22.9	74	51.53	26.91	6.65	33.99	147	154	P	H	
		2368.32	41.68	-12.32	54	42.11	26.91	6.65	33.99	147	154	A	H	
	*	2440.16	92.36	-	-	92.43	27.16	6.74	33.97	147	154	P	H	
	*	2440.08	92.11	-	-	92.18	27.16	6.74	33.97	147	154	A	H	
			2490.36	51.41	-22.59	74	51.29	27.3	6.77	33.95	147	154	P	H
			2487.72	42.57	-11.43	54	42.45	27.3	6.77	33.95	147	154	A	H
			2370.57	51.05	-22.95	74	51.43	26.96	6.65	33.99	304	84	P	V
			2385.06	42.06	-11.94	54	42.38	26.96	6.71	33.99	304	84	A	V
	*		2439.83	89.37	-	-	89.44	27.16	6.74	33.97	304	84	P	V
	*		2440.08	89.09	-	-	89.16	27.16	6.74	33.97	304	84	A	V
			2496.12	51.45	-22.55	74	51.32	27.3	6.77	33.94	304	84	P	V
			2486.16	42.54	-11.46	54	42.47	27.25	6.77	33.95	304	84	A	V





<b>BLE CH 39 2480MHz</b>	*	2479.83	89.59	-	-	89.52	27.25	6.77	33.95	142	150	P	H
	*	2479.99	89.25	-	-	89.18	27.25	6.77	33.95	142	150	A	H
		2499.88	51.71	-22.29	74	51.58	27.3	6.77	33.94	142	150	P	H
		2484.36	42.19	-11.81	54	42.12	27.25	6.77	33.95	142	150	A	H
													H
													H
	*	2479.83	85.82	-	-	85.75	27.25	6.77	33.95	329	81	P	V
	*	2480.08	85.46	-	-	85.39	27.25	6.77	33.95	329	81	A	V
		2490.48	51.02	-22.98	74	50.9	27.3	6.77	33.95	329	81	P	V
		2497.12	42.3	-11.7	54	42.17	27.3	6.77	33.94	329	81	A	V
													V
													V
<b>Remark</b>	1. No other spurious found. 2. All results are PASS against Peak and Average limit line.												



2.4GHz 2400~2483.5MHz

BLE (Harmonic @ 3m)

BLE	Note	Frequency ( MHz )	Level ( dBµV/m )	Over Limit ( dB )	Limit Line ( dBµV/m )	Read Level ( dBµV )	Antenna Factor ( dB/m )	Cable Loss ( dB )	Preamp Factor ( dB )	Ant Pos ( cm )	Table Pos ( deg )	Peak Avg. ( P/A )	Pol. ( H/V )	
BLE CH 00 2402MHz		4804	33.51	-40.49	74	56.82	31.1	10.68	65.09	100	0	P	H	
													H	
													H	
													H	
			4804	33.87	-40.13	74	57.18	31.1	10.68	65.09	100	0	P	V
														V
														V
BLE CH 19 2440MHz		4880	34.69	-39.31	74	58.02	31.21	10.48	65.02	100	0	P	H	
		7320	38.67	-35.33	74	55.34	36.12	12.28	65.07	100	0	P	H	
													H	
													H	
			4880	35.17	-38.83	74	58.5	31.21	10.48	65.02	100	0	P	V
			7320	37.56	-36.44	74	54.23	36.12	12.28	65.07	100	0	P	V
														V
BLE CH 39 2480MHz		4960	34.71	-39.29	74	58.01	31.34	10.29	64.93	100	0	P	H	
		7440	37.94	-36.06	74	54.09	36.39	12.55	65.09	100	0	P	H	
													H	
													H	
			4960	33.16	-40.84	74	56.46	31.34	10.29	64.93	100	0	P	V
			7440	38.08	-35.92	74	54.23	36.39	12.55	65.09	100	0	P	V
														V
Remark	1. No other spurious found.													
	2. All results are PASS against Peak and Average limit line.													



Emission below 1GHz

2.4GHz BLE (LF)

BLE	Note	Frequency	Level	Over	Limit	Read	Antenna	Cable	Preamp	Ant	Table	Peak	Pol.	
		( MHz )	( dBμV/m )	( dB )	( dBμV/m )	( dBμV )	( dB/m )	( dB )	( dB )	( cm )	( deg )	( P/A )	( H/V )	
2.4GHz BLE LF		102.09	25.11	-18.39	43.5	39.09	16.32	1.48	31.78			P	H	
		136.38	23	-20.5	43.5	35.37	17.93	1.48	31.78			P	H	
		233.85	21.5	-24.5	46	34.07	17.22	1.98	31.77			P	H	
		477.8	25.08	-20.92	46	30.34	23.75	2.86	31.87			P	H	
		757.1	29.57	-16.43	46	30.13	27.79	3.62	31.97			P	H	
		952.4	32.29	-13.71	46	28.83	30.59	3.89	31.02	100	87	P	H	
														H
														H
														H
														H
														H
														H
			41.07	31.34	-8.66	40	42.49	19.74	0.93	31.82	248	68	P	V
			77.25	22.28	-17.72	40	39.55	13.35	1.17	31.79			P	V
			112.35	25.44	-18.06	43.5	38.4	17.34	1.48	31.78			P	V
			486.9	24.86	-21.14	46	30	23.88	2.86	31.88			P	V
			672.4	27.95	-18.05	46	30.12	26.42	3.45	32.04			P	V
			937.7	32.74	-13.26	46	29.74	30.27	3.86	31.13			P	V
														V
														V
													V	
													V	
													V	
													V	
Remark	1. No other spurious found. 2. All results are PASS against limit line.													



**Note symbol**

*	<b>Fundamental Frequency</b> which can be ignored. However, the level of any unwanted emissions shall not exceed the level of the fundamental frequency.
!	Test result is <b>over limit</b> line.
P/A	<b>Peak</b> or <b>Average</b>
H/V	<b>Horizontal</b> or <b>Vertical</b>



A calculation example for radiated spurious emission is shown as below:

WIFI	Note	Frequency	Level	Over	Limit	Read	Antenna	Cable	Preamp	Ant	Table	Peak	Pol.
Ant.				Limit	Line	Level	Factor	Loss	Factor	Pos	Pos	Avg.	
1+2		( MHz )	( dBμV/m )	( dB )	( dBμV/m )	( dBμV )	( dB/m )	( dB )	( dB )	( cm )	( deg )	( P/A )	( H/V )
802.11b		2390	55.45	-18.55	74	54.51	32.22	4.58	35.86	103	308	P	H
CH 01													
2412MHz		2390	43.54	-10.46	54	42.6	32.22	4.58	35.86	103	308	A	H

- Level(dBμV/m) =  
Antenna Factor(dB/m) + Cable Loss(dB) + Read Level(dBμV) - Preamp Factor(dB)
- Over Limit(dB) = Level(dBμV/m) – Limit Line(dBμV/m)

**For Peak Limit @ 2390MHz:**

- Level(dBμV/m)  
= Antenna Factor(dB/m) + Cable Loss(dB) + Read Level(dBμV) - Preamp Factor(dB)  
= 32.22(dB/m) + 4.58(dB) + 54.51(dBμV) – 35.86 (dB)  
= 55.45 (dBμV/m)
- Over Limit(dB)  
= Level(dBμV/m) – Limit Line(dBμV/m)  
= 55.45(dBμV/m) – 74(dBμV/m)  
= -18.55(dB)

**For Average Limit @ 2390MHz:**

- Level(dBμV/m)  
= Antenna Factor(dB/m) + Cable Loss(dB) + Read Level(dBμV) - Preamp Factor(dB)  
= 32.22(dB/m) + 4.58(dB) + 42.6(dBμV) – 35.86 (dB)  
= 43.54 (dBμV/m)
- Over Limit(dB)  
= Level(dBμV/m) – Limit Line(dBμV/m)  
= 43.54(dBμV/m) – 54(dBμV/m)  
= -10.46(dB)

**Both peak and average measured complies with the limit line, so test result is “PASS”.**



## Appendix C. Radiated Spurious Emission

Test Engineer :	Ken Wu and J.C. Liang	Temperature :	20~22°C
		Relative Humidity :	50~54%

### Note symbol

-L	Low channel location
-R	High channel location



2.4GHz 2400~2483.5MHz

BLE (Band Edge @ 3m)

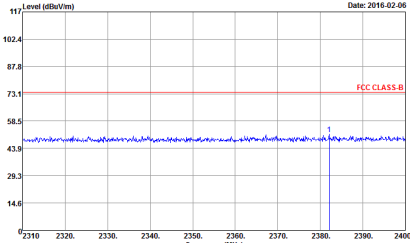
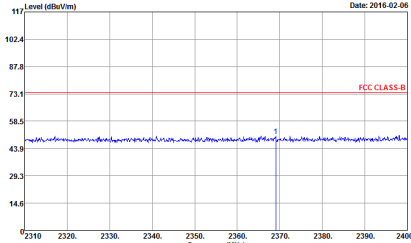
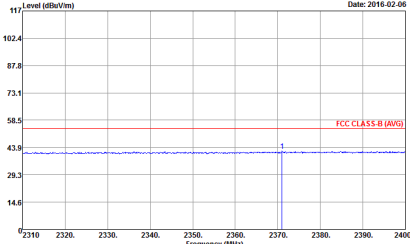
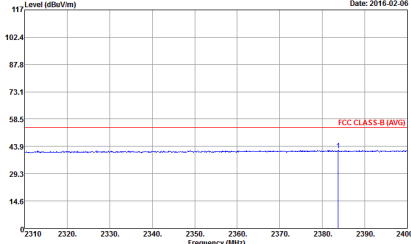
BLE	2.4GHz 2400~2483.5MHz Band Edge @ 3m	
ANT	BLE CH00 2402MHz	
1	Horizontal	Vertical
Peak	 <p>Level (dBuV/m) vs Frequency (MHz) plot for Horizontal Peak. The plot shows a signal level around 43.8 dBuV/m with a peak at approximately 2370 MHz. A red horizontal line indicates the FCC CLASS-B limit at 73.1 dBuV/m. The x-axis ranges from 2310 to 2400 MHz, and the y-axis ranges from 0 to 117 dBuV/m.</p> <p>Site : 03CH11-HY  Condition : FCC CLASS-B 3m HORN 9120D-HF HORIZONTAL  RBW:1000.000KHz VBW:3000.000KHz SWT:Auto  Detector : Peak</p>	 <p>Level (dBuV/m) vs Frequency (MHz) plot for Vertical Peak. The plot shows a signal level around 43.8 dBuV/m with a peak at approximately 2370 MHz. A red horizontal line indicates the FCC CLASS-B limit at 73.1 dBuV/m. The x-axis ranges from 2310 to 2400 MHz, and the y-axis ranges from 0 to 117 dBuV/m.</p> <p>Site : 03CH11-HY  Condition : FCC CLASS-B 3m HORN 9120D-HF VERTICAL  RBW:1000.000KHz VBW:3000.000KHz SWT:Auto  Detector : Peak</p>
Avg.	 <p>Level (dBuV/m) vs Frequency (MHz) plot for Horizontal Avg. The plot shows an average signal level around 43.8 dBuV/m with a peak at approximately 2370 MHz. A red horizontal line indicates the FCC CLASS-B (AVG) limit at 58.5 dBuV/m. The x-axis ranges from 2310 to 2400 MHz, and the y-axis ranges from 0 to 117 dBuV/m.</p> <p>Site : 03CH11-HY  Condition : FCC CLASS-B (AVG) 3m HORN 9120D-HF HORIZONTAL  RBW:1000.000KHz VBW:3.000KHz SWT:Auto  Detector : Peak</p>	 <p>Level (dBuV/m) vs Frequency (MHz) plot for Vertical Avg. The plot shows an average signal level around 43.8 dBuV/m with a peak at approximately 2370 MHz. A red horizontal line indicates the FCC CLASS-B (AVG) limit at 58.5 dBuV/m. The x-axis ranges from 2310 to 2400 MHz, and the y-axis ranges from 0 to 117 dBuV/m.</p> <p>Site : 03CH11-HY  Condition : FCC CLASS-B (AVG) 3m HORN 9120D-HF VERTICAL  RBW:1000.000KHz VBW:3.000KHz SWT:Auto  Detector : Peak</p>

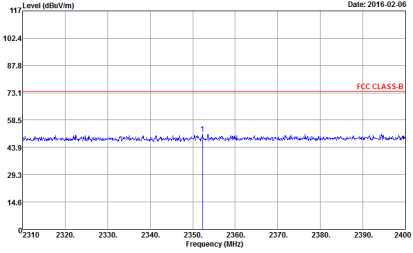
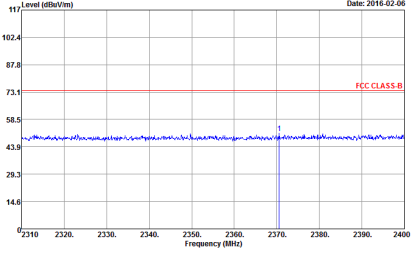
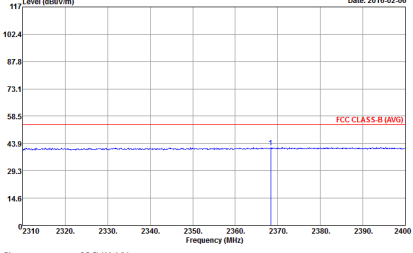
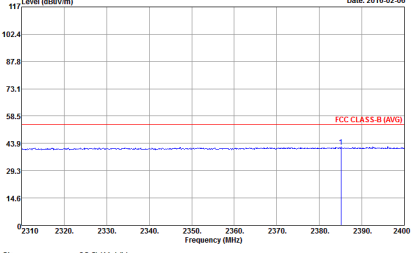

BLE	2.4GHz 2400~2483.5MHz Band Edge @ 3m	
ANT	BLE CH19 2440MHz - L	
1	Horizontal	Vertical
Peak	 <p>Level (dBuV/m) vs Frequency (MHz) plot for Horizontal orientation. The y-axis ranges from 0 to 117 dBuV/m, and the x-axis ranges from 2310 to 2400 MHz. A red horizontal line indicates the FCC CLASS-B limit at 73.1 dBuV/m. A blue signal trace shows a peak at approximately 2370 MHz, reaching about 85 dBuV/m.</p> <p>Site : 03CH11-HY            Condition : FCC CLASS-B 3m HORN 9120D-HF HORIZONTAL            RBW:1000.000KHz VBW:3000.000KHz SWT:Auto            Detector : Peak</p>	 <p>Level (dBuV/m) vs Frequency (MHz) plot for Vertical orientation. The y-axis ranges from 0 to 117 dBuV/m, and the x-axis ranges from 2310 to 2400 MHz. A red horizontal line indicates the FCC CLASS-B limit at 73.1 dBuV/m. A blue signal trace shows a peak at approximately 2370 MHz, reaching about 85 dBuV/m.</p> <p>Site : 03CH11-HY            Condition : FCC CLASS-B 3m HORN 9120D-HF VERTICAL            RBW:1000.000KHz VBW:3000.000KHz SWT:Auto            Detector : Peak</p>
Avg.	 <p>Level (dBuV/m) vs Frequency (MHz) plot for Horizontal orientation showing average values. The y-axis ranges from 0 to 117 dBuV/m, and the x-axis ranges from 2310 to 2400 MHz. A red horizontal line indicates the FCC CLASS-B (AVG) limit at 58.5 dBuV/m. A blue signal trace shows a peak at approximately 2370 MHz, reaching about 45 dBuV/m.</p> <p>Site : 03CH11-HY            Condition : FCC CLASS-B (AVG) 3m HORN 9120D-HF HORIZONTAL            RBW:1000.000KHz VBW:3.000KHz SWT:Auto            Detector : Peak</p>	 <p>Level (dBuV/m) vs Frequency (MHz) plot for Vertical orientation showing average values. The y-axis ranges from 0 to 117 dBuV/m, and the x-axis ranges from 2310 to 2400 MHz. A red horizontal line indicates the FCC CLASS-B (AVG) limit at 58.5 dBuV/m. A blue signal trace shows a peak at approximately 2370 MHz, reaching about 45 dBuV/m.</p> <p>Site : 03CH11-HY            Condition : FCC CLASS-B (AVG) 3m HORN 9120D-HF VERTICAL            RBW:1000.000KHz VBW:3.000KHz SWT:Auto            Detector : Peak</p>



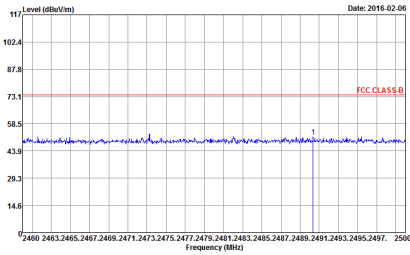
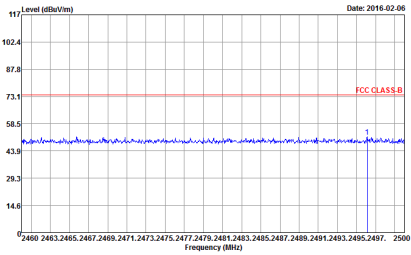
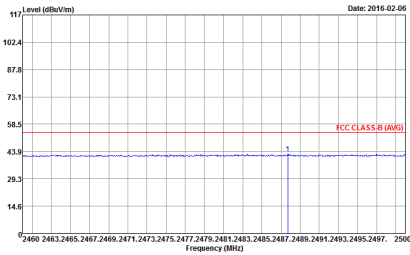
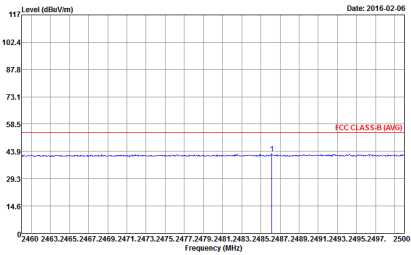

BLE	2.4GHz 2400~2483.5MHz Band Edge @ 3m	
ANT	BLE CH19 2440MHz - R	
1	Horizontal	Vertical
Peak	 <p>Site : 03CH11-HY Condition : FCC CLASS-B 3m HORN 9120D-HF HORIZONTAL Detector : Peak</p>	 <p>Site : 03CH11-HY Condition : FCC CLASS-B 3m HORN 9120D-HF VERTICAL Detector : Peak</p>
Avg.	 <p>Site : 03CH11-HY Condition : FCC CLASS-B (AVG) 3m HORN 9120D-HF HORIZONTAL Detector : Peak</p>	 <p>Site : 03CH11-HY Condition : FCC CLASS-B (AVG) 3m HORN 9120D-HF VERTICAL Detector : Peak</p>



BLE	2.4GHz 2400~2483.5MHz Band Edge @ 3m	
ANT	BLE CH39 2480MHz	
1	Horizontal	Vertical
Peak	<p>Site : 03CH11-HY            Condition : FCC CLASS-B 3m HORN 9120D-HF HORIZONTAL            RBW:1000.000KHz VBW:3000.000KHz SWT:Auto            Detector : Peak</p>	<p>Site : 03CH11-HY            Condition : FCC CLASS-B 3m HORN 9120D-HF VERTICAL            RBW:1000.000KHz VBW:3000.000KHz SWT:Auto            Detector : Peak</p>
Avg.	<p>Site : 03CH11-HY            Condition : FCC CLASS-B (AVG) 3m HORN 9120D-HF HORIZONTAL            RBW:1000.000KHz VBW:3.000KHz SWT:Auto            Detector : Peak</p>	<p>Site : 03CH11-HY            Condition : FCC CLASS-B (AVG) 3m HORN 9120D-HF VERTICAL            RBW:1000.000KHz VBW:3.000KHz SWT:Auto            Detector : Peak</p>



2.4GHz 2400~2483.5MHz

BLE (Harmonic @ 3m)

BLE	2.4GHz 2400~2483.5MHz Harmonic @ 3m	
ANT	BLE CH00 2402MHz	
1	Horizontal	Vertical
Peak Avg.	<p>Site : 03CH11-HY Condition : FCC CLASS-B 3m 9170 SHF HORM_150809 HORIZONTAL Detector : Peak</p>	<p>Site : 03CH11-HY Condition : FCC CLASS-B 3m 9170 SHF HORM_150809 VERTICAL Detector : Peak</p>



<b>BLE</b>	<b>2.4GHz 2400~2483.5MHz Harmonic @ 3m</b>	
<b>ANT</b>	<b>BLE CH19 2440MHz</b>	
<b>1</b>	<b>Horizontal</b>	<b>Vertical</b>
<b>Peak Avg.</b>	<p>Site : 03CH11-HY Condition : FCC CLASS-B 3m 9170 SHF HORM_150809 HORIZONTAL Detector : Peak</p>	<p>Site : 03CH11-HY Condition : FCC CLASS-B 3m 9170 SHF HORM_150809 VERTICAL Detector : Peak</p>

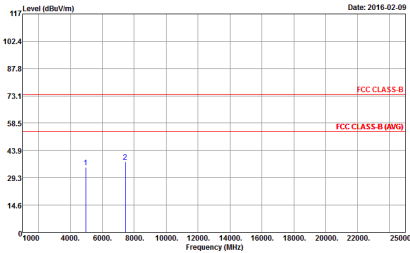
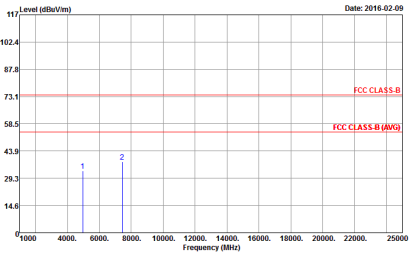

BLE	2.4GHz 2400~2483.5MHz Band Edge @ 3m	
ANT	BLE CH39 2480MHz	
1	Horizontal	Vertical
Peak	 <p>Site : 03CH11-HY Condition : FCC CLASS-B 3m 9170 SHF HORM_150809 HORIZONTAL Detector : Peak</p>	 <p>Site : 03CH11-HY Condition : FCC CLASS-B 3m 9170 SHF HORM_150809 VERTICAL Detector : Peak</p>



Emission below 1GHz

2.4GHz BLE (LF)

BLE	2.4GHz 2400~2483.5MHz	
ANT	BLE LF	
1	Horizontal	Vertical
QP / Peak	<p>Site : 03CH11-1#Y Condition : FCC CLASS-B 3m BT-LOG 61110-LF_ETC HORIZONTAL Detector : Peak</p>	<p>Site : 03CH11-1#Y Condition : FCC CLASS-B 3m BT-LOG 61110-LF_ETC VERTICAL Detector : Peak</p>