



C2PC CERTIFICATION TEST REPORT

Report Number. : 16U23577-E1V3

Applicant : SONY MOBILE COMMUNICATIONS INC.
4-12-3 HIGASHI-SHINAGAWA,
SHINAGAWA -KU, TOKYO, 140-0002, JAPAN

FCC ID : PY7-PM0943

EUT Description : GSM/WCDMA/LTE Phone with BT, DTS/UNII a/b/g/n/ac &
NFC

Test Standard(s) : FCC CFR47 PART 22 SUBPART H
FCC CFR47 PART 90 SUBPART S

Date of Issue:

Wednesday, June 08, 2016

Prepared by:

UL Verification Services Inc.
47173 Benicia Street
Fremont, CA 94538, U.S.A.
TEL: (510) 771-1000
FAX: (510) 661-0888



NVLAP LAB CODE 200065-0

Revision History

<u>Rev.</u>	<u>Issue Date</u>	<u>Revisions</u>	<u>Revised By</u>
V1	6/6/2016	Initial Issue	C.S.OOI
V2	6/7/2016	Update Section 14.1 & 15	J. WU
V3	6/8/2016	Update Section 7	J. WU

TABLE OF CONTENTS

1. ATTESTATION OF TEST RESULTS 5

2. TEST METHODOLOGY 6

3. FACILITIES AND ACCREDITATION 6

4. CALIBRATION AND UNCERTAINTY 6

 4.1. *MEASURING INSTRUMENT CALIBRATION 6*

 4.2. *SAMPLE CALCULATION 6*

 4.3. *MEASUREMENT UNCERTAINTY 7*

5. EQUIPMENT UNDER TEST 8

 5.1. *DESCRIPTION OF EUT 8*

 5.2. *MAXIMUM OUTPUT POWER (LTE)..... 9*

 5.3. *DESCRIPTION OF AVAILABLE ANTENNAS 10*

 5.4. *DESCRIPTION OF TEST SETUP..... 11*

6. TEST AND MEASUREMENT EQUIPMENT 14

7. SUMMARY TABLE 15

8. RF POWER OUTPUT VERIFICATION..... 16

 8.1. *LTE OUTPUT POWER RESULT 16*

9. PEAK TO AVERAGE RATIO 19

 9.1. *CONDUCTED PEAK TO AVERAGE RESULT..... 20*

10. OCCUPIED BANDWIDTH..... 22

 10.1. *OCCUPIED BANDWIDTH RESULTS AND PLOTS..... 23*

11. BAND EDGE EMISSIONS 26

 11.1. *BAND EDGE PLOTS..... 27*

 11.2. *EMISSION MASK PLOTS 34*

12. OUT OF BAND EMISSIONS 37

 12.1. *OUT OF BAND EMISSIONS RESULT AND PLOTS 38*

13. FREQUENCY STABILITY 41

 13.1. *FREQUENCY STABILITY RESULTS..... 42*

14. RADIATED TEST RESULTS 43

 14.1. *RADIATED POWER (ERP & EIRP)..... 43*

 14.1.1. *ERP/EIRP RESULTS AND TABLE 44*

 14.2. *FIELD STRENGTH OF SPURIOUS RADIATION 47*

 14.2.1. *SPURIOUS RADIATION PLOTS..... 48*

15. SETUP PHOTOS51

1. ATTESTATION OF TEST RESULTS

COMPANY NAME: SONY MOBILE COMMUNICATIONS, INC.
EUT DESCRIPTION: GSM/WCDMA/LTE Phone with BT, DTS/UNII a/b/g/n/ac & NFC
SERIAL NUMBER: CB512A0R0S (Conducted), CB512A3UG4 (Radiated)
DATE TESTED: JUNE 2 - 3, 2016

APPLICABLE STANDARDS	
STANDARD	TEST RESULTS
FCC PART 22H, 90S	PASS

UL Verification Services Inc. tested the above equipment in accordance with the requirements set forth in the above standards. All indications of Pass/Fail in this report are opinions expressed by UL Verification Services Inc. based on interpretations and/or observations of test results. Measurement Uncertainties were not taken into account and are published for informational purposes only. The test results show that the equipment tested is capable of demonstrating compliance with the requirements as documented in this report.

Note: The results documented in this report apply only to the tested sample, under the conditions and modes of operation as described herein. This document may not be altered or revised in any way unless done so by UL Verification Services Inc. and all revisions are duly noted in the revisions section. Any alteration of this document not carried out by UL Verification Services Inc. will constitute fraud and shall nullify the document. This report must not be used by the client to claim product certification, approval, or endorsement by NVLAP, NIST, any agency of the Federal Government, or any agency of any government.

Approved & Released For
UL Verification Services Inc. By:

Prepared By:



CHOON OOI
CONSUMER TECHNOLOGY DIVISION
WISE PROJECT LEAD
UL VERIFICATION SERVICES INC

KIYA KEDIDA
CONSUMER TECHNOLOGY DIVISION
WISE LAB ENGINEER
UL VERIFICATION SERVICES INC

2. TEST METHODOLOGY

The tests documented in this report were performed in accordance with TIA-603-D, FCC CFR 47 Part 22, and FCC CFR 47 Part 90.

3. FACILITIES AND ACCREDITATION

The test sites and measurement facilities used to collect data are located at 47173 and 47266 Benicia Street, Fremont, California, USA. Line conducted emissions are measured only at the 47173 address. The following table identifies which facilities were utilized for radiated emission measurements documented in this report. Specific facilities are also identified in the test results sections.

47173 Benicia Street	47266 Benicia Street
<input type="checkbox"/> Chamber A	<input type="checkbox"/> Chamber D
<input checked="" type="checkbox"/> Chamber B	<input type="checkbox"/> Chamber E
<input type="checkbox"/> Chamber C	<input type="checkbox"/> Chamber F
	<input type="checkbox"/> Chamber G
	<input type="checkbox"/> Chamber H

The above test sites and facilities are covered under FCC Test Firm Registration # 208313.

UL Verification Services Inc. is accredited by NVLAP, Laboratory Code 200065-0.

Chambers A through H are covered under Industry Canada company address code 2324B with site numbers 2324B -1 through 2324B-8, respectively.

4. CALIBRATION AND UNCERTAINTY

4.1. MEASURING INSTRUMENT CALIBRATION

The measuring equipment utilized to perform the tests documented in this report has been calibrated in accordance with the manufacturer's recommendations, and is traceable to recognized national standards

4.2. SAMPLE CALCULATION

Where relevant, the following sample calculation is provided:

EIRP = PSA reading with EUT worst orientation (dBm) + Path loss (dB) – cable loss
(between the SG and substitution antenna) + Substitution Antenna Factor (dBi)

ERP = PSA reading with EUT worst orientation (dBm) + Path loss (dB) – cable loss
(between the SG and substitution antenna)

(Path loss = Signal generator output – PSA reading with substitution antenna)

4.3. MEASUREMENT UNCERTAINTY

Where relevant, the following measurement uncertainty levels have been estimated for tests performed on the apparatus:

PARAMETER	UNCERTAINTY
Conducted Disturbance, 0.15 to 30 MHz	3.52 dB
Radiated Disturbance, 9KHz to 30 MHz	2.14 dB
Radiated Disturbance, 30 to 1000 MHz	4.98 dB
Radiated Disturbance,1000 to 6000 MHz	3.86 dB
Radiated Disturbance,6000 to 18000 MHz	4.23 dB
Radiated Disturbance,18000 to 26000 MHz	5.30 dB
Radiated Disturbance,26000 to 40000 MHz	5.23 dB

Uncertainty figures are valid to a confidence level of 95%.

5. EQUIPMENT UNDER TEST

5.1. DESCRIPTION OF EUT

This EUT is a GSM/WCDMA/LTE Phone with BT, DTS/UNII a/b/g/n/ac & NFC

C2PC Reason: Adding LTE Band 26

5.2. MAXIMUM OUTPUT POWER (LTE)

The transmitter has a maximum peak conducted and radiated ERP/EIRP output powers as follows:

LTE Band 26 PART 90

FCC Part 90							
Band	Frequency Range(MHz)	BandWidth (MHz)	Modulation	Conducted		Radiated	
				AVG(dBm)	AVG(mW)	AVG(dBm)	AVG(mW)
LTE26	814~824	1.4MHz	QPSK	23.70	234.42	21.36	136.77
			16QAM	22.70	186.21	20.53	112.98
		3MHz	QPSK	23.70	234.42	21.55	142.89
			16QAM	22.80	190.55	20.73	118.30
		5MHz	QPSK	23.80	239.88	21.92	155.60
			16QAM	22.80	190.55	20.97	125.03
		10MHz	QPSK	23.70	234.42	21.38	137.40
			16QAM	22.80	190.55	20.48	111.69

LTE Band 26 PART 22

FCC Part 22							
Band	Frequency Range(MHz)	BandWidth (MHz)	Modulation	Conducted		Radiated	
				AVG(dBm)	AVG(mW)	AVG(dBm)	AVG(mW)
LTE26	824~849	1.4MHz	QPSK	24.00	251.19	21.56	143.22
			16QAM	23.00	199.53	20.64	115.88
		3MHz	QPSK	24.00	251.19	21.57	143.55
			16QAM	22.80	190.55	20.76	119.12
		5MHz	QPSK	24.10	257.04	21.96	157.04
			16QAM	23.20	208.93	20.99	125.60
		10MHz	QPSK	23.90	245.47	21.82	152.05
			16QAM	22.80	190.55	20.86	121.90
		15MHz	QPSK	24.00	251.19	22.17	164.82
			16QAM	23.30	204.17	21.40	138.04

5.3. DESCRIPTION OF AVAILABLE ANTENNAS

The radio utilizes a PIFA antenna for the [List the bands supported] with a maximum peak gain as follow:

Frequency (MHz)	Peak Gain (dBi)
LTE Band 26, 814~849MHz	-2.4

5.4. DESCRIPTION OF TEST SETUP

SUPPORT EQUIPMENT

Support Equipment List				
Description	Manufacturer	Model	Serial Number	FCC ID
AC Adapter	SONY	SEM0809	5815W29100038	N/A
Earphone	SONY	N/A	N/A	N/A

I/O CABLES (CONDUCTED SETUP)

I/O Cable List						
Cable No	Port	# of Identical ports	Connector Type	Serial Type	Cable Length (m)	Remarks
1	RF Out	1	Spectrum Analyzer	Shielded	None	NA
2	Antenna Port	1	EUT	Shielded	0.1m	NA
3	RF In/Out	1	Communication Test Set	Shielded	1m	NA

I/O CABLES (RADIATED SETUP)

I/O Cable List						
Cable No	Port	# of Identical ports	Connector Type	Serial Type	Cable Length (m)	Remarks
1	USB	1	AC Adapter	Un-shielded	1.2m	No
2	Jack	1	Headset	Shielded	1m	No
3	RF In/out	1	Communication Test Set	Un-shielded	2m	Yes

TEST SETUP

The EUT is continuously communicated to the call box during the tests.

SETUP DIAGRAM FOR TESTS (CONDUCTED TEST SETUP)

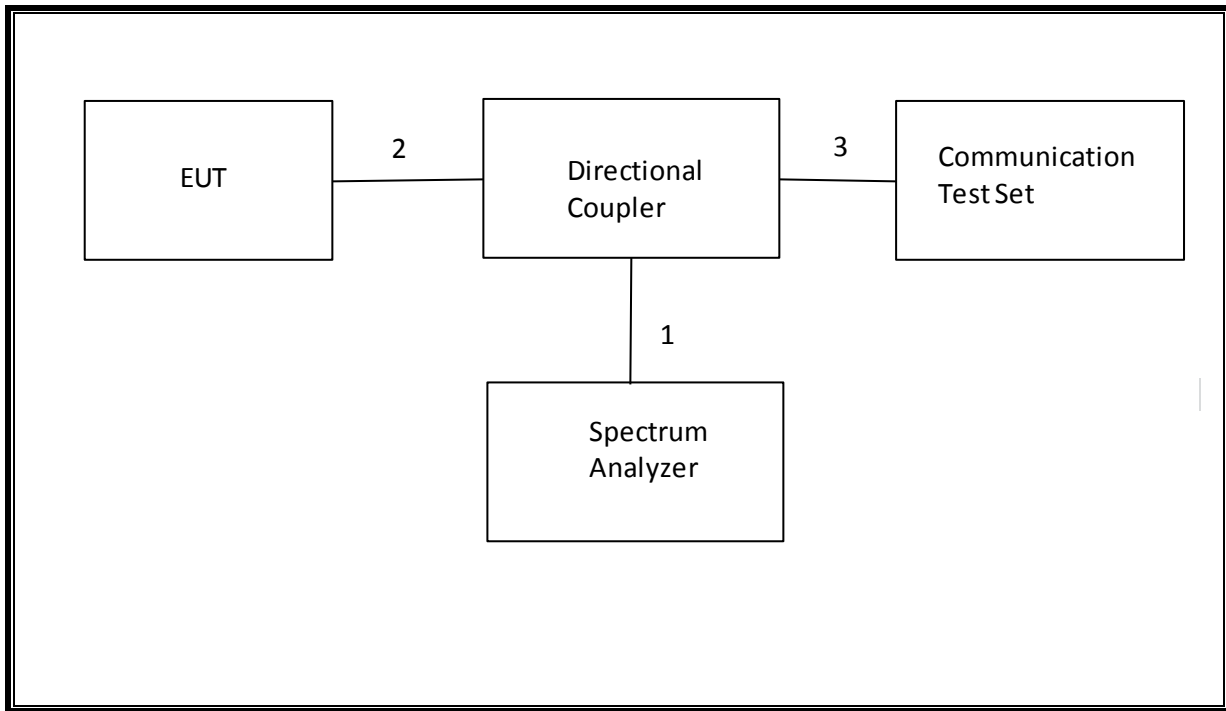

SETUP DIAGRAM FOR TESTS (RADIATED TEST SETUP)

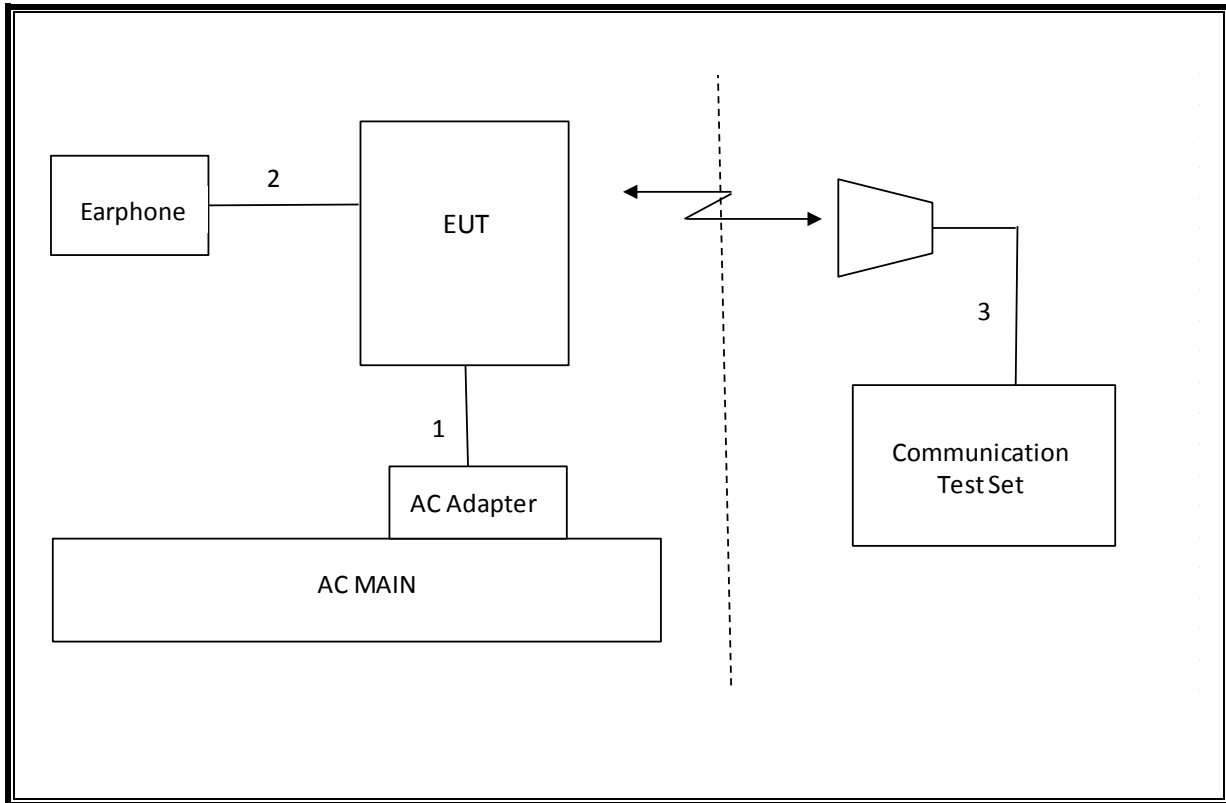

6. TEST AND MEASUREMENT EQUIPMENT

The following test and measurement equipment was utilized for the tests documented in this report:

Test Software List				
Description	Manufacturer	Model	T Number	Cal Due
Spectrum Analyzer, 44 GHz	Agilent / HP	E4446A	123	10/22/16
Antenna, Bilog, 2 GHz	Sunol Sciences	JB1	130	06/10/16
Antenna, Horn, 18 GHz	EMCO	3115	59	11/18/16
Highpass Filter, 2.7 GHz	Micro-Tronics	HPM13194	151	CNR
Highpass Filter, 1.5 GHz	Micro-Tronics	HPM13193	153	CNR
Temperature / Humidity Chamber	Thermotron	SE 600-10-10	80	11/16/16
Communications Test Set	R&S	CMW500	159	07/10/16
DC power supply, 8 V @ 3 A or 15 V @ 2 A	Agilent / HP	E3610A	None	CNR
Vector signal generator, 6 GHz	Agilent / HP	E4438C	None	06/16/16
Antenna, Tuned Dipole 400~1000 MHz	ETS	3121C DB4	273	05/16/17
Directional Coupler	RF-Lambda	RFDC5M06G15	None	CNR

Test Software List			
Description	Manufacturer	Model	Version
Radiated Software	UL	UL EMC	Ver 9.5, June 24, 2015
Conducted Software	UL	UL EMC	Ver 9.5, May 26, 2015
CLT Software	UL	UL RF	Ver 1.0, Feb 2, 2015
Antenna Port Software	UL	UL RF	Ver 3.7, Nov 12, 2015

7. SUMMARY TABLE

FCC Part Section	Test Description	Test Limit	Test Condition	Test Result
2.1049	Occupied Bandwidth (99%)	N/A	Conducted	Pass
22.917(a) 90.691	Band Edge / Conducted Spurious Emission	-13dBm		Pass
2.1046	Conducted output power	N/A		Pass
90.691	Emission Mask			Pass
22.355 90.213	Frequency Stability	2.5PPM		Pass
22.913(a)(2)	Effective Radiated Power	38dBm	Radiated	Pass
90.635		50dBm		Pass
22.917(a)		Radiated Spurious Emission		-13dBm

8. RF POWER OUTPUT VERIFICATION

8.1. LTE OUTPUT POWER RESULT

LTE Band 26

Band	BW (MHz)	Mode	RB Allocation	RB offset	MPR	Avg Pwr (dBm)		
						26697	26865	27033
						814.7 MHz	831.5 MHz	848.3 MHz
LTE Band 26	1.4	QPSK	1	0	0	23.60	23.90	23.10
			1	3	0	23.70	24.00	23.10
			1	5	0	23.60	24.00	23.10
			3	0	0	23.70	23.90	23.20
			3	1	0	23.70	23.90	23.20
			3	3	0	23.70	23.90	23.10
		16QAM	6	0	1	22.60	22.90	22.10
			1	0	1	22.70	22.90	22.50
			1	3	1	22.70	23.00	22.40
			1	5	1	22.60	22.90	22.40
			3	0	1	22.80	22.90	22.30
			3	1	1	22.80	23.00	22.40
			3	3	1	22.80	23.00	22.30
			6	0	2	21.80	22.00	21.00
Band	BW (MHz)	Mode	RB Allocation	RB offset	MPR	Avg Pwr (dBm)		
						26705	26865	27025
						815.5 MHz	831.5 MHz	847.5 MHz
LTE Band 26	3	QPSK	1	0	0	23.70	24.00	23.10
			1	8	0	23.70	24.00	23.10
			1	14	0	23.60	24.00	23.10
			8	0	1	22.70	22.80	22.10
			8	4	1	22.70	22.90	22.10
			8	7	1	22.70	22.90	22.10
			15	0	1	22.70	23.00	22.20
		16QAM	1	0	1	22.80	22.70	22.50
			1	8	1	22.80	22.80	22.40
			1	14	1	22.80	22.80	22.50
			8	0	2	21.80	22.00	21.20
			8	4	2	21.80	22.00	21.20
			8	7	2	21.80	22.00	21.20
			15	0	2	21.70	22.00	21.20

Band	BW (MHz)	Mode	RB Allocation	RB offset	MPR	Avg Pwr (dBm)		
						26715	26865	27015
						816.5 MHz	831.5 MHz	846.5 MHz
LTE Band 26	5	QPSK	1	0	0	23.80	24.10	23.30
			1	12	0	23.70	24.00	23.20
			1	24	0	23.70	24.00	23.20
			12	0	1	22.80	22.90	22.30
			12	7	1	22.70	22.90	22.30
			12	13	1	22.70	23.00	22.20
		16QAM	25	0	1	22.70	23.00	22.30
			1	0	1	22.80	23.20	22.80
			1	12	1	22.70	23.10	22.80
			1	24	1	22.80	23.10	22.80
			12	0	2	21.80	21.90	21.40
			12	7	2	21.80	22.00	21.50
			12	13	2	21.80	22.00	21.40
			25	0	2	21.70	22.00	21.40
Band	BW (MHz)	Mode	RB Allocation	RB offset	MPR	Avg Pwr (dBm)		
						26740	26865	26990
						819 MHz	831.5 MHz	844 MHz
LTE Band 26	10	QPSK	1	0	0	23.70	23.90	23.50
			1	25	0	23.60	23.90	23.40
			1	49	0	23.60	23.90	23.40
			25	0	1	22.60	23.00	22.50
			25	12	1	22.70	23.00	22.40
			25	25	1	22.60	23.00	22.40
		16QAM	50	0	1	22.60	23.00	22.50
			1	0	1	22.80	22.80	22.80
			1	25	1	22.70	22.80	22.70
			1	49	1	22.50	22.80	22.60
			25	0	2	21.80	22.00	21.60
			25	12	2	21.90	22.00	21.50
			25	25	2	21.80	22.00	21.50
			50	0	2	21.70	22.00	21.50

BW (MHz)	Mode	RB Allocation	RB offset	MPR	Avg Pwr (dBm)		
					26765	26865	26965
					821.5 MHz	831.5 MHz	841.5 MHz
15	QPSK	1	0	0	24.00	24.00	23.90
		1	37	0	23.80	23.80	23.80
		1	74	0	24.00	24.00	23.80
		36	0	1	22.80	22.90	22.80
		36	20	1	22.80	22.80	22.90
		36	39	1	22.80	22.90	22.90
		75	0	1	22.80	22.90	22.90
	16QAM	1	0	1	23.20	23.10	23.30
		1	37	1	23.00	22.70	23.00
		1	74	1	23.10	23.10	23.20
		36	0	2	21.90	22.10	22.00
		36	20	2	21.80	21.90	21.90
		36	39	2	21.90	22.00	22.00
		75	0	2	21.90	22.00	21.90

9. PEAK TO AVERAGE RATIO

TEST PROCEDURE

Per KDB 971168 D01 Power Meas License Digital Systems v02r02

TEST SPEC

In addition, when the transmitter power is measured in terms of average value, the peak-to-average ratio of the power shall not exceed 13 dB.

9.1. CONDUCTED PEAK TO AVERAGE RESULT

LTE Band 26



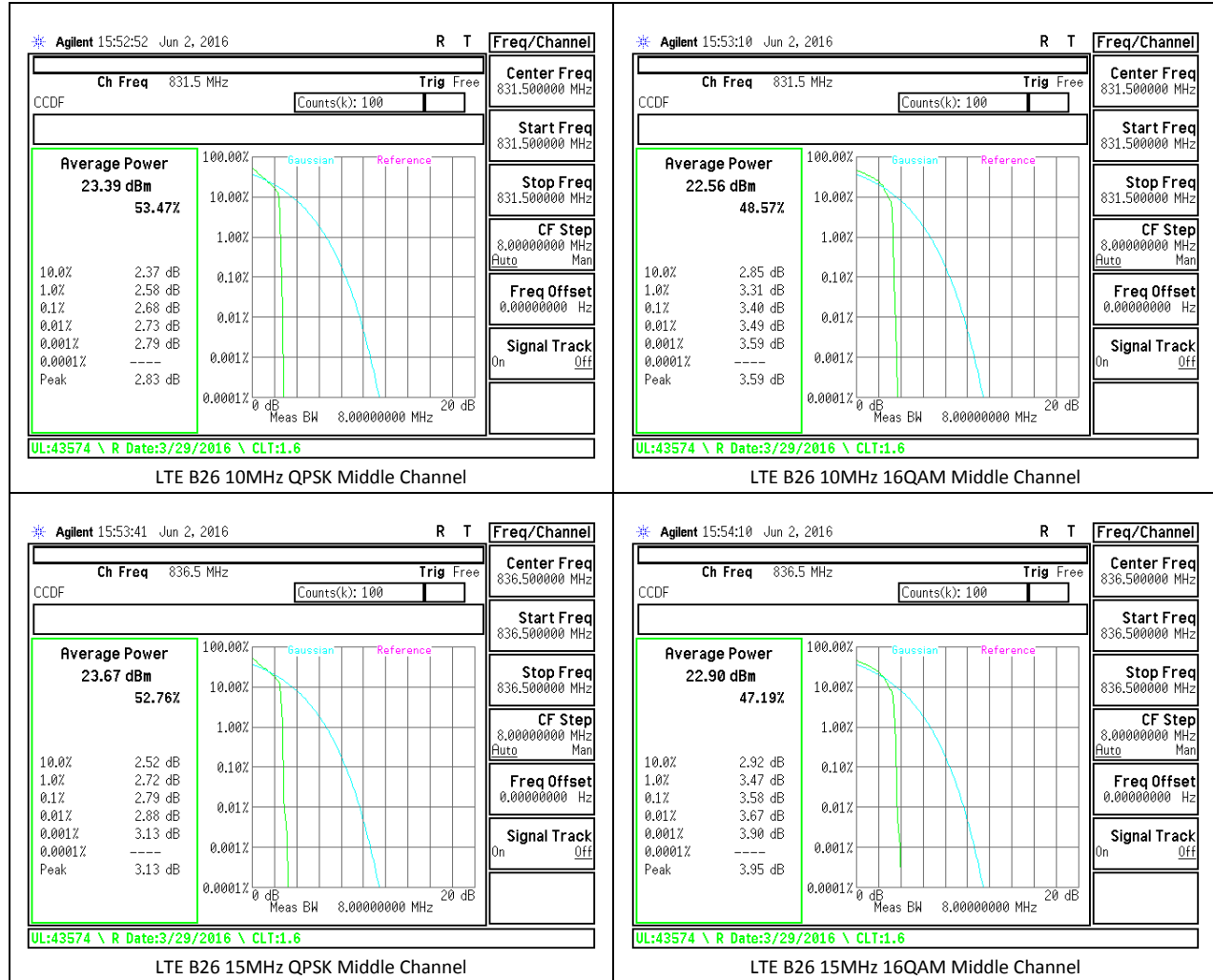

10. OCCUPIED BANDWIDTH

RULE PART(S)

FCC: §2.1049

LIMITS

For reporting purposes only

TEST PROCEDURE

The transmitter output was connected to a calibrated coaxial cable and coupler, the other end of which was connected to a spectrum analyzer. The occupied bandwidth was measured with the spectrum analyzer at the low, middle and high channel in each band. The -26dB bandwidth was also measured and recorded.

(KDB 971168 D01 Power Meas License Digital Systems v02r02)

10.1. OCCUPIED BANDWIDTH RESULTS AND PLOTS

LTE Band 26

BW(MHz)	Mode	RB/RB Size	f (MHz)	99% BW (MHz)	-26dB BW (MHz)
1.4	QPSK	6/0	814.7	1.0825	1.238
1.4	QPSK	6/0	831.5	1.0789	1.243
1.4	QPSK	6/0	848.3	1.0785	1.240
1.4	16QAM	6/0	814.7	1.0806	1.235
1.4	16QAM	6/0	831.5	1.0809	1.224
1.4	16QAM	6/0	848.3	1.0859	1.240
3	QPSK	15/0	815.5	2.6896	2.980
3	QPSK	15/0	831.5	2.6857	2.985
3	QPSK	15/0	847.5	2.6850	3.052
3	16QAM	15/0	815.5	2.6885	2.956
3	16QAM	15/0	831.5	2.6826	2.998
3	16QAM	15/0	847.5	2.6854	2.986
5	QPSK	25/0	816.5	4.4873	4.944
5	QPSK	25/0	831.5	4.4920	4.945
5	QPSK	25/0	846.5	4.4973	4.921
5	16QAM	25/0	816.5	4.4913	4.964
5	16QAM	25/0	831.5	4.4860	4.937
5	16QAM	25/0	846.5	4.5000	4.858
10	QPSK	50/0	819	8.9730	9.727
10	QPSK	50/0	831.5	8.9628	9.711
10	QPSK	50/0	844	8.9518	9.658
10	16QAM	50/0	819	8.9447	9.717
10	16QAM	50/0	831.5	8.9524	9.631
10	16QAM	50/0	844	8.9435	9.741
15	QPSK	75/0	831.5	13.4445	14.582
15	QPSK	75/0	836.5	13.3923	14.394
15	QPSK	75/0	841.5	13.4491	14.605
15	16QAM	75/0	831.5	13.4204	14.551
15	16QAM	75/0	836.5	13.4414	14.460
15	16QAM	75/0	841.5	13.3974	14.571

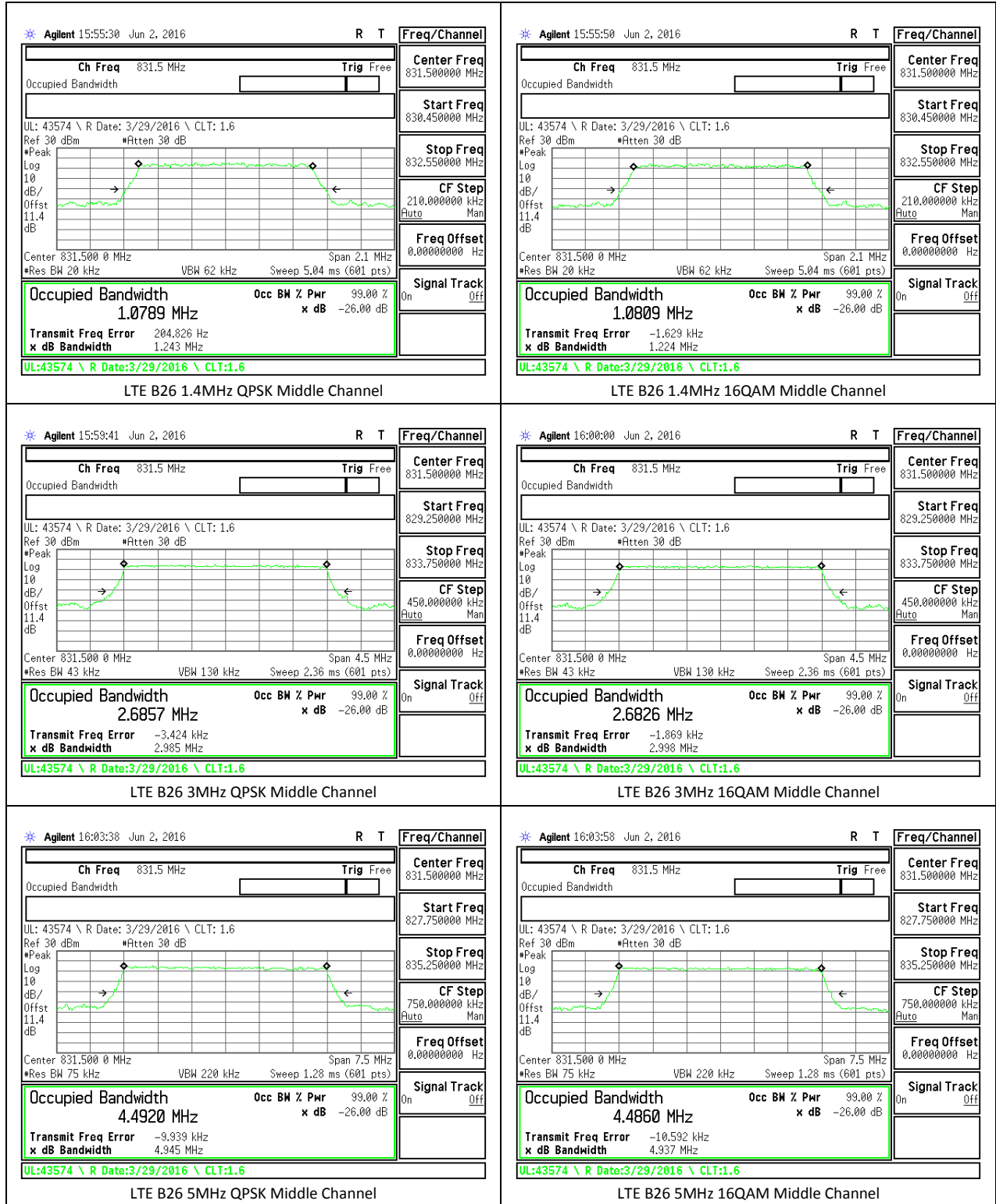



11. BAND EDGE EMISSIONS

RULE PART(S)

FCC: §22.359 and § 90.691

LIMITS

The power of any emission outside of the authorized operating frequency ranges must be attenuated below the transmitting power (P) by a factor of at least $43 + 10 \log (P)$ dB.

Part 90:

(a)(1) For any frequency removed from the EA licensee's frequency block by up to and including 37.5 kHz, the power of any emission shall be attenuated below the transmitter power (P) in watts by at least $116 \log_{10}(f/6.1)$ decibels or $50 + 10 \log_{10}(P)$ decibels or 80 decibels, whichever is the lesser attenuation, where f is the frequency removed from the center of the outer channel in the block in kilohertz and where f is greater than 12.5 kHz.

(a)(2) For any frequency removed from the EA licensee's frequency block greater than 37.5 kHz, the power of any emission shall be attenuated below the transmitter power (P) in watts by at least $43 + 10 \log_{10}(P)$ decibels or 80 decibels, whichever is the lesser attenuation, where f is the frequency removed from the center of the outer channel in the block in kilohertz and where f is greater than 37.5 kHz. {NOTE: Use 100 kHz reference bandwidth.}

TEST PROCEDURE

Per KDB 971168 D01 Power Meas License Digital Systems v02r02

The transmitter output was connected to an Agilent 8960 or a CMW500 Test Set and configured to operate at maximum power. The band edge emissions were measured at the required operating frequencies in each band on the Spectrum Analyzer.

11.1. BAND EDGE PLOTS

LTE Band 26

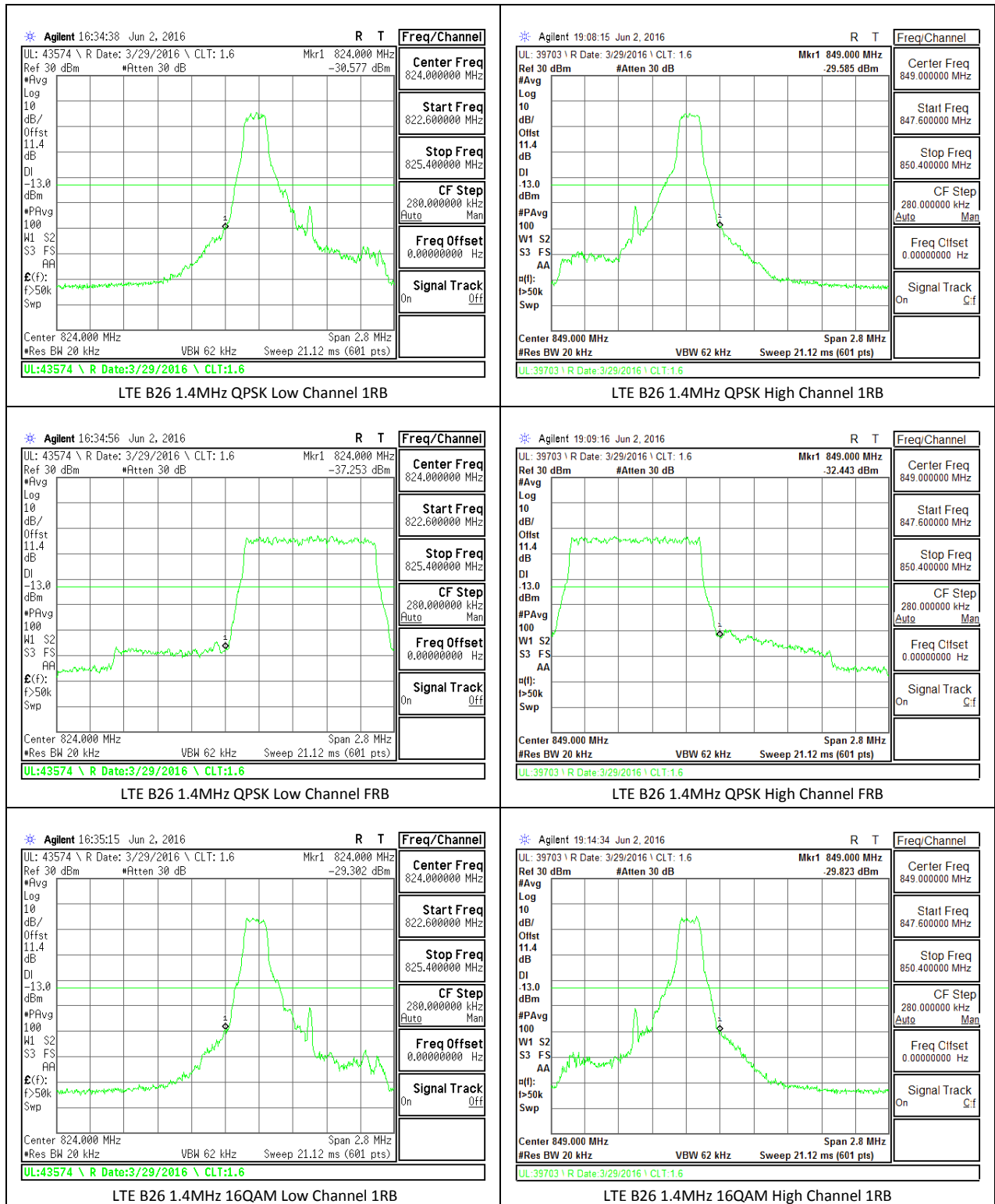

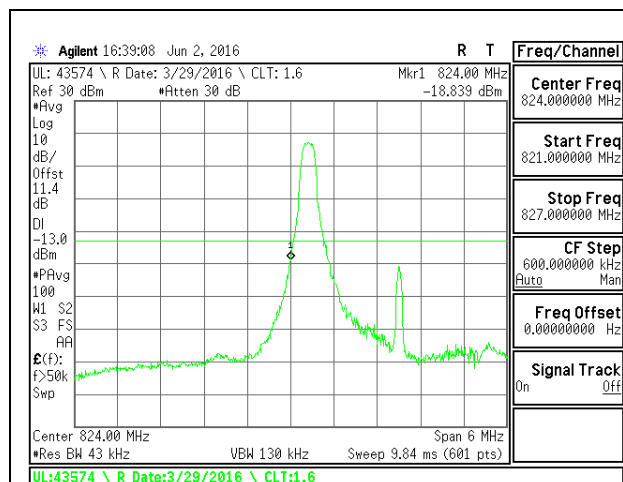

LTE B26 3MHz 16QAM Low Channel 1RB

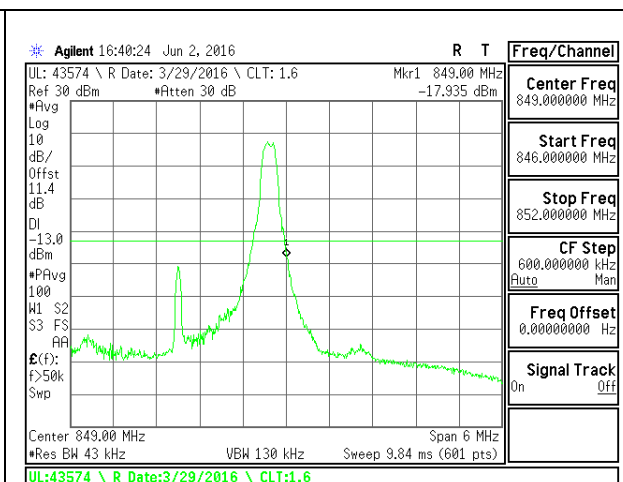

LTE B26 3MHz 16QAM High Channel 1RB

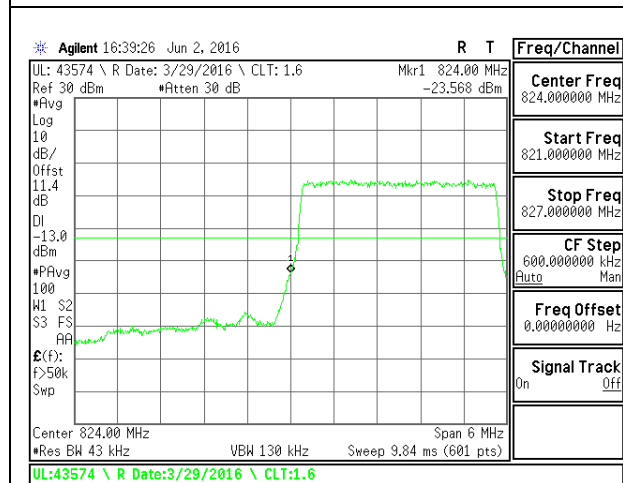

LTE B26 3MHz 16QAM Low Channel FRB

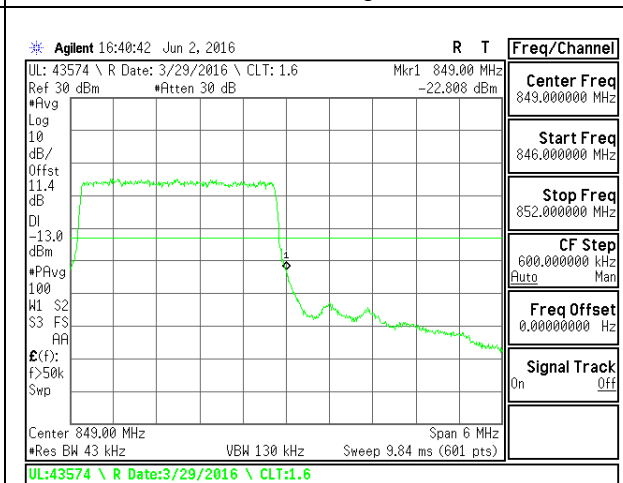

LTE B26 3MHz 16QAM High Channel FRB

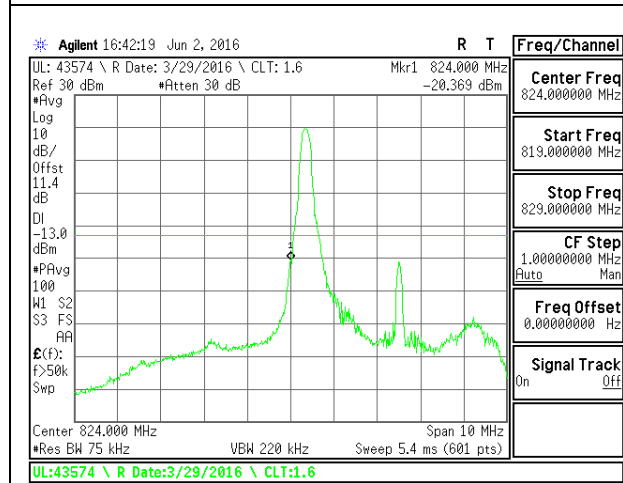

LTE B26 5MHz QPSK Low Channel 1RB

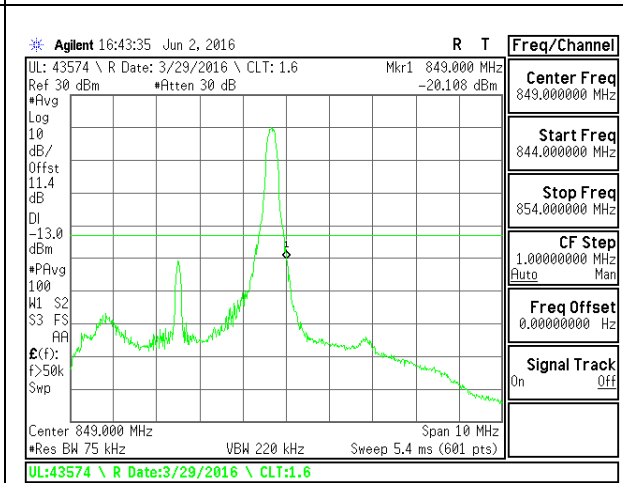

LTE B26 5MHz QPSK High Channel 1RB

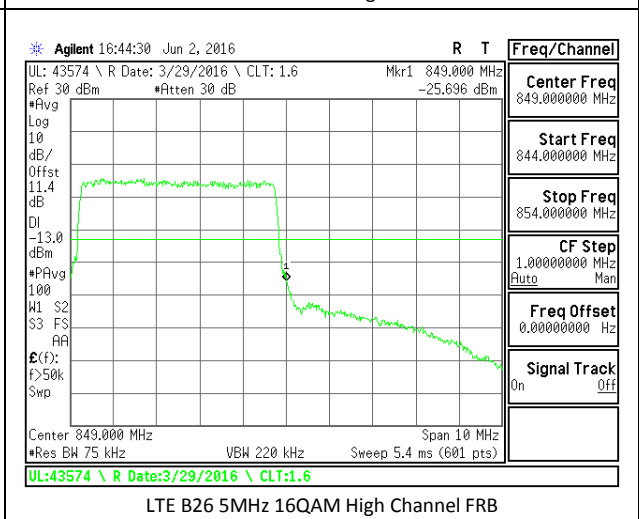
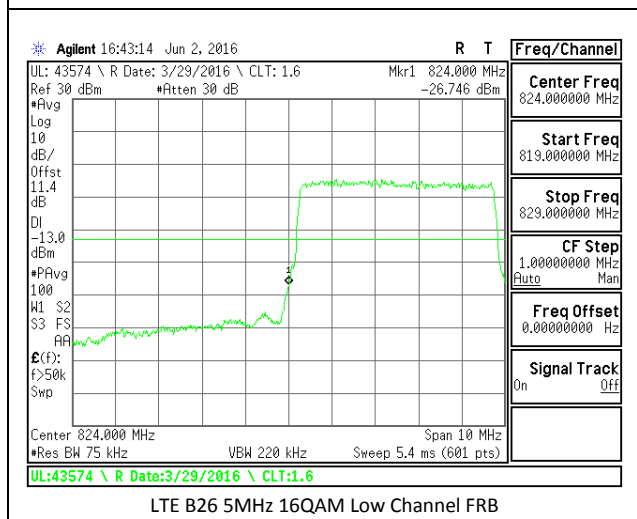
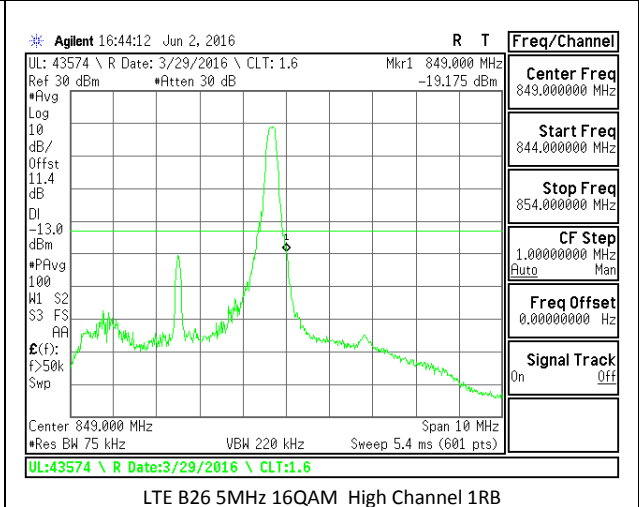
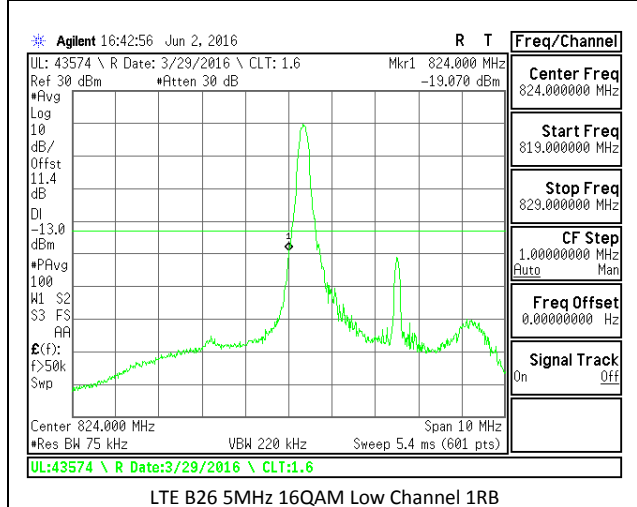
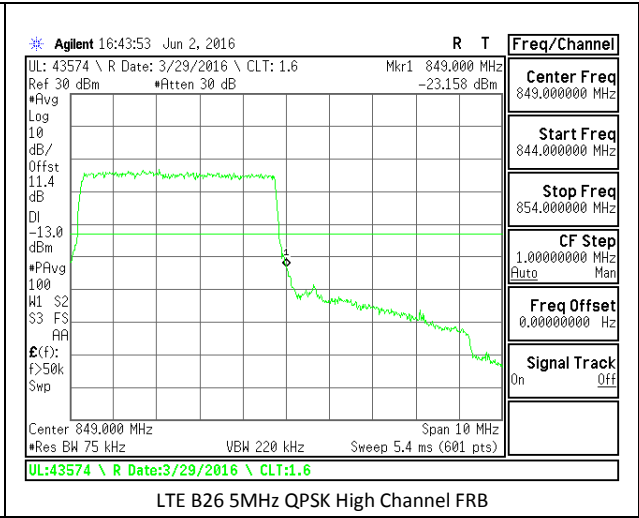
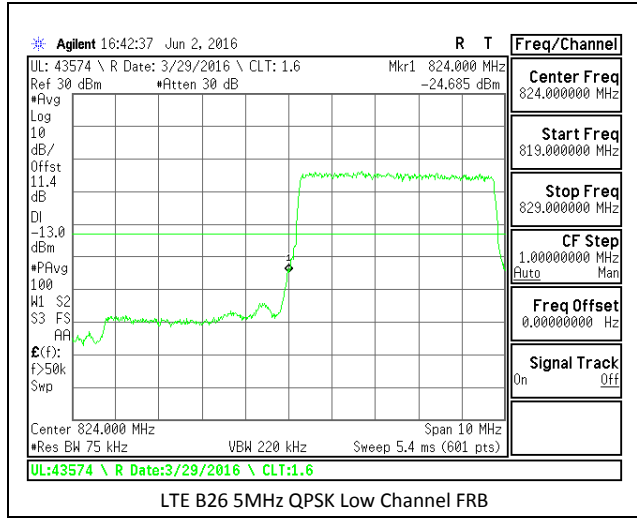

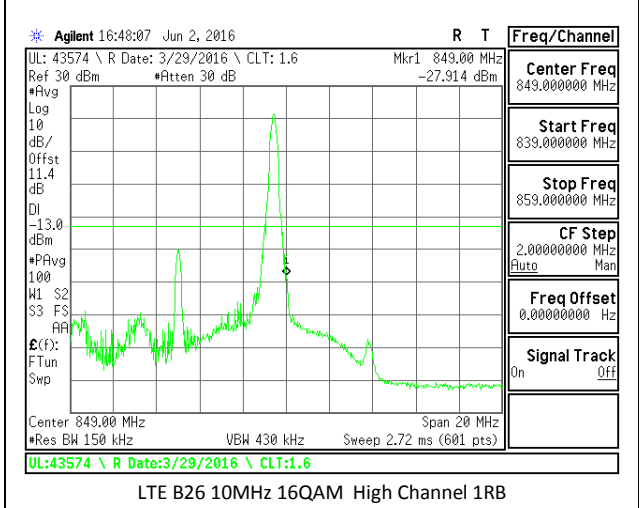
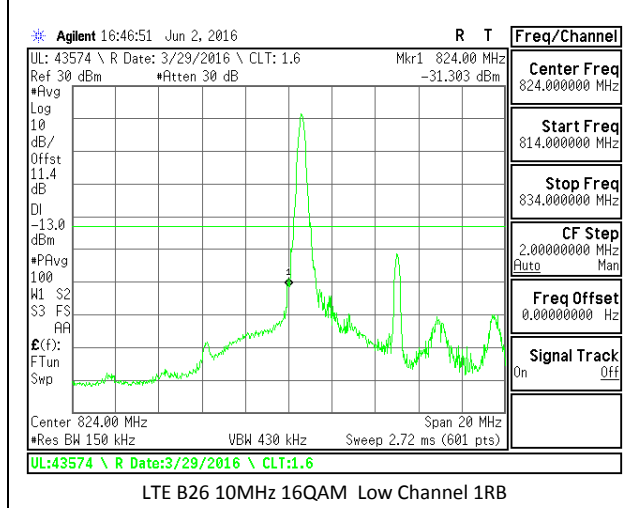
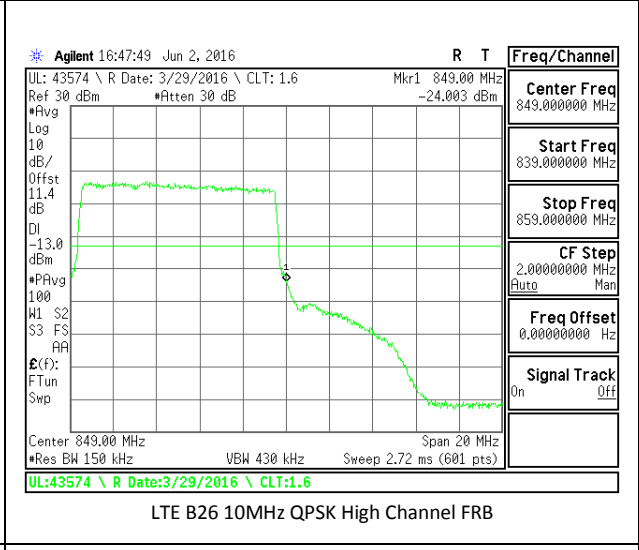
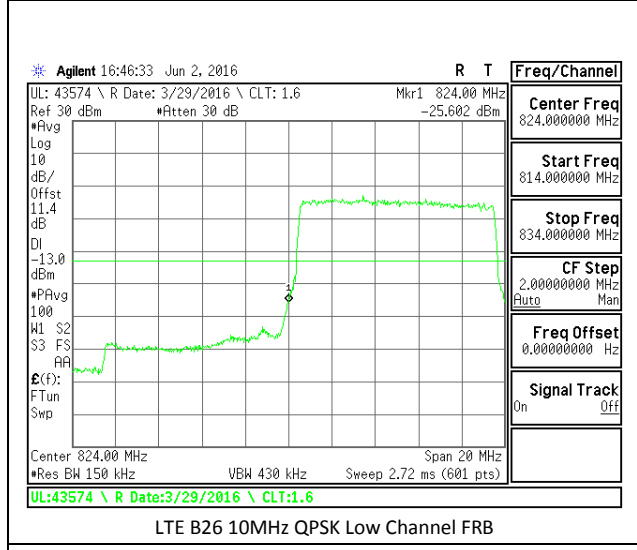
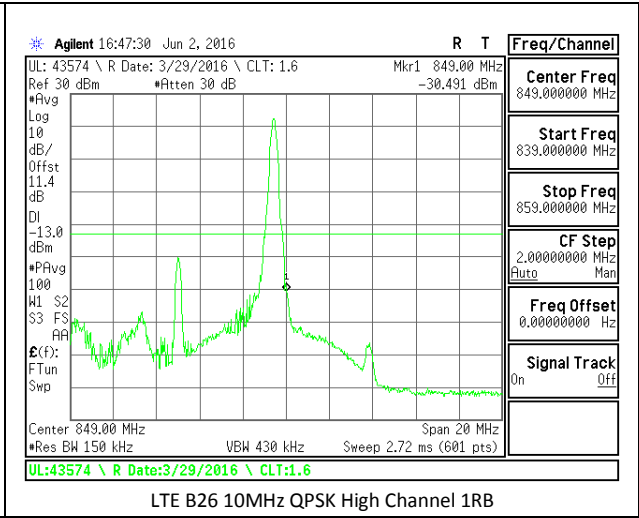
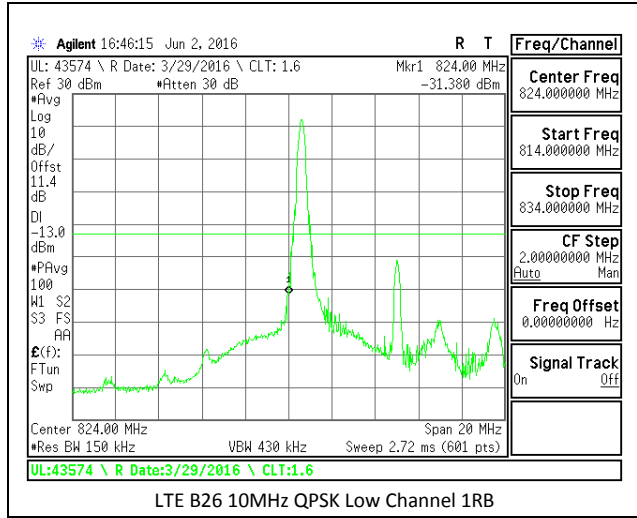

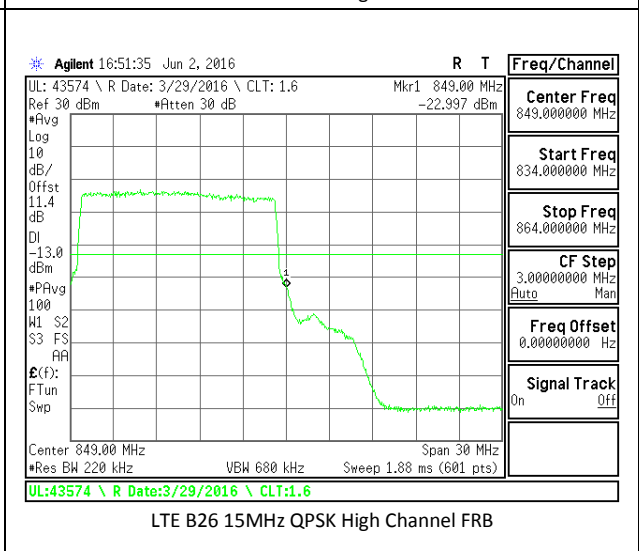
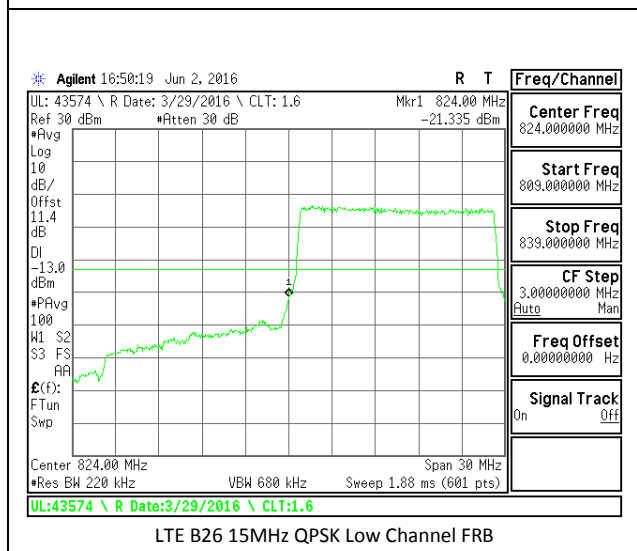
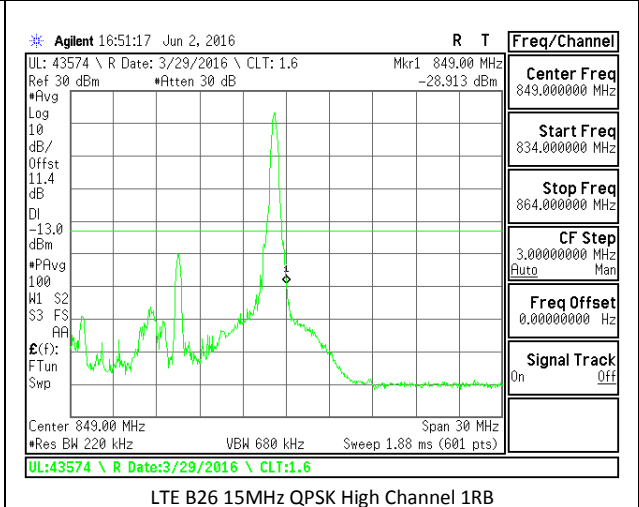
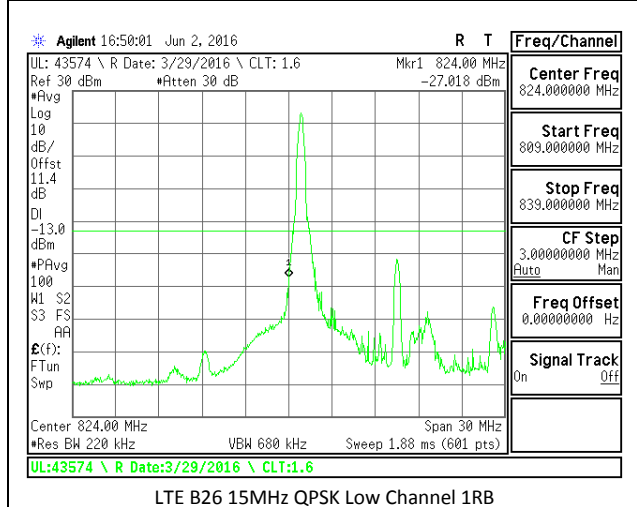
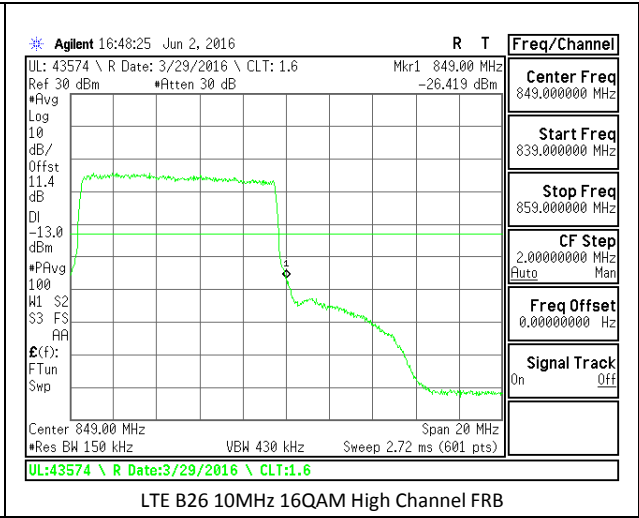
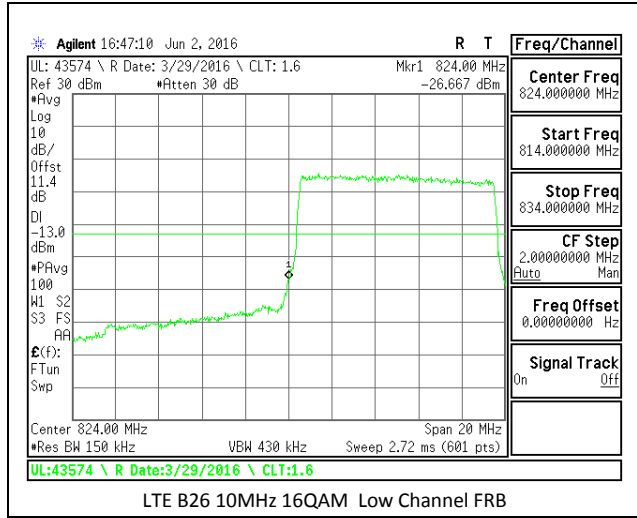

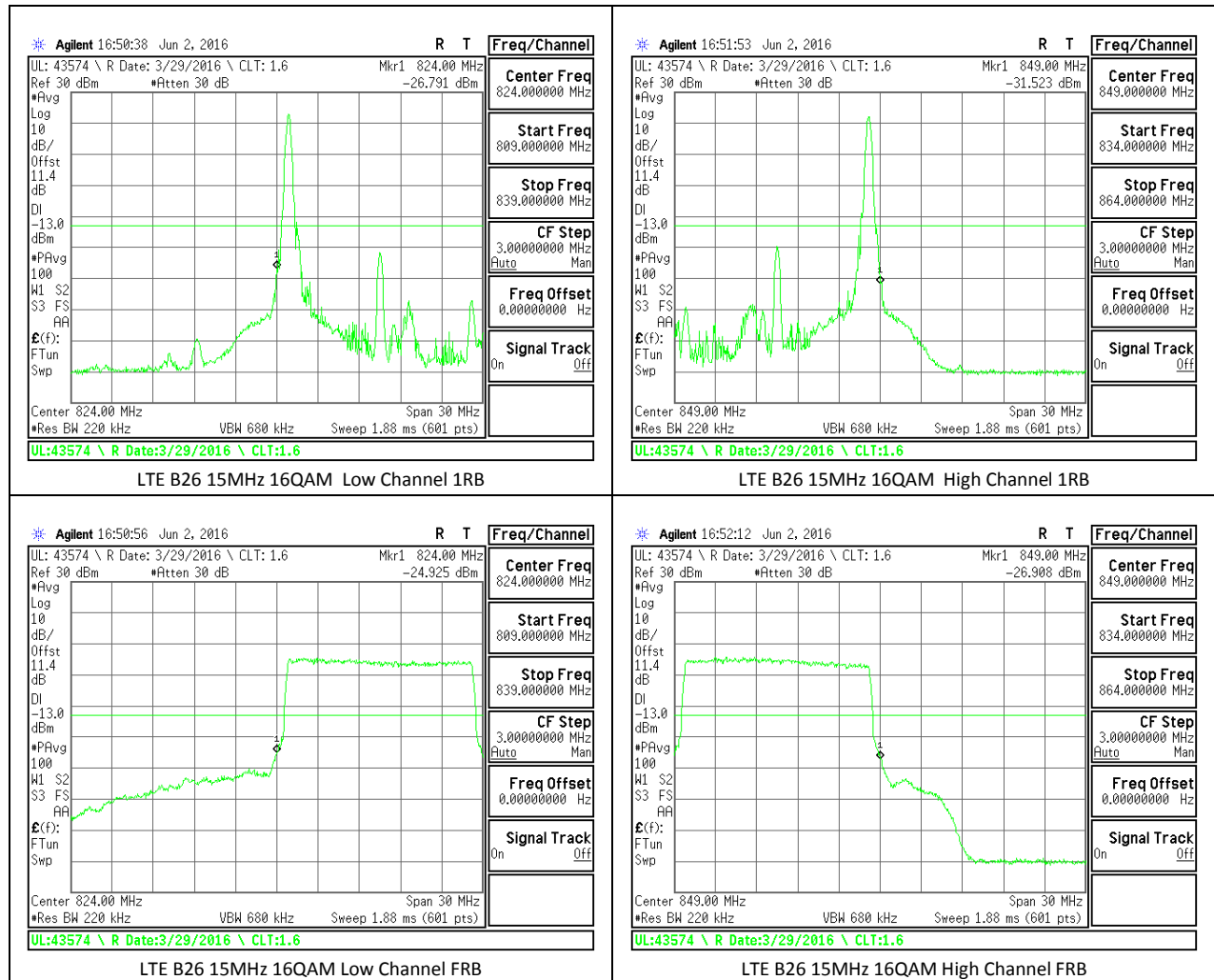

11.2. EMISSION MASK PLOTS

LTE Band 26

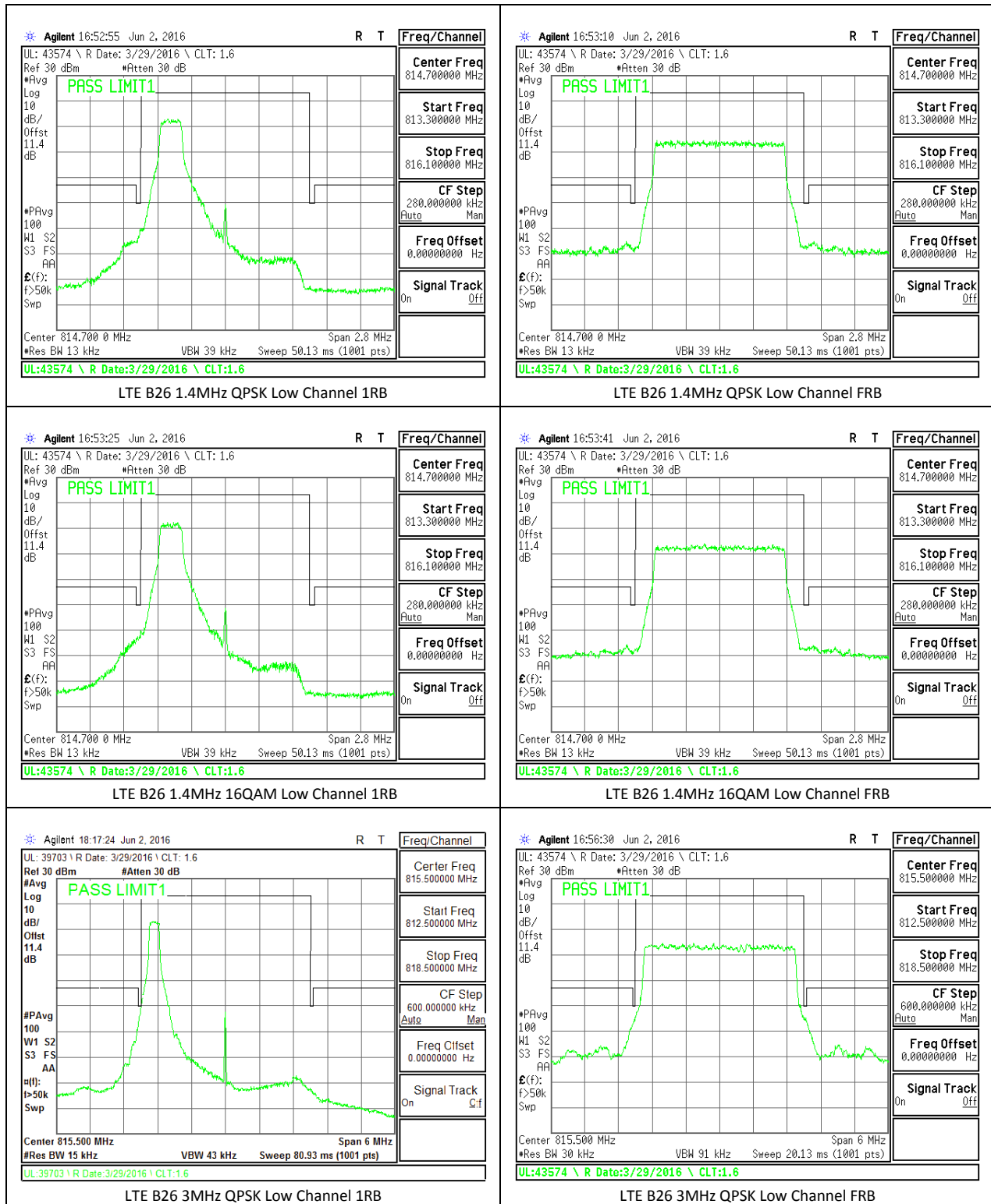

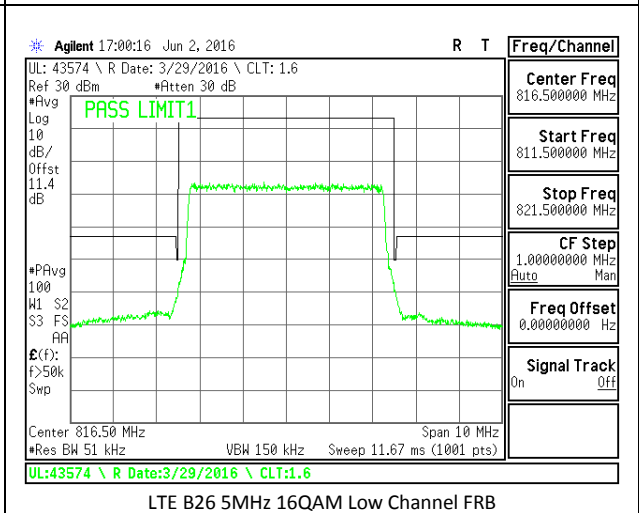
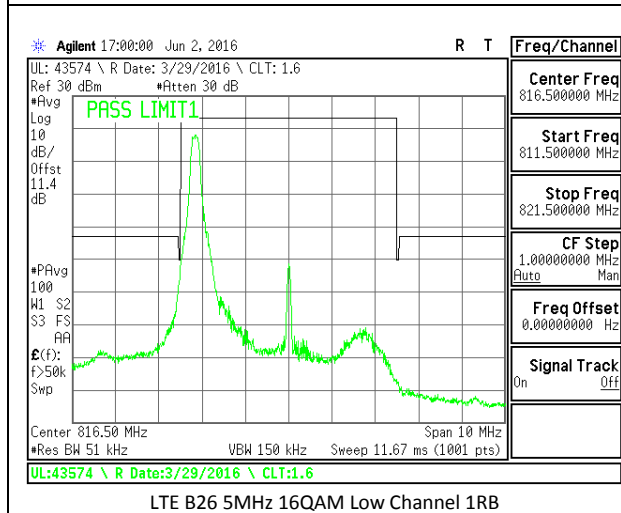
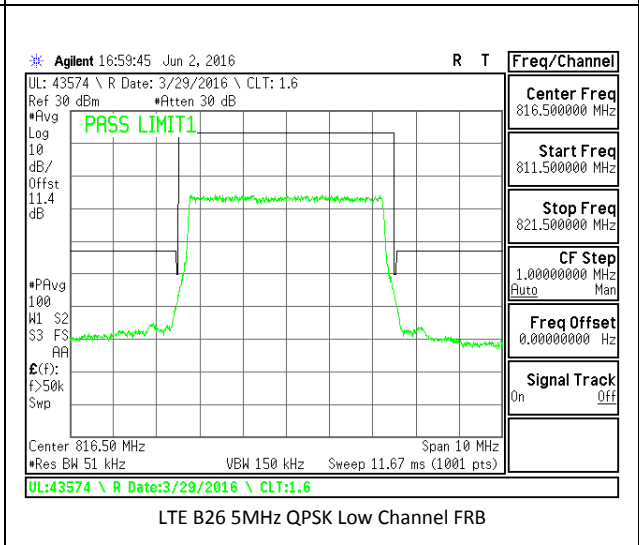
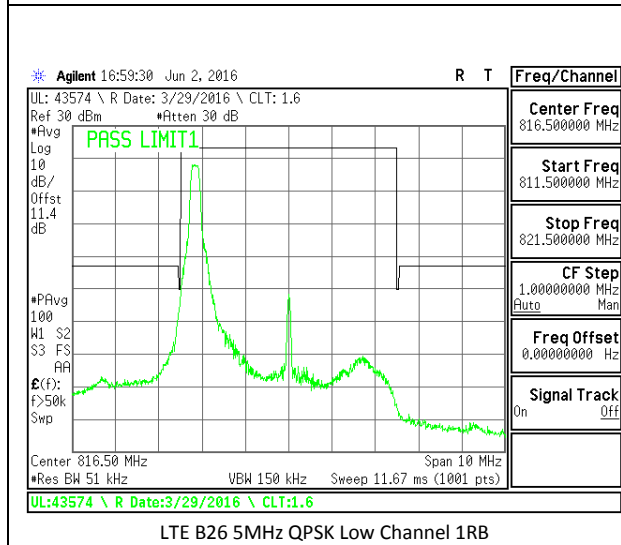
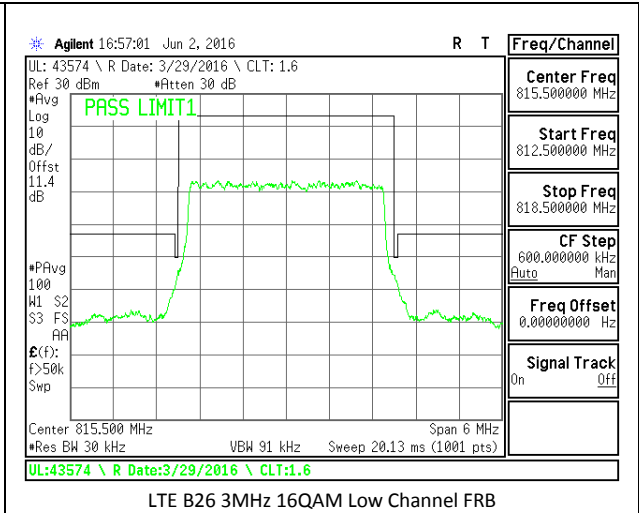
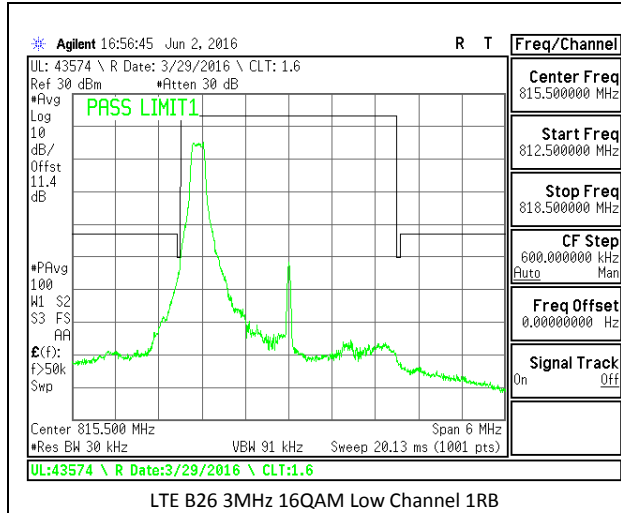

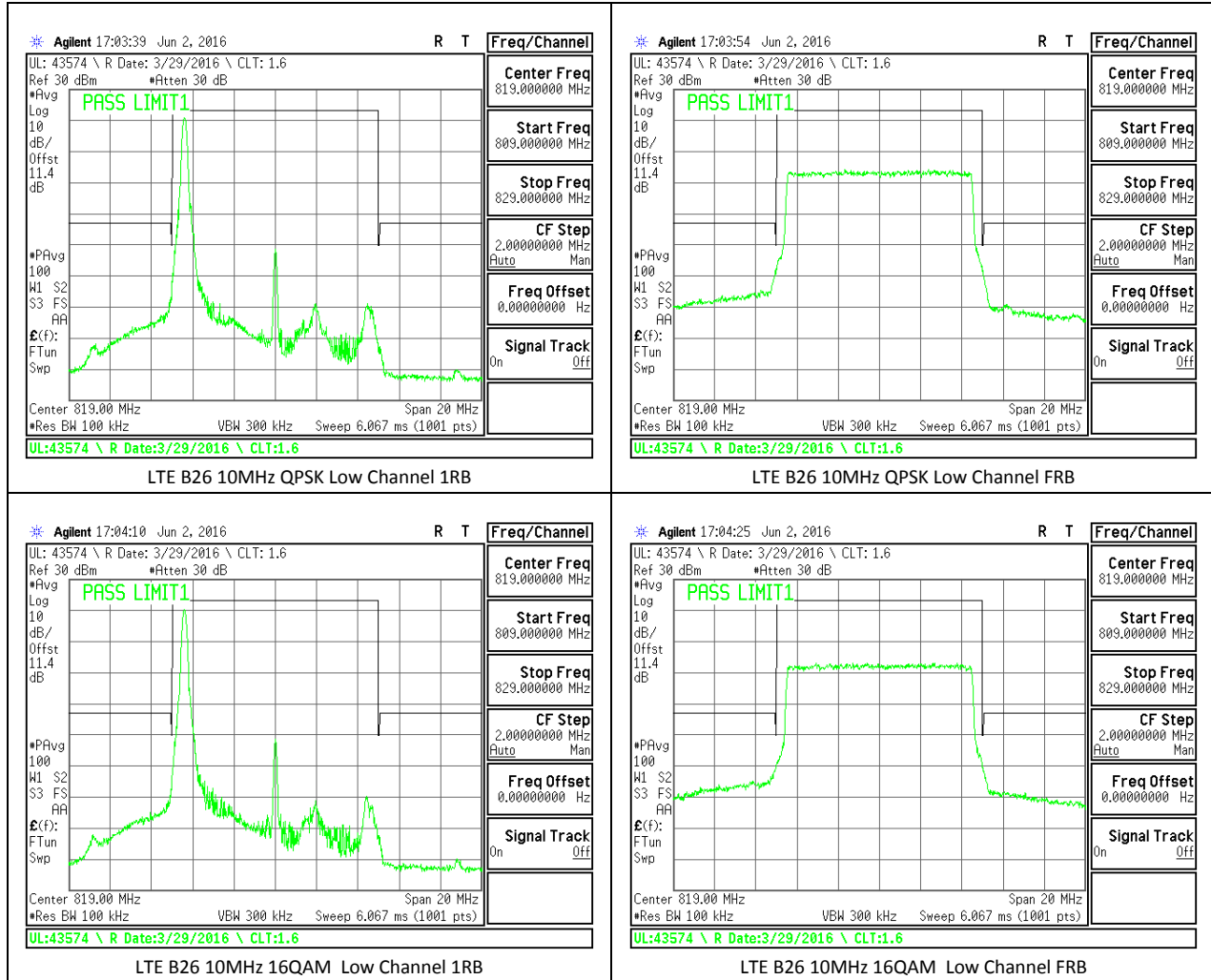

12. OUT OF BAND EMISSIONS

RULE PART(S)

FCC: §2.1051, §22.901, §22.917 and §90.691

LIMITS

The power of any emission outside of the authorized operating frequency ranges must be attenuated below the transmitting power (P) by a factor of at least $43 + 10 \log (P)$ dB.

TEST PROCEDURE

Per KDB 971168 D01 Power Meas License Digital Systems v02r02

The RF output of the transmitter was connected to a spectrum analyzer through a calibrated coaxial cable. Sufficient scans were taken to show the out-of-band Emissions, if any, up to 10th harmonic. Multiple sweeps were recorded in a maximum hold mode using a peak detector to ensure that the worst-case emissions were caught.

12.1. OUT OF BAND EMISSIONS RESULT AND PLOTS

LTE Band 26

BW(MHz)	Mode	f (MHz)	Spur (dBm)	Spec (dBm)	Delta (dB)
1.4	QPSK	814.7	-33.89	-13	-20.89
1.4	QPSK	831.5	-33.99	-13	-20.99
1.4	QPSK	848.3	-32.76	-13	-19.76
1.4	16QAM	814.7	-33.75	-13	-20.75
1.4	16QAM	831.5	-34.50	-13	-21.5
1.4	16QAM	848.3	-33.83	-13	-20.83
3	QPSK	815.5	-34.78	-13	-21.78
3	QPSK	831.5	-33.67	-13	-20.67
3	QPSK	847.5	-33.80	-13	-20.8
3	16QAM	815.5	-34.27	-13	-21.27
3	16QAM	831.5	-33.48	-13	-20.48
3	16QAM	847.5	-34.72	-13	-21.72
5	QPSK	816.5	-34.11	-13	-21.11
5	QPSK	831.5	-34.26	-13	-21.26
5	QPSK	846.5	-34.11	-13	-21.11
5	16QAM	816.5	-34.08	-13	-21.08
5	16QAM	831.5	-34.03	-13	-21.03
5	16QAM	846.5	-33.23	-13	-20.23
10	QPSK	819	-33.90	-13	-20.9
10	QPSK	831.5	-34.60	-13	-21.6
10	QPSK	844	-34.16	-13	-21.16
10	16QAM	819	-33.22	-13	-20.22
10	16QAM	831.5	-33.48	-13	-20.48
10	16QAM	844	-34.19	-13	-21.19
15	QPSK	831.5	-33.69	-13	-20.69
15	QPSK	836.5	-33.76	-13	-20.76
15	QPSK	841.5	-33.86	-13	-20.86
15	16QAM	831.5	-34.32	-13	-21.32
15	16QAM	836.5	-33.46	-13	-20.46
15	16QAM	841.5	-34.10	-13	-21.1

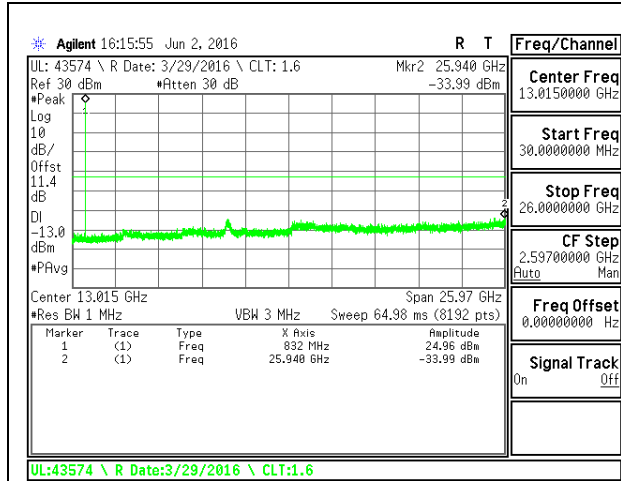

LTE B26 1.4MHz QPSK Middle Channel

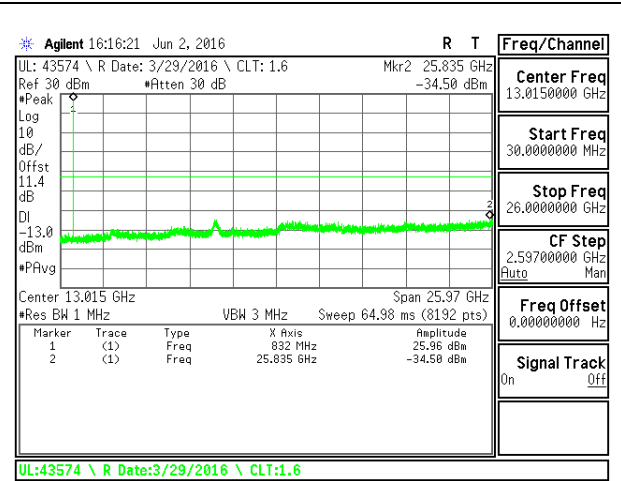

LTE B26 1.4MHz 16QAM Middle Channel

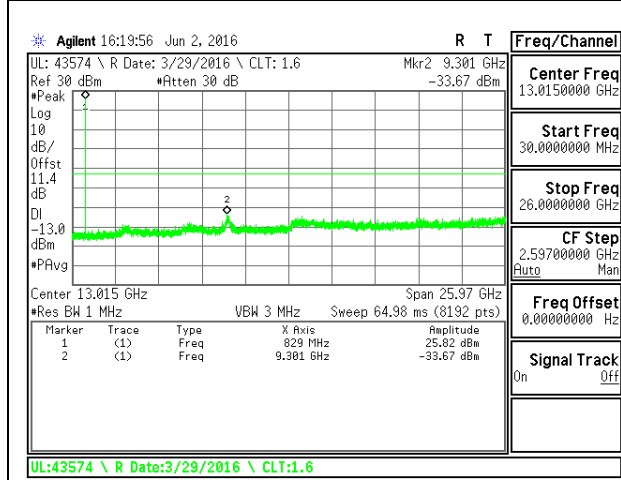

LTE B26 3MHz QPSK Middle Channel

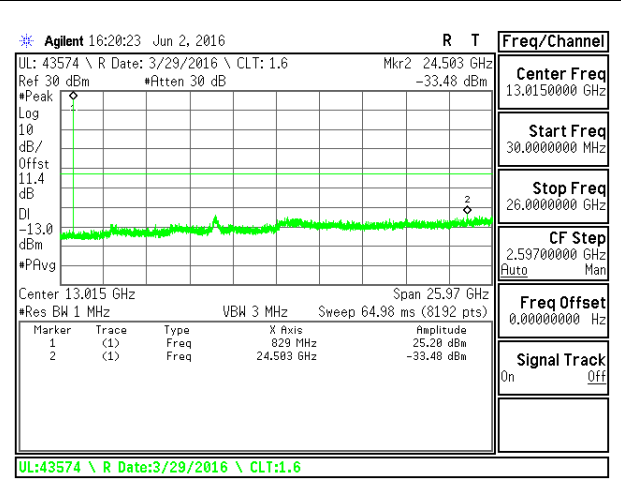

LTE B26 3MHz 16QAM Middle Channel

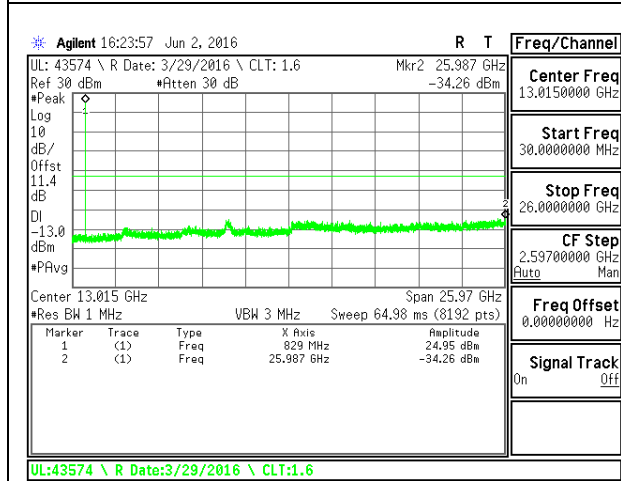

LTE B26 5MHz QPSK Middle Channel

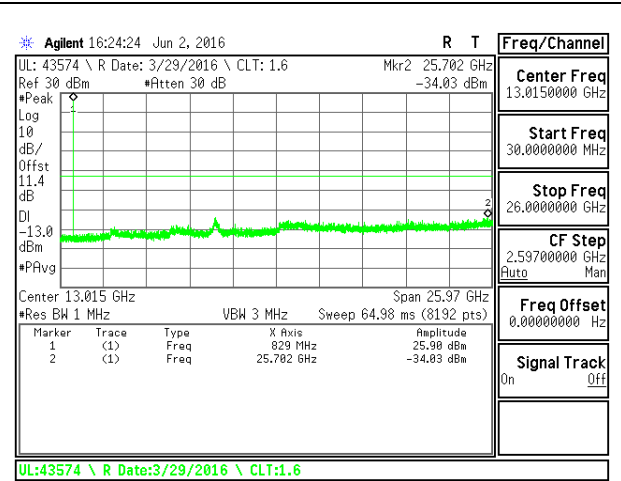

LTE B26 5MHz 16QAM Middle Channel

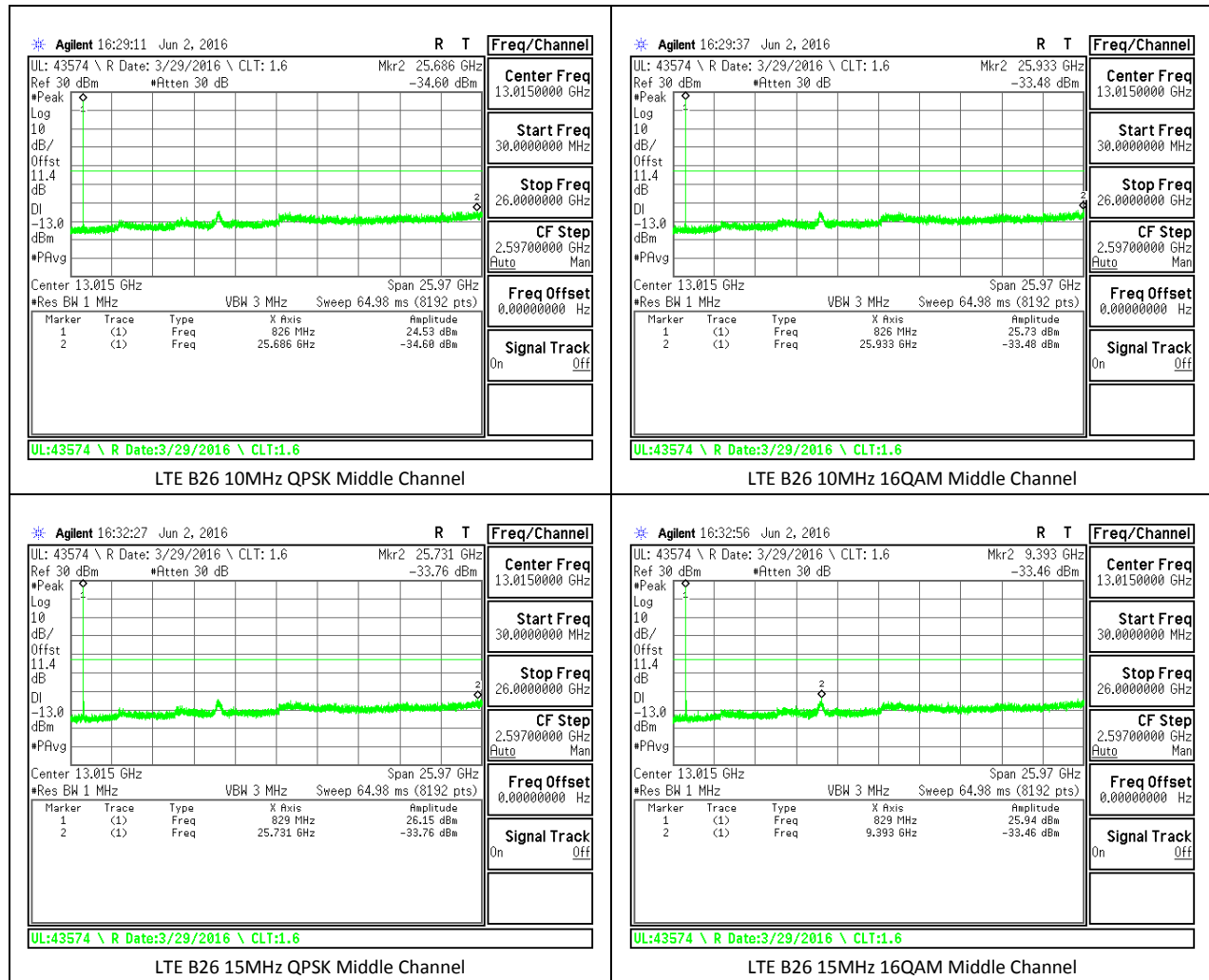

13. FREQUENCY STABILITY

RULE PART(S)

FCC: §2.1055, §22.355 and §90.213

LIMITS

§22.355 - The carrier frequency shall not depart from the reference frequency in excess of ± 2.5 ppm for mobile stations.

§90.213 - The carrier frequency shall not depart from the reference frequency in excess of ± 2.5 ppm for mobile stations.

TEST PROCEDURE

Per KDB 971168 D01 Power Meas License Digital Systems v02r02

13.1. FREQUENCY STABILITY RESULTS

LTE Band 26

Reference Frequency: PCS Mid Channel		831.5	MHz @ 20°C	
Limit: to stay +/- 2.5 ppm =		2078.750	Hz	
Power Supply (Vdc)	Environment Temperature (°C)	Frequency Deviation Measured with Time Elapse		
		(MHz)	Delta (ppm)	Limit (ppm)
3.80	50	831.499981	0.028	2.5
3.80	40	831.499995	0.012	2.5
3.80	30	831.500017	-0.015	2.5
3.80	20	831.500004	0	2.5
3.80	10	831.500009	-0.006	2.5
3.80	0	831.500005	0.000	2.5
3.80	-10	831.500005	0.000	2.5
3.80	-20	831.500004	0.000	2.5
3.80	-30	831.499995	0.011	2.5

Reference Frequency: PCS Mid Channel		831.5	MHz @ 20°C	
Limit: to stay +/- 2.5 ppm =		2078.750	Hz	
Power Supply (Vdc)	Environment Temperature (°C)	Frequency Deviation Measured with Time Elapse		
		(MHz)	Delta (ppm)	Limit (ppm)
3.80	20	831.500004	0	2.5
4.37	20	831.500044	0.000	2.5
3.23(End of volt)	20	831.4999953	0.011	2.5

14. RADIATED TEST RESULTS

14.1. RADIATED POWER (ERP & EIRP)

RULE PART(S)

FCC: §2. 1046, §22. 913 and § 90.635.

LIMITS

22.913 (a) - The ERP of mobile transmitters and auxiliary test transmitters must not exceed 7 Watts.

90.635 (b) - The maximum output power of the transmitter for mobile stations is 100 watts (20 dBw). (LTE B26)

In addition, when the transmitter power is measured in terms of average value, the peak-to-average ratio of the power shall not exceed 13dB.

TEST PROCEDURE

ANSI / TIA / EIA 603D Clause 2.2.17; PSA setting reference to 971168 D01 v02r02

For peak power measurement with a PSA:

a) Set the RBW \geq OBW; b) Set VBW $\geq 3 \times$ RBW; c) Set span $\geq 2 \times$ RBW; d) Sweep time = auto couple; e) Detector = peak; f) Ensure that the number of measurement points \geq span/RBW; g) Trace mode = max hold;

For average power measurement with a PSA:

a) Set span to at least 1.5 times the OBW; b) Set RBW = 1-5% of the OBW, not to exceed 1 MHz; c) Set VBW $\geq 3 \times$ RBW; d) Set number of points in sweep $\geq 2 \times$ span / RBW; e) Sweep time = auto-couple; f) Detector = RMS (power averaging); g) Use free run trigger If burst duty cycle ≥ 98 ; h) Use trigger to capture bursts If burst duty cycle < 98 ; i) Trace average at least 100 traces in power averaging (*i.e.*, RMS) mode. j) Compute the power by integrating the spectrum across the OBW of the signal using the instrument's band power measurement function.

14.1.1. ERP/EIRP RESULTS AND TABLE

LTE Band 26

BW (MHz)	Mode	RB/RB Size	f(MHz)	ERP	
				dBm	mW
1.4	QPSK	1/0	814.7	21.36	136.77
1.4	QPSK	1/0	831.5	21.56	143.22
1.4	QPSK	1/0	848.3	21.03	126.77
1.4	16QAM	1/0	814.7	20.53	112.98
1.4	16QAM	1/0	831.5	20.64	115.88
1.4	16QAM	1/0	848.3	20.23	105.44
3	QPSK	1/0	815.5	21.55	142.89
3	QPSK	1/0	831.5	21.57	143.55
3	QPSK	1/0	847.5	21.31	135.21
3	16QAM	1/0	815.5	20.73	118.30
3	16QAM	1/0	831.5	20.76	119.12
3	16QAM	1/0	847.5	20.45	110.92
5	QPSK	1/0	816.5	21.92	155.60
5	QPSK	1/0	831.5	21.96	157.04
5	QPSK	1/0	846.5	21.73	148.94
5	16QAM	1/0	816.5	20.97	125.03
5	16QAM	1/0	831.5	20.99	125.60
5	16QAM	1/0	846.5	20.80	120.23
10	QPSK	1/0	819	21.38	137.40
10	QPSK	1/0	831.5	21.82	152.05
10	QPSK	1/0	844	21.56	143.22
10	16QAM	1/0	819	20.48	111.69
10	16QAM	1/0	831.5	20.86	121.90
10	16QAM	1/0	844	20.58	114.29
15	QPSK	1/0	831.5	22.17	164.82
15	QPSK	1/0	836.5	22.16	164.44
15	QPSK	1/0	841.5	22.06	160.69
15	16QAM	1/0	831.5	21.40	138.04
15	16QAM	1/0	836.5	21.23	132.74
15	16QAM	1/0	841.5	21.17	130.92

High Frequency Substitution Measurement
 UL Verification Services, Inc.

Company: SOMC
 Project #: 16U23577
 Date: 6/2/2016
 Test Engineer: 45250, A.E.
 Configuration: EUT Only
 Location: Chamber B
 Mode: LTE_QPSK Band 26 Fundamentals, 1.4MHz Bandwidth

Test Equipment:
 Receiving: Hybrid T130, and Chamber B SMA Cables
 Substitution: Dipole T416, 6ft N-Type Cable

f MHz	SG reading (dBm)	Ant. Pol. (H/V)	Cable Loss (dB)	Antenna Gain (dBd)	ERP (dBm)	Limit (dBm)	Delta (dB)	Notes
Low Ch								
814.70	14.45	V	0.9	0.0	13.55	50.0	-36.5	
814.70	22.26	H	0.9	0.0	21.36	50.0	-28.6	
Mid Ch								
831.50	14.29	V	0.9	0.0	13.39	38.5	-25.1	
831.50	22.46	H	0.9	0.0	21.56	38.5	-16.9	
High Ch								
848.30	14.00	V	0.9	0.0	13.10	38.5	-25.4	
848.30	21.93	H	0.9	0.0	21.03	38.5	-17.5	

LTE B26 1.4MHz QPSK

High Frequency Substitution Measurement
 UL Verification Services, Inc.

Company: SOMC
 Project #: 16U23577
 Date: 6/2/2016
 Test Engineer: 45250, A.E.
 Configuration: EUT Only
 Location: Chamber B
 Mode: LTE_16QAM Band 26 Fundamentals, 1.4MHz Bandwidth

Test Equipment:
 Receiving: Hybrid T130, and Chamber B SMA Cables
 Substitution: Dipole T416, 6ft N-Type Cable

f MHz	SG reading (dBm)	Ant. Pol. (H/V)	Cable Loss (dB)	Antenna Gain (dBd)	ERP (dBm)	Limit (dBm)	Delta (dB)	Notes
Low Ch								
814.70	13.76	V	0.9	0.0	12.86	50.0	-37.1	
814.70	21.43	H	0.9	0.0	20.53	50.0	-29.5	
Mid Ch								
831.50	13.35	V	0.9	0.0	12.45	38.5	-26.0	
831.50	21.54	H	0.9	0.0	20.64	38.5	-17.9	
High Ch								
848.30	13.11	V	0.9	0.0	12.21	38.5	-26.3	
848.30	21.13	H	0.9	0.0	20.23	38.5	-18.3	

LTE B26 1.4MHz 16QAM

High Frequency Substitution Measurement
 UL Verification Services, Inc.

Company: SOMC
 Project #: 16U23577
 Date: 6/2/2016
 Test Engineer: 45250, A.E.
 Configuration: EUT Only
 Location: Chamber B
 Mode: LTE_QPSK Band 26 Fundamentals, 3MHz Bandwidth

Test Equipment:
 Receiving: Hybrid T130, and Chamber B SMA Cables
 Substitution: Dipole T416, 6ft N-Type Cable

f MHz	SG reading (dBm)	Ant. Pol. (H/V)	Cable Loss (dB)	Antenna Gain (dBd)	ERP (dBm)	Limit (dBm)	Delta (dB)	Notes
Low Ch								
815.50	14.95	V	0.9	0.0	14.05	50.0	-36.0	
815.50	22.45	H	0.9	0.0	21.55	50.0	-28.5	
Mid Ch								
831.50	14.13	V	0.9	0.0	13.23	38.5	-25.3	
831.50	22.47	H	0.9	0.0	21.57	38.5	-16.9	
High Ch								
847.50	14.23	V	0.9	0.0	13.33	38.5	-25.2	
847.50	22.21	H	0.9	0.0	21.31	38.5	-17.2	

LTE B26 3MHz QPSK

High Frequency Substitution Measurement
 UL Verification Services, Inc.

Company: SOMC
 Project #: 16U23577
 Date: 6/2/2016
 Test Engineer: 45250, A.E.
 Configuration: EUT Only
 Location: Chamber B
 Mode: LTE_16QAM Band 26 Fundamentals, 3MHz Bandwidth

Test Equipment:
 Receiving: Hybrid T130, and Chamber B SMA Cables
 Substitution: Dipole T416, 6ft N-Type Cable

f MHz	SG reading (dBm)	Ant. Pol. (H/V)	Cable Loss (dB)	Antenna Gain (dBd)	ERP (dBm)	Limit (dBm)	Delta (dB)	Notes
Low Ch								
815.50	14.05	V	0.9	0.0	13.15	50.0	-36.9	
815.50	21.63	H	0.9	0.0	20.73	50.0	-29.3	
Mid Ch								
831.50	13.16	V	0.9	0.0	12.26	38.5	-26.2	
831.50	21.66	H	0.9	0.0	20.76	38.5	-17.7	
High Ch								
847.50	13.33	V	0.9	0.0	12.43	38.5	-26.1	
847.50	21.35	H	0.9	0.0	20.45	38.5	-18.1	

LTE B26 3MHz 16QAM

High Frequency Substitution Measurement
 UL Verification Services, Inc.

Company: SOMC
 Project #: 16U23577
 Date: 6/2/2016
 Test Engineer: 45250, A.E.
 Configuration: EUT Only
 Location: Chamber B
 Mode: LTE_QPSK Band 26 Fundamentals, 5MHz Bandwidth

Test Equipment:
 Receiving: Hybrid T130, and Chamber B SMA Cables
 Substitution: Dipole T416, 6ft N-Type Cable

f MHz	SG reading (dBm)	Ant. Pol. (H/V)	Cable Loss (dB)	Antenna Gain (dBd)	ERP (dBm)	Limit (dBm)	Delta (dB)	Notes
Low Ch								
816.50	13.62	V	0.9	0.0	12.72	50.0	-37.3	
816.50	22.82	H	0.9	0.0	21.92	50.0	-28.1	
Mid Ch								
831.50	14.16	V	0.9	0.0	13.26	38.5	-25.2	
831.50	22.86	H	0.9	0.0	21.96	38.5	-16.5	
High Ch								
846.50	14.51	V	0.9	0.0	13.61	38.5	-24.9	
846.50	22.63	H	0.9	0.0	21.73	38.5	-16.8	

LTE B26 5MHz QPSK

High Frequency Substitution Measurement
 UL Verification Services, Inc.

Company: SOMC
 Project #: 16U23577
 Date: 6/2/2016
 Test Engineer: 45250, A.E.
 Configuration: EUT Only
 Location: Chamber B
 Mode: LTE_16QAM Band 26 Fundamentals, 5MHz Bandwidth

Test Equipment:
 Receiving: Hybrid T130, and Chamber B SMA Cables
 Substitution: Dipole T416, 6ft N-Type Cable

f MHz	SG reading (dBm)	Ant. Pol. (H/V)	Cable Loss (dB)	Antenna Gain (dBd)	ERP (dBm)	Limit (dBm)	Delta (dB)	Notes
Low Ch								
816.50	12.81	V	0.9	0.0	11.91	50.0	-38.1	
816.50	21.87	H	0.9	0.0	20.97	50.0	-29.0	
Mid Ch								
831.50	13.44	V	0.9	0.0	12.54	38.5	-26.0	
831.50	21.89	H	0.9	0.0	20.99	38.5	-17.5	
High Ch								
846.50	13.72	V	0.9	0.0	12.82	38.5	-25.7	
846.50	21.70	H	0.9	0.0	20.80	38.5	-17.7	

LTE B26 5MHz 16QAM

High Frequency Substitution Measurement
 UL Verification Services, Inc.

Company: SOMC
 Project #: 16U23577
 Date: 6/2/2016
 Test Engineer: 45250, A.E.
 Configuration: EUT Only
 Location: Chamber B
 Mode: LTE_QPSK Band 26 Fundamentals, 10MHz Bandwidth

Test Equipment:
 Receiving: Hybrid T130, and Chamber B SMA Cables
 Substitution: Dipole T416, 6ft N-Type Cable

f MHz	SG reading (dBm)	Ant. Pol. (H/V)	Cable Loss (dB)	Antenna Gain (dBd)	ERP (dBm)	Limit (dBm)	Delta (dB)	Notes
Low Ch								
819.00	15.00	V	0.9	0.0	14.10	50.0	-35.9	
819.00	22.28	H	0.9	0.0	21.38	50.0	-28.6	
Mid Ch								
831.50	14.41	V	0.9	0.0	13.51	38.5	-25.0	
831.50	22.72	H	0.9	0.0	21.82	38.5	-16.7	
High Ch								
844.00	13.64	V	0.9	0.0	12.74	38.5	-25.8	
844.00	22.46	H	0.9	0.0	21.56	38.5	-16.9	

LTE B26 10MHz QPSK

High Frequency Substitution Measurement
 UL Verification Services, Inc.

Company: SOMC
 Project #: 16U23577
 Date: 6/2/2016
 Test Engineer: 45250, A.E.
 Configuration: EUT Only
 Location: Chamber B
 Mode: LTE_16QAM Band 26 Fundamentals, 10MHz Bandwidth

Test Equipment:
 Receiving: Hybrid T130, and Chamber B SMA Cables
 Substitution: Dipole T416, 6ft N-Type Cable

f MHz	SG reading (dBm)	Ant. Pol. (H/V)	Cable Loss (dB)	Antenna Gain (dBd)	ERP (dBm)	Limit (dBm)	Delta (dB)	Notes
Low Ch								
819.00	14.17	V	0.9	0.0	13.27	50.0	-36.7	
819.00	21.38	H	0.9	0.0	20.48	50.0	-29.5	
Mid Ch								
831.50	13.58	V	0.9	0.0	12.68	38.5	-25.8	
831.50	21.76	H	0.9	0.0	20.86	38.5	-17.6	
High Ch								
844.00	12.91	V	0.9	0.0	12.01	38.5	-26.5	
844.00	21.48	H	0.9	0.0	20.58	38.5	-17.9	

LTE B26 10MHz 16QAM

High Frequency Substitution Measurement
 UL Verification Services, Inc.

Company: SOMC
 Project #: 16U23577
 Date: 6/2/2016
 Test Engineer: 45250, A.E.
 Configuration: EUT Only
 Location: Chamber B
 Mode: LTE_QPSK Band 26 Fundamentals, 15MHz Bandwidth

Test Equipment:
 Receiving: Hybrid T130, and Chamber B SMA Cables
 Substitution: Dipole T416, 6ft N-Type Cable

f MHz	SG reading (dBm)	Ant. Pol. (H/V)	Cable Loss (dB)	Antenna Gain (dBd)	ERP (dBm)	Limit (dBm)	Delta (dB)	Notes
Low Ch								
831.50	13.74	V	0.9	0.0	12.84	38.5	-25.7	
831.50	23.07	H	0.9	0.0	22.17	38.5	-16.3	
Mid Ch								
836.50	13.74	V	0.9	0.0	12.84	38.5	-25.7	
836.50	23.06	H	0.9	0.0	22.16	38.5	-16.3	
High Ch								
841.50	13.97	V	0.9	0.0	13.07	38.5	-25.4	
841.50	22.96	H	0.9	0.0	22.06	38.5	-16.4	

LTE B26 15MHz QPSK

High Frequency Substitution Measurement
 UL Verification Services, Inc.

Company: SOMC
 Project #: 16U23577
 Date: 6/2/2016
 Test Engineer: 45250, A.E.
 Configuration: EUT Only
 Location: Chamber B
 Mode: LTE_16QAM Band 26 Fundamentals, 15MHz Bandwidth

Test Equipment:
 Receiving: Hybrid T130, and Chamber B SMA Cables
 Substitution: Dipole T416, 6ft N-Type Cable

f MHz	SG reading (dBm)	Ant. Pol. (H/V)	Cable Loss (dB)	Antenna Gain (dBd)	ERP (dBm)	Limit (dBm)	Delta (dB)	Notes
Low Ch								
831.50	12.88	V	0.9	0.0	11.98	38.5	-26.5	
831.50	22.30	H	0.9	0.0	21.40	38.5	-17.1	
Mid Ch								
836.50	12.87	V	0.9	0.0	11.97	38.5	-26.5	
836.50	22.13	H	0.9	0.0	21.23	38.5	-17.3	
High Ch								
841.50	13.33	V	0.9	0.0	12.43	38.5	-26.1	
841.50	22.07	H	0.9	0.0	21.17	38.5	-17.3	

LTE B26 15MHz 16QAM

14.2. FIELD STRENGTH OF SPURIOUS RADIATION

RULE PART(S)

FCC: §2.1053, §22.917 and §90.691

LIMIT

The power of any emission outside of the authorized operating frequency ranges must be attenuated below the transmitting power (P) by a factor of at least $43 + 10 \log (P)$ dB.

TEST PROCEDURE

For Cellular equipment - Compliance with these rules is based on the use of measurement instrumentation employing a resolution bandwidth of 100 kHz or greater. In the 1 MHz bands immediately outside and adjacent to the frequency block a resolution bandwidth of at least one percent of the emission bandwidth of the fundamental emission of the transmitter may be employed. A narrower resolution bandwidth is permitted in all cases to improve measurement accuracy provided the measured power is integrated over the full required measurement bandwidth (i.e. 100 kHz or 1 percent of emission bandwidth, as specified). The emission bandwidth is defined as the width of the signal between two points, one below the carrier center frequency and one above the carrier center frequency, outside of which all emissions are attenuated at least 26 dB below the transmitter power.

For PCS equipment - Compliance with these rules is based on the use of measurement instrumentation employing a resolution bandwidth of 1 MHz or greater. However, in the 1 MHz bands immediately outside and adjacent to the frequency block a resolution bandwidth of at least one percent of the emission bandwidth of the fundamental emission of the transmitter may be employed. A narrower resolution bandwidth is permitted in all cases to improve measurement accuracy provided the measured power is integrated over the full required measurement bandwidth (i.e. 1 MHz or 1 percent of emission bandwidth, as specified). The emission bandwidth is defined as the width of the signal between two points, one below the carrier center frequency and one above the carrier center frequency, outside of which all emissions are attenuated at least 26 dB below the transmitter power.

14.2.1. SPURIOUS RADIATION PLOTS

LTE Band 26

UL Verification Services, Inc. Above 1GHz High Frequency Substitution Measurement										
Company:		SOMC								
Project #:		16U23577								
Date:		6/3/2016								
Test Engineer:		43574 JS								
Configuration:		EUT + AC Adapter + HS								
Location:		Chamber C								
Mode:		LTE_QPSK Band 26 Harmonics, 1.4MHz Bandwidth								
f MHz	SG reading (dBm)	Ant. Pol. (H/V)	Distance (m)	Preamp (dB)	Filter (dB)	EIRP (dBm)	Limit (dBm)	Delta (dB)	Notes	
Low Ch, 814.7										
1629.40	-28.5	V	3.0	36.4	1.0	-63.9	-13.0	-50.9		
2444.10	-23.4	V	3.0	35.0	1.0	-57.4	-13.0	-44.4		
3258.80	-24.0	V	3.0	34.3	1.0	-57.3	-13.0	-44.3		
1629.40	-29.9	H	3.0	36.4	1.0	-65.3	-13.0	-52.3		
2444.10	-24.0	H	3.0	35.0	1.0	-58.0	-13.0	-45.0		
3258.80	-24.7	H	3.0	34.3	1.0	-58.0	-13.0	-45.0		
Mid Ch, 831.5										
1663.00	-28.5	V	3.0	36.3	1.0	-63.9	-13.0	-50.9		
2494.50	-24.4	V	3.0	34.9	1.0	-58.4	-13.0	-45.4		
3326.00	-24.7	V	3.0	34.2	1.0	-58.0	-13.0	-45.0		
1663.00	-29.2	H	3.0	36.3	1.0	-64.6	-13.0	-51.6		
2494.50	-24.5	H	3.0	34.9	1.0	-58.5	-13.0	-45.5		
3326.00	-25.2	H	3.0	34.2	1.0	-58.5	-13.0	-45.5		
High Ch, 848.3										
1696.60	-27.1	V	3.0	36.3	1.0	-62.3	-13.0	-49.3		
2544.90	-25.1	V	3.0	34.9	1.0	-59.0	-13.0	-46.0		
3393.20	-24.4	V	3.0	34.2	1.0	-57.6	-13.0	-44.6		
1696.60	-28.5	H	3.0	36.3	1.0	-63.8	-13.0	-50.8		
2544.90	-25.1	H	3.0	34.9	1.0	-59.0	-13.0	-46.0		
3393.20	-24.8	H	3.0	34.2	1.0	-58.0	-13.0	-45.0		

LTE B26 1.4MHz QPSK

UL Verification Services, Inc. Above 1GHz High Frequency Substitution Measurement										
Company:		SOMC								
Project #:		16U23577								
Date:		6/3/2016								
Test Engineer:		43574 JS								
Configuration:		EUT + AC Adapter + HS								
Location:		Chamber C								
Mode:		LTE_16QAM Band 26 Harmonics, 1.4MHz Bandwidth								
f MHz	SG reading (dBm)	Ant. Pol. (H/V)	Distance (m)	Preamp (dB)	Filter (dB)	EIRP (dBm)	Limit (dBm)	Delta (dB)	Notes	
Low Ch, 814.7										
1629.40	-28.2	V	3.0	36.4	1.0	-64.6	-13.0	-51.6		
2444.10	-23.5	V	3.0	35.0	1.0	-57.5	-13.0	-44.5		
3258.80	-24.8	V	3.0	34.3	1.0	-58.1	-13.0	-45.1		
1629.40	-29.8	H	3.0	36.4	1.0	-66.2	-13.0	-53.2		
2444.10	-24.0	H	3.0	35.0	1.0	-58.0	-13.0	-45.0		
3258.80	-25.4	H	3.0	34.3	1.0	-58.7	-13.0	-45.7		
Mid Ch, 831.5										
1663.00	-28.0	V	3.0	36.3	1.0	-63.4	-13.0	-50.4		
2494.50	-24.7	V	3.0	34.9	1.0	-58.6	-13.0	-45.6		
3326.00	-24.3	V	3.0	34.2	1.0	-57.6	-13.0	-44.6		
1663.00	-28.2	H	3.0	36.3	1.0	-64.6	-13.0	-51.6		
2494.50	-24.0	H	3.0	34.9	1.0	-57.9	-13.0	-44.9		
3326.00	-24.2	H	3.0	34.2	1.0	-57.4	-13.0	-44.4		
High Ch, 848.3										
1696.60	-27.5	V	3.0	36.3	1.0	-62.8	-13.0	-49.8		
2544.90	-25.0	V	3.0	34.9	1.0	-59.5	-13.0	-46.5		
3393.20	-24.2	V	3.0	34.2	1.0	-57.4	-13.0	-44.4		
1696.60	-28.7	H	3.0	36.3	1.0	-64.0	-13.0	-51.0		
2544.90	-25.8	H	3.0	34.9	1.0	-59.7	-13.0	-46.7		
3393.20	-25.0	H	3.0	34.2	1.0	-58.2	-13.0	-45.2		

LTE B26 1.4MHz 16QAM

UL Verification Services, Inc. Above 1GHz High Frequency Substitution Measurement										
Company:		SOMC								
Project #:		16U23577								
Date:		6/3/2016								
Test Engineer:		43574 JS								
Configuration:		EUT + AC Adapter + HS								
Location:		Chamber C								
Mode:		LTE_QPSK Band 26 Harmonics, 3MHz Bandwidth								
f MHz	SG reading (dBm)	Ant. Pol. (H/V)	Distance (m)	Preamp (dB)	Filter (dB)	EIRP (dBm)	Limit (dBm)	Delta (dB)	Notes	
Low Ch, 815.5										
1631.00	-27.0	V	3.0	36.4	1.0	-62.4	-13.0	-49.4		
2446.50	-22.1	V	3.0	35.0	1.0	-56.1	-13.0	-43.1		
3262.00	-22.6	V	3.0	34.3	1.0	-56.0	-13.0	-43.0		
1631.00	-27.6	H	3.0	36.4	1.0	-63.0	-13.0	-50.0		
2446.50	-22.0	H	3.0	35.0	1.0	-56.1	-13.0	-43.1		
3262.00	-22.4	H	3.0	34.3	1.0	-55.7	-13.0	-42.7		
Mid Ch, 831.5										
1663.00	-27.1	V	3.0	36.3	1.0	-62.4	-13.0	-49.4		
2494.50	-24.4	V	3.0	34.9	1.0	-58.4	-13.0	-45.4		
3326.00	-24.0	V	3.0	34.2	1.0	-57.3	-13.0	-44.3		
1663.00	-28.6	H	3.0	36.3	1.0	-63.9	-13.0	-50.9		
2494.50	-24.0	H	3.0	34.9	1.0	-58.0	-13.0	-45.0		
3326.00	-24.8	H	3.0	34.2	1.0	-58.0	-13.0	-45.0		
High Ch, 847.5										
1695.00	-26.1	V	3.0	36.3	1.0	-61.4	-13.0	-48.4		
2542.50	-23.0	V	3.0	34.9	1.0	-56.9	-13.0	-43.9		
3390.00	-22.9	V	3.0	34.2	1.0	-56.1	-13.0	-43.1		
1695.00	-26.4	H	3.0	36.3	1.0	-61.7	-13.0	-48.7		
2542.50	-22.9	H	3.0	34.9	1.0	-56.8	-13.0	-43.8		
3390.00	-23.2	H	3.0	34.2	1.0	-56.4	-13.0	-43.4		

LTE B26 3MHz QPSK

UL Verification Services, Inc. Above 1GHz High Frequency Substitution Measurement										
Company:		SOMC								
Project #:		16U23577								
Date:		6/3/2016								
Test Engineer:		43574 JS								
Configuration:		EUT + AC Adapter + HS								
Location:		Chamber C								
Mode:		LTE_16QAM Band 26 Harmonics, 3MHz Bandwidth								
f MHz	SG reading (dBm)	Ant. Pol. (H/V)	Distance (m)	Preamp (dB)	Filter (dB)	EIRP (dBm)	Limit (dBm)	Delta (dB)	Notes	
Low Ch, 815.5										
1631.00	-27.4	V	3.0	36.4	1.0	-62.8	-13.0	-49.8		
2446.50	-22.8	V	3.0	35.0	1.0	-56.9	-13.0	-43.9		
3262.00	-22.9	V	3.0	34.3	1.0	-56.2	-13.0	-43.2		
1631.00	-28.1	H	3.0	36.4	1.0	-63.5	-13.0	-50.5		
2446.50	-22.4	H	3.0	35.0	1.0	-56.4	-13.0	-43.4		
3262.00	-22.6	H	3.0	34.3	1.0	-55.9	-13.0	-42.9		
Mid Ch, 831.5										
1663.00	-27.2	V	3.0	36.3	1.0	-62.6	-13.0	-49.6		
2494.50	-25.1	V	3.0	34.9	1.0	-59.1	-13.0	-46.1		
3326.00	-24.4	V	3.0	34.2	1.0	-57.6	-13.0	-44.6		
1663.00	-28.9	H	3.0	36.3	1.0	-64.2	-13.0	-51.2		
2494.50	-24.0	H	3.0	34.9	1.0	-58.0	-13.0	-45.0		
3326.00	-24.8	H	3.0	34.2	1.0	-58.1	-13.0	-45.1		
High Ch, 847.5										
1695.00	-26.7	V	3.0	36.3	1.0	-62.0	-13.0	-49.0		
2542.50	-23.9	V	3.0	34.9	1.0	-57.8	-13.0	-44.8		
3390.00	-23.1	V	3.0	34.2	1.0	-56.2	-13.0	-43.2		
1695.00	-26.5	H	3.0	36.3	1.0	-61.8	-13.0	-48.8		
2542.50	-23.2	H	3.0	34.9	1.0	-57.1	-13.0	-44.1		
3390.00	-23.9	H	3.0	34.2	1.0	-57.0	-13.0	-44.0		

LTE B26 3MHz 16QAM

UL Verification Services, Inc. Above 1GHz High Frequency Substitution Measurement										
Company:		SOMC								
Project #:		16U23577								
Date:		6/3/2016								
Test Engineer:		43574 JS								
Configuration:		EUT + AC Adapter + HS								
Location:		Chamber C								
Mode:		LTE_QPSK Band 26 Harmonics, 5MHz Bandwidth								
f MHz	SG reading (dBm)	Ant. Pol. (H/V)	Distance (m)	Preamp (dB)	Filter (dB)	EIRP (dBm)	Limit (dBm)	Delta (dB)	Notes	
Low Ch, 816.5										
1633.00	-26.8	V	3.0	36.4	1.0	-62.2	-13.0	-49.2		
2449.50	-22.1	V	3.0	35.0	1.0	-56.1	-13.0	-43.1		
3266.00	-21.9	V	3.0	34.3	1.0	-55.2	-13.0	-42.2		
1633.00	-27.2	H	3.0	36.4	1.0	-62.6	-13.0	-49.6		
2449.50	-21.9	H	3.0	35.0	1.0	-56.0	-13.0	-43.0		
3266.00	-22.9	H	3.0	34.3	1.0	-56.2	-13.0	-43.2		
Mid Ch, 831.5										
1663.00	-26.4	V	3.0	36.3	1.0	-61.8	-13.0	-48.8		
2494.50	-21.9	V	3.0	34.9	1.0	-55.8	-13.0	-42.8		
3326.00	-22.5	V	3.0	34.2	1.0	-55.7	-13.0	-42.7		
1663.00	-27.1	H	3.0	36.3	1.0	-62.5	-13.0	-49.5		
2494.50	-22.6	H	3.0	34.9	1.0	-56.5	-13.0	-43.5		
3326.00	-23.1	H	3.0	34.2	1.0	-56.3	-13.0	-43.3		
High Ch, 846.5										
1693.00	-23.8	V	3.0	36.3	1.0	-61.9	-13.0	-48.9		
2539.50	-21.4	V	3.0	34.9	1.0	-55.3	-13.0	-42.3		
3386.00	-19.7	V	3.0	34.2	1.0	-52.9	-13.0	-39.9		
1693.00	-24.9	H	3.0	36.3	1.0	-60.2	-13.0	-47.2		
2539.50	-22.0	H	3.0	34.9	1.0	-55.9	-13.0	-42.9		
3386.00	-20.9	H	3.0	34.2	1.0	-54.0	-13.0	-41.0		

LTE B26 5MHz QPSK

UL Verification Services, Inc. Above 1GHz High Frequency Substitution Measurement										
Company:		SOMC								
Project #:		16U23577								
Date:		6/3/2016								
Test Engineer:		43574 JS								
Configuration:		EUT + AC Adapter + HS								
Location:		Chamber C								
Mode:		LTE_16QAM Band 26 Harmonics, 5MHz Bandwidth								
f MHz	SG reading (dBm)	Ant. Pol. (H/V)	Distance (m)	Preamp (dB)	Filter (dB)	EIRP (dBm)	Limit (dBm)	Delta (dB)	Notes	
Low Ch, 816.5										
1633.00	-26.7	V	3.0	36.4	1.0	-62.1	-13.0	-49.1		
2449.50	-22.5	V	3.0	35.0	1.0	-56.5	-13.0	-43.5		
3266.00	-22.6	V	3.0	34.3	1.0	-55.9	-13.0	-42.9		
1633.00	-27.2	H	3.0	36.4	1.0	-62.6	-13.0	-49.6		
2449.50	-22.3	H	3.0	35.0	1.0	-56.3	-13.0	-43.3		
3266.00	-23.6	H	3.0	34.3	1.0	-56.9	-13.0	-43.9		
Mid Ch, 831.5										
1663.00	-26.2	V	3.0	36.3	1.0	-61.6	-13.0	-48.6		
2494.50	-22.8	V	3.0	34.9	1.0	-56.8	-13.0	-43.8		
3326.00	-22.7	V	3.0	34.2	1.0	-55.9	-13.0	-42.9		
1663.00	-26.9	H	3.0	36.3	1.0	-62.2	-13.0	-49.2		
2494.50	-22.4	H	3.0	34.9	1.0	-56.3	-13.0	-43.3		
3326.00	-23.3	H	3.0	34.2	1.0	-56.6	-13.0	-43.6		
High Ch, 846.5										
1693.00	-23.8	V	3.0	36.3	1.0	-61.9	-13.0	-48.9		
2539.50	-21.9	V	3.0	34.9	1.0	-55.9	-13.0	-42.9		
3386.00	-20.2	V	3.0	34.2	1.0	-53.4	-13.0	-40.4		
1693.00	-24.9	H	3.0	36.3	1.0	-60.2	-13.0	-47.2		
2539.50	-22.8	H	3.0	34.9	1.0	-56.7	-13.0	-43.7		
3386.00	-21.4	H	3.0	34.2	1.0	-54.6	-13.0	-41.6		

LTE B26 5MHz 16QAM

UL Verification Services, Inc. Above 1GHz High Frequency Substitution Measurement										
Company:		SOMC								
Project #:		16U23577								
Date:		6/3/2016								
Test Engineer:		43574 JS								
Configuration:		EUT + AC Adapter + HS								
Location:		Chamber C								
Mode:		LTE_QPSK Band 26 Harmonics, 10MHz Bandwidth								
f MHz	SG reading (dBm)	Ant. Pol. (H/V)	Distance (m)	Preamp (dB)	Filter (dB)	EIRP (dBm)	Limit (dBm)	Delta (dB)	Notes	
Low Ch, 819										
1638.00	-26.8	V	3.0	36.4	1.0	-62.1	-13.0	-49.1		
2457.00	-21.7	V	3.0	35.0	1.0	-55.7	-13.0	-42.7		
3276.00	-22.5	V	3.0	34.3	1.0	-55.8	-13.0	-42.8		
1638.00	-27.3	H	3.0	36.4	1.0	-62.7	-13.0	-49.7		
2457.00	-22.0	H	3.0	35.0	1.0	-56.1	-13.0	-43.1		
3276.00	-23.6	H	3.0	34.3	1.0	-56.9	-13.0	-43.9		
Mid Ch, 831.5										
1663.00	-26.3	V	3.0	36.3	1.0	-61.8	-13.0	-48.8		
2494.50	-22.3	V	3.0	34.9	1.0	-56.2	-13.0	-43.2		
3326.00	-22.3	V	3.0	34.2	1.0	-55.6	-13.0	-42.6		
1663.00	-27.5	H	3.0	36.3	1.0	-62.9	-13.0	-49.9		
2494.50	-22.5	H	3.0	34.9	1.0	-56.4	-13.0	-43.4		
3326.00	-22.8	H	3.0	34.2	1.0	-56.1	-13.0	-43.1		
High Ch, 844										
1688.00	-25.5	V	3.0	36.3	1.0	-60.8	-13.0	-47.8		
2532.00	-23.6	V	3.0	34.9	1.0	-57.6	-13.0	-44.6		
3376.00	-19.9	V	3.0	34.2	1.0	-53.1	-13.0	-40.1		
1688.00	-25.6	H	3.0	36.3	1.0	-60.9	-13.0	-47.9		
2532.00	-23.4	H	3.0	34.9	1.0	-57.3	-13.0	-44.3		
3376.00	-20.7	H	3.0	34.2	1.0	-53.9	-13.0	-40.9		

LTE B26 10MHz QPSK

UL Verification Services, Inc. Above 1GHz High Frequency Substitution Measurement										
Company:		SOMC								
Project #:		16U23577								
Date:		6/3/2016								
Test Engineer:		43574 JS								
Configuration:		EUT + AC Adapter + HS								
Location:		Chamber C								
Mode:		LTE_16QAM Band 26 Harmonics, 10MHz Bandwidth								
f MHz	SG reading (dBm)	Ant. Pol. (H/V)	Distance (m)	Preamp (dB)	Filter (dB)	EIRP (dBm)	Limit (dBm)	Delta (dB)	Notes	
Low Ch, 819										
1638.00	-26.7	V	3.0	36.4	1.0	-62.1	-13.0	-49.1		
2457.00	-21.9	V	3.0	35.0	1.0	-55.9	-13.0	-42.9		
3276.00	-22.8	V	3.0	34.3	1.0	-56.1	-13.0	-43.1		
1638.00	-27.4	H	3.0	36.4	1.0	-62.8	-13.0	-49.8		
2457.00	-23.0	H	3.0	35.0	1.0	-57.0	-13.0	-44.0		
3276.00	-24.2	H	3.0	34.3	1.0	-57.5	-13.0	-44.5		
Mid Ch, 831.5										
1663.00	-26.3	V	3.0	36.3	1.0	-61.7	-13.0	-48.7		
2494.50	-23.1	V	3.0	34.9	1.0	-57.0	-13.0	-44.0		
3326.00	-22.6	V	3.0	34.2	1.0	-55.8	-13.0	-42.8		
1663.00	-27.5	H	3.0	36.3	1.0	-62.8	-13.0	-49.8		
2494.50	-23.2	H	3.0	34.9	1.0	-57.1	-13.0	-44.1		
3326.00	-23.4	H	3.0	34.2	1.0	-56.6	-13.0	-43.6		
High Ch, 844										
1688.00	-25.4	V	3.0	36.3	1.0	-60.7	-13.0	-47.7		
2532.00	-24.2	V	3.0	34.9	1.0	-58.1	-13.0	-45.1		
3376.00	-20.9	V	3.0	34.2	1.0	-54.0	-13.0	-41.0		
1688.00	-25.7	H	3.0	36.3	1.0	-61.0	-13.0	-48.0		
2532.00	-24.1	H	3.0	34.9	1.0	-58.0	-13.0	-45.0		
3376.00	-21.3	H	3.0	34.2	1.0	-54.5	-13.0	-41.5		

LTE B26 10MHz 16QAM

UL Verification Services, Inc. Above 1GHz High Frequency Substitution Measurement										
Company:		SOMC								
Project #:		16U23577								
Date:		6/3/2016								
Test Engineer:		43574 JS								
Configuration:		EUT + AC Adapter + HS								
Location:		Chamber C								
Mode:		LTE_QPSK Band 26 Harmonics, 15MHz Bandwidth								
f MHz	SG reading (dBm)	Ant. Pol. (H/V)	Distance (m)	Preamp (dB)	Filter (dB)	EIRP (dBm)	Limit (dBm)	Delta (dB)	Notes	
Low Ch, 831.5										
1663.00	-26.0	V	3.0	36.3	1.0	-61.4	-13.0	-48.4		
2494.50	-21.7	V	3.0	34.9	1.0	-55.7	-13.0	-42.7		
3326.00	-22.4	V	3.0	34.2	1.0	-55.7	-13.0	-42.7		
1663.00	-27.0	H	3.0	36.3	1.0	-62.3	-13.0	-49.3		
2494.50	-22.2	H	3.0	34.9	1.0	-56.1	-13.0	-43.1		
3326.00	-23.4	H	3.0	34.2	1.0	-56.7	-13.0	-43.7		
Mid Ch, 836.5										
1673.00	-26.5	V	3.0	36.3	1.0	-61.9	-13.0	-48.9		
2509.50	-22.8	V	3.0	34.9	1.0	-56.7	-13.0	-43.7		
3346.00	-22.5	V	3.0	34.2	1.0	-55.8	-13.0	-42.8		
1673.00	-27.3	H	3.0	36.3	1.0	-62.6	-13.0	-49.6		
2509.50	-22.5	H	3.0	34.9	1.0	-56.5	-13.0	-43.5		
3346.00	-23.3	H	3.0	34.2	1.0	-56.5	-13.0	-43.5		
High Ch, 841.5										
1683.00	-26.1	V	3.0	36.3	1.0	-61.4	-13.0	-48.4		
2524.50	-23.1	V	3.0	34.9	1.0	-57.0	-13.0	-44.0		
3366.00	-22.7	V	3.0	34.2	1.0	-55.9	-13.0	-42.9		
1683.00	-26.6	H	3.0	36.3	1.0	-61.9	-13.0	-48.9		
2524.50	-23.3	H	3.0	34.9	1.0	-57.2	-13.0	-44.2		
3366.00	-22.8	H	3.0	34.2	1.0	-56.0	-13.0	-43.0		

LTE B26 15MHz QPSK

UL Verification Services, Inc. Above 1GHz High Frequency Substitution Measurement										
Company:		SOMC								
Project #:		16U23577								
Date:		6/3/2016								
Test Engineer:		43574 JS								
Configuration:		EUT + AC Adapter + HS								
Location:		Chamber C								
Mode:		LTE_16QAM Band 26 Harmonics, 15MHz Bandwidth								
f MHz	SG reading (dBm)	Ant. Pol. (H/V)	Distance (m)	Preamp (dB)	Filter (dB)	EIRP (dBm)	Limit (dBm)	Delta (dB)	Notes	
Low Ch, 831.5										
1663.00	-26.0	V	3.0	36.3	1.0	-61.4	-13.0	-48.4		
2494.50	-22.1	V	3.0	34.9	1.0	-56.0	-13.0	-43.0		
3326.00	-22.9	V	3.0	34.2	1.0	-56.1	-13.0	-43.1		
1663.00	-26.9	H	3.0	36.3	1.0	-62.2	-13.0	-49.2		
2494.50	-22.8	H	3.0	34.9	1.0	-56.8	-13.0	-43.8		
3326.00	-24.4	H	3.0	34.2	1.0	-57.7	-13.0	-44.7		
Mid Ch, 836.5										
1673.00	-26.5	V	3.0	36.3	1.0	-61.8	-13.0	-48.8		
2509.50	-23.0	V	3.0	34.9	1.0	-57.0	-13.0	-44.0		
3346.00	-23.1	V	3.0	34.2	1.0	-56.3	-13.0	-43.3		
1673.00	-27.3	H	3.0	36.3	1.0	-62.7	-13.0	-49.7		
2509.50	-23.2	H	3.0	34.9	1.0	-57.1	-13.0	-44.1		
3346.00	-23.8	H	3.0	34.2	1.0	-57.0	-13.0	-44.0		
High Ch, 841.5										
1683.00	-26.2	V	3.0	36.3	1.0	-61.5	-13.0	-48.5		
2524.50	-23.6	V	3.0	34.9	1.0	-57.5	-13.0	-44.5		
3366.00	-23.4	V	3.0	34.2	1.0	-56.7	-13.0	-43.7		
1683.00	-26.7	H	3.0	36.3	1.0	-62.0	-13.0	-49.0		
2524.50	-23.4	H	3.0	34.9	1.0	-57.4	-13.0	-44.4		
3366.00	-23.2	H	3.0	34.2	1.0	-56.4	-13.0	-43.4		

LTE B26 15MHz 16QAM