



UL LLC  
12 Laboratory Dr.  
Research Triangle Park, NC  
27709

[www.ul.com/emc](http://www.ul.com/emc)  
(919) 549-1400

Report Number: R11139405B-E2V3  
Order Number: 11139405  
Date: 04/26/16  
EUT: GSM/WCDMA/LTE Phone with  
BT, DTS/UNII a/b/g/n/ac & NFC  
FCC ID: PY7-PM0943

## Electromagnetic Compatibility Test Report

For

### SONY MOBILE COMMUNICATIONS, INC.

4-12-3 Higashi-Shinagawa, Shinagawa-Ku  
TOKYO, 140-0002 JAPAN

Copyright © 2016 UL LLC

UL LLC authorizes the above-named company to reproduce this Report provided it is reproduced in its entirety.

## Test Report Details

Tests Performed By: **UL LLC**  
**2800 Perimeter Park Drive, Suite B**  
**Morrisville, NC 27560 USA**

Tests Performed For: **Sony Mobile Communications Inc.**  
**4-12-3 Higashi-Shinagawa, Shinagawa-Ku**  
**TOKYO, 140-0002 JAPAN**

Test Report Date: **2016-04-21**

Product Type: **GSM/WCDMA/LTE Phone with BT, DTS/UNII a/b/g/n/ac & NFC**

Product standards **CFR 47 FCC Part 15 Subpart B: 2015, ICES-003 - 2016**

Sample Serial Number: **10253**

Testing Start Date: **2016-04-08**

Date Testing Complete: **2016-04-11**

**Overall Results: Compliant**

UL LLC reports apply only to the specific samples tested under stated test conditions. All samples tested were in good operating condition throughout the entire test program. It is the manufacturer's responsibility to assure that additional production units of this model are manufactured with identical electrical and mechanical components. UL LLC shall have no liability for any deductions, inferences or generalizations drawn by the client or others from UL LLC issued reports. This report must not be used by the client to claim product certification, approval, or endorsement by NVLAP, NIST, any agency of the Federal Government, or any agency of any government.

This report may contain test results that are not covered by the NVLAP or A2LA accreditation. The scope of accreditation is limited to the specific tests that are listed on the NVLAP and/or A2LA websites referenced at the end of this report.

## Report Directory

1.0	GENERAL - Product Description.....	4
1.1	Equipment Description .....	4
1.2	Device Configuration During Test .....	5
1.2.1	Equipment Used During Test:.....	5
1.2.2	Input/Output Ports:.....	5
1.2.3	EUT Internal Operating Frequencies:.....	6
1.2.4	Power Interface:.....	6
1.3	Block Diagram:.....	7
1.4	EUT Configurations .....	9
1.5	EUT Operation Modes .....	9
1.6	Rational for EUT Configuration .....	9
2.0	Summary .....	10
2.1	Deviations from standard test methods .....	10
2.2	Device Modifications Necessary for Compliance .....	10
2.3	Reference Standards .....	11
2.4	Results Summary .....	11
3.0	Calibration of Equipment Used for Measurement .....	12
4.0	EMISSIONS TEST RESULTS.....	12
4.1	Test Conditions and Results – MAINS TERMINAL – CONDUCTED EMISSIONS .....	13
4.2	Test Conditions and Results – RADIATED EMISSIONS.....	19
	Accreditations and Authorizations .....	27

Report Revision History

Version	Revision Date	Description	Revised By
V1	4/15/16	Initial Issue	JEFF MOSER
V2	4/21/16	Updated Issue date Information	CHOON OOI
V3	4/26/16	Updated Conducted Emission Test Equipment List	CHOON OOI

**1.0 GENERAL - Product Description**

**1.1 Equipment Description**

GSM/WCDMA/LTE Phone with BT, DTS/UNII a/b/g/n/ac & NFC.

**1.2 Device Configuration During Test**

**1.2.1 Equipment Used During Test:**

Use	Product Type	Manufacturer	Model	Comments
EUT	Phone	Sony Mobile Communication	FCC ID: PY7-PM0943	SN - 10253
AE	Laptop	Lenovo	T450	TYPE 20BU-S04K00 S/N PC-0A2UQU 16/01
AE	AC Adapter	Lenovo	ADLX65NCC2A	SN's: 11S45N0263Z1ZS995256HR 11S36200284ZZ1005255WE
AE	Mouse	Logitech	B100	M/N: M-U0026 P/N: 810-002149 S/N: 1451HS05PWZ8
AE	Keyboard	Logitech	Internet 350 Keyboard	M/N: Y-US76A P/N: 820-000172 PID: SC70812
Note1: EUT - Equipment Under Test, AE - Auxiliary/Associated Equipment, or SIM - Simulator (Not Subjected to Test)				
Note 2: Laptop Ethernet was plugged into facility wall jack that was connected to facility switch, running ping session.				

**1.2.2 Input/Output Ports:**

I/O Cable List						
Cable No	Port	# of identical ports	Connector Type	Cable Type	Cable Length (m)	Remarks
1	DC Power	2	Power	Shielded	1.2m	N/A
2	Audio	1	Mini-Jack	Unshielded	1m	N/A
3	USB	1	Mini-USB	Shielded	0.9 m	UCB16 cable from EUT to Laptop
3	USB	2	USB	Shielded	2m	From laptop to keyboard & mouse
4	AC Power	2	IEC	Unshielded	1m	N/A
5	Ethernet	1	RJ45	Unshielded	2m	N/A

**1.2.3 EUT Internal Operating Frequencies:**

Frequency (MHz)	Description
≤ 2200	The highest operating frequency is 2.2 GHz.

**1.2.4 Power Interface:**

Mode # /Rated	Voltage (V)	Current (A)	Power (W)	Frequency (DC/AC-Hz)	Phases (#)	Comments
Rated	100-240	-	-	50-60	1	
1	120	-	-	60	1	

**1.3 Block Diagram:**

The diagram below illustrates the configuration of the equipment above.

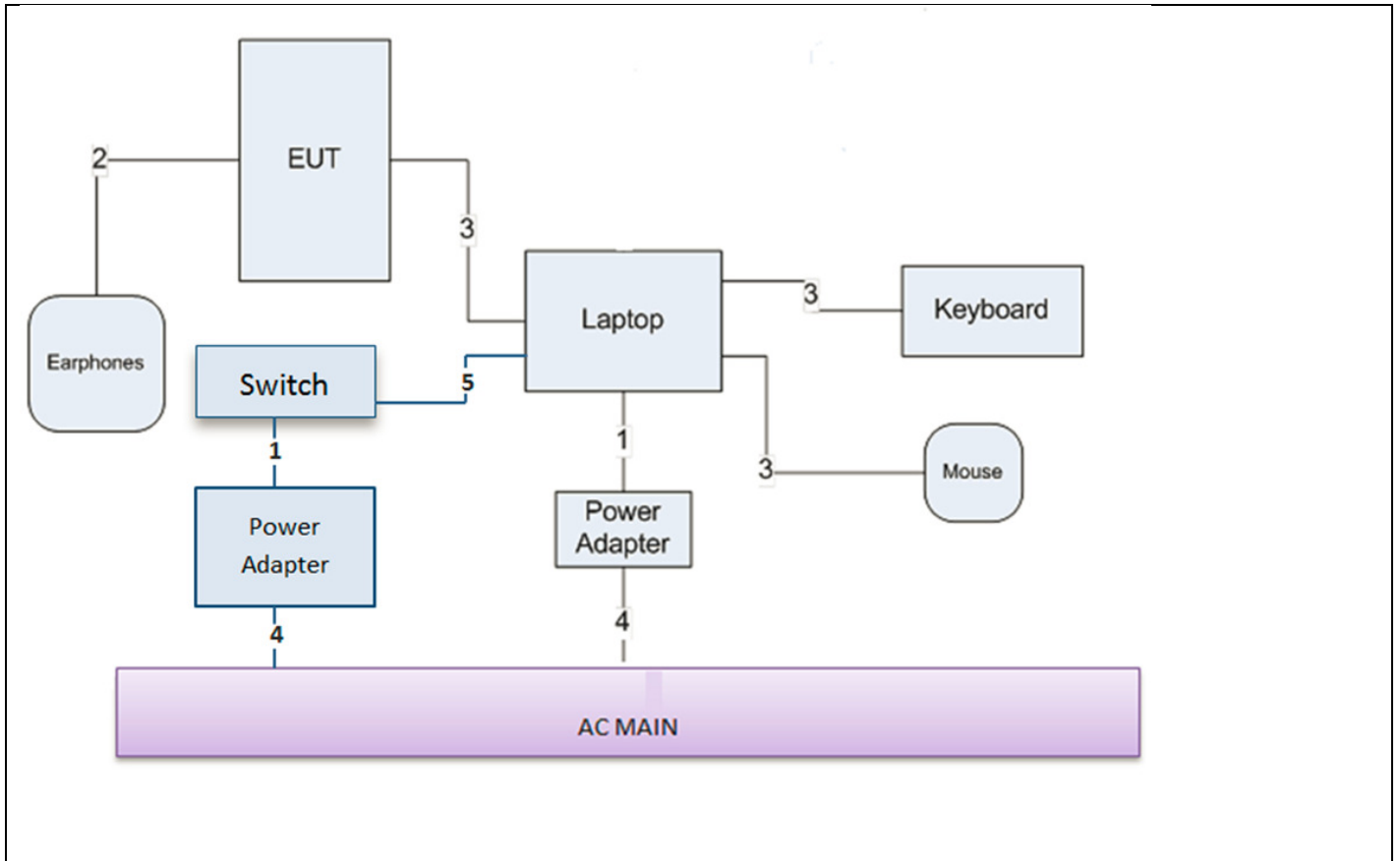

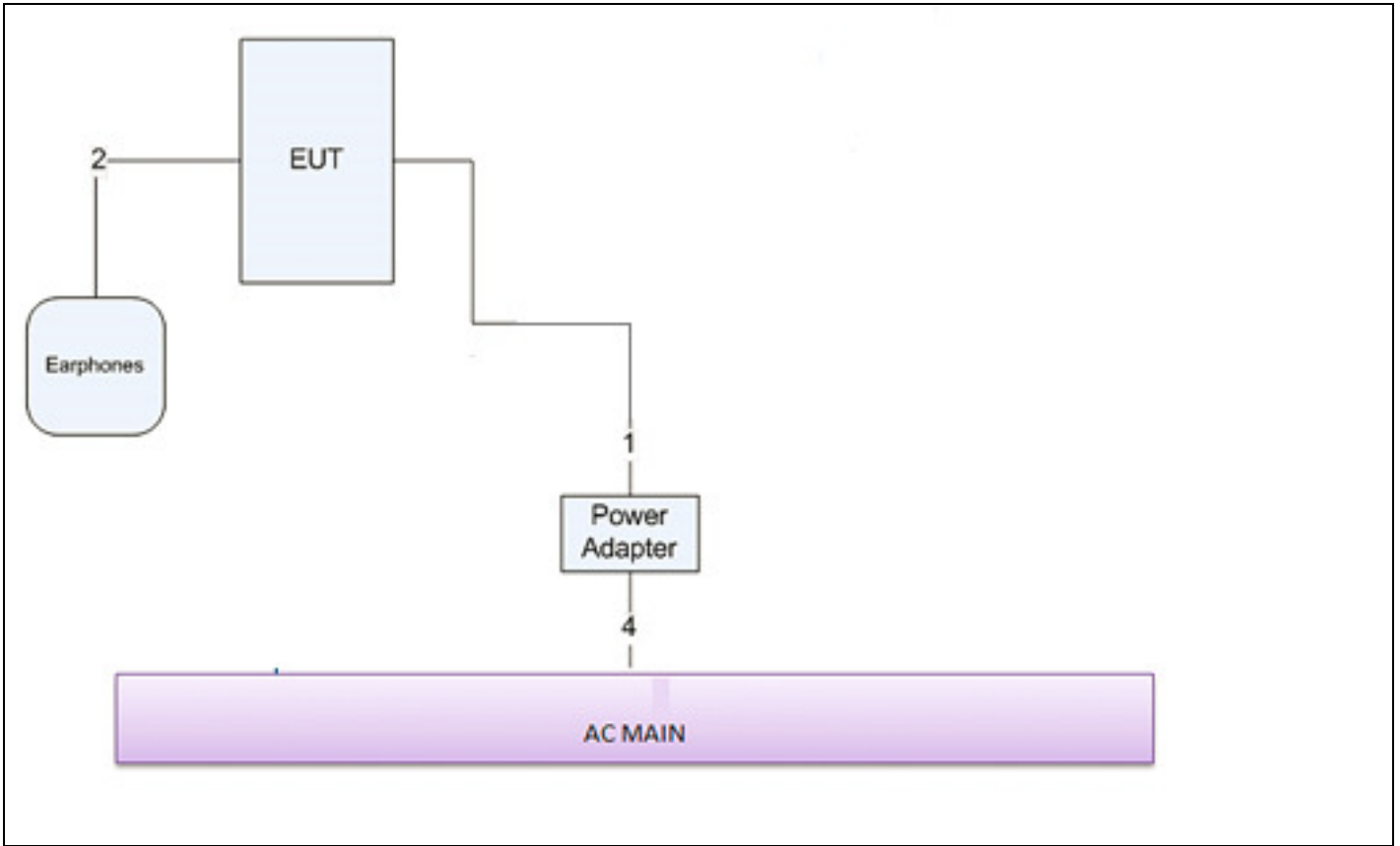



#### 1.4 EUT Configurations

Mode #	Description
Sync mode	Data transfer; Sync video file from laptop to EUT and continued playing video during testing.
Charging Mode	_Charging with supplied USB charger. EUT and its charger shall be on back edge of table, with charger connected to extension cord.

#### 1.5 EUT Operation Modes

Mode #	Description
1	Test software exercised the EUT.

#### 1.6 Rational for EUT Configuration

Mode #	Description
1	The selected EUT configuration was chosen to maximize emissions

## 2.0 Summary

The tests listed in the Summary of Testing section of this report have been performed and the results recorded by UL LLC in accordance with the procedures stated in each test requirement and specification. The applicant determined the list of tests performed were applicable to the Equipment Under Test. As a result, the subject product has been verified to comply or not comply as noted in the Summary of Testing with each test specification. The test results relate only to the items tested.

### 2.1 Deviations from standard test methods

None
------

### 2.2 Device Modifications Necessary for Compliance

None
------

**2.3 Reference Standards**

Standard Number	Standard Name	Standard Date
47 CFR Part 15, Subpart B	Radio Frequency Devices – Unintentional Radiators	2015
ICES-003	Information Technology Equipment (ITE) — Limits and methods of measurement	2016

**2.4 Results Summary**

This product is considered Class B.

Requirement – Test	Result (Compliant / Non-Compliant)*
Conducted Emissions - Mains	Compliant
Radiated Emissions	Compliant

Test Engineer:

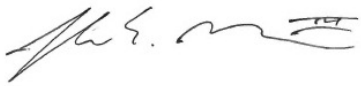

John Manser  
 EMC Laboratory Technician  
 UL – Consumer Technology Division

Reviewer:



Jeff Moser  
 EMC Program Manager  
 UL – Consumer Technology Division

Any information and documentation involving UL Mark services are provided on behalf of UL LLC (UL) or any authorized licensee of UL.

### 3.0 Calibration of Equipment Used for Measurement

All test equipment and test accessories are calibrated on a regular basis. The maximum time between calibrations is one year or the manufacturers' recommendation, whichever is less.

All test equipment calibrations are traceable to the National Institute of Standards and Technology (NIST); therefore, all test data recorded in this report is traceable to NIST.

### 4.0 EMISSIONS TEST RESULTS

The emissions tests were performed according to following regulations:

----- United States -----

Code of Federal Regulations Title 47	Part 15, Subpart B, Radio Frequency Devices
--------------------------------------	---

Unless specified otherwise in the individual Methods, the tests shall be conducted under the following ambient conditions. Confirmation of these conditions shall be verified at the time the test is conducted.

Ambient Temperature, °C	22.5 ± 2.5	Relative Humidity, %	45 ± 15	Barometric Pressure, mBar	950 ± 150
-------------------------	------------	----------------------	---------	---------------------------	-----------

#### Measurement Uncertainty

Test	Uncertainty
Conducted Emissions (0.150-30MHz)	+/- 2.37
Radiated Emissions (30-1000 MHz)	+/- 5.36
Radiated Emissions (1-18 GHz)	+/- 4.32

Note – The above values represent worst-case for each frequency range.

#### Sample Calculations

Radiated Field Strength and Conducted Emissions data contained within this report is calculated on the following basis:

- Field Strength (dBuV/m) = Meter Reading (dBuV) + AF (dB/m) - Gain (dB) + Cable Loss (dB)
- Conducted Voltage (dBuV) = Meter Reading (dBuV) + Cable Loss (dB) + LISN IL (dB)
- Conducted Current (dBuA) = Meter Reading (dBuV) + Cable Loss (dB) - Transducer Factor (dBohms)

**4.1 Test Conditions and Results – MAINS TERMINAL – CONDUCTED EMISSIONS**

Test Description	Measurements were made on a ground plane. All power was connected to the system through Artificial Mains Network (AMN). Conducted voltage measurements on mains lines were made at the output of the AMN.	
Basic Standard	FCC Part 15, Subparts A & B in conjunction with ANSI C63.4:2014	
UL LPG	80-EM-S0026	
	Frequency range on each side of line	Measurement Point
Fully configured sample scanned over the following frequency range	150kHz to 30MHz	Mains
<b>Limits - Class B</b>		
Frequency (MHz)	Limit (dB $\mu$ V)	
	Quasi-Peak	Average
0.15-0.5	66 to 56	56 to 46
0.5-5	56	46
5-30	60	50
Supplementary information: None		

**Table 1 Conducted Emissions EUT Configuration Settings**

Power Interface Mode #	EUT Configurations Mode #	EUT Operation Mode #
1	1	1
1	2	1
Supplementary information: None		

**Table 2 Conducted Emissions Test Equipment**

Test Equipment Used - Line-Conducted Emissions – Voltage (Morrisville – Conducted 1)

Equipment ID	Description	Manufacturer	Model Number	Last Cal.	Next Cal.
CBL077	Coax cable, RG223, N-male to BNC-male, 20-ft.	Pasternack	PE3476-240	2015-10-29	2016-10-31
HI0079	Temp/Humid/Pressure Meter	Springfield Precision	PreciseTemp	2015-07-01	2016-07-31
LISN003	LISN, 50-ohm/50-uH, 2-conductor, 25A	Fischer Custom Com.	FCC-LISN-50-25-2-01-550V	2015-08-24	2016-08-31
LISN008	LISN, 50-ohm/50-uH, 2-conductor, 25A (For support gear only.)	Solar Electronics	8012-50-R-24-BNC	2015-09-03	2016-09-30
MM0167	Multi-meter	Agilent	U1232A	2015-08-17	2016-08-31
PRE0101521 (75141)	EMI Test Receiver 9kHz-7GHz	Rohde & Schwarz	ESCI 7	2015-08-26	2016-08-31
TL001	Transient Limiter, 0.009-30MHz	Com-Power	LIT-930A	2015-05-22	2016-05-31
PS214	AC Power Source	Elgar	CW2501M (s/n 1523A02396)	NA	NA
PS215	AC Power Source	Elgar	CW2501M (s/n 1523A02397)	NA	NA
SOFTEMI	EMI Software	UL	Version 9.5	NA	NA

**Figure 2 Conducted Emissions Graph (Charging Adapter Mode)**

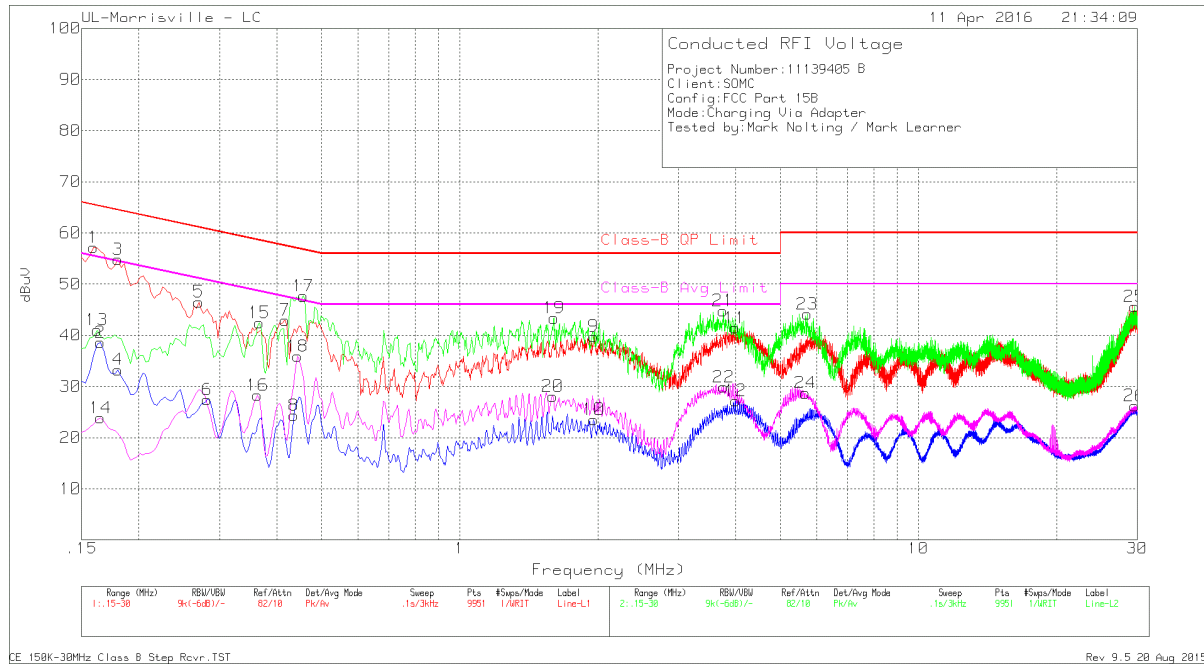

**Table 3 Conducted Emissions Data Points (Charging Adapter Mode)**

Marker	Frequency (MHz)	Meter Reading (dBuV)	Det	LISN VCF [dB]	Cbl/Limiter (dB)	Corrected Reading dBuV	Class-B QP Limit	Margin (dB)	Class-B Avg Limit	Margin (dB)
Range 1 (Line 1)										
1	.159	46.98	Pk	.2	10	57.18	65.52	-8.34	-	-
2	.165	28.4	Av	.2	10	38.6	-	-	55.21	-16.61
3	.18	44.61	Pk	.2	10	54.81	64.49	-9.68	-	-
4	.18	23.07	Av	.2	10	33.27	-	-	54.49	-21.22
5	.27	36.44	Pk	.1	10	46.54	61.12	-14.58	-	-
6	.282	17.34	Av	.1	10	27.44	-	-	50.76	-23.32
7	.417	32.86	Pk	.1	10	42.96	57.51	-14.55	-	-
8	.435	14.29	Av	.1	10	24.39	-	-	47.16	-22.77
9	1.962	29.58	Pk	.1	10.1	39.78	56	-16.22	-	-
10	1.962	13.34	Av	.1	10.1	23.54	-	-	46	-22.46
11	3.987	31.21	Pk	.1	10.1	41.41	56	-14.59	-	-
12	3.993	17.02	Av	.1	10.1	27.22	-	-	46	-18.78
Range 2 (Line 2)										
13	.162	30.82	Pk	.2	10	41.02	65.36	-24.34	-	-
14	.165	13.66	Av	.2	10	23.86	-	-	55.21	-31.35
15	.366	32.36	Pk	.1	10	42.46	58.59	-16.13	-	-
16	.363	18.18	Av	.1	10	28.28	-	-	48.66	-20.38
17	.456	37.56	Pk	.1	10	47.66	56.77	-9.11	-	-
18	.444	25.8	Av	.1	10	35.9	-	-	46.99	-11.09
19	1.605	33.36	Pk	0	10	43.36	56	-12.64	-	-
20	1.596	18.1	Av	0	10	28.1	-	-	46	-17.9
21	3.753	34.6	Pk	.1	10.1	44.8	56	-11.2	-	-
22	3.762	19.66	Av	.1	10.1	29.86	-	-	46	-16.14
23	5.721	33.86	Pk	.1	10.2	44.16	60	-15.84	-	-
24	5.676	18.43	Av	.1	10.2	28.73	-	-	50	-21.27
25	29.598	34.55	Pk	.4	10.7	45.65	60	-14.35	-	-
26	29.595	15.14	Av	.4	10.7	26.24	-	-	50	-23.76

Pk - Peak detector

Av - Average detection

CE 150K-30MHz Class B Step Rcvr.TST

Rev 9.5 20 Aug 2015



**Figure 3 Conducted Emissions Graph (Laptop Sync Mode)**

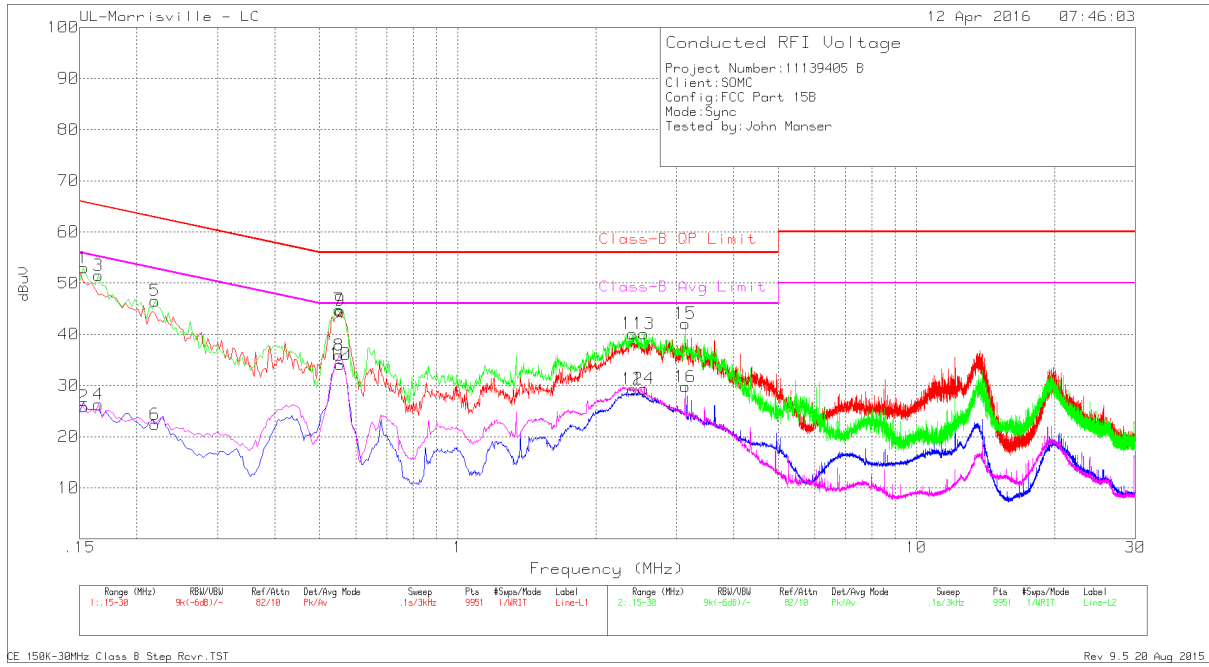

**Table 4 Conducted Emissions Data Points (Laptop Sync Mode)**

Marker	Frequency (MHz)	Meter Reading (dBUV)	Det	LISN VCF [dB]	Cbl/Limiter (dB)	Corrected Reading dBUV	Class-B QP Limit	Margin (dB)	Class-B Avg Limit	Margin (dB)
Range 1 (Line 1)										
9	.555	34.49	Pk	.1	10	44.59	56	-11.41	-	-
10	.555	24.01	Av	.1	10	34.11	-	-	46	-11.89
Range 2 (Line 2)										
1	.153	42.79	Pk	.2	10	52.99	65.84	-12.85	-	-
2	.153	15.68	Av	.2	10	25.88	-	-	55.84	-29.96
3	.165	41.34	Pk	.2	10	51.54	65.21	-13.67	-	-
4	.165	16.08	Av	.2	10	26.28	-	-	55.21	-28.93
5	.219	36.45	Pk	.1	10	46.55	62.86	-16.31	-	-
6	.219	12.31	Av	.1	10	22.41	-	-	52.86	-30.45
7	.552	34.8	Pk	0	10	44.8	56	-11.2	-	-
8	.552	25.9	Av	0	10	35.9	-	-	46	-10.1
11	2.406	30.03	Pk	0	10.1	40.13	56	-15.87	-	-
12	2.406	19.21	Av	0	10.1	29.31	-	-	46	-16.69
13	2.547	30.02	Pk	0	10.1	40.12	56	-15.88	-	-
14	2.547	19.25	Av	0	10.1	29.35	-	-	46	-16.65
15	3.132	32	Pk	0	10.1	42.1	56	-13.9	-	-
16	3.132	19.69	Av	0	10.1	29.79	-	-	46	-16.21

Pk - Peak detector

Av - Average detection

CE 150K-30MHz Class B Step Rcvr.TST

Rev 9.5 20 Aug 2015

**4.2 Test Conditions and Results – RADIATED EMISSIONS**

Test Description	Measurements were made in a 10-meter semi-anechoic chamber that complies to CISPR 16/ANSI C63.4. Preliminary (peak) measurements were performed at an antenna to EUT separation distance of 10-meter. The EUT was rotated 360° about its azimuth with the receive antenna located at various heights in both horizontal and vertical polarities. Final measurements (quasi-peak or average as noted) were then performed by rotating the EUT 360° and adjusting the receive antenna height from 1 to 4-meters. All frequencies were investigated in both horizontal and vertical antenna polarity, where applicable.	
Basic Standard	FCC Part 15, Subparts A & B in conjunction with ANSI C63.4:2003	
UL LPG	80-EM-S0029	
	Frequency range	Measurement Point
Fully configured sample scanned over the following frequency range	30MHz – 1GHz	10 meter – Class A 3 meter – Class B
	1-18 GHz	3 meter
	18-40 GHz	1 meter
<b>Limits - Class B</b>		
Frequency (MHz)	Limit (dBμV/m)	
	Quasi-Peak	Average
30-88	40	NA
88-216	43.5	NA
216-960	46	NA
960-1000	54	NA
1,000-18,000	NA	54
18,000-40,000	NA	54 <sup>Note3</sup>
Note 1 – Distance Correction (DCF) = 20 log (D <sub>NEW</sub> /D <sub>FCC</sub> ) = 20 log (3/10) = -10.45 dB		
Note 2 - Distance Correction (DCF) = 20 log (D <sub>NEW</sub> /D <sub>FCC</sub> ) = 20 log (1/10) = -20 dB, if measuring at 1m.		
Note 3 - Distance Correction (DCF) = 20 log (D <sub>NEW</sub> /D <sub>FCC</sub> ) = 20 log (1/3) = -9.54 dB, if measuring at 1m.		

**Table 5 Radiated Emissions EUT Configuration Settings**

Power Interface Mode #	EUT Configurations Mode #	EUT Operation Mode #
1	1	1
1	2	1
Supplementary information: None		

**Table 6 Radiated Emissions Test Equipment**

Test Equipment Used - Radiated Disturbance Emissions Test Equipment (Morrisville - South Chamber)

Equip. ID	Description	Manufacturer	Model Number	Last Cal.	Next Cal.
	<b>30-1000 MHz</b>				
AT0074	Hybrid Broadband Antenna	Sunol Sciences Corp.	JB3	2015-06-10	2016-06-30
	<b>1-18 GHz</b>				
AT0069	Double-Ridged Waveguide Horn Antenna, 1 to 18 GHz	ETS Lindgren	3117	2016-03-07	2017-03-31
	<b>Tuned Dipole Set</b>				
AT0013-AT0016	Four Dipole Antenna Set, 30 to 1000 MHz	EMCO	3121C-DB-1, -2, -3, -4	2015-05-06	2016-05-31
	<b>Gain-Loss Chains</b>				
S-SAC02	Gain-loss string: 30-1000MHz	Various	Various	2015-06-09	2016-06-30
S-SAC03	Gain-loss string: 1-18GHz	Various	Various	2015-08-22	2016-08-31
	<b>Receiver &amp; Software</b>				
SA0025	Spectrum Analyzer	Agilent	N9030A	2016-03-17	2017-03-31
SOFTEMI	EMI Software	UL	Version 9.5	NA	NA
	<b>Additional Equipment used</b>				
HI0050	Temp/Humid/Pressure Meter	Cole-Parmer	99760-00	2015-07-01	2016-07-31

**Figure 6 Radiated Emissions Graph – 30-1000 MHz (Charging Adapter Mode)**

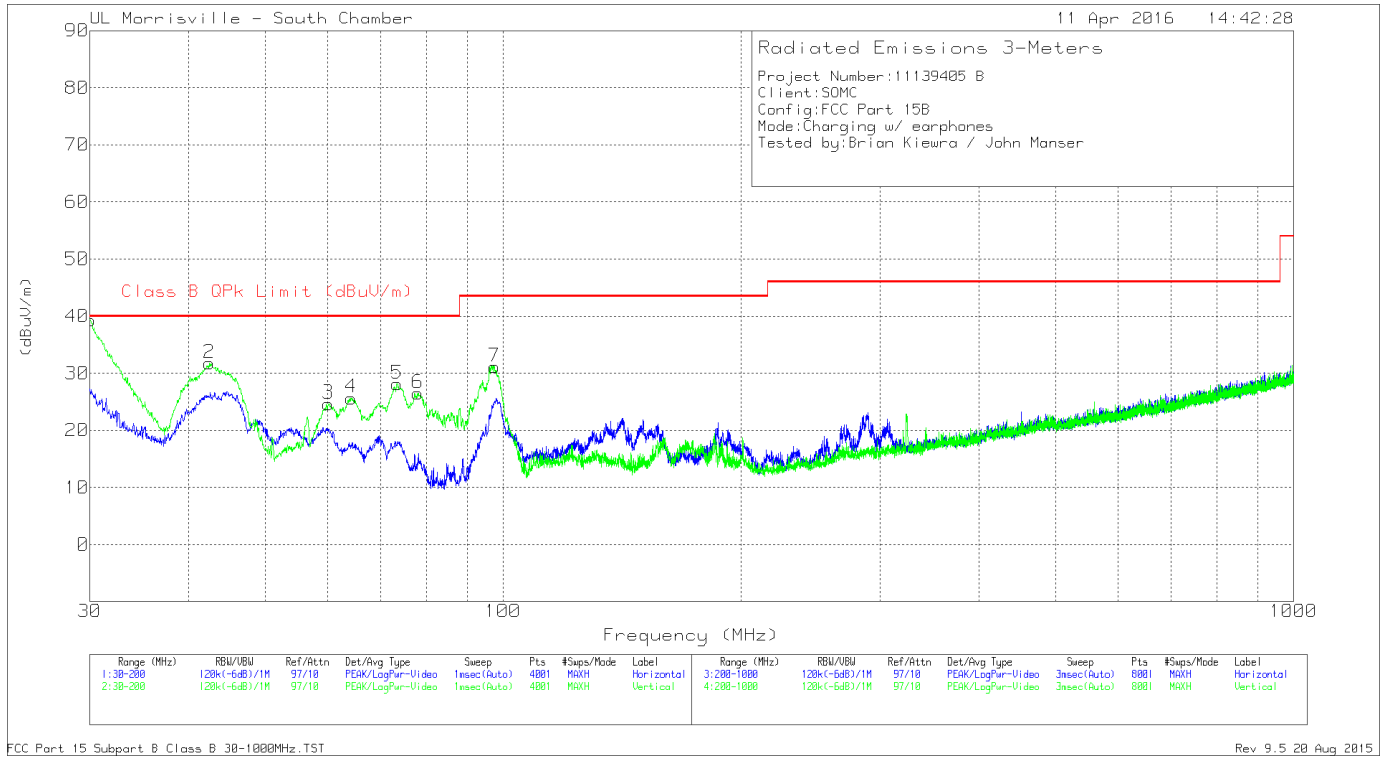

**Table 7 Radiated Emissions Data Points - 30-1000 MHz (Charging Adapter Mode)**

Trace Markers

Marker	Frequency (MHz)	Meter Reading (dBuV)	Det	AF AT0074 (dB/m)	Port 0 Factors	Corrected Reading (dBuV/m)	Class B QPk Limit (dBuV/m)	Margin (dB)	Azimuth (Degs)	Height (cm)	Polarity
1	30.0682	40.06	Qp	26.1	-31.8	34.36	40	-5.64	355	102	V
2	42.495	46.73	Pk	16.6	-31.6	31.73	40	-8.27	0-360	102	V
3	60.09	44.26	Pk	11.9	-31.5	24.66	40	-15.34	0-360	102	V
4	64.2975	44.87	Pk	12.1	-31.3	25.67	40	-14.33	0-360	102	V
5	73.3925	46.94	Pk	12.4	-31.2	28.14	40	-11.86	0-360	102	V
6	77.9613	45.61	Pk	12.2	-31.3	26.51	40	-13.49	0-360	102	V
7	97.5325	48.46	Pk	13.6	-30.9	31.16	43.52	-12.36	0-360	102	V

Pk - Peak detector

Qp - Quasi-Peak detector

FCC Part 15 Subpart B Class B 30-1000MHz.TST

Rev 9.5 20 Aug 2015

**Figure 7 Radiated Emissions Graph – 1-18 GHz (Charging Adapter Mode)**

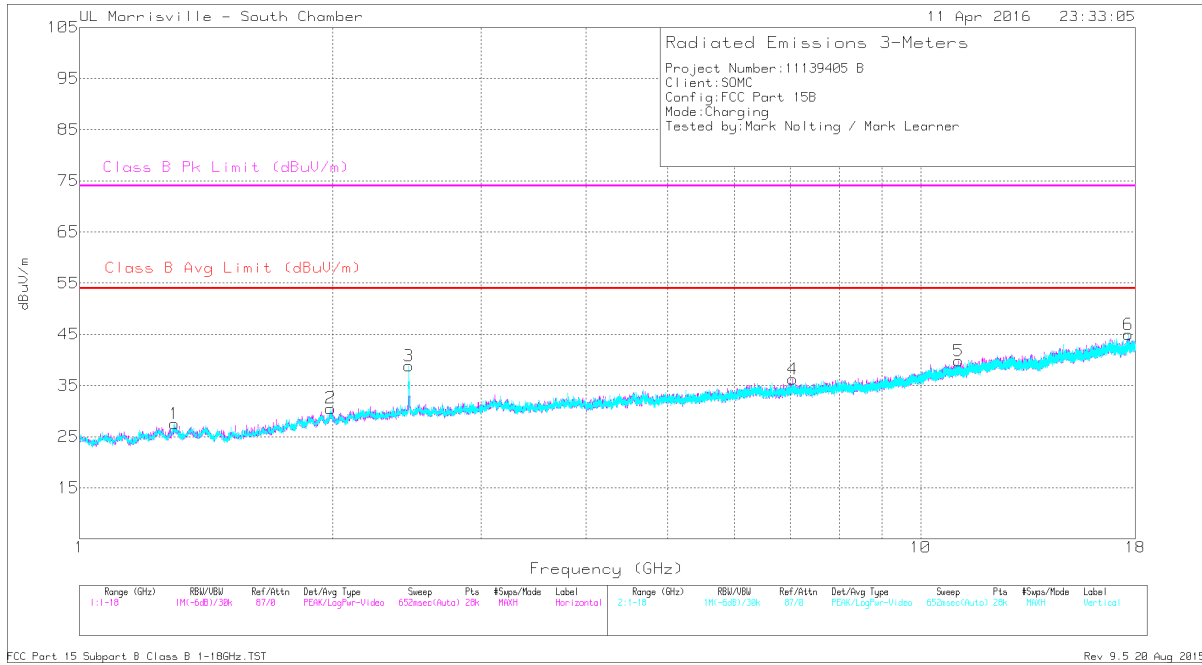

**Table 8 Radiated Emissions Data Points – 1-18 GHz (Charging Adapter Mode)**

Radiated Emissions

Frequency (GHz)	Meter Reading (dBuV)	Det	AF AT0069 (dB/m)	Amp/Cbl (dB)	Corrected Reading dBuV/m	Class B Avg Limit (dBuV/m)	Margin (dB)	Class B Pk Limit (dBuV/m)	Margin (dB)	Azimuth (Degs)	Height (cm)	Polarity
1.297	41.17	Pk	28.8	-35.6	34.37	-	-	74	-39.63	281	201	V
1.297	29.66	Av	28.8	-35.6	22.86	54	-31.14	-	-	281	201	V
1.988	42.14	Pk	31.2	-35.1	38.24	-	-	74	-35.76	17	201	V
1.988	29.17	Av	31.2	-35.1	25.27	54	-28.73	-	-	17	201	V
2.462	45.8	Pk	32.3	-34.7	43.4	-	-	74	-30.6	193	391	V
2.462	32.16	Av	32.3	-34.7	29.76	54	-24.24	-	-	193	391	V
7.049	37.99	Pk	35.6	-29.5	44.09	-	-	74	-29.91	321	394	H
7.049	24.55	Av	35.6	-29.5	30.65	54	-23.35	-	-	321	394	H
11.098	34.71	Pk	38	-25.8	46.91	-	-	74	-27.09	264	368	H
11.098	22.04	Av	38	-25.8	34.24	54	-19.76	-	-	264	368	H
17.651	34.52	Pk	41.2	-23	52.72	-	-	74	-21.28	297	135	V
17.651	21.66	Av	41.2	-23	39.86	54	-14.14	-	-	297	135	V

Pk - Peak detector

Av - Average detection

FCC Part 15 Subpart B Class B 1-18GHz.TST

Rev 9.5 20 Aug 2015

**Figure 8 Radiated Emissions Graph – 30-1000 MHz (Laptop Sync Mode)**

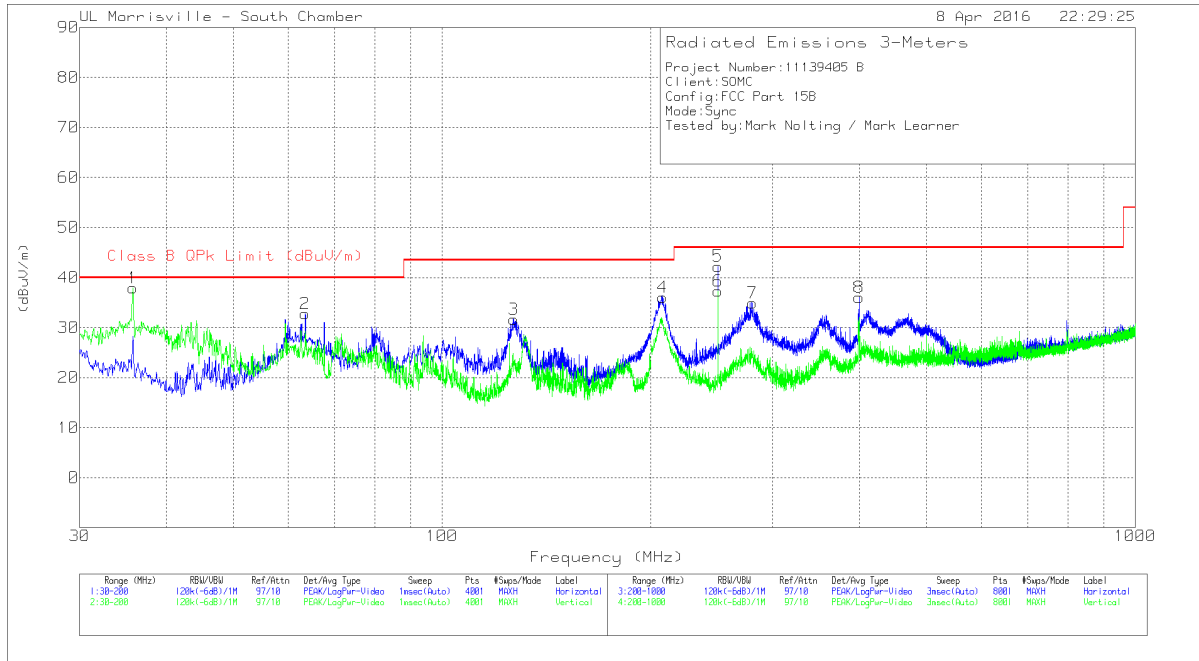

**Table 9 Radiated Emissions Data Points - 30-1000 MHz (Laptop Sync Mode)**

Trace Markers

Marker	Frequency (MHz)	Meter Reading (dBuV)	Det	AF AT0074 (dB/m)	Port 0 Factors	Corrected Reading (dBuV/m)	Class B QPk Limit (dBuV/m)	Margin (dB)	Azimuth (Degs)	Height (cm)	Polarity
1	35.8009	46.6	Qp	21.7	-31.7	36.6	40	-3.4	280	108	V
2	63.49	52.09	Pk	12.1	-31.4	32.79	40	-7.21	0-360	399	H
3	126.9	44.27	Pk	18.2	-30.8	31.67	43.52	-11.85	0-360	199	H
4	208.2	50.97	Pk	15.3	-30.2	36.07	43.52	-7.45	0-360	102	H
5	250.0226	54.59	Qp	16.3	-29.9	40.99	46.02	-5.03	152	109	H
6	250	50.91	Pk	16.3	-29.9	37.31	46.02	-8.71	0-360	102	V
7	280.6	46.93	Pk	17.8	-29.8	34.93	46.02	-11.09	0-360	102	H
8	399.5	45.05	Pk	20.2	-29.2	36.05	46.02	-9.97	0-360	199	H

Pk - Peak detector  
 Qp - Quasi-Peak detector

**Figure 9 Radiated Emissions Graph – 1-18 GHz (Laptop Sync Mode)**

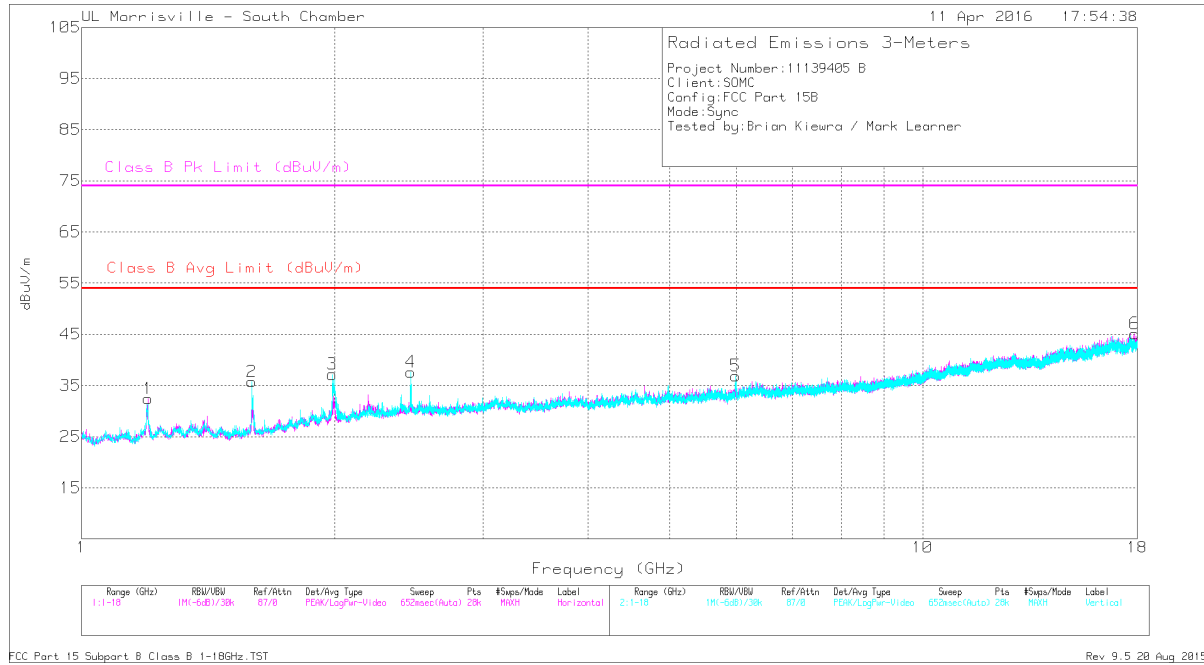

**Table 10 Radiated Emissions Data Points – 1-18 GHz (Laptop Sync Mode)**

Radiated Emissions

Frequency (GHz)	Meter Reading (dBuV)	Det	AF AT0069 (dB/m)	Amp/Cbl (dB)	Corrected Reading dBuV/m	Class B Avg Limit (dBuV/m)	Margin (dB)	Class B Pk Limit (dBuV/m)	Margin (dB)	Azimuth (Degs)	Height (cm)	Polarity
1.198	33.18	Av	28.2	-35.9	25.48	54	-28.52	-	-	344	276	H
1.198	54.29	Pk	28.2	-35.9	46.59	-	-	74	-27.41	344	276	H
1.599	57.01	Pk	28.4	-35.4	50.01	-	-	74	-23.99	203	202	V
1.599	36.46	Av	28.4	-35.4	29.46	54	-24.54	-	-	203	202	V
1.993	54.95	Pk	31.2	-35	51.15	-	-	74	-22.85	58	270	V
1.993	36.5	Av	31.2	-35	32.7	54	-21.3	-	-	58	270	V
2.459	49.44	Pk	32.3	-34.7	47.04	-	-	74	-26.96	93	137	V
2.459	36.72	Av	32.3	-34.7	34.32	54	-19.68	-	-	93	137	V
5.991	47.23	Pk	35	-31.1	51.13	-	-	74	-22.87	355	391	V
5.991	31.17	Av	35	-31.1	35.07	54	-18.93	-	-	355	391	V
17.879	22.14	Av	41.2	-23.4	39.94	54	-14.06	-	-	343	263	H
17.881	33.69	Pk	41.2	-23.4	51.49	-	-	74	-22.51	343	263	H

Pk - Peak detector

Av - Average detection

FCC Part 15 Subpart B Class B 1-18GHz.TST

Rev 9.5 20 Aug 2015

## Appendix A

### Accreditations and Authorizations



NVLAP Lab code: 200246-0

NVLAP: The National Institute of Standards and Technology (NIST) administers the National Voluntary Laboratory Accreditation Program (NVLAP). NVLAP is comprised of laboratory accreditation programs (LAPs) which are established on the basis of requests and demonstrated need. Each LAP includes specific calibration and/or test standards and related methods and protocols assembled to satisfy the unique needs for accreditation in a field of testing or calibration. NVLAP accredits public and private laboratories based on evaluation of their technical qualifications and competence to carry out specific calibrations or tests. Accreditation criteria are established in accordance with the U.S. Code of Federal Regulations (CFR, Title 15, Part 285), NVLAP Procedures and General Requirements, and encompass the requirements of ISO/IEC 17025. For a full scope listing see <http://www.nist.gov/nvlap/>