



FCC RF Test Report

APPLICANT : Sony Mobile Communications Inc.
EQUIPMENT : GSM/WCDMA/LTE Phone+Bluetooth, DTS/UNII
a/b/g/n and NFC
BRAND NAME : Sony
FCC ID : PY7-PM0922
STANDARD : FCC Part 15 Subpart E §15.407
CLASSIFICATION : (NII) Unlicensed National Information Infrastructure

The product was received on Oct. 07, 2015 and testing was completed on Dec. 29, 2015. We, SPORTON INTERNATIONAL INC., would like to declare that the tested sample has been evaluated in accordance with the test procedures and has been in compliance with the applicable technical standards.

The test results in this report apply exclusively to the tested model / sample. Without written approval of SPORTON INTERNATIONAL INC., the test report shall not be reproduced except in full.

Reviewed by: Joseph Lin / Supervisor

Approved by: Jones Tsai / Manager



SPORTON INTERNATIONAL INC.

No. 52, Hwa Ya 1st Rd., Hwa Ya Technology Park, Kwei-Shan District, Tao Yuan City, Taiwan, R.O.C.

SPORTON INTERNATIONAL INC.

TEL : 886-3-327-3456

FAX : 886-3-328-4978

FCC ID : PY7-PM0922

Page Number : 1 of 31

Report Issued Date : Jan. 19, 2016

Report Version : Rev. 01

Report Template No.: BU5-FR15EWL Version 1.0



TABLE OF CONTENTS

REVISION HISTORY..... 3

SUMMARY OF TEST RESULT 4

1 GENERAL DESCRIPTION 5

 1.1 Applicant 5

 1.2 Manufacturer 5

 1.3 Feature of Equipment Under Test 5

 1.4 Modification of EUT 6

 1.5 Testing Location 7

 1.6 Applicable Standards 7

2 TEST CONFIGURATION OF EQUIPMENT UNDER TEST 8

 2.1 Carrier Frequency Channel 8

 2.2 Pre-Scanned RF Power 9

 2.3 Test Mode 9

 2.4 Connection Diagram of Test System 11

 2.5 Support Unit used in test configuration and system 12

 2.6 EUT Operation Test Setup 12

 2.7 Measurement Results Explanation Example 12

3 TEST RESULT 13

 3.1 26dB & 99% Occupied Bandwidth Measurement 13

 3.2 Maximum Conducted Output Power Measurement 15

 3.3 Power Spectral Density Measurement 16

 3.4 Unwanted Radiated Emission Measurement 18

 3.5 AC Conducted Emission Measurement 22

 3.6 Frequency Stability Measurement 26

 3.7 Automatically Discontinue Transmission 27

 3.8 Antenna Requirements 28

4 LIST OF MEASURING EQUIPMENTS 29

5 UNCERTAINTY OF EVALUATION 31

APPENDIX A. CONDUCTED TEST RESULTS

APPENDIX B. RADIATED SPURIOUS EMISSION

APPENDIX C. RADIATED SPURIOUS EMISSION PLOTS



REVISION HISTORY

REPORT NO.	VERSION	DESCRIPTION	ISSUED DATE
FR582709-01E	Rev. 01	Initial issue of report	Jan. 19, 2016



SUMMARY OF TEST RESULT

Report Section	FCC Rule	Description	Limit	Result	Remark
3.1	2.1049 15.403(i)	26dB & 99% Bandwidth	-	Pass	-
3.2	15.407(a)	Maximum Conducted Output Power	≤ 24 dBm (depend on band)	Pass	-
3.3	15.407(a)	Power Spectral Density	≤ 11 dBm (depend on band)	Pass	-
3.4	15.407(b)	Unwanted Emissions	≤ -17, -27 dBm (depend on band)&15.209(a)	Pass	Under limit 3.23 dB at 5470.000 MHz
3.5	15.207	AC Conducted Emission	15.207(a)	Pass	Under limit 22.40 dB at 0.182 MHz
3.6	15.407(g)	Frequency Stability	Within Operation Band	Pass	-
3.7	15.407(c)	Automatically Discontinue Transmission	Discontinue Transmission	Pass	-
3.8	15.203 & 15.407(a)	Antenna Requirement	N/A	Pass	-

Remark: The FCC ID: PY7-PM0920 and IC: 4170B-PM0922 is similar device, in this report all the test result are referred to PY7-PM0920, Sporton Report No: FR5O0716E.



1 General Description

1.1 Applicant

Sony Mobile Communications Inc.
Nya Vattentorget, 22188 Lund, Sweden

1.2 Manufacturer

Sony Mobile Communications Inc.
1-8-15 Konan, Minato-ku, Tokyo, 108-0075, Japan

1.3 Feature of Equipment Under Test

GSM/WCDMA/LTE, Bluetooth, DTS/UNII a/b/g/n, NFC, and GPS

Product Specification subjective to this standard	
Antenna Type	PIFA Antenna
Antenna Gain	<5150 MHz ~ 5250 MHz> -1.10 dBi <5250 MHz ~ 5350 MHz> -1.10 dBi <5470 MHz ~ 5725 MHz> -1.10 dBi
HW Version	A
SW Version	33.2.A.0.19

<FR5O0716E>

EUT Information List				
IMEI	HW Version	SW Version	S/N	Performed Test Item
004402455537120	A	33.2.A.0.19	RQ3000D4EL	RF conducted measurement
004402455535371			RQ3000D4PK	radiated spurious emission
004402455535215			RQ3000D4J1	conducted emission



Accessory List	
AC Adapter 1	Model No. : UCH20
	Type No. : AC-0060-US
	S/N : 1215W43609270 (for radiated spurious emission) 1215W48600011 (for conducted emission)
Battery 1	Model No. : LIS1618ERPC
Earphone	Model No. : MH410c
	Type No. : AG-1100
	S/N : 1541A8180036E76 (for radiated spurious emission) 1541A8170036EC2 (for conducted emission)
USB Cable 1	Model No. : EC803
	Type No. : AI-0404
	S/N : 153812AF5009094 (for radiated spurious emission) 153812AA503376C (for conducted emission)

Note:

1. Above EUT list and accessory list used are electrically identical per declared by manufacturer.
2. Above the accessories list are used to exercise the EUT during test.
3. For other wireless features of this EUT, test report will be issued separately.

1.4 Modification of EUT

No modifications are made to the EUT during all test items.



1.5 Testing Location

Sporton Lab is accredited to ISO 17025 by Taiwan Accreditation Foundation (TAF code : 1190) and the FCC designation No. TW1022 under the FCC 2.948(e) by Mutual Recognition Agreement (MRA) in FCC Test.

Test Site	SPORTON INTERNATIONAL INC.	
Test Site Location	No. 52, Hwa Ya 1 st Rd., Hwa Ya Technology Park, Kwei-Shan District, Tao Yuan City, Taiwan, R.O.C. TEL: +886-3-327-3456 FAX: +886-3-328-4978	
Test Site No.	Sporton Site No.	
	TH05-HY	CO05-HY

Note: The test site complies with ANSI C63.4 2014 requirement.

Test Site	SPORTON INTERNATIONAL INC.	
Test Site Location	No.58, Aly. 75, Ln. 564, Wenhua 3rd Rd. Guishan Dist, Taoyuan City, Taiwan (R.O.C.) TEL: +886-3-327-0868 FAX: +886-3-327-0855	
Test Site No.	Sporton Site No.	
	03CH11-HY	

Note: The test site complies with ANSI C63.4 2014 requirement.

1.6 Applicable Standards

According to the specifications of the manufacturer, the EUT must comply with the requirements of the following standards:

- ♦ FCC Part 15 Subpart E
- ♦ FCC KDB 789033 D02 General UNII Test Procedures New Rules v01
- ♦ ANSI C63.10-2013

Remark:

1. All test items were verified and recorded according to the standards and without any deviation during the test.
2. This EUT has also been tested and complied with the requirements of FCC Part 15, Subpart B, recorded in a separate test report.



2 Test Configuration of Equipment Under Test

The EUT has been associated with peripherals and configuration operated in a manner tended to maximize its emission characteristics in a typical application. Frequency range investigated: conducted emission (150 kHz to 30 MHz) and radiated emission (9 kHz to the 10th harmonic of the highest fundamental frequency or to 40 GHz, whichever is lower). For radiated measurement, pre-scanned in three orthogonal panels, X, Y, Z. The worst cases (Z plane) were recorded in this report.

The final configuration from all the combinations and the worst-case data rates were investigated by measuring the maximum power across all the data rates and modulation modes under section 2.2.

Based on the worst configuration found above, the RF power setting is set individually to meet FCC compliance limit for the final conducted and radiated tests shown in section 2.3.

2.1 Carrier Frequency Channel

Frequency Band	Channel	Freq. (MHz)	Channel	Freq. (MHz)
5150-5250 MHz Band 1 (U-NII-1)	36	5180	44	5220
	38	5190	46	5230
	40	5200	48	5240

Frequency Band	Channel	Freq. (MHz)	Channel	Freq. (MHz)
5250-5350 MHz Band 2 (U-NII-2A)	52	5260	60	5300
	54	5270	62	5310
	56	5280	64	5320

Frequency Band	Channel	Freq. (MHz)	Channel	Freq. (MHz)
5470-5600 MHz and 5650-5725 MHz Band 3 (U-NII-2C)	100	5500	116	5580
	102	5510	132	5660
	104	5520	134	5670
	108	5540	136	5680
	110	5550	140	5700
	112	5560		

Note: The above Frequency and Channel in boldface were 802.11n HT40.



2.2 Pre-Scanned RF Power

Preliminary tests were performed in different data rate and data rate associated with the highest power were chosen for full test in the following tables.

5GHz 802.11a mode								
Data Rate (MHz)	6M bps	9M bps	12M bps	18M bps	24M bps	36M bps	48M bps	54M bps
Average Power (dBm)	14.95	14.93	14.94	14.94	14.91	14.89	14.90	14.93

5GHz 802.11n HT20 mode								
Data Rate (MHz)	MCS0	MCS1	MCS2	MCS3	MCS4	MCS5	MCS6	MCS7
Average Power (dBm)	14.98	14.97	14.95	14.97	14.95	14.96	14.97	14.96

5GHz 802.11n HT40 mode								
Data Rate (MHz)	MCS0	MCS1	MCS2	MCS3	MCS4	MCS5	MCS6	MCS7
Average Power (dBm)	12.48	12.46	12.42	12.33	12.33	12.38	12.40	12.46

2.3 Test Mode

Final test mode of conducted test items and radiated spurious emissions are considering the modulation and worse data rates from the power table described in section 2.2.

Modulation	Data Rate
802.11a	6 Mbps
802.11n HT20	MCS0
802.11n HT40	MCS0

AC Conducted Emission	Mode 1 : GSM1900 Idle + Bluetooth Link + WLAN (5GHz) Link + Earphone + USB Cable 1 (Charging from Adapter 1) + MP3 + Battery 1
------------------------------	--



Ch. #		Band I : 5150-5250 MHz	Band II : 5250-5350 MHz	Band III : 5470-5600 MHz and 5650-5725MHz
		802.11a	802.11a	802.11a
L	Low	36	52	100
M	Middle	44	60	116
H	High	48	64	140

Ch. #		Band I : 5150-5250 MHz	Band II : 5250-5350 MHz	Band III : 5470-5600 MHz and 5650-5725MHz
		802.11n HT20	802.11n HT20	802.11n HT20
L	Low	36	52	100
M	Middle	44	60	116
H	High	48	64	140

Ch. #		Band I : 5150-5250 MHz	Band II : 5250-5350 MHz	Band III : 5470-5600 MHz and 5650-5725MHz
		802.11n HT40	802.11n HT40	802.11n HT40
L	Low	38	54	102
M	Middle	-	-	110
H	High	46	62	134

2.4 Connection Diagram of Test System

<WLAN Tx Mode>

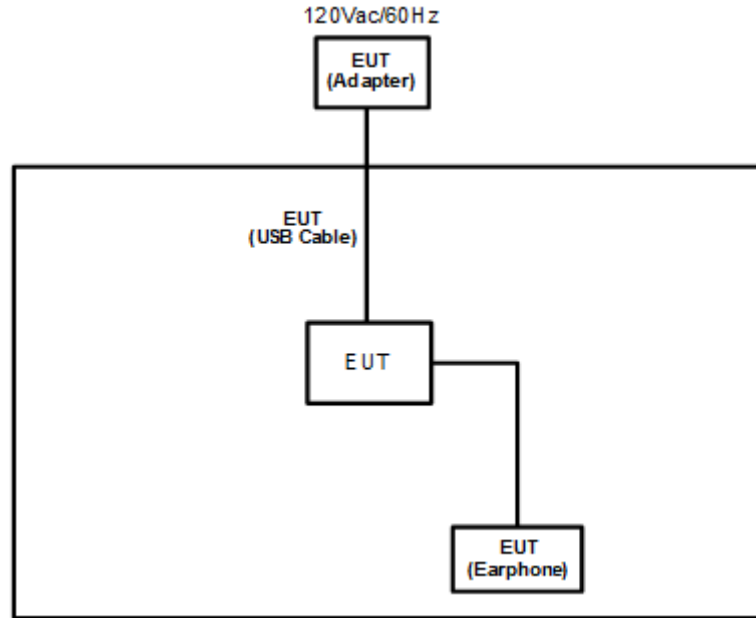

<AC Conducted Emission Mode>

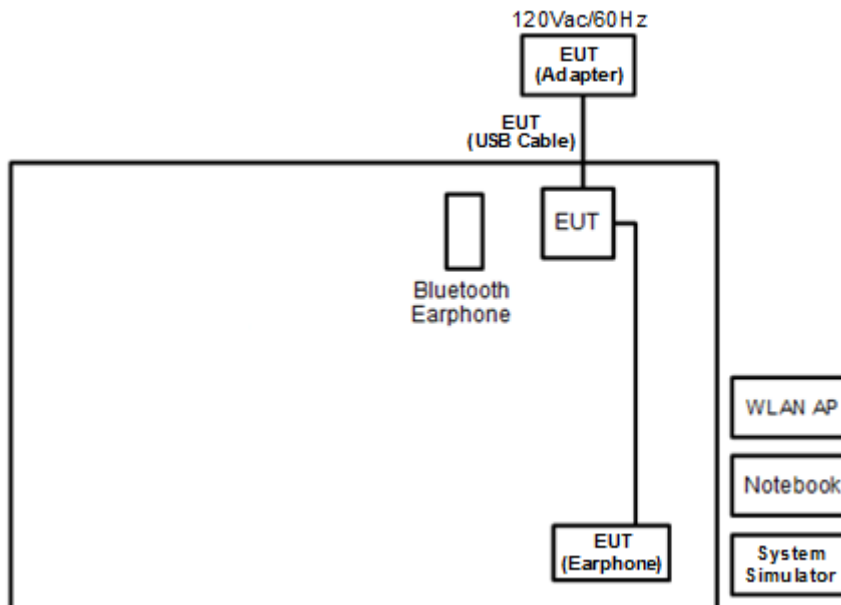



2.5 Support Unit used in test configuration and system

Item	Equipment	Trade Name	Model Name	FCC ID	Data Cable	Power Cord
1.	System Simulator	Anritsu	MT8820C	N/A	N/A	Unshielded, 1.8 m
2.	WLAN AP	D-Link	DIR-865L	KA2IR865LA1	N/A	Unshielded, 1.8 m
3.	Bluetooth Earphone	Sony	SBH20	PY7-RD0010	Unshielded, 0.75 m	N/A
4.	Notebook	DELL	Latitude E6320	FCC DoC/ Contains FCC ID: QDS-BRCM1054	N/A	AC I/P: Unshielded, 1.2 m DC O/P: Shielded, 1.8 m
5.	SD Card	SanDisk	MicroSD HC	FCC DoC	N/A	N/A

2.6 EUT Operation Test Setup

For WLAN RF test items, an engineering test program was provided and enabled to make EUT continuous transmit/receive.

2.7 Measurement Results Explanation Example

For all conducted test items:

The offset level is set in the spectrum analyzer to compensate the RF cable loss and attenuator factor between EUT conducted output port and spectrum analyzer. With the offset compensation, the spectrum analyzer reading level is exactly the EUT RF output level.

Example :

The spectrum analyzer offset is derived from RF cable loss and attenuator factor.

$$\text{Offset} = \text{RF cable loss} + \text{attenuator factor}.$$

Following shows an offset computation example with cable loss 4.2 dB and 10dB attenuator.

$$\begin{aligned} \text{Offset(dB)} &= \text{RF cable loss(dB)} + \text{attenuator factor(dB)}. \\ &= 4.2 + 10 = 14.2 \text{ (dB)} \end{aligned}$$

3 Test Result

3.1 26dB & 99% Occupied Bandwidth Measurement

3.1.1 Description of 26dB & 99% Occupied Bandwidth

This section is for reporting purpose only.

There is no restriction limits for bandwidth.

3.1.2 Measuring Instruments

The measuring equipment is listed in the section 4 of this test report.

3.1.3 Test Procedures

1. The testing follows FCC KDB 789033 D02 General UNII Test Procedures New Rules v01.
Section C) Emission bandwidth
2. Set RBW = approximately 1% of the emission bandwidth.
3. Set the VBW > RBW.
4. Detector = Peak.
5. Trace mode = max hold
6. Measure the maximum width of the emission that is 26 dB down from the peak of the emission.
Compare this with the RBW setting of the analyzer. Readjust RBW and repeat measurement as needed until the RBW/EBW ratio is approximately 1%.
7. For 99% Bandwidth Measurement, the spectrum analyzer's resolution bandwidth (RBW) is set 1MHz and set the Video bandwidth (VBW) $\geq 3 * RBW$.
8. Measure and record the results in the test report.

3.1.4 Test Setup

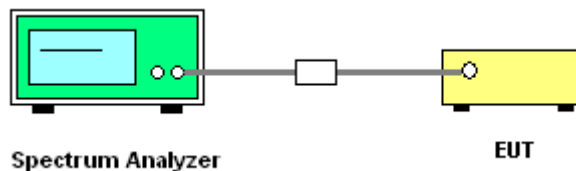



3.1.5 Test Result of 26dB & 99% Occupied Bandwidth Plots

Please refer to Appendix A.

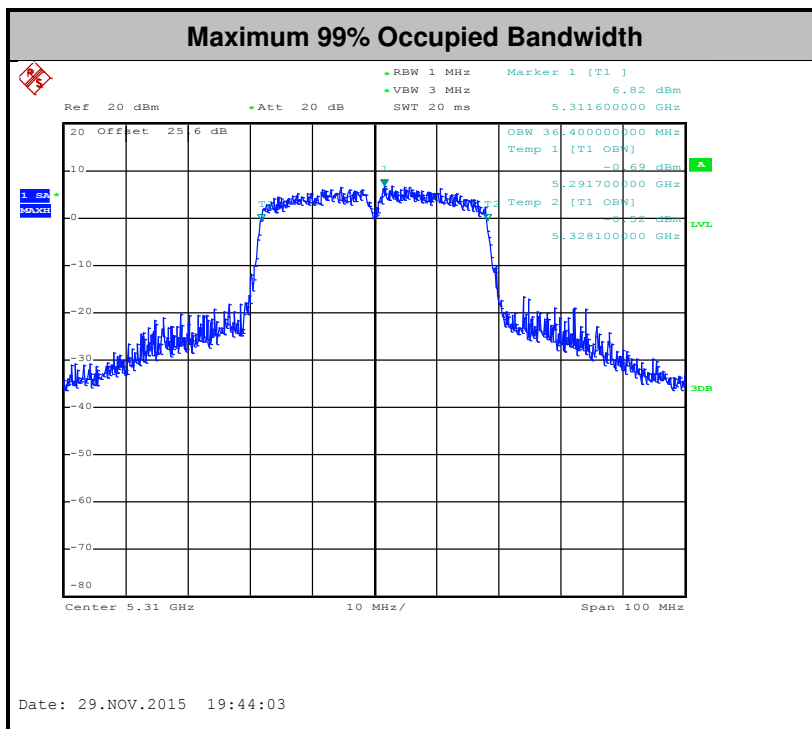
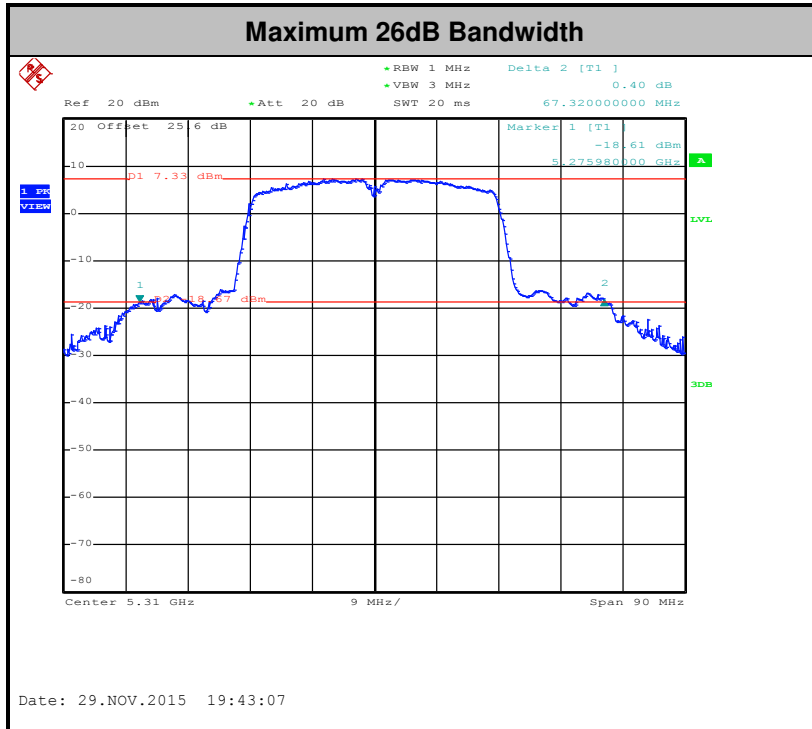

3.2 Maximum Conducted Output Power Measurement

3.2.1 Limit of Maximum Conducted Output Power

For mobile and portable client devices in the 5.15–5.25 GHz band, the maximum conducted output power over the frequency band of operation shall not exceed 250 mW.

For the 5.25–5.35 GHz and 5.47–5.725 GHz bands, the maximum conducted output power over the frequency bands of operation shall not exceed the lesser of 250 mW or $11 \text{ dBm} + 10 \log B$, where B is the 26 dB emission bandwidth in megahertz.

If transmitting antennas of directional gain greater than 6 dBi are used, the peak output power shall be reduced by the amount in dB that the directional gain of the antenna exceeds 6 dBi.

Note that U-NII-2 band, devices with a maximum e.i.r.p. greater than 500 mW shall implement TPC in order to have the capability to operate at least 6 dB below the maximum permitted e.i.r.p. of 1 W.

3.2.2 Measuring Instruments

The measuring equipment is listed in the section 4 of this test report.

3.2.3 Test Procedures

The testing follows Method PM of FCC KDB 789033 D02 General UNII Test Procedures New Rules v01.

Method PM (Measurement using an RF average power meter):

1. Measurement is performed using a wideband RF power meter.
2. The EUT is configured to transmit continuously with a consistent duty cycle at its maximum power control level.
3. Measure the average power of the transmitter, and the average power is corrected with duty factor, $10 \log(1/x)$, where x is the duty cycle.

3.2.4 Test Setup

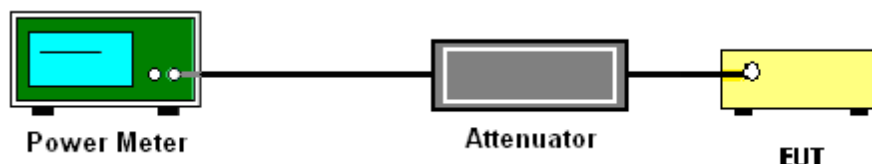

3.2.5 Test Result of Maximum Conducted Output Power

Please refer to Appendix A.



3.3 Power Spectral Density Measurement

3.3.1 Limit of Power Spectral Density

For mobile and portable client devices in the 5.15–5.25 GHz band, the maximum power spectral density shall not exceed 11dBm in any 1 megahertz band.

For the 5.25–5.35 GHz and 5.47–5.725 GHz bands, the maximum power spectral density shall not exceed 11 dBm in any 1 megahertz band.

If transmitting antennas of directional gain greater than 6 dBi are used, the peak output power shall be reduced by the amount in dB that the directional gain of the antenna exceeds 6 dBi.

3.3.2 Measuring Instruments

The measuring equipment is listed in the section 4 of this test report.

3.3.3 Test Procedures

The testing follows FCC KDB 789033 D02 General UNII Test Procedures New Rules v01.

Section F) Maximum power spectral density.

Method SA-2

(trace averaging across on and off times of the EUT transmissions, followed by duty cycle correction).

1. The testing follows Method SA-2 of FCC KDB 789033 D02 General UNII Test Procedures New Rules v01.
 - Measure the duty cycle.
 - Set span to encompass the entire emission bandwidth (EBW) of the signal.
 - Set RBW = 1 MHz.
 - Set VBW \geq 3 MHz.
 - Number of points in sweep \geq 2 Span / RBW.
 - Sweep time = auto.
 - Detector = RMS
 - Trace average at least 100 traces in power averaging mode.
 - Add $10 \log(1/x)$, where x is the duty cycle, to the measured power in order to compute the average power during the actual transmission times. For example, add $10 \log(1/0.25) = 6$ dB if the duty cycle is 25 percent.
2. The RF output of EUT was connected to the spectrum analyzer by a low loss cable.
3. Each plot has already offset with cable loss, and attenuator loss. Measure the PPSD and record it.

3.3.4 Test Setup

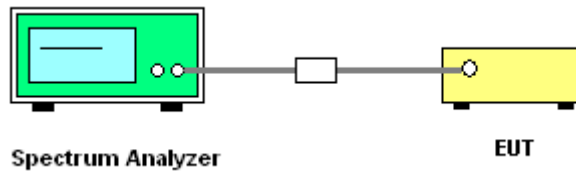

3.3.5 Test Result of Power Spectral Density

Please refer to Appendix A.

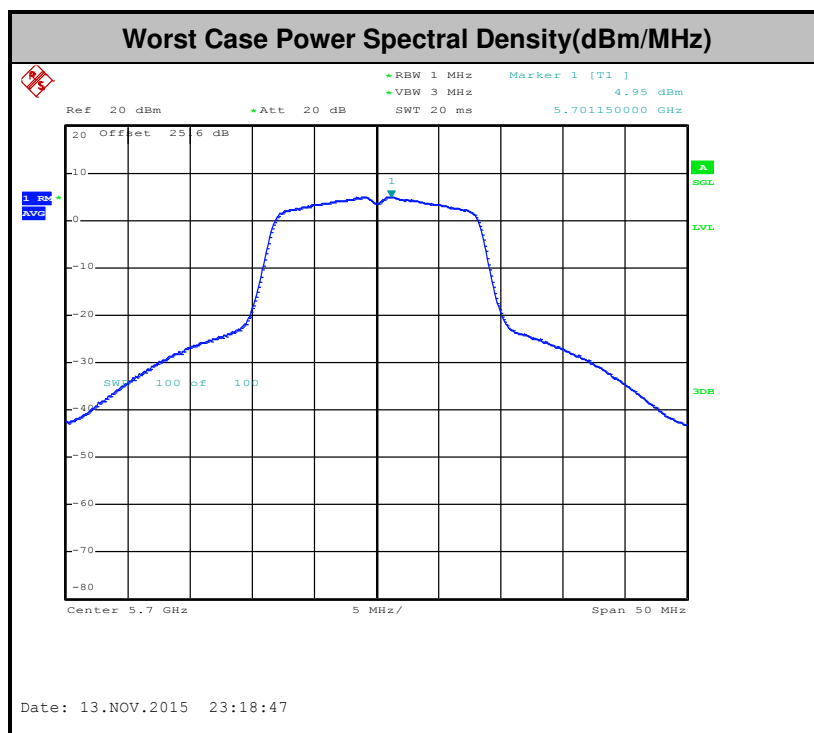

Note: Average Power Density (dB) = Measured value+ Duty Factor



3.4 Unwanted Radiated Emission Measurement

This section as specified in FCC Part 15.407(b) is to measure unwanted emissions through radiated measurement for band edge spurious emissions and out of band emissions measurement. The unwanted emissions shall comply with 15.407(b)(1) to (6), and restricted bands per FCC Part15.205.

3.4.1 Limit of Unwanted Emissions

(1) For transmitters operating in the 5150-5250 MHz band: all emissions outside of the 5150-5350 MHz band shall not exceed an EIRP of -27dBm/MHz.

For transmitters operating in the 5250-5350 MHz band: all emissions outside of the 5150-5350 MHz band shall not exceed an EIRP of -27 dBm/MHz. Devices operating in the 5250-5350 MHz band that generate emissions in the 5150-5250 MHz band must meet all applicable technical requirements for operation in the 5150-5250 MHz band (including indoor use) or alternatively meet an out-of-band emission EIRP limit of -27 dBm/MHz in the 5150-5250 MHz band.

For transmitters operating in the 5470-5600 MHz and 5650-5725MHz band: all emissions outside of the 5470-5600 MHz and 5650-5725MHz band shall not exceed an EIRP of -27 dBm/MHz.

(2) Unwanted spurious emissions fallen in restricted bands per FCC Part15.205 shall comply with the general field strength limits set forth in § 15.209 as below table,

Frequency (MHz)	Field Strength (microvolts/meter)	Measurement Distance (meters)
0.009 – 0.490	2400/F(kHz)	300
0.490 – 1.705	24000/F(kHz)	30
1.705 – 30.0	30	30
30 – 88	100	3
88 – 216	150	3
216 - 960	200	3
Above 960	500	3

Note: The following formula is used to convert the EIRP to field strength.

$$E = \frac{1000000\sqrt{30P}}{3} \mu\text{V/m, where P is the eirp (Watts)}$$

EIRP (dBm)	Field Strength at 3m (dBμV/m)
-17	78.3
- 27	68.3



- (3) KDB789033 v01 G)2)c) As specified in 15.407(b), emissions above 1000 MHz that are outside of the restricted bands are subject to a peak emission limit of -27 dBm/MHz (or -17 dBm/MHz as specified in 15.407(b)(4)). However, an out-of-band emission that complies with both the average and peak limits of 15.209 is not required to satisfy the -27 dBm/MHz or -17 dBm/MHz peak emission limit.

3.4.2 Measuring Instruments

The measuring equipment is listed in the section 4 of this test report.

3.4.3 Test Procedures

- 1. The testing follows FCC KDB 789033 D02 General UNII Test Procedures New Rules v01. Section G) Unwanted emissions measurement.

(1) Procedure for Unwanted Emissions Measurements Below 1000MHz

- RBW = 120 kHz
- VBW = 300 kHz
- Detector = Peak
- Trace mode = max hold

(2) Procedure for Peak Unwanted Emissions Measurements Above 1000 MHz

- RBW = 1 MHz
- VBW ≥ 3 MHz
- Detector = Peak
- Sweep time = auto
- Trace mode = max hold

(3) Procedures for Average Unwanted Emissions Measurements Above 1000MHz

- RBW = 1 MHz
- VBW = 10 Hz, when duty cycle is no less than 98 percent.
- $VBW \geq 1/T$, when duty cycle is less than 98 percent where T is the minimum transmission duration over which the transmitter is on and is transmitting at its maximum power control level for the tested mode of operation.

Band	Duty Cycle(%)	T(μs)	1/T(kHz)	VBW Setting
802.11a	97.20	1390.00	0.72	1kHz
802.11n HT20	97.02	1300.00	0.77	1kHz
802.11n HT40	94.20	650.00	1.54	3kHz

2. The EUT was placed on a turntable with 0.8 meter for frequency below 1GHz and 1.5 meter for frequency above 1GHz respectively above ground.
3. The EUT was set 3 meters from the interference receiving antenna which was mounted on the top of a variable height antenna tower.
4. The antenna is a broadband antenna and its height is adjusted between one meter and four meters above ground to find the maximum value of the field strength for both horizontal polarization and vertical polarization of the antenna.
5. For each suspected emission, the EUT was arranged to its worst case and then adjust the antenna tower (from 1 m to 4 m) and turntable (from 0 degree to 360 degrees) to find the maximum reading.
6. For testing below 1GHz, if the emission level of the EUT in peak mode was 3 dB lower than the limit specified, then peak values of EUT will be reported, otherwise, the emissions will be repeated one by one using the CISPR quasi-peak method and reported.
7. For testing above 1GHz, the emission level of the EUT in peak mode was 20dB lower than average limit (that means the emission level in average mode also complies with the limit in average mode), then peak values of EUT will be reported, otherwise, the emissions will be measured in average mode again and reported.

3.4.4 Test Setup

For radiated emissions below 30MHz

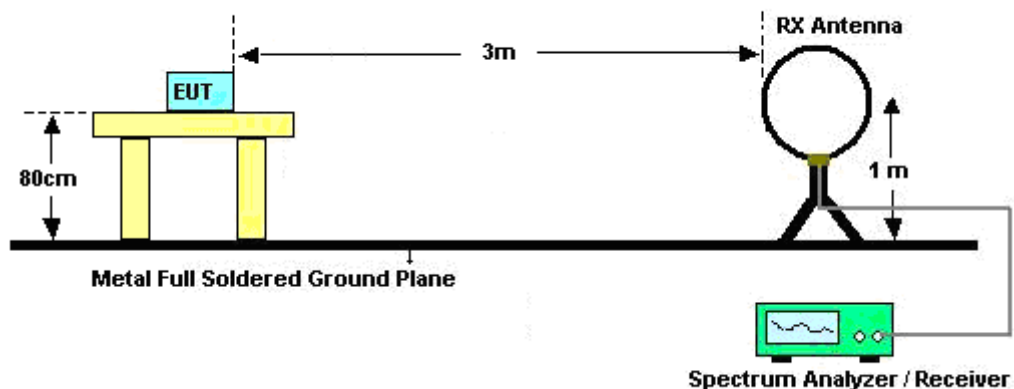

For radiated emissions from 30MHz to 1GHz

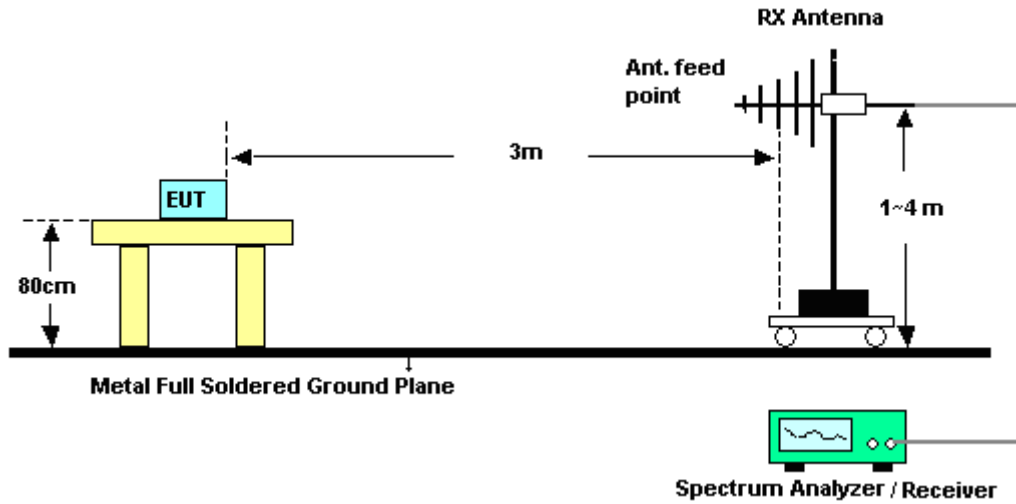

For radiated emissions above 1GHz

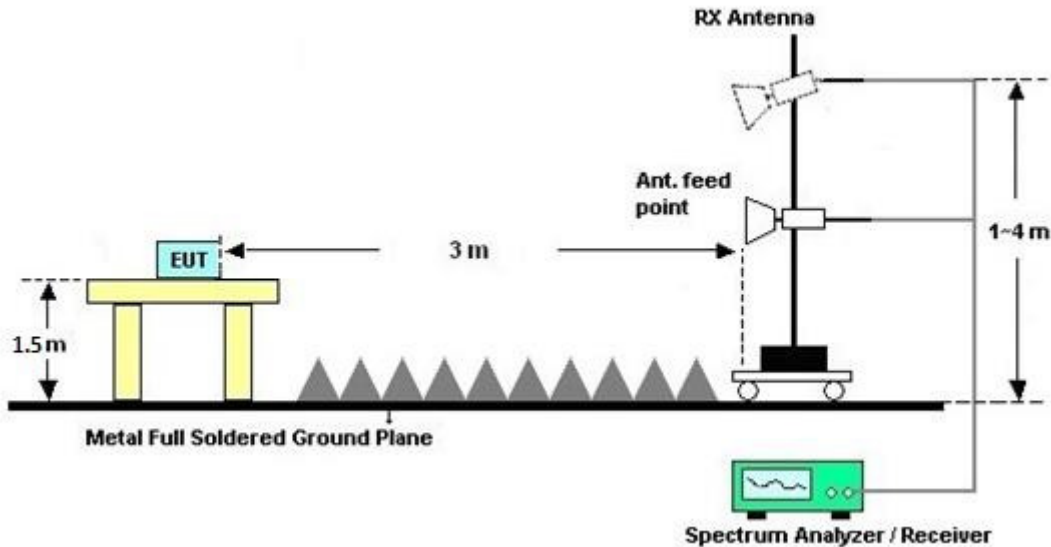

3.4.5 Test Results of Radiated Emissions (9 kHz ~ 30 MHz)

The low frequency, which started from 9 kHz to 30MHz, was pre-scanned and the result which was 20dB lower than the limit line per 15.31(o) was not reported.

3.4.6 Test Result of Radiated Band Edges

Please refer to Appendix B.

3.4.7 Test Result of Unwanted Radiated Emission (30MHz ~ 10th Harmonic)

Please refer to Appendix B.



3.5 AC Conducted Emission Measurement

3.5.1 Limit of AC Conducted Emission

For equipment that is designed to be connected to the public utility (AC) power line, the radio frequency voltage that is conducted back onto the AC power line on any frequency or frequencies within the band 150 kHz to 30 MHz shall not exceed the limits in the following table.

Frequency of emission (MHz)	Conducted limit (dB μ V)	
	Quasi-peak	Average
0.15-0.5	66 to 56*	56 to 46*
0.5-5	56	46
5-30	60	50

*Decreases with the logarithm of the frequency.

3.5.2 Measuring Instruments

The measuring equipment is listed in the section 4 of this test report.

3.5.3 Test Procedures

1. The EUT was placed 0.4 meter from the conducting wall of the shielding room was kept at least 80 centimeters from any other grounded conducting surface.
2. Connect EUT to the power mains through a line impedance stabilization network (LISN).
3. All the support units are connecting to the other LISN.
4. The LISN provides 50 ohm coupling impedance for the measuring instrument.
5. The FCC states that a 50 ohm, 50 microhenry LISN should be used.
6. Both sides of AC line were checked for maximum conducted interference.
7. The frequency range from 150 kHz to 30 MHz was searched.
8. Set the test-receiver system to Peak Detect Function and specified bandwidth with Maximum Hold Mode.

3.5.4 Test Setup

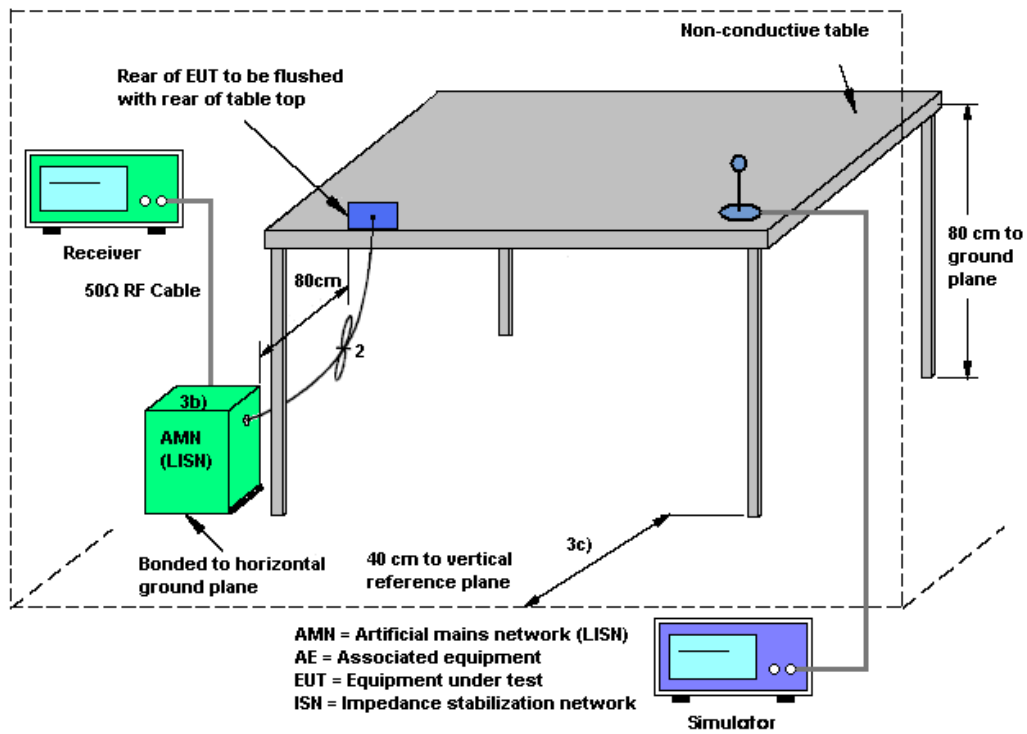



3.5.5 Test Result of AC Conducted Emission

Test Mode :	Mode 1	Temperature :	22~23°C
Test Engineer :	Derreck Chen	Relative Humidity :	52~55%
Test Voltage :	120Vac / 60Hz	Phase :	Line
Function Type :	GSM1900 Idle + Bluetooth Link + WLAN (5GHz) Link + Earphone + USB Cable 1 (Charging from Adapter 1) + MP3 + Battery 1		

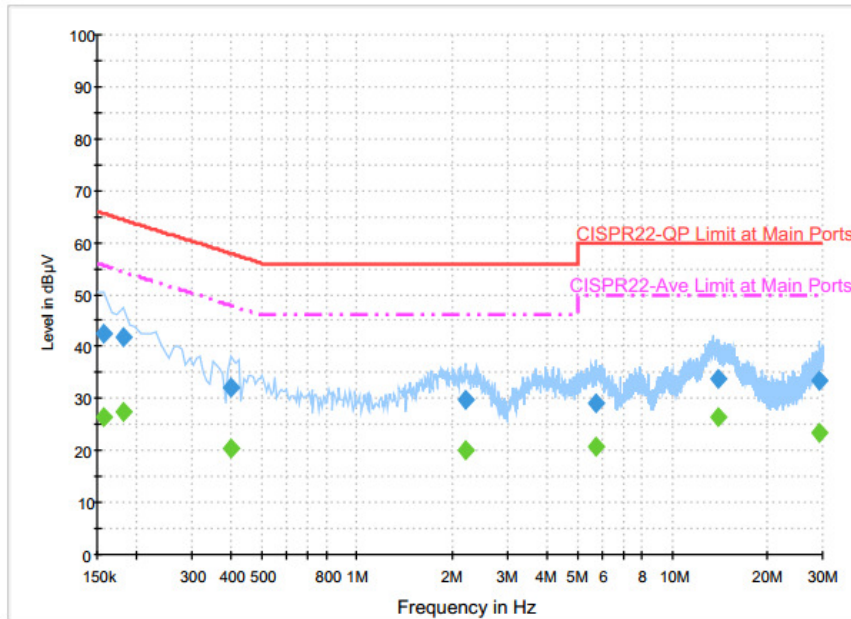

Final Result : QuasiPeak

Frequency (MHz)	QuasiPeak (dBµV)	Filter	Line	Corr. (dB)	Margin (dB)	Limit (dBµV)
0.158000	42.6	Off	L1	19.6	23.0	65.6
0.182000	42.0	Off	L1	19.7	22.4	64.4
0.398000	32.0	Off	L1	19.7	25.9	57.9
2.206000	29.7	Off	L1	19.6	26.3	56.0
5.742000	29.0	Off	L1	19.7	31.0	60.0
14.038000	33.9	Off	L1	19.8	26.1	60.0
29.430000	33.4	Off	L1	19.9	26.6	60.0

Final Result : Average

Frequency (MHz)	Average (dBµV)	Filter	Line	Corr. (dB)	Margin (dB)	Limit (dBµV)
0.158000	26.3	Off	L1	19.6	29.3	55.6
0.182000	27.5	Off	L1	19.7	26.9	54.4
0.398000	20.5	Off	L1	19.7	27.4	47.9
2.206000	20.2	Off	L1	19.6	25.8	46.0
5.742000	20.6	Off	L1	19.7	29.4	50.0
14.038000	26.4	Off	L1	19.8	23.6	50.0
29.430000	23.3	Off	L1	19.9	26.7	50.0



Test Mode :	Mode 1	Temperature :	22~23°C
Test Engineer :	Derreck Chen	Relative Humidity :	52~55%
Test Voltage :	120Vac / 60Hz	Phase :	Neutral
Function Type :	GSM1900 Idle + Bluetooth Link + WLAN (5GHz) Link + Earphone + USB Cable 1 (Charging from Adapter 1) + MP3 + Battery 1		

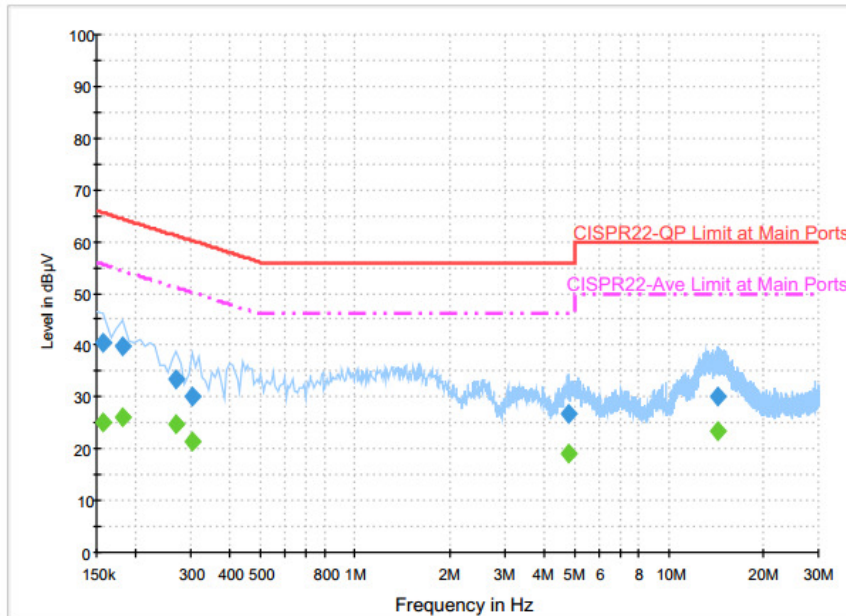

Final Result : QuasiPeak

Frequency (MHz)	QuasiPeak (dBµV)	Filter	Line	Corr. (dB)	Margin (dB)	Limit (dBµV)
0.158000	40.3	Off	N	19.6	25.3	65.6
0.182000	39.8	Off	N	19.7	24.6	64.4
0.270000	33.5	Off	N	19.7	27.6	61.1
0.302000	30.1	Off	N	19.7	30.1	60.2
4.814000	26.8	Off	N	19.7	29.2	56.0
14.406000	30.2	Off	N	19.8	29.8	60.0

Final Result : Average

Frequency (MHz)	Average (dBµV)	Filter	Line	Corr. (dB)	Margin (dB)	Limit (dBµV)
0.158000	25.2	Off	N	19.6	30.4	55.6
0.182000	25.9	Off	N	19.7	28.5	54.4
0.270000	24.8	Off	N	19.7	26.3	51.1
0.302000	21.5	Off	N	19.7	28.7	50.2
4.814000	19.0	Off	N	19.7	27.0	46.0
14.406000	23.5	Off	N	19.8	26.5	50.0

3.6 Frequency Stability Measurement

3.6.1 Limit of Frequency Stability

Manufacturers of U-NII devices are responsible for ensuring frequency stability such that an emission is maintained within the band of operation under all conditions of normal operation as specified in the user's manual.

3.6.2 Measuring Instruments

The measuring equipment is listed in the section 4 of this test report.

3.6.3 Test Procedures

1. To ensure emission at the band edge is maintained within the authorized band, those values shall be measured by radiation emissions at upper and lower frequency points, and finally compensated by frequency deviation as procedures below.
2. The EUT was operated at the maximum output power, and connected to the spectrum analyzer, which is set to maximum hold function and peak detector. The peak value of the power envelope was measured and noted. The upper and lower frequency points were respectively measured relatively 10dB lower than the measured peak value.
3. The frequency deviation was calculated by adding the upper frequency point and the lower frequency point divided by two. Those detailed values of frequency deviation are provided in table below.

3.6.4 Test Setup



3.6.5 Test Result of Frequency Stability

Please refer to Appendix A.



3.7 Automatically Discontinue Transmission

3.7.1 Limit of Automatically Discontinue Transmission

The device shall automatically discontinue transmission in case of either absence of information to transmit or operational failure. These provisions are not intended to preclude the transmission of control or signaling information or the use of repetitive codes used by certain digital technologies to complete frame or burst intervals. Applicants shall include in their application for equipment authorization to describe how this requirement is met.

3.7.2 Measuring Instruments

The measuring equipment is listed in the section 4 of this test report.

3.7.3 Test Result of Automatically Discontinue Transmission

While the EUT is not transmitting any information, the EUT can automatically discontinue transmission and become standby mode for power saving. The EUT can detect the controlling signal of ACK message transmitting from remote device and verify whether it shall resend or discontinue transmission.



3.8 Antenna Requirements

3.8.1 Standard Applicable

According to FCC 47 CFR Section 15.407(a)(1)(2) ,if transmitting antenna directional gain is greater than 6 dBi, both the peak transmit power and the peak power spectral density shall be reduced by the amount in dB that the directional gain of the antenna exceeds 6 dBi.

3.8.2 Antenna Anti-Replacement Construction

An embedded-in antenna design is used.

3.8.3 Antenna Gain

The antenna gain is less than 6 dBi. Therefore, it is not necessary to reduce maximum peak output power limit.



4 List of Measuring Equipments

Instrument	Manufacturer	Model No.	Serial No.	Characteristics	Calibration Date	Test Date	Due Date	Remark
Power Meter	Anritsu	ML2495A	1218006	300MHz~40GHz	Oct. 07, 2015	Nov. 06, 2015~ Nov. 29, 2015	Oct. 06, 2016	Conducted (TH05-HY)
Power Sensor	Anritsu	MA2411B	1207363	300MHz~40GHz	Oct. 07, 2015	Nov. 06, 2015~ Nov. 29, 2015	Oct. 06, 2016	Conducted (TH05-HY)
Spectrum Analyzer	Rohde & Schwarz	FSP40	100055	9kHz-40GHz	Jun. 18, 2015	Nov. 06, 2015~ Nov. 29, 2015	Jun. 17, 2016	Conducted (TH05-HY)
Hygrometer	Testo	608-H1	34897199	N/A	May. 04, 2015	Nov. 06, 2015~ Nov. 29, 2015	May. 03, 2016	Conducted (TH05-HY)
Temperature Chamber	ESPEC	SH-641	92013720	-40 °C~90 °C	Sep. 08, 2015	Nov. 06, 2015~ Nov. 29, 2015	Sep. 07, 2016	Conducted (TH05-HY)
RF Cable	HARBOUR INDUSTRIES	LL142	Infinet CA3601-3601- DLL	0.1MHz~40GHz	Mar. 06, 2015	Nov. 06, 2015~ Nov. 29, 2015	Mar. 05, 2016	Conducted (TH05-HY)
Loop Antenna	Rohde & Schwarz	HFH2-Z2	100315	9 kHz~30 MHz	Sep. 02, 2015	Oct. 30, 2015~ Dec. 29, 2015	Sep. 01, 2016	Radiation (03CH11-HY)
Amplifier	SONOMA	310N	187312	9kHz~1GHz	Nov. 24, 2014	Oct. 30, 2015~ Nov. 17, 2015	Nov. 23, 2015	Radiation (03CH11-HY)
Amplifier	SONOMA	310N	187312	9kHz~1GHz	Nov. 20, 2015	Nov. 21, 2015~ Dec. 29, 2015	Nov. 19, 2016	Radiation (03CH11-HY)
Horn Antenna	SCHWARZBECK	BBHA 9120 D	9120D-1326	1GHz ~ 18GHz	Oct. 08, 2015	Oct. 30, 2015~ Dec. 29, 2015	Oct. 07, 2016	Radiation (03CH11-HY)
Hygrometer	TECPEL	DTN-303B	TP140325	N/A	Nov. 19, 2014	Oct. 30, 2015~ Nov. 17, 2015	Nov. 18, 2015	Radiation (03CH11-HY)
Hygrometer	TECPEL	DTN-303B	TP140325	N/A	Nov. 17, 2015	Nov. 21, 2015~ Dec. 29, 2015	Nov. 16, 2016	Radiation (03CH11-HY)
Preamplifier	Keysight	83017A	MY53270080	1GHz~26.5GHz	Nov. 20, 2014	Oct. 30, 2015~ Nov. 17, 2015	Nov. 19, 2015	Radiation (03CH11-HY)
Preamplifier	Keysight	83017A	MY53270080	1GHz~26.5GHz	Nov. 19, 2015	Nov. 21, 2015~ Dec. 29, 2015	Nov. 18, 2016	Radiation (03CH11-HY)
Preamplifier	MITEQ	AMF-7D-0010 1800-30-10P	1902247	1GHz~18GHz	Jul. 01, 2015	Oct. 30, 2015~ Dec. 29, 2015	Jun. 30, 2016	Radiation (03CH11-HY)
Spectrum Analyzer	Keysight	N9010A	MY54200486	10Hz ~ 44GHZ	Sep. 24, 2015	Oct. 30, 2015~ Dec. 29, 2015	Sep. 23, 2016	Radiation (03CH11-HY)
EMI Test Receiver	Agilent	N9038A(MXE)	MY53290053	20Hz to 26.5GHz	Feb. 02, 2015	Oct. 30, 2015~ Dec. 29, 2015	Feb. 01, 2016	Radiation (03CH11-HY)
Controller	EMEC	EM 1000	N/A	Control Turn table & Ant Mast	N/A	Oct. 30, 2015~ Dec. 29, 2015	N/A	Radiation (03CH11-HY)
Antenna Mast	EMEC	AM-BS-4500-B	N/A	1~4m	N/A	Oct. 30, 2015~ Dec. 29, 2015	N/A	Radiation (03CH11-HY)
Turn Table	EMEC	TT 2000	N/A	0-360 degree	N/A	Oct. 30, 2015~ Dec. 29, 2015	N/A	Radiation (03CH11-HY)
Bilog Antenna	TESEQ	CBL 6111D	35414	30MHz to 1GHz	Nov. 17, 2015	Nov. 21, 2015~ Dec. 29, 2015	Nov. 16, 2016	Radiation (03CH11-HY)
SHF-EHF Horn Antenna	SCHWARZBECK	BBHA 9170	BBHA9170576	18GHz ~ 40GHz	Apr. 20, 2015	Oct. 30, 2015~ Dec. 29, 2015	Apr. 19, 2016	Radiation (03CH11-HY)
Preamplifier	MITEQ	JS44-1800400 0-33-8P	1840917	18GHz ~ 40GHz	Jun. 02, 2015	Oct. 30, 2015~ Dec. 29, 2015	Jun. 01, 2016	Radiation (03CH11-HY)



Instrument	Manufacturer	Model No.	Serial No.	Characteristics	Calibration Date	Test Date	Due Date	Remark
Test Software	Audix	E3	6.2009-8-24	N/A	N/A	Oct. 30, 2015~ Dec. 29, 2015	N/A	Radiation (03CH11-HY)
Filter	Wainwright	WLKS4500-8S S	SN19	4.5G Low Pass	Oct. 01, 2015	Oct. 30, 2015~ Dec. 29, 2015	Sep. 30, 2016	Radiation (03CH11-HY)
Filter	Microwave Circuits	H07G18G3	SN8009-01	7GHz HPF	Oct. 01, 2015	Oct. 30, 2015~ Dec. 29, 2015	Sep. 30, 2016	Radiation (03CH11-HY)
AC Power Source	ChainTek	APC-1000W	N/A	N/A	N/A	Dec. 21, 2015	N/A	Conduction (CO05-HY)
EMI Test Receiver	Rohde & Schwarz	ESCI 7	100724	9kHz~7GHz	Aug. 26, 2015	Dec. 21, 2015	Aug. 25, 2016	Conduction (CO05-HY)
Hygrometer	Testo	608-H1	34913912	N/A	Apr. 20, 2015	Dec. 21, 2015	Apr. 19, 2016	Conduction (CO05-HY)
LISN	Rohde & Schwarz	ENV216	100080	9kHz~30MHz	Dec. 02, 2015	Dec. 21, 2015	Dec. 01, 2016	Conduction (CO05-HY)
LF Cable	HUBER + SUHNER	RG-214/U	LF01	N/A	Jan. 07, 2015	Dec. 21, 2015	Jan. 06, 2016	Conduction (CO05-HY)
Test Software	N/A	EMC32	8.40.0	N/A	N/A	Dec. 21, 2015	N/A	Conduction (CO05-HY)



5 Uncertainty of Evaluation

Uncertainty of Conducted Emission Measurement (150kHz ~ 30MHz)

Measuring Uncertainty for a Level of Confidence of 95% ($U = 2Uc(y)$)	2.26
---	------

Uncertainty of Radiated Emission Measurement (30 MHz ~ 1000 MHz)

Measuring Uncertainty for a Level of Confidence of 95% ($U = 2Uc(y)$)	4.9
---	-----



Appendix A. Conducted Test Results

Test Engineer:	Luffy Lin	Temperature:	21~25	°C
Test Date:	2015/11/06~2015/11/29	Relative Humidity:	51~54	%

TEST RESULTS DATA
26dB and 99% OBW

Band I										
Mod.	Data Rate	NTX	CH.	Freq. (MHz)	99% Bandwidth (MHz)	26 dB Bandwidth (MHz)	IC 99% Bandwidth Power Limit (dBm)	IC 99% Bandwidth EIRP Limit (dBm)		
11a	6Mbps	1	36	5180	18.20	38.10	-	22.60		
11a	6Mbps	1	44	5220	18.45	37.10	-	22.66		
11a	6Mbps	1	48	5240	17.75	37.50	-	22.49		
HT20	MCS0	1	36	5180	18.85	40.00	-	22.75		
HT20	MCS0	1	44	5220	18.60	38.60	-	22.70		
HT20	MCS0	1	48	5240	18.60	38.90	-	22.70		
HT40	MCS0	1	38	5190	36.40	62.82	-	23.01		
HT40	MCS0	1	46	5230	36.40	62.64	-	23.01		

TEST RESULTS DATA
Average Power Table

FCC Band I										
Mod.	Data Rate	NTX	CH.	Freq. (MHz)	Duty Factor (dB)	Average Conducted Power (dBm)	FCC Conducted Power Limit (dBm)	DG (dBi)		Pass/Fail
11a	6Mbps	1	36	5180	0.12	14.90	24.00	-1.10		Pass
11a	6Mbps	1	44	5220	0.12	14.82	24.00	-1.10		Pass
11a	6Mbps	1	48	5240	0.12	14.77	24.00	-1.10		Pass
HT20	MCS0	1	36	5180	0.13	14.98	24.00	-1.10		Pass
HT20	MCS0	1	44	5220	0.13	14.65	24.00	-1.10		Pass
HT20	MCS0	1	48	5240	0.13	14.71	24.00	-1.10		Pass
HT40	MCS0	1	38	5190	0.26	12.24	24.00	-1.10		Pass
HT40	MCS0	1	46	5230	0.26	12.09	24.00	-1.10		Pass

TEST RESULTS DATA
Power Spectral Density

FCC Band I										
Mod.	Data Rate	NTX	CH.	Freq. (MHz)	Duty Factor (dB)	Average Power Density (dBm/MHz)	Average PSD Limit (dBm/MHz)	DG (dBi)	-	Pass/Fail
11a	6Mbps	1	36	5180	0.12	2.51	11.00	-1.10		Pass
11a	6Mbps	1	44	5220	0.12	4.50	11.00	-1.10		Pass
11a	6Mbps	1	48	5240	0.12	4.42	11.00	-1.10		Pass
HT20	MCS0	1	36	5180	0.13	3.86	11.00	-1.10		Pass
HT20	MCS0	1	44	5220	0.13	4.36	11.00	-1.10		Pass
HT20	MCS0	1	48	5240	0.13	4.32	11.00	-1.10		Pass
HT40	MCS0	1	38	5190	0.26	-1.45	11.00	-1.10		Pass
HT40	MCS0	1	46	5230	0.26	-1.68	11.00	-1.10		Pass

TEST RESULTS DATA
26dB and 99% OBW

Band II										
Mod.	Data Rate	NTX	CH.	Freq. (MHz)	99% Bandwidth (MHz)	26 dB Bandwidth (MHz)	IC 99% Bandwidth Power Limit (dBm)	IC 99% Bandwidth EIRP Limit (dBm)	FCC 26dB Bandwidth Power Limit (dBm)	Note
11a	6M bps	1	52	5260	17.7	38.4	23.48	29.48	23.98	
11a	6M bps	1	60	5300	17.65	37.3	23.47	29.47	23.98	
11a	6M bps	1	64	5320	17.75	35.6	23.49	29.49	23.98	
HT20	MCS 0	1	52	5260	18.6	40.2	23.70	29.70	23.98	
HT20	MCS 0	1	60	5300	18.65	41.2	23.71	29.71	23.98	
HT20	MCS 0	1	64	5320	18.7	38.8	23.72	29.72	23.98	
HT40	MCS 0	1	54	5270	36.4	66.96	23.98	30.00	23.98	
HT40	MCS 0	1	62	5310	36.4	67.32	23.98	30.00	23.98	

TEST RESULTS DATA
Average Power Table

FCC Band II										
Mod.	Data Rate	NTX	CH.	Freq. (MHz)	Duty Factor (dB)	Average Conducted Power (dBm)	FCC Conducted Power Limit (dBm)	DG (dBi)		Pass/Fail
11a	6M bps	1	52	5260	0.12	14.51	23.98	-1.10		Pass
11a	6M bps	1	60	5300	0.12	14.86	23.98	-1.10		Pass
11a	6M bps	1	64	5320	0.12	14.93	23.98	-1.10		Pass
HT20	MCS 0	1	52	5260	0.13	14.90	23.98	-1.10		Pass
HT20	MCS 0	1	60	5300	0.13	14.85	23.98	-1.10		Pass
HT20	MCS 0	1	64	5320	0.13	14.93	23.98	-1.10		Pass
HT40	MCS 0	1	54	5270	0.26	12.14	23.98	-1.10		Pass
HT40	MCS 0	1	62	5310	0.26	12.19	23.98	-1.10		Pass

TEST RESULTS DATA
Power Spectral Density

Band II										
Mod.	Data Rate	NTX	CH.	Freq. (MHz)	Duty Factor (dB)	Average Power Density (dBm/MHz)	Average PSD Limit (dBm/MHz)	DG (dBi)		Pass/Fail
11a	6M bps	1	52	5260	0.12	4.17	11.00	-1.10		Pass
11a	6M bps	1	60	5300	0.12	4.25	11.00	-1.10		Pass
11a	6M bps	1	64	5320	0.12	4.27	11.00	-1.10		Pass
HT20	MCS 0	1	52	5260	0.13	4.06	11.00	-1.10		Pass
HT20	MCS 0	1	60	5300	0.13	4.57	11.00	-1.10		Pass
HT20	MCS 0	1	64	5320	0.13	4.50	11.00	-1.10		Pass
HT40	MCS 0	1	54	5270	0.26	-1.63	11.00	-1.10		Pass
HT40	MCS 0	1	62	5310	0.26	-1.24	11.00	-1.10		Pass

TEST RESULTS DATA
26dB and 99% OBW

Band III										
Mod.	Data Rate	NTX	CH.	Freq. (MHz)	99% Bandwidth (MHz)	26 dB Bandwidth (MHz)	IC 99% Bandwidth Power Limit (dBm)	IC 99% Bandwidth EIRP Limit (dBm)	FCC 26dB Bandwidth Power Limit (dBm)	Note
11a	6M bps	1	100	5500	17.55	33	23.44	29.44	23.98	
11a	6M bps	1	116	5580	17.5	33.2	23.43	29.43	23.98	
11a	6M bps	1	140	5700	17.55	33	23.44	29.44	23.98	
HT20	MCS 0	1	100	5500	18.4	37.3	23.65	29.65	23.98	
HT20	MCS 0	1	116	5580	18.55	33.1	23.68	29.68	23.98	
HT20	MCS 0	1	140	5700	18.35	34.9	23.64	29.64	23.98	
HT40	MCS 0	1	102	5510	36.3	53.82	23.98	30.00	23.98	
HT40	MCS 0	1	110	5550	36.4	54.18	23.98	30.00	23.98	
HT40	MCS 0	1	134	5670	36.3	54.18	23.98	30.00	23.98	

TEST RESULTS DATA
Average Power Table

FCC Band III										
Mod.	Data Rate	NTX	CH.	Freq. (MHz)	Duty Factor (dB)	Average Conducted Power (dBm)	FCC Conducted Power Limit (dBm)	DG (dBi)		Pass/Fail
11a	6M bps	1	100	5500	0.12	14.95	23.98	-1.10		Pass
11a	6M bps	1	116	5580	0.12	14.66	23.98	-1.10		Pass
11a	6M bps	1	140	5700	0.12	14.85	23.98	-1.10		Pass
HT20	MCS 0	1	100	5500	0.13	14.68	23.98	-1.10		Pass
HT20	MCS 0	1	116	5580	0.13	14.75	23.98	-1.10		Pass
HT20	MCS 0	1	140	5700	0.13	14.88	23.98	-1.10		Pass
HT40	MCS 0	1	102	5510	0.26	12.30	23.98	-1.10		Pass
HT40	MCS 0	1	110	5550	0.26	12.36	23.98	-1.10		Pass
HT40	MCS 0	1	134	5670	0.26	12.48	23.98	-1.10		Pass

TEST RESULTS DATA
Power Spectral Density

Band III										
Mod.	Data Rate	NTX	CH.	Freq. (MHz)	Duty Factor (dB)	Average Power Density (dBm/MHz)	Average PSD Limit (dBm/MHz)	DG (dBi)		Pass/Fail
11a	6M bps	1	100	5500	0.12	4.30	11.00	-1.10		Pass
11a	6M bps	1	116	5580	0.12	4.89	11.00	-1.10		Pass
11a	6M bps	1	140	5700	0.12	5.07	11.00	-1.10		Pass
HT20	MCS 0	1	100	5500	0.13	4.26	11.00	-1.10		Pass
HT20	MCS 0	1	116	5580	0.13	4.84	11.00	-1.10		Pass
HT20	MCS 0	1	140	5700	0.13	4.93	11.00	-1.10		Pass
HT40	MCS 0	1	102	5510	0.26	-0.45	11.00	-1.10		Pass
HT40	MCS 0	1	110	5550	0.26	-0.52	11.00	-1.10		Pass
HT40	MCS 0	1	134	5670	0.26	-1.33	11.00	-1.10		Pass

TEST RESULTS DATA
Frequency Stability

Band I										
Mod.	Data Rate	NTX	CH.	Freq. (MHz)	Center Frequency (MHz)	Frequency Deviation (MHz)	Frequency Stability (ppm)	Temperature (°C)	Voltage (V)	Note
11a	6Mbps	1	36	5180	5180.000	0.000	0.00	20	3.4	
11a	6Mbps	1	36	5180	5179.950	-0.050	-9.65	20	4.35	
11a	6Mbps	1	36	5180	5180.000	0.000	0.00	20	3.8	
11a	6Mbps	1	36	5180	5180.000	0.000	0.00	-30	3.8	
11a	6Mbps	1	36	5180	5180.000	0.000	0.00	50	3.8	

Band II										
Mod.	Data Rate	NTX	CH.	Freq. (MHz)	Center Frequency (MHz)	Frequency Deviation (MHz)	Frequency Stability (ppm)	Temperature (°C)	Voltage (V)	Note
11a	6Mbps	1	64	5320	5320.050	0.050	9.40	20	3.4	
11a	6Mbps	1	64	5320	5320.000	0.000	0.00	20	4.35	
11a	6Mbps	1	64	5320	5320.050	0.050	9.40	20	3.8	
11a	6Mbps	1	64	5320	5320.050	0.050	9.40	-30	3.8	
11a	6Mbps	1	64	5320	5320.050	0.050	9.40	50	3.8	

Band III										
Mod.	Data Rate	NTX	CH.	Freq. (MHz)	Center Frequency (MHz)	Frequency Deviation (MHz)	Frequency Stability (ppm)	Temperature (°C)	Voltage (V)	Note
11a	6Mbps	1	100	5500	5499.950	-0.050	-9.09	20	3.4	
11a	6Mbps	1	100	5500	5500.050	0.050	9.09	20	4.35	
11a	6Mbps	1	100	5500	5500.000	0.000	0.00	20	3.8	
11a	6Mbps	1	100	5500	5500.000	0.000	0.00	-30	3.8	
11a	6Mbps	1	100	5500	5500.000	0.000	0.00	50	3.8	



Appendix B. Radiated Spurious Emission

Test Engineer :	Bill Kuo, Ken Wu, and J.C. Liang	Temperature :	21~23°C
		Relative Humidity :	54~56%

Band 1 - 5150~5250MHz

WIFI 802.11a (Band Edge @ 3m)

WIFI Ant.	Note	Frequency (MHz)	Level (dBμV/m)	Over Limit (dB)	Limit Line (dBμV/m)	Read Level (dBμV)	Antenna Factor (dB/m)	Cable Loss (dB)	Preamp Factor (dB)	Ant Pos (cm)	Table Pos (deg)	Peak Avg. (P/A)	Pol. (H/V)	
802.11a CH 36 5180MHz		5150	52.23	-21.77	74	45.24	31.58	8.95	33.54	224	304	P	H	
		5150	43.65	-10.35	54	36.66	31.58	8.95	33.54	224	304	A	H	
	*	5180	101.78	-	-	94.73	31.62	8.97	33.54	224	304	P	H	
	*	5180	96.09	-	-	89.04	31.62	8.97	33.54	224	304	P	H	
													H	
														H
			5134.1	49.87	-24.13	74	42.9	31.56	8.95	33.54	100	168	P	V
			5149.85	40.89	-13.11	54	33.9	31.58	8.95	33.54	100	168	A	V
	*		5180	99.34	-	-	92.29	31.62	8.97	33.54	100	168	P	V
	*		5180	91	-	-	83.95	31.62	8.97	33.54	100	168	A	V
														V
														V
802.11a CH 44 5220MHz		5135.15	50.44	-23.56	74	43.47	31.56	8.95	33.54	232	303	P	H	
		5140.1	41.65	-12.35	54	34.66	31.58	8.95	33.54	232	303	A	H	
	*	5222	102.64	-	-	95.54	31.66	8.98	33.54	232	303	P	H	
	*	5222	97.05	-	-	89.95	31.66	8.98	33.54	232	303	A	H	
			5373.1	48.95	-25.05	74	41.52	31.84	9.13	33.54	232	303	P	H
			5455.05	39.33	-14.67	54	31.72	31.94	9.22	33.55	232	303	A	H
			5144.9	49.07	-24.93	74	42.08	31.58	8.95	33.54	100	100	P	V
			5139.8	40.32	-13.68	54	33.33	31.58	8.95	33.54	100	100	A	V
	*		5220	98.18	-	-	91.08	31.66	8.98	33.54	100	100	P	V
	*		5220	92.3	-	-	85.2	31.66	8.98	33.54	100	100	A	V
			5450.98	48.39	-25.61	74	40.78	31.94	9.22	33.55	100	100	P	V
			5372.99	39.66	-14.34	54	32.23	31.84	9.13	33.54	100	100	A	V



802.11a CH 48 5240MHz		5128.55	49.35	-24.65	74	42.38	31.56	8.95	33.54	100	305	P	H
		5149.1	41.15	-12.85	54	34.16	31.58	8.95	33.54	100	305	A	H
	*	5240	101.55	-	-	94.43	31.68	8.98	33.54	100	305	P	H
	*	5240	95.93	-	-	88.81	31.68	8.98	33.54	100	305	A	H
		5446.91	49.84	-24.16	74	42.23	31.94	9.22	33.55	100	305	P	H
		5393.01	40.4	-13.6	54	32.96	31.86	9.13	33.55	100	305	A	H
		5058.35	49.48	-24.52	74	42.64	31.48	8.89	33.53	138	105	P	V
		5113.85	40.1	-13.9	54	33.17	31.54	8.92	33.53	138	105	A	V
	*	5240	98.76	-	-	91.64	31.68	8.98	33.54	138	105	P	V
	*	5240	92.07	-	-	84.95	31.68	8.98	33.54	138	105	A	V
		5449.77	48.95	-25.05	74	41.34	31.94	9.22	33.55	138	105	P	V
		5399.06	39.52	-14.48	54	32.06	31.88	9.13	33.55	138	105	A	V
Remark	1. No other spurious found. 2. All results are PASS against Peak and Average limit line.												



Band 1 5150~5250MHz

WIFI 802.11a (Harmonic @ 3m)

WIFI Ant. 1	Note	Frequency (MHz)	Level (dBμV/m)	Over Limit (dB)	Limit Line (dBμV/m)	Read Level (dBμV)	Antenna Factor (dB/m)	Cable Loss (dB)	Preamp Factor (dB)	Ant Pos (cm)	Table Pos (deg)	Peak Avg. (P/A)	Pol. (H/V)
802.11a CH 36 5180MHz		10360	42.57	-31.43	74	57.19	39.79	13.09	67.5	100	0	P	H
		15540	47.95	-26.05	74	58.19	38.6	16.55	65.39	100	0	P	H
													H
													H
		10360	45.28	-28.72	74	59.9	39.79	13.09	67.5	100	0	P	V
		15540	48.18	-25.82	74	58.42	38.6	16.55	65.39	100	0	P	V
													V
													V
802.11a CH 44 5220MHz		10440	41.32	-32.68	74	55.82	39.89	13.11	67.5	100	0	P	H
		15660	46.6	-27.4	74	57.18	38.23	16.56	65.37	100	0	P	H
													H
													H
		10440	41.21	-32.79	74	55.71	39.89	13.11	67.5	100	0	P	V
		15660	47.1	-26.9	74	57.68	38.23	16.56	65.37	100	0	P	V
													V
													V
802.11a CH 48 5240MHz		10480	41.82	-32.18	74	56.24	39.97	13.11	67.5	100	0	P	H
		15720	47.18	-26.82	74	57.94	38.03	16.57	65.36	100	0	P	H
													H
													H
		10480	41.28	-32.72	74	55.7	39.97	13.11	67.5	100	0	P	V
		15720	51.84	-22.16	74	62.6	38.03	16.57	65.36	198	65	P	V
		15720	42.01	-11.99	54	52.77	38.03	16.57	65.36	198	65	A	V
													V
Remark	1. No other spurious found. 2. All results are PASS against Peak and Average limit line.												



Band 1 5150~5250MHz

WIFI 802.11n HT20 (Band Edge @ 3m)

WIFI Ant. 1	Note	Frequency (MHz)	Level (dBμV/m)	Over Limit (dB)	Limit Line (dBμV/m)	Read Level (dBμV)	Antenna Factor (dB/m)	Cable Loss (dB)	Preamp Factor (dB)	Ant Pos (cm)	Table Pos (deg)	Peak Avg. (P/A)	Pol. (H/V)	
802.11n HT20 CH 36 5180MHz		5149.7	53.92	-20.08	74	46.93	31.58	8.95	33.54	244	304	P	H	
		5147.9	45.09	-8.91	54	38.1	31.58	8.95	33.54	244	304	A	H	
	*	5180	102.79	-	-	95.74	31.62	8.97	33.54	244	304	P	H	
	*	5180	96.56	-	-	89.51	31.62	8.97	33.54	244	304	A	H	
													H	
														H
			5110.55	49.32	-24.68	74	42.39	31.54	8.92	33.53	108	106	P	V
			5149.1	41.5	-12.5	54	34.51	31.58	8.95	33.54	108	106	A	V
		*	5180	97.06	-	-	90.01	31.62	8.97	33.54	108	106	P	V
		*	5180	91.42	-	-	84.37	31.62	8.97	33.54	108	106	A	V
													V	
													V	
802.11n HT20 CH 44 5220MHz		5077.1	49.84	-24.16	74	42.98	31.5	8.89	33.53	251	304	P	H	
		5140.1	41.58	-12.42	54	34.59	31.58	8.95	33.54	251	304	A	H	
		*	5220	102.56	-	-	95.46	31.66	8.98	33.54	251	304	P	H
		*	5220	95.79	-	-	88.69	31.66	8.98	33.54	251	304	A	H
			5352.09	47.97	-26.03	74	40.61	31.82	9.08	33.54	251	304	P	H
			5372.33	40.25	-13.75	54	32.82	31.84	9.13	33.54	251	304	A	H
			5111.45	49.37	-24.63	74	42.44	31.54	8.92	33.53	109	105	P	V
			5140.55	40.15	-13.85	54	33.16	31.58	8.95	33.54	109	105	A	V
		*	5220	99.29	-	-	92.19	31.66	8.98	33.54	109	105	P	V
		*	5220	92.5	-	-	85.4	31.66	8.98	33.54	109	105	A	V
		5385.2	49.25	-24.75	74	41.81	31.86	9.13	33.55	109	105	P	V	
		5372	39.7	-14.3	54	32.27	31.84	9.13	33.54	109	105	A	V	



802.11n HT20 CH 48 5240MHz		5021.15	49.85	-24.15	74	43.08	31.44	8.86	33.53	233	308	P	H
		5149.25	40.73	-13.27	54	33.74	31.58	8.95	33.54	233	308	A	H
	*	5240	102.57	-	-	95.45	31.68	8.98	33.54	233	308	P	H
	*	5240	95.62	-	-	88.5	31.68	8.98	33.54	233	308	A	H
		5392.02	49.48	-24.52	74	42.04	31.86	9.13	33.55	233	308	P	H
		5393.67	40.42	-13.58	54	32.98	31.86	9.13	33.55	233	308	A	H
		5035.55	49.26	-24.74	74	42.49	31.44	8.86	33.53	126	105	P	V
		5086.55	39.92	-14.08	54	33.03	31.5	8.92	33.53	126	105	A	V
	*	5240	98.71	-	-	91.59	31.68	8.98	33.54	126	105	P	V
	*	5240	92.38	-	-	85.26	31.68	8.98	33.54	126	105	A	V
		5353.52	48.32	-25.68	74	40.96	31.82	9.08	33.54	126	105	P	V
		5392.46	39.8	-14.2	54	32.36	31.86	9.13	33.55	126	105	A	V
Remark	1. No other spurious found. 2. All results are PASS against Peak and Average limit line.												



Band 1 5150~5250MHz

WIFI 802.11n HT20 (Harmonic @ 3m)

WIFI Ant. 1	Note	Frequency (MHz)	Level (dBμV/m)	Over Limit (dB)	Limit Line (dBμV/m)	Read Level (dBμV)	Antenna Factor (dB/m)	Cable Loss (dB)	Preamp Factor (dB)	Ant Pos (cm)	Table Pos (deg)	Peak Avg. (P/A)	Pol. (H/V)
802.11n HT20 CH 36 5180MHz		10360	42.94	-31.06	74	57.56	39.79	13.09	67.5	100	0	P	H
		15540	47.11	-26.89	74	57.35	38.6	16.55	65.39	100	0	P	H
													H
													H
		10360	43.91	-30.09	74	58.53	39.79	13.09	67.5	100	0	P	V
		15540	46.63	-27.37	74	56.87	38.6	16.55	65.39	100	0	P	V
													V
802.11n HT20 CH 44 5220MHz		10440	41.46	-32.54	74	55.96	39.89	13.11	67.5	100	0	P	H
		15660	48.3	-25.7	74	58.88	38.23	16.56	65.37	100	0	P	H
													H
													H
		10440	41.08	-32.92	74	55.58	39.89	13.11	67.5	100	0	P	V
		15660	48.3	-25.7	74	58.88	38.23	16.56	65.37	100	0	P	V
													V
802.11n HT20 CH 48 5240MHz		10480	41.19	-32.81	74	55.61	39.97	13.11	67.5	100	0	P	H
		15720	48.82	-25.18	74	59.58	38.03	16.57	65.36	100	0	P	H
													H
													H
		10480	42.57	-31.43	74	56.99	39.97	13.11	67.5	100	0	P	V
		15720	51.36	-22.64	74	62.12	38.03	16.57	65.36	197	35	P	V
		15720	44.41	-9.59	54	55.17	38.03	16.57	65.36	197	35	A	V
												V	
Remark	1. No other spurious found. 2. All results are PASS against Peak and Average limit line.												



Band 1 5150~5250MHz

WIFI 802.11n HT40 (Band Edge @ 3m)

WIFI Ant. 1	Note	Frequency (MHz)	Level (dBμV/m)	Over Limit (dB)	Limit Line (dBμV/m)	Read Level (dBμV)	Antenna Factor (dB/m)	Cable Loss (dB)	Preamp Factor (dB)	Ant Pos (cm)	Table Pos (deg)	Peak Avg. (P/A)	Pol. (H/V)
802.11n HT40 CH 38 5190MHz		5148.95	63.21	-10.79	74	56.22	31.58	8.95	33.54	227	304	P	H
		5150	50.72	-3.28	54	43.73	31.58	8.95	33.54	227	304	A	H
	*	5190	96.22	-	-	89.17	31.62	8.97	33.54	227	304	P	H
	*	5190	90.24	-	-	83.19	31.62	8.97	33.54	227	304	A	H
		5445.92	48.48	-25.52	74	40.87	31.94	9.22	33.55	227	304	P	H
		5428.1	39.92	-14.08	54	32.4	31.9	9.17	33.55	227	304	A	H
		5149.25	57.78	-16.22	74	50.79	31.58	8.95	33.54	100	104	P	V
		5149.25	45.38	-8.62	54	38.39	31.58	8.95	33.54	100	104	A	V
	*	5190	93.02	-	-	85.97	31.62	8.97	33.54	100	104	P	V
	*	5190	86.36	-	-	79.31	31.62	8.97	33.54	100	104	A	V
		5393.67	47.88	-26.12	74	40.44	31.86	9.13	33.55	100	104	P	V
		5429.53	39.97	-14.03	54	32.43	31.92	9.17	33.55	100	104	A	V
802.11n HT40 CH 46 5230MHz		5149.7	50.51	-23.49	74	43.52	31.58	8.95	33.54	231	305	P	H
		5145.95	41.26	-12.74	54	34.27	31.58	8.95	33.54	231	305	A	H
	*	5230	98.22	-	-	91.1	31.68	8.98	33.54	231	305	P	H
	*	5230	91.86	-	-	84.74	31.68	8.98	33.54	231	305	A	H
		5412.92	49.02	-24.98	74	41.5	31.9	9.17	33.55	231	305	P	H
		5374.75	40.62	-13.38	54	33.2	31.84	9.13	33.55	231	305	A	H
		5082.8	48.97	-25.03	74	42.08	31.5	8.92	33.53	101	105	P	V
		5090.3	40.44	-13.56	54	33.53	31.52	8.92	33.53	101	105	A	V
	*	5230	95.4	-	-	88.28	31.68	8.98	33.54	101	105	P	V
	*	5230	88.1	-	-	80.98	31.68	8.98	33.54	101	105	A	V
	5384.32	48.3	-25.7	74	40.86	31.86	9.13	33.55	101	105	P	V	
	5377.83	40.31	-13.69	54	32.87	31.86	9.13	33.55	101	105	A	V	
Remark	1. No other spurious found. 2. All results are PASS against Peak and Average limit line.												



Band 1 5150~5250MHz

WIFI 802.11n HT40 (Harmonic @ 3m)

WIFI Ant. 1	Note	Frequency (MHz)	Level (dBμV/m)	Over Limit (dB)	Limit Line (dBμV/m)	Read Level (dBμV)	Antenna Factor (dB/m)	Cable Loss (dB)	Preamp Factor (dB)	Ant Pos (cm)	Table Pos (deg)	Peak Avg. (P/A)	Pol. (H/V)
802.11n HT40 CH 38 5190MHz		10380	42.63	-31.37	74	57.23	39.81	13.09	67.5	100	0	P	H
		15570	42.28	-31.72	74	52.63	38.49	16.55	65.39	100	0	P	H
													H
													H
		10380	43.21	-30.79	74	57.81	39.81	13.09	67.5	100	0	P	V
		15570	42.82	-31.18	74	53.17	38.49	16.55	65.39	100	0	P	V
													V
													V
802.11n HT40 CH 46 5230MHz		10460	41.14	-32.86	74	55.61	39.92	13.11	67.5	100	0	P	H
		15690	43.75	-30.25	74	54.42	38.13	16.56	65.36	100	0	P	H
													H
													H
		10460	41.27	-32.73	74	55.74	39.92	13.11	67.5	100	0	P	V
		15690	44.74	-29.26	74	55.41	38.13	16.56	65.36	100	0	P	V
													V
													V
Remark	1. No other spurious found. 2. All results are PASS against Peak and Average limit line.												



Band 2 - 5250~5350MHz

WIFI 802.11a (Band Edge @ 3m)

WIFI	Note	Frequency	Level	Over	Limit	Read	Antenna	Cable	Preamp	Ant	Table	Peak	Pol.
Ant.				Limit	Line	Level	Factor	Loss	Factor	Pos	Pos	Avg.	
1		(MHz)	(dBμV/m)	(dB)	(dBμV/m)	(dBμV)	(dB/m)	(dB)	(dB)	(cm)	(deg)	(P/A)	(H/V)
802.11a CH 52 5260MHz		5026.4	49.58	-24.42	74	42.81	31.44	8.86	33.53	247	311	P	H
		5107.7	40.55	-13.45	54	33.62	31.54	8.92	33.53	247	311	A	H
	*	5260	102.98	-	-	95.81	31.72	8.99	33.54	247	311	P	H
	*	5260	96.46	-	-	89.29	31.72	8.99	33.54	247	311	A	H
		5405.66	49.79	-24.21	74	42.29	31.88	9.17	33.55	247	311	P	H
		5350.77	40.62	-13.38	54	33.26	31.82	9.08	33.54	247	311	A	H
		5084.3	48.81	-25.19	74	41.92	31.5	8.92	33.53	100	103	P	V
		5103.8	40.12	-13.88	54	33.21	31.52	8.92	33.53	100	103	A	V
	*	5260	99.44	-	-	92.27	31.72	8.99	33.54	100	103	P	V
	*	5260	93.56	-	-	86.39	31.72	8.99	33.54	100	103	A	V
		5408.3	49.15	-24.85	74	41.65	31.88	9.17	33.55	100	103	P	V
		5411.27	39.92	-14.08	54	32.42	31.88	9.17	33.55	100	103	A	V
802.11a CH 60 5300MHz		5145.5	49.59	-24.41	74	41.29	31.58	8.95	32.23	100	122	P	H
		5145.65	40.17	-13.83	54	31.87	31.58	8.95	32.23	100	122	A	H
	*	5300	103.32	-	-	94.71	31.76	9.04	32.19	100	122	P	H
	*	5300	96.3	-	-	87.69	31.76	9.04	32.19	100	122	A	H
		5365.4	50.11	-23.89	74	41.31	31.84	9.13	32.17	100	122	P	H
		5350.44	40.63	-13.37	54	31.91	31.82	9.08	32.18	100	122	A	H
		5075.75	49.05	-24.95	74	40.91	31.5	8.89	32.25	100	58	P	V
		5088.65	40.09	-13.91	54	31.89	31.52	8.92	32.24	100	58	A	V
	*	5300	99.57	-	-	90.96	31.76	9.04	32.19	100	58	P	V
	*	5300	92.24	-	-	83.63	31.76	9.04	32.19	100	58	A	V
		5384.21	48.53	-25.47	74	39.71	31.86	9.13	32.17	100	58	P	V
		5359.35	40.39	-13.61	54	31.67	31.82	9.08	32.18	100	58	A	V



802.11a CH 64 5320MHz	*	5320	101.66	-	-	94.38	31.78	9.04	33.54	240	303	P	H
	*	5320	96.3	-	-	89.02	31.78	9.04	33.54	240	303	A	H
		5356.71	51.73	-22.27	74	44.37	31.82	9.08	33.54	240	303	P	H
		5350.11	43.65	-10.35	54	36.29	31.82	9.08	33.54	240	303	A	H
													H
													H
	*	5320	98.66	-	-	91.38	31.78	9.04	33.54	100	98	P	V
	*	5320	92.63	-	-	85.35	31.78	9.04	33.54	100	98	A	V
		5377.72	50.21	-23.79	74	42.77	31.86	9.13	33.55	100	98	P	V
		5350.77	41.74	-12.26	54	34.38	31.82	9.08	33.54	100	98	A	V
													V
													V
Remark	1. No other spurious found. 2. All results are PASS against Peak and Average limit line.												



Band 2 5250~5350MHz

WIFI 802.11a (Harmonic @ 3m)

WIFI Ant. 1	Note	Frequency (MHz)	Level (dBμV/m)	Over Limit (dB)	Limit Line (dBμV/m)	Read Level (dBμV)	Antenna Factor (dB/m)	Cable Loss (dB)	Preamp Factor (dB)	Ant Pos (cm)	Table Pos (deg)	Peak Avg. (P/A)	Pol. (H/V)
802.11a CH 52 5260MHz		10520	43.88	-30.12	74	58.21	40.01	13.14	67.48	100	0	P	H
		15780	48.46	-25.54	74	59.36	37.87	16.57	65.34	100	0	P	H
													H
													H
		10520	44.02	-29.98	74	58.35	40.01	13.14	67.48	100	0	P	V
		15780	50.52	-23.48	74	61.42	37.87	16.57	65.34	100	0	P	V
													V
													V
802.11a CH 60 5300MHz		10600	43.45	-30.55	74	57.59	40.06	13.2	67.4	100	0	P	H
		15900	48.73	-25.27	74	59.96	37.51	16.58	65.32	100	0	P	H
													H
													H
		10600	43.41	-30.59	74	57.55	40.06	13.2	67.4	100	0	P	V
		15900	50.73	-23.27	74	61.96	37.51	16.58	65.32	100	0	P	V
													V
													V
802.11a CH 64 5320MHz		10640	43.89	-30.11	74	57.94	40.08	13.23	67.36	100	0	P	H
		15960	50.79	-23.21	74	62.21	37.3	16.59	65.31	100	0	P	H
													H
													H
		10640	43.16	-30.84	74	57.21	40.08	13.23	67.36	100	0	P	V
		15960	53.13	-20.87	74	64.55	37.3	16.59	65.31	329	42	P	V
		15960	45.03	-8.97	54	56.45	37.3	16.59	65.31	329	42	A	V
													V
Remark	1. No other spurious found. 2. All results are PASS against Peak and Average limit line.												



Band 2 5250~5350MHz

WIFI 802.11n HT20 (Band Edge @ 3m)

WIFI Ant. 1	Note	Frequency (MHz)	Level (dBμV/m)	Over Limit (dB)	Limit Line (dBμV/m)	Read Level (dBμV)	Antenna Factor (dB/m)	Cable Loss (dB)	Preamp Factor (dB)	Ant Pos (cm)	Table Pos (deg)	Peak Avg. (P/A)	Pol. (H/V)
802.11n HT20 CH 52 5260MHz		5093	49	-25	74	42.09	31.52	8.92	33.53	247	306	P	H
		5108.75	40.51	-13.49	54	33.58	31.54	8.92	33.53	247	306	A	H
	*	5260	101.46	-	-	94.29	31.72	8.99	33.54	247	306	P	H
	*	5260	95.93	-	-	88.76	31.72	8.99	33.54	247	306	A	H
		5355.72	50.9	-23.1	74	43.54	31.82	9.08	33.54	247	306	P	H
		5350.11	40.83	-13.17	54	33.47	31.82	9.08	33.54	247	306	A	H
		5020.1	48.65	-25.35	74	41.9	31.42	8.86	33.53	100	103	P	V
		5107.4	40.03	-13.97	54	33.1	31.54	8.92	33.53	100	103	A	V
	*	5260	97.89	-	-	90.72	31.72	8.99	33.54	100	103	P	V
	*	5260	91.67	-	-	84.5	31.72	8.99	33.54	100	103	A	V
		5451.42	48.94	-25.06	74	41.33	31.94	9.22	33.55	100	103	P	V
		5355.5	39.7	-14.3	54	32.34	31.82	9.08	33.54	100	103	A	V
802.11n HT20 CH 60 5300MHz		5118.65	49.42	-24.58	74	42.5	31.54	8.92	33.54	227	307	P	H
		5148.5	40.73	-13.27	54	33.74	31.58	8.95	33.54	227	307	A	H
	*	5300	103.37	-	-	96.11	31.76	9.04	33.54	227	307	P	H
	*	5300	97.29	-	-	90.03	31.76	9.04	33.54	227	307	A	H
		5350	51.27	-22.73	74	43.91	31.82	9.08	33.54	227	307	P	H
		5354.51	42.95	-11.05	54	35.59	31.82	9.08	33.54	227	307	A	H
		5056.7	48.94	-25.06	74	42.1	31.48	8.89	33.53	223	103	P	V
		5104.1	39.9	-14.1	54	32.99	31.52	8.92	33.53	223	103	A	V
	*	5300	99.83	-	-	92.57	31.76	9.04	33.54	223	103	P	V
	*	5300	93.97	-	-	86.71	31.76	9.04	33.54	223	103	A	V
	5388.72	49.72	-24.28	74	42.28	31.86	9.13	33.55	223	103	P	V	
	5354.29	41.59	-12.41	54	34.23	31.82	9.08	33.54	223	103	A	V	



802.11n HT20 CH 64 5320MHz	*	5320	103.3	-	-	96.02	31.78	9.04	33.54	256	306	P	H
	*	5320	96.36	-	-	89.08	31.78	9.04	33.54	256	306	A	H
		5350.77	52.88	-21.12	74	45.52	31.82	9.08	33.54	256	306	P	H
		5350.66	44.06	-9.94	54	36.7	31.82	9.08	33.54	256	306	A	H
													H
													H
	*	5320	99.38	-	-	92.1	31.78	9.04	33.54	235	107	P	V
	*	5320	93.59	-	-	86.31	31.78	9.04	33.54	235	107	A	V
		5381.68	51.15	-22.85	74	43.71	31.86	9.13	33.55	235	107	P	V
		5350.11	42.72	-11.28	54	35.36	31.82	9.08	33.54	235	107	A	V
													V
													V
Remark	1. No other spurious found. 2. All results are PASS against Peak and Average limit line.												



Band 2 5250~5350MHz

WIFI 802.11n HT20 (Harmonic @ 3m)

WIFI Ant. 1	Note	Frequency (MHz)	Level (dBμV/m)	Over Limit (dB)	Limit Line (dBμV/m)	Read Level (dBμV)	Antenna Factor (dB/m)	Cable Loss (dB)	Preamp Factor (dB)	Ant Pos (cm)	Table Pos (deg)	Peak Avg. (P/A)	Pol. (H/V)	
802.11n HT20 CH 52 5260MHz		10520	44.58	-29.42	74	58.91	40.01	13.14	67.48	100	0	P	H	
		15780	48.1	-25.9	74	59	37.87	16.57	65.34	100	0	P	H	
													H	
													H	
			10520	43.1	-30.9	74	57.43	40.01	13.14	67.48	100	0	P	V
			15780	49.57	-24.43	74	60.47	37.87	16.57	65.34	100	0	P	V
														V
802.11n HT20 CH 60 5300MHz		10600	43.24	-30.76	74	57.38	40.06	13.2	67.4	100	0	P	H	
		15900	49.96	-24.04	74	61.19	37.51	16.58	65.32	100	0	P	H	
													H	
													H	
			10600	43.6	-30.4	74	57.74	40.06	13.2	67.4	100	0	P	V
			15900	52.54	-21.46	74	63.77	37.51	16.58	65.32	245	54	P	V
			15900	43	-11	54	54.23	37.51	16.58	65.32	245	54	A	V
802.11n HT20 CH 64 5320MHz		10640	44.69	-29.31	74	58.74	40.08	13.23	67.36	100	0	P	H	
		15960	50.4	-23.6	74	61.82	37.3	16.59	65.31	100	0	P	H	
													H	
													H	
			10640	43.46	-30.54	74	57.51	40.08	13.23	67.36	100	0	P	V
			15960	53.44	-20.56	74	64.86	37.3	16.59	65.31	247	53	P	V
			15960	46.04	-7.96	54	57.46	37.3	16.59	65.31	247	53	A	V
													V	
Remark	1. No other spurious found. 2. All results are PASS against Peak and Average limit line.													



Band 2 5250~5350MHz

WIFI 802.11n HT40 (Band Edge @ 3m)

WIFI Ant. 1	Note	Frequency (MHz)	Level (dBμV/m)	Over Limit (dB)	Limit Line (dBμV/m)	Read Level (dBμV)	Antenna Factor (dB/m)	Cable Loss (dB)	Preamp Factor (dB)	Ant Pos (cm)	Table Pos (deg)	Peak Avg. (P/A)	Pol. (H/V)
802.11n HT40 CH 54 5270MHz		5125.55	49.99	-24.01	74	43.02	31.56	8.95	33.54	245	307	P	H
		5120.15	41.12	-12.88	54	34.2	31.54	8.92	33.54	245	307	A	H
	*	5270	98.31	-	-	91.14	31.72	8.99	33.54	245	307	P	H
	*	5270	91.72	-	-	84.55	31.72	8.99	33.54	245	307	A	H
		5415.12	48.98	-25.02	74	41.46	31.9	9.17	33.55	245	307	P	H
		5353.52	41.03	-12.97	54	33.67	31.82	9.08	33.54	245	307	A	H
		5027.75	49.99	-24.01	74	43.22	31.44	8.86	33.53	100	110	P	V
		5135.15	40.63	-13.37	54	33.66	31.56	8.95	33.54	100	110	A	V
	*	5270	95.13	-	-	87.96	31.72	8.99	33.54	100	110	P	V
	*	5270	88.82	-	-	81.65	31.72	8.99	33.54	100	110	A	V
		5365.62	49.42	-24.58	74	41.99	31.84	9.13	33.54	100	110	P	V
		5421.28	40.66	-13.34	54	33.14	31.9	9.17	33.55	100	110	A	V
802.11n HT40 CH 62 5310MHz		5023.85	49.64	-24.36	74	42.87	31.44	8.86	33.53	224	302	P	H
		5101.85	40.7	-13.3	54	33.79	31.52	8.92	33.53	224	302	A	H
	*	5310	97.26	-	-	89.98	31.78	9.04	33.54	224	302	P	H
	*	5310	90.2	-	-	82.92	31.78	9.04	33.54	224	302	A	H
		5350.77	57.93	-16.07	74	50.57	31.82	9.08	33.54	224	302	P	H
		5350.55	50.6	-3.4	54	43.24	31.82	9.08	33.54	224	302	A	H
		5119.4	49.08	-24.92	74	42.16	31.54	8.92	33.54	100	91	P	V
		5126.3	40.57	-13.43	54	33.6	31.56	8.95	33.54	100	91	A	V
	*	5310	93.41	-	-	86.13	31.78	9.04	33.54	100	91	P	V
	*	5310	87.01	-	-	79.73	31.78	9.04	33.54	100	91	A	V
	5350.55	57.14	-16.86	74	49.78	31.82	9.08	33.54	100	91	P	V	
	5350.77	47.81	-6.19	54	40.45	31.82	9.08	33.54	100	91	A	V	
Remark	1. No other spurious found. 2. All results are PASS against Peak and Average limit line.												



Band 2 5250~5350MHz

WIFI 802.11n HT40 (Harmonic @ 3m)

WIFI Ant. 1	Note	Frequency (MHz)	Level (dBμV/m)	Over Limit (dB)	Limit Line (dBμV/m)	Read Level (dBμV)	Antenna Factor (dB/m)	Cable Loss (dB)	Preamp Factor (dB)	Ant Pos (cm)	Table Pos (deg)	Peak Avg. (P/A)	Pol. (H/V)
802.11n HT40 CH 54 5270MHz		10540	43.49	-30.51	74	57.8	40.02	13.14	67.47	100	0	P	H
		15810	44.63	-29.37	74	55.63	37.77	16.57	65.34	100	0	P	H
													H
													H
		10540	43.36	-30.64	74	57.67	40.02	13.14	67.47	100	0	P	V
		15810	47.46	-26.54	74	58.46	37.77	16.57	65.34	100	0	P	V
													V
													V
802.11n HT40 CH 62 5310MHz		10620	42.34	-31.66	74	56.45	40.07	13.2	67.38	100	0	P	H
		15930	42.75	-31.25	74	54.07	37.41	16.58	65.31	100	0	P	H
													H
													H
		10620	43	-31	74	57.11	40.07	13.2	67.38	100	0	P	V
		15930	46.21	-27.79	74	57.53	37.41	16.58	65.31	100	0	P	V
													V
													V
Remark	1. No other spurious found. 2. All results are PASS against Peak and Average limit line.												



Band 3 - 5470~5725MHz

WIFI 802.11a (Band Edge @ 3m)

WIFI	Note	Frequency	Level	Over	Limit	Read	Antenna	Cable	Preamp	Ant	Table	Peak	Pol.	
Ant.				Limit	Line	Level	Factor	Loss	Factor	Pos	Pos	Avg.		
1		(MHz)	(dBμV/m)	(dB)	(dBμV/m)	(dBμV)	(dB/m)	(dB)	(dB)	(cm)	(deg)	(P/A)	(H/V)	
802.11a CH 100 5500MHz		5460.24	51.24	-22.76	74	42.23	31.94	9.22	32.15	333	61	P	H	
		5470	43.7	-10.3	54	34.67	31.96	9.22	32.15	333	61	A	H	
	*	5499	102.84	-	-	93.72	32	9.26	32.14	333	61	P	H	
	*	5499	95.1	-	-	85.98	32	9.26	32.14	333	61	A	H	
													H	
													H	
			5452.24	50.05	-23.95	74	41.04	31.94	9.22	32.15	100	105	P	V
			5469.68	42.86	-11.14	54	33.83	31.96	9.22	32.15	100	105	A	V
	*		5503	101.26	-	-	92.14	32	9.26	32.14	100	105	P	V
	*		5503	93.87	-	-	84.75	32	9.26	32.14	100	105	A	V
													V	
													V	
802.11a CH 116 5580MHz		5364.72	49.02	-24.98	74	40.22	31.84	9.13	32.17	326	59	P	H	
		5467.6	40.46	-13.54	54	31.43	31.96	9.22	32.15	326	59	A	H	
	*	5580	102.96	-	-	93.66	32.1	9.32	32.12	326	59	P	H	
	*	5580	96.05	-	-	86.75	32.1	9.32	32.12	326	59	A	H	
			5735.16	50.27	-23.73	74	40.55	32.34	9.44	32.06	326	59	P	H
			5733	41.75	-12.25	54	32.07	32.31	9.44	32.07	326	59	A	H
			5432.08	49.71	-24.29	74	40.78	31.92	9.17	32.16	100	109	P	V
			5463.92	39.99	-14.01	54	30.96	31.96	9.22	32.15	100	109	A	V
	*		5582	101.58	-	-	92.25	32.12	9.32	32.11	100	109	P	V
	*		5582	94.87	-	-	85.54	32.12	9.32	32.11	100	109	A	V
			5746.52	50.73	-23.27	74	41.01	32.34	9.44	32.06	100	109	P	V
			5732.52	41.8	-12.2	54	32.12	32.31	9.44	32.07	100	109	A	V



802.11a CH 140 5700MHz	*	5700	103.16	-	-	93.58	32.27	9.39	32.08	343	64	P	H
	*	5700	96.51	-	-	86.93	32.27	9.39	32.08	343	64	A	H
		5725.48	54.97	-19.03	74	45.29	32.31	9.44	32.07	343	64	P	H
		5725.08	46.37	-7.63	54	36.69	32.31	9.44	32.07	343	64	A	H
													H
													H
	*	5700	101.77	-	-	92.19	32.27	9.39	32.08	102	104	P	V
	*	5700	95.83	-	-	86.25	32.27	9.39	32.08	102	104	A	V
		5730.36	59.68	-14.32	74	50	32.31	9.44	32.07	102	104	P	V
		5725	47.1	-6.9	54	37.42	32.31	9.44	32.07	102	104	A	V
													V
													V
Remark	1. No other spurious found. 2. All results are PASS against Peak and Average limit line.												



Band 3 - 5470~5725MHz

WIFI 802.11a (Harmonic @ 3m)

WIFI Ant. 1	Note	Frequency (MHz)	Level (dBμV/m)	Over Limit (dB)	Limit Line (dBμV/m)	Read Level (dBμV)	Antenna Factor (dB/m)	Cable Loss (dB)	Preamp Factor (dB)	Ant Pos (cm)	Table Pos (deg)	Peak Avg. (P/A)	Pol. (H/V)
802.11a CH 100 5500MHz		11000	46.42	-27.58	74	59.64	40.3	13.48	67	100	0	P	H
		16500	51.41	-22.59	74	59.7	38.9	16.81	64	149	47	P	H
		16500	43.05	-10.95	54	51.34	38.9	16.81	64	149	47	A	H
													H
		11000	44.07	-29.93	74	57.29	40.3	13.48	67	100	0	P	V
		16500	58.17	-15.83	74	66.46	38.9	16.81	64	242	14	P	V
		16500	50.16	-3.84	54	58.45	38.9	16.81	64	242	14	A	V
802.11a CH 116 5580MHz		11160	41.58	-32.42	74	54.34	40.17	13.64	66.57	100	0	P	H
		16740	47.01	-26.99	74	54.53	39.58	16.8	63.9	100	0	P	H
													H
													H
		11160	43.63	-30.37	74	56.39	40.17	13.64	66.57	100	0	P	V
		16740	54.86	-19.14	74	62.38	39.58	16.8	63.9	289	18	P	V
		16740	45.55	-8.45	54	53.07	39.58	16.8	63.9	289	18	A	V
802.11a CH 140 5700MHz		11400	42.25	-31.75	74	54.36	39.98	13.87	65.96	100	0	P	H
		17100	45.97	-28.03	74	52.44	40.6	16.85	63.92	100	0	P	H
													H
													H
		11400	41.64	-32.36	74	53.75	39.98	13.87	65.96	100	0	P	V
		17100	52.21	-21.79	74	58.68	40.6	16.85	63.92	284	25	P	V
		17100	44.37	-9.63	54	50.84	40.6	16.85	63.92	284	25	A	V
Remark	1. No other spurious found. 2. All results are PASS against Peak and Average limit line.												



Band 3 - 5470~5725MHz

WIFI 802.11n HT20 (Band Edge @ 3m)

WIFI Ant. 1	Note	Frequency (MHz)	Level (dBμV/m)	Over Limit (dB)	Limit Line (dBμV/m)	Read Level (dBμV)	Antenna Factor (dB/m)	Cable Loss (dB)	Preamp Factor (dB)	Ant Pos (cm)	Table Pos (deg)	Peak Avg. (P/A)	Pol. (H/V)	
802.11n HT20 CH 100 5500MHz		5466.48	54.39	-19.61	74	45.36	31.96	9.22	32.15	335	58	P	H	
		5469.68	43.76	-10.24	54	34.73	31.96	9.22	32.15	335	58	A	H	
	*	5500	103.74	-	-	94.62	32	9.26	32.14	335	58	P	H	
	*	5500	97.19	-	-	88.07	32	9.26	32.14	335	58	A	H	
													H	
														H
			5467.12	52.01	-21.99	74	42.98	31.96	9.22	32.15	100	106	P	V
			5469.84	43.71	-10.29	54	34.68	31.96	9.22	32.15	100	106	A	V
		*	5500	101.13	-	-	92.01	32	9.26	32.14	100	106	P	V
		*	5500	95.46	-	-	86.34	32	9.26	32.14	100	106	A	V
													V	
													V	
802.11n HT20 CH 116 5580MHz		5410.96	49.68	-24.32	74	40.8	31.88	9.17	32.17	323	59	P	H	
		5465.04	40.06	-13.94	54	31.03	31.96	9.22	32.15	323	59	A	H	
	*	5580	103.49	-	-	94.19	32.1	9.32	32.12	323	59	P	H	
	*	5580	97.29	-	-	87.99	32.1	9.32	32.12	323	59	A	H	
			5736.04	49.67	-24.33	74	39.95	32.34	9.44	32.06	323	59	P	H
			5733	41.73	-12.27	54	32.05	32.31	9.44	32.07	323	59	A	H
			5466.48	48.6	-25.4	74	39.57	31.96	9.22	32.15	103	110	P	V
			5426.96	40.06	-13.94	54	31.15	31.9	9.17	32.16	103	110	A	V
		*	5581	103.12	-	-	93.82	32.1	9.32	32.12	103	110	P	V
		*	5581	97.65	-	-	88.35	32.1	9.32	32.12	103	110	A	V
		5758.44	49.98	-24.02	74	40.24	32.36	9.44	32.06	103	110	P	V	
		5732.12	41.72	-12.28	54	32.04	32.31	9.44	32.07	103	110	A	V	



802.11n HT20 CH 140 5700MHz	*	5700	104.33	-	-	96.3	32.27	9.39	33.63	326	61	P	H
	*	5700	98.08	-	-	90.05	32.27	9.39	33.63	326	61	A	H
		5728.84	58.17	-15.83	74	50.06	32.31	9.44	33.64	326	61	P	H
		5725	46.58	-7.42	54	38.47	32.31	9.44	33.64	326	61	A	H
													H
													H
	*	5700	102.13	-	-	94.1	32.27	9.39	33.63	100	106	P	V
	*	5700	96.17	-	-	88.14	32.27	9.39	33.63	100	106	A	V
		5725.08	59.08	-14.92	74	50.97	32.31	9.44	33.64	100	106	P	V
		5725	47.99	-6.01	54	39.88	32.31	9.44	33.64	100	106	A	V
													V
													V
Remark	1. No other spurious found. 2. All results are PASS against Peak and Average limit line.												



Band 3 - 5470~5725MHz

WIFI 802.11n HT20 (Harmonic @ 3m)

WIFI Ant. 1	Note	Frequency (MHz)	Level (dBμV/m)	Over Limit (dB)	Limit Line (dBμV/m)	Read Level (dBμV)	Antenna Factor (dB/m)	Cable Loss (dB)	Preamp Factor (dB)	Ant Pos (cm)	Table Pos (deg)	Peak Avg. (P/A)	Pol. (H/V)	
802.11n HT20 CH 100 5500MHz		11000	44.1	-29.9	74	57.32	40.3	13.48	67	100	0	P	H	
		16500	50.47	-23.53	74	58.76	38.9	16.81	64	100	0	P	H	
													H	
													H	
			11000	43.91	-30.09	74	57.13	40.3	13.48	67	100	0	P	V
			16500	56.55	-17.45	74	64.84	38.9	16.81	64	232	53	P	V
			16500	46.57	-7.43	54	54.86	38.9	16.81	64	232	53	A	V
													V	
802.11n HT20 CH 116 5580MHz		11160	40.19	-33.81	74	52.95	40.17	13.64	66.57	100	0	P	H	
		16740	46.86	-27.14	74	54.38	39.58	16.8	63.9	100	0	P	H	
													H	
													H	
			11160	40.58	-33.42	74	53.34	40.17	13.64	66.57	100	0	P	V
			16740	53.8	-20.2	74	61.32	39.58	16.8	63.9	245	53	P	V
			16740	47.19	-6.81	54	54.71	39.58	16.8	63.9	245	53	A	V
													V	
802.11n HT20 CH 140 5700MHz		11400	42.25	-31.75	74	54.36	39.98	13.87	65.96	100	0	P	H	
		17100	45.62	-28.38	74	52.09	40.6	16.85	63.92	100	0	P	H	
													H	
													H	
			11400	42.23	-31.77	74	54.34	39.98	13.87	65.96	100	0	P	V
			17100	51.06	-22.94	74	57.53	40.6	16.85	63.92	248	59	P	V
			17100	42.84	-11.16	54	49.31	40.6	16.85	63.92	248	59	A	V
													V	
Remark	1. No other spurious found. 2. All results are PASS against Peak and Average limit line.													



Band 3 - 5470~5725MHz

WIFI 802.11n HT40 (Band Edge @ 3m)

WIFI Ant. 1	Note	Frequency (MHz)	Level (dBμV/m)	Over Limit (dB)	Limit Line (dBμV/m)	Read Level (dBμV)	Antenna Factor (dB/m)	Cable Loss (dB)	Preamp Factor (dB)	Ant Pos (cm)	Table Pos (deg)	Peak Avg. (P/A)	Pol. (H/V)
802.11n HT40 CH 102 5510MHz		5469.84	57.43	-16.57	74	48.4	31.96	9.22	32.15	255	62	P	H
		5470	50.77	-3.23	54	41.74	31.96	9.22	32.15	255	62	A	H
	*	5510	98.68	-	-	89.56	32	9.26	32.14	255	62	P	H
	*	5510	92.17	-	-	83.05	32	9.26	32.14	255	62	A	H
		5759.08	49.77	-24.23	74	40.03	32.36	9.44	32.06	255	62	P	H
		5762.2	41.03	-12.97	54	31.24	32.36	9.49	32.06	255	62	A	H
		5464.56	61.25	-12.75	74	52.22	31.96	9.22	32.15	100	112	P	V
		5469.36	50.72	-3.28	54	41.69	31.96	9.22	32.15	100	112	A	V
	*	5510	96.65	-	-	87.53	32	9.26	32.14	100	112	P	V
	*	5510	90.14	-	-	81.02	32	9.26	32.14	100	112	A	V
		5736.92	49.6	-24.4	74	39.88	32.34	9.44	32.06	100	112	P	V
		5740.2	41.13	-12.87	54	31.41	32.34	9.44	32.06	100	112	A	V
802.11n HT40 CH 110 5550MHz		5391.76	49.7	-24.3	74	42.26	31.86	9.13	33.55	232	68	P	H
		5467.12	42.25	-11.75	54	34.62	31.96	9.22	33.55	232	68	A	H
	*	5550	101.25	-	-	93.46	32.07	9.29	33.57	232	68	P	H
	*	5550	93.93	-	-	86.14	32.07	9.29	33.57	232	68	A	H
		5731.72	49.96	-24.04	74	41.86	32.31	9.44	33.65	232	68	P	H
		5747.56	41.62	-12.38	54	33.49	32.34	9.44	33.65	232	68	A	H
		5466.96	49.08	-24.92	74	41.45	31.96	9.22	33.55	100	113	P	V
		5469.84	41.29	-12.71	54	33.66	31.96	9.22	33.55	100	113	A	V
	*	5549	98.61	-	-	90.82	32.07	9.29	33.57	100	113	P	V
	*	5549	91.87	-	-	84.08	32.07	9.29	33.57	100	113	A	V
		5760.6	50	-24	74	41.85	32.36	9.44	33.65	100	113	P	V
		5726.04	41.79	-12.21	54	33.68	32.31	9.44	33.64	100	113	A	V



802.11n HT40 CH 134 5670MHz		5468.08	48.6	-25.4	74	40.97	31.96	9.22	33.55	324	65	P	H
		5440.24	40.25	-13.75	54	32.71	31.92	9.17	33.55	324	65	A	H
	*	5670	99.67	-	-	91.7	32.24	9.35	33.62	324	65	P	H
	*	5670	92.65	-	-	84.68	32.24	9.35	33.62	324	65	A	H
		5727.88	61.17	-12.83	74	53.06	32.31	9.44	33.64	324	65	P	H
		5725.88	46.1	-7.9	54	37.99	32.31	9.44	33.64	324	65	A	H
		5453.52	48.06	-25.94	74	40.45	31.94	9.22	33.55	101	98	P	V
		5468.24	40.19	-13.81	54	32.56	31.96	9.22	33.55	101	98	A	V
	*	5670	99.47	-	-	91.5	32.24	9.35	33.62	101	98	P	V
	*	5670	92.53	-	-	84.56	32.24	9.35	33.62	101	98	A	V
		5728.28	61.76	-12.24	74	53.65	32.31	9.44	33.64	101	98	P	V
		5725.16	48.26	-5.74	54	40.15	32.31	9.44	33.64	101	98	A	V
Remark	1. No other spurious found. 2. All results are PASS against Peak and Average limit line.												



Band 3 - 5470~5725MHz

WIFI 802.11n HT40 (Harmonic @ 3m)

WIFI Ant. 1	Note	Frequency (MHz)	Level (dBμV/m)	Over Limit (dB)	Limit Line (dBμV/m)	Read Level (dBμV)	Antenna Factor (dB/m)	Cable Loss (dB)	Preamp Factor (dB)	Ant Pos (cm)	Table Pos (deg)	Peak Avg. (P/A)	Pol. (H/V)	
802.11n HT40 CH 102 5510MHz		11020	44.64	-29.36	74	57.83	40.29	13.48	66.96	100	0	P	H	
		16530	43.27	-30.73	74	51.45	39	16.81	63.99	100	0	P	H	
													H	
													H	
			11020	42.68	-31.32	74	55.87	40.29	13.48	66.96	100	0	P	V
			16530	48.42	-25.58	74	56.6	39	16.81	63.99	100	0	P	V
														V
802.11n HT40 CH 110 5550MHz		11100	43.19	-30.81	74	56.15	40.22	13.56	66.74	100	0	P	H	
		16650	41.35	-32.65	74	49.16	39.33	16.8	63.94	100	0	P	H	
													H	
													H	
			11100	43.6	-30.4	74	56.56	40.22	13.56	66.74	100	0	P	V
			16650	52.49	-21.51	74	60.3	39.33	16.8	63.94	100	18	P	V
			16650	44.45	-9.55	54	52.26	39.33	16.8	63.94	100	18	A	V
802.11n HT40 CH 134 5670MHz		11340	43.72	-30.28	74	56.03	40.03	13.79	66.13	100	0	P	H	
		17010	42.88	-31.12	74	49.55	40.35	16.8	63.82	100	0	P	H	
													H	
													H	
			11340	43.05	-30.95	74	55.36	40.03	13.79	66.13	100	0	P	V
			17010	49.45	-24.55	74	56.12	40.35	16.8	63.82	100	0	P	V
														V
Remark	1. No other spurious found.													
	2. All results are PASS against Peak and Average limit line.													



Emission below 1GHz

WIFI 802.11a (LF @ 3m)

WIFI	Note	Frequency	Level	Over	Limit	Read	Antenna	Cable	Preamp	Ant	Table	Peak	Pol.	
Ant.				Limit	Line	Level	Factor	Loss	Factor	Pos	Pos	Avg.		
1		(MHz)	(dBμV/m)	(dB)	(dBμV/m)	(dBμV)	(dB/m)	(dB)	(dB)	(cm)	(deg)	(P/A)	(H/V)	
802.11a LF		97.23	24.94	-18.56	43.5	39.7	15.74	1.28	31.78	-	-	P	H	
		163.11	28.03	-15.47	43.5	41.75	16.6	1.46	31.78	-	-	P	H	
		201.45	35.81	-7.69	43.5	49.91	16.04	1.64	31.78	145	200	P	H	
		465.2	24.98	-21.02	46	30.72	23.55	2.57	31.86	-	-	P	H	
		721.4	28.65	-17.35	46	30.39	27.13	3.14	32.01	-	-	P	H	
		958	33.31	-12.69	46	30.02	30.58	3.68	30.97	-	-	P	H	
													H	
													H	
													H	
													H	
													H	
													H	
			31.08	31.33	-8.67	40	37.31	25.18	0.67	31.83	100	315	P	V
			64.02	30.99	-9.01	40	49.64	12.1	1.04	31.79	-	-	P	V
			197.13	29.92	-13.58	43.5	44.27	15.79	1.64	31.78	-	-	P	V
			547.1	26.1	-19.9	46	30.53	24.76	2.77	31.96	-	-	P	V
			795.6	30.2	-15.8	46	30.53	28.24	3.35	31.92	-	-	P	V
			993.7	33.82	-20.18	54	30.22	30.51	3.78	30.69	-	-	P	V
												V		
												V		
												V		
												V		
												V		
												V		
Remark	1. No other spurious found. 2. All results are PASS against limit line.													



Emission below 1GHz

WIFI 802.11n HT20 (LF @ 3m)

WIFI	Note	Frequency	Level	Over	Limit	Read	Antenna	Cable	Preamp	Ant	Table	Peak	Pol.	
Ant.				Limit	Line	Level	Factor	Loss	Factor	Pos	Pos	Avg.		
1		(MHz)	(dBμV/m)	(dB)	(dBμV/m)	(dBμV)	(dB/m)	(dB)	(dB)	(cm)	(deg)	(P/A)	(H/V)	
802.11n HT20 LF		98.85	25.4	-18.1	43.5	39.92	15.98	1.28	31.78	-	-	P	H	
		167.16	27.85	-15.65	43.5	41.79	16.2	1.64	31.78	-	-	P	H	
		201.45	36.27	-7.23	43.5	50.37	16.04	1.64	31.78	150	116	P	H	
		465.9	24.53	-21.47	46	30.27	23.55	2.57	31.86	-	-	P	H	
		679.4	26.93	-19.07	46	29.46	26.49	3.02	32.04	-	-	P	H	
		950.3	32.85	-13.15	46	29.6	30.6	3.68	31.03	-	-	P	H	
														H
														H
														H
														H
														H
														H
			31.89	30.61	-9.39	40	37.11	24.66	0.67	31.83	100	308	P	V
			63.21	30.17	-9.83	40	48.87	12.05	1.04	31.79	-	-	P	V
			196.86	26.83	-16.67	43.5	41.18	15.79	1.64	31.78	-	-	P	V
			501.6	25.49	-20.51	46	30.63	24.11	2.64	31.89	-	-	P	V
			742.4	29.38	-16.62	46	30.58	27.54	3.25	31.99	-	-	P	V
			952.4	32.87	-13.13	46	29.62	30.59	3.68	31.02	-	-	P	V
														V
														V
													V	
													V	
													V	
													V	
Remark	1. No other spurious found. 2. All results are PASS against limit line.													



Emission below 1GHz

WIFI 802.11n HT40 (LF @ 3m)

WIFI	Note	Frequency	Level	Over	Limit	Read	Antenna	Cable	Preamp	Ant	Table	Peak	Pol.	
Ant.				Limit	Line	Level	Factor	Loss	Factor	Pos	Pos	Avg.		
1		(MHz)	(dBμV/m)	(dB)	(dBμV/m)	(dBμV)	(dB/m)	(dB)	(dB)	(cm)	(deg)	(P/A)	(H/V)	
802.11n HT40 LF		98.31	21.94	-21.56	43.5	36.58	15.86	1.28	31.78	-	-	P	H	
		141.24	25.75	-17.75	43.5	38.26	17.81	1.46	31.78	-	-	P	H	
		199.02	32.51	-10.99	43.5	46.72	15.93	1.64	31.78	155	168	P	H	
		539.4	25.43	-20.57	46	29.96	24.65	2.77	31.95	-	-	P	H	
		787.9	30.91	-15.09	46	31.34	28.15	3.35	31.93	-	-	P	H	
		948.2	33.04	-12.96	46	29.84	30.57	3.68	31.05	-	-	P	H	
														H
														H
														H
														H
														H
														H
			31.62	28.91	-11.09	40	35.41	24.66	0.67	31.83	-	-	P	V
			63.48	30.28	-9.72	40	48.93	12.1	1.04	31.79	100	320	P	V
			199.29	27.14	-16.36	43.5	41.28	16	1.64	31.78	-	-	P	V
			492.5	24.83	-21.17	46	30.09	23.98	2.64	31.88	-	-	P	V
			812.4	30.32	-15.68	46	30.33	28.45	3.4	31.86	-	-	P	V
			944	32.99	-13.01	46	29.95	30.44	3.68	31.08	-	-	P	V
														V
														V
													V	
													V	
													V	
													V	
Remark	1. No other spurious found. 2. All results are PASS against limit line.													



Note symbol

*	Fundamental Frequency which can be ignored. However, the level of any unwanted emissions shall not exceed the level of the fundamental frequency.
!	Test result is over limit line.
P/A	Peak or Average
H/V	Horizontal or Vertical



A calculation example for radiated spurious emission is shown as below:

WIFI	Note	Frequency	Level	Over	Limit	Read	Antenna	Cable	Preamp	Ant	Table	Peak	Pol.
Ant.				Limit	Line	Level	Factor	Loss	Factor	Pos	Pos	Avg.	
1		(MHz)	(dBμV/m)	(dB)	(dBμV/m)	(dBμV)	(dB/m)	(dB)	(dB)	(cm)	(deg)	(P/A)	(H/V)
802.11b		2390	55.45	-18.55	74	54.51	32.22	4.58	35.86	103	308	P	H
CH 01													
2412MHz		2390	43.54	-10.46	54	42.6	32.22	4.58	35.86	103	308	A	H

- 1. Level(dBμV/m) =
Antenna Factor(dB/m) + Cable Loss(dB) + Read Level(dBμV) - Preamp Factor(dB)
- 2. Over Limit(dB) = Level(dBμV/m) – Limit Line(dBμV/m)

For Peak Limit @ 2390MHz:

- 1. Level(dBμV/m)
= Antenna Factor(dB/m) + Cable Loss(dB) + Read Level(dBμV) - Preamp Factor(dB)
= 32.22(dB/m) + 4.58(dB) + 54.51(dBμV) – 35.86 (dB)
= 55.45 (dBμV/m)
- 2. Over Limit(dB)
= Level(dBμV/m) – Limit Line(dBμV/m)
= 55.45(dBμV/m) – 74(dBμV/m)
= -18.55(dB)

For Average Limit @ 2390MHz:

- 1. Level(dBμV/m)
= Antenna Factor(dB/m) + Cable Loss(dB) + Read Level(dBμV) - Preamp Factor(dB)
= 32.22(dB/m) + 4.58(dB) + 42.6(dBμV) – 35.86 (dB)
= 43.54 (dBμV/m)
- 2. Over Limit(dB)
= Level(dBμV/m) – Limit Line(dBμV/m)
= 43.54(dBμV/m) – 54(dBμV/m)
= -10.46(dB)

Both peak and average measured complies with the limit line, so test result is “PASS”.



Appendix C. Radiated Spurious Emission

Note symbol

-L	Low channel location
-R	High channel location



Band 1 - 5150~5250MHz
WIFI 802.11a (Band Edge @ 3m)

WIFI	Band 1 5150~5250MHz Band Edge @ 3m	
ANT	802.11a CH36 5180MHz	
1	Horizontal	Vertical
Peak	<p>Site : 03CH11-HY Condition : FCC CLASS-B 3m HORN 9120D-HF HORIZONTAL RBW:1000.000KHz VBW:3000.000KHz SWT:Auto Detector : Peak</p>	<p>Site : 03CH11-HY Condition : FCC CLASS-B 3m HORN 9120D-HF VERTICAL RBW:1000.000KHz VBW:3000.000KHz SWT:Auto Detector : Peak</p>
Avg.	<p>Site : 03CH11-HY Condition : FCC CLASS-B (AVG) 3m HORN 9120D-HF HORIZONTAL RBW:1000.000KHz VBW:1.000KHz SWT:Auto Detector : Peak</p>	<p>Site : 03CH11-HY Condition : FCC CLASS-B (AVG) 3m HORN 9120D-HF VERTICAL RBW:1000.000KHz VBW:1.000KHz SWT:Auto Detector : Peak</p>



WIFI	Band 1 5150~5250MHz Band Edge @ 3m	
ANT	802.11a CH44 5220MHz - L	
1	Horizontal	Vertical
Peak	<p>Site : 03CH11-HY Condition : FCC CLASS-B 3m HORN 9120D-HF HORIZONTAL Detector : Peak</p>	<p>Site : 03CH11-HY Condition : FCC CLASS-B 3m HORN 9120D-HF VERTICAL Detector : Peak</p>
Avg.	<p>Site : 03CH11-HY Condition : FCC CLASS-B (AVG) 3m HORN 9120D-HF HORIZONTAL Detector : Peak</p>	<p>Site : 03CH11-HY Condition : FCC CLASS-B (AVG) 3m HORN 9120D-HF VERTICAL Detector : Peak</p>



WIFI	Band 1 5150~5250MHz Band Edge @ 3m	
ANT	802.11a CH44 5220MHz - R	
1	Horizontal	Vertical
Peak	<p>Site : 03CH11-HY Condition : FCC CLASS-B 3m HORN 9120D-HF HORIZONTAL RBW:1000.000KHz VBW:3000.000KHz SWT:Auto Detector : Peak</p>	<p>Site : 03CH11-HY Condition : FCC CLASS-B 3m HORN 9120D-HF VERTICAL RBW:1000.000KHz VBW:3000.000KHz SWT:Auto Detector : Peak</p>
Avg.	<p>Site : 03CH11-HY Condition : FCC CLASS-B (AVG) 3m HORN 9120D-HF HORIZONTAL RBW:1000.000KHz VBW:1.000KHz SWT:Auto Detector : Peak</p>	<p>Site : 03CH11-HY Condition : FCC CLASS-B (AVG) 3m HORN 9120D-HF VERTICAL RBW:1000.000KHz VBW:1.000KHz SWT:Auto Detector : Peak</p>



WIFI	Band 1 5150~5250MHz Band Edge @ 3m	
ANT	802.11a CH48 5240MHz - L	
1	Horizontal	Vertical
Peak	<p>Site : 03CH11-HY Condition : FCC CLASS-B 3m HORN 9120D-HF HORIZONTAL RBW:1000.000KHz VBW:3000.000KHz SWT:Auto Detector : Peak</p>	<p>Site : 03CH11-HY Condition : FCC CLASS-B 3m HORN 9120D-HF VERTICAL RBW:1000.000KHz VBW:3000.000KHz SWT:Auto Detector : Peak</p>
Avg.	<p>Site : 03CH11-HY Condition : FCC CLASS-B (AVG) 3m HORN 9120D-HF HORIZONTAL RBW:1000.000KHz VBW:1.000KHz SWT:Auto Detector : Peak</p>	<p>Site : 03CH11-HY Condition : FCC CLASS-B (AVG) 3m HORN 9120D-HF VERTICAL RBW:1000.000KHz VBW:1.000KHz SWT:Auto Detector : Peak</p>

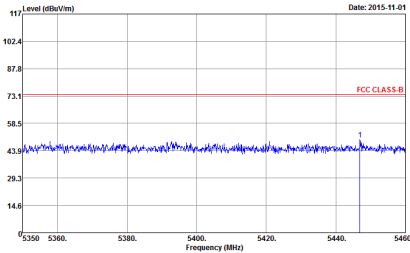
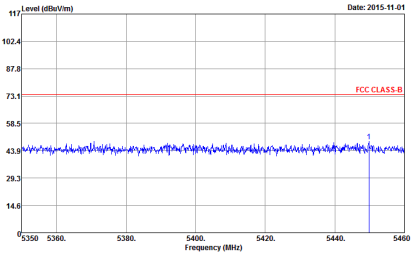
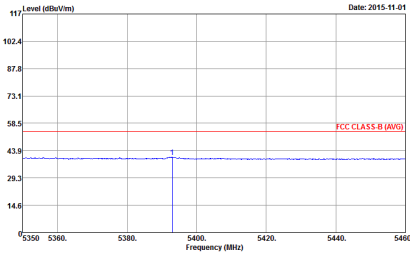
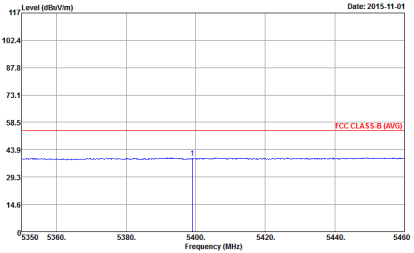

WIFI	Band 1 5150~5250MHz Band Edge @ 3m	
ANT	802.11a CH48 5240MHz - R	
1	Horizontal	Vertical
Peak	 <p>Site : 03CH11-HY Condition : FCC CLASS-B 3m HORN 9120D-HF HORIZONTAL RBW:1000.000KHz VBW:3000.000KHz SWT:Auto Detector : Peak</p>	 <p>Site : 03CH11-HY Condition : FCC CLASS-B 3m HORN 9120D-HF VERTICAL RBW:1000.000KHz VBW:3000.000KHz SWT:Auto Detector : Peak</p>
Avg.	 <p>Site : 03CH11-HY Condition : FCC CLASS-B (AVG) 3m HORN 9120D-HF HORIZONTAL RBW:1000.000KHz VBW:1.000KHz SWT:Auto Detector : Peak</p>	 <p>Site : 03CH11-HY Condition : FCC CLASS-B (AVG) 3m HORN 9120D-HF VERTICAL RBW:1000.000KHz VBW:1.000KHz SWT:Auto Detector : Peak</p>



Band 1 5150~5250MHz
WIFI 802.11n HT20 (Band Edge @ 3m)

Table with 4 columns: WIFI, ANT, 1, and two sub-columns for Horizontal and Vertical. Rows are labeled 'Peak' and 'Avg.' containing spectral plots and technical details like Site, Condition, and Detector.



WIFI	Band 1 5150~5250MHz Band Edge @ 3m	
ANT	802.11n HT20 CH44 5220MHz - L	
1	Horizontal	Vertical
Peak	<p>Site : 03CH11-HY Condition : FCC CLASS-B 3m HORN 9120D-HF HORIZONTAL RBW:1000.000KHz VBW:3000.000KHz SWT:Auto Detector : Peak</p>	<p>Site : 03CH11-HY Condition : FCC CLASS-B 3m HORN 9120D-HF VERTICAL RBW:1000.000KHz VBW:3000.000KHz SWT:Auto Detector : Peak</p>
Avg.	<p>Site : 03CH11-HY Condition : FCC CLASS-B (AVG) 3m HORN 9120D-HF HORIZONTAL RBW:1000.000KHz VBW:1.000KHz SWT:Auto Detector : Peak</p>	<p>Site : 03CH11-HY Condition : FCC CLASS-B (AVG) 3m HORN 9120D-HF VERTICAL RBW:1000.000KHz VBW:1.000KHz SWT:Auto Detector : Peak</p>



WIFI	Band 1 5150~5250MHz Band Edge @ 3m	
ANT	802.11n HT20 CH44 5220MHz - R	
1	Horizontal	Vertical
Peak	<p>Site : 03CH11-HY Condition : FCC CLASS-B 3m HORN 9120D-HF HORIZONTAL RBW:1000.000KHz VBW:3000.000KHz SWT:Auto Detector : Peak</p>	<p>Site : 03CH11-HY Condition : FCC CLASS-B 3m HORN 9120D-HF VERTICAL RBW:1000.000KHz VBW:3000.000KHz SWT:Auto Detector : Peak</p>
Avg.	<p>Site : 03CH11-HY Condition : FCC CLASS-B (AVG) 3m HORN 9120D-HF HORIZONTAL RBW:1000.000KHz VBW:1.000KHz SWT:Auto Detector : Peak</p>	<p>Site : 03CH11-HY Condition : FCC CLASS-B (AVG) 3m HORN 9120D-HF VERTICAL RBW:1000.000KHz VBW:1.000KHz SWT:Auto Detector : Peak</p>

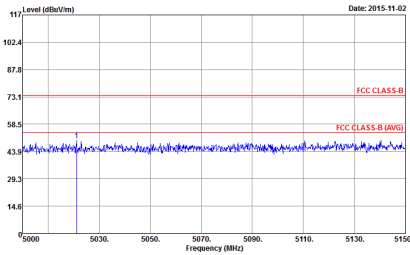
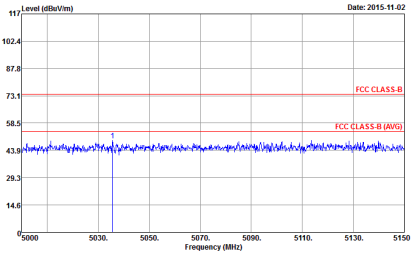
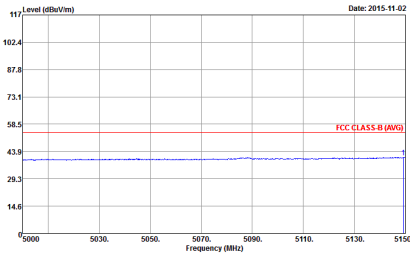
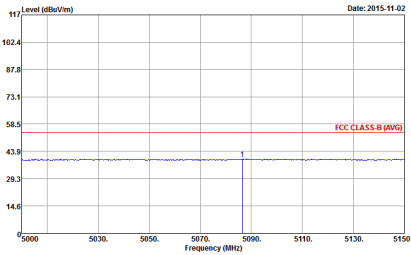

WIFI	Band 1 5150~5250MHz Band Edge @ 3m	
ANT	802.11n HT20 CH48 5240MHz - L	
1	Horizontal	Vertical
Peak	 <p>Site : 03CH11-HY Condition : FCC CLASS-B 3m HORN 9120D-HF HORIZONTAL Detector : Peak</p>	 <p>Site : 03CH11-HY Condition : FCC CLASS-B 3m HORN 9120D-HF VERTICAL Detector : Peak</p>
Avg.	 <p>Site : 03CH11-HY Condition : FCC CLASS-B (AVG) 3m HORN 9120D-HF HORIZONTAL Detector : Peak</p>	 <p>Site : 03CH11-HY Condition : FCC CLASS-B (AVG) 3m HORN 9120D-HF VERTICAL Detector : Peak</p>

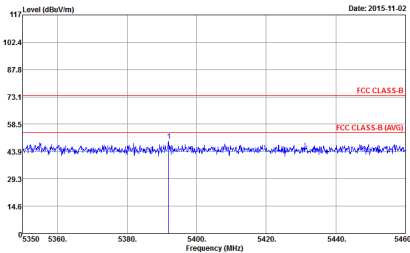
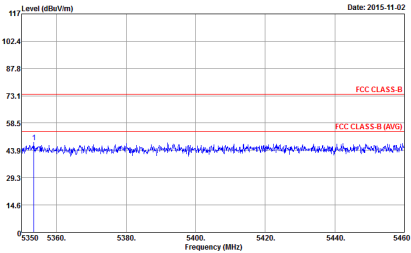
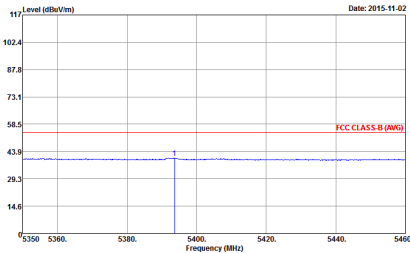
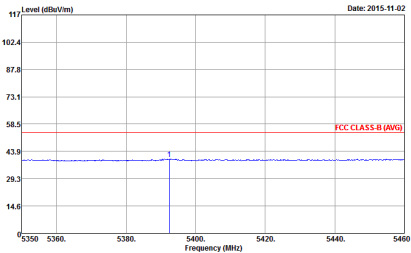

WIFI	Band 1 5150~5250MHz Band Edge @ 3m	
ANT	802.11n HT20 CH48 5240MHz - R	
1	Horizontal	Vertical
Peak	 <p>Site : 03CH11-HY Condition : FCC CLASS-B 3m HORN 9120D-HF HORIZONTAL RBW:1000.000KHz VBW:3000.000KHz SWT:Auto Detector : Peak</p>	 <p>Site : 03CH11-HY Condition : FCC CLASS-B 3m HORN 9120D-HF VERTICAL RBW:1000.000KHz VBW:3000.000KHz SWT:Auto Detector : Peak</p>
Avg.	 <p>Site : 03CH11-HY Condition : FCC CLASS-B (AVG) 3m HORN 9120D-HF HORIZONTAL RBW:1000.000KHz VBW:1.000KHz SWT:Auto Detector : Peak</p>	 <p>Site : 03CH11-HY Condition : FCC CLASS-B (AVG) 3m HORN 9120D-HF VERTICAL RBW:1000.000KHz VBW:1.000KHz SWT:Auto Detector : Peak</p>



**Band 1 5150~5250MHz
WIFI 802.11n HT40 (Band Edge @ 3m)**

WIFI	Band 1 5150~5250MHz Band Edge @ 3m	
ANT	802.11n HT40 CH38 5190MHz - L	
1	Horizontal	Vertical
Peak	<p>Site : 03CH11-HY Condition : FCC CLASS-B 3m HORN 9120D-HF HORIZONTAL RBW:1000.000KHz VBW:3000.000KHz SWT:Auto Detector : Peak</p>	<p>Site : 03CH11-HY Condition : FCC CLASS-B 3m HORN 9120D-HF VERTICAL RBW:1000.000KHz VBW:3000.000KHz SWT:Auto Detector : Peak</p>
Avg.	<p>Site : 03CH11-HY Condition : FCC CLASS-B (AVG) 3m HORN 9120D-HF HORIZONTAL RBW:1000.000KHz VBW:3.000KHz SWT:Auto Detector : Peak</p>	<p>Site : 03CH11-HY Condition : FCC CLASS-B (AVG) 3m HORN 9120D-HF VERTICAL RBW:1000.000KHz VBW:3.000KHz SWT:Auto Detector : Peak</p>

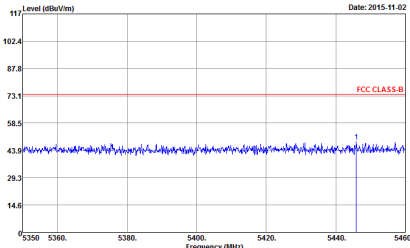
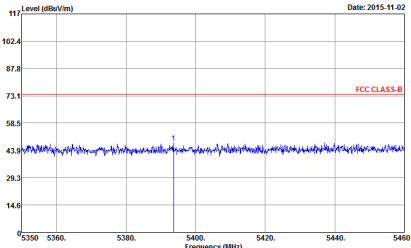
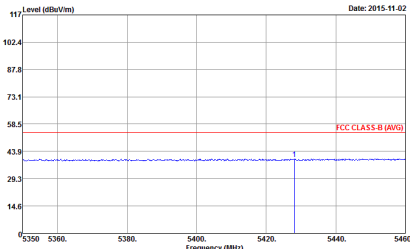
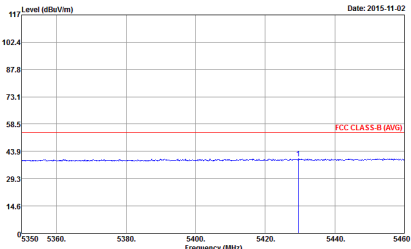

WIFI	Band 1 5150~5250MHz Band Edge @ 3m	
ANT	802.11n HT40 CH38 5190MHz - R	
1	Horizontal	Vertical
Peak	 <p>Site : 03CH11-HY Condition : FCC CLASS-B 3m HORN 9120D-HF HORIZONTAL RBW:1000.000KHz VBW:3000.000KHz SWT:Auto Detector : Peak</p>	 <p>Site : 03CH11-HY Condition : FCC CLASS-B 3m HORN 9120D-HF VERTICAL RBW:1000.000KHz VBW:3000.000KHz SWT:Auto Detector : Peak</p>
Avg.	 <p>Site : 03CH11-HY Condition : FCC CLASS-B (AVG) 3m HORN 9120D-HF HORIZONTAL RBW:1000.000KHz VBW:3.000KHz SWT:Auto Detector : Peak</p>	 <p>Site : 03CH11-HY Condition : FCC CLASS-B (AVG) 3m HORN 9120D-HF VERTICAL RBW:1000.000KHz VBW:3.000KHz SWT:Auto Detector : Peak</p>

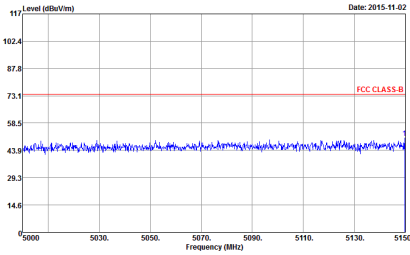
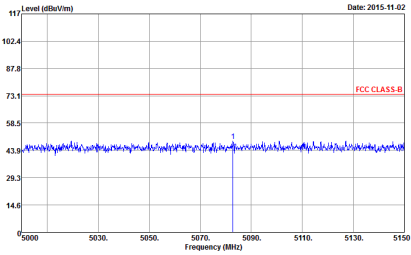
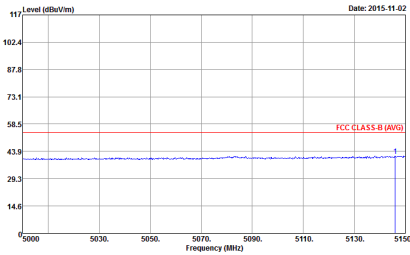
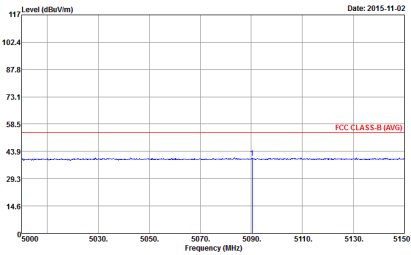

WIFI	Band 1 5150~5250MHz Band Edge @ 3m	
ANT	802.11n HT40 CH46 5230MHz - L	
1	Horizontal	Vertical
Peak	 <p>Level (dBuV/m) vs Frequency (MHz) plot for Horizontal orientation. The y-axis ranges from 14.6 to 117 dBuV/m, and the x-axis ranges from 5000 to 5150 MHz. A red horizontal line indicates the FCC CLASS-B limit at 73.1 dBuV/m. The blue signal line remains below this limit, with a peak at approximately 5140 MHz.</p> <p>Site : 03CH11-HY Condition : FCC CLASS-B 3m HORN 9120D-HF HORIZONTAL RBW:1000.000KHz VBW:3000.000KHz SWT:Auto Detector : Peak</p>	 <p>Level (dBuV/m) vs Frequency (MHz) plot for Vertical orientation. The y-axis ranges from 14.6 to 117 dBuV/m, and the x-axis ranges from 5000 to 5150 MHz. A red horizontal line indicates the FCC CLASS-B limit at 73.1 dBuV/m. The blue signal line shows a sharp peak at approximately 5090 MHz, reaching about 70 dBuV/m.</p> <p>Site : 03CH11-HY Condition : FCC CLASS-B 3m HORN 9120D-HF VERTICAL RBW:1000.000KHz VBW:3000.000KHz SWT:Auto Detector : Peak</p>
Avg.	 <p>Level (dBuV/m) vs Frequency (MHz) plot for Horizontal orientation showing average values. The y-axis ranges from 14.6 to 117 dBuV/m, and the x-axis ranges from 5000 to 5150 MHz. A red horizontal line indicates the FCC CLASS-B (AVG) limit at 58.5 dBuV/m. The blue signal line is consistently below this limit.</p> <p>Site : 03CH11-HY Condition : FCC CLASS-B (AVG) 3m HORN 9120D-HF HORIZONTAL RBW:1000.000KHz VBW:3.000KHz SWT:Auto Detector : Peak</p>	 <p>Level (dBuV/m) vs Frequency (MHz) plot for Vertical orientation showing average values. The y-axis ranges from 14.6 to 117 dBuV/m, and the x-axis ranges from 5000 to 5150 MHz. A red horizontal line indicates the FCC CLASS-B (AVG) limit at 58.5 dBuV/m. The blue signal line is consistently below this limit.</p> <p>Site : 03CH11-HY Condition : FCC CLASS-B (AVG) 3m HORN 9120D-HF VERTICAL RBW:1000.000KHz VBW:3.000KHz SWT:Auto Detector : Peak</p>



WIFI	Band 1 5150~5250MHz Band Edge @ 3m	
ANT	802.11n HT40 CH46 5230MHz - R	
1	Horizontal	Vertical
Peak	<p>Site : 03CH11-HY Condition : FCC CLASS-B 3m HORN 9120D-HF HORIZONTAL RBW:1000.000KHz VBW:3000.000KHz SWT:Auto Detector : Peak</p>	<p>Site : 03CH11-HY Condition : FCC CLASS-B 3m HORN 9120D-HF VERTICAL RBW:1000.000KHz VBW:3000.000KHz SWT:Auto Detector : Peak</p>
Avg.	<p>Site : 03CH11-HY Condition : FCC CLASS-B (AVG) 3m HORN 9120D-HF HORIZONTAL RBW:1000.000KHz VBW:3.000KHz SWT:Auto Detector : Peak</p>	<p>Site : 03CH11-HY Condition : FCC CLASS-B (AVG) 3m HORN 9120D-HF VERTICAL RBW:1000.000KHz VBW:3.000KHz SWT:Auto Detector : Peak</p>



Band 1 - 5150~5250MHz
WIFI 802.11a (Harmonic @ 3m)

WIFI	Band 1 5150~5250MHz Harmonic @ 3m	
ANT	802.11a CH36 5180MHz	
1	Horizontal	Vertical
Peak Avg.	<p>Site : 03CH11-HY Condition : FCC CLASS-B 3m 9170 SHF HORM_150809 HORIZONTAL Detector : Peak</p>	<p>Site : 03CH11-HY Condition : FCC CLASS-B 3m 9170 SHF HORM_150809 VERTICAL Detector : Peak</p>



WIFI	Band 1 5150~5250MHz Harmonic @ 3m	
ANT	802.11a CH44 5220MHz	
1	Horizontal	Vertical
Peak Avg.	<p>Site : 03CH11-HY Condition : FCC CLASS-B 3m 9170 SHF HORM_150809 HORIZONTAL Detector : Peak</p>	<p>Site : 03CH11-HY Condition : FCC CLASS-B 3m 9170 SHF HORM_150809 VERTICAL Detector : Peak</p>



WIFI	Band 1 5150~5250MHz Harmonic @ 3m	
ANT	802.11a CH48 5240MHz	
1	Horizontal	Vertical
<p>Peak</p> <p>Avg.</p>	<p>Site : 03CH11-HY Condition : FCC CLASS-B 3m 9170 SHF HORM_150809 HORIZONTAL Detector : Peak</p>	<p>Site : 03CH11-HY Condition : FCC CLASS-B 3m 9170 SHF HORM_150809 VERTICAL Detector : Peak</p>



**Band 1 5150~5250MHz
WIFI 802.11n HT20 (Harmonic @ 3m)**

WIFI	Band 1 5150~5250MHz Harmonic @ 3m	
ANT	802.11n HT20 CH36 5180MHz	
1	Horizontal	Vertical
Peak Avg.	<p>Site : 03GH11-HY Condition : FCC CLASS-B 3m 9170 SHF HORM_150809 HORIZONTAL Detector : Peak</p>	<p>Site : 03GH11-HY Condition : FCC CLASS-B 3m 9170 SHF HORM_150809 VERTICAL Detector : Peak</p>



WIFI	Band 1 5150~5250MHz Harmonic @ 3m	
ANT	802.11n HT20 CH44 5220MHz	
1	Horizontal	Vertical
<p>Peak Avg.</p>	<p>Site : 03CH11-HY Condition : FCC CLASS-B 3m 9170 SHF HORM_150809 HORIZONTAL Detector : Peak</p>	<p>Site : 03CH11-HY Condition : FCC CLASS-B 3m 9170 SHF HORM_150809 VERTICAL Detector : Peak</p>

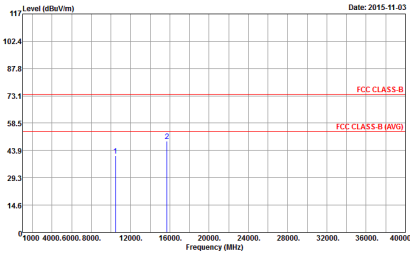
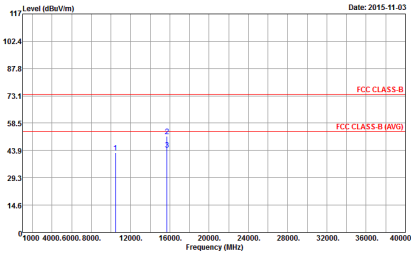

WIFI	Band 1 5150~5250MHz Harmonic @ 3m	
ANT	802.11n HT20 CH48 5240MHz	
1	Horizontal	Vertical
<p>Peak</p> <p>Avg.</p>	 <p>Site : 03CH11-HY Condition : FCC CLASS-B 3m 9170 SHF HORM_150809 HORIZONTAL Detector : Peak</p>	 <p>Site : 03CH11-HY Condition : FCC CLASS-B 3m 9170 SHF HORM_150809 VERTICAL Detector : Peak</p>



**Band 1 5150~5250MHz
WIFI 802.11n HT40 (Harmonic @ 3m)**

WIFI	Band 1 5150~5250MHz Harmonic @ 3m	
ANT	802.11n HT40 CH38 5190MHz	
1	Horizontal	Vertical
Peak Avg.	<p>Site : 03CH11-HY Condition : FCC CLASS-B 3m 9170 SHF HORM_150809 HORIZONTAL Detector : Peak</p>	<p>Site : 03CH11-HY Condition : FCC CLASS-B 3m 9170 SHF HORM_150809 VERTICAL Detector : Peak</p>



WIFI	Band 1 5150~5250MHz Harmonic @ 3m	
ANT	802.11n HT40 CH46 5230MHz	
1	Horizontal	Vertical
Peak Avg.	<p>Site : 03CH11-HY Condition : FCC CLASS-B 3m 9170 SHF HORM_150809 HORIZONTAL Detector : Peak</p>	<p>Site : 03CH11-HY Condition : FCC CLASS-B 3m 9170 SHF HORM_150809 VERTICAL Detector : Peak</p>



Band 2 - 5250~5350MHz
WIFI 802.11a (Band Edge @ 3m)

WIFI	Band 2 5250~5350MHz Band Edge @ 3m	
ANT	802.11a CH52 5260MHz - L	
1	Horizontal	Vertical
Peak	<p>Site : 03CH11-HY Condition : FCC CLASS-B 3m HORN 9120D-HF HORIZONTAL Detector : Peak</p>	<p>Site : 03CH11-HY Condition : FCC CLASS-B 3m HORN 9120D-HF VERTICAL Detector : Peak</p>
Avg.	<p>Site : 03CH11-HY Condition : FCC CLASS-B (AVG) 3m HORN 9120D-HF HORIZONTAL Detector : Peak</p>	<p>Site : 03CH11-HY Condition : FCC CLASS-B (AVG) 3m HORN 9120D-HF VERTICAL Detector : Peak</p>

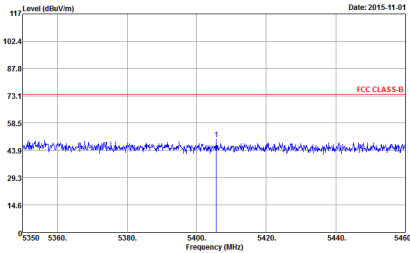
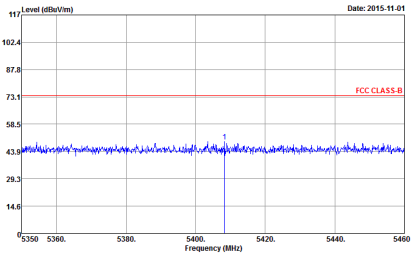
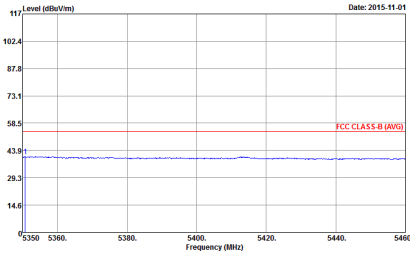
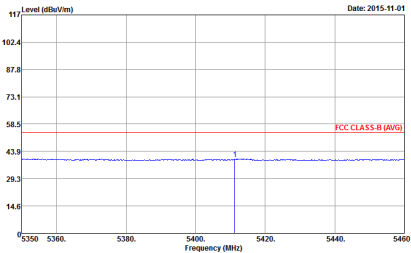

WIFI	Band 2 5250~5350MHz Band Edge @ 3m	
ANT	802.11a CH52 5260MHz - R	
1	Horizontal	Vertical
Peak	 <p>Site : 03CH11-HY Condition : FCC CLASS-B 3m HORN 9120D-HF HORIZONTAL RBW:1000.000KHz VBW:3000.000KHz SWT:Auto Detector : Peak</p>	 <p>Site : 03CH11-HY Condition : FCC CLASS-B 3m HORN 9120D-HF VERTICAL RBW:1000.000KHz VBW:3000.000KHz SWT:Auto Detector : Peak</p>
Avg.	 <p>Site : 03CH11-HY Condition : FCC CLASS-B (AVG) 3m HORN 9120D-HF HORIZONTAL RBW:1000.000KHz VBW:1.000KHz SWT:Auto Detector : Peak</p>	 <p>Site : 03CH11-HY Condition : FCC CLASS-B (AVG) 3m HORN 9120D-HF VERTICAL RBW:1000.000KHz VBW:1.000KHz SWT:Auto Detector : Peak</p>



WIFI	Band 2 5250~5350MHz Band Edge @ 3m	
ANT	802.11a CH60 5300MHz - L	
1	Horizontal	Vertical
Peak	<p>Site : 03CH11-HY Condition : FCC CLASS-B 3m HORN 9120D-HF HORIZONTAL Detector : Peak</p>	<p>Site : 03CH11-HY Condition : FCC CLASS-B 3m HORN 9120D-HF VERTICAL Detector : Peak</p>
Avg.	<p>Site : 03CH11-HY Condition : FCC CLASS-B (AVG) 3m HORN 9120D-HF HORIZONTAL Detector : Peak</p>	<p>Site : 03CH11-HY Condition : FCC CLASS-B (AVG) 3m HORN 9120D-HF VERTICAL Detector : Peak</p>



WIFI	Band 2 5250~5350MHz Band Edge @ 3m	
ANT	802.11a CH60 5300MHz - R	
1	Horizontal	Vertical
Peak	<p>Site : 03CH11-HY Condition : FCC CLASS-B 3m HORN 9120D-HF HORIZONTAL RBW:1000.000KHz VBW:3000.000KHz SWT:Auto Detector : Peak</p>	<p>Site : 03CH11-HY Condition : FCC CLASS-B 3m HORN 9120D-HF VERTICAL RBW:1000.000KHz VBW:3000.000KHz SWT:Auto Detector : Peak</p>
Avg.	<p>Site : 03CH11-HY Condition : FCC CLASS-B (AVG) 3m HORN 9120D-HF HORIZONTAL RBW:1000.000KHz VBW:1.000KHz SWT:Auto Detector : Peak</p>	<p>Site : 03CH11-HY Condition : FCC CLASS-B (AVG) 3m HORN 9120D-HF VERTICAL RBW:1000.000KHz VBW:1.000KHz SWT:Auto Detector : Peak</p>

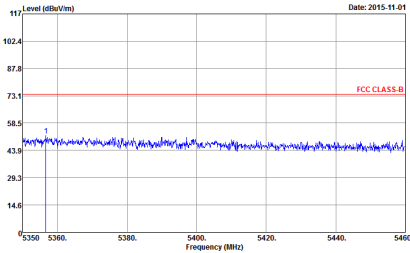
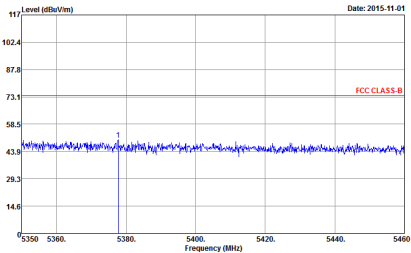
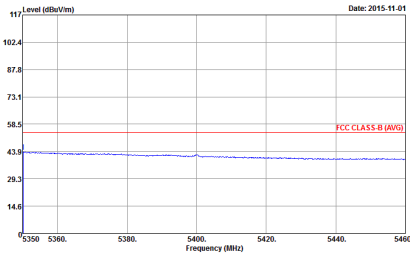
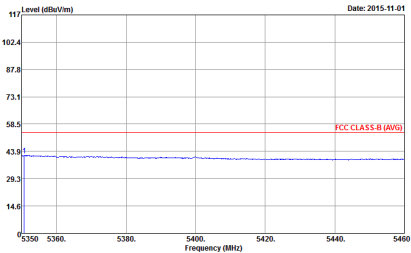

WIFI	Band 2 5250~5350MHz Band Edge @ 3m	
ANT	802.11a CH64 5320MHz	
1	Horizontal	Vertical
Peak	 <p>Site : 03CH11-HY Condition : FCC CLASS-B 3m HORN 9120D-HF HORIZONTAL RBW:1000.000KHz VBW:3000.000KHz SWT:Auto Detector : Peak</p>	 <p>Site : 03CH11-HY Condition : FCC CLASS-B 3m HORN 9120D-HF VERTICAL RBW:1000.000KHz VBW:3000.000KHz SWT:Auto Detector : Peak</p>
Avg.	 <p>Site : 03CH11-HY Condition : FCC CLASS-B (AVG) 3m HORN 9120D-HF HORIZONTAL RBW:1000.000KHz VBW:1.000KHz SWT:Auto Detector : Peak</p>	 <p>Site : 03CH11-HY Condition : FCC CLASS-B (AVG) 3m HORN 9120D-HF VERTICAL RBW:1000.000KHz VBW:1.000KHz SWT:Auto Detector : Peak</p>



Band 2 5250~5350MHz
WIFI 802.11n HT20 (Band Edge @ 3m)

WIFI	Band 2 5250~5350MHz Band Edge @ 3m	
ANT	802.11n HT20 CH52 5260MHz - L	
1	Horizontal	Vertical
Peak	<p>Site : 03CH11-HY Condition : FCC CLASS-B 3m HORN 9120D-HF HORIZONTAL RBW:1000.000KHz VBW:3000.000KHz SWT:Auto Detector : Peak</p>	<p>Site : 03CH11-HY Condition : FCC CLASS-B 3m HORN 9120D-HF VERTICAL RBW:1000.000KHz VBW:3000.000KHz SWT:Auto Detector : Peak</p>
Avg.	<p>Site : 03CH11-HY Condition : FCC CLASS-B (AVG) 3m HORN 9120D-HF HORIZONTAL RBW:1000.000KHz VBW:1.000KHz SWT:Auto Detector : Peak</p>	<p>Site : 03CH11-HY Condition : FCC CLASS-B (AVG) 3m HORN 9120D-HF VERTICAL RBW:1000.000KHz VBW:1.000KHz SWT:Auto Detector : Peak</p>

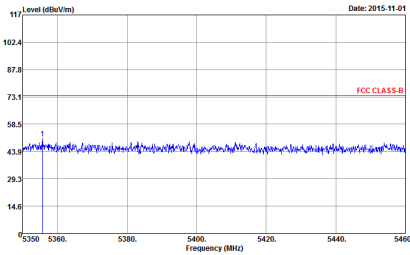
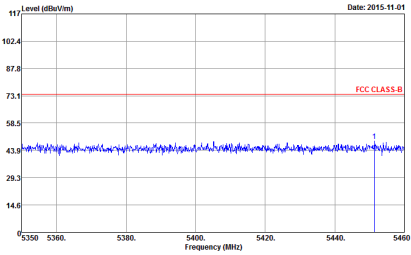
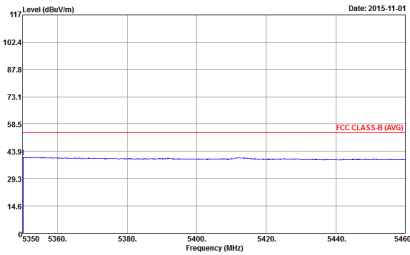
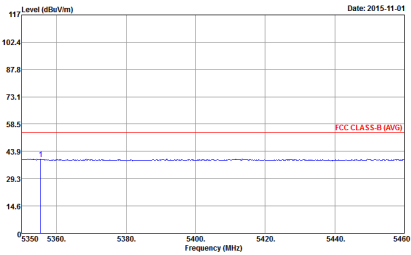

WIFI	Band 2 5250~5350MHz Band Edge @ 3m	
ANT	802.11n HT20 CH52 5260MHz - R	
1	Horizontal	Vertical
Peak	 <p>Site : 03CH11-HY Condition : FCC CLASS-B 3m HORN 9120D-HF HORIZONTAL RBW:1000.000KHz VBW:3000.000KHz SWT:Auto Detector : Peak</p>	 <p>Site : 03CH11-HY Condition : FCC CLASS-B 3m HORN 9120D-HF VERTICAL RBW:1000.000KHz VBW:3000.000KHz SWT:Auto Detector : Peak</p>
Avg.	 <p>Site : 03CH11-HY Condition : FCC CLASS-B (AVG) 3m HORN 9120D-HF HORIZONTAL RBW:1000.000KHz VBW:1.000KHz SWT:Auto Detector : Peak</p>	 <p>Site : 03CH11-HY Condition : FCC CLASS-B (AVG) 3m HORN 9120D-HF VERTICAL RBW:1000.000KHz VBW:1.000KHz SWT:Auto Detector : Peak</p>

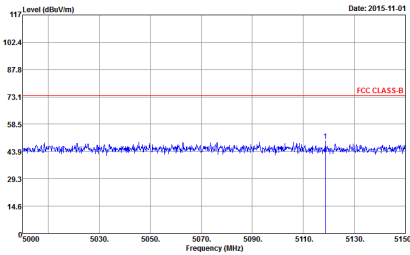
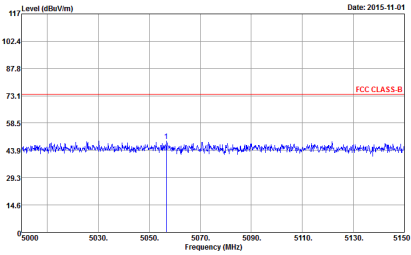
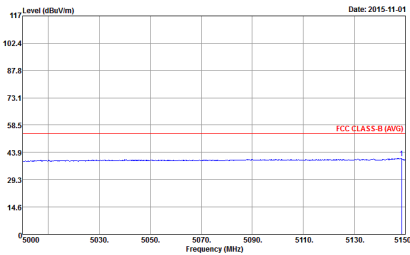
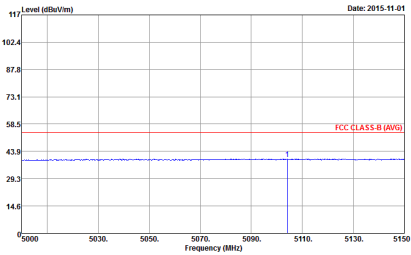

WIFI	Band 2 5250~5350MHz Band Edge @ 3m	
ANT	802.11n HT20 CH60 5300MHz - L	
1	Horizontal	Vertical
Peak	 <p>Site : 03CH11-HY Condition : FCC CLASS-B 3m HORN 9120D-HF HORIZONTAL RBW:1000.000KHz VBW:3000.000KHz SWT:Auto Detector : Peak</p>	 <p>Site : 03CH11-HY Condition : FCC CLASS-B 3m HORN 9120D-HF VERTICAL RBW:1000.000KHz VBW:3000.000KHz SWT:Auto Detector : Peak</p>
Avg.	 <p>Site : 03CH11-HY Condition : FCC CLASS-B (AVG) 3m HORN 9120D-HF HORIZONTAL RBW:1000.000KHz VBW:1.000KHz SWT:Auto Detector : Peak</p>	 <p>Site : 03CH11-HY Condition : FCC CLASS-B (AVG) 3m HORN 9120D-HF VERTICAL RBW:1000.000KHz VBW:1.000KHz SWT:Auto Detector : Peak</p>



WIFI	Band 2 5250~5350MHz Band Edge @ 3m	
ANT	802.11n HT20 CH60 5300MHz - R	
1	Horizontal	Vertical
Peak	<p>Site : 03CH11-HY Condition : FCC CLASS-B 3m HORN 9120D-HF HORIZONTAL RBW:1000.000KHz VBW:3000.000KHz SWT:Auto Detector : Peak</p>	<p>Site : 03CH11-HY Condition : FCC CLASS-B 3m HORN 9120D-HF VERTICAL RBW:1000.000KHz VBW:3000.000KHz SWT:Auto Detector : Peak</p>
Avg.	<p>Site : 03CH11-HY Condition : FCC CLASS-B (AVG) 3m HORN 9120D-HF HORIZONTAL RBW:1000.000KHz VBW:1.000KHz SWT:Auto Detector : Peak</p>	<p>Site : 03CH11-HY Condition : FCC CLASS-B (AVG) 3m HORN 9120D-HF VERTICAL RBW:1000.000KHz VBW:1.000KHz SWT:Auto Detector : Peak</p>

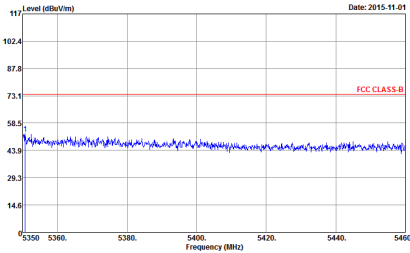
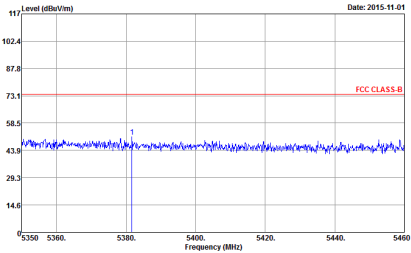
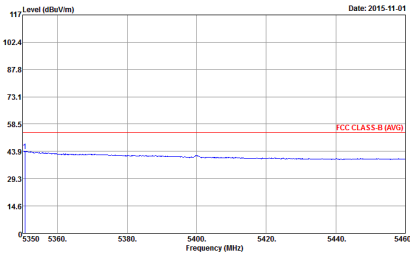
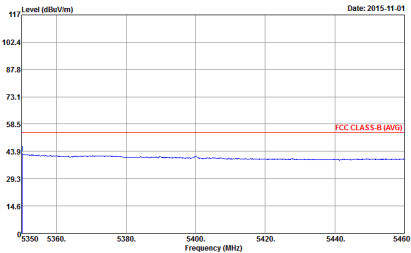

WIFI	Band 2 5250~5350MHz Band Edge @ 3m	
ANT	802.11n HT20 CH64 5320MHz	
1	Horizontal	Vertical
Peak	 <p>Site : 03CH11-HY Condition : FCC CLASS-B 3m HORN 9120D-HF HORIZONTAL RBW:1000.000KHz VBW:3000.000KHz SWT:Auto Detector : Peak</p>	 <p>Site : 03CH11-HY Condition : FCC CLASS-B 3m HORN 9120D-HF VERTICAL RBW:1000.000KHz VBW:3000.000KHz SWT:Auto Detector : Peak</p>
Avg.	 <p>Site : 03CH11-HY Condition : FCC CLASS-B (AVG) 3m HORN 9120D-HF HORIZONTAL RBW:1000.000KHz VBW:1.000KHz SWT:Auto Detector : Peak</p>	 <p>Site : 03CH11-HY Condition : FCC CLASS-B (AVG) 3m HORN 9120D-HF VERTICAL RBW:1000.000KHz VBW:1.000KHz SWT:Auto Detector : Peak</p>



**Band 2 5250~5350MHz
WIFI 802.11n HT40 (Band Edge @ 3m)**

WIFI	Band 2 5250~5350MHz Band Edge @ 3m	
ANT	802.11n HT40 CH54 5270 - L	
1	Horizontal	Vertical
Peak	<p>Site : 03CH11-HY Condition : FCC CLASS-B 3m HORN 9120D-HF HORIZONTAL Detector : Peak</p>	<p>Site : 03CH11-HY Condition : FCC CLASS-B 3m HORN 9120D-HF VERTICAL Detector : Peak</p>
Avg.	<p>Site : 03CH11-HY Condition : FCC CLASS-B (AVG) 3m HORN 9120D-HF HORIZONTAL Detector : Peak</p>	<p>Site : 03CH11-HY Condition : FCC CLASS-B (AVG) 3m HORN 9120D-HF VERTICAL Detector : Peak</p>

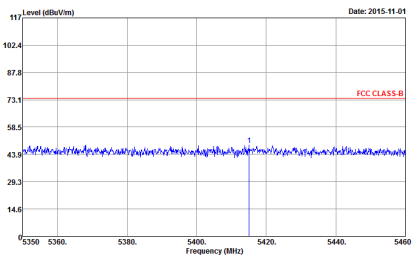
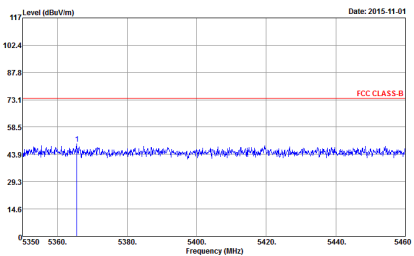
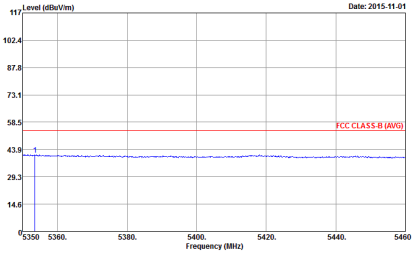
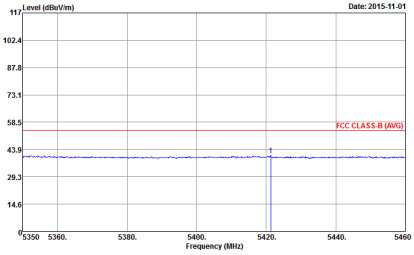

WIFI	Band 2 5250~5350MHz Band Edge @ 3m	
ANT	802.11n HT40 CH54 5270 - R	
1	Horizontal	Vertical
Peak	 <p>Site : 03CH11-HY Condition : FCC CLASS-B 3m HORN 9120D-HF HORIZONTAL RBW:1000.000KHz VBW:3000.000KHz SWT:Auto Detector : Peak</p>	 <p>Site : 03CH11-HY Condition : FCC CLASS-B 3m HORN 9120D-HF VERTICAL RBW:1000.000KHz VBW:3000.000KHz SWT:Auto Detector : Peak</p>
Avg.	 <p>Site : 03CH11-HY Condition : FCC CLASS-B (AVG) 3m HORN 9120D-HF HORIZONTAL RBW:1000.000KHz VBW:3.000KHz SWT:Auto Detector : Peak</p>	 <p>Site : 03CH11-HY Condition : FCC CLASS-B (AVG) 3m HORN 9120D-HF VERTICAL RBW:1000.000KHz VBW:3.000KHz SWT:Auto Detector : Peak</p>

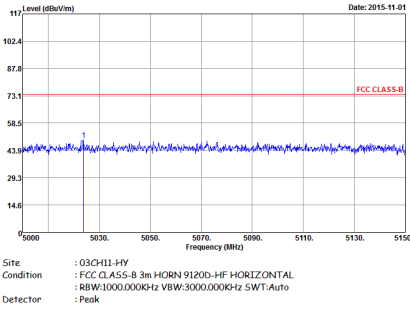
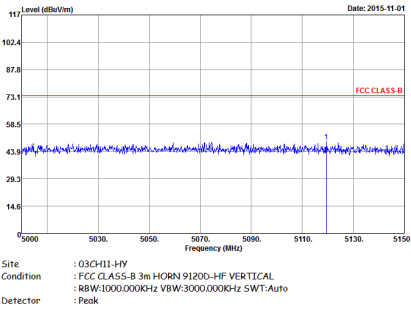
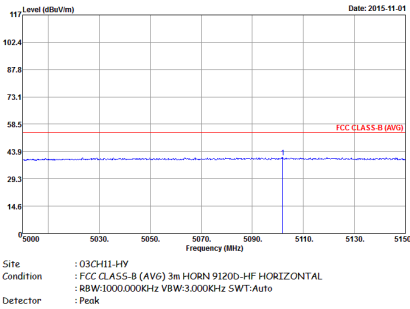
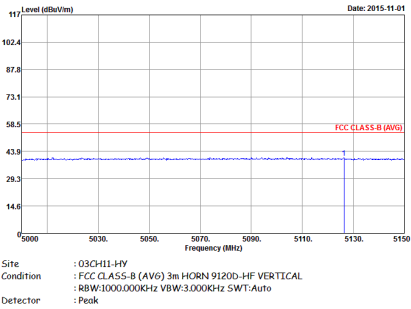

WIFI	Band 2 5250~5350MHz Band Edge @ 3m	
ANT	802.11n HT40 CH62 5310 - L	
1	Horizontal	Vertical
Peak	 <p>Site : 03GH11-HY Condition : FCC CLASS-B 3m HORN 9120D-HF HORIZONTAL RBW:1000.000KHz VBW:3000.000KHz SWT:Auto Detector : Peak</p>	 <p>Site : 03GH11-HY Condition : FCC CLASS-B 3m HORN 9120D-HF VERTICAL RBW:1000.000KHz VBW:3000.000KHz SWT:Auto Detector : Peak</p>
Avg.	 <p>Site : 03GH11-HY Condition : FCC CLASS-B (AVG) 3m HORN 9120D-HF HORIZONTAL RBW:1000.000KHz VBW:3.000KHz SWT:Auto Detector : Peak</p>	 <p>Site : 03GH11-HY Condition : FCC CLASS-B (AVG) 3m HORN 9120D-HF VERTICAL RBW:1000.000KHz VBW:3.000KHz SWT:Auto Detector : Peak</p>

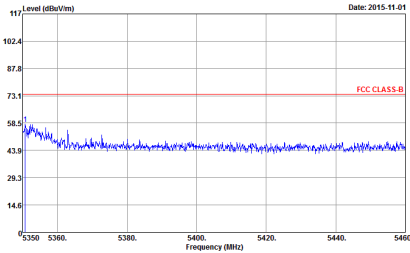
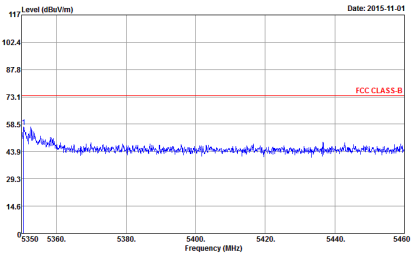
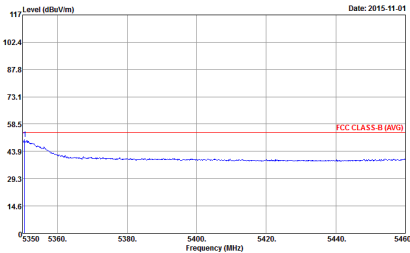
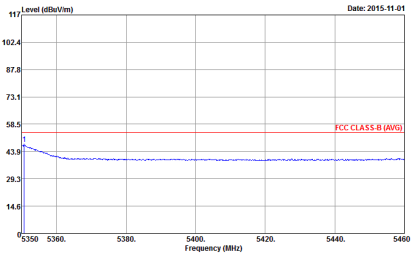

WIFI	Band 2 5250~5350MHz Band Edge @ 3m	
ANT	802.11n HT40 CH62 5310 - R	
1	Horizontal	Vertical
Peak	 <p>Site : 03CH11-HY Condition : FCC CLASS-B 3m HORN 9120D-HF HORIZONTAL RBW:1000.000KHz VBW:3000.000KHz SWT:Auto Detector : Peak</p>	 <p>Site : 03CH11-HY Condition : FCC CLASS-B 3m HORN 9120D-HF VERTICAL RBW:1000.000KHz VBW:3000.000KHz SWT:Auto Detector : Peak</p>
Avg.	 <p>Site : 03CH11-HY Condition : FCC CLASS-B (AVG) 3m HORN 9120D-HF HORIZONTAL RBW:1000.000KHz VBW:3.000KHz SWT:Auto Detector : Peak</p>	 <p>Site : 03CH11-HY Condition : FCC CLASS-B (AVG) 3m HORN 9120D-HF VERTICAL RBW:1000.000KHz VBW:3.000KHz SWT:Auto Detector : Peak</p>



Band 2 - 5250~5350MHz
WIFI 802.11a (Harmonic @ 3m)

Table with 3 columns: WIFI, ANT, and measurement results for Horizontal and Vertical orientations. Includes two graphs showing Level (dBuV/m) vs Frequency (MHz) with FCC CLASS-B and FCC CLASS-B (AVG) limits.



WIFI	Band 2 5250~5350MHz Harmonic @ 3m	
ANT	802.11a CH60 5300MHz	
1	Horizontal	Vertical
<p>Peak</p> <p>Avg.</p>	<p>Site : 03CH11-HY Condition : FCC CLASS-B 3m 9170 SHF HORM_150809 HORIZONTAL Detector : Peak</p>	<p>Site : 03CH11-HY Condition : FCC CLASS-B 3m 9170 SHF HORM_150809 VERTICAL Detector : Peak</p>

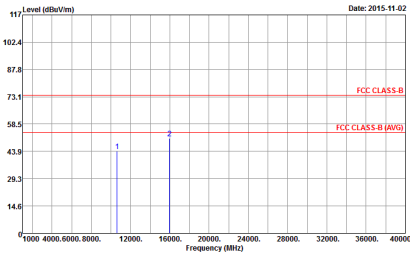
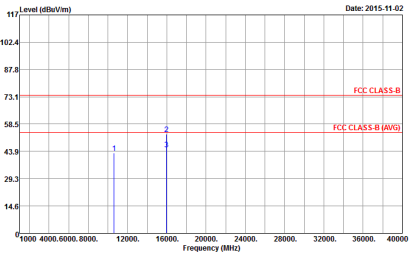

WIFI	Band 2 5250~5350MHz Harmonic @ 3m	
ANT	802.11a CH64 5320MHz	
1	Horizontal	Vertical
<p>Peak</p> <p>Avg.</p>	 <p>Site : 03CH11-HY Condition : FCC CLASS-B 3m 9170 SHF HORM_150809 HORIZONTAL Detector : Peak</p>	 <p>Site : 03CH11-HY Condition : FCC CLASS-B 3m 9170 SHF HORM_150809 VERTICAL Detector : Peak</p>



Band 2 5250~5350MHz
WIFI 802.11n HT20 (Harmonic @ 3m)

WIFI	Band 2 5250~5350MHz Harmonic @ 3m	
ANT	802.11n HT20 CH52 5260MHz	
1	Horizontal	Vertical
<p>Peak Avg.</p>	<p>Site : 03GH11-HY Condition : FCC CLASS-B 3m 9170 SHF HORM_150809 HORIZONTAL Detector : Peak</p>	<p>Site : 03GH11-HY Condition : FCC CLASS-B 3m 9170 SHF HORM_150809 VERTICAL Detector : Peak</p>



WIFI	Band 2 5250~5350MHz Harmonic @ 3m	
ANT	802.11n HT20 CH60 5300MHz	
1	Horizontal	Vertical
<p>Peak Avg.</p>	<p>Site : 03CH11-HY Condition : FCC CLASS-B 3m 9170 SHF HORM_150809 HORIZONTAL Detector : Peak</p>	<p>Site : 03CH11-HY Condition : FCC CLASS-B 3m 9170 SHF HORM_150809 VERTICAL Detector : Peak</p>



WIFI	Band 2 5250~5350MHz Harmonic @ 3m	
ANT	802.11n HT20 CH64 5320MHz	
1	Horizontal	Vertical
<p>Peak</p> <p>Avg.</p>	<p>Site : 03CH11-HY Condition : FCC CLASS-B 3m 9170 SHF HORM_150809 HORIZONTAL Detector : Peak</p>	<p>Site : 03CH11-HY Condition : FCC CLASS-B 3m 9170 SHF HORM_150809 VERTICAL Detector : Peak</p>



Band 2 5250~5350MHz
WIFI 802.11n HT40 (Harmonic @ 3m)

WIFI	Band 2 5250~5350MHz Harmonic @ 3m	
ANT	802.11n HT40 CH54 5270	
1	Horizontal	Vertical
Peak Avg.	<p>Site : 03GH11-HY Condition : FCC CLASS-B 3m 9170 SHF HORM_150809 HORIZONTAL Detector : Peak Project : FR 500716</p>	<p>Site : 03GH11-HY Condition : FCC CLASS-B 3m 9170 SHF HORM_150809 VERTICAL Detector : Peak</p>

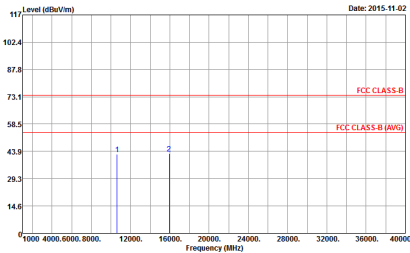
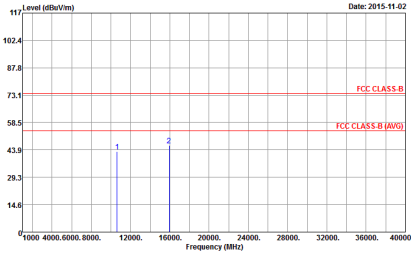

WIFI	Band 2 5250~5350MHz Harmonic @ 3m	
ANT	802.11n HT40 CH62 5310	
1	Horizontal	Vertical
<p>Peak Avg.</p>	 <p>Site : 03CH11-HY Condition : FCC CLASS-B 3m 9170 SHF HORM_150809 HORIZONTAL Detector : Peak</p>	 <p>Site : 03CH11-HY Condition : FCC CLASS-B 3m 9170 SHF HORM_150809 VERTICAL Detector : Peak</p>



Band 3 - 5470~5725MHz
WIFI 802.11a (Band Edge @ 3m)

WIFI	Band 3 5470~5725MHz Band Edge @ 3m	
ANT	802.11a CH100 5500MHz	
1	Horizontal	Vertical
Peak	<p>Site : 03CH11-HY Condition : FCC CLASS-B 3m HORN 9120D-HF HORIZONTAL Detector : Peak</p>	<p>Site : 03CH11-HY Condition : FCC CLASS-B 3m HORN 9120D-HF VERTICAL Detector : Peak</p>
Avg.	<p>Site : 03CH11-HY Condition : FCC CLASS-B (AVG) 3m HORN 9120D-HF HORIZONTAL Detector : Peak</p>	<p>Site : 03CH11-HY Condition : FCC CLASS-B (AVG) 3m HORN 9120D-HF VERTICAL Detector : Peak</p>

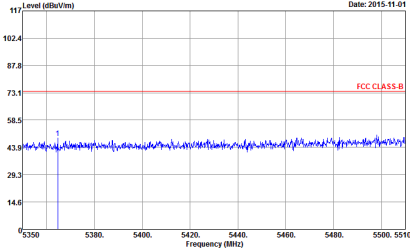
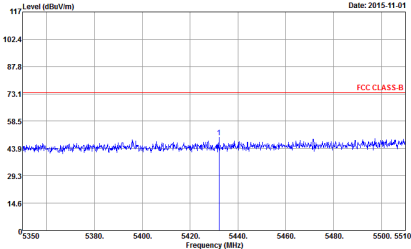
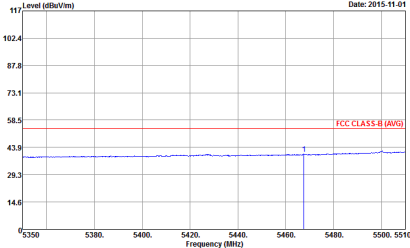
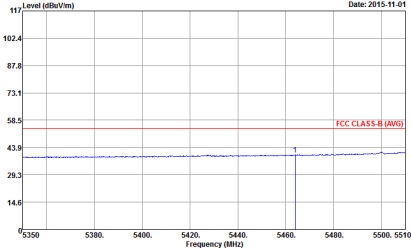

WIFI	Band 3 5470~5725MHz Band Edge @ 3m	
ANT	802.11a CH116 5580MHz - L	
1	Horizontal	Vertical
Peak	 <p>Date: 2015-11-01</p> <p>Site : 03CH11-HY Condition : FCC CLASS-B 3m HORN 9120D-HF HORIZONTAL RBW:1000.000KHz VBW:3000.000KHz SWT:Auto Detector : Peak</p>	 <p>Date: 2015-11-01</p> <p>Site : 03CH11-HY Condition : FCC CLASS-B 3m HORN 9120D-HF VERTICAL RBW:1000.000KHz VBW:3000.000KHz SWT:Auto Detector : Peak</p>
Avg.	 <p>Date: 2015-11-01</p> <p>Site : 03CH11-HY Condition : FCC CLASS-B (AVG) 3m HORN 9120D-HF HORIZONTAL RBW:1000.000KHz VBW:1.000KHz SWT:Auto Detector : Peak</p>	 <p>Date: 2015-11-01</p> <p>Site : 03CH11-HY Condition : FCC CLASS-B (AVG) 3m HORN 9120D-HF VERTICAL RBW:1000.000KHz VBW:1.000KHz SWT:Auto Detector : Peak</p>

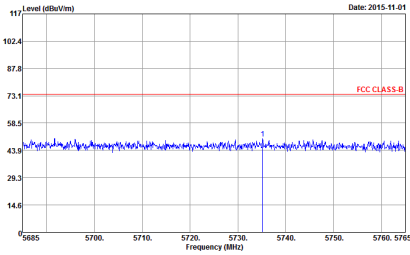
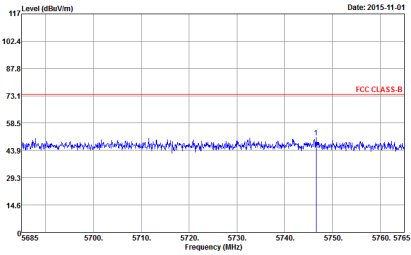
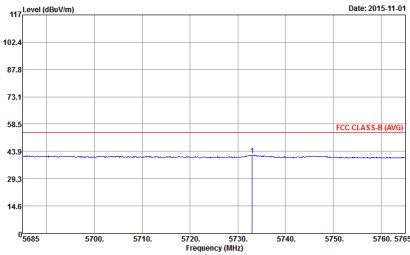
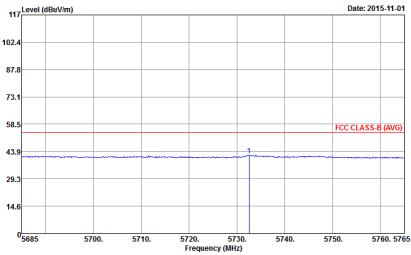

WIFI	Band 3 5470~5725MHz Band Edge @ 3m	
ANT	802.11a CH116 5580MHz - R	
1	Horizontal	Vertical
Peak	 <p>Site : 03CH11-HY Condition : FCC CLASS-B 3m HORN 9120D-HF HORIZONTAL RBW:1000.000KHz VBW:3000.000KHz SWT:Auto Detector : Peak</p>	 <p>Site : 03CH11-HY Condition : FCC CLASS-B 3m HORN 9120D-HF VERTICAL RBW:1000.000KHz VBW:3000.000KHz SWT:Auto Detector : Peak</p>
Avg.	 <p>Site : 03CH11-HY Condition : FCC CLASS-B (AVG) 3m HORN 9120D-HF HORIZONTAL RBW:1000.000KHz VBW:1.000KHz SWT:Auto Detector : Peak</p>	 <p>Site : 03CH11-HY Condition : FCC CLASS-B (AVG) 3m HORN 9120D-HF VERTICAL RBW:1000.000KHz VBW:1.000KHz SWT:Auto Detector : Peak</p>



WIFI	Band 3 5470~5725MHz Band Edge @ 3m	
ANT	802.11a CH140 5700MHz	
1	Horizontal	Vertical
Peak	<p>Site : 03CH11-HY Condition : FCC CLASS-B 3m HORN 9120D-HF HORIZONTAL RBW:1000.000KHz VBW:3000.000KHz SWT:Auto Detector : Peak</p>	<p>Site : 03CH11-HY Condition : FCC CLASS-B 3m HORN 9120D-HF VERTICAL RBW:1000.000KHz VBW:3000.000KHz SWT:Auto Detector : Peak</p>
Avg.	<p>Site : 03CH11-HY Condition : FCC CLASS-B (AVG) 3m HORN 9120D-HF HORIZONTAL RBW:1000.000KHz VBW:1.000KHz SWT:Auto Detector : Peak</p>	<p>Site : 03CH11-HY Condition : FCC CLASS-B (AVG) 3m HORN 9120D-HF VERTICAL RBW:1000.000KHz VBW:1.000KHz SWT:Auto Detector : Peak</p>



Band 3 5470~5725MHz
WIFI 802.11n HT20 (Band Edge @ 3m)

Table with 4 columns: WIFI, ANT, 1, and two sub-columns for Horizontal and Vertical. Rows are labeled Peak and Avg. Each cell contains a spectral plot and technical details like Site, Condition, RBW, and Detector.

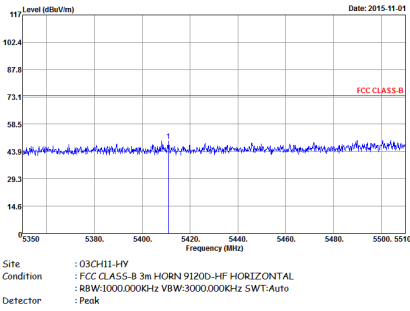
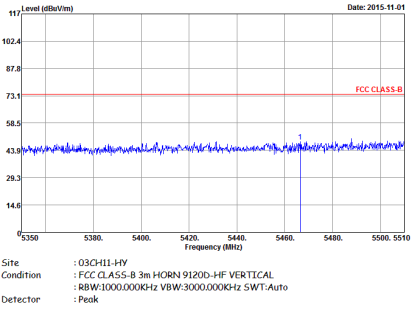
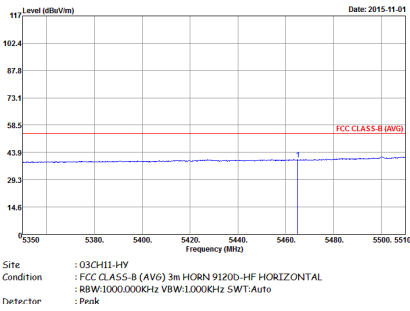
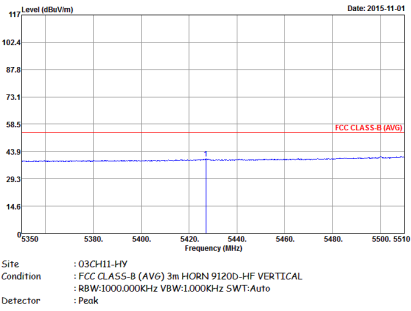

WIFI	Band 3 5470~5725MHz Band Edge @ 3m	
ANT	802.11n HT20 CH116 5580MHz - L	
1	Horizontal	Vertical
Peak	 <p>Site : 03CH11-HY Condition : FCC CLASS-B 3m HORN 9120D-HF HORIZONTAL RBW:1000.000KHz VBW:3000.000KHz SWT:Auto Detector : Peak</p>	 <p>Site : 03CH11-HY Condition : FCC CLASS-B 3m HORN 9120D-HF VERTICAL RBW:1000.000KHz VBW:3000.000KHz SWT:Auto Detector : Peak</p>
Avg.	 <p>Site : 03CH11-HY Condition : FCC CLASS-B (AVG) 3m HORN 9120D-HF HORIZONTAL RBW:1000.000KHz VBW:1.000KHz SWT:Auto Detector : Peak</p>	 <p>Site : 03CH11-HY Condition : FCC CLASS-B (AVG) 3m HORN 9120D-HF VERTICAL RBW:1000.000KHz VBW:1.000KHz SWT:Auto Detector : Peak</p>

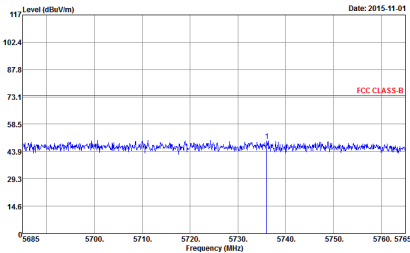
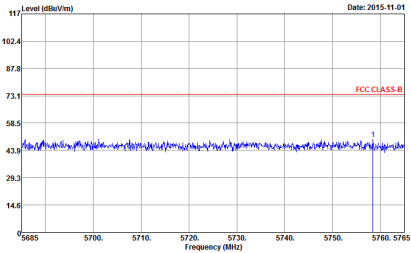
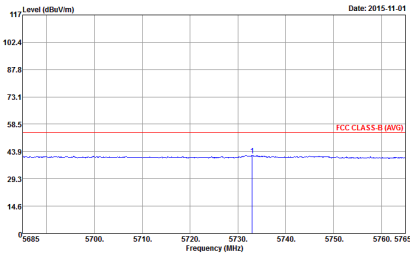
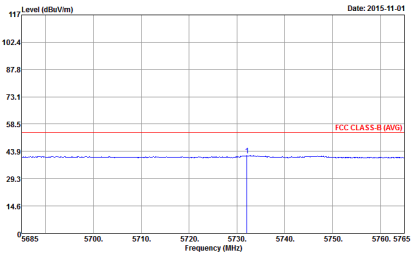

WIFI	Band 3 5470~5725MHz Band Edge @ 3m	
ANT	802.11n HT20 CH116 5580MHz - R	
1	Horizontal	Vertical
Peak	 <p>Level (dBuV/m) vs Frequency (MHz) plot for Horizontal orientation. The y-axis ranges from 14.6 to 117 dBuV/m, and the x-axis ranges from 5685 to 5765 MHz. A red horizontal line indicates the FCC CLASS-B limit at 73.1 dBuV/m. A blue signal trace shows a peak at approximately 5730 MHz, reaching about 73.1 dBuV/m. A vertical blue line with a '1' marker points to this peak.</p> <p>Site : 03CH11-HY Condition : FCC CLASS-B 3m HORN 9120D-HF HORIZONTAL RBW:1000.000KHz VBW:3000.000KHz SWT:Auto Detector : Peak</p>	 <p>Level (dBuV/m) vs Frequency (MHz) plot for Vertical orientation. The y-axis ranges from 14.6 to 117 dBuV/m, and the x-axis ranges from 5685 to 5765 MHz. A red horizontal line indicates the FCC CLASS-B limit at 73.1 dBuV/m. A blue signal trace shows a peak at approximately 5730 MHz, reaching about 73.1 dBuV/m. A vertical blue line with a '1' marker points to this peak.</p> <p>Site : 03CH11-HY Condition : FCC CLASS-B 3m HORN 9120D-HF VERTICAL RBW:1000.000KHz VBW:3000.000KHz SWT:Auto Detector : Peak</p>
Avg.	 <p>Level (dBuV/m) vs Frequency (MHz) plot for Horizontal orientation showing the average signal. The y-axis ranges from 14.6 to 117 dBuV/m, and the x-axis ranges from 5685 to 5765 MHz. A red horizontal line indicates the FCC CLASS-B (AVG) limit at 58.5 dBuV/m. A blue signal trace shows a peak at approximately 5730 MHz, reaching about 58.5 dBuV/m. A vertical blue line with a '1' marker points to this peak.</p> <p>Site : 03CH11-HY Condition : FCC CLASS-B (AVG) 3m HORN 9120D-HF HORIZONTAL RBW:1000.000KHz VBW:1.000KHz SWT:Auto Detector : Peak</p>	 <p>Level (dBuV/m) vs Frequency (MHz) plot for Vertical orientation showing the average signal. The y-axis ranges from 14.6 to 117 dBuV/m, and the x-axis ranges from 5685 to 5765 MHz. A red horizontal line indicates the FCC CLASS-B (AVG) limit at 58.5 dBuV/m. A blue signal trace shows a peak at approximately 5730 MHz, reaching about 58.5 dBuV/m. A vertical blue line with a '1' marker points to this peak.</p> <p>Site : 03CH11-HY Condition : FCC CLASS-B (AVG) 3m HORN 9120D-HF VERTICAL RBW:1000.000KHz VBW:1.000KHz SWT:Auto Detector : Peak</p>



WIFI	Band 3 5470~5725MHz Band Edge @ 3m	
ANT	802.11n HT20 CH140 5700MHz	
1	Horizontal	Vertical
Peak	<p>Date: 2015-11-01</p> <p>Site : 03CH11-HY Condition : FCC CLASS-B 3m HORN 9120D-HF HORIZONTAL RBW:1000.000KHz VBW:3000.000KHz SWT:Auto Detector : Peak</p>	<p>Date: 2015-11-01</p> <p>Site : 03CH11-HY Condition : FCC CLASS-B 3m HORN 9120D-HF VERTICAL RBW:1000.000KHz VBW:3000.000KHz SWT:Auto Detector : Peak</p>
Avg.	<p>Date: 2015-11-01</p> <p>Site : 03CH11-HY Condition : FCC CLASS-B (AVG) 3m HORN 9120D-HF HORIZONTAL RBW:1000.000KHz VBW:1.000KHz SWT:Auto Detector : Peak</p>	<p>Date: 2015-11-01</p> <p>Site : 03CH11-HY Condition : FCC CLASS-B (AVG) 3m HORN 9120D-HF VERTICAL RBW:1000.000KHz VBW:1.000KHz SWT:Auto Detector : Peak</p>



Band 3 5470~5725MHz
WIFI 802.11n HT40 (Band Edge @ 3m)

Table with 4 columns: WIFI, ANT, 1, and two sub-columns for Horizontal and Vertical. Rows are labeled Peak and Avg. Each cell contains a spectral plot and technical details like Site, Condition, RBW, and Detector.

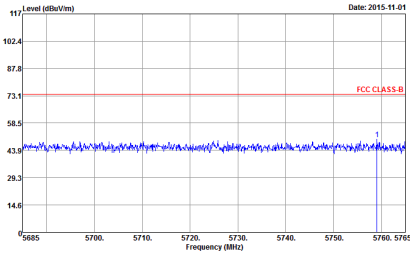
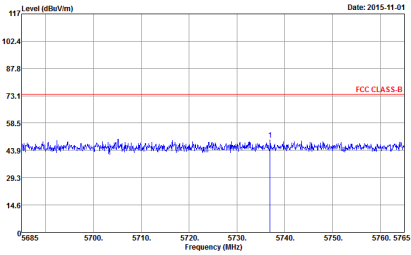
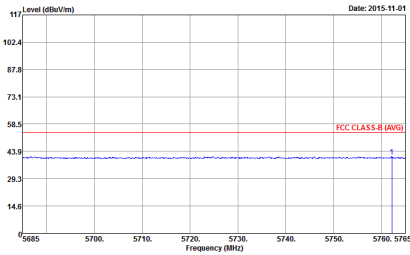
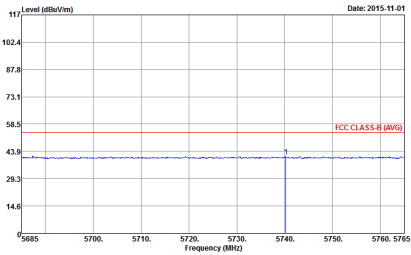

WIFI	Band 3 5470~5725MHz Band Edge @ 3m	
ANT	802.11n HT40 CH102 5510MHz - R	
1	Horizontal	Vertical
Peak	 <p>Site : 03CH11-HY Condition : FCC CLASS-B 3m HORN 9120D-HF HORIZONTAL RBW:1000.000KHz VBW:3000.000KHz SWT:Auto Detector : Peak</p>	 <p>Site : 03CH11-HY Condition : FCC CLASS-B 3m HORN 9120D-HF VERTICAL RBW:1000.000KHz VBW:3000.000KHz SWT:Auto Detector : Peak</p>
Avg.	 <p>Site : 03CH11-HY Condition : FCC CLASS-B (AVG) 3m HORN 9120D-HF HORIZONTAL RBW:1000.000KHz VBW:3.000KHz SWT:Auto Detector : Peak</p>	 <p>Site : 03CH11-HY Condition : FCC CLASS-B (AVG) 3m HORN 9120D-HF VERTICAL RBW:1000.000KHz VBW:3.000KHz SWT:Auto Detector : Peak</p>

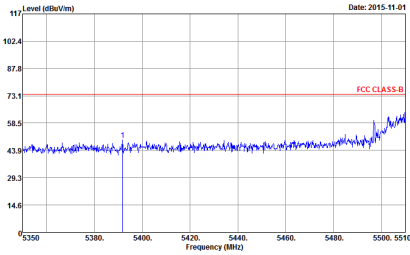
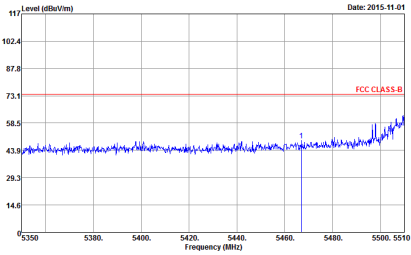
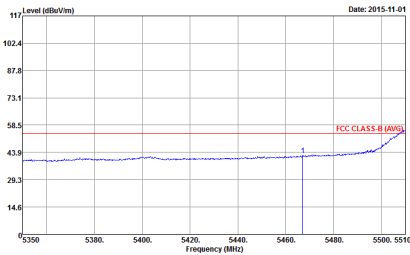
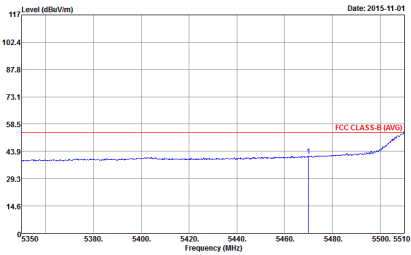

WIFI	Band 3 5470~5725MHz Band Edge @ 3m	
ANT	802.11n HT40 CH110 5550MHz - L	
1	Horizontal	Vertical
Peak	 <p>Date: 2015-11-01</p> <p>Site : 03CH11-HY Condition : FCC CLASS-B 3m HORN 9120D-HF HORIZONTAL RBW:1000.000KHz VBW:3000.000KHz SWT:Auto Detector : Peak</p>	 <p>Date: 2015-11-01</p> <p>Site : 03CH11-HY Condition : FCC CLASS-B 3m HORN 9120D-HF VERTICAL RBW:1000.000KHz VBW:3000.000KHz SWT:Auto Detector : Peak</p>
Avg.	 <p>Date: 2015-11-01</p> <p>Site : 03CH11-HY Condition : FCC CLASS-B (AVG) 3m HORN 9120D-HF HORIZONTAL RBW:1000.000KHz VBW:3.000KHz SWT:Auto Detector : Peak</p>	 <p>Date: 2015-11-01</p> <p>Site : 03CH11-HY Condition : FCC CLASS-B (AVG) 3m HORN 9120D-HF VERTICAL RBW:1000.000KHz VBW:3.000KHz SWT:Auto Detector : Peak</p>

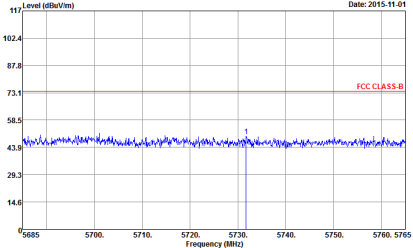
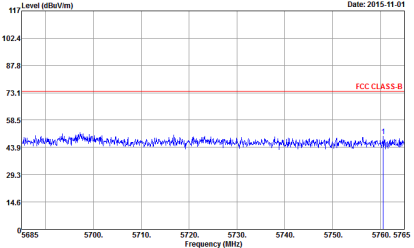
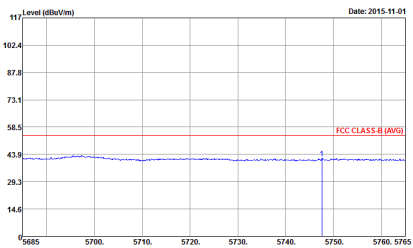
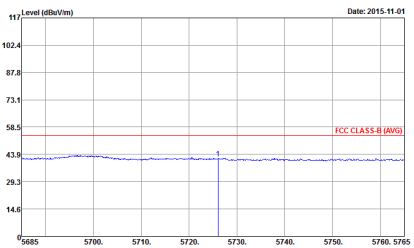

WIFI	Band 3 5470~5725MHz Band Edge @ 3m	
ANT	802.11n HT40 CH110 5550MHz - R	
1	Horizontal	Vertical
Peak	 <p>Site : 03CH11-HY Condition : FCC CLASS-B 3m HORN 9120D-HF HORIZONTAL RBW:1000.000KHz VBW:3000.000KHz SWT:Auto Detector : Peak</p>	 <p>Site : 03CH11-HY Condition : FCC CLASS-B 3m HORN 9120D-HF VERTICAL RBW:1000.000KHz VBW:3000.000KHz SWT:Auto Detector : Peak</p>
Avg.	 <p>Site : 03CH11-HY Condition : FCC CLASS-B (AVG) 3m HORN 9120D-HF HORIZONTAL RBW:1000.000KHz VBW:3.000KHz SWT:Auto Detector : Peak</p>	 <p>Site : 03CH11-HY Condition : FCC CLASS-B (AVG) 3m HORN 9120D-HF VERTICAL RBW:1000.000KHz VBW:3.000KHz SWT:Auto Detector : Peak</p>



WIFI	Band 3 5470~5725MHz Band Edge @ 3m	
ANT	802.11n HT40 CH134 5670MHz - L	
1	Horizontal	Vertical
Peak	<p>Site : 03CH11-HY Condition : FCC CLASS-B 3m HORN 9120D-HF HORIZONTAL RBW:1000.000KHz VBW:3000.000KHz SWT:Auto Detector : Peak</p>	<p>Site : 03CH11-HY Condition : FCC CLASS-B 3m HORN 9120D-HF VERTICAL RBW:1000.000KHz VBW:3000.000KHz SWT:Auto Detector : Peak</p>
Avg.	<p>Site : 03CH11-HY Condition : FCC CLASS-B (AVG) 3m HORN 9120D-HF HORIZONTAL RBW:1000.000KHz VBW:3.000KHz SWT:Auto Detector : Peak</p>	<p>Site : 03CH11-HY Condition : FCC CLASS-B (AVG) 3m HORN 9120D-HF VERTICAL RBW:1000.000KHz VBW:3.000KHz SWT:Auto Detector : Peak</p>

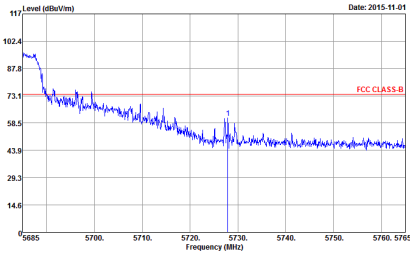
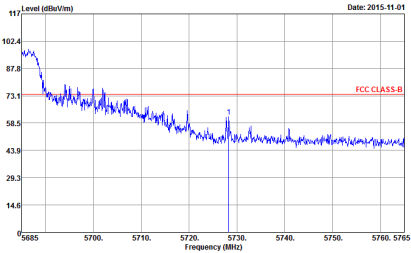
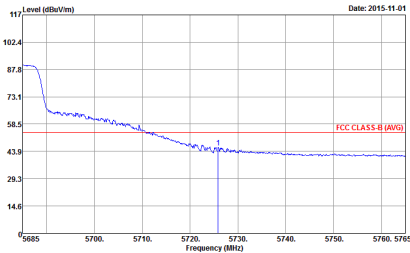
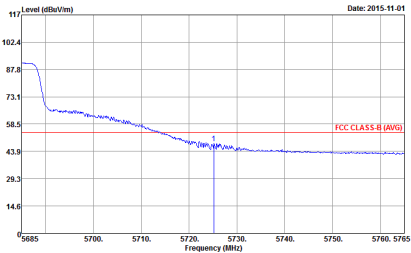

WIFI	Band 3 5470~5725MHz Band Edge @ 3m	
ANT	802.11n HT40 CH134 5670MHz - R	
1	Horizontal	Vertical
Peak	 <p>Site : 03CH11-HY Condition : FCC CLASS-B 3m HORN 9120D-HF HORIZONTAL RBW:1000.000KHz VBW:3000.000KHz SWT:Auto Detector : Peak</p>	 <p>Site : 03CH11-HY Condition : FCC CLASS-B 3m HORN 9120D-HF VERTICAL RBW:1000.000KHz VBW:3000.000KHz SWT:Auto Detector : Peak</p>
Avg.	 <p>Site : 03CH11-HY Condition : FCC CLASS-B (AVG) 3m HORN 9120D-HF HORIZONTAL RBW:1000.000KHz VBW:3.000KHz SWT:Auto Detector : Peak</p>	 <p>Site : 03CH11-HY Condition : FCC CLASS-B (AVG) 3m HORN 9120D-HF VERTICAL RBW:1000.000KHz VBW:3.000KHz SWT:Auto Detector : Peak</p>



Band 3 - 5470~5725MHz
WIFI 802.11a (Harmonic @ 3m)

Table with 3 columns: WIFI, ANT, and antenna orientation (Horizontal/Vertical). It contains two spectral plots showing Level (dBuV/m) vs Frequency (MHz) for FCC CLASS-B and FCC CLASS-B (AVG) limits. The plots show two peaks labeled 1 and 2, both well below the limits.



WIFI	Band 3 5470~5725MHz Harmonic @ 3m	
ANT	802.11a CH116 5580MHz	
1	Horizontal	Vertical
Peak Avg.	<p>Site : 03CH11-HY Condition : FCC CLASS-B 3m 9170 SHF HORM_150809 HORIZONTAL Detector : Peak</p>	<p>Site : 03CH11-HY Condition : FCC CLASS-B 3m 9170 SHF HORM_150809 VERTICAL Detector : Peak</p>



WIFI	Band 3 5470~5725MHz Harmonic @ 3m	
ANT	802.11a CH140 5700MHz	
1	Horizontal	Vertical
Peak Avg.	<p>Site : 03CH11-HY Condition : FCC CLASS-B 3m 9170 SHF HORM_150809 HORIZONTAL Detector : Peak</p>	<p>Site : 03CH11-HY Condition : FCC CLASS-B 3m 9170 SHF HORM_150809 VERTICAL Detector : Peak</p>



**Band 3 5470~5725MHz
WIFI 802.11n HT20 (Harmonic @ 3m)**

WIFI	Band 3 5470~5725MHz Harmonic @ 3m	
ANT	802.11n HT20 CH100 5500MHz	
1	Horizontal	Vertical
Peak Avg.	<p>Site : 03CH11-HY Condition : FCC CLASS-B 3m 9170 SHF HORM_150809 HORIZONTAL Detector : Peak</p>	<p>Site : 03CH11-HY Condition : FCC CLASS-B 3m 9170 SHF HORM_150809 VERTICAL Detector : Peak</p>

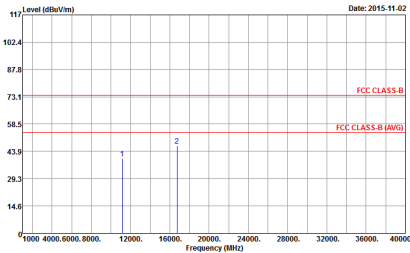
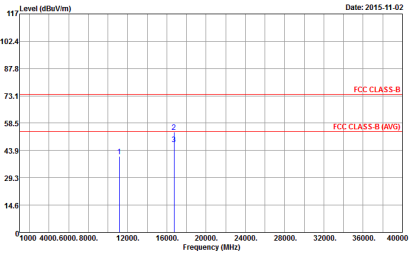

WIFI	Band 3 5470~5725MHz Harmonic @ 3m	
ANT	802.11n HT20 CH116 5580MHz	
1	Horizontal	Vertical
<p>Peak Avg.</p>	 <p>Site : 03CH11-HY Condition : FCC CLASS-B 3m 9170 SHF HORM_150809 HORIZONTAL Detector : Peak</p>	 <p>Site : 03CH11-HY Condition : FCC CLASS-B 3m 9170 SHF HORM_150809 VERTICAL Detector : Peak</p>



WIFI	Band 3 5470~5725MHz Harmonic @ 3m	
ANT	802.11n HT20 CH140 5700MHz	
1	Horizontal	Vertical
<p>Peak Avg.</p>	<p>Site : 03CH11-HY Condition : FCC CLASS-B 3m 9170 SHF HORM_150809 HORIZONTAL Detector : Peak</p>	<p>Site : 03CH11-HY Condition : FCC CLASS-B 3m 9170 SHF HORM_150809 VERTICAL Detector : Peak</p>



Band 3 5470~5725MHz
WIFI 802.11n HT40 (Harmonic @ 3m)

Table with 3 columns: WIFI, ANT, and 1. It contains two graphs: Horizontal and Vertical. Each graph plots Level (dBuV/m) vs Frequency (MHz) with FCC CLASS-B and FCC CLASS-B (AVG) limits. Includes site and condition details for each graph.



WIFI	Band 3 5470~5725MHz Harmonic @ 3m	
ANT	802.11n HT40 CH110 5550MHz	
1	Horizontal	Vertical
<p>Peak Avg.</p>	<p>Site : 03CH11-HY Condition : FCC CLASS-B 3m 9170 SHF HORM_150809 HORIZONTAL Detector : Peak</p>	<p>Site : 03CH11-HY Condition : FCC CLASS-B 3m 9170 SHF HORM_150809 VERTICAL Detector : Peak</p>



WIFI	Band 3 5470~5725MHz Harmonic @ 3m	
ANT	802.11n HT40 CH134 5670MHz	
1	Horizontal	Vertical
Peak Avg.	<p>Site : 03CH11-HY Condition : FCC CLASS-B 3m 9170 SHF HORM_150809 HORIZONTAL Detector : Peak</p>	<p>Site : 03CH11-HY Condition : FCC CLASS-B 3m 9170 SHF HORM_150809 VERTICAL Detector : Peak</p>



Emission below 1GHz
5GHz WIFI 802.11a (LF)

WIFI	5GHz WIFI	
ANT	802.11a LF	
1	Horizontal	Vertical
QP / Peak	<p>Site : 03CH11-1#Y Condition : FCC CLASS-B 3m BT-LOG 6111D-LF_ETC HORIZONTAL Detector : Peak</p>	<p>Site : 03CH11-1#Y Condition : FCC CLASS-B 3m BT-LOG 6111D-LF_ETC VERTICAL Detector : Peak</p>



Emission below 1GHz
5GHz WIFI 802.11n HT20 (LF)

WIFI	5GHz WIFI	
ANT	802.11n HT20 LF	
1	Horizontal	Vertical
QP / Peak	<p>Site : D3CH11-HY Condition : FCC CLASS-B 3m BT-LOG 6111D-LF_ETC HORIZONTAL Detector : Peak</p>	<p>Site : D3CH11-HY Condition : FCC CLASS-B 3m BT-LOG 6111D-LF_ETC VERTICAL Detector : Peak</p>



Emission below 1GHz
5GHz WIFI 802.11n HT40 (LF)

WIFI	5GHz WIFI	
ANT	802.11n HT40 LF	
1	Horizontal	Vertical
QP / Peak	<p>Site : 03CH11-HY Condition : FCC CLASS-B 3m BT-LOG 6111D-LF_ETC HORIZONTAL Detector : Peak</p>	<p>Site : 03CH11-HY Condition : FCC CLASS-B 3m BT-LOG 6111D-LF_ETC VERTICAL Detector : Peak</p>