



FCC RF Test Report

APPLICANT : Sony Mobile Communications Inc.
EQUIPMENT : GSM/WCDMA/LTE Phone + Bluetooth, DTS/UNII
a/b/g/n and NFC
BRAND NAME : Sony
FCC ID : PY7-PM0921
STANDARD : FCC Part 15 Subpart E §15.407
CLASSIFICATION : (NII) Unlicensed National Information Infrastructure

The product was received on Oct. 07, 2015 and testing was completed on Dec. 29, 2015. We, SPORTON INTERNATIONAL INC., would like to declare that the tested sample has been evaluated in accordance with the test procedures and has been in compliance with the applicable technical standards.

The test results in this report apply exclusively to the tested model / sample. Without written approval of SPORTON INTERNATIONAL INC., the test report shall not be reproduced except in full.

Reviewed by: Joseph Lin / Supervisor

Approved by: Jones Tsai / Manager



SPORTON INTERNATIONAL INC.

No. 52, Hwa Ya 1st Rd., Hwa Ya Technology Park, Kwei-Shan District, Tao Yuan City, Taiwan, R.O.C.

SPORTON INTERNATIONAL INC.

TEL : 886-3-327-3456

FAX : 886-3-328-4978

FCC ID : PY7-PM0921

Page Number : 1 of 32

Report Issued Date : Jan. 21, 2016

Report Version : Rev. 01

Report Template No.: BU5-FR15EWLB4 AC MA Version 1.1



TABLE OF CONTENTS

REVISION HISTORY 3

SUMMARY OF TEST RESULT 4

1 GENERAL DESCRIPTION 5

 1.1 Applicant 5

 1.2 Manufacturer 5

 1.3 Feature of Equipment Under Test 5

 1.4 Modification of EUT 6

 1.5 Testing Location 7

 1.6 Applicable Standards 7

2 TEST CONFIGURATION OF EQUIPMENT UNDER TEST 8

 2.1 Carrier Frequency and Channel 8

 2.2 Pre-Scanned RF Power 9

 2.3 Test Mode 10

 2.4 Connection Diagram of Test System 11

 2.5 Support Unit used in test configuration and system 12

 2.6 EUT Operation Test Setup 12

 2.7 Measurement Results Explanation Example 12

3 TEST RESULT 13

 3.1 6dB and 26dB and 99% Occupied Bandwidth Measurement 13

 3.2 Maximum Conducted Output Power Measurement 16

 3.3 Power Spectral Density Measurement 17

 3.4 Unwanted Emissions Measurement 19

 3.5 AC Conducted Emission Measurement 23

 3.6 Frequency Stability Measurement 27

 3.7 Automatically Discontinue Transmission 28

 3.8 Antenna Requirements 29

4 LIST OF MEASURING EQUIPMENT 30

5 UNCERTAINTY OF EVALUATION 32

APPENDIX A. CONDUCTED TEST RESULTS

APPENDIX B. RADIATED SPURIOUS EMISSION

APPENDIX C. RADIATED SPURIOUS EMISSION PLOTS



REVISION HISTORY

REPORT NO.	VERSION	DESCRIPTION	ISSUED DATE
FR582708-02F	Rev. 01	Initial issue of report	Jan. 21, 2016



SUMMARY OF TEST RESULT

Report Section	FCC Rule	Description	Limit	Result	Remark
3.1	15.403(i)	6dB, 26dB and 99% Occupied Bandwidth	> 500kHz	Pass	-
3.2	15.407(a)	Maximum Conducted Output Power	≤ 30 dBm	Pass	-
3.3	15.407(a)	Power Spectral Density	≤ 30 dBm/500kHz	Pass	-
3.4	15.407(b)	Unwanted Emissions	≤ -17, -27 dBm/MHz & 15.209(a)	Pass	Under limit 3.21 dB at 5711.720 MHz
3.5	15.207	AC Conducted Emission	15.207(a)	Pass	Under limit 22.40 dB at 0.182 MHz
3.6	15.407(g)	Frequency Stability	Within Operation Band	Pass	-
3.7	15.407(c)	Automatically Discontinue Transmission	Discontinue Transmission	Pass	-
3.8	15.203 & 15.407(a)	Antenna Requirement	N/A	Pass	-

Remark: The FCC ID: PY7-PM0920 and FCC ID: PY7-PM0921 is similar device, in this report all the test result are referred to PY7-PM0920, Sporton Report No: FR500716F



1 General Description

1.1 Applicant

Sony Mobile Communications Inc.
Nya Vattentorget, 22188 Lund, Sweden

1.2 Manufacturer

Sony Mobile Communications Inc.
1-8-15 Konan, Minato-ku, Tokyo, 108-0075, Japan

1.3 Feature of Equipment Under Test

GSM/WCDMA/LTE, Bluetooth, DTS/UNII a/b/g/n, NFC, and GPS

Product Specification subjective to this standard	
Antenna Type	PIFA Antenna
Antenna Gain	-1.10 dBi
HW Version	A
SW Version	33.2.B.0.19

<FR5O0716F>

EUT Information List				
IMEI	HW Version	SW Version	S/N	Performed Test Item
004402455537120	A	33.2.A.0.19	RQ3000D4EL	RF conducted measurement
004402455535371			RQ3000D4PK	radiated spurious emission
004402455535215			RQ3000D4J1	conducted emission



Accessory List	
AC Adapter 1	Model No. : UCH20
	Type No. : AC-0060-US
	S/N : 1215W43609270 (for radiated spurious emission) 1215W48600011 (for conducted emission)
Battery 1	Model No. : LIS1618ERPC
Earphone	Model No. : MH410c
	Type No. : AG-1100
	S/N : 1541A8180036E76 (for radiated spurious emission) 1541A8170036EC2 (for conducted emission)
USB Cable 1	Model No. : EC803
	Type No. : AI-0404
	S/N : 153812AF5009094 (for radiated spurious emission) 153812AA503376C (for conducted emission)

Note:

1. Above EUT list and accessory list used are electrically identical per declared by manufacturer.
2. Above the accessories list are used to exercise the EUT during test.
3. For other wireless features of this EUT, test report will be issued separately.

1.4 Modification of EUT

No modifications are made to the EUT during all test items.



1.5 Testing Location

Sporton Lab is accredited to ISO 17025 by Taiwan Accreditation Foundation (TAF code : 1190) and the FCC designation No. TW1022 under the FCC 2.948(e) by Mutual Recognition Agreement (MRA) in FCC Test.

Test Site	SPORTON INTERNATIONAL INC.	
Test Site Location	No. 52, Hwa Ya 1 st Rd., Hwa Ya Technology Park, Kwei-Shan District, Tao Yuan City, Taiwan, R.O.C. TEL: +886-3-327-3456 FAX: +886-3-328-4978	
Test Site No.	Sporton Site No.	
	TH05-HY	CO05-HY

Note: The test site complies with ANSI C63.4 2014 requirement.

Test Site	SPORTON INTERNATIONAL INC.	
Test Site Location	No.58, Aly. 75, Ln. 564, Wenhua 3rd Rd. Guishan Dist, Taoyuan City, Taiwan (R.O.C.) TEL: +886-3-327-0868 FAX: +886-3-327-0855	
Test Site No.	Sporton Site No.	
	03CH11-HY	

Note: The test site complies with ANSI C63.4 2014 requirement.

1.6 Applicable Standards

According to the specifications of the manufacturer, the EUT must comply with the requirements of the following standards:

- ♦ FCC Part 15 Subpart E
- ♦ FCC KDB 789033 D02 General UNII Test Procedures New Rules v01
- ♦ ANSI C63.10-2013

Remark:

1. All test items were verified and recorded according to the standards and without any deviation during the test.
2. FCC permits the use of the 1.5 meter table as an alternative in C63.10-2013 through inquiry tracking number 961829.



2 Test Configuration of Equipment Under Test

The EUT has been associated with peripherals and configuration operated in a manner tended to maximize its emission characteristics in a typical application. Frequency range investigated: conducted emission (150 kHz to 30 MHz) and radiated emission (9 kHz to the 10th harmonic of the highest fundamental frequency or to 40 GHz, whichever is lower). For radiated measurement, pre-scanned in three orthogonal panels, X, Y, Z. The worst cases (X plane) were recorded in this report.

The final configuration from all the combinations and the worst-case data rates were investigated by measuring the maximum power across all the data rates and modulation modes under section 2.2.

Based on the worst configuration found above, the RF power setting is set individually to meet FCC compliance limit for the final conducted and radiated tests shown in section 2.3.

2.1 Carrier Frequency and Channel

Frequency Band	Channel	Freq. (MHz)	Channel	Freq. (MHz)
5725-5850 MHz Band 4 (U-NII-3)	149	5745	157	5785
	151	5755	159	5795
	153	5765	161	5805
	155	5775	165	5825

Note: The above Frequency and Channel in boldface were 802.11n HT40.



2.2 Pre-Scanned RF Power

Preliminary tests were performed in different data rate and data rate associated with the highest power were chosen for full test in the following tables.

5GHz 802.11a mode								
Data Rate (MHz)	6M bps	9M bps	12M bps	18M bps	24M bps	36M bps	48M bps	54M bps
Average Power (dBm)	14.84	14.50	14.77	14.71	14.57	14.49	14.77	14.71

5GHz 802.11n HT20 mode								
Data Rate (MHz)	MCS0	MCS1	MCS2	MCS3	MCS4	MCS5	MCS6	MCS7
Average Power (dBm)	14.64	14.19	14.48	14.21	14.24	14.30	14.41	14.32

5GHz 802.11n HT40 mode								
Data Rate (MHz)	MCS0	MCS1	MCS2	MCS3	MCS4	MCS5	MCS6	MCS7
Average Power (dBm)	11.27	11.20	11.11	11.20	11.15	11.02	11.04	11.15



2.3 Test Mode

Final test mode of conducted test items and radiated spurious emissions are considering the modulation and worse data rates from the power table described in section 2.2.

The radiated spurious emissions testing were performed in n-mode only for HT20/40, which covers ac-mode testing.

Modulation	Data Rate
802.11a	6 Mbps
802.11n HT20	MCS0
802.11n HT40	MCS0

AC Conducted Emission	Mode 1 : GSM1900 Idle + Bluetooth Link + WLAN (5GHz) Link + Earphone + USB Cable 1 (Charging from Adapter 1) + MP3 + Battery 1
------------------------------	--

Ch. #		Band IV : 5725-5850 MHz		
		802.11a	802.11n HT20	802.11n HT40
L	Low	149	149	151
M	Middle	157	157	-
H	High	165	165	159

2.4 Connection Diagram of Test System

<WLAN Tx Mode>

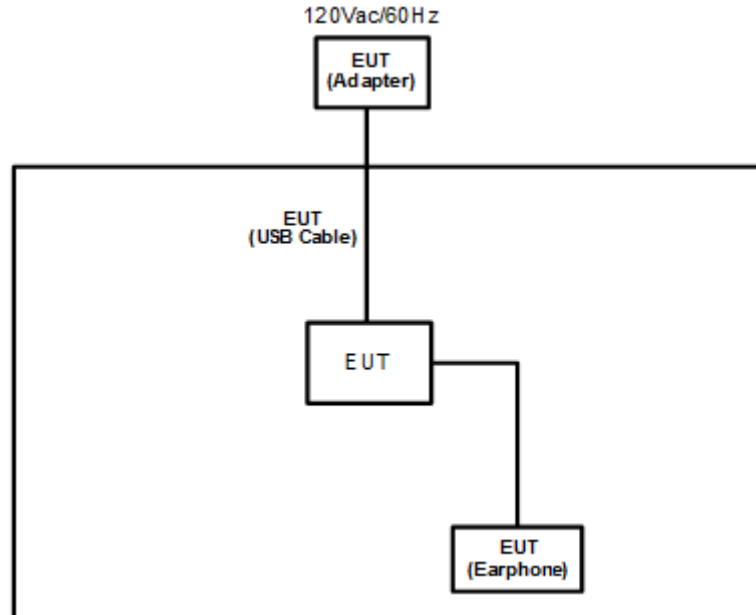

<AC Conducted Emission Mode>

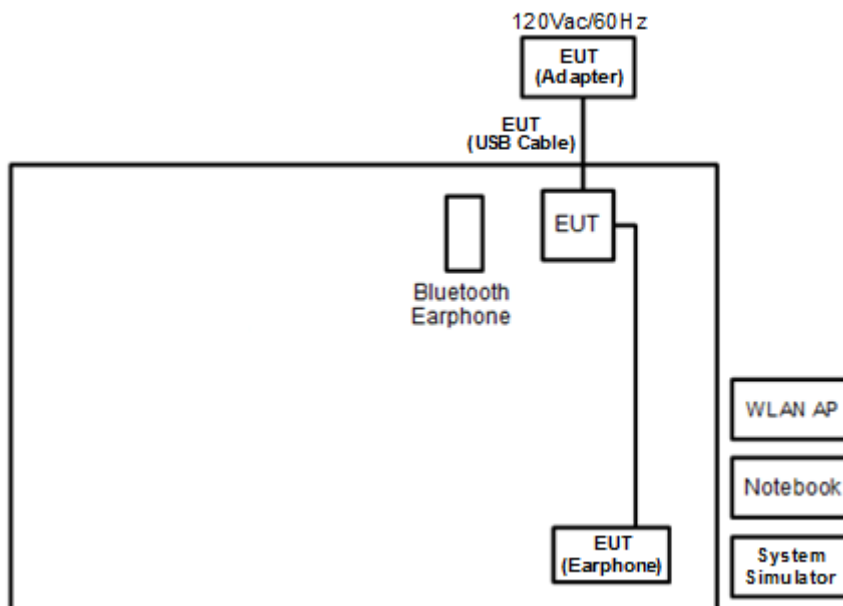



2.5 Support Unit used in test configuration and system

Item	Equipment	Trade Name	Model Name	FCC ID	Data Cable	Power Cord
1.	System Simulator	Anritsu	MT8820C	N/A	N/A	Unshielded, 1.8 m
2.	WLAN AP	D-Link	DIR-865L	KA2IR865LA1	N/A	Unshielded, 1.8 m
3.	Bluetooth Earphone	Sony	SBH20	PY7-RD0010	Unshielded, 0.75 m	N/A
4.	Notebook	DELL	Latitude E6320	FCC DoC/ Contains FCC ID: QDS-BRCM1054	N/A	AC I/P: Unshielded, 1.2 m DC O/P: Shielded, 1.8 m
5.	SD Card	SanDisk	MicroSD HC	FCC DoC	N/A	N/A

2.6 EUT Operation Test Setup

For WLAN RF test items, an engineering test program was provided and enabled to make EUT continuous transmit/receive.

2.7 Measurement Results Explanation Example

For all conducted test items:

The offset level is set in the spectrum analyzer to compensate the RF cable loss and attenuator factor between EUT conducted output port and spectrum analyzer. With the offset compensation, the spectrum analyzer reading level is exactly the EUT RF output level.

Example :

The spectrum analyzer offset is derived from RF cable loss and attenuator factor.

Offset = RF cable loss + attenuator factor.

Following shows an offset computation example with cable loss 4.2 dB and 10dB attenuator.

$$\begin{aligned}
\text{Offset(dB)} &= \text{RF cable loss(dB)} + \text{attenuator factor(dB)}. \\
&= 4.2 + 10 = 14.2 \text{ (dB)}
\end{aligned}$$

3 Test Result

3.1 6dB and 26dB and 99% Occupied Bandwidth Measurement

3.1.1 Description of 6dB and 26dB and 99% Occupied Bandwidth

The minimum 6 dB bandwidth shall be at least 500 kHz.

26dB and 99% Occupied bandwidth are reporting only.

3.1.2 Measuring Instruments

The measuring equipment is listed in the section 4 of this test report.

3.1.3 Test Procedures

1. The testing follows FCC KDB 789033 D02 General UNII Test Procedures New Rules v01.
Section C) Emission bandwidth for the band 5.725-5.85GHz
2. Set RBW = 100kHz.
3. Set the VBW $\geq 3 \times$ RBW.
4. Detector = Peak.
5. Trace mode = max hold
6. Measure the maximum width of the emission that is 6 dB down from the peak of the emission.
7. Measure and record the results in the test report.

3.1.4 Test Setup

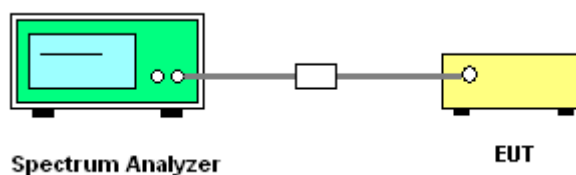



3.1.5 Test Result of 6dB and 26dB and 99% Occupied Bandwidth

Please refer to Appendix A.

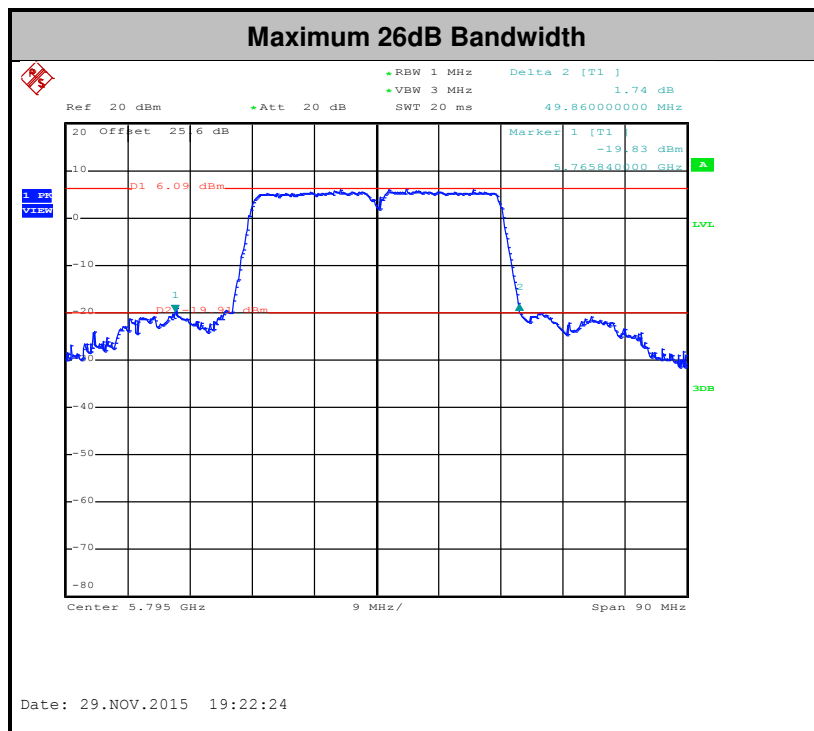
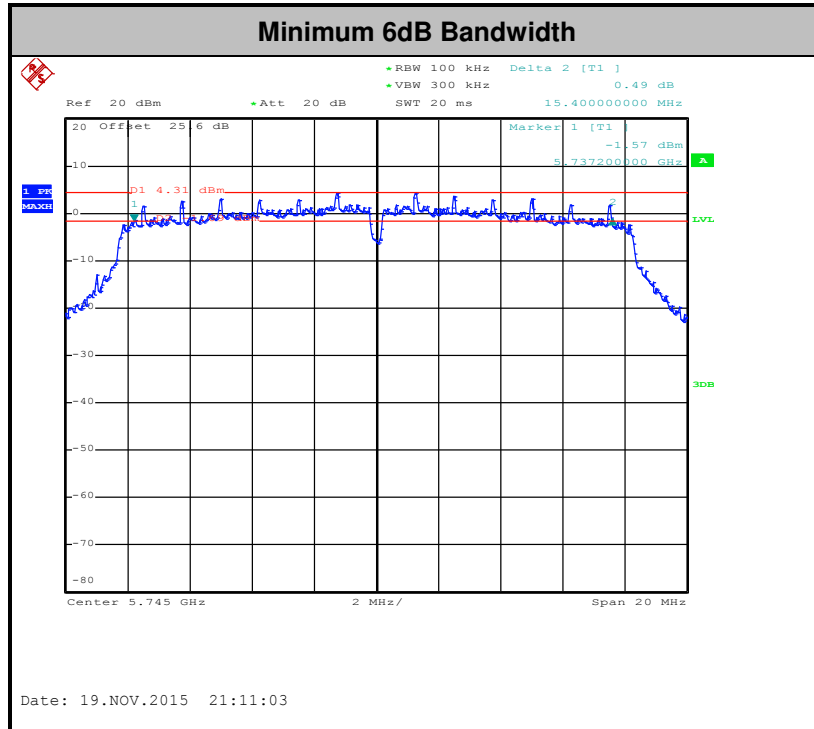

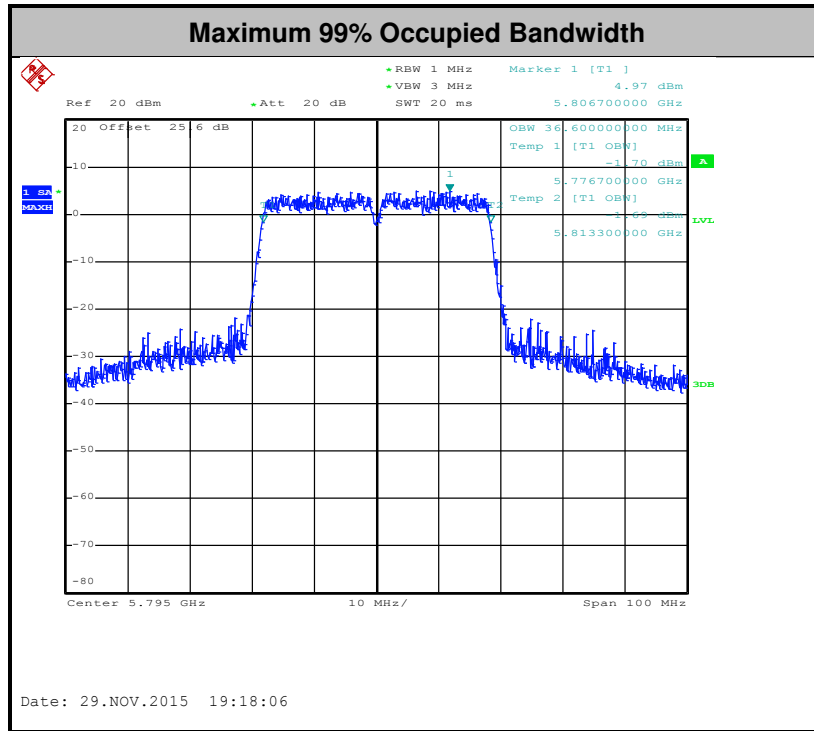

Note: The occupied channel bandwidth is maintained within the band of operation for all of the modulations.

3.2 Maximum Conducted Output Power Measurement

3.2.1 Limit of Maximum Conducted Output Power

For the band 5.725–5.85 GHz, the maximum conducted output power over the frequency band of operation shall not exceed 1 W.

If transmitting antennas of directional gain greater than 6 dBi are used, the peak output power shall be reduced by the amount in dB that the directional gain of the antenna exceeds 6 dBi.

3.2.2 Measuring Instruments

The measuring equipment is listed in the section 4 of this test report.

3.2.3 Test Procedures

The testing follows Method PM of FCC KDB 789033 D02 General UNII Test Procedures New Rules v01.

Method PM (Measurement using an RF average power meter):

1. Measurement is performed using a wideband RF power meter.
2. The EUT is configured to transmit continuously with a consistent duty cycle at its maximum power control level.
3. Measure the average power of the transmitter, and the average power is corrected with duty factor, $10 \log(1/x)$, where x is the duty cycle.

3.2.4 Test Setup

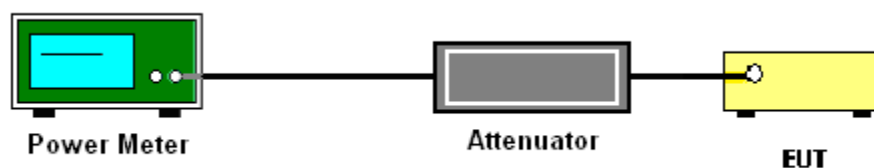

3.2.5 Test Result of Maximum Conducted Output Power

Please refer to Appendix A.



3.3 Power Spectral Density Measurement

3.3.1 Limit of Power Spectral Density

For the band 5.725–5.85 GHz, the maximum power spectral density shall not exceed 30 dBm in any 500-kHz band.

If transmitting antennas of directional gain greater than 6 dBi are used, the peak output power shall be reduced by the amount in dB that the directional gain of the antenna exceeds 6 dBi.

3.3.2 Measuring Instruments

The measuring equipment is listed in the section 4 of this test report.

3.3.3 Test Procedures

The testing follows FCC KDB 789033 D02 General UNII Test Procedures New Rules v01. Section F) Maximum power spectral density.

Method SA-2

(trace averaging across on and off times of the EUT transmissions, followed by duty cycle correction).

1. The testing follows Method SA-2 of FCC KDB 789033 D01 General UNII Test Procedures v01r03.
 - Measure the duty cycle.
 - Set span to encompass the entire emission bandwidth (EBW) of the signal.
 - Set RBW = 300 kHz.
 - Set VBW \geq 1 MHz.
 - Number of points in sweep \geq 2 Span / RBW.
 - Sweep time = auto.
 - Detector = RMS
 - Trace average at least 100 traces in power averaging mode.
 - Add $10 \log(500\text{kHz}/\text{RBW})$ to the test result.
 - Add $10 \log(1/x)$, where x is the duty cycle, to the measured power in order to compute the average power during the actual transmission times. For example, add $10 \log(1/0.25) = 6$ dB if the duty cycle is 25 percent.

- 2. The RF output of EUT was connected to the spectrum analyzer by a low loss cable.
- 3. Each plot has already offset with cable loss, and attenuator loss. Measure the PPSD and record it.

3.3.4 Test Setup

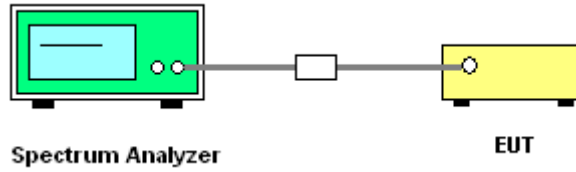

3.3.5 Test Result of Power Spectral Density

Please refer to Appendix A.

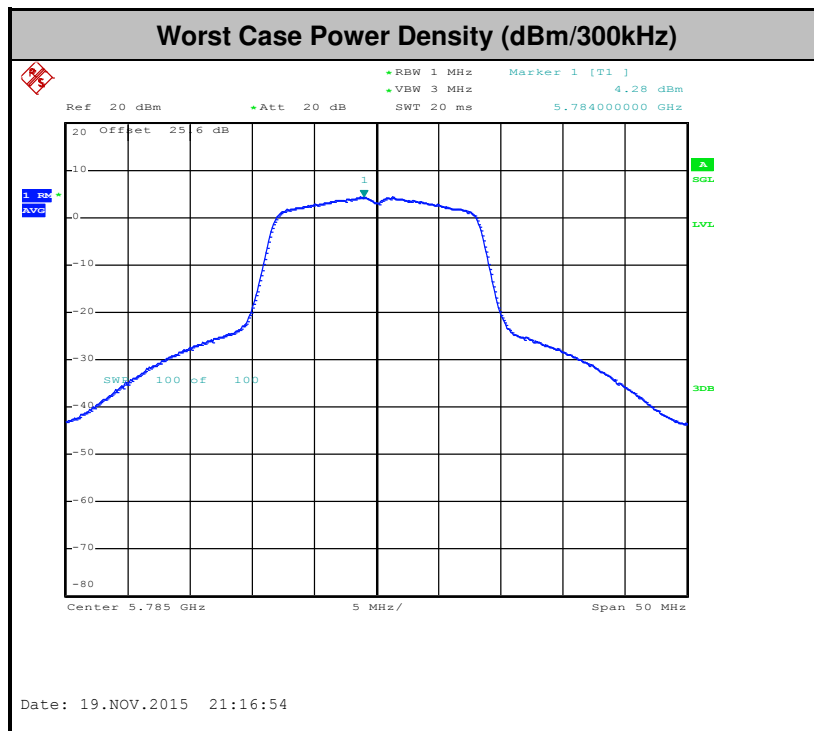



3.4 Unwanted Emissions Measurement

This section as specified in FCC Part 15.407(b) is to measure unwanted emissions through radiated measurement for band edge spurious emissions and out of band emissions measurement. The unwanted emissions shall comply with 15.407(b)(1) to (6), and restricted bands per FCC Part15.205.

3.4.1 Limit of Unwanted Emissions

- (1) For transmitters operating in the 5725-5850 MHz band: all emissions within the frequency range from the band edge to 10 MHz above or below the band edge shall not exceed an EIRP of -17 dBm/MHz (78.3dBµV/m); for frequencies 10 MHz or greater above or below the band edge, emissions shall not exceed an EIRP of -27 dBm/MHz (68.3dBµV/m).
- (2) Unwanted spurious emissions fallen in restricted bands per FCC Part15.205 shall comply with the general field strength limits set forth in § 15.209 as below table,

Frequency (MHz)	Field Strength (microvolts/meter)	Measurement Distance (meters)
0.009 – 0.490	2400/F(kHz)	300
0.490 – 1.705	24000/F(kHz)	30
1.705 – 30.0	30	30
30 – 88	100	3
88 – 216	150	3
216 - 960	200	3
Above 960	500	3

Note: The following formula is used to convert the EIRP to field strength.

$$E = \frac{1000000\sqrt{30P}}{3} \mu\text{V/m, where P is the eirp (Watts)}$$

EIRP (dBm)	Field Strength at 3m (dBµV/m)
-17	78.3
-27	68.3

- (3) KDB789033 v01r03 H)2)c)(i) As specified in 15.407(b), emissions above 1000 MHz that are outside of the restricted bands are subject to a peak emission limit of -27 dBm/MHz (or -17 dBm/MHz as specified in 15.407(b)(4)). However, an out-of-band emission that complies with both the average and peak limits of 15.209 is not required to satisfy the -27 dBm/MHz or -17 dBm/MHz peak emission limit.



3.4.2 Measuring Instruments

The measuring equipment is listed in the section 4 of this test report.

3.4.3 Test Procedures

1. The testing follows FCC KDB 789033 D02 General UNII Test Procedures New Rules v01. Section G) Unwanted emissions measurement.

(1) Procedure for Unwanted Emissions Measurements Below 1000MHz

- RBW = 120 kHz
- VBW = 300 kHz
- Detector = Peak
- Trace mode = max hold

(2) Procedure for Peak Unwanted Emissions Measurements Above 1000 MHz

- RBW = 1 MHz
- VBW ≥ 3 MHz
- Detector = Peak
- Sweep time = auto
- Trace mode = max hold

(3) Procedures for Average Unwanted Emissions Measurements Above 1000MHz

- RBW = 1 MHz
- VBW = 10 Hz, when duty cycle is no less than 98 percent.
- $VBW \geq 1/T$, when duty cycle is less than 98 percent where T is the minimum transmission duration over which the transmitter is on and is transmitting at its maximum power control level for the tested mode of operation.

Band	Duty Cycle(%)	T(us)	1/T(kHz)	VBW Setting
802.11a	97.20	1390.00	0.72	1kHz
5GHz 802.11n HT20	97.02	1300.00	0.77	1kHz
5GHz 802.11n HT40	94.20	650.00	1.54	3kHz

2. The EUT was placed on a turntable with 0.8 meter for frequency below 1GHz and 1.5 meter for frequency above 1GHz respectively above ground.
3. The EUT was set 3 meters from the interference receiving antenna which was mounted on the top of a variable height antenna tower.
4. The antenna is a broadband antenna and its height is adjusted between one meter and four meters above ground to find the maximum value of the field strength for both horizontal polarization and vertical polarization of the antenna.
5. For each suspected emission, the EUT was arranged to its worst case and then adjust the antenna tower (from 1 m to 4 m) and turntable (from 0 degree to 360 degrees) to find the maximum reading.
6. For testing below 1GHz, if the emission level of the EUT in peak mode was 3 dB lower than the limit specified, then peak values of EUT will be reported, otherwise, the emissions will be repeated one by one using the CISPR quasi-peak method and reported.
7. For testing above 1GHz, the emission level of the EUT in peak mode was 20dB lower than average limit (that means the emission level in average mode also complies with the limit in average mode), then peak values of EUT will be reported, otherwise, the emissions will be measured in average mode again and reported.

3.4.4 Test Setup

For radiated emissions below 30MHz

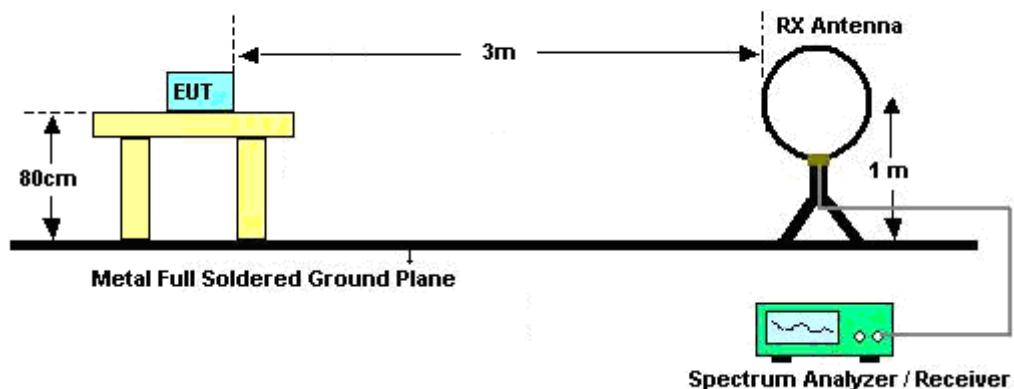

For radiated emissions from 30MHz to 1GHz

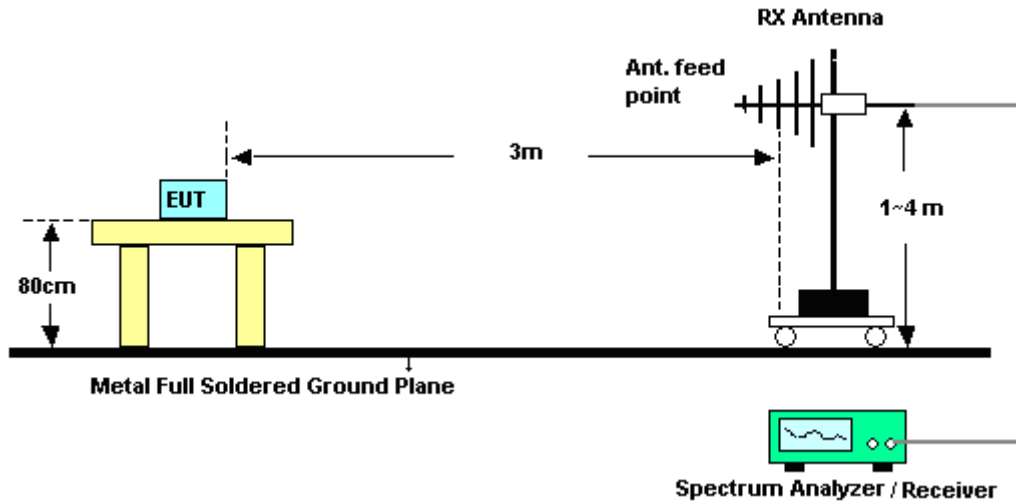

For radiated emissions above 1GHz

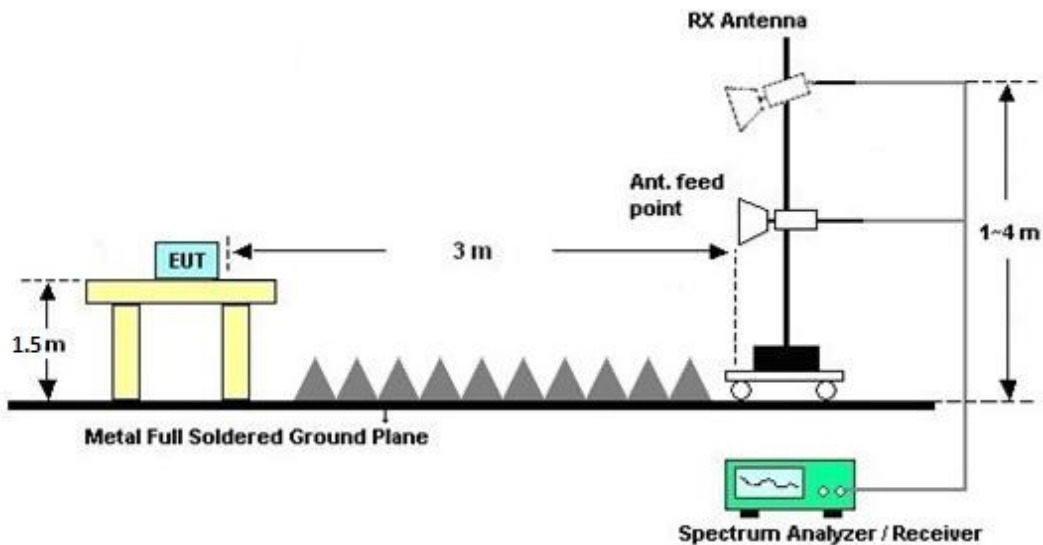

3.4.5 Test Results of Radiated Emissions (9 kHz ~ 30 MHz)

The low frequency, which started from 9 kHz to 30MHz, was pre-scanned and the result which was 20dB lower than the limit line per 15.31(o) was not reported.

3.4.6 Test Result of Radiated Band Edges

Please refer to Appendix B.

3.4.7 Test Result of Unwanted Radiated Emission (30MHz ~ 10th Harmonic)

Please refer to Appendix B.



3.5 AC Conducted Emission Measurement

3.5.1 Limit of AC Conducted Emission

For equipment that is designed to be connected to the public utility (AC) power line, the radio frequency voltage that is conducted back onto the AC power line on any frequency or frequencies within the band 150 kHz to 30 MHz shall not exceed the limits in the following table.

Frequency of emission (MHz)	Conducted limit (dB μ V)	
	Quasi-peak	Average
0.15-0.5	66 to 56*	56 to 46*
0.5-5	56	46
5-30	60	50

*Decreases with the logarithm of the frequency.

3.5.2 Measuring Instruments

The measuring equipment is listed in the section 4 of this test report.

3.5.3 Test Procedures

1. The EUT was placed 0.4 meter from the conducting wall of the shielding room was kept at least 80 centimeters from any other grounded conducting surface.
2. Connect EUT to the power mains through a line impedance stabilization network (LISN).
3. All the support units are connecting to the other LISN.
4. The LISN provides 50 ohm coupling impedance for the measuring instrument.
5. The FCC states that a 50 ohm, 50 microhenry LISN should be used.
6. Both sides of AC line were checked for maximum conducted interference.
7. The frequency range from 150 kHz to 30 MHz was searched.
8. Set the test-receiver system to Peak Detect Function and specified bandwidth with Maximum Hold Mode.

3.5.4 Test Setup

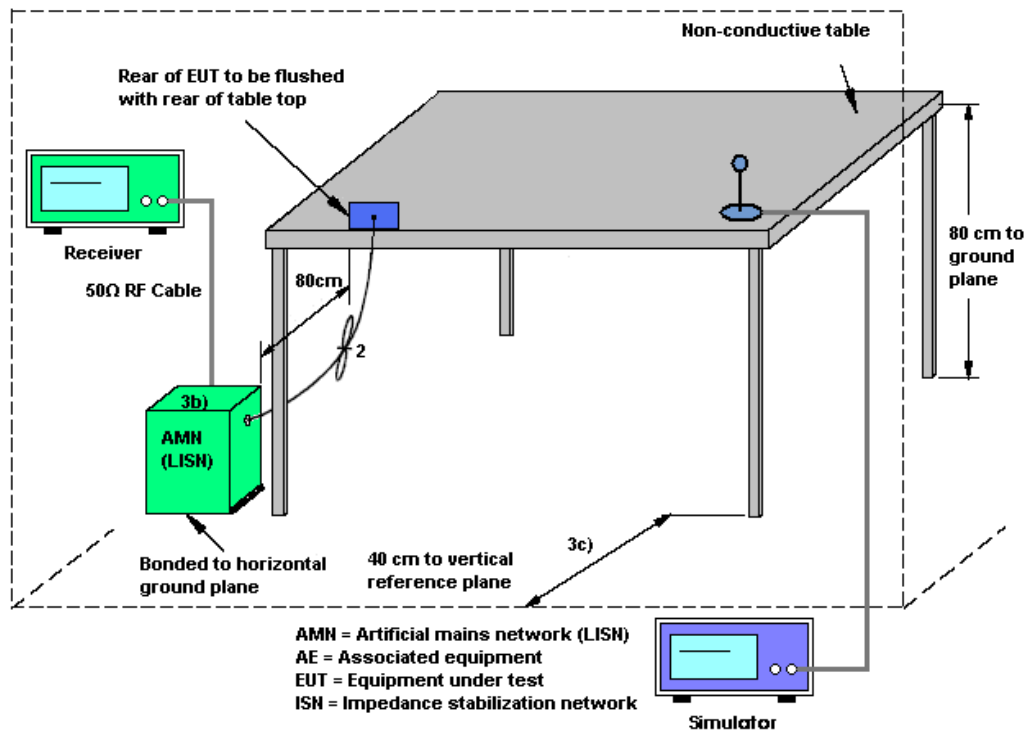



3.5.5 Test Result of AC Conducted Emission

Test Mode :	Mode 1	Temperature :	22~23°C
Test Engineer :	Derreck Chen	Relative Humidity :	52~55%
Test Voltage :	120Vac / 60Hz	Phase :	Line
Function Type :	GSM1900 Idle + Bluetooth Link + WLAN (5GHz) Link + Earphone + USB Cable 1 (Charging from Adapter 1) + MP3 + Battery 1		

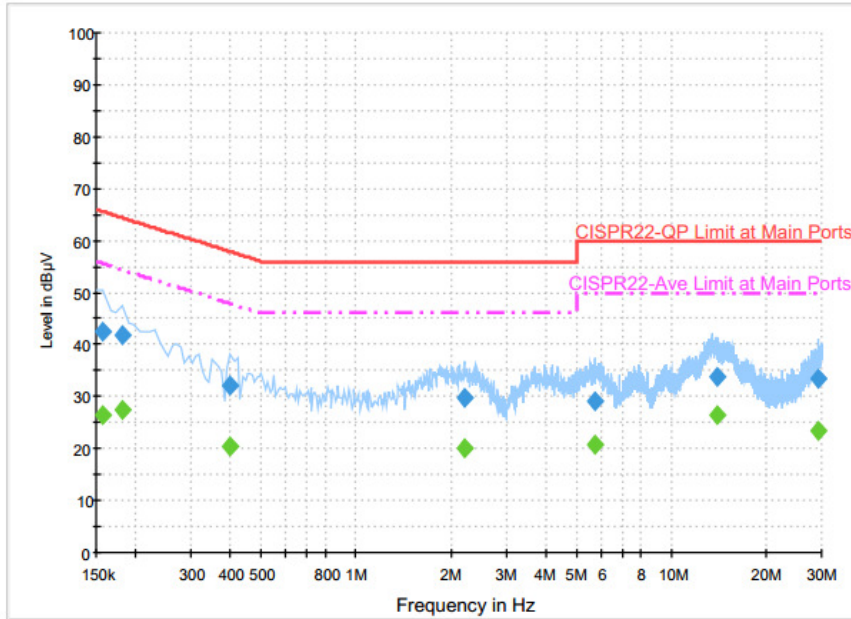

Final Result : QuasiPeak

Frequency (MHz)	QuasiPeak (dBµV)	Filter	Line	Corr. (dB)	Margin (dB)	Limit (dBµV)
0.158000	42.6	Off	L1	19.6	23.0	65.6
0.182000	42.0	Off	L1	19.7	22.4	64.4
0.398000	32.0	Off	L1	19.7	25.9	57.9
2.206000	29.7	Off	L1	19.6	26.3	56.0
5.742000	29.0	Off	L1	19.7	31.0	60.0
14.038000	33.9	Off	L1	19.8	26.1	60.0
29.430000	33.4	Off	L1	19.9	26.6	60.0

Final Result : Average

Frequency (MHz)	Average (dBµV)	Filter	Line	Corr. (dB)	Margin (dB)	Limit (dBµV)
0.158000	26.3	Off	L1	19.6	29.3	55.6
0.182000	27.5	Off	L1	19.7	26.9	54.4
0.398000	20.5	Off	L1	19.7	27.4	47.9
2.206000	20.2	Off	L1	19.6	25.8	46.0
5.742000	20.6	Off	L1	19.7	29.4	50.0
14.038000	26.4	Off	L1	19.8	23.6	50.0
29.430000	23.3	Off	L1	19.9	26.7	50.0



Test Mode :	Mode 1	Temperature :	22~23°C
Test Engineer :	Derreck Chen	Relative Humidity :	52~55%
Test Voltage :	120Vac / 60Hz	Phase :	Neutral
Function Type :	GSM1900 Idle + Bluetooth Link + WLAN (5GHz) Link + Earphone + USB Cable 1 (Charging from Adapter 1) + MP3 + Battery 1		

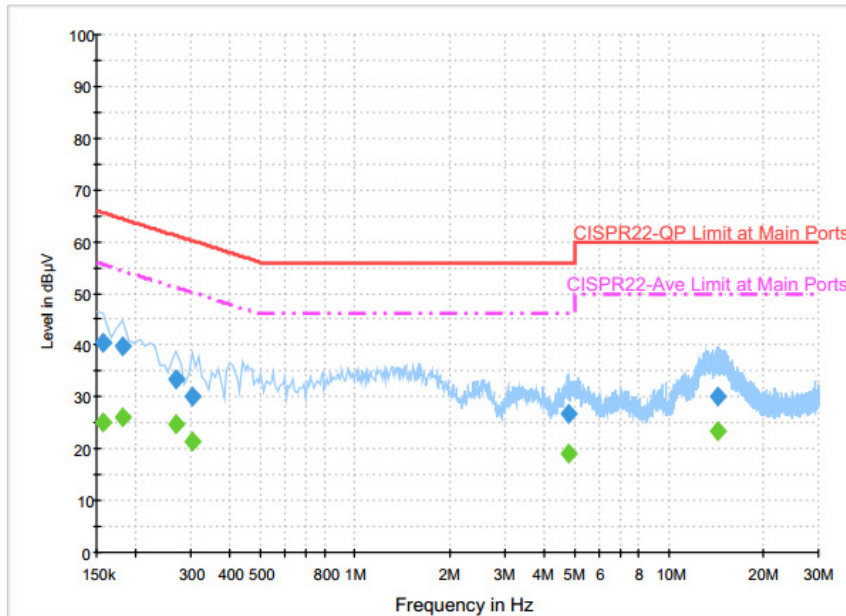

Final Result : QuasiPeak

Frequency (MHz)	QuasiPeak (dBµV)	Filter	Line	Corr. (dB)	Margin (dB)	Limit (dBµV)
0.158000	40.3	Off	N	19.6	25.3	65.6
0.182000	39.8	Off	N	19.7	24.6	64.4
0.270000	33.5	Off	N	19.7	27.6	61.1
0.302000	30.1	Off	N	19.7	30.1	60.2
4.814000	26.8	Off	N	19.7	29.2	56.0
14.406000	30.2	Off	N	19.8	29.8	60.0

Final Result : Average

Frequency (MHz)	Average (dBµV)	Filter	Line	Corr. (dB)	Margin (dB)	Limit (dBµV)
0.158000	25.2	Off	N	19.6	30.4	55.6
0.182000	25.9	Off	N	19.7	28.5	54.4
0.270000	24.8	Off	N	19.7	26.3	51.1
0.302000	21.5	Off	N	19.7	28.7	50.2
4.814000	19.0	Off	N	19.7	27.0	46.0
14.406000	23.5	Off	N	19.8	26.5	50.0

3.6 Frequency Stability Measurement

3.6.1 Limit of Frequency Stability

Manufacturers of U-NII devices are responsible for ensuring frequency stability such that an emission is maintained within the band of operation under all conditions of normal operation as specified in the user's manual.

3.6.2 Measuring Instruments

The measuring equipment is listed in the section 4 of this test report.

3.6.3 Test Procedures

1. To ensure emission at the band edge is maintained within the authorized band, those values shall be measured by radiation emissions at upper and lower frequency points, and finally compensated by frequency deviation as procedures below.
2. The EUT was operated at the maximum output power, and connected to the spectrum analyzer, which is set to maximum hold function and peak detector. The peak value of the power envelope was measured and noted. The upper and lower frequency points were respectively measured relatively 10dB lower than the measured peak value.
3. The frequency deviation was calculated by adding the upper frequency point and the lower frequency point divided by two. Those detailed values of frequency deviation are provided in table below.

3.6.4 Test Setup

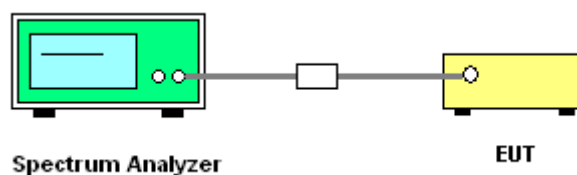

3.6.5 Test Result of Frequency Stability

Please refer to Appendix A.



3.7 Automatically Discontinue Transmission

3.7.1 Limit of Automatically Discontinue Transmission

The device shall automatically discontinue transmission in case of either absence of information to transmit or operational failure. These provisions are not intended to preclude the transmission of control or signaling information or the use of repetitive codes used by certain digital technologies to complete frame or burst intervals. Applicants shall include in their application for equipment authorization to describe how this requirement is met.

3.7.2 Measuring Instruments

The measuring equipment is listed in the section 4 of this test report.

3.7.3 Test Result of Automatically Discontinue Transmission

While the EUT is not transmitting any information, the EUT can automatically discontinue transmission and become standby mode for power saving. The EUT can detect the controlling signal of ACK message transmitting from remote device and verify whether it shall resend or discontinue transmission.



3.8 Antenna Requirements

3.8.1 Standard Applicable

According to FCC 47 CFR Section 15.407(a)(1)(2), if transmitting antenna directional gain is greater than 6 dBi, both the peak transmit power and the peak power spectral density shall be reduced by the amount in dB that the directional gain of the antenna exceeds 6 dBi.

3.8.2 Antenna Anti-Replacement Construction

An embedded-in antenna design is used.

3.8.3 Antenna Gain

The antenna peak gain of EUT is less than 6 dBi. Therefore, it is not necessary to reduce maximum peak output power limit.



4 List of Measuring Equipment

Instrument	Manufacturer	Model No.	Serial No.	Characteristics	Calibration Date	Test Date	Due Date	Remark
Power Meter	Anritsu	ML2495A	1218006	300MHz~40GHz	Oct. 07, 2015	Nov. 06, 2015~ Nov. 29, 2015	Oct. 06, 2016	Conducted (TH05-HY)
Power Sensor	Anritsu	MA2411B	1207363	300MHz~40GHz	Oct. 07, 2015	Nov. 06, 2015~ Nov. 29, 2015	Oct. 06, 2016	Conducted (TH05-HY)
Spectrum Analyzer	Rohde & Schwarz	FSP40	100055	9kHz-40GHz	Jun. 18, 2015	Nov. 06, 2015~ Nov. 29, 2015	Jun. 17, 2016	Conducted (TH05-HY)
Hygrometer	Testo	608-H1	34897199	N/A	May. 04, 2015	Nov. 06, 2015~ Nov. 29, 2015	May. 03, 2016	Conducted (TH05-HY)
Temperature Chamber	ESPEC	SH-641	92013720	-40 °C~90 °C	Sep. 08, 2015	Nov. 06, 2015~ Nov. 29, 2015	Sep. 07, 2016	Conducted (TH05-HY)
RF Cable	HARBOUR INDUSTRIES	LL142	Infinet CA3601-3601- DLL	0.1MHz~40GHz	Mar. 06, 2015	Nov. 06, 2015~ Nov. 29, 2015	Mar. 05, 2016	Conducted (TH05-HY)
Loop Antenna	Rohde & Schwarz	HFH2-Z2	100315	9 kHz~30 MHz	Sep. 02, 2015	Oct. 30, 2015~ Dec. 29, 2015	Sep. 01, 2016	Radiation (03CH11-HY)
Amplifier	SONOMA	310N	187312	9kHz~1GHz	Nov. 24, 2014	Oct. 30, 2015~ Nov. 17, 2015	Nov. 23, 2015	Radiation (03CH11-HY)
Amplifier	SONOMA	310N	187312	9kHz~1GHz	Nov. 20, 2015	Nov. 21, 2015~ Dec. 29, 2015	Nov. 19, 2016	Radiation (03CH11-HY)
Horn Antenna	SCHWARZBECK	BBHA 9120 D	9120D-1326	1GHz ~ 18GHz	Oct. 08, 2015	Oct. 30, 2015~ Dec. 29, 2015	Oct. 07, 2016	Radiation (03CH11-HY)
Hygrometer	TECPEL	DTN-303B	TP140325	N/A	Nov. 19, 2014	Oct. 30, 2015~ Nov. 17, 2015	Nov. 18, 2015	Radiation (03CH11-HY)
Hygrometer	TECPEL	DTN-303B	TP140325	N/A	Nov. 17, 2015	Nov. 21, 2015~ Dec. 29, 2015	Nov. 16, 2016	Radiation (03CH11-HY)
Preamplifier	Keysight	83017A	MY53270080	1GHz~26.5GHz	Nov. 20, 2014	Oct. 30, 2015~ Nov. 17, 2015	Nov. 19, 2015	Radiation (03CH11-HY)
Preamplifier	Keysight	83017A	MY53270080	1GHz~26.5GHz	Nov. 19, 2015	Nov. 21, 2015~ Dec. 29, 2015	Nov. 18, 2016	Radiation (03CH11-HY)
Preamplifier	MITEQ	AMF-7D-0010 1800-30-10P	1902247	1GHz~18GHz	Jul. 01, 2015	Oct. 30, 2015~ Dec. 29, 2015	Jun. 30, 2016	Radiation (03CH11-HY)
Spectrum Analyzer	Keysight	N9010A	MY54200486	10Hz ~ 44GHZ	Sep. 24, 2015	Oct. 30, 2015~ Dec. 29, 2015	Sep. 23, 2016	Radiation (03CH11-HY)
EMI Test Receiver	Agilent	N9038A(MXE)	MY53290053	20Hz to 26.5GHz	Feb. 02, 2015	Oct. 30, 2015~ Dec. 29, 2015	Feb. 01, 2016	Radiation (03CH11-HY)
Controller	EMEC	EM 1000	N/A	Control Turn table & Ant Mast	N/A	Oct. 30, 2015~ Dec. 29, 2015	N/A	Radiation (03CH11-HY)
Antenna Mast	EMEC	AM-BS-4500-B	N/A	1~4m	N/A	Oct. 30, 2015~ Dec. 29, 2015	N/A	Radiation (03CH11-HY)
Turn Table	EMEC	TT 2000	N/A	0-360 degree	N/A	Oct. 30, 2015~ Dec. 29, 2015	N/A	Radiation (03CH11-HY)
Bilog Antenna	TESEQ	CBL 6111D	35414	30MHz to 1GHz	Nov. 17, 2015	Nov. 21, 2015~ Dec. 29, 2015	Nov. 16, 2016	Radiation (03CH11-HY)
SHF-EHF Horn Antenna	SCHWARZBECK	BBHA 9170	BBHA917057 6	18GHz ~ 40GHz	Apr. 20, 2015	Oct. 30, 2015~ Dec. 29, 2015	Apr. 19, 2016	Radiation (03CH11-HY)
Preamplifier	MITEQ	JS44-1800400 0-33-8P	1840917	18GHz ~ 40GHz	Jun. 02, 2015	Oct. 30, 2015~ Dec. 29, 2015	Jun. 01, 2016	Radiation (03CH11-HY)



Instrument	Manufacturer	Model No.	Serial No.	Characteristics	Calibration Date	Test Date	Due Date	Remark
Test Software	Audix	E3	6.2009-8-24	N/A	N/A	Oct. 30, 2015~ Dec. 29, 2015	N/A	Radiation (03CH11-HY)
Filter	Wainwright	WLKS4500-8S S	SN19	4.5G Low Pass	Oct. 01, 2015	Oct. 30, 2015~ Dec. 29, 2015	Sep. 30, 2016	Radiation (03CH11-HY)
Filter	Microwave Circuits	H07G18G3	SN8009-01	7GHz HPF	Oct. 01, 2015	Oct. 30, 2015~ Dec. 29, 2015	Sep. 30, 2016	Radiation (03CH11-HY)
AC Power Source	ChainTek	APC-1000W	N/A	N/A	N/A	Dec. 21, 2015	N/A	Conduction (CO05-HY)
EMI Test Receiver	Rohde & Schwarz	ESCI 7	100724	9kHz~7GHz	Aug. 26, 2015	Dec. 21, 2015	Aug. 25, 2016	Conduction (CO05-HY)
Hygrometer	Testo	608-H1	34913912	N/A	Apr. 20, 2015	Dec. 21, 2015	Apr. 19, 2016	Conduction (CO05-HY)
LISN	Rohde & Schwarz	ENV216	100080	9kHz~30MHz	Dec. 02, 2015	Dec. 21, 2015	Dec. 01, 2016	Conduction (CO05-HY)
LF Cable	HUBER + SUHNER	RG-214/U	LF01	N/A	Jan. 07, 2015	Dec. 21, 2015	Jan. 06, 2016	Conduction (CO05-HY)
Test Software	N/A	EMC32	8.40.0	N/A	N/A	Dec. 21, 2015	N/A	Conduction (CO05-HY)



5 Uncertainty of Evaluation

Uncertainty of Conducted Emission Measurement (150kHz ~ 30MHz)

Measuring Uncertainty for a Level of Confidence of 95% ($U = 2Uc(y)$)	2.26
---	------

Uncertainty of Radiated Emission Measurement (30 MHz ~ 1000 MHz)

Measuring Uncertainty for a Level of Confidence of 95% ($U = 2Uc(y)$)	4.9
---	-----



Appendix A. Conducted Test Results

Test Engineer:	Luffy Lin	Temperature:	21~25	°C
Test Date:	2015/11/06~2015/11/29	Relative Humidity:	51~54	%

TEST RESULTS DATA
6dB and 26dB EBW and 99% OBW

Band IV									
Mod.	Data Rate	NTX	CH.	Freq. (MHz)	99% Bandwidth (MHz)	26 dB Bandwidth (MHz)	6 dB Bandwidth (MHz)	6dB Bandwidth min. Limit (MHz)	Pass/Fail
11a	6M bps	1	149	5745	17.35	30.2	15.4	0.5	Pass
11a	6Mbps	1	157	5785	17.5	34.3	15.68	0.5	Pass
11a	6Mbps	1	165	5825	17.3	31.8	15.48	0.5	Pass
HT20	MCS 0	1	149	5745	18.3	29.4	16	0.5	Pass
HT20	MCS 0	1	157	5785	18.3	31.9	16.52	0.5	Pass
HT20	MCS 0	1	165	5825	18.3	31.2	15.48	0.5	Pass
HT40	MCS 0	1	151	5755	36.6	45	36.08	0.5	Pass
HT40	MCS 0	1	159	5795	36.6	49.86	36.32	0.5	Pass

TEST RESULTS DATA
Average Power Table

Band IV										
Mod.	Data Rate	NTX	CH.	Freq. (MHz)	Duty Factor (dB)	Average Conducted Power (dBm)	FCC Conducted Power Limit (dBm)	DG (dBi)		Pass/Fail
11a	6M bps	1	149	5745	0.12	14.84	30.00	-1.10		Pass
11a	6Mbps	1	157	5785	0.12	14.83	30.00	-1.10		Pass
11a	6Mbps	1	165	5825	0.12	14.63	30.00	-1.10		Pass
HT20	MCS 0	1	149	5745	0.13	14.64	30.00	-1.10		Pass
HT20	MCS 0	1	157	5785	0.13	14.55	30.00	-1.10		Pass
HT20	MCS 0	1	165	5825	0.13	14.48	30.00	-1.10		Pass
HT40	MCS 0	1	151	5755	0.26	11.17	30.00	-1.10		Pass
HT40	MCS 0	1	159	5795	0.26	11.27	30.00	-1.10		Pass

TEST RESULTS DATA
Power Spectral Density

Band IV										
Mod.	Data Rate	NTX	CH.	Freq. (MHz)	Duty Factor (dB)	10log (500kHz /RBW) Factor (dB)	Average Power Density (dBm/500kHz)	Average PSD Limit (dBm/500kHz)	DG (dBi)	Pass/Fail
11a	6M bps	1	149	5745	0.12	2.22	6.22	30.00	-1.10	Pass
11a	6Mbps	1	157	5785	0.12	2.22	6.62	30.00	-1.10	Pass
11a	6Mbps	1	165	5825	0.12	2.22	6.37	30.00	-1.10	Pass
HT20	MCS 0	1	149	5745	0.13	2.22	6.13	30.00	-1.10	Pass
HT20	MCS 0	1	157	5785	0.13	2.22	5.79	30.00	-1.10	Pass
HT20	MCS 0	1	165	5825	0.13	2.22	6.48	30.00	-1.10	Pass
HT40	MCS 0	1	151	5755	0.26	2.22	-5.43	30.00	-1.10	Pass
HT40	MCS 0	1	159	5795	0.26	2.22	-5.41	30.00	-1.10	Pass

TEST RESULTS DATA
Frequency Stability

Band IV										
Mod.	Data Rate	NTX	CH.	Freq. (MHz)	Center Frequency (MHz)	Frequency Deviation (MHz)	Frequency Stability (ppm)	Temperature (°C)	Voltage (V)	Note
11a	6M bps	1	149	5745	5744.950	-0.050	-8.70	20	3.2	
11a	6M bps	1	149	5745	5744.950	-0.050	-8.70	20	4.2	
11a	6M bps	1	149	5745	5745.050	0.050	8.70	20	3.7	
11a	6M bps	1	149	5745	5745.000	0.000	0.00	-30	3.7	
11a	6M bps	1	149	5745	5745.000	0.000	0.00	50	3.7	



Appendix B. Radiated Spurious Emission

Test Engineer :	Bill Kuo, Ken Wu, and J.C. Liang	Temperature :	21~23°C
		Relative Humidity :	54~56%

Band 4 5725~5850MHz

WIFI 802.11a (Band Edge @ 3m)

WIFI Ant. 1	Note	Frequency (MHz)	Level (dBμV/m)	Over Limit (dB)	Limit Line (dBμV/m)	Read Level (dBμV)	Antenna Factor (dB/m)	Cable Loss (dB)	Preamp Factor (dB)	Ant Pos (cm)	Table Pos (deg)	Peak Avg. (P/A)	Pol. (H/V)	
802.11a CH 149 5745MHz		5714.84	59.62	-14.38	74	51.58	32.29	9.39	33.64	100	120	P	H	
		5724.2	74.46	-3.84	78.3	66.35	32.31	9.44	33.64	100	120	P	H	
		5714.84	50.64	-3.36	54	42.6	32.29	9.39	33.64	100	120	A	H	
	*	5745	107.89	-	-	99.76	32.34	9.44	33.65	100	120	P	H	
	*	5745	101.28	-	-	93.15	32.34	9.44	33.65	100	120	A	H	
														H
														H
														H
			5714.36	56.22	-17.78	74	48.18	32.29	9.39	33.64	335	99	P	V
			5724.36	70.59	-7.71	78.3	62.48	32.31	9.44	33.64	335	99	P	V
			5714.68	45.03	-8.97	54	36.99	32.29	9.39	33.64	335	99	A	V
	*		5745	104.19	-	-	96.06	32.34	9.44	33.65	335	99	P	V
	*		5745	94.81	-	-	86.68	32.34	9.44	33.65	335	99	A	V
														V
														V
														V



WIFI Ant. 1	Note	Frequency (MHz)	Level (dBμV/m)	Over Limit (dB)	Limit Line (dBμV/m)	Read Level (dBμV)	Antenna Factor (dB/m)	Cable Loss (dB)	Preamp Factor (dB)	Ant Pos (cm)	Table Pos (deg)	Peak Avg. (P/A)	Pol. (H/V)
802.11a CH 157 5785MHz		5705.4	53.88	-20.12	74	45.84	32.29	9.39	33.64	100	120	P	H
		5721.32	54.95	-23.35	78.3	46.89	32.31	9.39	33.64	100	120	P	H
		5704.92	46.04	-7.96	54	38	32.29	9.39	33.64	100	120	A	H
	*	5785	108.33	-	-	100.11	32.39	9.49	33.66	100	120	P	H
	*	5785	101.26	-	-	93.04	32.39	9.49	33.66	100	120	A	H
		5856	56.63	-21.67	78.3	48.26	32.51	9.54	33.68	100	120	P	H
		5864.56	54.78	-19.22	74	46.42	32.51	9.54	33.69	100	120	P	H
		5865.04	46.66	-7.34	54	38.3	32.51	9.54	33.69	100	120	A	H
		5685.8	50.27	-23.73	74	42.24	32.27	9.39	33.63	352	99	P	V
		5719.4	50.12	-28.18	78.3	42.06	32.31	9.39	33.64	352	99	P	V
		5705	41.89	-12.11	54	33.85	32.29	9.39	33.64	352	99	A	V
	*	5785	104.84	-	-	96.62	32.39	9.49	33.66	352	99	P	V
	*	5785	97.92	-	-	89.7	32.39	9.49	33.66	352	99	A	V
		5857.52	50.99	-27.31	78.3	42.62	32.51	9.54	33.68	352	99	P	V
		5862.64	51.12	-22.88	74	42.76	32.51	9.54	33.69	352	99	P	V
		5864.88	43	-11	54	34.64	32.51	9.54	33.69	352	99	A	V



WiFi Ant. 1	Note	Frequency (MHz)	Level (dBμV/m)	Over Limit (dB)	Limit Line (dBμV/m)	Read Level (dBμV)	Antenna Factor (dB/m)	Cable Loss (dB)	Preamp Factor (dB)	Ant Pos (cm)	Table Pos (deg)	Peak Avg. (P/A)	Pol. (H/V)	
802.11a CH 165 5825MHz	*	5825	108.15	-	-	99.84	32.46	9.52	33.67	100	117	P	H	
	*	5825	100.71	-	-	92.4	32.46	9.52	33.67	100	117	A	H	
		5852.64	68.51	-9.79	78.3	60.17	32.48	9.54	33.68	100	117	P	H	
		5864.72	55.95	-18.05	74	47.59	32.51	9.54	33.69	100	117	P	H	
		5860	47.91	-6.09	54	39.55	32.51	9.54	33.69	100	117	A	H	
														H
														H
														H
	*	5825	103.88	-	-	95.57	32.46	9.52	33.67	365	93	P	V	
	*	5825	97.45	-	-	89.14	32.46	9.52	33.67	365	93	A	V	
		5851.68	61.97	-16.33	78.3	53.63	32.48	9.54	33.68	365	93	P	V	
		5864.64	52.65	-21.35	74	44.29	32.51	9.54	33.69	365	93	P	V	
		5860.24	44.32	-9.68	54	35.96	32.51	9.54	33.69	365	93	A	V	
														V
														V
														V
														V
Remark	1. No other spurious found. 2. All results are PASS against Peak and Average limit line.													



Band 4 5725~5850MHz

WIFI 802.11a (Harmonic @ 3m)

WIFI Ant. 1	Note	Frequency (MHz)	Level (dBμV/m)	Over Limit (dB)	Limit Line (dBμV/m)	Read Level (dBμV)	Antenna Factor (dB/m)	Cable Loss (dB)	Preamp Factor (dB)	Ant Pos (cm)	Table Pos (deg)	Peak Avg. (P/A)	Pol. (H/V)
802.11a CH 149 5745MHz		11490	43.54	-30.46	74	55.42	39.91	13.95	65.74	100	0	P	H
		17232	43.53	-30.47	74	49.68	41	16.93	64.08	100	0	P	H
													H
													H
		11490	42.91	-31.09	74	54.79	39.91	13.95	65.74	100	0	P	V
		17235	55.03	-18.97	74	61.16	41	16.95	64.08	100	19	P	V
		17235	44.75	-9.25	54	50.88	41	16.95	64.08	100	19	A	V
802.11a CH 157 5785MHz		11570	43.42	-30.58	74	55.32	39.76	14	65.66	100	0	P	H
		17352	43.66	-30.34	74	49.53	41.35	17	64.22	100	0	P	H
													H
													H
		11570	42.65	-31.35	74	54.55	39.76	14	65.66	100	0	P	V
		17355	56.28	-17.72	74	62.12	41.35	17.03	64.22	100	15	P	V
		17355	46.55	-7.45	54	52.39	41.35	17.03	64.22	100	15	A	V
802.11a CH 165 5825MHz		11650	43.59	-30.41	74	55.54	39.62	14.05	65.62	100	0	P	H
		17475	42.97	-31.03	74	48.53	41.7	17.1	64.36	100	0	P	H
													H
													H
		11650	43.34	-30.66	74	55.29	39.62	14.05	65.62	100	0	P	V
		17475	55.64	-18.36	74	61.2	41.7	17.1	64.36	100	20	P	V
		17475	46.83	-7.17	54	52.39	41.7	17.1	64.36	100	20	A	V
Remark	1. No other spurious found. 2. All results are PASS against Peak and Average limit line.												



Band 4 5725~5850MHz

WIFI 802.11n HT20 (Band Edge @ 3m)

WIFI Ant. 1	Note	Frequency (MHz)	Level (dBμV/m)	Over Limit (dB)	Limit Line (dBμV/m)	Read Level (dBμV)	Antenna Factor (dB/m)	Cable Loss (dB)	Preamp Factor (dB)	Ant Pos (cm)	Table Pos (deg)	Peak Avg. (P/A)	Pol. (H/V)	
802.11n HT20 CH 149 5745MHz		5713.08	62.79	-11.21	74	54.75	32.29	9.39	33.64	100	118	P	H	
		5723.24	73.9	-4.4	78.3	65.79	32.31	9.44	33.64	100	118	P	H	
		5714.6	49.37	-4.63	54	41.33	32.29	9.39	33.64	100	118	A	H	
	*	5744	107.73	-	-	99.6	32.34	9.44	33.65	100	118	P	H	
	*	5744	100.44	-	-	92.31	32.34	9.44	33.65	100	118	A	H	
														H
														H
														H
			5714.12	51.34	-22.66	74	43.3	32.29	9.39	33.64	372	98	P	V
			5724.76	67.48	-10.82	78.3	59.37	32.31	9.44	33.64	372	98	P	V
			5714.76	43.85	-10.15	54	35.81	32.29	9.39	33.64	372	98	A	V
	*		5747	103.09	-	-	94.96	32.34	9.44	33.65	372	98	P	V
	*		5747	95.67	-	-	87.54	32.34	9.44	33.65	372	98	A	V
														V
														V
													V	



WIFI Ant. 1	Note	Frequency (MHz)	Level (dBμV/m)	Over Limit (dB)	Limit Line (dBμV/m)	Read Level (dBμV)	Antenna Factor (dB/m)	Cable Loss (dB)	Preamp Factor (dB)	Ant Pos (cm)	Table Pos (deg)	Peak Avg. (P/A)	Pol. (H/V)
802.11n HT20 CH 157 5785MHz		5713.8	54.06	-19.94	74	46.02	32.29	9.39	33.64	100	119	P	H
		5724.68	55.07	-23.23	78.3	46.96	32.31	9.44	33.64	100	119	P	H
		5705	46.23	-7.77	54	38.19	32.29	9.39	33.64	100	119	A	H
	*	5786	108.57	-	-	100.33	32.41	9.49	33.66	100	119	P	H
	*	5786	100.78	-	-	92.54	32.41	9.49	33.66	100	119	A	H
		5850.24	56.15	-22.15	78.3	47.81	32.48	9.54	33.68	100	119	P	H
		5866.16	54.69	-19.31	74	46.33	32.51	9.54	33.69	100	119	P	H
		5865.04	47.06	-6.94	54	38.7	32.51	9.54	33.69	100	119	A	H
		5704.6	49.47	-24.53	74	41.42	32.29	9.39	33.63	368	98	P	V
		5724.84	50.29	-28.01	78.3	42.18	32.31	9.44	33.64	368	98	P	V
		5705.08	41.47	-12.53	54	33.43	32.29	9.39	33.64	368	98	A	V
	*	5787	105.56	-	-	97.32	32.41	9.49	33.66	368	98	P	V
	*	5787	97.4	-	-	89.16	32.41	9.49	33.66	368	98	A	V
		5850.96	51.11	-27.19	78.3	42.77	32.48	9.54	33.68	368	98	P	V
		5867.12	50.7	-23.3	74	42.34	32.51	9.54	33.69	368	98	P	V
	5865.28	42.52	-11.48	54	34.16	32.51	9.54	33.69	368	98	A	V	



WIFI Ant. 1	Note	Frequency (MHz)	Level (dBμV/m)	Over Limit (dB)	Limit Line (dBμV/m)	Read Level (dBμV)	Antenna Factor (dB/m)	Cable Loss (dB)	Preamp Factor (dB)	Ant Pos (cm)	Table Pos (deg)	Peak Avg. (P/A)	Pol. (H/V)	
802.11n HT20 CH 165 5825MHz	*	5826	108.36	-	-	100.05	32.46	9.52	33.67	100	120	P	H	
	*	5826	100.65	-	-	92.34	32.46	9.52	33.67	100	120	A	H	
		5850.88	72.54	-5.76	78.3	64.2	32.48	9.54	33.68	100	120	P	H	
		5860.48	58.05	-15.95	74	49.69	32.51	9.54	33.69	100	120	P	H	
		5860.24	49.25	-4.75	54	40.89	32.51	9.54	33.69	100	120	A	H	
														H
														H
														H
	*	5824	103.55	-	-	95.24	32.46	9.52	33.67	381	92	P	V	
	*	5824	97.32	-	-	89.01	32.46	9.52	33.67	381	92	A	V	
		5852.64	67.02	-11.28	78.3	58.68	32.48	9.54	33.68	381	92	P	V	
		5861.36	55.91	-18.09	74	47.55	32.51	9.54	33.69	381	92	P	V	
		5860.24	45.77	-8.23	54	37.41	32.51	9.54	33.69	381	92	A	V	
														V
														V
													V	
Remark	1. No other spurious found. 2. All results are PASS against Peak and Average limit line.													



Band 4 5725~5850MHz
WIFI 802.11n HT20 (Harmonic @ 3m)

WIFI Ant. 1	Note	Frequency (MHz)	Level (dBμV/m)	Over Limit (dB)	Limit Line (dBμV/m)	Read Level (dBμV)	Antenna Factor (dB/m)	Cable Loss (dB)	Preamp Factor (dB)	Ant Pos (cm)	Table Pos (deg)	Peak Avg. (P/A)	Pol. (H/V)	
802.11n HT20 CH 149 5745MHz		11490	43.6	-30.4	74	55.48	39.91	13.95	65.74	100	0	P	H	
		17235	45.37	-28.63	74	51.5	41	16.95	64.08	100	0	P	H	
													H	
													H	
			11490	43.13	-30.87	74	55.01	39.91	13.95	65.74	100	0	P	V
			17235	59.57	-14.43	74	65.7	41	16.95	64.08	100	19	P	V
			17235	46.84	-7.16	54	52.97	41	16.95	64.08	100	19	A	V
802.11n HT20 CH 157 5785MHz		11570	43.05	-30.95	74	54.95	39.76	14	65.66	100	0	P	H	
		17355	44.42	-29.58	74	50.26	41.35	17.03	64.22	100	0	P	H	
													H	
													H	
			11570	42.5	-31.5	74	54.4	39.76	14	65.66	100	0	P	V
			17355	57.17	-16.83	74	63.01	41.35	17.03	64.22	100	17	P	V
			17355	45.77	-8.23	54	51.61	41.35	17.03	64.22	100	17	A	V
802.11n HT20 CH 165 5825MHz		11650	42.65	-31.35	74	54.6	39.62	14.05	65.62	100	0	P	H	
		17475	43.89	-30.11	74	49.45	41.7	17.1	64.36	100	0	P	H	
													H	
													H	
			11650	43.06	-30.94	74	55.01	39.62	14.05	65.62	100	0	P	V
			17475	55.35	-18.65	74	60.91	41.7	17.1	64.36	100	15	P	V
			17475	46.04	-7.96	54	51.6	41.7	17.1	64.36	100	15	A	V
Remark	1. No other spurious found.													
	2. All results are PASS against Peak and Average limit line.													



Band 4 5725~5850MHz

WIFI 802.11n HT40 (Band Edge @ 3m)

WIFI Ant. 1	Note	Frequency (MHz)	Level (dBμV/m)	Over Limit (dB)	Limit Line (dBμV/m)	Read Level (dBμV)	Antenna Factor (dB/m)	Cable Loss (dB)	Preamp Factor (dB)	Ant Pos (cm)	Table Pos (deg)	Peak Avg. (P/A)	Pol. (H/V)	
802.11n HT40 CH 151 5755MHz		5711.72	65.09	-3.21	68.3	57.05	32.29	9.39	33.64	100	119	P	H	
		5718.6	73.33	-4.97	78.3	65.27	32.31	9.39	33.64	100	119	P	H	
	*	5755	100.84	-	-	92.69	32.36	9.44	33.65	100	119	P	H	
	*	5755	94.05	-	-	85.9	32.36	9.44	33.65	100	119	A	H	
		5851.12	50.11	-28.19	78.3	41.77	32.48	9.54	33.68	100	119	P	H	
		5885.04	49.95	-18.35	68.3	41.55	32.53	9.57	33.7	100	119	P	H	
														H
														H
			5714.52	60	-8.3	68.3	51.96	32.29	9.39	33.64	392	94	P	V
			5725	66.77	-11.53	78.3	58.66	32.31	9.44	33.64	392	94	P	V
	*		5755	95.81	-	-	87.66	32.36	9.44	33.65	392	94	P	V
	*		5755	88.95	-	-	80.8	32.36	9.44	33.65	392	94	A	V
			5854.8	49.81	-28.49	78.3	41.44	32.51	9.54	33.68	392	94	P	V
			5887.68	49.68	-18.62	68.3	41.25	32.56	9.57	33.7	392	94	P	V
														V
													V	



WIFI Ant. 1	Note	Frequency (MHz)	Level (dBμV/m)	Over Limit (dB)	Limit Line (dBμV/m)	Read Level (dBμV)	Antenna Factor (dB/m)	Cable Loss (dB)	Preamp Factor (dB)	Ant Pos (cm)	Table Pos (deg)	Peak Avg. (P/A)	Pol. (H/V)
802.11n HT40 CH 159 5795MHz		5713.32	52.03	-21.97	74	43.99	32.29	9.39	33.64	100	117	P	H
		5720.6	58.11	-20.19	78.3	50.05	32.31	9.39	33.64	100	117	P	H
		5712.28	44.16	-9.84	54	36.12	32.29	9.39	33.64	100	117	A	H
	*	5795	104.73	-	-	96.49	32.41	9.49	33.66	100	117	P	H
	*	5795	95.43	-	-	87.19	32.41	9.49	33.66	100	117	A	H
		5850.01	68.14	-10.16	78.3	59.8	32.48	9.54	33.68	100	117	P	H
		5865.36	59.99	-14.01	74	51.63	32.51	9.54	33.69	100	117	P	H
		5860	47.46	-6.54	54	39.1	32.51	9.54	33.69	100	117	A	H
		5707.72	49.07	-24.93	74	41.03	32.29	9.39	33.64	367	93	P	V
		5723.24	49.45	-28.85	78.3	41.34	32.31	9.44	33.64	367	93	P	V
		5713.32	40.86	-13.14	54	32.82	32.29	9.39	33.64	367	93	A	V
	*	5795	100.83	-	-	92.59	32.41	9.49	33.66	367	93	P	V
	*	5795	93.42	-	-	85.18	32.41	9.49	33.66	367	93	A	V
		5853.76	58.93	-19.37	78.3	50.56	32.51	9.54	33.68	367	93	P	V
		5866.64	52.91	-21.09	74	44.55	32.51	9.54	33.69	367	93	P	V
	5860	42.67	-11.33	54	34.31	32.51	9.54	33.69	367	93	A	V	
Remark	1. No other spurious found. 2. All results are PASS against Peak and Average limit line.												



Band 4 5725~5850MHz

WIFI 802.11n HT40 (Harmonic @ 3m)

WIFI Ant. 1	Note	Frequency (MHz)	Level (dBμV/m)	Over Limit (dB)	Limit Line (dBμV/m)	Read Level (dBμV)	Antenna Factor (dB/m)	Cable Loss (dB)	Preamp Factor (dB)	Ant Pos (cm)	Table Pos (deg)	Peak Avg. (P/A)	Pol. (H/V)
802.11n HT40 CH 151 5755MHz		11510	43.49	-30.51	74	55.34	39.9	13.95	65.7	100	0	P	H
		17265	43.36	-24.94	68.3	49.43	41.1	16.95	64.12	100	0	P	H
													H
													H
		11510	43.41	-30.59	74	55.26	39.9	13.95	65.7	100	0	P	V
		17268	42.85	-25.45	68.3	48.92	41.1	16.95	64.12	100	0	P	V
													V
													V
802.11n HT40 CH 159 5795MHz		11590	42.92	-31.08	74	54.84	39.73	14	65.65	100	0	P	H
		17385	44.09	-29.91	74	49.87	41.45	17.03	64.26	100	0	P	H
													H
													H
		11590	43.11	-30.89	74	55.03	39.73	14	65.65	100	0	P	V
		17385	45.61	-28.39	74	51.39	41.45	17.03	64.26	100	0	P	V
													V
													V
Remark	1. No other spurious found. 2. All results are PASS against Peak and Average limit line.												



Emission below 1GHz
5GHz WIFI 802.11a (LF @ 3m)

WIFI Ant. 1	Note	Frequency (MHz)	Level (dBμV/m)	Over Limit (dB)	Limit Line (dBμV/m)	Read Level (dBμV)	Antenna Factor (dB/m)	Cable Loss (dB)	Preamp Factor (dB)	Ant Pos (cm)	Table Pos (deg)	Peak Avg. (P/A)	Pol. (H/V)	
5GHz 802.11a LF		97.5	21.65	-21.85	43.5	36.29	15.86	1.28	31.78			P	H	
		165.27	28.53	-14.97	43.5	42.27	16.4	1.64	31.78			P	H	
		197.94	32.47	-11.03	43.5	46.75	15.86	1.64	31.78	160	96	P	H	
		542.2	25.82	-20.18	46	30.31	24.69	2.77	31.95			P	H	
		854.4	30.76	-15.24	46	30.05	28.93	3.44	31.66			P	H	
		976.9	33.35	-20.65	54	29.84	30.55	3.78	30.82			P	H	
														H
														H
														H
														H
														H
														H
														H
			31.35	29.35	-10.65	40	35.33	25.18	0.67	31.83			P	V
			63.75	30.29	-9.71	40	48.94	12.1	1.04	31.79	100	345	P	V
			194.43	26.34	-17.16	43.5	40.83	15.65	1.64	31.78			P	V
			431.6	25.12	-20.88	46	31.57	22.97	2.41	31.83			P	V
			759.2	28.77	-17.23	46	29.67	27.82	3.25	31.97			P	V
			981.8	33.06	-20.94	54	29.52	30.54	3.78	30.78			P	V
														V
													V	
													V	
													V	
													V	
													V	
Remark	1. No other spurious found. 2. All results are PASS against limit line.													



Emission below 1GHz
5GHz WIFI 802.11n HT20 (LF @ 3m)

WIFI Ant. 1	Note	Frequency (MHz)	Level (dBμV/m)	Over Limit (dB)	Limit Line (dBμV/m)	Read Level (dBμV)	Antenna Factor (dB/m)	Cable Loss (dB)	Preamp Factor (dB)	Ant Pos (cm)	Table Pos (deg)	Peak Avg. (P/A)	Pol. (H/V)	
5GHz 802.11n HT20 LF		98.31	21.61	-21.89	43.5	36.25	15.86	1.28	31.78	-	-	P	H	
		165.54	26.12	-17.38	43.5	39.96	16.3	1.64	31.78	-	-	P	H	
		196.86	33.33	-10.17	43.5	47.68	15.79	1.64	31.78	170	99	P	H	
		352.5	21.75	-24.25	46	30.21	21.15	2.17	31.78	-	-	P	H	
		777.4	30.27	-15.73	46	30.84	28.03	3.35	31.95	-	-	P	H	
		976.2	33.31	-20.69	54	29.81	30.55	3.78	30.83	-	-	P	H	
														H
														H
														H
														H
														H
														H
			31.08	29.71	-10.29	40	35.69	25.18	0.67	31.83	-	-	P	V
			63.48	31.02	-8.98	40	49.67	12.1	1.04	31.79	100	352	P	V
			198.75	25.59	-17.91	43.5	39.8	15.93	1.64	31.78	-	-	P	V
			544.3	25.03	-20.97	46	29.5	24.72	2.77	31.96	-	-	P	V
			716.5	28.99	-17.01	46	30.84	27.03	3.14	32.02	-	-	P	V
			993.7	33.45	-20.55	54	29.85	30.51	3.78	30.69	-	-	P	V
													V	
													V	
													V	
													V	
													V	
													V	
Remark	1. No other spurious found. 2. All results are PASS against limit line.													



Emission below 1GHz
5GHz WIFI 802.11n HT40 (LF @ 3m)

WIFI Ant. 1	Note	Frequency (MHz)	Level (dBμV/m)	Over Limit (dB)	Limit Line (dBμV/m)	Read Level (dBμV)	Antenna Factor (dB/m)	Cable Loss (dB)	Preamp Factor (dB)	Ant Pos (cm)	Table Pos (deg)	Peak Avg. (P/A)	Pol. (H/V)	
5GHz 802.11n HT40 LF		99.39	23.58	-19.92	43.5	37.98	16.1	1.28	31.78	-	-	P	H	
		164.46	25.73	-17.77	43.5	39.65	16.4	1.46	31.78	-	-	P	H	
		200.37	31.72	-11.78	43.5	45.84	16.02	1.64	31.78	130	105	P	H	
		518.4	24.92	-21.08	46	29.84	24.36	2.64	31.92	-	-	P	H	
		841.8	30.71	-15.29	46	30.21	28.81	3.4	31.71	-	-	P	H	
		995.8	33.48	-20.52	54	29.86	30.51	3.78	30.67	-	-	P	H	
														H
														H
														H
														H
														H
														H
			32.43	28.86	-11.14	40	35.88	24.14	0.67	31.83	-	-	P	V
			63.21	31.59	-8.41	40	50.29	12.05	1.04	31.79	100	348	P	V
			198.21	25.09	-18.41	43.5	39.37	15.86	1.64	31.78	-	-	P	V
			433.7	24.38	-21.62	46	30.79	23.01	2.41	31.83	-	-	P	V
			732.6	29.33	-16.67	46	30.73	27.35	3.25	32	-	-	P	V
			965	33.45	-20.55	54	30.02	30.57	3.78	30.92	-	-	P	V
													V	
													V	
													V	
													V	
													V	
													V	
Remark	1. No other spurious found. 2. All results are PASS against limit line.													



Note symbol

*	Fundamental Frequency which can be ignored. However, the level of any unwanted emissions shall not exceed the level of the fundamental frequency.
!	Test result is over limit line.
P/A	Peak or Average
H/V	Horizontal or Vertical



A calculation example for radiated spurious emission is shown as below:

WIFI Ant. 1	Note	Frequency (MHz)	Level (dBμV/m)	Over Limit (dB)	Limit Line (dBμV/m)	Read Level (dBμV)	Antenna Factor (dB/m)	Cable Loss (dB)	Preamp Factor (dB)	Ant Pos (cm)	Table Pos (deg)	Peak Avg. (P/A)	Pol. (H/V)
802.11b CH 01 2412MHz		2390	55.45	-18.55	74	54.51	32.22	4.58	35.86	103	308	P	H
		2390	43.54	-10.46	54	42.6	32.22	4.58	35.86	103	308	A	H

- Level(dBμV/m) =
Antenna Factor(dB/m) + Cable Loss(dB) + Read Level(dBμV) - Preamp Factor(dB)
- Over Limit(dB) = Level(dBμV/m) – Limit Line(dBμV/m)

For Peak Limit @ 2390MHz:

- Level(dBμV/m)
= Antenna Factor(dB/m) + Cable Loss(dB) + Read Level(dBμV) - Preamp Factor(dB)
= 32.22(dB/m) + 4.58(dB) + 54.51(dBμV) – 35.86 (dB)
= 55.45 (dBμV/m)
- Over Limit(dB)
= Level(dBμV/m) – Limit Line(dBμV/m)
= 55.45(dBμV/m) – 74(dBμV/m)
= -18.55(dB)

For Average Limit @ 2390MHz:

- Level(dBμV/m)
= Antenna Factor(dB/m) + Cable Loss(dB) + Read Level(dBμV) - Preamp Factor(dB)
= 32.22(dB/m) + 4.58(dB) + 42.6(dBμV) – 35.86 (dB)
= 43.54 (dBμV/m)
- Over Limit(dB)
= Level(dBμV/m) – Limit Line(dBμV/m)
= 43.54(dBμV/m) – 54(dBμV/m)
= -10.46(dB)

Both peak and average measured complies with the limit line, so test result is “PASS”.



Appendix C. Radiated Spurious Emission Plots

Note symbol

-L	Low channel location
-R	High channel location



Band 4 - 5725~5850MHz
WIFI 802.11a (Band Edge @ 3m)

WIFI	Band 4 5725~5850MHz Band Edge @ 3m	
ANT	802.11a CH149 5745MHz	
1	Horizontal	Vertical
Peak	<p>Site : 03CH11-HY Condition : FCC CLASS-B_BAND 4 3m HORN 9120D-HF HORIZONTAL Detector : Peak</p>	<p>Site : 03CH11-HY Condition : FCC CLASS-B_BAND 4 3m HORN 9120D-HF VERTICAL Detector : Peak</p>
Avg.	<p>Site : 03CH11-HY Condition : FCC CLASS-B (AVG) 3m HORN 9120D-HF HORIZONTAL Detector : Peak</p>	<p>Site : 03CH11-HY Condition : FCC CLASS-B (AVG) 3m HORN 9120D-HF VERTICAL Detector : Peak</p>



WIFI	Band 4 5725~5850MHz Band Edge @ 3m	
ANT	802.11a CH157 5785MHz - L	
1	Horizontal	Vertical
Peak	<p>Site : 03CH11-HY Condition : FCC CLASS-B_BAND 4 3m HORN 9120D-HF HORIZONTAL RBW:1000.000KHz VBW:3000.000KHz SWT:Auto Detector : Peak</p>	<p>Site : 03CH11-HY Condition : FCC CLASS-B_BAND 4 3m HORN 9120D-HF VERTICAL RBW:1000.000KHz VBW:3000.000KHz SWT:Auto Detector : Peak</p>
Avg.	<p>Site : 03CH11-HY Condition : FCC CLASS-B (AVG) 3m HORN 9120D-HF HORIZONTAL RBW:1000.000KHz VBW:1.000KHz SWT:Auto Detector : Peak</p>	<p>Site : 03CH11-HY Condition : FCC CLASS-B (AVG) 3m HORN 9120D-HF VERTICAL RBW:1000.000KHz VBW:1.000KHz SWT:Auto Detector : Peak</p>

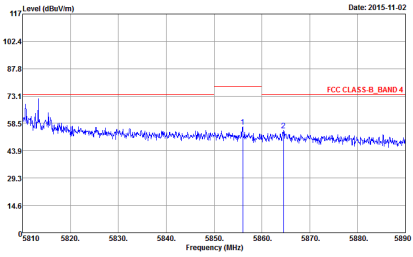
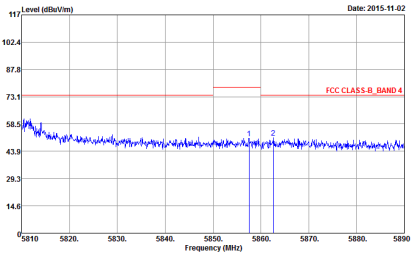
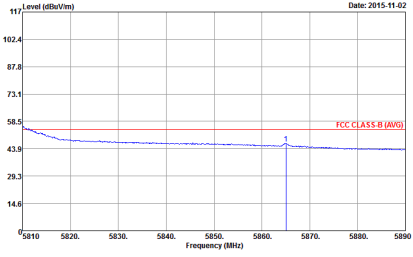
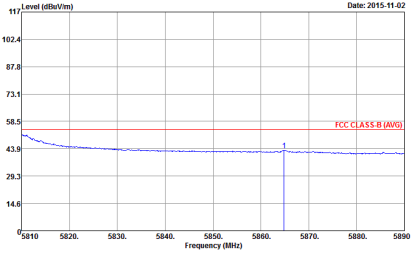

WIFI	Band 4 5725~5850MHz Band Edge @ 3m	
ANT	802.11a CH157 5785MHz - R	
1	Horizontal	Vertical
Peak	 <p>Site : 03CH11-HY Condition : FCC CLASS-B_BAND 4 3m HORN 9120D-HF HORIZONTAL RBW:1000.000KHz VBW:3000.000KHz SWT:Auto Detector : Peak</p>	 <p>Site : 03CH11-HY Condition : FCC CLASS-B_BAND 4 3m HORN 9120D-HF VERTICAL RBW:1000.000KHz VBW:3000.000KHz SWT:Auto Detector : Peak</p>
Avg.	 <p>Site : 03CH11-HY Condition : FCC CLASS-B (AVG) 3m HORN 9120D-HF HORIZONTAL RBW:1000.000KHz VBW:1.000KHz SWT:Auto Detector : Peak</p>	 <p>Site : 03CH11-HY Condition : FCC CLASS-B (AVG) 3m HORN 9120D-HF VERTICAL RBW:1000.000KHz VBW:1.000KHz SWT:Auto Detector : Peak</p>

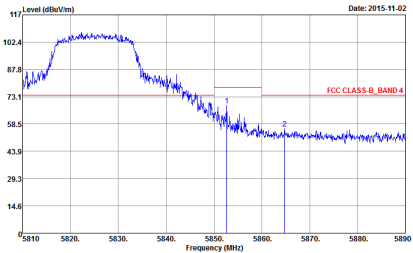
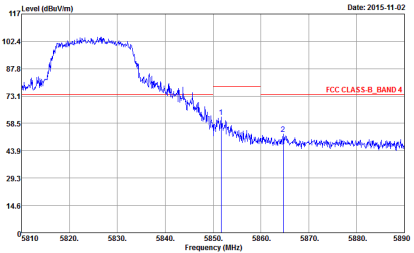
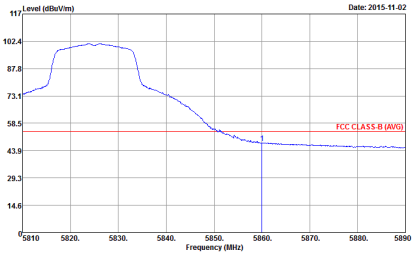
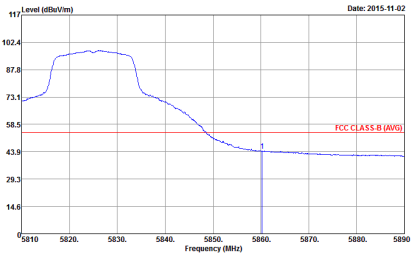

WIFI	Band 4 5725~5850MHz Band Edge @ 3m	
ANT	802.11a CH165 5825MHz	
1	Horizontal	Vertical
Peak	 <p>Site : 03CH11-HY Condition : FCC CLASS-B_BAND 4 3m HORN 9120D-HF HORIZONTAL RBW:1000.000KHz VBW:3000.000KHz SWT:Auto Detector : Peak</p>	 <p>Site : 03CH11-HY Condition : FCC CLASS-B_BAND 4 3m HORN 9120D-HF VERTICAL RBW:1000.000KHz VBW:3000.000KHz SWT:Auto Detector : Peak</p>
Avg.	 <p>Site : 03CH11-HY Condition : FCC CLASS-B (AVG) 3m HORN 9120D-HF HORIZONTAL RBW:1000.000KHz VBW:1.000KHz SWT:Auto Detector : Peak</p>	 <p>Site : 03CH11-HY Condition : FCC CLASS-B (AVG) 3m HORN 9120D-HF VERTICAL RBW:1000.000KHz VBW:1.000KHz SWT:Auto Detector : Peak</p>

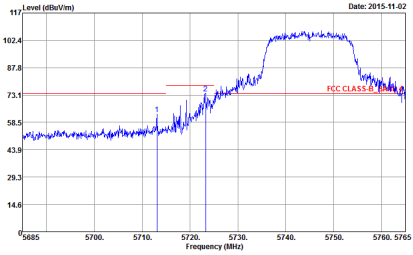
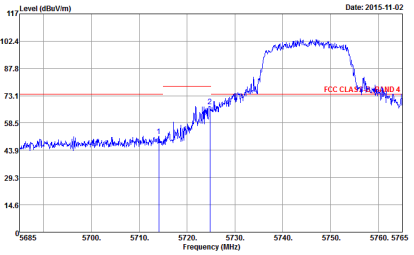
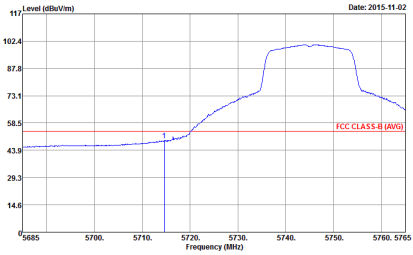
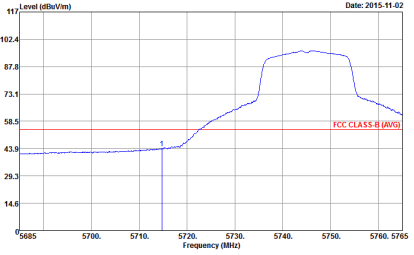

Band 4 5725~5850MHz
WIFI 802.11n HT20 (Band Edge @ 3m)

WIFI	Band 4 5725~5850MHz Band Edge @ 3m	
ANT	802.11n HT20 CH149 5745MHz	
1	Horizontal	Vertical
Peak	 <p>Site : 03CH11-HY Condition : FCC CLASS-B_BAND 4 3m HORN 9120D-HF HORIZONTAL RBW:1000.000KHz VBW:3000.000KHz SWT:Auto Detector : Peak</p>	 <p>Site : 03CH11-HY Condition : FCC CLASS-B_BAND 4 3m HORN 9120D-HF VERTICAL RBW:1000.000KHz VBW:3000.000KHz SWT:Auto Detector : Peak</p>
Avg.	 <p>Site : 03CH11-HY Condition : FCC CLASS-B (AVG) 3m HORN 9120D-HF HORIZONTAL RBW:1000.000KHz VBW:1.000KHz SWT:Auto Detector : Peak</p>	 <p>Site : 03CH11-HY Condition : FCC CLASS-B (AVG) 3m HORN 9120D-HF VERTICAL RBW:1000.000KHz VBW:1.000KHz SWT:Auto Detector : Peak</p>

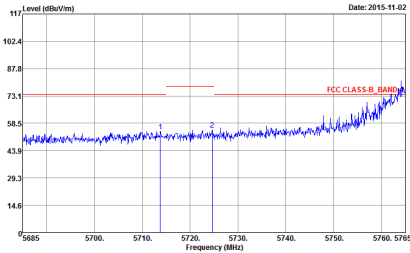
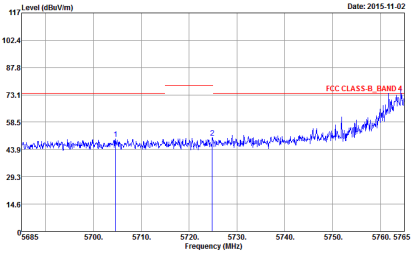
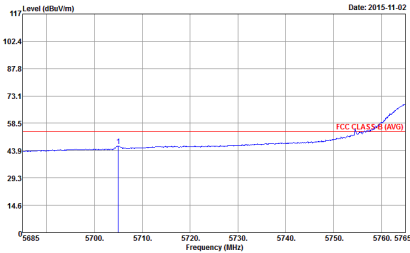
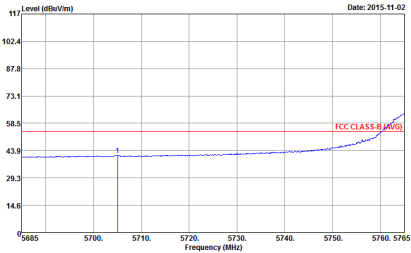

WIFI	Band 4 5725~5850MHz Band Edge @ 3m	
ANT	802.11n HT20 CH157 5785MHz - L	
1	Horizontal	Vertical
Peak	 <p>Site : 03CH11-HY Condition : FCC CLASS-B_BAND 4 3m HORN 9120D-HF HORIZONTAL RBW:1000.000KHz VBW:3000.000KHz SWT:Auto Detector : Peak</p>	 <p>Site : 03CH11-HY Condition : FCC CLASS-B_BAND 4 3m HORN 9120D-HF VERTICAL RBW:1000.000KHz VBW:3000.000KHz SWT:Auto Detector : Peak</p>
Avg.	 <p>Site : 03CH11-HY Condition : FCC CLASS-B (AVG) 3m HORN 9120D-HF HORIZONTAL RBW:1000.000KHz VBW:1.000KHz SWT:Auto Detector : Peak</p>	 <p>Site : 03CH11-HY Condition : FCC CLASS-B (AVG) 3m HORN 9120D-HF VERTICAL RBW:1000.000KHz VBW:1.000KHz SWT:Auto Detector : Peak</p>

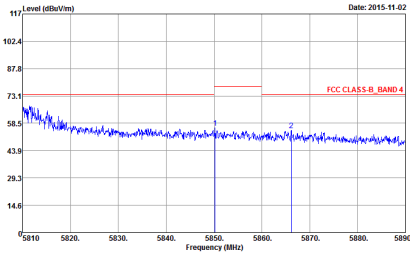
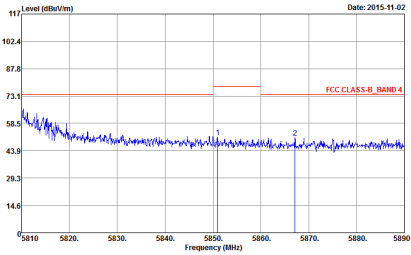
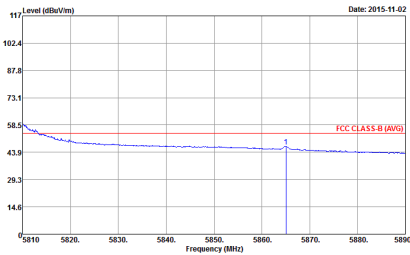
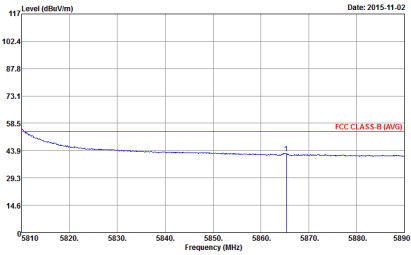

WIFI	Band 4 5725~5850MHz Band Edge @ 3m	
ANT	802.11n HT20 CH157 5785MHz - R	
1	Horizontal	Vertical
<p>Peak</p>	 <p>Site : 03CH11-HY Condition : FCC CLASS-B_BAND 4 3m HORN 9120D-HF HORIZONTAL RBW:1000.000KHz VBW:3000.000KHz SWT:Auto Detector : Peak</p>	 <p>Site : 03CH11-HY Condition : FCC CLASS-B_BAND 4 3m HORN 9120D-HF VERTICAL RBW:1000.000KHz VBW:3000.000KHz SWT:Auto Detector : Peak</p>
<p>Avg.</p>	 <p>Site : 03CH11-HY Condition : FCC CLASS-B (AVG) 3m HORN 9120D-HF HORIZONTAL RBW:1000.000KHz VBW:1.000KHz SWT:Auto Detector : Peak</p>	 <p>Site : 03CH11-HY Condition : FCC CLASS-B (AVG) 3m HORN 9120D-HF VERTICAL RBW:1000.000KHz VBW:1.000KHz SWT:Auto Detector : Peak</p>

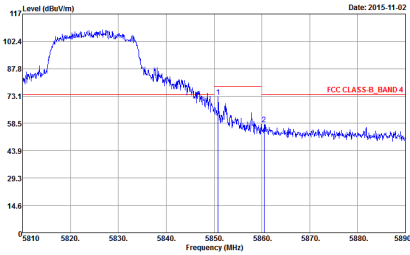
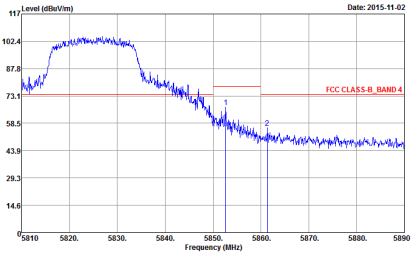
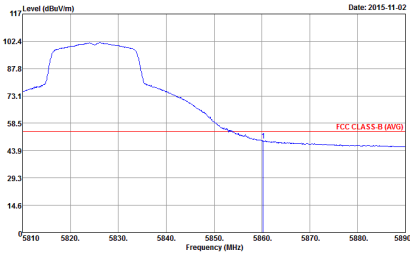
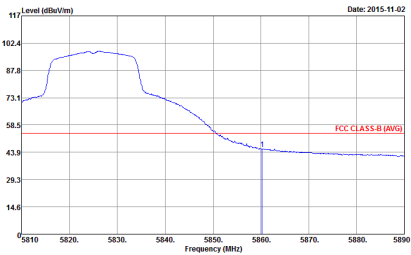

WIFI	Band 4 5725~5850MHz Band Edge @ 3m	
ANT	802.11n HT20 CH165 5825MHz	
1	Horizontal	Vertical
Peak	 <p>Site : 03CH11-HY Condition : FCC CLASS-B_BAND 4 3m HORN 9120D-HF HORIZONTAL RBW:1000.000KHz VBW:3000.000KHz SWT:Auto Detector : Peak</p>	 <p>Site : 03CH11-HY Condition : FCC CLASS-B_BAND 4 3m HORN 9120D-HF VERTICAL RBW:1000.000KHz VBW:3000.000KHz SWT:Auto Detector : Peak</p>
Avg.	 <p>Site : 03CH11-HY Condition : FCC CLASS-B (AVG) 3m HORN 9120D-HF HORIZONTAL RBW:1000.000KHz VBW:1.000KHz SWT:Auto Detector : Peak</p>	 <p>Site : 03CH11-HY Condition : FCC CLASS-B (AVG) 3m HORN 9120D-HF VERTICAL RBW:1000.000KHz VBW:1.000KHz SWT:Auto Detector : Peak</p>

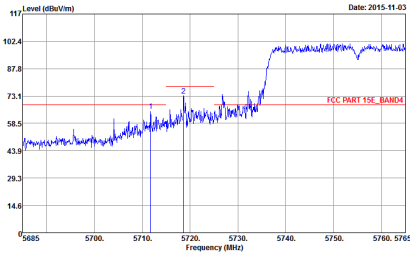
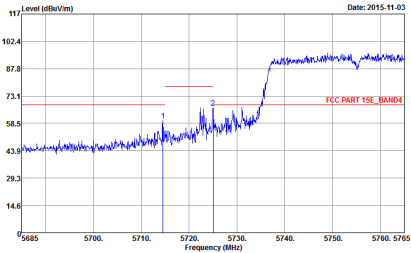

**Band 4 5725~5850MHz
WIFI 802.11n HT40 (Band Edge @ 3m)**

WIFI	Band 4 5725~5850MHz Band Edge @ 3m	
ANT	802.11n HT40 CH151 5755MHz - L	
1	Horizontal	Vertical
Peak	 <p>Site : 03CH11-HY Condition : FCC PART 15E_BAND4 3m HORN 9120D-HF HORIZONTAL RBW:1000.000KHz VBW:3000.000KHz SWT:Auto Detector : Peak</p>	 <p>Site : 03CH11-HY Condition : FCC PART 15E_BAND4 3m HORN 9120D-HF VERTICAL RBW:1000.000KHz VBW:3000.000KHz SWT:Auto Detector : Peak</p>

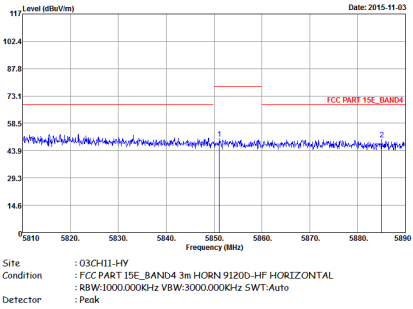
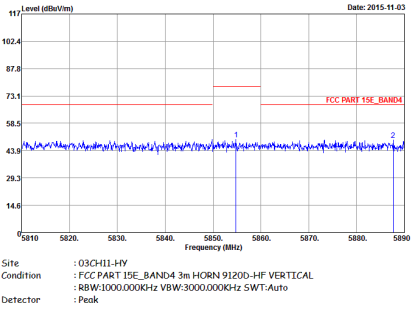

WIFI	Band 4 5725~5850MHz Band Edge @ 3m	
ANT	802.11n HT40 CH151 5755MHz - R	
1	Horizontal	Vertical
Peak	 <p>Site : 03CH11-HY Condition : FCC PART 15E_BAND4 3m HORN 9120D-HF HORIZONTAL RBW:1000.000KHz VBW:3000.000KHz SWT-Auto Detector : Peak</p>	 <p>Site : 03CH11-HY Condition : FCC PART 15E_BAND4 3m HORN 9120D-HF VERTICAL RBW:1000.000KHz VBW:3000.000KHz SWT-Auto Detector : Peak</p>



WIFI	Band 4 5725~5850MHz Band Edge @ 3m	
ANT	802.11n HT40 CH159 5795MHz - L	
1	Horizontal	Vertical
<p>Peak</p>	<p>Site : 03CH11-HY Condition : FCC CLASS-B_BAND 4 3m HORN 9120D-HF HORIZONTAL Detector : Peak</p>	<p>Site : 03CH11-HY Condition : FCC CLASS-B_BAND 4 3m HORN 9120D-HF VERTICAL Detector : Peak</p>
<p>Avg.</p>	<p>Site : 03CH11-HY Condition : FCC CLASS-B (AVG) 3m HORN 9120D-HF HORIZONTAL Detector : Peak</p>	<p>Site : 03CH11-HY Condition : FCC CLASS-B (AVG) 3m HORN 9120D-HF VERTICAL Detector : Peak</p>

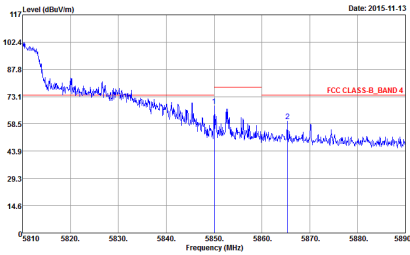
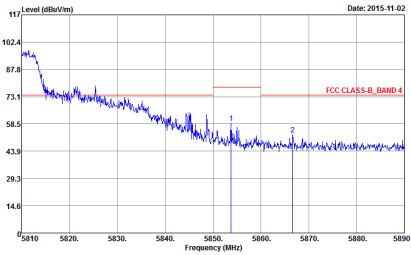
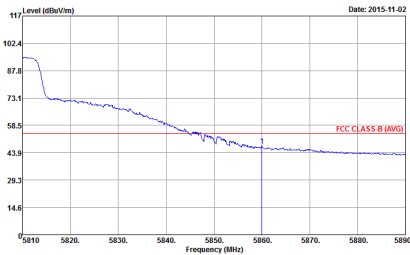
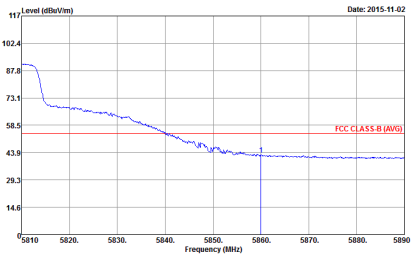

WIFI	Band 4 5725~5850MHz Band Edge @ 3m	
ANT	802.11n HT40 CH159 5795MHz - R	
1	Horizontal	Vertical
Peak	 <p>Site : 03CH11-HY Condition : FCC CLASS-B_BAND 4 3m HORN 9120D-HF HORIZONTAL RBW:1000.000KHz VBW:3000.000KHz SWT:Auto Detector : Peak</p>	 <p>Site : 03CH11-HY Condition : FCC CLASS-B_BAND 4 3m HORN 9120D-HF VERTICAL RBW:1000.000KHz VBW:3000.000KHz SWT:Auto Detector : Peak</p>
Avg.	 <p>Site : 03CH11-HY Condition : FCC CLASS-B (AVG) 3m HORN 9120D-HF HORIZONTAL RBW:1000.000KHz VBW:3.000KHz SWT:Auto Detector : Peak</p>	 <p>Site : 03CH11-HY Condition : FCC CLASS-B (AVG) 3m HORN 9120D-HF VERTICAL RBW:1000.000KHz VBW:3.000KHz SWT:Auto Detector : Peak</p>



Band 4 - 5725~5850MHz
WIFI 802.11a (Harmonic @ 3m)

Table with 3 columns: WIFI, ANT, and antenna orientation (Horizontal/Vertical). It contains two spectral plots showing Level (dBuV/m) vs Frequency (MHz) for Peak and Avg. measurements, with FCC CLASS-B BAND 4 and FCC CLASS-B (AVG) limits indicated.

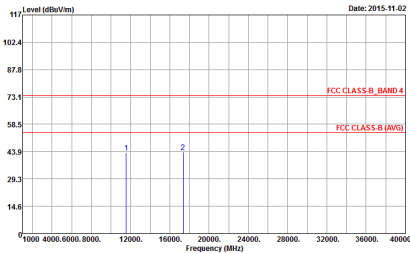
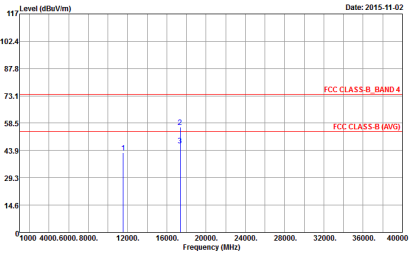

WIFI	Band 4 5725~5850MHz Harmonic @ 3m	
ANT	802.11a CH157 5785MHz	
1	Horizontal	Vertical
<p>Peak</p> <p>Avg.</p>	 <p>Site : 03CH11-HY Condition : FCC CLASS-B_BAND 4 3m 9170 SHF HORM_150809 HORIZONTAL Detector : Peak</p>	 <p>Site : 03CH11-HY Condition : FCC CLASS-B_BAND 4 3m 9170 SHF HORM_150809 VERTICAL Detector : Peak</p>

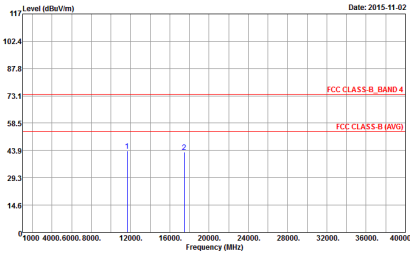
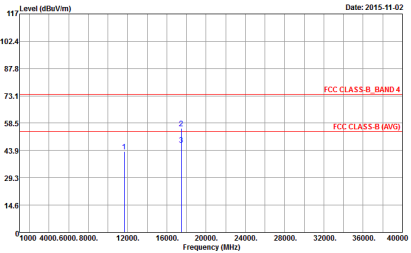

WIFI	Band 4 5725~5850MHz Harmonic @ 3m	
ANT	802.11a CH165 5825MHz	
1	Horizontal	Vertical
<p>Peak</p> <p>Avg.</p>	 <p>Site : 03CH11-HY Condition : FCC CLASS-B_BAND 4 3m 9170 SHF HORM_150809 HORIZONTAL Detector : Peak</p>	 <p>Site : 03CH11-HY Condition : FCC CLASS-B_BAND 4 3m 9170 SHF HORM_150809 VERTICAL Detector : Peak</p>



Band 4 5725~5850MHz
WIFI 802.11n HT20 (Harmonic @ 3m)

Table with 3 columns: WIFI, ANT, and 1. It contains two graphs showing Peak and Avg. levels for Horizontal and Vertical orientations. The graphs plot Level (dBuV/m) against Frequency (MHz) with FCC Class-B limits.

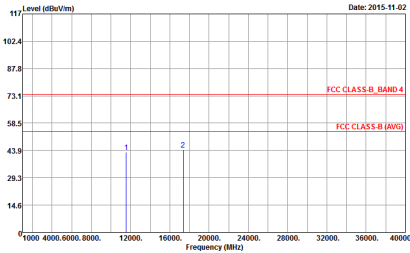
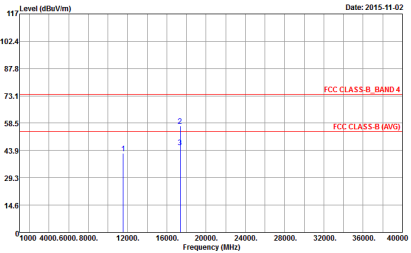

WIFI	Band 4 5725~5850MHz Harmonic @ 3m	
ANT	802.11n HT20 CH157 5785MHz	
1	Horizontal	Vertical
<p>Peak</p> <p>Avg.</p>	 <p>Site : 03CH11-HY Condition : FCC CLASS-B_BAND 4 3m 9170 SHF HORM_150809 HORIZONTAL Detector : Peak</p>	 <p>Site : 03CH11-HY Condition : FCC CLASS-B_BAND 4 3m 9170 SHF HORM_150809 VERTICAL Detector : Peak</p>



WIFI	Band 4 5725~5850MHz Harmonic @ 3m	
ANT	802.11n HT20 CH165 5825MHz	
1	Horizontal	Vertical
<p>Peak</p> <p>Avg.</p>	<p>Site : 03CH11-HY Condition : FCC CLASS-B_BAND 4 3m 9170 SHF HORM_150809 HORIZONTAL Detector : Peak</p>	<p>Site : 03CH11-HY Condition : FCC CLASS-B_BAND 4 3m 9170 SHF HORM_150809 VERTICAL Detector : Peak</p>



**Band 4 5725~5850MHz
WIFI 802.11n HT40 (Harmonic @ 3m)**

WIFI	Band 4 5725~5850MHz Harmonic @ 3m	
ANT	802.11n HT40 CH151 5755MHz	
1	Horizontal	Vertical
<p>Peak Avg.</p>	<p>Site : 03CH11-HY Condition : FCC PART 15E_BAND4 3m 9170 SHF HORM_150809 HORIZONTAL Detector : Peak</p>	<p>Site : 03CH11-HY Condition : FCC PART 15E_BAND4 3m 9170 SHF HORM_150809 VERTICAL Detector : Peak</p>



WIFI	Band 4 5725~5850MHz Harmonic @ 3m	
ANT	802.11n HT40 CH159 5795MHz	
1	Horizontal	Vertical
Peak Avg.	<p>Site : 03CH11-HY Condition : FCC CLASS-B_BAND 4 3m 9170 SHF HORM_150809 HORIZONTAL Detector : Peak</p>	<p>Site : 03CH11-HY Condition : FCC CLASS-B_BAND 4 3m 9170 SHF HORM_150809 VERTICAL Detector : Peak</p>



Emission below 1GHz
5GHz WIFI 802.11a (LF)

WIFI	5GHz 5725~5850MHz	
ANT	802.11a LF	
1	Horizontal	Vertical
QP / Peak	<p>Site : 03CH11-1#Y Condition : FCC CLASS-B 3m BT-LOG 6111D-LF_ETC HORIZONTAL Detector : Peak</p>	<p>Site : 03CH11-1#Y Condition : FCC CLASS-B 3m BT-LOG 6111D-LF_ETC VERTICAL Detector : Peak</p>



Emission below 1GHz
5GHz WIFI 802.11n HT20 (LF)

Table with 3 columns: WIFI (5GHz 5725~5850MHz), ANT (802.11n HT20 LF), and 1 (Horizontal/Vertical). It contains two spectral plots showing Level (dBuV/m) vs Frequency (MHz) for QP / Peak detection. The left plot is for Horizontal orientation and the right for Vertical. Both plots show a blue signal line and a red FCC CLASS-B limit line.



Emission below 1GHz
5GHz WIFI 802.11n HT40 (LF)

WIFI	5GHz 5725~5850MHz	
ANT	802.11n HT40 LF	
1	Horizontal	Vertical
QP / Peak	<p>Site : 00CH11-1V Condition : FCC CLASS-B 3m BT-LOG 6111D-LF_ETC HORIZONTAL Detector : Peak</p>	<p>Site : 00CH11-1V Condition : FCC CLASS-B 3m BT-LOG 6111D-LF_ETC VERTICAL Detector : Peak</p>