



# FCC RF Test Report

**APPLICANT** : Sony Mobile Communications Inc.  
**EQUIPMENT** : GSM/WCDMA/LTE Phone+Bluetooth,  
DTS/UNII a/b/g/n and NFC  
**BRAND NAME** : Sony  
**FCC ID** : PY7-PM0920  
**STANDARD** : FCC 47 CFR Part 2, 22(H), 24(E)  
**CLASSIFICATION** : PCS Licensed Transmitter Held to Ear (PCE)

The product was received on Oct. 07, 2015 and testing was completed on Nov. 30, 2015. We, SPORTON INTERNATIONAL INC., would like to declare that the tested sample has been evaluated in accordance with the test procedures given in ANSI / TIA / EIA-603-D-2010 and has been in compliance with the applicable technical standards.

The test results in this report apply exclusively to the tested model / sample. Without written approval of SPORTON INTERNATIONAL INC., the test report shall not be reproduced except in full.

Reviewed by: Joseph Lin / Supervisor

Approved by: Jones Tsai / Manager



## **SPORTON INTERNATIONAL INC.**

No. 52, Hwa Ya 1<sup>st</sup> Rd., Hwa Ya Technology Park, Kwei-Shan District, Tao Yuan City, Taiwan, R.O.C.



# TABLE OF CONTENTS

**REVISION HISTORY.....3**

**SUMMARY OF TEST RESULT .....4**

**1 GENERAL DESCRIPTION.....5**

    1.1 Applicant.....5

    1.2 Manufacturer .....5

    1.3 Product Feature of Equipment Under Test .....5

    1.4 Modification of EUT .....6

    1.5 Maximum ERP/EIRP Power, Frequency Tolerance, and Emission Designator .....7

    1.6 Testing Location .....8

    1.7 Applicable Standards .....8

**2 TEST CONFIGURATION OF EQUIPMENT UNDER TEST.....9**

    2.1 Test Mode.....9

    2.2 Connection Diagram of Test System .....10

    2.3 Support Unit used in test configuration .....10

    2.4 Measurement Results Explanation Example .....10

**3 CONDUCTED TEST RESULT.....11**

    3.1 Measuring Instruments.....11

    3.2 Test Setup .....11

    3.3 Test Result of Conducted Test.....11

    3.4 Conducted Output Power .....12

    3.5 Peak-to-Average Ratio .....13

    3.6 99% Occupied Bandwidth and 26dB Bandwidth Measurement.....14

    3.7 Conducted Band Edge .....15

    3.8 Conducted Spurious Emission .....16

    3.9 Frequency Stability.....17

**4 RADIATED TEST ITEMS .....18**

    4.1 Measuring Instruments.....18

    4.2 Test Setup .....18

    4.3 Test Result of Radiated Test.....18

    4.4 Effective Radiated Power and Effective Isotropic Radiated Power Measurement .....19

    4.5 Field Strength of Spurious Radiation Measurement .....21

**5 LIST OF MEASURING EQUIPMENT .....22**

**6 UNCERTAINTY OF EVALUATION.....24**

**APPENDIX A. TEST RESULTS OF CONDUCTED TEST**

**APPENDIX B. TEST RESULTS OF RADIATED TEST**



### REVISION HISTORY

REPORT NO.	VERSION	DESCRIPTION	ISSUED DATE
FG500716A	Rev. 01	Initial issue of report	Jan. 14, 2016



## SUMMARY OF TEST RESULT

Report Section	FCC Rule	Description	Limit	Result	Remark
3.4	§2.1046	Conducted Output Power	Reporting Only	PASS	-
3.5	§24.232(d)	Peak-to-Average Ratio	< 13 dB	PASS	-
3.6	§2.1049 §22.917(b) §24.238(b)	Occupied Bandwidth	Reporting Only	PASS	-
3.7	§2.1051 §22.917(a) §24.238(a)	Band Edge Measurement	< 43+10log10(P[Watts])	PASS	-
3.8	§2.1051 §22.917(a) §24.238(a)	Conducted Emission	< 43+10log10(P[Watts])	PASS	-
3.9	§2.1055 §22.355	Frequency Stability for Temperature & Voltage	< 2.5 ppm for Part 22	PASS	-
	§2.1055 §24.235		Within Authorized Band		
4.4	§22.913(a)(2)	Effective Radiated Power	< 7 Watts	PASS	-
	§24.232(c)	Equivalent Isotropic Radiated Power	< 2 Watts	PASS	-
4.5	§2.1053 §22.917(a) §24.238(a)	Field Strength of Spurious Radiation	< 43+10log10(P[Watts])	PASS	Under limit 25.68 dB at 2544.000 MHz



# 1 General Description

## 1.1 Applicant

Sony Mobile Communications Inc.  
Nya Vattentorget, 22188 Lund, Sweden

## 1.2 Manufacturer

Sony Mobile Communications Inc.  
1-8-15 Konan, Minato-ku, Tokyo, 108-0075, Japan

## 1.3 Product Feature of Equipment Under Test

GSM/WCDMA/LTE, Bluetooth, DTS/UNII, a/b/g/n, GPS, and NFC

Product Feature	
Antenna Type	Coupling type (LDS) Antenna

EUT Information List				
IMEI	HW Version	SW Version	S/N	Performed Test Item
00440245535512	A	33.2.A.0.19	RQ3000D4PB	RF conducted measurement ERP/EIRP Test
00440245535231			RQ3000D4EV	Radiated Spurious Emission



Accessory List	
AC Adapter 1	Model No. : UCH20
	Type No. : AC-0060-US
	S/N : 1215W43609278 (Radiated Spurious Emission)
Battery 1	Model No. : LIS1618ERPC
Earphone	Model No. : MH410c
	Type No. : AG-1100
	S/N : 1541A8180036F24 (Radiated Spurious Emission)
USB Cable 1	Model No. : EC803
	Type No. : AI-0404
	S/N : 153812A45005976 (Radiated Spurious Emission)

**Note:**

1. Above EUT list and accessory list used are electrically identical per declared by manufacturer.
2. Above the accessories list are used to exercise the EUT during test.
3. For other wireless features of this EUT, test report will be issued separately.

### 1.4 Modification of EUT

No modifications are made to the EUT during all test items.



### 1.5 Maximum ERP/EIRP Power, Frequency Tolerance, and Emission Designator

FCC Rule	System	Type of Modulation	Maximum ERP/EIRP (W)	Frequency Tolerance (ppm)	Emission Designator
Part 22	GSM850 GPRS class 8	GMSK	0.5718	0.0060 ppm	245KGXW
Part 22	GSM850 EDGE class 8	8PSK	0.1411	0.0072 ppm	248KG7W
Part 22	WCDMA Band V RMC 12.2Kbps	QPSK	0.0885	0.0203 ppm	4M20F9W
Part 24	GSM1900 GPRS class 8	GMSK	0.9538	0.0064 ppm	247KGXW
Part 24	GSM1900 EDGE class 8	8PSK	0.3286	0.0043 ppm	252KG7W
Part 24	WCDMA Band II RMC 12.2Kbps	QPSK	0.2446	0.0016 ppm	4M18F9W



### 1.6 Testing Location

Sporton Lab is accredited to ISO 17025 by Taiwan Accreditation Foundation (TAF code : 1190) and the FCC designation No. TW1022 under the FCC 2.948(e) by Mutual Recognition Agreement (MRA) in FCC Test.

<b>Test Site</b>	SPORTON INTERNATIONAL INC.
<b>Test Site Location</b>	No. 52, Hwa Ya 1 <sup>st</sup> Rd., Hwa Ya Technology Park, Kwei-Shan District, Tao Yuan City, Taiwan, R.O.C. TEL: +886-3-327-3456 FAX: +886-3-328-4978
<b>Test Site No.</b>	<b>Sporton Site No.</b>
	TH03-HY

<b>Test Site</b>	SPORTON INTERNATIONAL INC.
<b>Test Site Location</b>	No.58, Aly. 75, Ln. 564, Wenhua 3rd Rd. Guishan Dist, Taoyuan City, Taiwan (R.O.C.) TEL: +886-3-327-0868 FAX: +886-3-327-0855
<b>Test Site No.</b>	<b>Sporton Site No.</b>
	03CH10HY

### 1.7 Applicable Standards

According to the specifications of the manufacturer, the EUT must comply with the requirements of the following standards:

- ♦ 47 CFR Part 2, 22(H), 24(E)
- ♦ ANSI / TIA / EIA-603-D-2010
- ♦ FCC KDB 971168 D01 Power Meas. License Digital Systems v02r02

**Remark:**

1. All test items were verified and recorded according to the standards and without any deviation during the test.
2. This EUT has also been tested and complied with the requirements of FCC Part 15, Subpart B, recorded in a separate test report.





## 2 Test Configuration of Equipment Under Test

### 2.1 Test Mode

Antenna port conducted and radiated test items were performed according to KDB 971168 D01 Power Meas. License Digital Systems v02r02 with maximum output power.

Radiated measurements were performed with rotating EUT in different three orthogonal test planes to find the maximum emission.

Radiated emissions were investigated as following frequency range:

1. 30 MHz to 9000 MHz for GSM850 and WCDMA Band V.
2. 30 MHz to 19000 MHz for GSM1900 and WCDMA Band II.

All modes and data rates and positions were investigated.

Test modes are chosen to be reported as the worst case configuration below:

Test Modes		
Band	Radiated TCs	Conducted TCs
GSM 850	<ul style="list-style-type: none"><li>■ GPRS class 8 Link</li><li>■ EDGE class 8 Link</li></ul>	<ul style="list-style-type: none"><li>■ GPRS class 8 Link</li><li>■ EDGE class 8 Link</li></ul>
GSM 1900	<ul style="list-style-type: none"><li>■ GPRS class 8 Link</li><li>■ EDGE class 8 Link</li></ul>	<ul style="list-style-type: none"><li>■ GPRS class 8 Link</li><li>■ EDGE class 8 Link</li></ul>
WCDMA Band V	<ul style="list-style-type: none"><li>■ RMC 12.2Kbps Link</li></ul>	<ul style="list-style-type: none"><li>■ RMC 12.2Kbps Link</li></ul>
WCDMA Band II	<ul style="list-style-type: none"><li>■ RMC 12.2Kbps Link</li></ul>	<ul style="list-style-type: none"><li>■ RMC 12.2Kbps Link</li></ul>

## 2.2 Connection Diagram of Test System

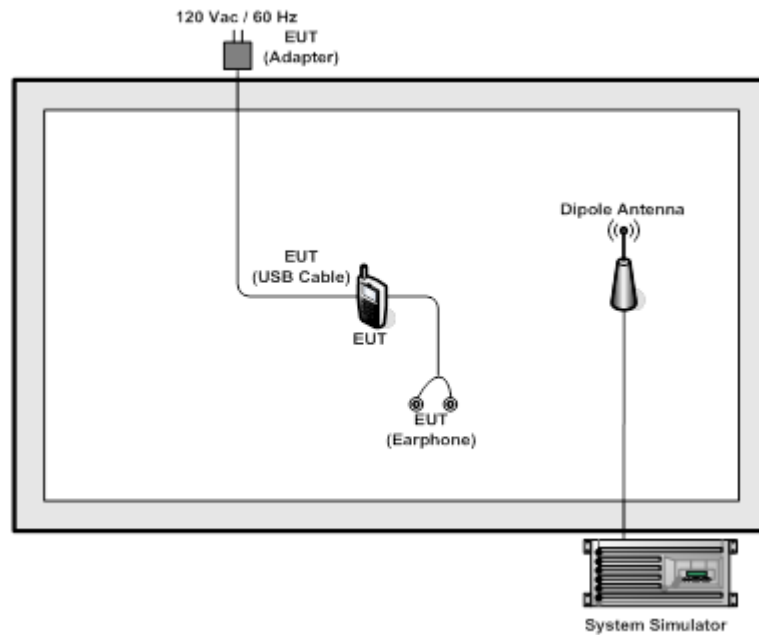

## 2.3 Support Unit used in test configuration

Item	Equipment	Trade Name	Model No.	FCC ID	Data Cable	Power Cord
1.	System Simulator	R&S	CMU 200	N/A	N/A	Unshielded, 1.8 m

## 2.4 Measurement Results Explanation Example

### For all conducted test items:

The offset level is set in the spectrum analyzer to compensate the RF cable loss and attenuator factor between RF conducted output port and spectrum analyzer. With the offset compensation, the spectrum analyzer reading level will be exactly the RF output level.

The spectrum analyzer offset is derived from RF cable loss and attenuator factor.

*Offset = RF cable loss + attenuator factor.*

The following shows an offset computation example with RF cable loss 4.2 dB and a 10dB attenuator.

Example :

$$\begin{aligned} \text{Offset(dB)} &= \text{RF cable loss(dB)} + \text{attenuator factor(dB)} \\ &= 4.2 + 10 = 14.2 \text{ (dB)} \end{aligned}$$

### 3 Conducted Test Result

#### 3.1 Measuring Instruments

See list of measuring instruments of this test report.

#### 3.2 Test Setup

##### 3.2.1 Conducted Output Power

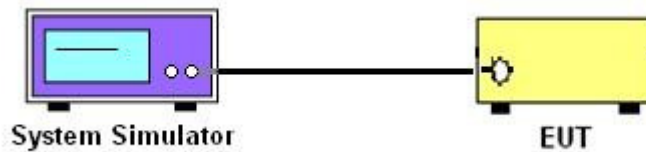

##### 3.2.2 Peak-to-Average Ratio, Occupied Bandwidth, Conducted Band-Edge and Conducted Spurious Emission

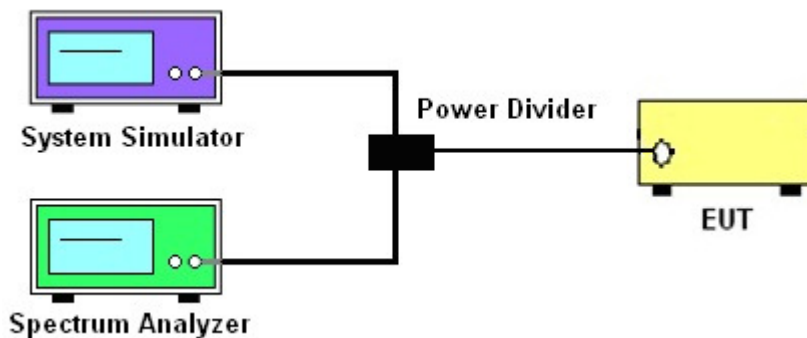

##### 3.2.3 Frequency Stability

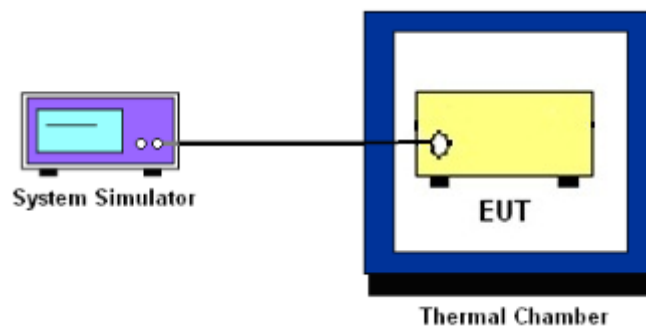

### 3.3 Test Result of Conducted Test

Please refer to Appendix A.



## **3.4 Conducted Output Power**

### **3.4.1 Description of the Conducted Output Power**

A system simulator was used to establish communication with the EUT. Its parameters were set to enforce EUT transmitting at the maximum power. The measured power in the radio frequency on the transmitter output terminals shall be reported.

### **3.4.2 Test Procedures**

1. The transmitter output port was connected to the system simulator.
2. Set EUT at maximum power through system simulator.
3. Select lowest, middle, and highest channels for each band and different modulation.
4. Measure the maximum burst average power for GSM and maximum average power for other modulation signal.



## **3.5 Peak-to-Average Ratio**

### **3.5.1 Description of the PAR Measurement**

The peak-to-average ratio (PAR) of the transmission may not exceed 13 dB.

### **3.5.2 Test Procedures**

1. The testing follows FCC KDB 971168 D01 v02r02 Section 5.7.1.
2. The EUT was connected to spectrum analyzer and system simulator via a power divider.
3. Set EUT to transmit at maximum output power.
4. When the duty cycle is less than 98%, then signal gating will be implemented on the spectrum analyzer by triggering from the system simulator.
5. Set the CCDF (Complementary Cumulative Distribution Function) option of the spectrum analyzer.  
Record the maximum PAPR level associated with a probability of 0.1%.



### **3.6 99% Occupied Bandwidth and 26dB Bandwidth Measurement**

#### **3.6.1 Description of 99% Occupied Bandwidth and 26dB Bandwidth Measurement**

The occupied bandwidth is the width of a frequency band such that, below the lower and above the upper frequency limits, the mean powers emitted are each equal to a specified percentage 0.5% of the total mean transmitted power.

The 26 dB emission bandwidth is defined as the frequency range between two points, one above and one below the carrier frequency, at which the spectral density of the emission is attenuated 26 dB below the maximum in-band spectral density of the modulated signal. Spectral density (power per unit bandwidth) is to be measured with a detector of resolution bandwidth equal to approximately 1.0% of the emission bandwidth.

#### **3.6.2 Test Procedures**

1. The testing follows FCC KDB 971168 v02r02 Section 4.2.
2. The EUT was connected to spectrum analyzer and system simulator via a power divider.
3. The spectrum analyzer center frequency is set to the nominal EUT channel center frequency. The span range for the spectrum analyzer shall be between two and five times the anticipated OBW.
4. The nominal resolution bandwidth (RBW) shall be in the range of 1 to 5 % of the anticipated OBW, and the VBW shall be at least 3 times the RBW.
5. Set the detection mode to peak, and the trace mode to max hold.
6. Determine the reference value: Set the EUT to transmit a modulated signal. Allow the trace to stabilize. Set the spectrum analyzer marker to the highest level of the displayed trace.  
(this is the reference value)
7. Determine the “-26 dB down amplitude” as equal to (Reference Value – X).
8. Place two markers, one at the lowest and the other at the highest frequency of the envelope of the spectral display such that each marker is at or slightly below the “-X dB down amplitude” determined in step 6. If a marker is below this “-X dB down amplitude” value it shall be placed as close as possible to this value. The OBW is the positive frequency difference between the two markers.
9. Use the 99 % power bandwidth function of the spectrum analyzer and report the measured bandwidth.



### 3.7 Conducted Band Edge

#### 3.7.1 Description of Conducted Band Edge Measurement

The power of any emission outside of the authorized operating frequency ranges must be lower than the transmitter power (P) by a factor of at least  $43 + 10 \log (P)$  dB.

#### 3.7.2 Test Procedures

1. The testing follows FCC KDB 971168 D01 v02r02 Section 6.0.
2. The EUT was connected to the spectrum analyzer and system simulator via a power divider.
3. The RF output of EUT was connected to the spectrum analyzer by an RF cable and attenuator. The path loss was compensated to the results for each measurement.
4. The band edges of low and high channels for the highest RF powers were measured.
5. The RF fundamental frequency should be excluded against the limit line in the operating frequency band.
6. The limit line is derived from  $43 + 10\log(P)$  dB below the transmitter power P(Watts)  
=  $P(W) - [43 + 10\log(P)]$  (dB)  
=  $[30 + 10\log(P)]$  (dBm) -  $[43 + 10\log(P)]$  (dB)  
= -13dBm.



### 3.8 Conducted Spurious Emission

#### 3.8.1 Description of Conducted Spurious Emission Measurement

The power of any emission outside of the authorized operating frequency ranges must be lower than the transmitter power (P) by a factor of at least  $43 + 10 \log (P)$  dB.

It is measured by means of a calibrated spectrum analyzer and scanned from 30 MHz up to a frequency including its 10<sup>th</sup> harmonic.

#### 3.8.2 Test Procedures

1. The testing follows FCC KDB 971168 D01 v02r02 Section 6.0.
2. The EUT was connected to the spectrum analyzer and system simulator via a power divider.
3. The RF output of EUT was connected to the spectrum analyzer by an RF cable and attenuator. The path loss was compensated to the results for each measurement.
4. The middle channel for the highest RF power within the transmitting frequency was measured.
5. The conducted spurious emission for the whole frequency range was taken.
6. The RF fundamental frequency should be excluded against the limit line in the operating frequency band.
7. The limit line is derived from  $43 + 10\log(P)$  dB below the transmitter power P(Watts)  
=  $P(W) - [43 + 10\log(P)]$  (dB)  
=  $[30 + 10\log(P)]$  (dBm) -  $[43 + 10\log(P)]$  (dB)  
= -13dBm.





### **3.9 Frequency Stability**

#### **3.9.1 Description of Frequency Stability Measurement**

The frequency stability shall be measured by variation of ambient temperature and variation of primary supply voltage to ensure that the fundamental emission stays within the authorized frequency block. The frequency stability of the transmitter shall be maintained within  $\pm 0.00025\%$  ( $\pm 2.5\text{ppm}$ ) of the center frequency.

#### **3.9.2 Test Procedures for Temperature Variation**

1. The testing follows FCC KDB 971168 D01 v02r02 Section 9.0.
2. The EUT was set up in the thermal chamber and connected with the system simulator.
3. With power OFF, the temperature was decreased to  $-30^{\circ}\text{C}$  and the EUT was stabilized before testing. Power was applied and the maximum change in frequency was recorded within one minute.
4. With power OFF, the temperature was raised in  $10^{\circ}\text{C}$  steps up to  $50^{\circ}\text{C}$ . The EUT was stabilized at each step for at least half an hour. Power was applied and the maximum frequency change was recorded within one minute.

#### **3.9.3 Test Procedures for Voltage Variation**

1. The testing follows FCC KDB 971168 D01 v02r02 Section 9.0.
2. The EUT was placed in a temperature chamber at  $25\pm 5^{\circ}\text{C}$  and connected with the system simulator.
3. The power supply voltage to the EUT was varied from 85% to 115% of the nominal value measured at the input to the EUT.
4. The variation in frequency was measured for the worst case.

## 4 Radiated Test Items

### 4.1 Measuring Instruments

See list of measuring instruments of this test report.

### 4.2 Test Setup

#### 4.2.1 For radiated test from 30MHz to 1GHz

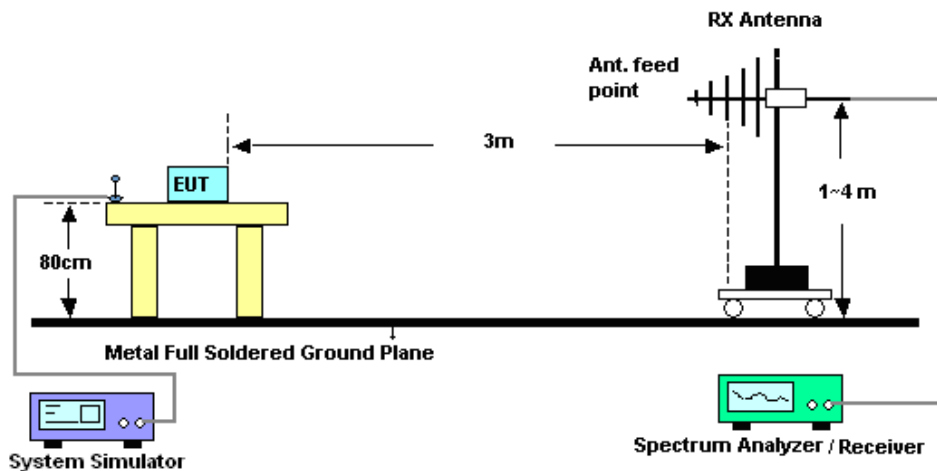

#### 4.2.2 For radiated test above 1GHz

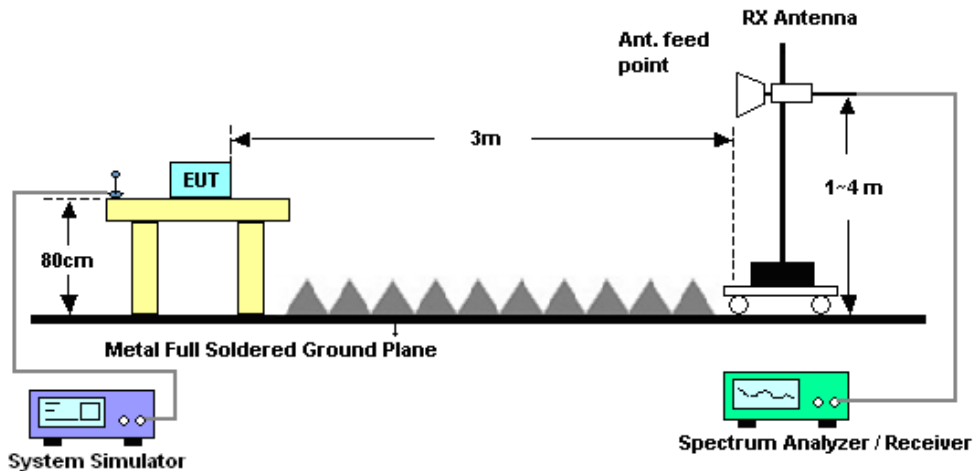

### 4.3 Test Result of Radiated Test

Please refer to Appendix B.



## 4.4 Effective Radiated Power and Effective Isotropic Radiated Power Measurement

### 4.4.1 Description of the ERP/EIRP Measurement

The substitution method, in ANSI / TIA / EIA-603-D-2010, was used for ERP/EIRP measurement, and the spectrum analyzer configuration follows KDB 971168 D01 Power Meas. License Digital Systems v02r02. The ERP of mobile transmitters must not exceed 7 Watts (Cellular Band) and the EIRP of mobile transmitters are limited to 2 Watts (PCS Band).

### 4.4.2 Test Procedures

1. The testing follows FCC KDB 971168 D01 v02r02 Section 5.2.1. (for CDMA/WCDMA), Section 5.2.2.2 (for GSM/GPRS/EDGE) and ANSI / TIA-603-D-2010 Section 2.2.17.
2. The EUT was placed on a non-conductive rotating platform 0.8 meters high in a semi-anechoic chamber. The radiated emission at the fundamental frequency was measured at 3 m with a test antenna and a spectrum analyzer with RMS detector per section 5. of KDB 971168 D01.
3. During the measurement, the system simulator parameters were set to force the EUT transmitting at maximum output power. The maximum emission was recorded from analyzer power level (LVL) from the 360 degrees rotation of the turntable and the test antenna raised and lowered over a range from 1 to 4 meters in both horizontally and vertically polarized orientations.
4. Effective Isotropic Radiated Power (EIRP) was measured by substitution method according to TIA/EIA-603-D. The EUT was replaced by the substitution antenna at same location, and then a known power from S.G. was applied into the dipole antenna through a Tx cable, and then recorded the maximum Analyzer reading through raised and lowered the test antenna. The correction factor (in dB) = S.G. - Tx Cable loss + Substitution antenna gain - Analyzer reading. Then the EUT's EIRP was calculated with the correction factor,  $EIRP = LVL + \text{Correction factor}$  and  $ERP = EIRP - 2.15$ . Take the record of the output power at substitution antenna.



	GSM/GPRS/EDGE	WCDMA/HSPA
SPAN	500kHz	10MHz
RBW	10kHz	100kHz
VBW	30kHz	300kHz
Detector	RMS	RMS
Trace	Average	Average
Average Type	Power	Power
Sweep Count	100	100



## 4.5 Field Strength of Spurious Radiation Measurement

### 4.5.1 Description of Field Strength of Spurious Radiated Measurement

The power of any emission outside of the authorized operating frequency ranges must be attenuated below the transmitter power (P) by a factor of at least  $43 + 10 \log (P)$  dB. The spectrum is scanned from 30 MHz up to a frequency including its 10th harmonic.

### 4.5.2 Test Procedures

1. The testing follows FCC KDB 971168 D01 v02r02 Section 5.8 and ANSI / TIA-603-D-2010 Section 2.2.12.
2. The EUT was placed on a rotatable wooden table 0.8 meters above the ground.
3. The EUT was set 3 meters from the receiving antenna, which was mounted on the antenna tower.
4. The table was rotated 360 degrees to determine the position of the highest spurious emission.
5. The height of the receiving antenna is varied between one meter and four meters to search for the maximum spurious emission for both horizontal and vertical polarizations.
6. Make the measurement with the spectrum analyzer's RBW = 1MHz, VBW = 3MHz, taking record of maximum spurious emission.
7. A horn antenna was substituted in place of the EUT and was driven by a signal generator.
8. Tune the output power of signal generator to the same emission level with EUT maximum spurious emission.
9. Taking the record of output power at antenna port.
10. Repeat step 7 to step 8 for another polarization.
11.  $EIRP \text{ (dBm)} = S.G. \text{ Power} - Tx \text{ Cable Loss} + Tx \text{ Antenna Gain}$
12.  $ERP \text{ (dBm)} = EIRP - 2.15$
13. The RF fundamental frequency should be excluded against the limit line in the operating frequency band.
14. The limit line is derived from  $43 + 10\log(P)$  dB below the transmitter power P(Watts)  
 $= P(W) - [43 + 10\log(P)] \text{ (dB)}$   
 $= [30 + 10\log(P)] \text{ (dBm)} - [43 + 10\log(P)] \text{ (dB)}$   
 $= -13\text{dBm}.$



## 5 List of Measuring Equipment

Instrument	Manufacturer	Model No.	Serial No.	Characteristics	Calibration Date	Test Date	Due Date	Remark
Hygrometer	Testo	608-H1	34893241	N/A	May 04, 2015	Nov. 01, 2015	May 03, 2016	Conducted (TH03-HY)
Spectrum Analyzer	Rohde & Schwarz	FSP30	101329	9kHz~30GHz	Jun. 24, 2015	Nov. 01, 2015	Jun. 23, 2016	Conducted (TH03-HY)
Temperature Chamber	ESPEC	SU-641	92013721	-30°C~70°C	Dec. 01, 2014	Nov. 01, 2015	Nov. 30, 2015	Conducted (TH03-HY)
Base Station(Measu	Rohde & Schwarz	CMU200	117995	GSM / GPRS / WCDMA / CDMA	Jul. 26, 2015	Nov. 01, 2015	Jul. 25, 2016	Conducted (TH03-HY)
RF cable	WOKEN	S05	S05-130708-2 2	N/A	Jan. 21, 2015	Nov. 01, 2015	Jan. 20, 2016	Conducted (TH03-HY)
Preamplifier	MITEQ	JS44-18004 000-33-8P	1840917	18GHz ~ 40GHz	Jun. 02, 2015	Oct. 28, 2015 ~ Nov. 30, 2015	Jun. 01, 2016	Radiation (03CH10-HY)
Horn Antenna	SCHWARZBECK	BBHA 9170	BBHA917058 4	18GHz- 40GHz	Nov. 03, 2014	Oct. 28, 2015 ~ Oct. 31, 2015	Nov. 02, 2015	Radiation (03CH10-HY)
Horn Antenna	SCHWARZBECK	BBHA 9170	BBHA917058 4	18GHz- 40GHz	Nov. 02, 2015	Nov. 17, 2015 ~ Nov. 30, 2015	Nov. 03, 2016	Radiation (03CH10-HY)
Amplifier	SONOMA	310N	187311	9kHz~1GHz	Nov. 24, 2014	Oct. 28, 2015 ~ Oct. 31, 2015	Nov. 23, 2015	Radiation (03CH10-HY)
Amplifier	SONOMA	310N	187311	9kHz~1GHz	Nov. 16, 2015	Nov. 17, 2015 ~ Nov. 30, 2015	Nov. 15, 2016	Radiation (03CH10-HY)
Bilog Antenna	TESEQ	CBL 6111D	35414	30MHz~1GHz	Nov. 17, 2015	Nov. 18, 2015 ~ Nov. 30, 2015	Nov. 16, 2016	Radiation (03CH10-HY)
EMI Test Receiver	Keysight	N9038A	MY54130085	20Hz ~ 8.4GHz	Nov. 05, 2014	Oct. 28, 2015 ~ Oct. 31, 2015	Nov. 04, 2015	Radiation (03CH10-HY)
EMI Test Receiver	Keysight	N9038A	MY54130085	20Hz ~ 8.4GHz	Nov. 04, 2015	Nov. 17, 2015 ~ Nov. 30, 2015	Nov. 03, 2016	Radiation (03CH10-HY)
Horn Antenna	SCHWARZBECK	BBHA 9120 D	9120D-1325	1GHz ~ 18GHz	Sep. 30, 2015	Oct. 28, 2015 ~ Nov. 30, 2015	Sep. 29, 2016	Radiation (03CH10-HY)
Preamplifier	Keysight	83017A	MY53270078	1GHz~26.5GHz	Nov. 20, 2014	Oct. 28, 2015 ~ Oct. 31, 2015	Nov. 19, 2015	Radiation (03CH10-HY)
Preamplifier	Keysight	83017A	MY53270078	1GHz~26.5GHz	Nov. 13, 2015	Nov. 17, 2015 ~ Nov. 30, 2015	Nov. 12, 2016	Radiation (03CH10-HY)
Spectrum Analyzer	Keysight	N9010A	MY54200485	10Hz ~ 44GHZ	Oct. 15, 2015	Oct. 28, 2015 ~ Nov. 30, 2015	Oct. 14, 2016	Radiation (03CH10-HY)
Controller	EMEC	EM 1000	N/A	Control Turn table & Ant Mast	N/A	Oct. 28, 2015 ~ Nov. 30, 2015	N/A	Radiation (03CH10-HY)
Antenna Mast	EMEC	AM-BS-450 0-B	N/A	1~4m	N/A	Oct. 28, 2015 ~ Nov. 30, 2015	N/A	Radiation (03CH10-HY)
Turn Table	EMEC	TT 2200	N/A	0-360 degree	N/A	Oct. 28, 2015 ~ Nov. 30, 2015	N/A	Radiation (03CH10-HY)
Hygrometer	TECPEL	DTM-303B	TP140320	N/A	Nov. 17, 2014	Oct. 28, 2015 ~ Oct. 31, 2015	Nov. 16, 2015	Radiation (03CH10-HY)
Hygrometer	TECPEL	DTM-303B	TP140320	N/A	Nov. 17, 2015	Nov. 17, 2015 ~ Nov. 30, 2015	Nov. 16, 2016	Radiation (03CH10-HY)
RF Cable	HUBER + SUHNER	SUCOFLEX 104	MY24958/4,M Y28653/4,MY	25GHz~40GHz	Jan. 13, 2015	Oct. 28, 2015 ~ Nov. 30, 2015	Jan. 12, 2016	Radiation (03CH10-HY)



Instrument	Manufacturer	Model No.	Serial No.	Characteristics	Calibration Date	Test Date	Due Date	Remark
Filter	Wainwright	WLKS1200-8SS	SN3	1.2G Low Pass	Oct. 01, 2015	Oct. 28, 2015 ~ Nov. 30, 2015	Sep. 30, 2016	Radiation (03CH10-HY)
Filter	Wainwright	WHK1.5/15 G-10SS	SN32	1.5G High Pass	Oct. 01, 2015	Oct. 28, 2015 ~ Nov. 30, 2015	Sep. 30, 2016	Radiation (03CH10-HY)
Filter	Microwave	H3G018G1	SN477220	3.0G High Pass	Oct. 01, 2015	Oct. 28, 2015 ~ Nov. 30, 2015	Sep. 30, 2016	Radiation (03CH10-HY)
Notch Filter	Wainwright	WRCG824/849-40/8SS	SN35	CDMA 850	Oct. 01, 2015	Oct. 28, 2015 ~ Nov. 30, 2015	Sep. 30, 2016	Radiation (03CH10-HY)
Notch Filter	Wainwright	WRCT1850/1910-40/8S	SN21	1900	Oct. 01, 2015	Oct. 28, 2015 ~ Nov. 30, 2015	Sep. 30, 2016	Radiation (03CH10-HY)
Test Software	Audix	E3	6.2009-8-24	N/A	N/A	Oct. 28, 2015 ~ Nov. 30, 2015	N/A	Radiation (03CH10-HY)



## 6 Uncertainty of Evaluation

### Uncertainty of Radiated Emission Measurement (30 MHz ~ 1000 MHz)

Measuring Uncertainty for a Level of Confidence of 95% ( $U = 2Uc(y)$ )	4.9
---	-----

### Uncertainty of Radiated Emission Measurement (1 GHz ~ 40 GHz)

Measuring Uncertainty for a Level of Confidence of 95% ( $U = 2Uc(y)$ )	5.5
---	-----





## Appendix A. Test Results of Conducted Test

### Conducted Output Power(Average power)

Conducted Power (*Unit: dBm)						
Band	GSM850			GSM1900		
Channel	128	189	251	512	661	810
Frequency	824.2	836.4	848.8	1850.2	1880.0	1909.8
GSM	33.24	33.21	33.03	30.17	30.14	30.35
GPRS class 8	33.25	33.23	33.07	30.18	30.16	30.37
GPRS class 10	30.20	30.17	29.96	26.50	26.61	26.59
GPRS class 11	28.66	28.61	28.38	24.85	24.96	25.40
GPRS class 12	27.81	27.74	27.49	24.06	24.18	24.64
EGPRS class 8	26.90	26.97	26.88	25.56	25.53	25.70
EGPRS class 10	26.80	26.87	26.81	25.17	25.26	25.48
EGPRS class 11	26.76	26.79	26.66	25.02	25.04	25.42
EGPRS class 12	26.62	26.67	26.50	24.45	24.55	24.88

Conducted Power (*Unit: dBm)						
Band	WCDMA Band V			WCDMA Band II		
Channel	4132	4182	4233	9262	9400	9538
Frequency	826.4	836.4	846.6	1852.4	1880	1907.6
RMC 12.2K	23.82	23.81	23.89	23.58	23.80	23.81
HSDPA Subtest-1	22.98	22.95	23.04	23.01	23.08	22.99
HSDPA Subtest-2	22.62	22.55	22.64	22.34	22.48	22.41
HSDPA Subtest-3	22.50	22.43	22.51	21.81	22.02	21.93
HSDPA Subtest-4	22.53	22.51	22.58	21.79	21.96	21.89
HSUPA Subtest-1	20.79	20.79	20.90	20.57	20.79	20.81
HSUPA Subtest-2	20.76	20.77	20.88	20.10	20.30	20.25
HSUPA Subtest-3	21.37	21.32	21.53	21.18	21.28	21.36
HSUPA Subtest-4	20.51	20.34	20.36	20.06	20.22	20.30
HSUPA Subtest-5	22.44	22.40	22.48	22.00	22.20	22.21



# A1. GSM

## Peak-to-Average Ratio

Mode	GSM850		Limit: 13dB
Mod.	GPRS class 8	EDGE class 8	Result
Lowest CH	0.24	3.20	PASS
Middle CH	0.20	3.32	
Highest CH	0.20	3.32	

Mode	GSM1900		Limit: 13dB
Mod.	GPRS class 8	EDGE class 8	Result
Lowest CH	0.20	3.28	PASS
Middle CH	0.24	3.40	
Highest CH	0.20	3.24	



GSM850 (GPRS class 8)	GSM850 (EDGE class 8)																
<p align="center"><b>Lowest Channel</b></p> <p>Ref: 35 dBm    Att: 30 dB    AQT: 3.125 ms</p> <p>Center: 824.2 MHz    2 dB/    Mean Pwr: +20 dB</p> <p>Complementary Cumulative Distribution Function (100000 samples)</p> <p>Trace 1</p> <p>Mean: 32.55 dBm Peak: 32.78 dBm Crest: 0.24 dB</p> <table border="1"> <tr><td>10 %</td><td>0.16 dB</td></tr> <tr><td>1 %</td><td>0.20 dB</td></tr> <tr><td>.1 %</td><td>0.24 dB</td></tr> <tr><td>.01 %</td><td>0.24 dB</td></tr> </table> <p>Date: 1.NOV.2015 09:34:14</p>	10 %	0.16 dB	1 %	0.20 dB	.1 %	0.24 dB	.01 %	0.24 dB	<p align="center"><b>Lowest Channel</b></p> <p>Ref: 35 dBm    Att: 30 dB    AQT: 3.125 ms</p> <p>Center: 824.2 MHz    2 dB/    Mean Pwr: +20 dB</p> <p>Complementary Cumulative Distribution Function (100000 samples)</p> <p>Trace 1</p> <p>Mean: 26.96 dBm Peak: 30.17 dBm Crest: 3.22 dB</p> <table border="1"> <tr><td>10 %</td><td>2.56 dB</td></tr> <tr><td>1 %</td><td>3.08 dB</td></tr> <tr><td>.1 %</td><td>3.20 dB</td></tr> <tr><td>.01 %</td><td>3.24 dB</td></tr> </table> <p>Date: 1.NOV.2015 09:52:35</p>	10 %	2.56 dB	1 %	3.08 dB	.1 %	3.20 dB	.01 %	3.24 dB
10 %	0.16 dB																
1 %	0.20 dB																
.1 %	0.24 dB																
.01 %	0.24 dB																
10 %	2.56 dB																
1 %	3.08 dB																
.1 %	3.20 dB																
.01 %	3.24 dB																
<p align="center"><b>Middle Channel</b></p> <p>Ref: 35 dBm    Att: 30 dB    AQT: 3.125 ms</p> <p>Center: 836.4 MHz    2 dB/    Mean Pwr: +20 dB</p> <p>Complementary Cumulative Distribution Function (100000 samples)</p> <p>Trace 1</p> <p>Mean: 32.52 dBm Peak: 32.71 dBm Crest: 0.19 dB</p> <table border="1"> <tr><td>10 %</td><td>0.20 dB</td></tr> <tr><td>1 %</td><td>0.20 dB</td></tr> <tr><td>.1 %</td><td>0.20 dB</td></tr> <tr><td>.01 %</td><td>0.20 dB</td></tr> </table> <p>Date: 1.NOV.2015 09:34:36</p>	10 %	0.20 dB	1 %	0.20 dB	.1 %	0.20 dB	.01 %	0.20 dB	<p align="center"><b>Middle Channel</b></p> <p>Ref: 35 dBm    Att: 30 dB    AQT: 3.125 ms</p> <p>Center: 836.4 MHz    2 dB/    Mean Pwr: +20 dB</p> <p>Complementary Cumulative Distribution Function (100000 samples)</p> <p>Trace 1</p> <p>Mean: 26.50 dBm Peak: 29.89 dBm Crest: 3.39 dB</p> <table border="1"> <tr><td>10 %</td><td>2.60 dB</td></tr> <tr><td>1 %</td><td>3.20 dB</td></tr> <tr><td>.1 %</td><td>3.32 dB</td></tr> <tr><td>.01 %</td><td>3.40 dB</td></tr> </table> <p>Date: 1.NOV.2015 09:52:53</p>	10 %	2.60 dB	1 %	3.20 dB	.1 %	3.32 dB	.01 %	3.40 dB
10 %	0.20 dB																
1 %	0.20 dB																
.1 %	0.20 dB																
.01 %	0.20 dB																
10 %	2.60 dB																
1 %	3.20 dB																
.1 %	3.32 dB																
.01 %	3.40 dB																
<p align="center"><b>Highest Channel</b></p> <p>Ref: 35 dBm    Att: 30 dB    AQT: 3.125 ms</p> <p>Center: 848.8 MHz    2 dB/    Mean Pwr: +20 dB</p> <p>Complementary Cumulative Distribution Function (100000 samples)</p> <p>Trace 1</p> <p>Mean: 32.67 dBm Peak: 32.92 dBm Crest: 0.26 dB</p> <table border="1"> <tr><td>10 %</td><td>0.20 dB</td></tr> <tr><td>1 %</td><td>0.20 dB</td></tr> <tr><td>.1 %</td><td>0.20 dB</td></tr> <tr><td>.01 %</td><td>0.20 dB</td></tr> </table> <p>Date: 1.NOV.2015 09:34:58</p>	10 %	0.20 dB	1 %	0.20 dB	.1 %	0.20 dB	.01 %	0.20 dB	<p align="center"><b>Highest Channel</b></p> <p>Ref: 35 dBm    Att: 30 dB    AQT: 3.125 ms</p> <p>Center: 848.8 MHz    2 dB/    Mean Pwr: +20 dB</p> <p>Complementary Cumulative Distribution Function (100000 samples)</p> <p>Trace 1</p> <p>Mean: 26.22 dBm Peak: 29.61 dBm Crest: 3.39 dB</p> <table border="1"> <tr><td>10 %</td><td>2.60 dB</td></tr> <tr><td>1 %</td><td>3.20 dB</td></tr> <tr><td>.1 %</td><td>3.32 dB</td></tr> <tr><td>.01 %</td><td>3.36 dB</td></tr> </table> <p>Date: 1.NOV.2015 09:53:17</p>	10 %	2.60 dB	1 %	3.20 dB	.1 %	3.32 dB	.01 %	3.36 dB
10 %	0.20 dB																
1 %	0.20 dB																
.1 %	0.20 dB																
.01 %	0.20 dB																
10 %	2.60 dB																
1 %	3.20 dB																
.1 %	3.32 dB																
.01 %	3.36 dB																



GSM1900 (GPRS class 8)	GSM1900 (EDGE class 8)																
<p align="center"><b>Lowest Channel</b></p> <p>Complementary Cumulative Distribution Function (100000 samples) Trace 1 Mean 31.06 dBm Peak 31.23 dBm Crest 0.17 dB</p> <table border="1"> <tr><td>10 %</td><td>0.16 dB</td></tr> <tr><td>1 %</td><td>0.20 dB</td></tr> <tr><td>.1 %</td><td>0.20 dB</td></tr> <tr><td>.01 %</td><td>0.20 dB</td></tr> </table> <p>Date: 1.NOV.2015 10:14:26</p>	10 %	0.16 dB	1 %	0.20 dB	.1 %	0.20 dB	.01 %	0.20 dB	<p align="center"><b>Lowest Channel</b></p> <p>Complementary Cumulative Distribution Function (100000 samples) Trace 1 Mean 26.66 dBm Peak 29.96 dBm Crest 3.30 dB</p> <table border="1"> <tr><td>10 %</td><td>2.56 dB</td></tr> <tr><td>1 %</td><td>3.16 dB</td></tr> <tr><td>.1 %</td><td>3.28 dB</td></tr> <tr><td>.01 %</td><td>3.32 dB</td></tr> </table> <p>Date: 1.NOV.2015 10:34:47</p>	10 %	2.56 dB	1 %	3.16 dB	.1 %	3.28 dB	.01 %	3.32 dB
10 %	0.16 dB																
1 %	0.20 dB																
.1 %	0.20 dB																
.01 %	0.20 dB																
10 %	2.56 dB																
1 %	3.16 dB																
.1 %	3.28 dB																
.01 %	3.32 dB																
<p align="center"><b>Middle Channel</b></p> <p>Complementary Cumulative Distribution Function (100000 samples) Trace 1 Mean 30.51 dBm Peak 30.74 dBm Crest 0.22 dB</p> <table border="1"> <tr><td>10 %</td><td>0.16 dB</td></tr> <tr><td>1 %</td><td>0.24 dB</td></tr> <tr><td>.1 %</td><td>0.24 dB</td></tr> <tr><td>.01 %</td><td>0.24 dB</td></tr> </table> <p>Date: 1.NOV.2015 10:14:47</p>	10 %	0.16 dB	1 %	0.24 dB	.1 %	0.24 dB	.01 %	0.24 dB	<p align="center"><b>Middle Channel</b></p> <p>Complementary Cumulative Distribution Function (100000 samples) Trace 1 Mean 25.33 dBm Peak 28.83 dBm Crest 3.50 dB</p> <table border="1"> <tr><td>10 %</td><td>2.52 dB</td></tr> <tr><td>1 %</td><td>3.20 dB</td></tr> <tr><td>.1 %</td><td>3.40 dB</td></tr> <tr><td>.01 %</td><td>3.48 dB</td></tr> </table> <p>Date: 1.NOV.2015 10:35:07</p>	10 %	2.52 dB	1 %	3.20 dB	.1 %	3.40 dB	.01 %	3.48 dB
10 %	0.16 dB																
1 %	0.24 dB																
.1 %	0.24 dB																
.01 %	0.24 dB																
10 %	2.52 dB																
1 %	3.20 dB																
.1 %	3.40 dB																
.01 %	3.48 dB																
<p align="center"><b>Highest Channel</b></p> <p>Complementary Cumulative Distribution Function (100000 samples) Trace 1 Mean 30.47 dBm Peak 30.67 dBm Crest 0.19 dB</p> <table border="1"> <tr><td>10 %</td><td>0.20 dB</td></tr> <tr><td>1 %</td><td>0.20 dB</td></tr> <tr><td>.1 %</td><td>0.20 dB</td></tr> <tr><td>.01 %</td><td>0.20 dB</td></tr> </table> <p>Date: 1.NOV.2015 10:15:07</p>	10 %	0.20 dB	1 %	0.20 dB	.1 %	0.20 dB	.01 %	0.20 dB	<p align="center"><b>Highest Channel</b></p> <p>Complementary Cumulative Distribution Function (100000 samples) Trace 1 Mean 25.97 dBm Peak 29.26 dBm Crest 3.28 dB</p> <table border="1"> <tr><td>10 %</td><td>2.56 dB</td></tr> <tr><td>1 %</td><td>3.08 dB</td></tr> <tr><td>.1 %</td><td>3.24 dB</td></tr> <tr><td>.01 %</td><td>3.28 dB</td></tr> </table> <p>Date: 1.NOV.2015 10:35:26</p>	10 %	2.56 dB	1 %	3.08 dB	.1 %	3.24 dB	.01 %	3.28 dB
10 %	0.20 dB																
1 %	0.20 dB																
.1 %	0.20 dB																
.01 %	0.20 dB																
10 %	2.56 dB																
1 %	3.08 dB																
.1 %	3.24 dB																
.01 %	3.28 dB																



**26dB Bandwidth**

Mode	GSM850	
Mod.	GPRS class 8	EDGE class 8
Lowest CH	0.315	0.295
Middle CH	0.315	0.297
Highest CH	0.313	0.313

Mode	GSM1900	
Mod.	GPRS class 8	EDGE class 8
Lowest CH	0.312	0.292
Middle CH	0.314	0.300
Highest CH	0.309	0.300

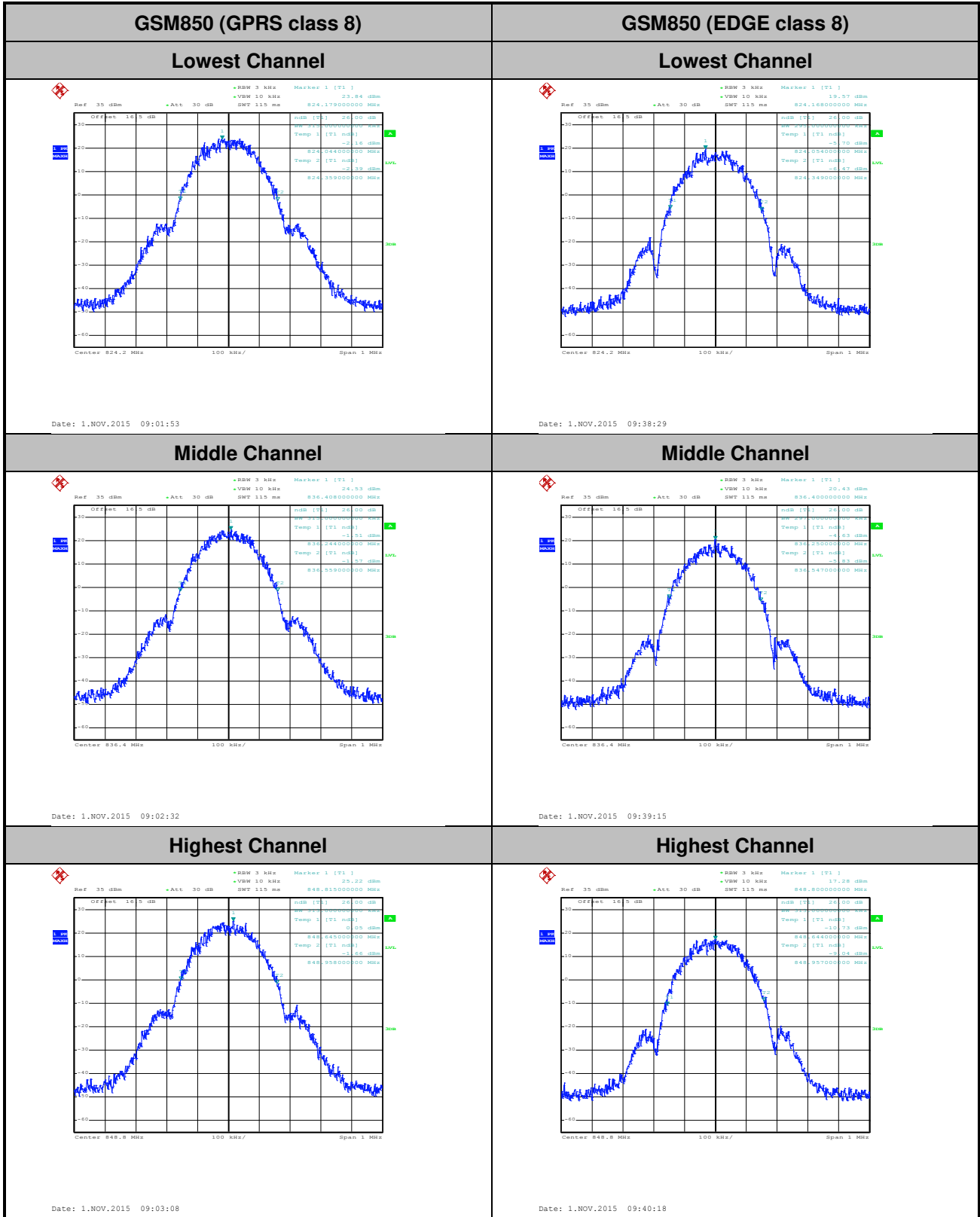

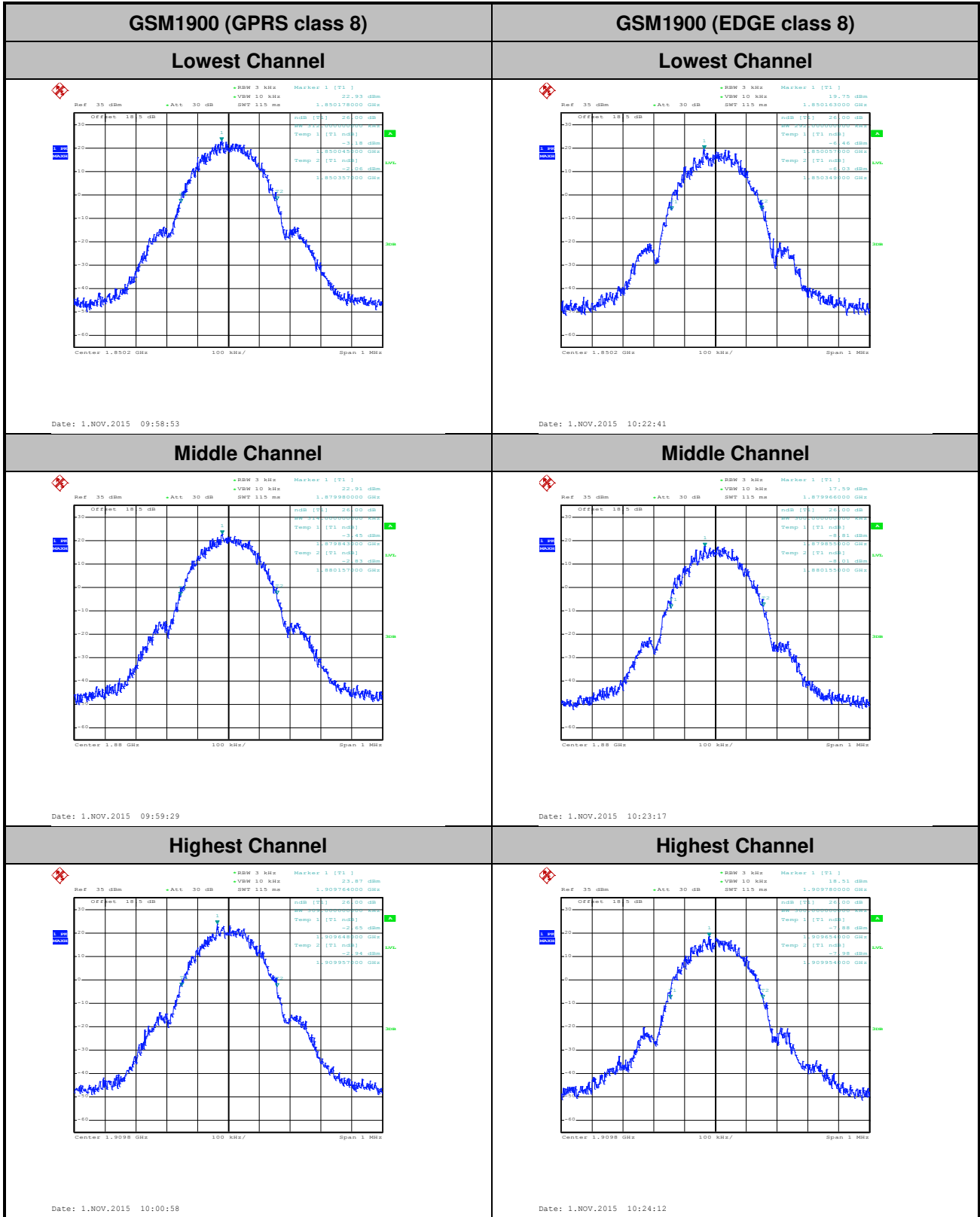



**Occupied Bandwidth**

Mode	GSM850	
Mod.	GPRS class 8	EDGE class 8
Lowest CH	0.244	0.248
Middle CH	0.245	0.247
Highest CH	0.244	0.245

Mode	GSM1900	
Mod.	GPRS class 8	EDGE class 8
Lowest CH	0.247	0.247
Middle CH	0.241	0.252
Highest CH	0.245	0.248



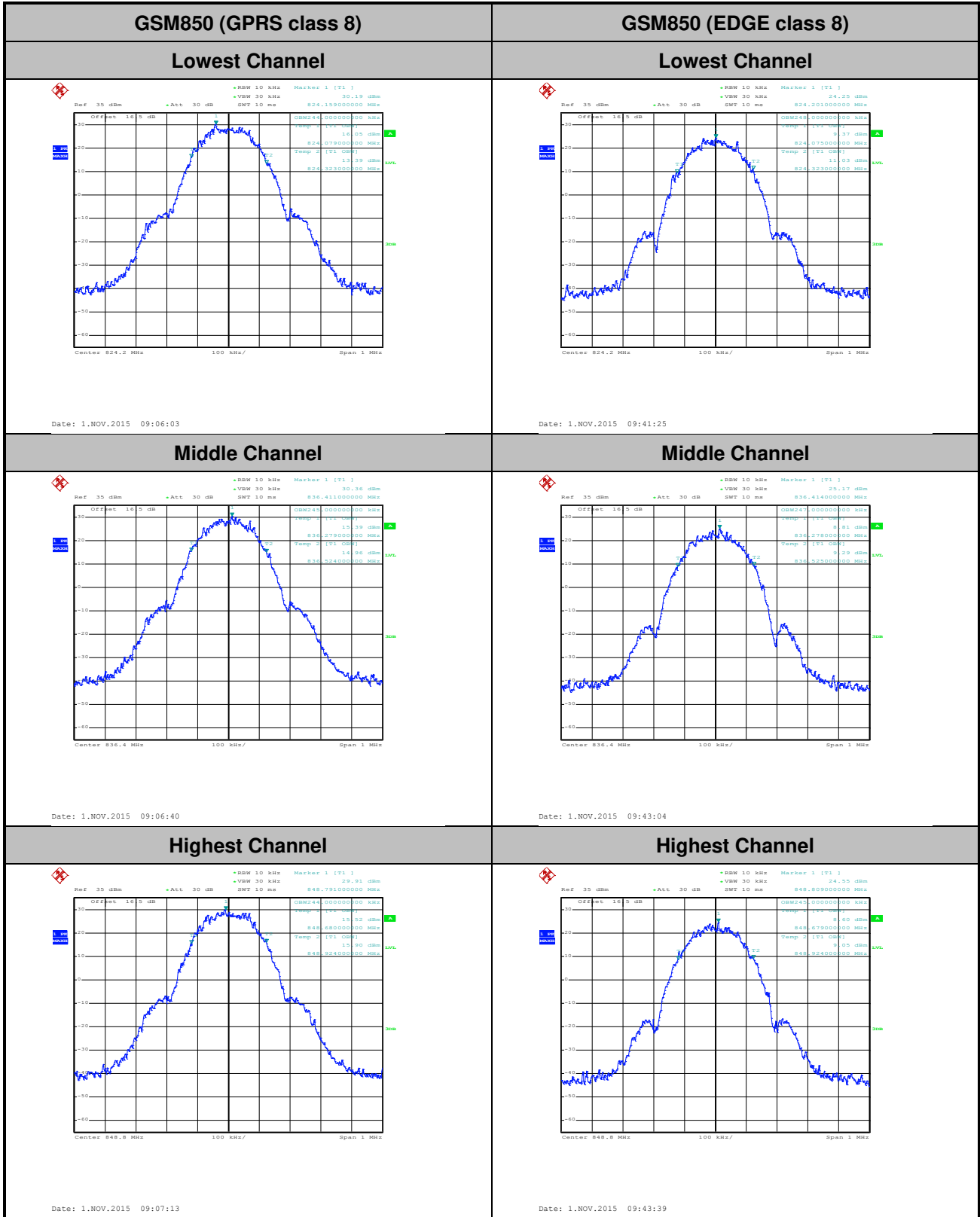

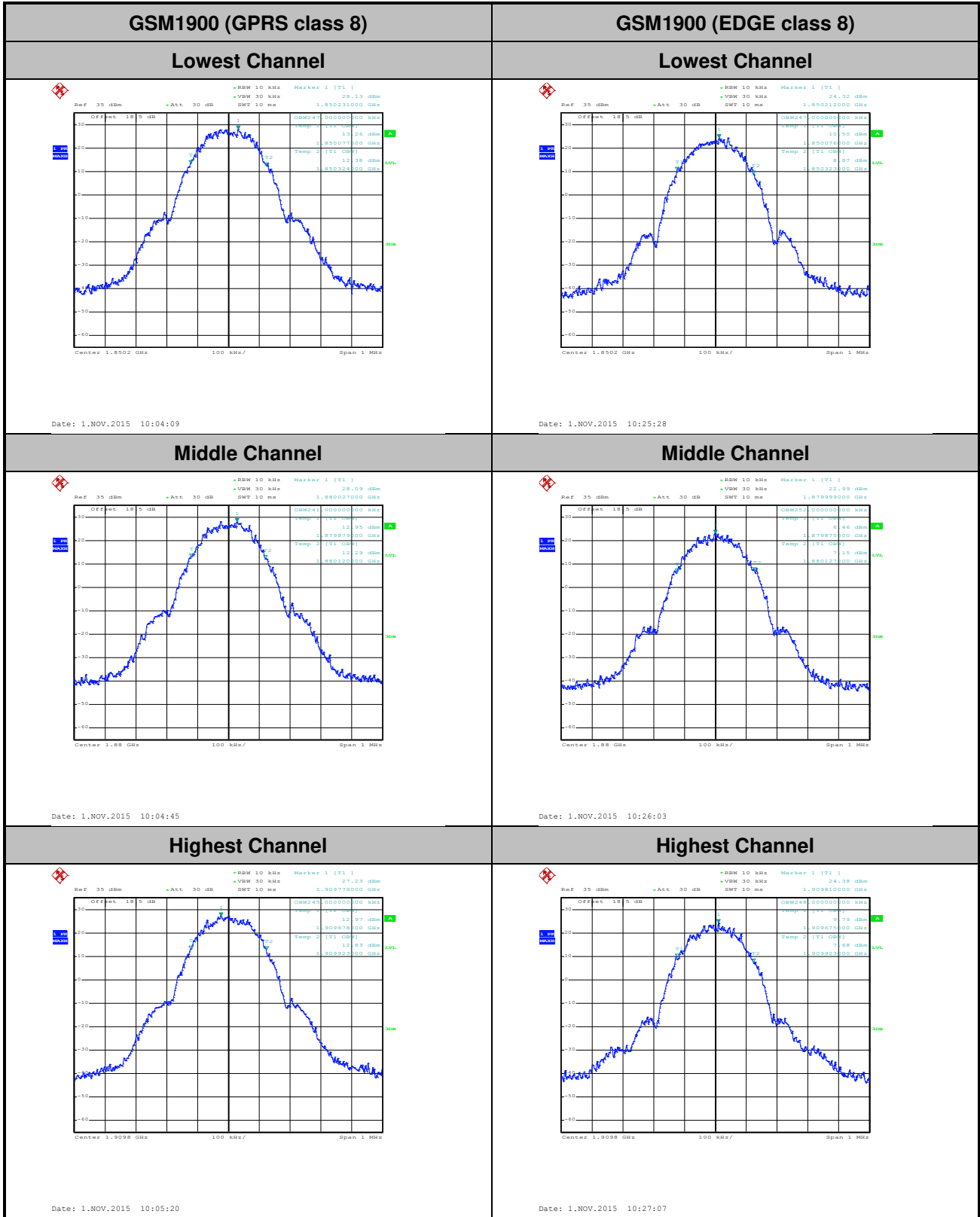



# Conducted Band Edge

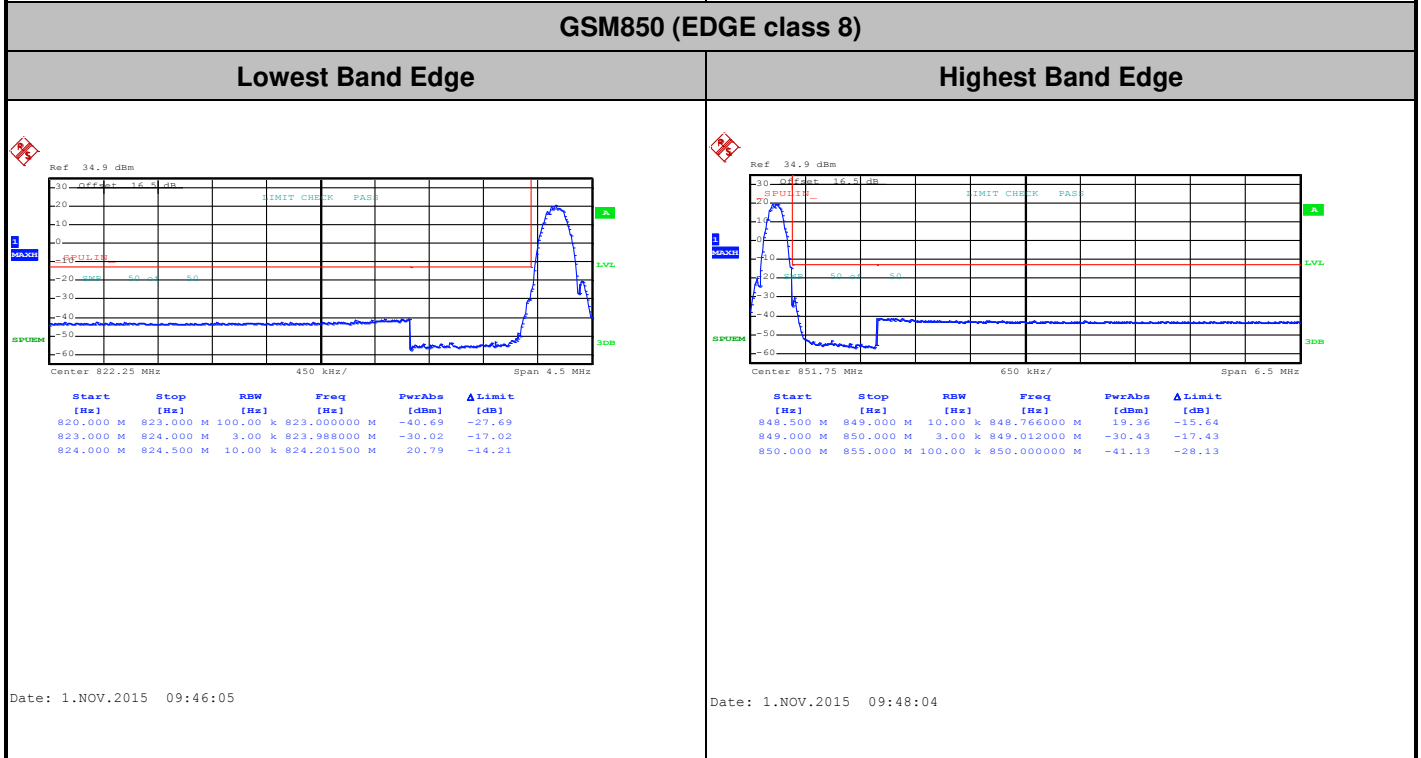
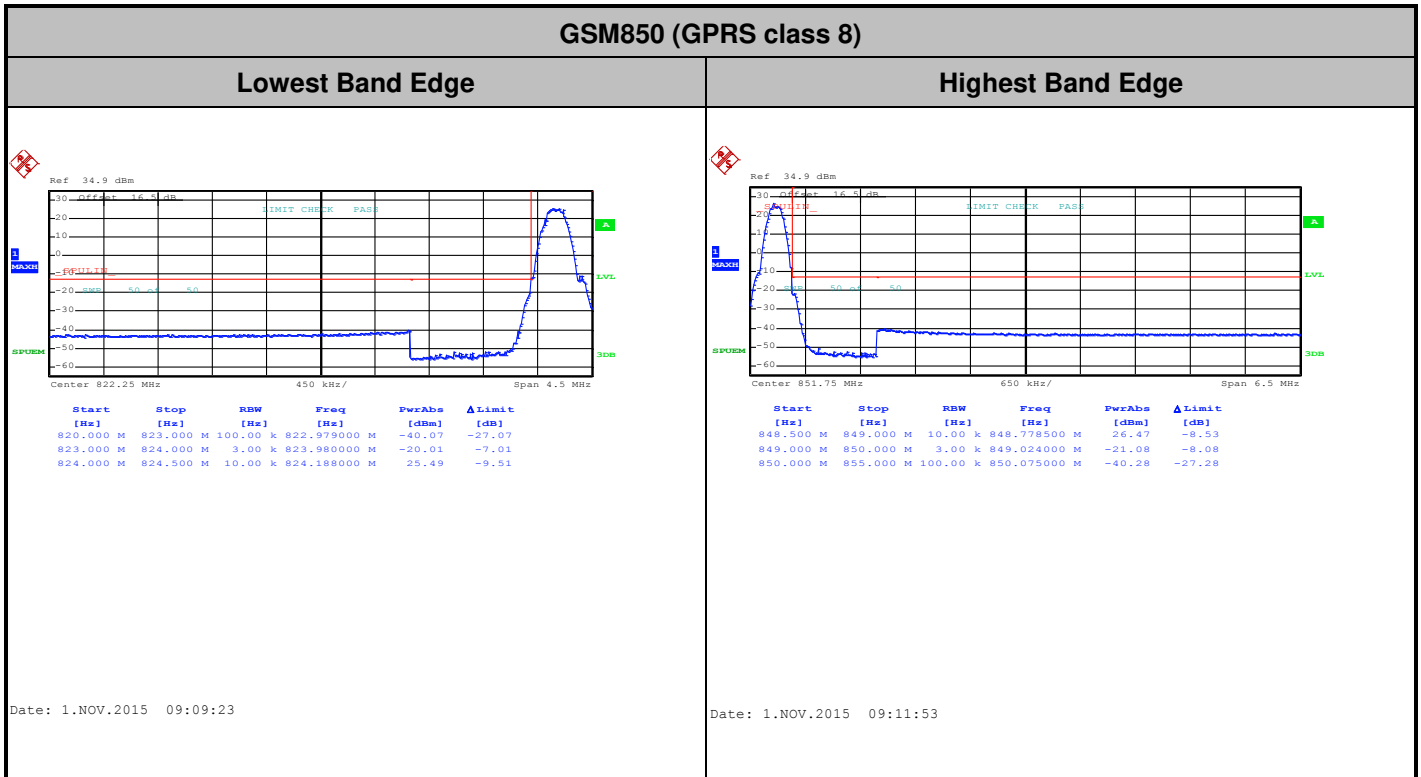



GSM1900 (GPRS class 8)

Lowest Band Edge

Highest Band Edge

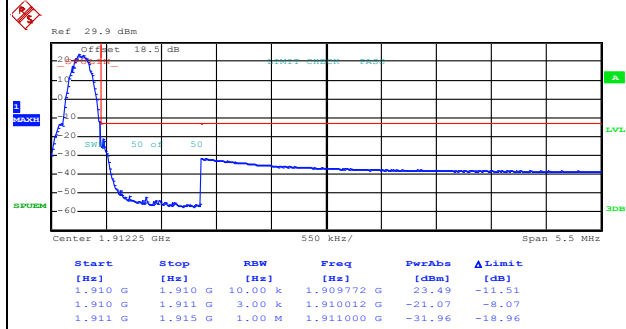
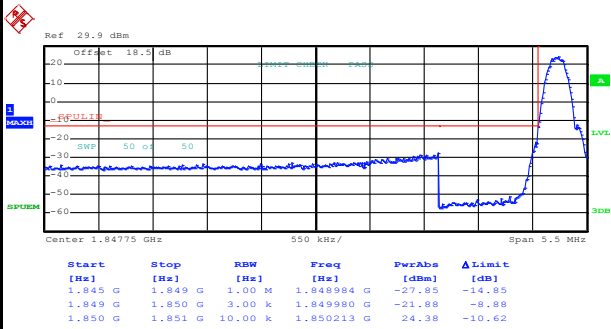

Date: 1.NOV.2015 10:07:38

Date: 1.NOV.2015 10:11:48

GSM1900 (EDGE class 8)

Lowest Band Edge

Highest Band Edge

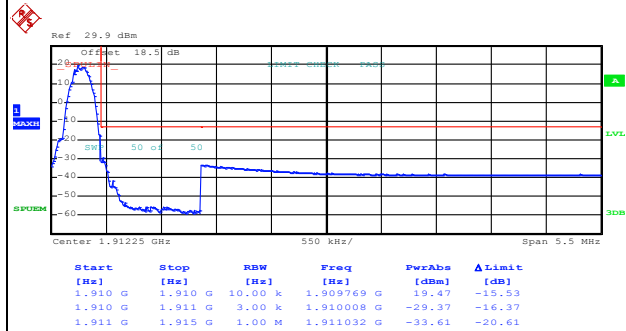
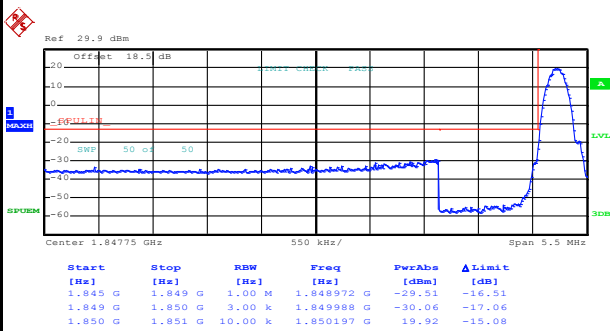

Date: 1.NOV.2015 10:29:30

Date: 1.NOV.2015 10:31:05

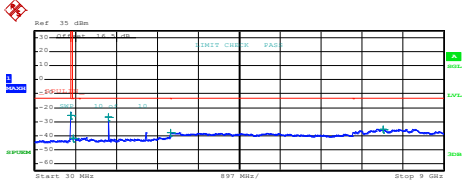
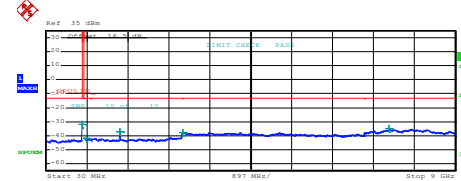
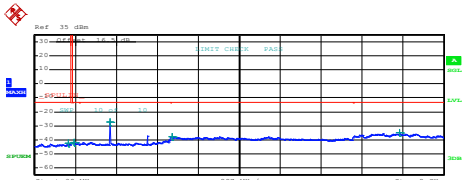
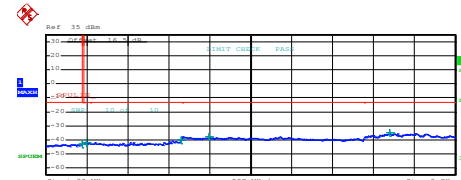
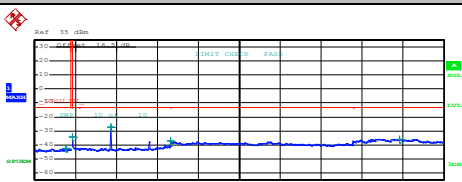
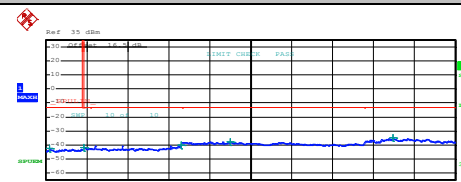

# Conducted Spurious Emission

GSM850 (GPRS class 8)	GSM850 (EDGE class 8)																																																																								
Lowest Channel	Lowest Channel																																																																								
 <table border="1" data-bbox="239 660 654 739"> <thead> <tr> <th>Start [Hz]</th> <th>Stop [Hz]</th> <th>RBW [Hz]</th> <th>Freq [Hz]</th> <th>Power [dBm]</th> <th>Limit [dB]</th> </tr> </thead> <tbody> <tr> <td>35,000 M</td> <td>820,000 M</td> <td>1,000 M</td> <td>816,802500 M</td> <td>-25.41</td> <td>-22.41</td> </tr> <tr> <td>855,000 M</td> <td>1,000 G</td> <td>1,000 M</td> <td>869,028751 M</td> <td>-41.67</td> <td>-28.67</td> </tr> <tr> <td>1,000 G</td> <td>3,000 G</td> <td>1,000 M</td> <td>1,648500 G</td> <td>-26.84</td> <td>-23.84</td> </tr> <tr> <td>3,000 G</td> <td>7,000 G</td> <td>1,000 M</td> <td>3,017000 G</td> <td>-37.95</td> <td>-24.95</td> </tr> <tr> <td>7,000 G</td> <td>9,000 G</td> <td>1,000 M</td> <td>7,679500 G</td> <td>-35.25</td> <td>-22.25</td> </tr> </tbody> </table> <p>Date: 1.NOV.2015 09:20:01</p>	Start [Hz]	Stop [Hz]	RBW [Hz]	Freq [Hz]	Power [dBm]	Limit [dB]	35,000 M	820,000 M	1,000 M	816,802500 M	-25.41	-22.41	855,000 M	1,000 G	1,000 M	869,028751 M	-41.67	-28.67	1,000 G	3,000 G	1,000 M	1,648500 G	-26.84	-23.84	3,000 G	7,000 G	1,000 M	3,017000 G	-37.95	-24.95	7,000 G	9,000 G	1,000 M	7,679500 G	-35.25	-22.25	 <table border="1" data-bbox="877 660 1292 739"> <thead> <tr> <th>Start [Hz]</th> <th>Stop [Hz]</th> <th>RBW [Hz]</th> <th>Freq [Hz]</th> <th>Power [dBm]</th> <th>Limit [dB]</th> </tr> </thead> <tbody> <tr> <td>35,000 M</td> <td>820,000 M</td> <td>1,000 M</td> <td>816,802500 M</td> <td>-25.41</td> <td>-22.41</td> </tr> <tr> <td>855,000 M</td> <td>1,000 G</td> <td>1,000 M</td> <td>811,042504 M</td> <td>-41.87</td> <td>-28.87</td> </tr> <tr> <td>1,000 G</td> <td>3,000 G</td> <td>1,000 M</td> <td>1,648500 G</td> <td>-27.21</td> <td>-24.21</td> </tr> <tr> <td>3,000 G</td> <td>7,000 G</td> <td>1,000 M</td> <td>3,027000 G</td> <td>-37.63</td> <td>-24.63</td> </tr> <tr> <td>7,000 G</td> <td>9,000 G</td> <td>1,000 M</td> <td>7,548000 G</td> <td>-34.97</td> <td>-21.97</td> </tr> </tbody> </table> <p>Date: 1.NOV.2015 09:49:44</p>	Start [Hz]	Stop [Hz]	RBW [Hz]	Freq [Hz]	Power [dBm]	Limit [dB]	35,000 M	820,000 M	1,000 M	816,802500 M	-25.41	-22.41	855,000 M	1,000 G	1,000 M	811,042504 M	-41.87	-28.87	1,000 G	3,000 G	1,000 M	1,648500 G	-27.21	-24.21	3,000 G	7,000 G	1,000 M	3,027000 G	-37.63	-24.63	7,000 G	9,000 G	1,000 M	7,548000 G	-34.97	-21.97
Start [Hz]	Stop [Hz]	RBW [Hz]	Freq [Hz]	Power [dBm]	Limit [dB]																																																																				
35,000 M	820,000 M	1,000 M	816,802500 M	-25.41	-22.41																																																																				
855,000 M	1,000 G	1,000 M	869,028751 M	-41.67	-28.67																																																																				
1,000 G	3,000 G	1,000 M	1,648500 G	-26.84	-23.84																																																																				
3,000 G	7,000 G	1,000 M	3,017000 G	-37.95	-24.95																																																																				
7,000 G	9,000 G	1,000 M	7,679500 G	-35.25	-22.25																																																																				
Start [Hz]	Stop [Hz]	RBW [Hz]	Freq [Hz]	Power [dBm]	Limit [dB]																																																																				
35,000 M	820,000 M	1,000 M	816,802500 M	-25.41	-22.41																																																																				
855,000 M	1,000 G	1,000 M	811,042504 M	-41.87	-28.87																																																																				
1,000 G	3,000 G	1,000 M	1,648500 G	-27.21	-24.21																																																																				
3,000 G	7,000 G	1,000 M	3,027000 G	-37.63	-24.63																																																																				
7,000 G	9,000 G	1,000 M	7,548000 G	-34.97	-21.97																																																																				
Middle Channel	Middle Channel																																																																								
 <table border="1" data-bbox="239 1176 654 1254"> <thead> <tr> <th>Start [Hz]</th> <th>Stop [Hz]</th> <th>RBW [Hz]</th> <th>Freq [Hz]</th> <th>Power [dBm]</th> <th>Limit [dB]</th> </tr> </thead> <tbody> <tr> <td>35,000 M</td> <td>820,000 M</td> <td>1,000 M</td> <td>759,762500 M</td> <td>-42.63</td> <td>-29.63</td> </tr> <tr> <td>855,000 M</td> <td>1,000 G</td> <td>1,000 M</td> <td>884,207502 M</td> <td>-43.94</td> <td>-30.94</td> </tr> <tr> <td>1,000 G</td> <td>3,000 G</td> <td>1,000 M</td> <td>1,673000 G</td> <td>-27.40</td> <td>-24.40</td> </tr> <tr> <td>3,000 G</td> <td>7,000 G</td> <td>1,000 M</td> <td>3,042000 G</td> <td>-37.57</td> <td>-24.57</td> </tr> <tr> <td>7,000 G</td> <td>9,000 G</td> <td>1,000 M</td> <td>8,039500 G</td> <td>-34.65</td> <td>-21.65</td> </tr> </tbody> </table> <p>Date: 1.NOV.2015 09:20:38</p>	Start [Hz]	Stop [Hz]	RBW [Hz]	Freq [Hz]	Power [dBm]	Limit [dB]	35,000 M	820,000 M	1,000 M	759,762500 M	-42.63	-29.63	855,000 M	1,000 G	1,000 M	884,207502 M	-43.94	-30.94	1,000 G	3,000 G	1,000 M	1,673000 G	-27.40	-24.40	3,000 G	7,000 G	1,000 M	3,042000 G	-37.57	-24.57	7,000 G	9,000 G	1,000 M	8,039500 G	-34.65	-21.65	 <table border="1" data-bbox="877 1176 1292 1254"> <thead> <tr> <th>Start [Hz]</th> <th>Stop [Hz]</th> <th>RBW [Hz]</th> <th>Freq [Hz]</th> <th>Power [dBm]</th> <th>Limit [dB]</th> </tr> </thead> <tbody> <tr> <td>35,000 M</td> <td>820,000 M</td> <td>1,000 M</td> <td>811,902500 M</td> <td>-42.92</td> <td>-29.92</td> </tr> <tr> <td>855,000 M</td> <td>1,000 G</td> <td>1,000 M</td> <td>802,737503 M</td> <td>-41.83</td> <td>-28.83</td> </tr> <tr> <td>1,000 G</td> <td>3,000 G</td> <td>1,000 M</td> <td>2,984500 G</td> <td>-40.27</td> <td>-27.27</td> </tr> <tr> <td>3,000 G</td> <td>7,000 G</td> <td>1,000 M</td> <td>3,600000 G</td> <td>-37.87</td> <td>-24.87</td> </tr> <tr> <td>7,000 G</td> <td>9,000 G</td> <td>1,000 M</td> <td>7,548500 G</td> <td>-34.79</td> <td>-21.79</td> </tr> </tbody> </table> <p>Date: 1.NOV.2015 09:50:28</p>	Start [Hz]	Stop [Hz]	RBW [Hz]	Freq [Hz]	Power [dBm]	Limit [dB]	35,000 M	820,000 M	1,000 M	811,902500 M	-42.92	-29.92	855,000 M	1,000 G	1,000 M	802,737503 M	-41.83	-28.83	1,000 G	3,000 G	1,000 M	2,984500 G	-40.27	-27.27	3,000 G	7,000 G	1,000 M	3,600000 G	-37.87	-24.87	7,000 G	9,000 G	1,000 M	7,548500 G	-34.79	-21.79
Start [Hz]	Stop [Hz]	RBW [Hz]	Freq [Hz]	Power [dBm]	Limit [dB]																																																																				
35,000 M	820,000 M	1,000 M	759,762500 M	-42.63	-29.63																																																																				
855,000 M	1,000 G	1,000 M	884,207502 M	-43.94	-30.94																																																																				
1,000 G	3,000 G	1,000 M	1,673000 G	-27.40	-24.40																																																																				
3,000 G	7,000 G	1,000 M	3,042000 G	-37.57	-24.57																																																																				
7,000 G	9,000 G	1,000 M	8,039500 G	-34.65	-21.65																																																																				
Start [Hz]	Stop [Hz]	RBW [Hz]	Freq [Hz]	Power [dBm]	Limit [dB]																																																																				
35,000 M	820,000 M	1,000 M	811,902500 M	-42.92	-29.92																																																																				
855,000 M	1,000 G	1,000 M	802,737503 M	-41.83	-28.83																																																																				
1,000 G	3,000 G	1,000 M	2,984500 G	-40.27	-27.27																																																																				
3,000 G	7,000 G	1,000 M	3,600000 G	-37.87	-24.87																																																																				
7,000 G	9,000 G	1,000 M	7,548500 G	-34.79	-21.79																																																																				
Highest Channel	Highest Channel																																																																								
 <table border="1" data-bbox="239 1691 654 1769"> <thead> <tr> <th>Start [Hz]</th> <th>Stop [Hz]</th> <th>RBW [Hz]</th> <th>Freq [Hz]</th> <th>Power [dBm]</th> <th>Limit [dB]</th> </tr> </thead> <tbody> <tr> <td>35,000 M</td> <td>820,000 M</td> <td>1,000 M</td> <td>718,403500 M</td> <td>-40.77</td> <td>-27.77</td> </tr> <tr> <td>855,000 M</td> <td>1,000 G</td> <td>1,000 M</td> <td>850,036250 M</td> <td>-34.06</td> <td>-21.06</td> </tr> <tr> <td>1,000 G</td> <td>3,000 G</td> <td>1,000 M</td> <td>1,697500 G</td> <td>-27.20</td> <td>-24.20</td> </tr> <tr> <td>3,000 G</td> <td>7,000 G</td> <td>1,000 M</td> <td>3,011000 G</td> <td>-37.33</td> <td>-24.33</td> </tr> <tr> <td>7,000 G</td> <td>9,000 G</td> <td>1,000 M</td> <td>8,029000 G</td> <td>-35.81</td> <td>-22.81</td> </tr> </tbody> </table> <p>Date: 1.NOV.2015 09:21:14</p>	Start [Hz]	Stop [Hz]	RBW [Hz]	Freq [Hz]	Power [dBm]	Limit [dB]	35,000 M	820,000 M	1,000 M	718,403500 M	-40.77	-27.77	855,000 M	1,000 G	1,000 M	850,036250 M	-34.06	-21.06	1,000 G	3,000 G	1,000 M	1,697500 G	-27.20	-24.20	3,000 G	7,000 G	1,000 M	3,011000 G	-37.33	-24.33	7,000 G	9,000 G	1,000 M	8,029000 G	-35.81	-22.81	 <table border="1" data-bbox="877 1691 1292 1769"> <thead> <tr> <th>Start [Hz]</th> <th>Stop [Hz]</th> <th>RBW [Hz]</th> <th>Freq [Hz]</th> <th>Power [dBm]</th> <th>Limit [dB]</th> </tr> </thead> <tbody> <tr> <td>35,000 M</td> <td>820,000 M</td> <td>1,000 M</td> <td>977,742500 M</td> <td>-40.34</td> <td>-27.34</td> </tr> <tr> <td>855,000 M</td> <td>1,000 G</td> <td>1,000 M</td> <td>861,198750 M</td> <td>-41.92</td> <td>-28.92</td> </tr> <tr> <td>1,000 G</td> <td>3,000 G</td> <td>1,000 M</td> <td>2,993500 G</td> <td>-40.30</td> <td>-27.30</td> </tr> <tr> <td>3,000 G</td> <td>7,000 G</td> <td>1,000 M</td> <td>4,072000 G</td> <td>-38.01</td> <td>-25.01</td> </tr> <tr> <td>7,000 G</td> <td>9,000 G</td> <td>1,000 M</td> <td>7,633000 G</td> <td>-34.72</td> <td>-21.72</td> </tr> </tbody> </table> <p>Date: 1.NOV.2015 09:51:06</p>	Start [Hz]	Stop [Hz]	RBW [Hz]	Freq [Hz]	Power [dBm]	Limit [dB]	35,000 M	820,000 M	1,000 M	977,742500 M	-40.34	-27.34	855,000 M	1,000 G	1,000 M	861,198750 M	-41.92	-28.92	1,000 G	3,000 G	1,000 M	2,993500 G	-40.30	-27.30	3,000 G	7,000 G	1,000 M	4,072000 G	-38.01	-25.01	7,000 G	9,000 G	1,000 M	7,633000 G	-34.72	-21.72
Start [Hz]	Stop [Hz]	RBW [Hz]	Freq [Hz]	Power [dBm]	Limit [dB]																																																																				
35,000 M	820,000 M	1,000 M	718,403500 M	-40.77	-27.77																																																																				
855,000 M	1,000 G	1,000 M	850,036250 M	-34.06	-21.06																																																																				
1,000 G	3,000 G	1,000 M	1,697500 G	-27.20	-24.20																																																																				
3,000 G	7,000 G	1,000 M	3,011000 G	-37.33	-24.33																																																																				
7,000 G	9,000 G	1,000 M	8,029000 G	-35.81	-22.81																																																																				
Start [Hz]	Stop [Hz]	RBW [Hz]	Freq [Hz]	Power [dBm]	Limit [dB]																																																																				
35,000 M	820,000 M	1,000 M	977,742500 M	-40.34	-27.34																																																																				
855,000 M	1,000 G	1,000 M	861,198750 M	-41.92	-28.92																																																																				
1,000 G	3,000 G	1,000 M	2,993500 G	-40.30	-27.30																																																																				
3,000 G	7,000 G	1,000 M	4,072000 G	-38.01	-25.01																																																																				
7,000 G	9,000 G	1,000 M	7,633000 G	-34.72	-21.72																																																																				

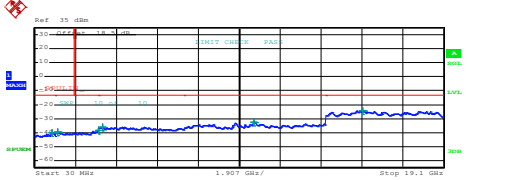
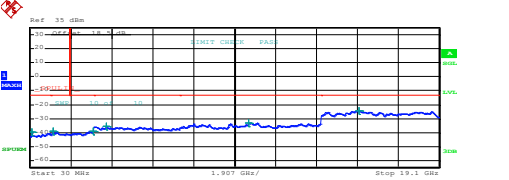
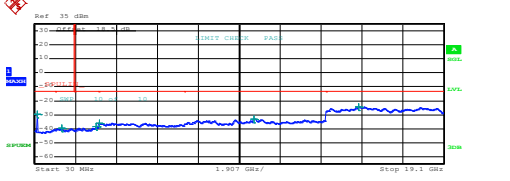
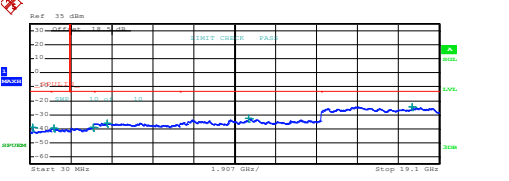
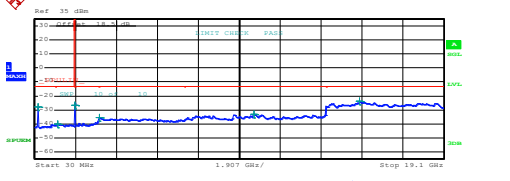
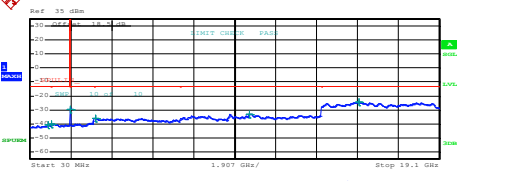

GSM1900 (GPRS class 8)	GSM1900 (EDGE class 8)																																																																																				
Lowest Channel	Lowest Channel																																																																																				
 <table border="1" data-bbox="239 571 686 672"> <thead> <tr> <th>Start [MHz]</th> <th>Stop [MHz]</th> <th>RBW [Hz]</th> <th>Freq [MHz]</th> <th>PwrAve [dBm]</th> <th>ΔLimit [dB]</th> </tr> </thead> <tbody> <tr><td>30.0000</td><td>1.0000</td><td>1.00</td><td>1.020310000</td><td>-40.41</td><td>-27.43</td></tr> <tr><td>1.0000</td><td>1.8450</td><td>1.00</td><td>1.1009770</td><td>-39.47</td><td>-26.47</td></tr> <tr><td>1.8450</td><td>3.0000</td><td>1.00</td><td>2.1928602</td><td>-38.39</td><td>-25.39</td></tr> <tr><td>3.0000</td><td>7.0000</td><td>1.00</td><td>3.1899000</td><td>-36.12</td><td>-23.12</td></tr> <tr><td>7.0000</td><td>13.6000</td><td>1.00</td><td>10.244725</td><td>-32.72</td><td>-19.72</td></tr> <tr><td>13.6000</td><td>19.1000</td><td>1.00</td><td>15.218750</td><td>-24.59</td><td>-11.59</td></tr> </tbody> </table> <p>Date: 1.NOV.2015 10:16:31</p>	Start [MHz]	Stop [MHz]	RBW [Hz]	Freq [MHz]	PwrAve [dBm]	ΔLimit [dB]	30.0000	1.0000	1.00	1.020310000	-40.41	-27.43	1.0000	1.8450	1.00	1.1009770	-39.47	-26.47	1.8450	3.0000	1.00	2.1928602	-38.39	-25.39	3.0000	7.0000	1.00	3.1899000	-36.12	-23.12	7.0000	13.6000	1.00	10.244725	-32.72	-19.72	13.6000	19.1000	1.00	15.218750	-24.59	-11.59	 <table border="1" data-bbox="893 571 1340 672"> <thead> <tr> <th>Start [MHz]</th> <th>Stop [MHz]</th> <th>RBW [Hz]</th> <th>Freq [MHz]</th> <th>PwrAve [dBm]</th> <th>ΔLimit [dB]</th> </tr> </thead> <tbody> <tr><td>30.0000</td><td>1.0000</td><td>1.00</td><td>1.11721500</td><td>-39.53</td><td>-26.53</td></tr> <tr><td>1.0000</td><td>1.8450</td><td>1.00</td><td>1.095696</td><td>-39.27</td><td>-26.27</td></tr> <tr><td>1.8450</td><td>3.0000</td><td>1.00</td><td>2.974974</td><td>-39.78</td><td>-25.78</td></tr> <tr><td>3.0000</td><td>7.0000</td><td>1.00</td><td>3.956000</td><td>-35.74</td><td>-22.74</td></tr> <tr><td>7.0000</td><td>13.6000</td><td>1.00</td><td>10.224925</td><td>-33.12</td><td>-20.12</td></tr> <tr><td>13.6000</td><td>19.1000</td><td>1.00</td><td>15.346250</td><td>-24.09</td><td>-11.09</td></tr> </tbody> </table> <p>Date: 1.NOV.2015 10:32:26</p>	Start [MHz]	Stop [MHz]	RBW [Hz]	Freq [MHz]	PwrAve [dBm]	ΔLimit [dB]	30.0000	1.0000	1.00	1.11721500	-39.53	-26.53	1.0000	1.8450	1.00	1.095696	-39.27	-26.27	1.8450	3.0000	1.00	2.974974	-39.78	-25.78	3.0000	7.0000	1.00	3.956000	-35.74	-22.74	7.0000	13.6000	1.00	10.224925	-33.12	-20.12	13.6000	19.1000	1.00	15.346250	-24.09	-11.09
Start [MHz]	Stop [MHz]	RBW [Hz]	Freq [MHz]	PwrAve [dBm]	ΔLimit [dB]																																																																																
30.0000	1.0000	1.00	1.020310000	-40.41	-27.43																																																																																
1.0000	1.8450	1.00	1.1009770	-39.47	-26.47																																																																																
1.8450	3.0000	1.00	2.1928602	-38.39	-25.39																																																																																
3.0000	7.0000	1.00	3.1899000	-36.12	-23.12																																																																																
7.0000	13.6000	1.00	10.244725	-32.72	-19.72																																																																																
13.6000	19.1000	1.00	15.218750	-24.59	-11.59																																																																																
Start [MHz]	Stop [MHz]	RBW [Hz]	Freq [MHz]	PwrAve [dBm]	ΔLimit [dB]																																																																																
30.0000	1.0000	1.00	1.11721500	-39.53	-26.53																																																																																
1.0000	1.8450	1.00	1.095696	-39.27	-26.27																																																																																
1.8450	3.0000	1.00	2.974974	-39.78	-25.78																																																																																
3.0000	7.0000	1.00	3.956000	-35.74	-22.74																																																																																
7.0000	13.6000	1.00	10.224925	-33.12	-20.12																																																																																
13.6000	19.1000	1.00	15.346250	-24.09	-11.09																																																																																
Middle Channel	Middle Channel																																																																																				
 <table border="1" data-bbox="239 1095 686 1196"> <thead> <tr> <th>Start [MHz]</th> <th>Stop [MHz]</th> <th>RBW [Hz]</th> <th>Freq [MHz]</th> <th>PwrAve [dBm]</th> <th>ΔLimit [dB]</th> </tr> </thead> <tbody> <tr><td>30.0000</td><td>1.0000</td><td>1.00</td><td>141.792500</td><td>-29.68</td><td>-16.68</td></tr> <tr><td>1.0000</td><td>1.8450</td><td>1.00</td><td>1.288032</td><td>-39.77</td><td>-26.77</td></tr> <tr><td>1.8450</td><td>3.0000</td><td>1.00</td><td>2.897467</td><td>-38.36</td><td>-25.36</td></tr> <tr><td>3.0000</td><td>7.0000</td><td>1.00</td><td>3.049000</td><td>-36.19</td><td>-23.19</td></tr> <tr><td>7.0000</td><td>13.6000</td><td>1.00</td><td>10.236975</td><td>-32.87</td><td>-19.87</td></tr> <tr><td>13.6000</td><td>19.1000</td><td>1.00</td><td>15.138625</td><td>-24.46</td><td>-11.46</td></tr> </tbody> </table> <p>Date: 1.NOV.2015 10:17:13</p>	Start [MHz]	Stop [MHz]	RBW [Hz]	Freq [MHz]	PwrAve [dBm]	ΔLimit [dB]	30.0000	1.0000	1.00	141.792500	-29.68	-16.68	1.0000	1.8450	1.00	1.288032	-39.77	-26.77	1.8450	3.0000	1.00	2.897467	-38.36	-25.36	3.0000	7.0000	1.00	3.049000	-36.19	-23.19	7.0000	13.6000	1.00	10.236975	-32.87	-19.87	13.6000	19.1000	1.00	15.138625	-24.46	-11.46	 <table border="1" data-bbox="893 1095 1340 1196"> <thead> <tr> <th>Start [MHz]</th> <th>Stop [MHz]</th> <th>RBW [Hz]</th> <th>Freq [MHz]</th> <th>PwrAve [dBm]</th> <th>ΔLimit [dB]</th> </tr> </thead> <tbody> <tr><td>30.0000</td><td>1.0000</td><td>1.00</td><td>142.035000</td><td>-38.95</td><td>-25.95</td></tr> <tr><td>1.0000</td><td>1.8450</td><td>1.00</td><td>1.218788</td><td>-39.43</td><td>-26.43</td></tr> <tr><td>1.8450</td><td>3.0000</td><td>1.00</td><td>2.983434</td><td>-38.76</td><td>-25.76</td></tr> <tr><td>3.0000</td><td>7.0000</td><td>1.00</td><td>3.597000</td><td>-35.99</td><td>-22.99</td></tr> <tr><td>7.0000</td><td>13.6000</td><td>1.00</td><td>10.233900</td><td>-32.81</td><td>-19.81</td></tr> <tr><td>13.6000</td><td>19.1000</td><td>1.00</td><td>17.836375</td><td>-24.47</td><td>-11.47</td></tr> </tbody> </table> <p>Date: 1.NOV.2015 10:33:03</p>	Start [MHz]	Stop [MHz]	RBW [Hz]	Freq [MHz]	PwrAve [dBm]	ΔLimit [dB]	30.0000	1.0000	1.00	142.035000	-38.95	-25.95	1.0000	1.8450	1.00	1.218788	-39.43	-26.43	1.8450	3.0000	1.00	2.983434	-38.76	-25.76	3.0000	7.0000	1.00	3.597000	-35.99	-22.99	7.0000	13.6000	1.00	10.233900	-32.81	-19.81	13.6000	19.1000	1.00	17.836375	-24.47	-11.47
Start [MHz]	Stop [MHz]	RBW [Hz]	Freq [MHz]	PwrAve [dBm]	ΔLimit [dB]																																																																																
30.0000	1.0000	1.00	141.792500	-29.68	-16.68																																																																																
1.0000	1.8450	1.00	1.288032	-39.77	-26.77																																																																																
1.8450	3.0000	1.00	2.897467	-38.36	-25.36																																																																																
3.0000	7.0000	1.00	3.049000	-36.19	-23.19																																																																																
7.0000	13.6000	1.00	10.236975	-32.87	-19.87																																																																																
13.6000	19.1000	1.00	15.138625	-24.46	-11.46																																																																																
Start [MHz]	Stop [MHz]	RBW [Hz]	Freq [MHz]	PwrAve [dBm]	ΔLimit [dB]																																																																																
30.0000	1.0000	1.00	142.035000	-38.95	-25.95																																																																																
1.0000	1.8450	1.00	1.218788	-39.43	-26.43																																																																																
1.8450	3.0000	1.00	2.983434	-38.76	-25.76																																																																																
3.0000	7.0000	1.00	3.597000	-35.99	-22.99																																																																																
7.0000	13.6000	1.00	10.233900	-32.81	-19.81																																																																																
13.6000	19.1000	1.00	17.836375	-24.47	-11.47																																																																																
Highest Channel	Highest Channel																																																																																				
 <table border="1" data-bbox="239 1619 686 1720"> <thead> <tr> <th>Start [MHz]</th> <th>Stop [MHz]</th> <th>RBW [Hz]</th> <th>Freq [MHz]</th> <th>PwrAve [dBm]</th> <th>ΔLimit [dB]</th> </tr> </thead> <tbody> <tr><td>30.0000</td><td>1.0000</td><td>1.00</td><td>171.600000</td><td>-27.95</td><td>-14.95</td></tr> <tr><td>1.0000</td><td>1.8450</td><td>1.00</td><td>1.103512</td><td>-40.10</td><td>-27.10</td></tr> <tr><td>1.8450</td><td>3.0000</td><td>1.00</td><td>1.932071</td><td>-30.84</td><td>-17.84</td></tr> <tr><td>3.0000</td><td>7.0000</td><td>1.00</td><td>3.032000</td><td>-35.72</td><td>-22.72</td></tr> <tr><td>7.0000</td><td>13.6000</td><td>1.00</td><td>10.242250</td><td>-33.10</td><td>-20.10</td></tr> <tr><td>13.6000</td><td>19.1000</td><td>1.00</td><td>15.170938</td><td>-23.76</td><td>-10.76</td></tr> </tbody> </table> <p>Date: 1.NOV.2015 10:17:50</p>	Start [MHz]	Stop [MHz]	RBW [Hz]	Freq [MHz]	PwrAve [dBm]	ΔLimit [dB]	30.0000	1.0000	1.00	171.600000	-27.95	-14.95	1.0000	1.8450	1.00	1.103512	-40.10	-27.10	1.8450	3.0000	1.00	1.932071	-30.84	-17.84	3.0000	7.0000	1.00	3.032000	-35.72	-22.72	7.0000	13.6000	1.00	10.242250	-33.10	-20.10	13.6000	19.1000	1.00	15.170938	-23.76	-10.76	 <table border="1" data-bbox="893 1619 1340 1720"> <thead> <tr> <th>Start [MHz]</th> <th>Stop [MHz]</th> <th>RBW [Hz]</th> <th>Freq [MHz]</th> <th>PwrAve [dBm]</th> <th>ΔLimit [dB]</th> </tr> </thead> <tbody> <tr><td>30.0000</td><td>1.0000</td><td>1.00</td><td>862.087500</td><td>-40.51</td><td>-27.51</td></tr> <tr><td>1.0000</td><td>1.8450</td><td>1.00</td><td>1.021970</td><td>-40.13</td><td>-27.13</td></tr> <tr><td>1.8450</td><td>3.0000</td><td>1.00</td><td>1.932071</td><td>-29.68</td><td>-16.68</td></tr> <tr><td>3.0000</td><td>7.0000</td><td>1.00</td><td>3.086000</td><td>-36.29</td><td>-23.29</td></tr> <tr><td>7.0000</td><td>13.6000</td><td>1.00</td><td>10.233175</td><td>-33.00</td><td>-20.00</td></tr> <tr><td>13.6000</td><td>19.1000</td><td>1.00</td><td>15.348313</td><td>-24.32</td><td>-11.32</td></tr> </tbody> </table> <p>Date: 1.NOV.2015 10:33:39</p>	Start [MHz]	Stop [MHz]	RBW [Hz]	Freq [MHz]	PwrAve [dBm]	ΔLimit [dB]	30.0000	1.0000	1.00	862.087500	-40.51	-27.51	1.0000	1.8450	1.00	1.021970	-40.13	-27.13	1.8450	3.0000	1.00	1.932071	-29.68	-16.68	3.0000	7.0000	1.00	3.086000	-36.29	-23.29	7.0000	13.6000	1.00	10.233175	-33.00	-20.00	13.6000	19.1000	1.00	15.348313	-24.32	-11.32
Start [MHz]	Stop [MHz]	RBW [Hz]	Freq [MHz]	PwrAve [dBm]	ΔLimit [dB]																																																																																
30.0000	1.0000	1.00	171.600000	-27.95	-14.95																																																																																
1.0000	1.8450	1.00	1.103512	-40.10	-27.10																																																																																
1.8450	3.0000	1.00	1.932071	-30.84	-17.84																																																																																
3.0000	7.0000	1.00	3.032000	-35.72	-22.72																																																																																
7.0000	13.6000	1.00	10.242250	-33.10	-20.10																																																																																
13.6000	19.1000	1.00	15.170938	-23.76	-10.76																																																																																
Start [MHz]	Stop [MHz]	RBW [Hz]	Freq [MHz]	PwrAve [dBm]	ΔLimit [dB]																																																																																
30.0000	1.0000	1.00	862.087500	-40.51	-27.51																																																																																
1.0000	1.8450	1.00	1.021970	-40.13	-27.13																																																																																
1.8450	3.0000	1.00	1.932071	-29.68	-16.68																																																																																
3.0000	7.0000	1.00	3.086000	-36.29	-23.29																																																																																
7.0000	13.6000	1.00	10.233175	-33.00	-20.00																																																																																
13.6000	19.1000	1.00	15.348313	-24.32	-11.32																																																																																



**Frequency Stability**

Test Conditions Temperature (°C)	Middle Channel Voltage (Volt)	GSM850 (GPRS class 8)	GSM850 (EDGE class 8)	Limit 2.5ppm
		Deviation (ppm)		Result
50	Normal Voltage	0.0060	0.0072	PASS
40	Normal Voltage	0.0024	0.0036	
30	Normal Voltage	0.0012	0.0012	
20(Ref.)	Normal Voltage	0.0000	0.0000	
10	Normal Voltage	0.0024	0.0036	
0	Normal Voltage	0.0012	0.0012	
-10	Normal Voltage	0.0012	0.0024	
-20	Normal Voltage	0.0000	0.0012	
-30	Normal Voltage	0.0036	0.0036	
20	Maximum Voltage	0.0012	0.0024	
20	Normal Voltage	0.0024	0.0012	
20	Battery End Point	0.0000	0.0012	

**Note:**

1. Normal Voltage = 3.8V. ; Battery End Point (BEP) = 3.4 V. ; Maximum Voltage =4.35V
2. The frequency fundamental emissions stay within the authorized frequency block.



Test Conditions Temperature (°C)	Middle Channel Voltage (Volt)	GSM1900 (GPRS class 8)	GSM1900 (EDGE class 8)	Limit Note 2.
		Deviation (ppm)		Result
50	Normal Voltage	0.0064	0.0043	PASS
40	Normal Voltage	0.0048	0.0037	
30	Normal Voltage	0.0011	0.0027	
20(Ref.)	Normal Voltage	0.0000	0.0000	
10	Normal Voltage	0.0021	0.0011	
0	Normal Voltage	0.0016	0.0011	
-10	Normal Voltage	0.0027	0.0005	
-20	Normal Voltage	0.0011	0.0016	
-30	Normal Voltage	0.0032	0.0027	
20	Maximum Voltage	0.0021	0.0021	
20	Normal Voltage	0.0016	0.0016	
20	Battery End Point	0.0027	0.0021	

**Note:**

1. Normal Voltage = 3.8V. ; Battery End Point (BEP) = 3.4 V. ; Maximum Voltage =4.35V
2. The frequency fundamental emissions stay within the authorized frequency block.





## A2. WCDMA

### Peak-to-Average Ratio

Mode	WCDMA Band V	WCDMA Band II	Limit: 13dB
Mod.	RMC 12.2Kbps	RMC 12.2Kbps	Result
Lowest CH	2.32	3.08	PASS
Middle CH	2.72	2.56	
Highest CH	2.72	2.68	

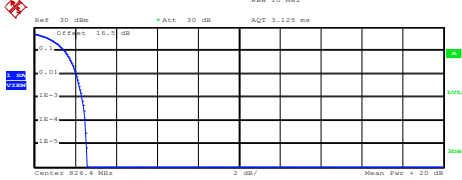
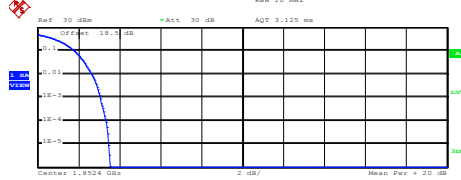
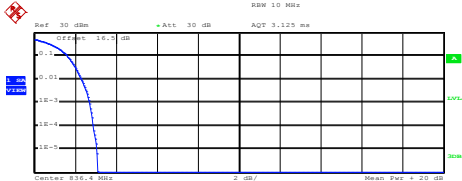
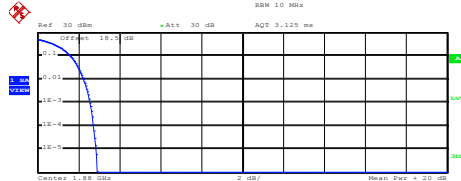
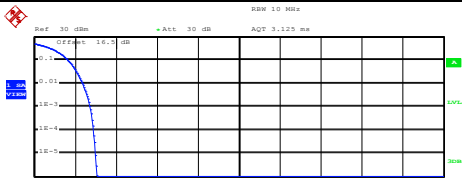
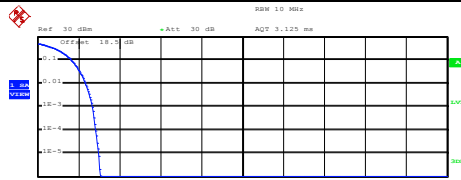

WCDMA Band V (RMC 12.2Kbps)	WCDMA Band II (RMC 12.2Kbps)																
<p style="text-align: center;"><b>Lowest Channel</b></p>  <p>Center 826.4 MHz</p> <p>Complementary Cumulative Distribution Function (100000 samples) Trace 1 Mean 23.73 dBm Peak 26.30 dBm Crest 2.57 dB</p> <table border="1"> <tr><td>10 %</td><td>1.48 dB</td></tr> <tr><td>1 %</td><td>2.04 dB</td></tr> <tr><td>.1 %</td><td>2.32 dB</td></tr> <tr><td>.01 %</td><td>2.48 dB</td></tr> </table> <p>Date: 1.NOV.2015 11:07:46</p>	10 %	1.48 dB	1 %	2.04 dB	.1 %	2.32 dB	.01 %	2.48 dB	<p style="text-align: center;"><b>Lowest Channel</b></p>  <p>Center 1.8524 GHz</p> <p>Complementary Cumulative Distribution Function (100000 samples) Trace 1 Mean 24.46 dBm Peak 27.99 dBm Crest 3.54 dB</p> <table border="1"> <tr><td>10 %</td><td>1.80 dB</td></tr> <tr><td>1 %</td><td>2.64 dB</td></tr> <tr><td>.1 %</td><td>3.08 dB</td></tr> <tr><td>.01 %</td><td>3.36 dB</td></tr> </table> <p>Date: 1.NOV.2015 10:58:09</p>	10 %	1.80 dB	1 %	2.64 dB	.1 %	3.08 dB	.01 %	3.36 dB
10 %	1.48 dB																
1 %	2.04 dB																
.1 %	2.32 dB																
.01 %	2.48 dB																
10 %	1.80 dB																
1 %	2.64 dB																
.1 %	3.08 dB																
.01 %	3.36 dB																
<p style="text-align: center;"><b>Middle Channel</b></p>  <p>Center 830.4 MHz</p> <p>Complementary Cumulative Distribution Function (100000 samples) Trace 1 Mean 23.84 dBm Peak 26.94 dBm Crest 3.10 dB</p> <table border="1"> <tr><td>10 %</td><td>1.60 dB</td></tr> <tr><td>1 %</td><td>2.32 dB</td></tr> <tr><td>.1 %</td><td>2.72 dB</td></tr> <tr><td>.01 %</td><td>2.88 dB</td></tr> </table> <p>Date: 1.NOV.2015 11:08:08</p>	10 %	1.60 dB	1 %	2.32 dB	.1 %	2.72 dB	.01 %	2.88 dB	<p style="text-align: center;"><b>Middle Channel</b></p>  <p>Center 1.88 GHz</p> <p>Complementary Cumulative Distribution Function (100000 samples) Trace 1 Mean 24.51 dBm Peak 27.43 dBm Crest 2.92 dB</p> <table border="1"> <tr><td>10 %</td><td>1.60 dB</td></tr> <tr><td>1 %</td><td>2.24 dB</td></tr> <tr><td>.1 %</td><td>2.56 dB</td></tr> <tr><td>.01 %</td><td>2.72 dB</td></tr> </table> <p>Date: 1.NOV.2015 10:58:23</p>	10 %	1.60 dB	1 %	2.24 dB	.1 %	2.56 dB	.01 %	2.72 dB
10 %	1.60 dB																
1 %	2.32 dB																
.1 %	2.72 dB																
.01 %	2.88 dB																
10 %	1.60 dB																
1 %	2.24 dB																
.1 %	2.56 dB																
.01 %	2.72 dB																
<p style="text-align: center;"><b>Highest Channel</b></p>  <p>Center 846.6 MHz</p> <p>Complementary Cumulative Distribution Function (100000 samples) Trace 1 Mean 24.16 dBm Peak 27.22 dBm Crest 3.05 dB</p> <table border="1"> <tr><td>10 %</td><td>1.64 dB</td></tr> <tr><td>1 %</td><td>2.36 dB</td></tr> <tr><td>.1 %</td><td>2.72 dB</td></tr> <tr><td>.01 %</td><td>2.92 dB</td></tr> </table> <p>Date: 1.NOV.2015 11:08:23</p>	10 %	1.64 dB	1 %	2.36 dB	.1 %	2.72 dB	.01 %	2.92 dB	<p style="text-align: center;"><b>Highest Channel</b></p>  <p>Center 1.9076 GHz</p> <p>Complementary Cumulative Distribution Function (100000 samples) Trace 1 Mean 24.17 dBm Peak 27.22 dBm Crest 3.05 dB</p> <table border="1"> <tr><td>10 %</td><td>1.64 dB</td></tr> <tr><td>1 %</td><td>2.36 dB</td></tr> <tr><td>.1 %</td><td>2.68 dB</td></tr> <tr><td>.01 %</td><td>2.84 dB</td></tr> </table> <p>Date: 1.NOV.2015 10:58:41</p>	10 %	1.64 dB	1 %	2.36 dB	.1 %	2.68 dB	.01 %	2.84 dB
10 %	1.64 dB																
1 %	2.36 dB																
.1 %	2.72 dB																
.01 %	2.92 dB																
10 %	1.64 dB																
1 %	2.36 dB																
.1 %	2.68 dB																
.01 %	2.84 dB																



**26dB Bandwidth**

Mode	WCDMA Band V	WCDMA Band II
Mod.	RMC 12.2Kbps	RMC 12.2Kbps
Lowest CH	4.74	4.68
Middle CH	4.70	4.71
Highest CH	4.69	4.70



WCDMA Band V (RMC 12.2Kbps)	WCDMA Band II (RMC 12.2Kbps)
<p style="text-align: center;"><b>Lowest Channel</b></p> <p>Date: 1.NOV.2015 11:00:51</p>	<p style="text-align: center;"><b>Lowest Channel</b></p> <p>Date: 1.NOV.2015 10:44:53</p>
<p style="text-align: center;"><b>Middle Channel</b></p> <p>Date: 1.NOV.2015 11:01:31</p>	<p style="text-align: center;"><b>Middle Channel</b></p> <p>Date: 1.NOV.2015 10:45:28</p>
<p style="text-align: center;"><b>Highest Channel</b></p> <p>Date: 1.NOV.2015 11:02:11</p>	<p style="text-align: center;"><b>Highest Channel</b></p> <p>Date: 1.NOV.2015 10:46:03</p>



### Occupied Bandwidth

Mode	WCDMA Band V	WCDMA Band II
Mod.	RMC 12.2Kbps	RMC 12.2Kbps
Lowest CH	4.20	4.17
Middle CH	4.18	4.18
Highest CH	4.16	4.17

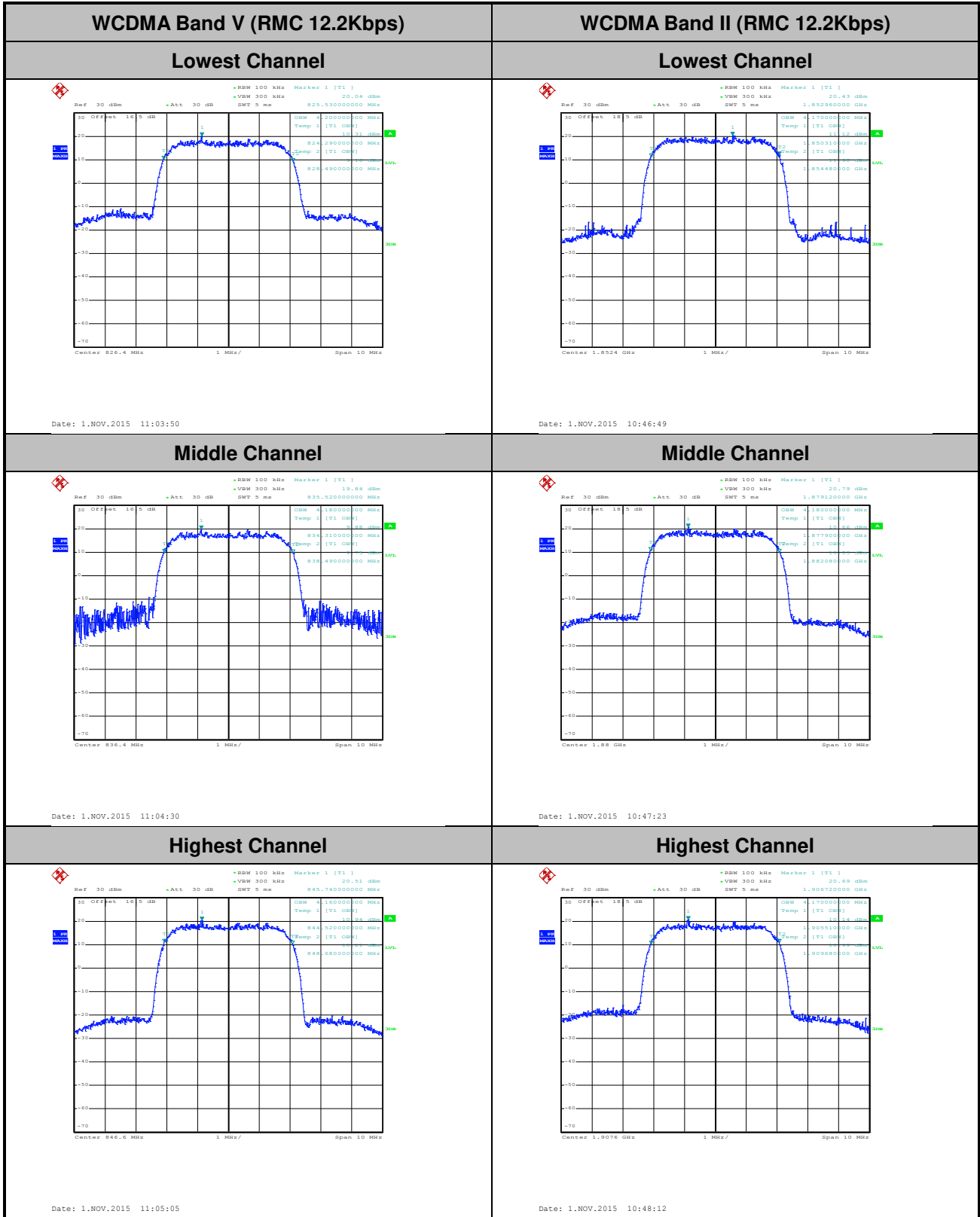



## Conducted Band Edge

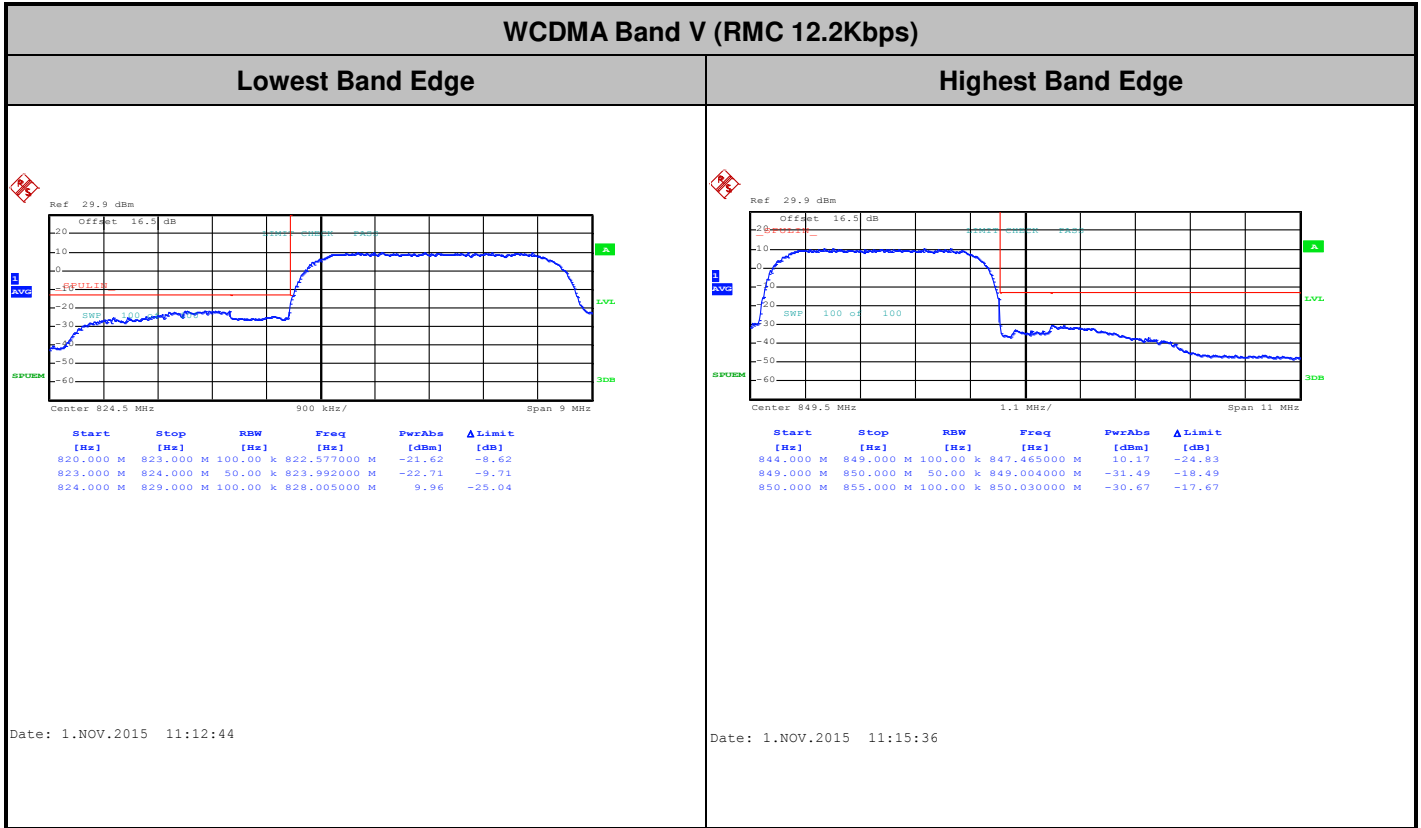



WCDMA Band II (RMC 12.2Kbps)

Lowest Band Edge

Highest Band Edge

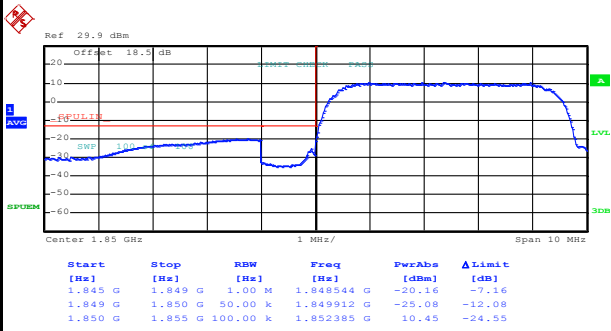

Date: 1.NOV.2015 10:51:38

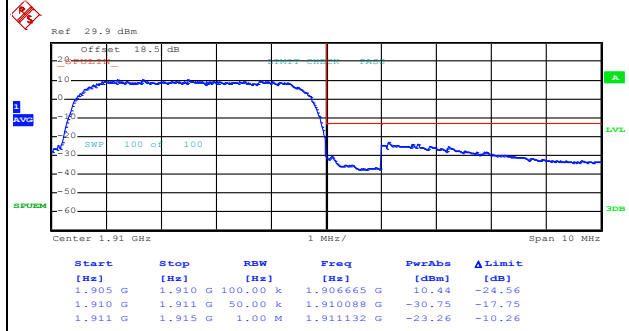

Date: 1.NOV.2015 10:54:28



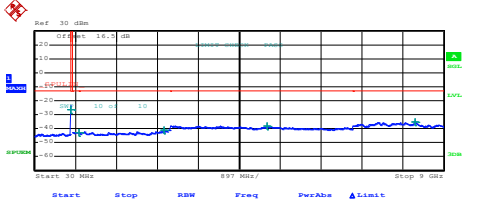
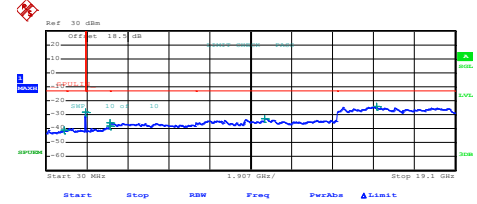
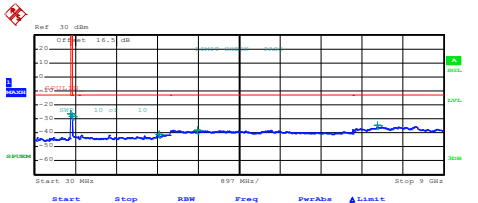
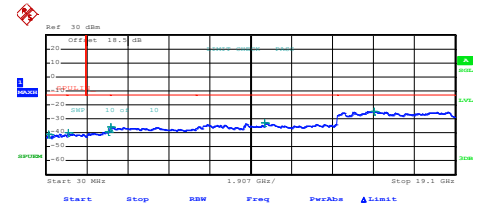
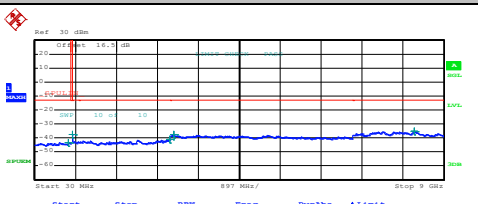
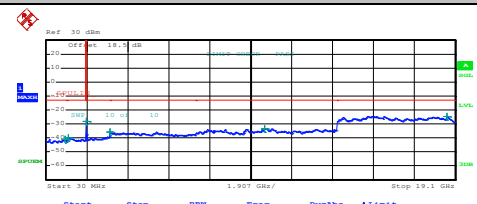

# Conducted Spurious Emission

WCDMA Band V (RMC 12.2Kbps)	WCDMA Band II (RMC 12.2Kbps)																																																																																										
Lowest Channel	Lowest Channel																																																																																										
 <table border="1"> <thead> <tr> <th>Start</th> <th>Stop</th> <th>RBW</th> <th>Freq</th> <th>PwrAbs</th> <th>ΔLimit</th> </tr> <tr> <th>[Hz]</th> <th>[Hz]</th> <th>[Hz]</th> <th>[Hz]</th> <th>[dBm]</th> <th>[dB]</th> </tr> </thead> <tbody> <tr> <td>35,000 M</td> <td>820,000 M</td> <td>1,000 M</td> <td>815,802500 M</td> <td>-26.72</td> <td>-13.72</td> </tr> <tr> <td>855,000 M</td> <td>1,000 G</td> <td>1,000 G</td> <td>991,046250 M</td> <td>-42.53</td> <td>-29.53</td> </tr> <tr> <td>1,000 G</td> <td>3,000 G</td> <td>1,000 M</td> <td>2,168500 G</td> <td>-40.84</td> <td>-27.84</td> </tr> <tr> <td>3,000 G</td> <td>7,000 G</td> <td>1,000 M</td> <td>5,120000 G</td> <td>-37.88</td> <td>-24.88</td> </tr> <tr> <td>7,000 G</td> <td>9,000 G</td> <td>1,000 M</td> <td>8,367000 G</td> <td>-35.39</td> <td>-22.39</td> </tr> </tbody> </table> <p>Date: 1.NOV.2015 11:06:10</p>	Start	Stop	RBW	Freq	PwrAbs	ΔLimit	[Hz]	[Hz]	[Hz]	[Hz]	[dBm]	[dB]	35,000 M	820,000 M	1,000 M	815,802500 M	-26.72	-13.72	855,000 M	1,000 G	1,000 G	991,046250 M	-42.53	-29.53	1,000 G	3,000 G	1,000 M	2,168500 G	-40.84	-27.84	3,000 G	7,000 G	1,000 M	5,120000 G	-37.88	-24.88	7,000 G	9,000 G	1,000 M	8,367000 G	-35.39	-22.39	 <table border="1"> <thead> <tr> <th>Start</th> <th>Stop</th> <th>RBW</th> <th>Freq</th> <th>PwrAbs</th> <th>ΔLimit</th> </tr> <tr> <th>[Hz]</th> <th>[Hz]</th> <th>[Hz]</th> <th>[Hz]</th> <th>[dBm]</th> <th>[dB]</th> </tr> </thead> <tbody> <tr> <td>35,000 M</td> <td>1,000 G</td> <td>1,000 M</td> <td>876,307500 M</td> <td>-41.30</td> <td>-28.30</td> </tr> <tr> <td>1,000 G</td> <td>3,000 G</td> <td>1,000 M</td> <td>1,844780 G</td> <td>-28.14</td> <td>-15.14</td> </tr> <tr> <td>3,000 G</td> <td>3,000 G</td> <td>1,000 M</td> <td>2,997850 G</td> <td>-38.23</td> <td>-25.23</td> </tr> <tr> <td>3,000 G</td> <td>7,000 G</td> <td>1,000 M</td> <td>3,037000 G</td> <td>-35.87</td> <td>-22.87</td> </tr> <tr> <td>7,000 G</td> <td>13,600 G</td> <td>1,000 M</td> <td>10,208425 G</td> <td>-32.78</td> <td>-19.78</td> </tr> <tr> <td>13,600 G</td> <td>19,100 G</td> <td>1,000 M</td> <td>15,450050 G</td> <td>-24.31</td> <td>-11.31</td> </tr> </tbody> </table> <p>Date: 1.NOV.2015 10:55:40</p>	Start	Stop	RBW	Freq	PwrAbs	ΔLimit	[Hz]	[Hz]	[Hz]	[Hz]	[dBm]	[dB]	35,000 M	1,000 G	1,000 M	876,307500 M	-41.30	-28.30	1,000 G	3,000 G	1,000 M	1,844780 G	-28.14	-15.14	3,000 G	3,000 G	1,000 M	2,997850 G	-38.23	-25.23	3,000 G	7,000 G	1,000 M	3,037000 G	-35.87	-22.87	7,000 G	13,600 G	1,000 M	10,208425 G	-32.78	-19.78	13,600 G	19,100 G	1,000 M	15,450050 G	-24.31	-11.31
Start	Stop	RBW	Freq	PwrAbs	ΔLimit																																																																																						
[Hz]	[Hz]	[Hz]	[Hz]	[dBm]	[dB]																																																																																						
35,000 M	820,000 M	1,000 M	815,802500 M	-26.72	-13.72																																																																																						
855,000 M	1,000 G	1,000 G	991,046250 M	-42.53	-29.53																																																																																						
1,000 G	3,000 G	1,000 M	2,168500 G	-40.84	-27.84																																																																																						
3,000 G	7,000 G	1,000 M	5,120000 G	-37.88	-24.88																																																																																						
7,000 G	9,000 G	1,000 M	8,367000 G	-35.39	-22.39																																																																																						
Start	Stop	RBW	Freq	PwrAbs	ΔLimit																																																																																						
[Hz]	[Hz]	[Hz]	[Hz]	[dBm]	[dB]																																																																																						
35,000 M	1,000 G	1,000 M	876,307500 M	-41.30	-28.30																																																																																						
1,000 G	3,000 G	1,000 M	1,844780 G	-28.14	-15.14																																																																																						
3,000 G	3,000 G	1,000 M	2,997850 G	-38.23	-25.23																																																																																						
3,000 G	7,000 G	1,000 M	3,037000 G	-35.87	-22.87																																																																																						
7,000 G	13,600 G	1,000 M	10,208425 G	-32.78	-19.78																																																																																						
13,600 G	19,100 G	1,000 M	15,450050 G	-24.31	-11.31																																																																																						
Middle Channel	Middle Channel																																																																																										
 <table border="1"> <thead> <tr> <th>Start</th> <th>Stop</th> <th>RBW</th> <th>Freq</th> <th>PwrAbs</th> <th>ΔLimit</th> </tr> <tr> <th>[Hz]</th> <th>[Hz]</th> <th>[Hz]</th> <th>[Hz]</th> <th>[dBm]</th> <th>[dB]</th> </tr> </thead> <tbody> <tr> <td>35,000 M</td> <td>820,000 M</td> <td>1,000 M</td> <td>815,852500 M</td> <td>-26.57</td> <td>-13.57</td> </tr> <tr> <td>855,000 M</td> <td>1,000 G</td> <td>1,000 M</td> <td>855,862500 M</td> <td>-28.09</td> <td>-15.09</td> </tr> <tr> <td>1,000 G</td> <td>3,000 G</td> <td>1,000 M</td> <td>2,748500 G</td> <td>-41.06</td> <td>-28.06</td> </tr> <tr> <td>3,000 G</td> <td>7,000 G</td> <td>1,000 M</td> <td>3,668000 G</td> <td>-37.97</td> <td>-24.97</td> </tr> <tr> <td>7,000 G</td> <td>9,000 G</td> <td>1,000 M</td> <td>7,344000 G</td> <td>-34.83</td> <td>-21.83</td> </tr> </tbody> </table> <p>Date: 1.NOV.2015 11:06:46</p>	Start	Stop	RBW	Freq	PwrAbs	ΔLimit	[Hz]	[Hz]	[Hz]	[Hz]	[dBm]	[dB]	35,000 M	820,000 M	1,000 M	815,852500 M	-26.57	-13.57	855,000 M	1,000 G	1,000 M	855,862500 M	-28.09	-15.09	1,000 G	3,000 G	1,000 M	2,748500 G	-41.06	-28.06	3,000 G	7,000 G	1,000 M	3,668000 G	-37.97	-24.97	7,000 G	9,000 G	1,000 M	7,344000 G	-34.83	-21.83	 <table border="1"> <thead> <tr> <th>Start</th> <th>Stop</th> <th>RBW</th> <th>Freq</th> <th>PwrAbs</th> <th>ΔLimit</th> </tr> <tr> <th>[Hz]</th> <th>[Hz]</th> <th>[Hz]</th> <th>[Hz]</th> <th>[dBm]</th> <th>[dB]</th> </tr> </thead> <tbody> <tr> <td>35,000 M</td> <td>1,000 G</td> <td>1,000 M</td> <td>142,762500 M</td> <td>-40.93</td> <td>-27.93</td> </tr> <tr> <td>1,000 G</td> <td>3,000 G</td> <td>1,000 M</td> <td>1,008200 G</td> <td>-40.48</td> <td>-27.48</td> </tr> <tr> <td>1,915 G</td> <td>3,000 G</td> <td>1,000 M</td> <td>2,930500 G</td> <td>-39.09</td> <td>-26.09</td> </tr> <tr> <td>3,000 G</td> <td>7,000 G</td> <td>1,000 M</td> <td>3,037000 G</td> <td>-35.85</td> <td>-22.85</td> </tr> <tr> <td>7,000 G</td> <td>13,600 G</td> <td>1,000 M</td> <td>10,216575 G</td> <td>-32.79</td> <td>-19.79</td> </tr> <tr> <td>13,600 G</td> <td>19,100 G</td> <td>1,000 M</td> <td>15,320813 G</td> <td>-24.40</td> <td>-11.40</td> </tr> </tbody> </table> <p>Date: 1.NOV.2015 10:56:16</p>	Start	Stop	RBW	Freq	PwrAbs	ΔLimit	[Hz]	[Hz]	[Hz]	[Hz]	[dBm]	[dB]	35,000 M	1,000 G	1,000 M	142,762500 M	-40.93	-27.93	1,000 G	3,000 G	1,000 M	1,008200 G	-40.48	-27.48	1,915 G	3,000 G	1,000 M	2,930500 G	-39.09	-26.09	3,000 G	7,000 G	1,000 M	3,037000 G	-35.85	-22.85	7,000 G	13,600 G	1,000 M	10,216575 G	-32.79	-19.79	13,600 G	19,100 G	1,000 M	15,320813 G	-24.40	-11.40
Start	Stop	RBW	Freq	PwrAbs	ΔLimit																																																																																						
[Hz]	[Hz]	[Hz]	[Hz]	[dBm]	[dB]																																																																																						
35,000 M	820,000 M	1,000 M	815,852500 M	-26.57	-13.57																																																																																						
855,000 M	1,000 G	1,000 M	855,862500 M	-28.09	-15.09																																																																																						
1,000 G	3,000 G	1,000 M	2,748500 G	-41.06	-28.06																																																																																						
3,000 G	7,000 G	1,000 M	3,668000 G	-37.97	-24.97																																																																																						
7,000 G	9,000 G	1,000 M	7,344000 G	-34.83	-21.83																																																																																						
Start	Stop	RBW	Freq	PwrAbs	ΔLimit																																																																																						
[Hz]	[Hz]	[Hz]	[Hz]	[dBm]	[dB]																																																																																						
35,000 M	1,000 G	1,000 M	142,762500 M	-40.93	-27.93																																																																																						
1,000 G	3,000 G	1,000 M	1,008200 G	-40.48	-27.48																																																																																						
1,915 G	3,000 G	1,000 M	2,930500 G	-39.09	-26.09																																																																																						
3,000 G	7,000 G	1,000 M	3,037000 G	-35.85	-22.85																																																																																						
7,000 G	13,600 G	1,000 M	10,216575 G	-32.79	-19.79																																																																																						
13,600 G	19,100 G	1,000 M	15,320813 G	-24.40	-11.40																																																																																						
Highest Channel	Highest Channel																																																																																										
 <table border="1"> <thead> <tr> <th>Start</th> <th>Stop</th> <th>RBW</th> <th>Freq</th> <th>PwrAbs</th> <th>ΔLimit</th> </tr> <tr> <th>[Hz]</th> <th>[Hz]</th> <th>[Hz]</th> <th>[Hz]</th> <th>[dBm]</th> <th>[dB]</th> </tr> </thead> <tbody> <tr> <td>35,000 M</td> <td>820,000 M</td> <td>1,000 M</td> <td>765,487500 M</td> <td>-33.32</td> <td>-20.32</td> </tr> <tr> <td>855,000 M</td> <td>1,000 G</td> <td>1,000 M</td> <td>855,108750 M</td> <td>-37.34</td> <td>-24.34</td> </tr> <tr> <td>1,000 G</td> <td>3,000 G</td> <td>1,000 M</td> <td>2,997500 G</td> <td>-42.14</td> <td>-28.14</td> </tr> <tr> <td>3,000 G</td> <td>7,000 G</td> <td>1,000 M</td> <td>3,087000 G</td> <td>-37.78</td> <td>-24.78</td> </tr> <tr> <td>7,000 G</td> <td>9,000 G</td> <td>1,000 M</td> <td>8,355000 G</td> <td>-35.28</td> <td>-22.28</td> </tr> </tbody> </table> <p>Date: 1.NOV.2015 11:07:22</p>	Start	Stop	RBW	Freq	PwrAbs	ΔLimit	[Hz]	[Hz]	[Hz]	[Hz]	[dBm]	[dB]	35,000 M	820,000 M	1,000 M	765,487500 M	-33.32	-20.32	855,000 M	1,000 G	1,000 M	855,108750 M	-37.34	-24.34	1,000 G	3,000 G	1,000 M	2,997500 G	-42.14	-28.14	3,000 G	7,000 G	1,000 M	3,087000 G	-37.78	-24.78	7,000 G	9,000 G	1,000 M	8,355000 G	-35.28	-22.28	 <table border="1"> <thead> <tr> <th>Start</th> <th>Stop</th> <th>RBW</th> <th>Freq</th> <th>PwrAbs</th> <th>ΔLimit</th> </tr> <tr> <th>[Hz]</th> <th>[Hz]</th> <th>[Hz]</th> <th>[Hz]</th> <th>[dBm]</th> <th>[dB]</th> </tr> </thead> <tbody> <tr> <td>35,000 M</td> <td>1,000 G</td> <td>1,000 M</td> <td>901,787500 M</td> <td>-40.87</td> <td>-27.87</td> </tr> <tr> <td>1,000 G</td> <td>3,000 G</td> <td>1,000 M</td> <td>1,071925 G</td> <td>-40.16</td> <td>-27.16</td> </tr> <tr> <td>3,000 G</td> <td>3,000 G</td> <td>1,000 M</td> <td>1,933500 G</td> <td>-28.31</td> <td>-15.31</td> </tr> <tr> <td>3,000 G</td> <td>7,000 G</td> <td>1,000 M</td> <td>3,032000 G</td> <td>-35.77</td> <td>-22.77</td> </tr> <tr> <td>7,000 G</td> <td>13,600 G</td> <td>1,000 M</td> <td>10,209250 G</td> <td>-33.23</td> <td>-20.23</td> </tr> <tr> <td>13,600 G</td> <td>19,100 G</td> <td>1,000 M</td> <td>16,723375 G</td> <td>-24.82</td> <td>-11.82</td> </tr> </tbody> </table> <p>Date: 1.NOV.2015 10:56:56</p>	Start	Stop	RBW	Freq	PwrAbs	ΔLimit	[Hz]	[Hz]	[Hz]	[Hz]	[dBm]	[dB]	35,000 M	1,000 G	1,000 M	901,787500 M	-40.87	-27.87	1,000 G	3,000 G	1,000 M	1,071925 G	-40.16	-27.16	3,000 G	3,000 G	1,000 M	1,933500 G	-28.31	-15.31	3,000 G	7,000 G	1,000 M	3,032000 G	-35.77	-22.77	7,000 G	13,600 G	1,000 M	10,209250 G	-33.23	-20.23	13,600 G	19,100 G	1,000 M	16,723375 G	-24.82	-11.82
Start	Stop	RBW	Freq	PwrAbs	ΔLimit																																																																																						
[Hz]	[Hz]	[Hz]	[Hz]	[dBm]	[dB]																																																																																						
35,000 M	820,000 M	1,000 M	765,487500 M	-33.32	-20.32																																																																																						
855,000 M	1,000 G	1,000 M	855,108750 M	-37.34	-24.34																																																																																						
1,000 G	3,000 G	1,000 M	2,997500 G	-42.14	-28.14																																																																																						
3,000 G	7,000 G	1,000 M	3,087000 G	-37.78	-24.78																																																																																						
7,000 G	9,000 G	1,000 M	8,355000 G	-35.28	-22.28																																																																																						
Start	Stop	RBW	Freq	PwrAbs	ΔLimit																																																																																						
[Hz]	[Hz]	[Hz]	[Hz]	[dBm]	[dB]																																																																																						
35,000 M	1,000 G	1,000 M	901,787500 M	-40.87	-27.87																																																																																						
1,000 G	3,000 G	1,000 M	1,071925 G	-40.16	-27.16																																																																																						
3,000 G	3,000 G	1,000 M	1,933500 G	-28.31	-15.31																																																																																						
3,000 G	7,000 G	1,000 M	3,032000 G	-35.77	-22.77																																																																																						
7,000 G	13,600 G	1,000 M	10,209250 G	-33.23	-20.23																																																																																						
13,600 G	19,100 G	1,000 M	16,723375 G	-24.82	-11.82																																																																																						



### Frequency Stability

Test Conditions	Middle Channel	WCDMA Band V (RMC 12.2Kbps)	Limit
Temperature (°C)	Voltage (Volt)	Deviation (ppm)	2.5ppm Result
50	Normal Voltage	0.0203	PASS
40	Normal Voltage	0.0155	
30	Normal Voltage	0.0012	
20(Ref.)	Normal Voltage	0.0000	
10	Normal Voltage	0.0143	
0	Normal Voltage	0.0132	
-10	Normal Voltage	0.0155	
-20	Normal Voltage	0.0179	
-30	Normal Voltage	0.0167	
20	Maximum Voltage	0.0143	
20	Normal Voltage	0.0120	
20	Battery End Point	0.0012	

**Note:**

- 1. Normal Voltage = 3.8V. ; Battery End Point (BEP) = 3.4 V. ; Maximum Voltage =4.35 V
- 2. The frequency fundamental emissions stay within the authorized frequency block .



Test Conditions	Middle Channel	WCDMA Band II (RMC 12.2Kbps)	Limit Note 2.
Temperature (°C)	Voltage (Volt)	Deviation (ppm)	Result
50	Normal Voltage	0.0016	PASS
40	Normal Voltage	0.0005	
30	Normal Voltage	0.0011	
20(Ref.)	Normal Voltage	0.0000	
10	Normal Voltage	0.0000	
0	Normal Voltage	0.0016	
-10	Normal Voltage	0.0005	
-20	Normal Voltage	0.0011	
-30	Normal Voltage	0.0000	
20	Maximum Voltage	0.0011	
20	Normal Voltage	0.0000	
20	Battery End Point	0.0005	

**Note:**

1. Normal Voltage = 3.8V. ; Battery End Point (BEP) = 3.4 V. ; Maximum Voltage =4.35 V
2. The frequency fundamental emissions stay within the authorized frequency block.



## Appendix B. Test Results of Radiated Test

### ERP/EIRP

Channel	Mode	Horizontal		Vertical	
		ERP(dBm)	ERP(W)	ERP(dBm)	ERP(W)
Lowest	GSM850 GPRS class 8	12.78	0.0189	25.10	0.3236
Middle		14.32	0.0270	26.58	0.4555
Highest		15.20	0.0331	27.57	0.5718
Lowest	GSM850 EDGE class 8	7.65	0.0058	19.89	0.0976
Middle		8.28	0.0067	20.93	0.1240
Highest		9.04	0.0080	21.50	0.1411
Lowest	WCDMA Band V RMC 12.2Kbps	4.19	0.0026	16.27	0.0424
Middle		6.15	0.0041	17.70	0.0589
Highest		7.54	0.0057	19.47	0.0885
Limit	ERP < 7W	Result		PASS	



Channel	Mode	Horizontal		Vertical	
		EIRP(dBm)	EIRP(W)	EIRP(dBm)	EIRP(W)
Lowest	GSM1900 GPRS class 8	24.92	0.3102	29.12	0.8168
Middle		25.54	0.3581	29.17	0.8255
Highest		26.06	0.4039	29.79	0.9538
Lowest	GSM1900 EDGE class 8	20.96	0.1247	25.17	0.3286
Middle		20.91	0.1234	24.62	0.2900
Highest		21.26	0.1336	24.78	0.3007
Lowest	WCDMA Band II RMC 12.2Kbps	19.78	0.0952	23.57	0.2277
Middle		20.28	0.1065	23.88	0.2446
Highest		19.85	0.0966	23.73	0.2361
Limit	EIRP < 2W	Result		PASS	



### Radiated Spurious Emission

GSM850 (GPRS class 8)									
Channel	Frequency ( MHz )	ERP ( dBm )	Limit ( dBm )	Over Limit ( dB )	SPA Reading (dBm)	S.G. Power ( dBm )	TX Cable loss ( dB )	TX Antenna Gain (dBi)	Polarization (H/V)
Lowest	1648	-45.26	-13	-32.26	-54.88	-47.02	0.98	4.89	H
	2472	-47.75	-13	-34.75	-61.03	-49.63	1.28	5.32	H
	3296	-58.73	-13	-45.73	-75.35	-62.14	1.54	7.10	H
	1648	-51.49	-13	-38.49	-59.14	-53.25	0.98	4.89	V
	2472	-47.34	-13	-34.34	-62.69	-49.22	1.28	5.32	V
	3296	-58.11	-13	-45.11	-73.55	-61.52	1.54	7.10	V
Middle	1672	-49.76	-13	-36.76	-59.1	-51.44	0.99	4.82	H
	2512	-43.34	-13	-30.34	-56.56	-45.31	1.29	5.41	H
	3344	-58.78	-13	-45.78	-75.06	-62.39	1.56	7.31	H
	1672	-52.52	-13	-39.52	-59.76	-54.2	0.99	4.82	V
	2512	-47.74	-13	-34.74	-63.08	-49.71	1.29	5.41	V
	3344	-58.76	-13	-45.76	-74.1	-62.37	1.56	7.31	V
Highest	1696	-52.24	-13	-39.24	-61.74	-53.84	1.00	4.75	H
	2544	-38.68	-13	-25.68	-52.39	-40.66	1.30	5.44	H
	3392	-59.50	-13	-46.50	-75.74	-63.3	1.57	7.52	H
	1696	-55.21	-13	-42.21	-63.01	-56.81	1.00	4.75	V
	2544	-42.03	-13	-29.03	-57.42	-44.01	1.30	5.44	V
	3392	-56.48	-13	-43.48	-72.32	-60.28	1.57	7.52	V

Remark: Spurious emissions within 30-1000MHz were found more than 20dB below limit line.



GSM850 (EDGE class 8)									
Channel	Frequency ( MHz )	ERP ( dBm )	Limit ( dBm )	Over Limit ( dB )	SPA Reading (dBm)	S.G. Power ( dBm )	TX Cable loss ( dB )	TX Antenna Gain (dBi)	Polarization (H/V)
Lowest	1648	-59.38	-13	-46.38	-69.03	-61.14	0.98	4.89	H
	2472	-58.78	-13	-45.78	-71.79	-60.66	1.28	5.32	H
	3296	-59.48	-13	-46.48	-75.7	-62.89	1.54	7.10	H
	1648	-62.76	-13	-49.76	-70.43	-64.52	0.98	4.89	V
	2472	-56.76	-13	-43.76	-72.05	-58.64	1.28	5.32	V
	3296	-60.37	-13	-47.37	-75.73	-63.78	1.54	7.10	V
Middle	1672	-60.92	-13	-47.92	-70.26	-62.6	0.99	4.82	H
	2512	-54.41	-13	-41.41	-67.68	-56.38	1.29	5.41	H
	3344	-59.44	-13	-46.44	-75.68	-63.05	1.56	7.31	H
	1672	-58.60	-13	-45.60	-65.89	-60.28	0.99	4.82	V
	2512	-57.24	-13	-44.24	-72.65	-59.21	1.29	5.41	V
	3344	-60.41	-13	-47.41	-75.59	-64.02	1.56	7.31	V
Highest	1696	-60.89	-13	-47.89	-70.41	-62.49	1.00	4.75	H
	2544	-55.47	-13	-42.47	-69.18	-57.45	1.30	5.44	H
	3392	-59.19	-13	-46.19	-75.61	-62.99	1.57	7.52	H
	1696	-63.29	-13	-50.29	-71.07	-64.89	1.00	4.75	V
	2544	-60.45	-13	-47.45	-73.61	-62.43	1.30	5.44	V
	3392	-62.02	-13	-49.02	-75.67	-65.82	1.57	7.52	V

Remark: Spurious emissions within 30-1000MHz were found more than 20dB below limit line.



GSM1900 (GPRS class 8)									
Channel	Frequency ( MHz )	EIRP ( dBm )	Limit ( dBm )	Over Limit ( dB )	SPA Reading (dBm)	S.G. Power ( dBm )	TX Cable loss ( dB )	TX Antenna Gain (dBi)	Polarization (H/V)
Lowest	3700	-47.64	-13	-34.64	-66.32	-54.21	1.67	8.24	H
	5548	-42.27	-13	-29.27	-65.92	-49.34	2.65	9.72	H
	7403	-46.33	-13	-33.33	-75.29	-55.48	2.46	11.61	H
	3700	-50.86	-13	-37.86	-69.31	-57.43	1.67	8.24	V
	5548	-47.13	-13	-34.13	-69.3	-54.2	2.65	9.72	V
	7403	-48.36	-13	-35.36	-76.26	-57.51	2.46	11.61	V
Middle	3763	-45.56	-13	-32.56	-64.83	-52.19	1.69	8.32	H
	5639	-43.23	-13	-30.23	-67	-50.28	2.71	9.76	H
	7522	-47.72	-13	-34.72	-76.42	-57.11	2.42	11.81	H
	3763	-50.26	-13	-37.26	-68.75	-56.89	1.69	8.32	V
	5639	-44.51	-13	-31.51	-66.85	-51.56	2.71	9.76	V
	7522	-48.61	-13	-35.61	-76.85	-58	2.42	11.81	V
Highest	3819	-45.58	-13	-32.58	-65.18	-52.26	1.70	8.38	H
	5730	-43.31	-13	-30.31	-67.51	-50.34	2.76	9.79	H
	7641	-47.24	-13	-34.24	-75.67	-56.74	2.38	11.88	H
	3819	-49.64	-13	-36.64	-68.31	-56.32	1.70	8.38	V
	5730	-43.99	-13	-30.99	-67.11	-51.02	2.76	9.79	V
	7641	-48.54	-13	-35.54	-76.43	-58.04	2.38	11.88	V

Remark: Spurious emissions within 30-1000MHz were found more than 20dB below limit line.





GSM1900 (EDGE class 8)									
Channel	Frequency ( MHz )	EIRP ( dBm )	Limit ( dBm )	Over Limit ( dB )	SPA Reading (dBm)	S.G. Power ( dBm )	TX Cable loss ( dB )	TX Antenna Gain (dBi)	Polarization (H/V)
Lowest	3700	-51.02	-13	-38.02	-69.71	-57.59	1.67	8.24	H
	5548	-52.24	-13	-39.24	-75.75	-59.31	2.65	9.72	H
	7403	-47.70	-13	-34.70	-76.41	-56.85	2.46	11.61	H
	3700	-56.60	-13	-43.60	-75.19	-63.17	1.67	8.24	V
	5548	-54.94	-13	-41.94	-77.07	-62.01	2.65	9.72	V
	7403	-48.47	-13	-35.47	-76.4	-57.62	2.46	11.61	V
Middle	3763	-51.03	-13	-38.03	-70.15	-57.66	1.69	8.32	H
	5639	-52.10	-13	-39.10	-75.83	-59.15	2.71	9.76	H
	7522	-46.63	-13	-33.63	-75.25	-56.02	2.42	11.81	H
	3763	-54.53	-13	-41.53	-73.22	-61.16	1.69	8.32	V
	5639	-53.32	-13	-40.32	-75.51	-60.37	2.71	9.76	V
	7522	-48.40	-13	-35.40	-76.66	-57.79	2.42	11.81	V
Highest	3819	-53.24	-13	-40.24	-72.87	-59.92	1.70	8.38	H
	5730	-52.06	-13	-39.06	-76.14	-59.09	2.76	9.79	H
	7641	-47.86	-13	-34.86	-76.25	-57.36	2.38	11.88	H
	3819	-54.53	-13	-41.53	-73.32	-61.21	1.70	8.38	V
	5730	-53.44	-13	-40.44	-76.61	-60.47	2.76	9.79	V
	7641	-48.49	-13	-35.49	-76.42	-57.99	2.38	11.88	V

Remark: Spurious emissions within 30-1000MHz were found more than 20dB below limit line.



WCDMA Band V (RMC 12.2Kbps)									
Channel	Frequency ( MHz )	ERP ( dBm )	Limit ( dBm )	Over Limit ( dB )	SPA Reading (dBm)	S.G. Power ( dBm )	TX Cable loss ( dB )	TX Antenna Gain (dBi)	Polarization (H/V)
Lowest	1656	-64.37	-13	-51.37	-73.86	-66.1	0.98	4.86	H
	2480	-62.09	-13	-49.09	-75.07	-64	1.28	5.34	H
	3304	-59.12	-13	-46.12	-75.61	-62.56	1.54	7.14	H
	1656	-66.41	-13	-53.41	-73.86	-68.14	0.98	4.86	V
	2480	-59.88	-13	-46.88	-75.03	-61.79	1.28	5.34	V
	3304	-60.44	-13	-47.44	-75.8	-63.88	1.54	7.14	V
Middle	1672	-63.95	-13	-50.95	-73.26	-65.63	0.99	4.82	H
	2504	-61.63	-13	-48.63	-74.72	-63.59	1.29	5.40	H
	3344	-59.40	-13	-46.40	-75.58	-63.01	1.56	7.31	H
	1672	-66.31	-13	-53.31	-73.45	-67.99	0.99	4.82	V
	2504	-59.59	-13	-46.59	-74.9	-61.55	1.29	5.40	V
	3344	-59.59	-13	-46.59	-75.77	-63.2	1.56	7.31	V
Highest	1696	-62.77	-13	-49.77	-72.24	-64.37	1.00	4.75	H
	2536	-60.92	-13	-47.92	-74.45	-62.9	1.30	5.43	H
	3384	-59.05	-13	-46.05	-75.38	-62.82	1.57	7.49	H
	1696	-65.06	-13	-52.06	-72.9	-66.66	1.00	4.75	V
	2536	-52.05	-13	-39.05	-67.44	-54.03	1.30	5.43	V
	3384	-59.46	-13	-46.46	-75.33	-63.23	1.57	7.49	V

Remark: Spurious emissions within 30-1000MHz were found more than 20dB below limit line.



WCDMA Band II (RMC 12.2Kbps)									
Channel	Frequency ( MHz )	EIRP ( dBm )	Limit ( dBm )	Over Limit ( dB )	SPA Reading (dBm)	S.G. Power ( dBm )	TX Cable loss ( dB )	TX Antenna Gain (dBi)	Polarization (H/V)
Lowest	3707	-53.08	-13	-40.08	-71.7	-59.66	1.67	8.25	H
	5555	-45.95	-13	-32.95	-69.66	-53.02	2.66	9.72	H
	7403	-46.26	-13	-33.26	-75.14	-55.41	2.46	11.61	H
	3707	-56.09	-13	-43.09	-74.56	-62.67	1.67	8.25	V
	5555	-48.42	-13	-35.42	-70.62	-55.49	2.66	9.72	V
	7403	-47.95	-13	-34.95	-75.96	-57.1	2.46	11.61	V
Middle	3756	-53.86	-13	-40.86	-72.97	-60.48	1.68	8.31	H
	5639	-49.23	-13	-36.23	-72.91	-56.28	2.71	9.76	H
	7522	-48.05	-13	-35.05	-76.75	-57.44	2.42	11.81	H
	3763	-55.37	-13	-42.37	-73.95	-62	1.69	8.32	V
	5646	-51.26	-13	-38.26	-73.6	-58.31	2.71	9.76	V
	7522	-48.38	-13	-35.38	-76.72	-57.77	2.42	11.81	V
Highest	3812	-51.91	-13	-38.91	-71.31	-58.58	1.70	8.37	H
	5723	-46.15	-13	-33.15	-70.31	-53.19	2.75	9.79	H
	7634	-42.26	-13	-29.26	-75.63	-51.75	2.39	11.88	H
	3819	-54.23	-13	-41.23	-72.95	-60.91	1.70	8.38	V
	5723	-49.64	-13	-36.64	-72.82	-56.68	2.75	9.79	V
	7634	-48.55	-13	-35.55	-76.51	-58.04	2.39	11.88	V

Remark: Spurious emissions within 30-1000MHz were found more than 20dB below limit line.