



# FCC RF Test Report

**APPLICANT** : Sony Mobile Communications Inc.  
**EQUIPMENT** : GSM/WCDMA/LTE Phone + Bluetooth, DTS/UNII  
a/b/g/n/ac, ANT+, and NFC  
**BRAND NAME** : Sony  
**FCC ID** : PY7-PM0913  
**STANDARD** : FCC Part 15 Subpart C §15.225  
**CLASSIFICATION** : (DXX) Low Power Communication Device Transmitter

The testing was completed on Sep. 10, 2015. We, SPORTON INTERNATIONAL INC., would like to declare that the tested sample has been evaluated in accordance with the test procedures and has been in compliance with the applicable technical standards.

The test results in this report apply exclusively to the tested model / sample. Without written approval of SPORTON INTERNATIONAL INC., the test report shall not be reproduced except in full.

Reviewed by: Joseph Lin / Supervisor

Approved by: Jones Tsai / Manager



**SPORTON INTERNATIONAL INC.**

**No. 52, Hwa Ya 1<sup>st</sup> Rd., Hwa Ya Technology Park, Kwei-Shan District, Tao Yuan City, Taiwan, R.O.C.**



Table of Contents

REVISION HISTORY.....3
SUMMARY OF THE TEST RESULT .....4
1. GENERAL INFORMATION.....5
1.1 Applicant.....5
1.2 Manufacturer.....5
1.3 Product Details.....5
1.4 Modification of EUT.....6
1.5 Testing Location.....6
1.6 Applicable Standards.....7
1.7 Test Modes.....7
1.8 Test Configurations.....8
1.9 Table for Supporting Units.....9
2. CONDUCTED EMISSION TEST.....10
2.1 Measuring Instruments.....10
2.2 Test setup.....10
2.3 Test Result of Conducted Emission Test.....10
2.4 AC Power Line Conducted Emissions Measurement.....11
3. CONDUCTED TEST ITEMS .....12
3.1 Measuring Instruments.....12
3.2 Test Setup.....12
3.3 Test Result of Conducted Test Items.....12
3.4 20dB and 99% OBW Spectrum Bandwidth Measurement.....13
3.5 Frequency Stability Measurement.....13
4. RADIATED TEST ITEMS.....14
4.1 Measuring Instruments.....14
4.2 Test Setup.....14
4.3 Test Result of Radiated Test Items.....14
4.4 Field Strength of Fundamental Emissions and Mask Measurement.....15
4.5 Radiated Emissions Measurement.....16
5. LIST OF MEASURING EQUIPMENT .....18
APPENDIX A. TEST RESULTS OF CONDUCTED EMISSION TEST
APPENDIX B. TEST RESULTS OF CONDUCTED TEST ITEMS
B.1.Test Result of 20dB Spectrum Bandwidth
B.2 Test Result of Frequency Stability
APPENDIX C. TEST RESULTS OF RADIATED TEST ITEMS
C.1 Test Result of Field Strength of Fundamental Emissions
C.2 Results of Radiated Emissions (9 kHz~30MHz)
C.3 Results of Radiated Emissions (30MHz~1GHz)





### SUMMARY OF THE TEST RESULT

Applied Standard: 47 CFR FCC Part 15 Subpart C				
Part	FCC Rule	Description of Test	Result	Under Limit
3.1	15.207	AC Power Line Conducted Emissions	Complies	1.70 dB at 13.558 MHz
3.2	15.225(a)(b)(c)	Field Strength of Fundamental Emissions	Complies	64.67 dB at 13.560 MHz
3.3	2.1049	20dB Spectrum Bandwidth	Complies	-
	-	99% OBW Spectrum Bandwidth		
3.4	15.225(d)	Radiated Emissions	Complies	9.27 dB at 40.530 MHz
	15.209			
3.5	15.225(e)	Frequency Stability	Complies	-
3.6	15.203	Antenna Requirements	Complies	-

**Remark:** The FCC ID: PY7-PM0911 and FCC ID: PY7-PM0913 is similar device, in this report all the test result are referred to PY7-PM0911, Sporton Report No: FR571621D.

Test Items	Uncertainty	Remark
AC Power Line Conducted Emissions	±2.26dB	Confidence levels of 95%
Radiated Emissions (30MHz~1000MHz)	±4.8dB	Confidence levels of 95%



# 1. GENERAL INFORMATION

## 1.1 Applicant

**Sony Mobile Communications Inc.**  
Nya Vattentornet, 22188 Lund, Sweden

## 1.2 Manufacturer

**Sony Mobile Communications Inc.**  
1-8-15 Konan, Minato-ku, Tokyo, 108-0075, Japan

## 1.3 Product Details

Items	Description
Channel Number	1
20dBW	2.64kHz
99%OBW	2.24kHz

**Remark:** The above EUT's information was declared by manufacturer. Please refer to the specifications or user's manual for more detailed description.

EUT Information List				
IMEI	HW Version	SW Version	S/N	Performed Test Item
004402455447874	A	32.0.A.0.323	CB5A27SPBX	RF Conducted Measurement Radiated Emission AC Conducted Emission



Accessory List	
AC Adapter	Model No. : UCH20
	Type No. : AC-0061-US
	S/N : 5815W22500089 (for Radiated Spurious Emission) 5815W22500112 (for Conducted Emission)
Earphone	Model No. : MDR-NC750
	Type No. : AG-0020
USB Cable	Model No. : UCB11
	Type No. : AI-0120
	S/N : 1015W02400014C (for Radiated Spurious Emission) 1522A7370000074 (for Conducted Emission)

**Note:**

1. Above EUT list and accessory list used are electrically identical per declared by manufacturer.
2. Above the accessories list are used to exercise the EUT during test.
3. For other wireless features of this EUT, test report will be issued separately.

**1.4 Modification of EUT**

No modifications are made to the EUT during all test items.

**1.5 Testing Location**

Sporton Lab is accredited to ISO 17025 by Taiwan Accreditation Foundation (TAF code : 1190) and the FCC designation No. TW1022 under the FCC 2.948(e) by Mutual Recognition Agreement (MRA) in FCC Test.

<b>Test Site</b>	SPORTON INTERNATIONAL INC.		
<b>Test Site Location</b>	No. 52, Hwa Ya 1 <sup>st</sup> Rd., Hwa Ya Technology Park, Kwei-Shan District, Tao Yuan City, Taiwan, R.O.C. TEL: +886-3-3273456 / FAX: +886-3-3284978		
<b>Test Site No.</b>	<b>Sporton Site No.</b>		
	TH03-HY	CO05-HY	03CH07-HY
<b>Test Engineer</b>	Danny Chen	Derreck Chen	Wei Chen
<b>Temperature</b>	22~24°C	23~25°C	21~24°C
<b>Relative Humidity</b>	53~55%	58~61%	56~58%

**Note:** The test site complies with ANSI C63.4 2009 requirement.



### 1.6 Applicable Standards

According to the specifications of the manufacturer, the EUT must comply with the requirements of the following standards:

- ♦ FCC Part 15 Subpart C §15.225
- ♦ ANSI C63.10-2009

### 1.7 Test Modes

Investigation has been done on all the possible configurations for searching the worst cases. The following table is a list of the test modes shown in this test report.

Test Items	
AC Power Line Conducted Emissions	Field Strength of Fundamental Emissions
20dB Spectrum Bandwidth	Frequency Stability
Radiated Emissions 9kHz~30MHz	Radiated Emissions 30MHz~1GHz
<b>Note:</b> 1. The EUT was programmed to be in continuously transmitting mode. 2. The ancillary equipment, NFC card, is used to make the EUT (NFC) continuously transmit at 13.56MHz and is placed around 3 cm gap to the EUT.	

## 1.8 Test Configurations

### <AC Conducted Emissions>

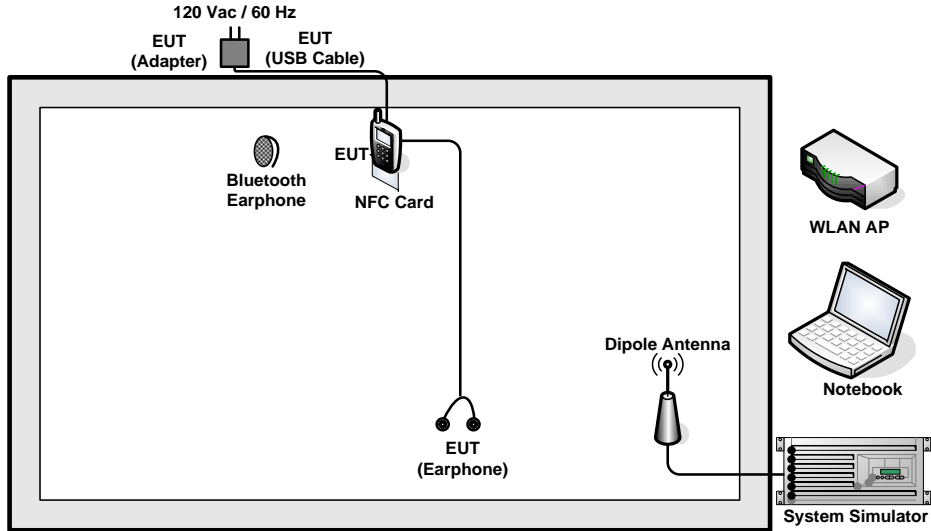

### <For Fundamental Emissions and Mask and Radiated Emissions Measurement>

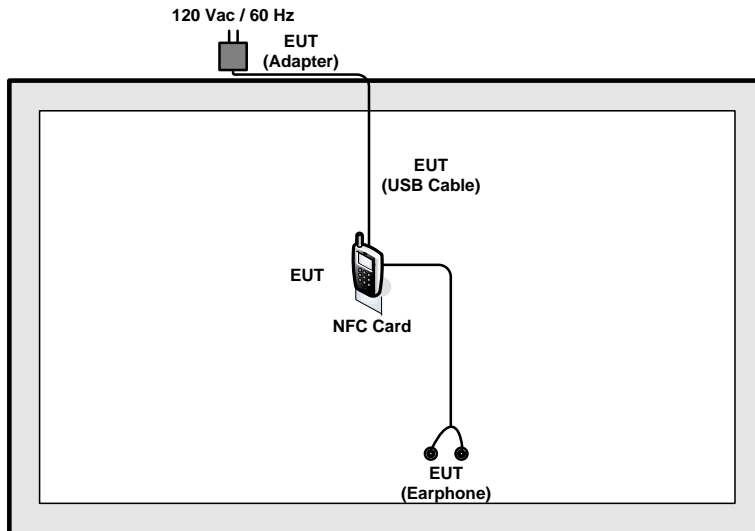





1.9 Table for Supporting Units

Item	Equipment	Trade Name	Model Name	FCC ID	Data Cable	Power Cord
1.	System Simulator	Anritsu	MT8820C	N/A	N/A	Unshielded, 1.8 m
2.	WLAN AP	D-Link	DIR-628	KA2DIR628A2	N/A	Unshielded, 1.8 m
3.	Bluetooth Earphone	Sony	SBH20	PY7-RD0010	Unshielded, 0.75m	N/A
4.	Notebook	DELL	Latitude E6320	FCC DoC/ Contains FCC ID: QDS-BRCM1054	N/A	AC I/P: Unshielded, 1.2 m DC O/P: Shielded, 1.8 m
5.	NFC Card	Metro Taipei	Easy Card	N/A	N/A	N/A
6.	SD Card	SanDisk	MicroSD HC	FCC DoC	N/A	N/A

## 2. CONDUCTED EMISSION TEST

### 2.1 Measuring Instruments

See list of measuring instruments of this test report.

### 2.2 Test setup

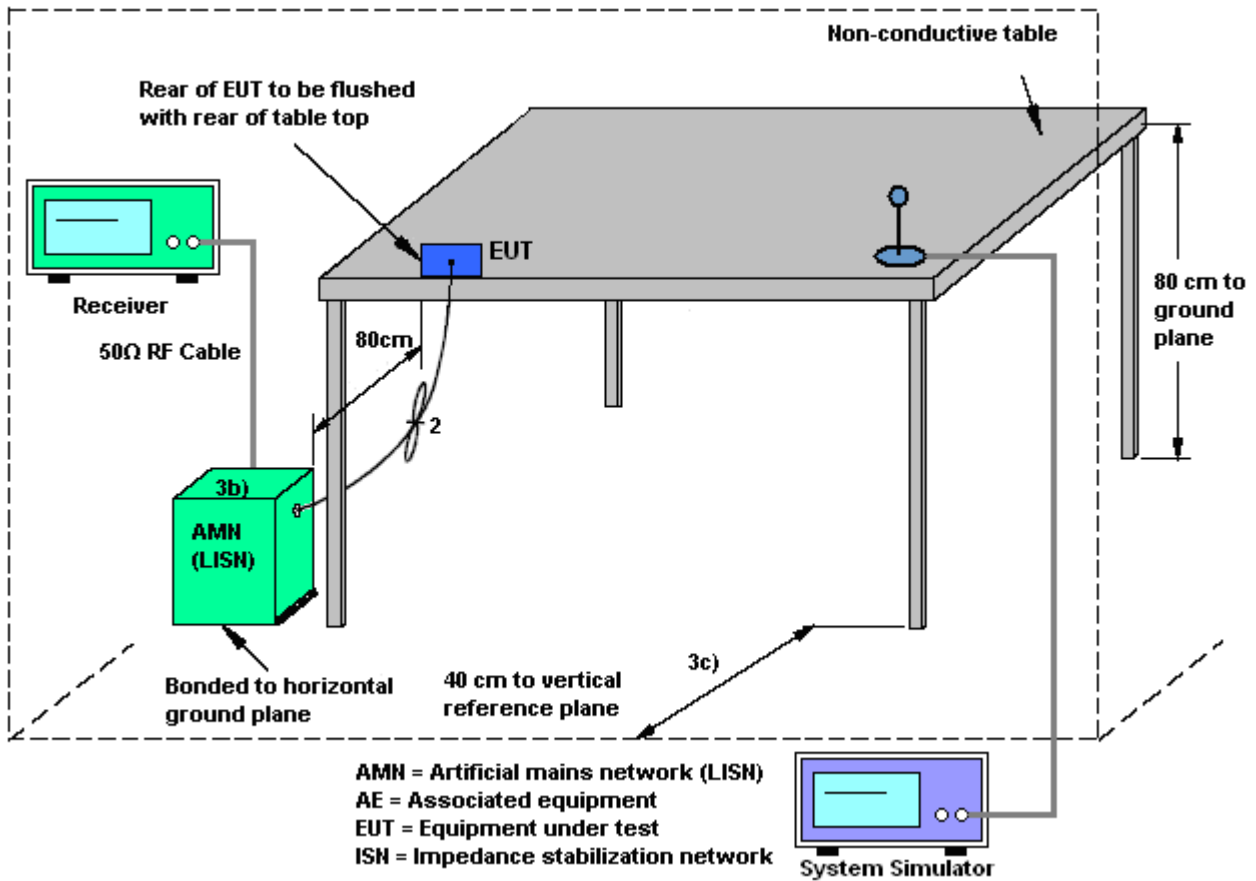

### 2.3 Test Result of Conducted Emission Test

Please refer to Appendix A.



## 2.4 AC Power Line Conducted Emissions Measurement

### 2.4.1 Limit

For equipment that is designed to be connected to the public utility (AC) power line, the radio frequency voltage that is conducted back onto the AC power line on any frequency or frequencies within the band 150 kHz to 30 MHz shall not exceed the limits in the following table.

Frequency of Emission (MHz)	Conducted Limit (dBµV)	
	Quasi-Peak	Average
0.15-0.5	66 to 56*	56 to 46*
0.5-5	56	46
5-30	60	50

\*Decreases with the logarithm of the frequency.

### 2.4.2 Test Procedures

1. The EUT was placed 0.4 meter from the conducting wall of the shielding room, and it was kept at least 80 centimeters from any other grounded conducting surface.
2. Connect EUT to the power mains through a line impedance stabilization network (LISN).
3. All the support units are connecting to the other LISN.
4. The LISN provides 50 ohm coupling impedance for the measuring instrument.
5. The FCC states that a 50 ohm, 50 microhenry LISN should be used.
6. Both sides of AC line were checked for maximum conducted interference.
7. The frequency range from 150 kHz to 30 MHz was searched.
8. Set the test-receiver system to Peak Detect Function and specified bandwidth (IF Bandwidth = 9kHz) with Maximum Hold Mode. Then measurement is also conducted by Average Detector and Quasi-Peak Detector Function respectively.

### 3. CONDUCTED TEST ITEMS

#### 3.1 Measuring Instruments

See list of measuring instruments of this test report.

#### 3.2 Test Setup

##### 3.2.1 20dB and 99% OBW Spectrum Bandwidth

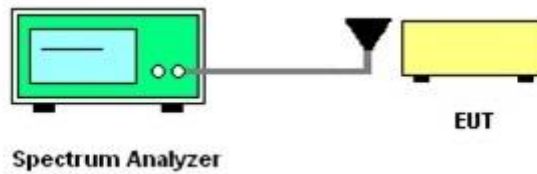

##### 3.2.2 Frequency Stability

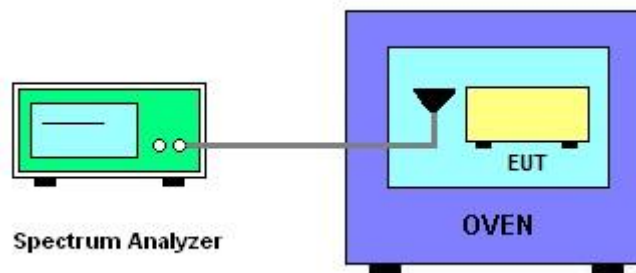

#### 3.3 Test Result of Conducted Test Items

Please refer to Appendix B.



### **3.4 20dB and 99% OBW Spectrum Bandwidth Measurement**

#### **3.4.1 Limit**

Intentional radiators must be designed to ensure that the 20dB and 99% emission bandwidth in the specific band 13.553~13.567MHz.

#### **3.4.2 Test Procedures**

1. The spectrum analyzer connected via a receive antenna placed near the EUT in peak Max hold mode.
2. The resolution bandwidth of 1 kHz and the video bandwidth of 3 kHz were used.
3. Measured the spectrum width with power higher than 20dB below carrier.
4. Measured the 99% OBW.

### **3.5 Frequency Stability Measurement**

#### **3.5.1 Limit**

The frequency tolerance of the carrier signal shall be maintained within +/- 0.01% (100ppm) of the operating frequency over a temperature variation of -20 degrees to +50 degrees C at normal supply voltage, and for a variation in the primary supply voltage from 85% to 115% of the rated supply voltage at a temperature of 20 degrees C. For battery operated equipment, the equipment tests shall be performed using a new battery.

#### **3.5.2 Test Procedures**

1. The spectrum analyzer connected via a receive antenna placed near the EUT.
2. EUT have transmitted signal and fixed channelize.
3. Set the spectrum analyzer span to view the entire emissions bandwidth.
4. Set RBW = 1 kHz, VBW = 3 kHz with peak detector and maxhold settings.
5. The fc is declaring of channel frequency. Then the frequency error formula is  $(f_c - f) / f_c \times 10^6$  ppm and the limit is less than  $\pm 100$ ppm.
6. Extreme temperature rule is -20°C~50°C.

## 4. RADIATED TEST ITEMS

### 4.1 Measuring Instruments

See list of measuring instruments of this test report.

### 4.2 Test Setup

#### 4.2.1 For radiated emissions below 30MHz

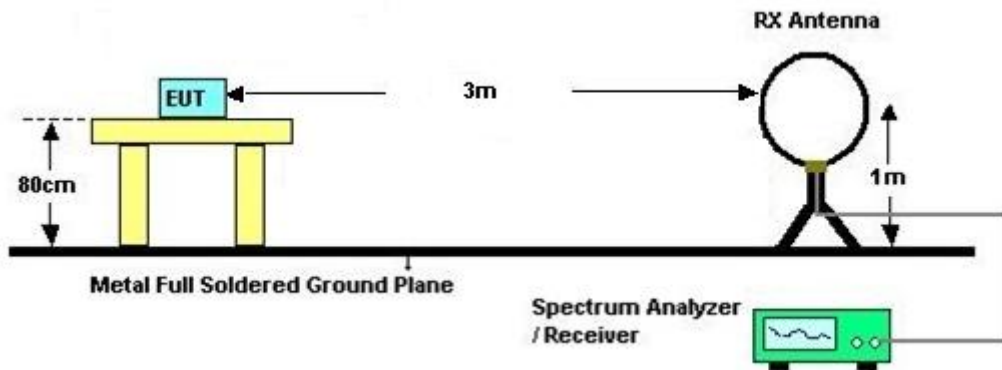

#### 4.2.2 For radiated emissions above 30MHz

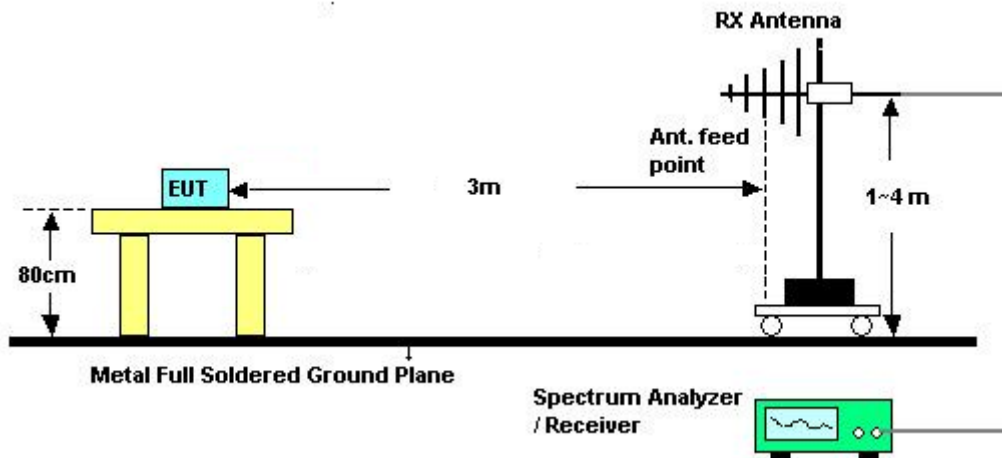

### 4.3 Test Result of Radiated Test Items

Please refer to Appendix C.



### 4.4 Field Strength of Fundamental Emissions and Mask Measurement

#### 4.4.1 Limit

Rules and specifications	FCC CFR 47 Part 15 section 15.225			
Description	Compliance with the spectrum mask is tested with RBW set to 9kHz.			
Freq. of Emission (MHz)	Field Strength (μV/m) at 30m	Field Strength (dBμV/m) at 30m	Field Strength (dBμV/m) at 10m	Field Strength (dBμV/m) at 3m
1.705~13.110	30	29.5	48.58	69.5
13.110~13.410	106	40.5	59.58	80.5
13.410~13.553	334	50.5	69.58	90.5
13.553~13.567	15848	84.0	103.08	124.0
13.567~13.710	334	50.5	69.58	90.5
13.710~14.010	106	40.5	59.58	80.5
14.010~30.000	30	29.5	48.58	69.5

#### 4.4.2 Test Procedures

1. Configure the EUT according to ANSI C63.10. The EUT was placed on the top of the turntable 0.8 meter above ground. The phase center of the loop receiving antenna mounted antenna tower was placed 3 meters far away from the turntable.
2. Power on the EUT and all the supporting units. The turntable was rotated by 360 degrees to determine the position of the highest radiation.
3. The height of the receiving antenna was fixed at one meter above ground to find the maximum emissions field strength.
4. For Fundamental emissions, use the receiver to measure QP reading.
5. When the radiated emissions limits are expressed in terms of the average value of the emissions, and pulsed operation is employed, the measurement field strength shall be determined by averaging over one complete pulse train, including blanking intervals, as long as the pulse train does not exceed 0.1 seconds. As an alternative (provided the transmitter operates for longer than 0.1 seconds) or in cases where the pulse train exceeds 0.1 seconds, the measured field strength shall be determined from the average absolute voltage during a 0.1 second interval during which the field strength is at its maximum value.
6. Compliance with the spectrum mask is tested with RBW set to 9kHz.

Note: Emission level (dBμV/m) = 20 log Emission level (μV/m).



### 4.5 Radiated Emissions Measurement

#### 4.5.1 Limit

The field strength of any emissions which appear outside of 13.110 ~14.010MHz band shall not exceed the general radiated emissions limits.

Frequencies (MHz)	Field Strength (µV/m)	Measurement Distance (meters)
0.009~0.490	2400/F(kHz)	300
0.490~1.705	24000/F(kHz)	30
1.705~30.0	30	30
30~88	100	3
88~216	150	3
216~960	200	3
Above 960	500	3

#### 4.5.2 Measuring Instrument Setting

The following table is the setting of receiver.

Receiver Parameter	Setting
Attenuation	Auto
Frequency Range: 9kHz~150kHz	RBW 200Hz for QP
Frequency Range: 150kHz~30MHz	RBW 9kHz for QP
Frequency Range: 30MHz~1000MHz	RBW 120kHz for Peak

**Note:** The emission limits shown in the above table are based on measurements employing a CISPR quasi-peak detector except for the frequency bands 9-90 kHz, 110-490 kHz. Radiated emission limits in these two bands are based on measurements employing an average detector.





### 4.5.3 Test Procedures

1. Configure the EUT according to ANSI C63.4. The EUT was placed on the top of the turntable 0.8 meter above ground. The phase center of the receiving antenna mounted on the top of a height-variable antenna tower was placed 3 meters far away from the turntable.
2. Power on the EUT and all the supporting units. The turntable was rotated by 360 degrees to determine the position of the highest radiation.
3. The height of the broadband receiving antenna was varied between one meter and four meters above ground to find the maximum emissions field strength of both horizontal and vertical polarization.
4. For each suspected emissions, the antenna tower was scan (from 1 M to 4 M) and then the turntable was rotated (from 0 degree to 360 degrees) to find the maximum reading.
5. Set the test-receiver system to Peak or CISPR quasi-peak Detect Function with specified bandwidth under Maximum Hold Mode.
6. When the radiated emissions limits are expressed in terms of the average value of the emissions, and pulsed operation is employed, the measurement field strength shall be determined by averaging over one complete pulse train, including blanking intervals, as long as the pulse train does not exceed 0.1 seconds. As an alternative (provided the transmitter operates for longer than 0.1 seconds) or in cases where the pulse train exceeds 0.1 seconds, the measured field strength shall be determined from the average absolute voltage during a 0.1 second interval during which the field strength is at its maximum value.
7. In case the emission is lower than 30MHz, loop antenna has to be used for measurement and the recorded data should be QP measured by receiver. Antenna Requirements

### 4.5.4 Limit

Except for special regulations, the Low-power Radio-frequency Devices must not be equipped with any jacket for installing an antenna with extension cable. An intentional radiator shall be designed to ensure that no antenna other than that furnished by the responsible party shall be used with the device. The use of a permanently attached antenna or of an antenna that uses a unique coupling to the intentional radiator shall be considered sufficient to comply with the provisions of this Section. The manufacturer may design the unit so that the user can replace a broken antenna, but the use of a standard antenna jack or electrical connector is prohibited.

### 4.5.5 Antenna Anti-Replacement Construction

An embedded-in antenna design is used.



### 5. LIST OF MEASURING EQUIPMENT

Instrument	Manufacturer	Model No.	Serial No.	Characteristics	Calibration Date	Test Date	Due Date	Remark
Spectrum Analyzer	Rohde & Schwarz	FSP30	101329	9kHz~30GHz	Jun. 24, 2015	Sep. 10, 2015	Jun. 23, 2016	Conducted (TH03-HY)
RF cable	WOKEN	S05	S05-130708-22	N/A	Jan. 21, 2015	Sep. 10, 2015	Jan. 20, 2016	Conducted (TH03-HY)
Hygrometer	Testo	608-H1	34893241	N/A	May 04, 2015	Sep. 10, 2015	May 03, 2016	Conducted (TH03-HY)
Temperature Chamber	ESPEC	SU-641	92013721	-30°C ~70°C	Dec. 01, 2014	Sep. 10, 2015	Nov. 30, 2015	Conducted (TH03-HY)
EMI Test Receiver	Rohde & Schwarz	ESCS 30	100356	9kHz ~ 2.75GHz	Dec. 01, 2014	Sep. 08, 2015	Nov. 30, 2015	Conduction (CO05-HY)
Hygrometer	Testo	608-H1	34913912	N/A	Apr. 20, 2015	Sep. 08, 2015	Apr. 19, 2016	Conduction (CO05-HY)
LISN	Rohde & Schwarz	ENV216	100080	9kHz~30MHz	Dec. 02, 2014	Sep. 08, 2015	Dec. 01, 2015	Conduction (CO05-HY)
AC Power Source	ChainTek	APC-1000W	N/A	N/A	N/A	Sep. 08, 2015	N/A	Conduction (CO05-HY)
LF Cable	HUBER + SUHNER	RG-214/U	LF01	N/A	Jan. 07, 2015	Sep. 08, 2015	Jan. 06, 2016	Conduction (CO05-HY)
Bilog Antenna	Schaffner	CBL6111C	2726	30MHz ~ 1GHz	Sep. 27, 2014	Sep. 09, 2015	Sep. 26, 2015	Radiation (03CH07-HY)
Hygrometer	Testo	608-H1	34897197	N/A	May 04, 2015	Sep. 09, 2015	May 03, 2016	Radiation (03CH07-HY)
Loop Antenna	TESEQ	HLA 6120	31244	9 kHz~30 MHz	Feb. 02, 2015	Sep. 09, 2015	Feb. 01, 2016	Radiation (03CH07-HY)
Preamplifier	COM-POWER	PA-103A	161241	10MHz-1000MHz	Mar. 12, 2015	Sep. 09, 2015	Mar. 11, 2016	Radiation (03CH07-HY)
Signal Analyzer	Rohde & Schwarz	FSV 30	101749	10Hz~30GHz	Mar. 10, 2015	Sep. 09, 2015	Mar. 09, 2016	Radiation (03CH07-HY)
EMI Test Receiver	Rohde & Schwarz	ESCI 7	100724	9kHz~7GHz	Aug. 25, 2015	Sep. 09, 2015	Aug. 24, 2016	Radiation (03CH07-HY)
Controller	ChainTek	Chaintek 3000	N/A	Control Turn table	N/A	Sep. 09, 2015	N/A	Radiation (03CH07-HY)
Controller	Max-Full	MF7802	MF780208368	Control Ant Mast	N/A	Sep. 09, 2015	N/A	Radiation (03CH07-HY)
Antenna Mast	Max-Full	MFA520BS	N/A	1m~4m	N/A	Sep. 09, 2015	N/A	Radiation (03CH07-HY)
Turn Table	ChainTek	Chaintek 3000	N/A	0~360 degree	N/A	Sep. 09, 2015	N/A	Radiation (03CH07-HY)
RF Cable	HUBER + SUHNER	SUCOFLEX 104	MY84209521	1GHz~40GHz	Dec. 04, 2014	Sep. 09, 2015	Dec. 03, 2015	Radiation (03CH07-HY)
RF Cable	HUBER + SUHNER	SUCOFLEX 104	MY84209521	9kHz~1GHz	Dec. 04, 2014	Sep. 09, 2015	Dec. 03, 2015	Radiation (03CH07-HY)
Test Software	N/A	E3	6.2009-8-24 (sporton)	N/A	N/A	Sep. 09, 2015	N/A	Radiation (03CH07-HY)
Filter	Wainwright	WHK20 /1000C7/40S S	SN2	20M High Pass	Oct. 01, 2014	Sep. 09, 2015	Sep. 30, 2015	Radiation (03CH07-HY)

**Note:** Test equipment calibration is traceable to the procedure of ISO17025.

## Appendix A. Test Results of Conducted Emission Test

Test Mode :	NFC Tx	Test Voltage :	120Vac / 60Hz
Function Type :	GSM850 Idle + Bluetooth Link + WLAN Link + USB Cable (Charging from Adapter) + NFC Tx + Earphone		

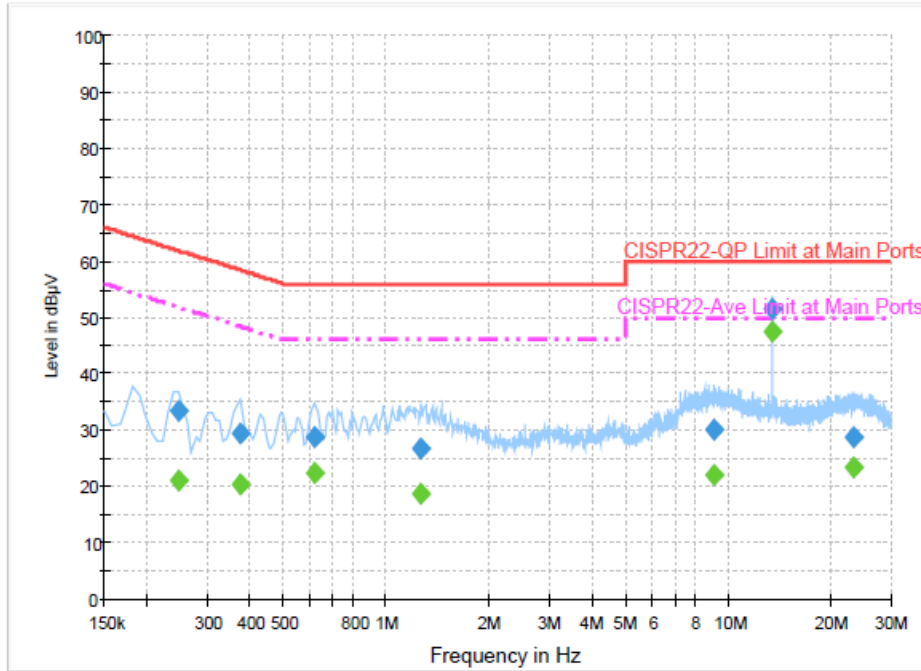

### Final Result : Quasi-Peak

Frequency (MHz)	Quasi-Peak (dBµV)	Filter	Line	Corr. (dB)	Margin (dB)	Limit (dBµV)
0.246000	33.4	Off	L1	19.5	28.5	61.9
0.374000	29.4	Off	L1	19.6	29.0	58.4
0.622000	28.9	Off	L1	19.5	27.1	56.0
1.270000	26.9	Off	L1	19.6	29.1	56.0
9.166000	30.2	Off	L1	19.8	29.8	60.0
13.558000	51.4	Off	L1	19.9	8.6	60.0
23.446000	28.8	Off	L1	19.9	31.2	60.0

### Final Result : Average

Frequency (MHz)	Average (dBµV)	Filter	Line	Corr. (dB)	Margin (dB)	Limit (dBµV)
0.246000	21.0	Off	L1	19.5	30.9	51.9
0.374000	20.4	Off	L1	19.6	28.0	48.4
0.622000	22.5	Off	L1	19.5	23.5	46.0
1.270000	18.6	Off	L1	19.6	27.4	46.0
9.166000	22.0	Off	L1	19.8	28.0	50.0
13.558000	47.4	Off	L1	19.9	2.6	50.0
23.446000	23.3	Off	L1	19.9	26.7	50.0



Test Mode :	NFC Tx	Test Voltage :	120Vac / 60Hz
Function Type :	GSM850 Idle + Bluetooth Link + WLAN Link + USB Cable (Charging from Adapter) + NFC Tx + Earphone		

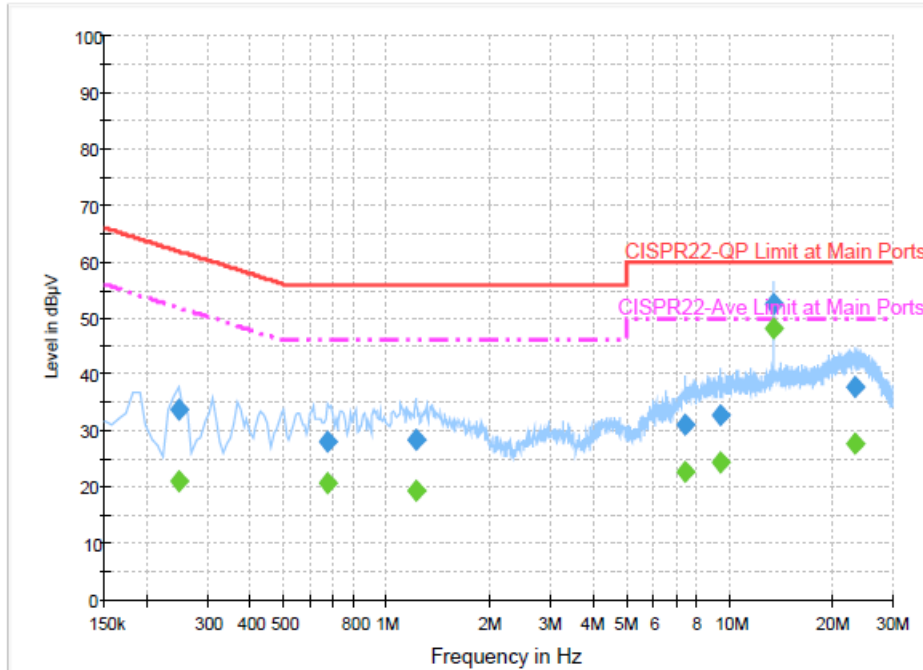

**Final Result : Quasi-Peak**

Frequency (MHz)	Quasi-Peak (dBµV)	Filter	Line	Corr. (dB)	Margin (dB)	Limit (dBµV)
0.246000	33.9	Off	N	19.5	28.0	61.9
0.670000	28.2	Off	N	19.6	27.8	56.0
1.214000	28.4	Off	N	19.6	27.6	56.0
7.478000	30.9	Off	N	19.7	29.1	60.0
9.470000	32.8	Off	N	19.8	27.2	60.0
13.558000	52.4	Off	N	19.9	7.6	60.0
23.430000	37.8	Off	N	20.0	22.2	60.0

**Final Result : Average**

Frequency (MHz)	Average (dBµV)	Filter	Line	Corr. (dB)	Margin (dB)	Limit (dBµV)
0.246000	21.2	Off	N	19.5	30.7	51.9
0.670000	20.9	Off	N	19.6	25.1	46.0
1.214000	19.3	Off	N	19.6	26.7	46.0
7.478000	22.7	Off	N	19.7	27.3	50.0
9.470000	24.6	Off	N	19.8	25.4	50.0
13.558000	48.3	Off	N	19.9	1.7	50.0
23.430000	27.7	Off	N	20.0	22.3	50.0

Remark: 13.558MHz is the NFC RF fundamental signal.



# Appendix B. Test Results of Conducted Test Items

## B.1 Test Result of 20dB Spectrum Bandwidth

Test mode	NFC Tx	Test Frequency (MHz)	13.56
<p>Ref 20 dBm Att 50 dB SWF 20 ms Center 13.56 MHz 1 kHz/ Span 10 kHz</p> <p>RBW 1 kHz VBW 3 kHz Marker 1 [T1] 4.14 dBm            BW 2.64000000 kHz            Temp 1 [T1] 13.55794000 MHz            Temp 2 [T2] 13.56060000 MHz            -15.68 dBm</p> <p>Date: 10.SEP.2015 15:11:49</p>		<p>Ref 20 dBm Att 40 dB SWF 20 ms Center 13.56 MHz 1 kHz/ Span 10 kHz</p> <p>RBW 1 kHz VBW 3 kHz Marker 1 [T1] 3.63 dBm            BW 2.24000000 kHz            Temp 1 [T1] 13.55796 MHz            Temp 2 [T2] 13.56060 MHz            3.63 dBm</p> <p>Date: 10.SEP.2015 15:10:15</p>	
20dB Bandwidth (kHz)	2.640	99% OccupiedBW(kHz)	2.240
Frequency range (MHz)	$f_L > 13.553$	13.55796	Test Result
	$f_H < 13.567$	13.56060	Complies



B.2 Test Result of Frequency Stability

Voltage vs. Frequency Stability		Temperature vs. Frequency Stability	
Voltage (Vac)	Measurement Frequency (MHz)	Temperature (°C)	Measurement Frequency (MHz)
120	13.559280	-20	13.559320
102	13.559280	-10	13.559340
138	13.559280	0	13.559340
		10	13.559320
		20	13.559300
		30	13.559280
		40	13.559260
		50	13.559240
Max.Deviation (MHz)	-0.000720	Max.Deviation (MHz)	-0.000760
Max.Deviation (ppm)	-53.0973	Max.Deviation (ppm)	-56.0472
Limit	FS < ±100 ppm	Limit	FS < ±100 ppm
Test Result	PASS	Test Result	PASS



# Appendix C. Test Results of Radiated Test Items

## C.1 Test Result of Field Strength of Fundamental Emissions

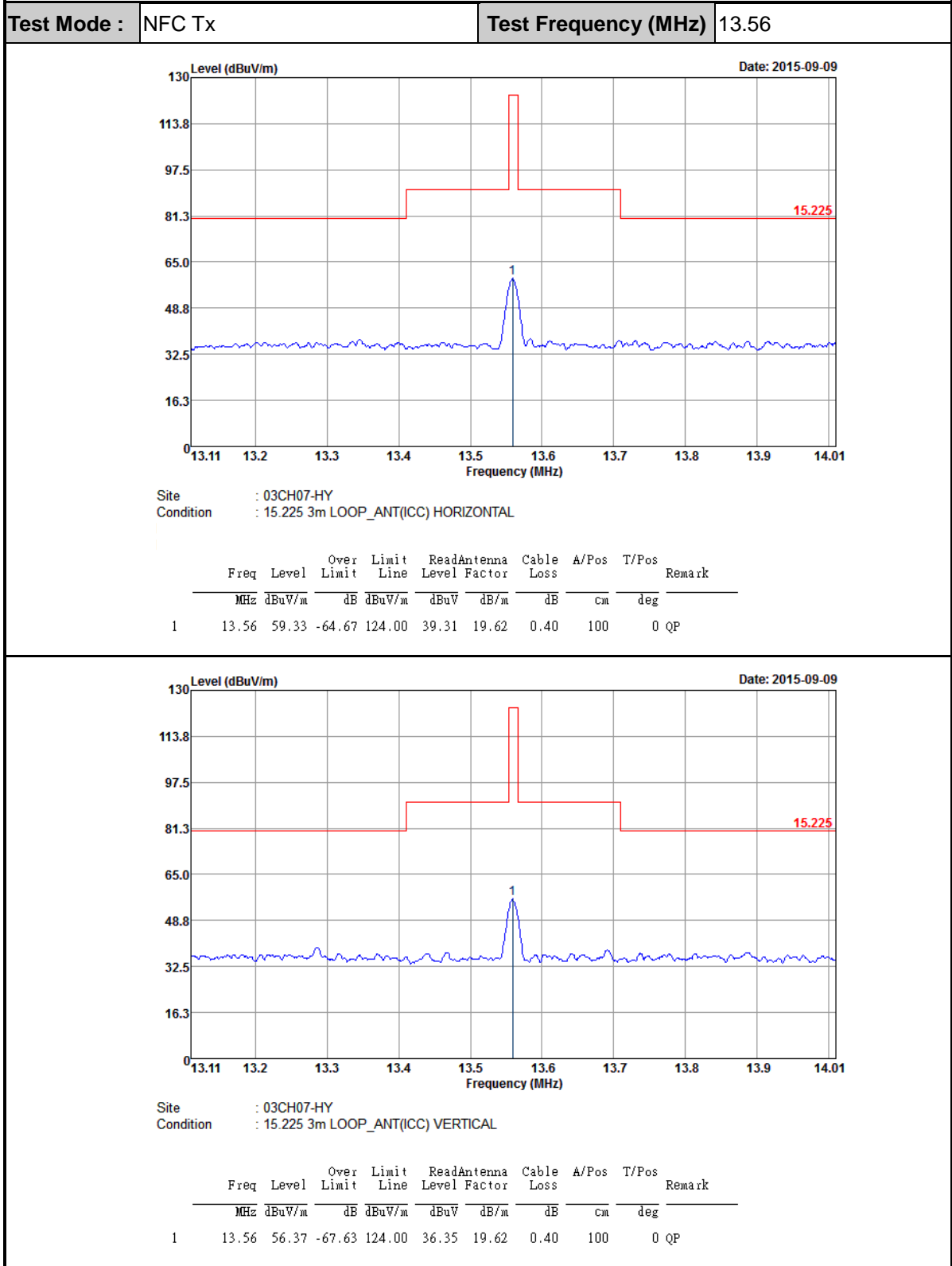

**Note:** All NFC's spurious emissions are below 20dB of limits.



C.2 Results of Radiated Emissions (9 kHz~30MHz)

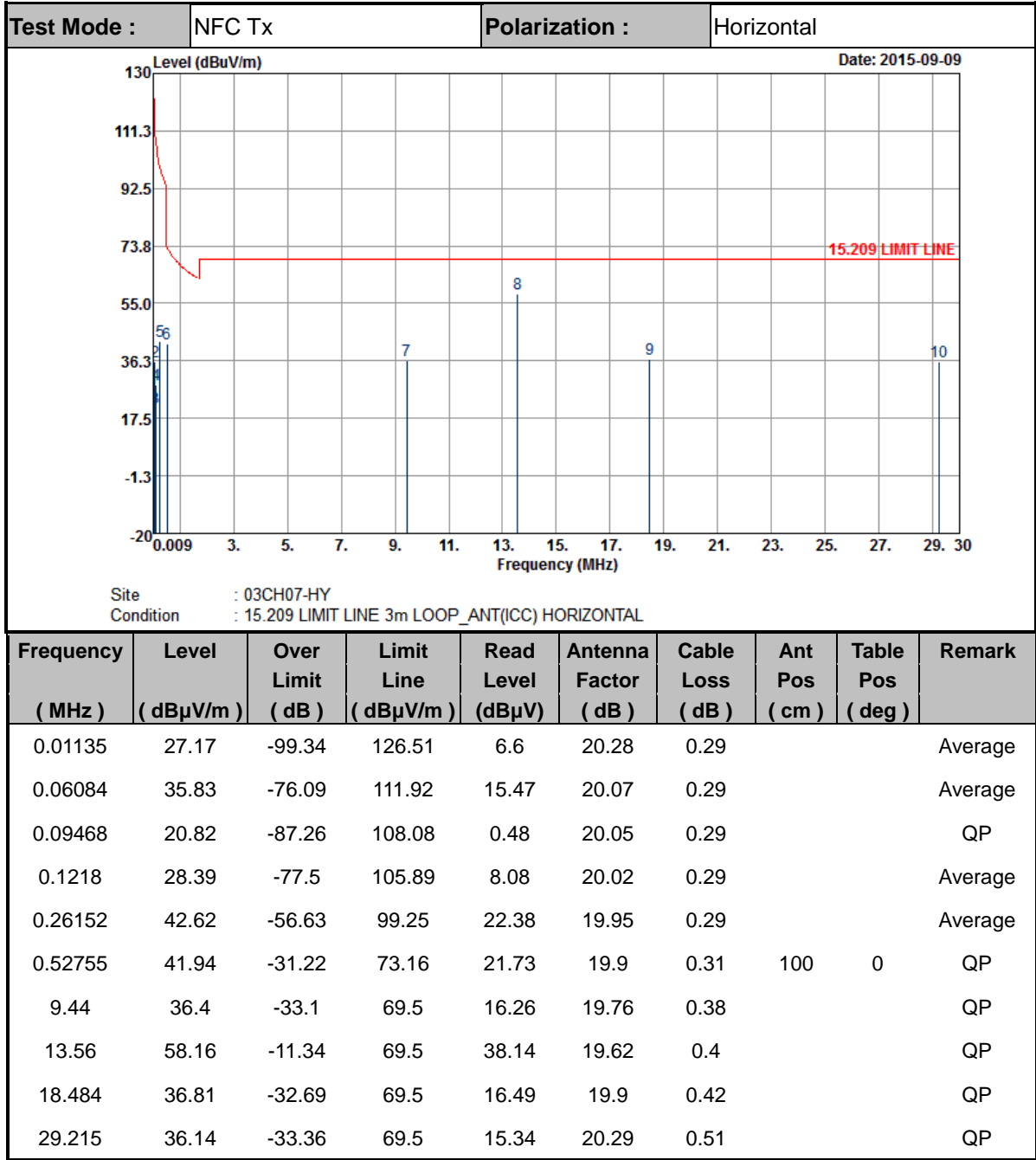



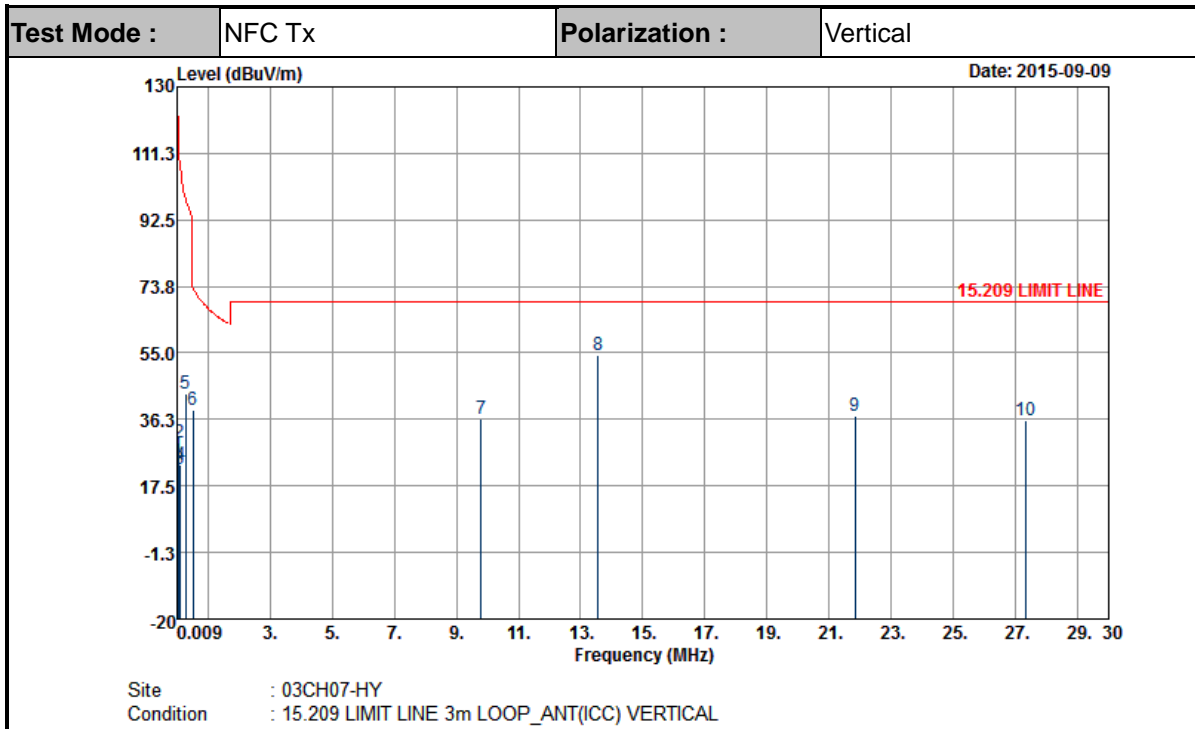

Frequency ( MHz )	Level ( dBμV/m )	Over Limit ( dB )	Limit Line ( dBμV/m )	Read Level ( dBμV )	Antenna Factor ( dB )	Cable Loss ( dB )	Ant Pos ( cm )	Table Pos ( deg )	Remark
0.00992	26.22	-101.46	127.68	5.65	20.28	0.29			Average
0.06111	29.79	-82.09	111.88	9.43	20.07	0.29			Average
0.10308	22.19	-85.15	107.34	1.85	20.05	0.29			QP
0.12204	23.35	-82.52	105.87	3.04	20.02	0.29			Average
0.27716	43.56	-55.19	98.75	23.33	19.94	0.29			Average
0.52755	39.07	-34.09	73.16	18.86	19.9	0.31			QP
9.8	36.49	-33.01	69.5	16.34	19.76	0.39			QP
13.56	54.46	-15.04	69.5	34.44	19.62	0.4			QP
21.841	37.19	-32.31	69.5	16.59	20.16	0.44	100	0	QP
27.32	36.06	-33.44	69.5	15.25	20.33	0.48			QP

**Note:**

1. 13.56 MHz is fundamental signal which can be ignored.
2. The amplitude of spurious emissions which are attenuated by more than 20dB below the permissible value has no need to be reported.
3. Distance extrapolation factor = 40 log (specific distance / test distance) (dB);
4. Limit line = specific limits (dBμV) + distance extrapolation factor.



C.3 Results of Radiated Emissions (30MHz~1GHz)

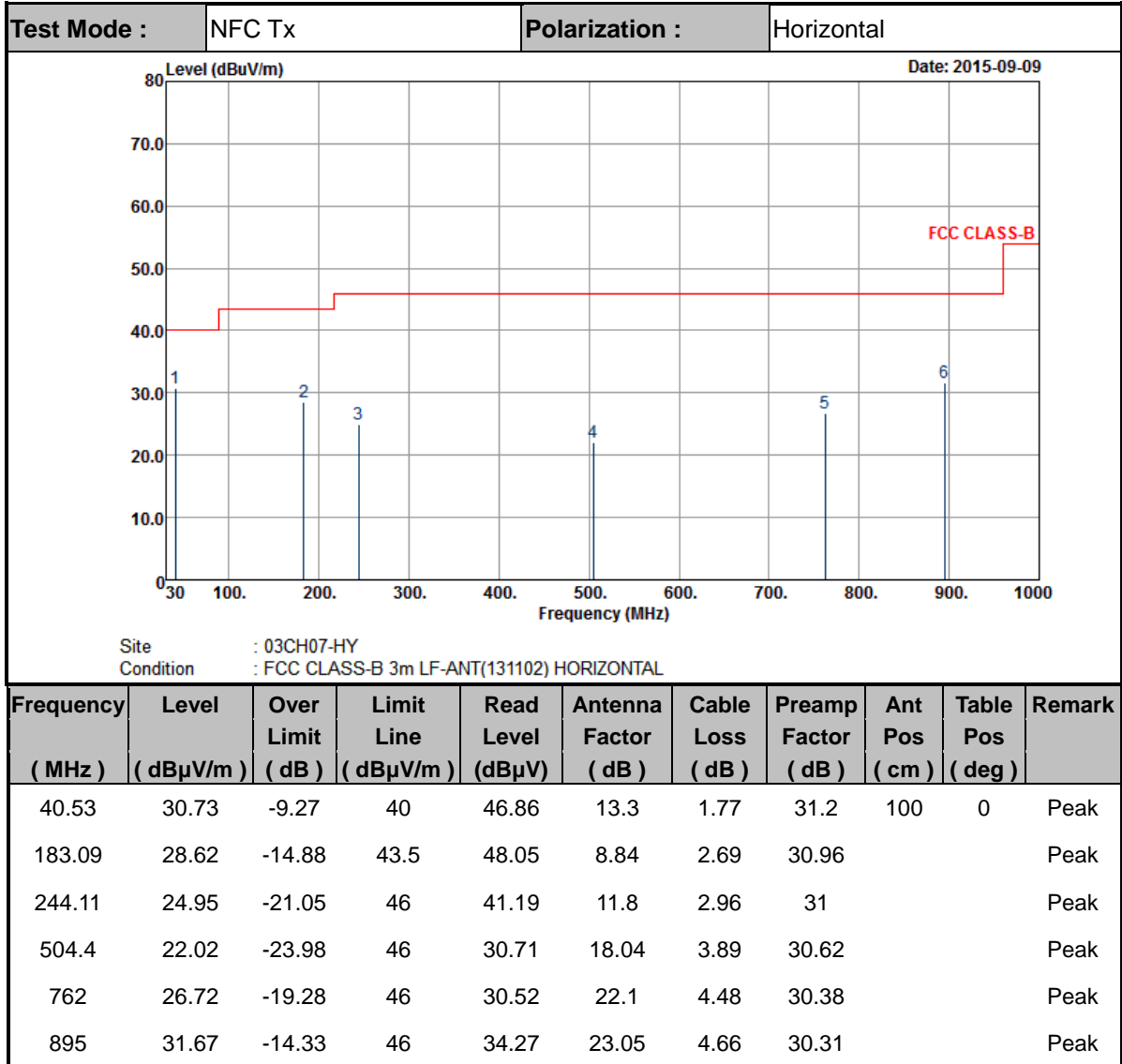

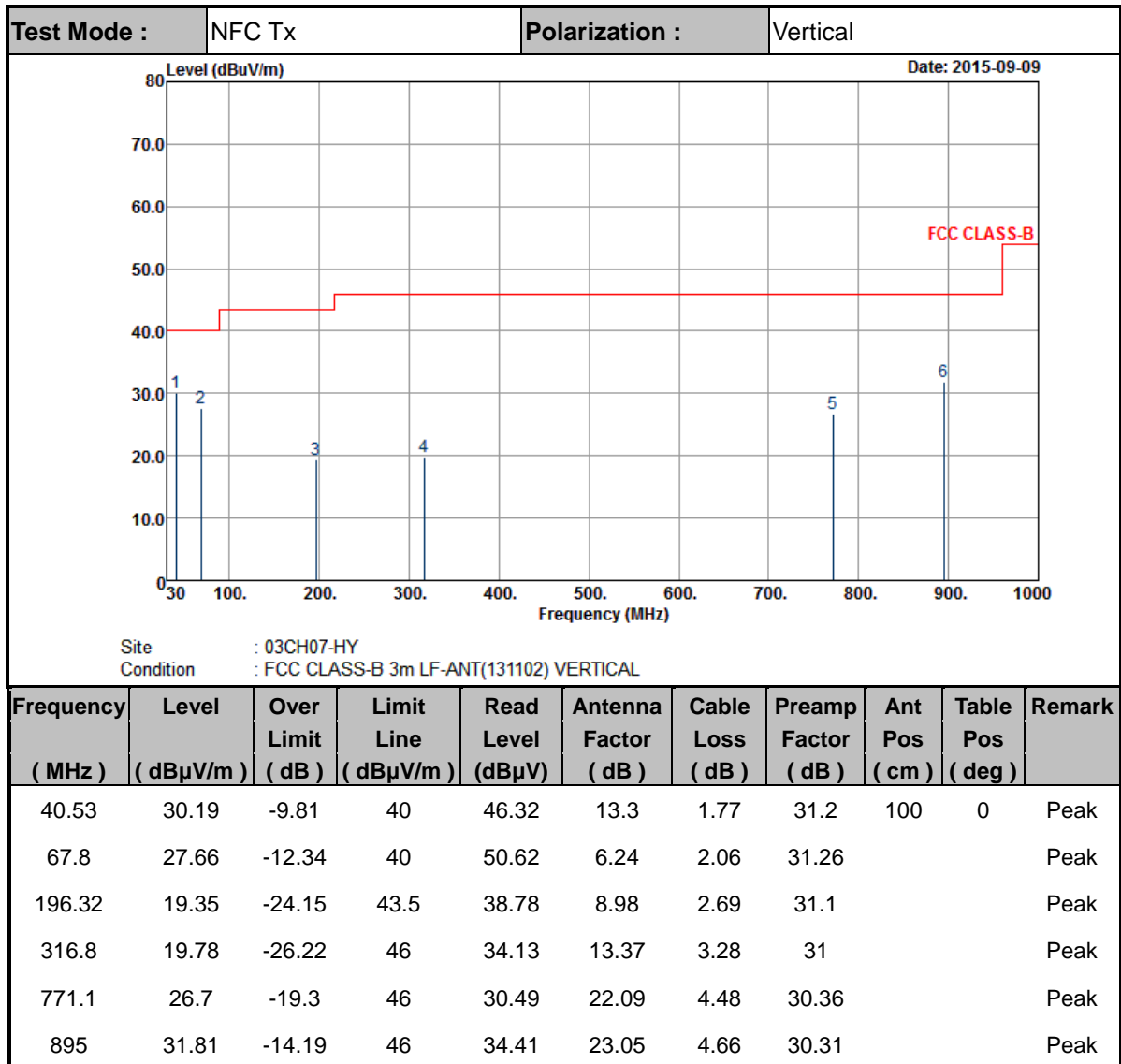

**Note:**

1. The amplitude of spurious emissions which are attenuated by more than 20dB below the permissible value has no need to be reported.
2. Emission level (dBμV/m) = 20 log Emission level (μV/m).
3. Corrected Reading: Antenna Factor + Cable Loss + Read Level - Preamp Factor= Level.