



# FCC RF Test Report

**APPLICANT** : Sony Mobile Communications Inc.  
**EQUIPMENT** : GSM/WCDMA/LTE Phone + Bluetooth, DTS/UNII  
a/b/g/n/ac, ANT+, and NFC  
**BRAND NAME** : Sony  
**FCC ID** : PY7-PM0913  
**STANDARD** : FCC Part 15 Subpart E §15.407  
**CLASSIFICATION** : (NII) Unlicensed National Information Infrastructure

The product was received on Jul. 16, 2015 and testing was completed on Sep. 09, 2015. We, SPORTON INTERNATIONAL INC., would like to declare that the tested sample has been evaluated in accordance with the test procedures and has been in compliance with the applicable technical standards.

The test results in this report apply exclusively to the tested model / sample. Without written approval of SPORTON INTERNATIONAL INC., the test report shall not be reproduced except in full.

Reviewed by: Joseph Lin / Supervisor

Approved by: Jones Tsai / Manager



## **SPORTON INTERNATIONAL INC.**

**No. 52, Hwa Ya 1<sup>st</sup> Rd., Hwa Ya Technology Park, Kwei-Shan District, Tao Yuan City, Taiwan, R.O.C.**

SPORTON INTERNATIONAL INC.

TEL : 886-3-327-3456

FAX : 886-3-328-4978

FCC ID : PY7-PM0913

Page Number : 1 of 46

Report Issued Date : Oct. 08, 2015

Report Version : Rev. 01

Report Template No.: BU5-FR15EWLAC MA Version 1.0



# TABLE OF CONTENTS

**REVISION HISTORY ..... 3**

**SUMMARY OF TEST RESULT ..... 4**

**1 GENERAL DESCRIPTION ..... 5**

    1.1 Applicant ..... 5

    1.2 Manufacturer ..... 5

    1.3 Feature of Equipment Under Test ..... 5

    1.4 Modification of EUT ..... 6

    1.5 Testing Location ..... 6

    1.6 Applicable Standards ..... 7

**2 TEST CONFIGURATION OF EQUIPMENT UNDER TEST ..... 8**

    2.1 Carrier Frequency and Channel ..... 9

    2.2 Pre-Scanned RF Power ..... 10

    2.3 Test Mode ..... 19

    2.4 Connection Diagram of Test System ..... 21

    2.5 Support Unit used in test configuration and system ..... 22

    2.6 EUT Operation Test Setup ..... 22

    2.7 Measurement Results Explanation Example ..... 22

**3 TEST RESULT ..... 23**

    3.1 26dB & 99% Occupied Bandwidth Measurement ..... 23

    3.2 Maximum Conducted Output Power Measurement ..... 25

    3.3 Power Spectral Density Measurement ..... 29

    3.4 Unwanted Emissions Measurement ..... 31

    3.5 AC Conducted Emission Measurement ..... 36

    3.6 Frequency Stability Measurement ..... 40

    3.7 Automatically Discontinue Transmission ..... 41

    3.8 Antenna Requirements ..... 42

**4 LIST OF MEASURING EQUIPMENT ..... 44**

**5 UNCERTAINTY OF EVALUATION ..... 46**

**APPENDIX A. CONDUCTED TEST RESULTS**

**APPENDIX B. RADIATED TEST RESULTS**

**APPENDIX C. RADIATED SPURIOUS EMISSION**





### SUMMARY OF TEST RESULT

Report Section	FCC Rule	Description	Limit	Result	Remark
3.1	2.1049 15.403(i)	26dB & 99% Bandwidth	-	Pass	-
3.2	15.407(a)	Maximum Conducted Output Power	≤ 24 dBm (depend on band)	Pass	-
3.3	15.407(a)	Power Spectral Density	≤ 11 dBm (depend on band)	Pass	-
3.4	15.407(b)	Unwanted Emissions	≤ -17, -27 dBm (depend on band)&15.209(a)	Pass	Under limit 6.38 dB at 5149.700 MHz
3.5	15.207	AC Conducted Emission	15.207(a)	Pass	Under limit 20.30 dB at 0.378 MHz
3.6	15.407(g)	Frequency Stability	Within Operation Band	Pass	-
3.7	15.407(c)	Automatically Discontinue Transmission	Discontinue Transmission	Pass	-
3.8	15.203 & 15.407(a)	Antenna Requirement	N/A	Pass	-

**Note:** The FCC ID: PY7-PM0910 and FCC ID: PY7-PM0913 is similar device, in this report all the test result are referred to PY7-PM0910, Sporton Report No: FR571620F.



# 1 General Description

## 1.1 Applicant

Sony Mobile Communications Inc.  
Nya Vattentorget, 22188 Lund, Sweden

## 1.2 Manufacturer

Sony Mobile Communications Inc.  
1-8-15 Konan, Minato-ku, Tokyo, 108-0075, Japan

## 1.3 Feature of Equipment Under Test

GSM/WCDMA/LTE, Bluetooth, DTS/UNII a/b/g/n/ac, ANT+, NFC and GPS

Product Specification subjective to this standard	
Antenna Type	Main Antenna : Monopole Antenna Aux. Antenna : Monopole Antenna
Antenna Gain	<b>&lt;5150 MHz ~ 5250 MHz&gt;</b> Main Antenna : -2.10 dBi Aux. Antenna : -6.20 dBi <b>&lt;5250 MHz ~ 5350 MHz&gt;</b> Main Antenna : -2.10 dBi Aux. Antenna : -6.20 dBi <b>&lt;5470 MHz ~ 5725 MHz&gt;</b> Main Antenna : -3.50 dBi Aux. Antenna : -6.10 dBi

EUT Information List				
IMEI	HW Version	SW Version	S/N	Performed Test Item
004402541723270	A	32.0.B.0.233	CB5A27R41W	RF conducted measurement
004402541720565			CB5A27R48A	Radiated Spurious Emission
004402541724070			CB5A27R49U	Conducted Emission



Accessory List	
AC Adapter	Model No. : UCH20
	Type No. : AC-0061-US
	S/N : 5815W22500089 (for radiated spurious emission) 5815W22500112 (for conducted emission)
Earphone	Model No. : MDR-NC750
	Type No. : AG-0020
USB Cable	Model No. : UCB11
	Type No. : AI-0120
	S/N : 1015W02400014C (for radiated spurious emission) 1522A7370000074 (for conducted emission)

**Note:**

1. Above EUT list and accessory list used are electrically identical per declared by manufacturer.
2. Above the accessories list are used to exercise the EUT during test.
3. For other wireless features of this EUT, test report will be issued separately.

### 1.4 Modification of EUT

No modifications are made to the EUT during all test items.

### 1.5 Testing Location

Sporton Lab is accredited to ISO 17025 by Taiwan Accreditation Foundation (TAF code : 1190) and the FCC designation No. TW1022 under the FCC 2.948(e) by Mutual Recognition Agreement (MRA) in FCC Test.

<b>Test Site</b>	SPORTON INTERNATIONAL INC.		
<b>Test Site Location</b>	No. 52, Hwa Ya 1 <sup>st</sup> Rd., Hwa Ya Technology Park, Kwei-Shan District, Tao Yuan City, Taiwan, R.O.C. TEL: +886-3-327-3456 FAX: +886-3-328-4978		
<b>Test Site No.</b>	<b>Sporton Site No.</b>		
	TH05-HY	CO05-HY	03CH07-HY

**Note:** The test site complies with ANSI C63.4 2009 requirement.



## 1.6 Applicable Standards

According to the specifications of the manufacturer, the EUT must comply with the requirements of the following standards:

- ♦ FCC Part 15 Subpart E
- ♦ FCC KDB 789033 D02 General UNII Test Procedures New Rules v01
- ♦ FCC KDB 662911 D01 Multiple Transmitter Output v02r01.
- ♦ FCC KDB 644545 D03 Guidance for IEEE 802 11ac New Rules v01
- ♦ ANSI C63.10-2009

**Remark:**

1. All test items were verified and recorded according to the standards and without any deviation during the test.
2. FCC permits the use of the 1.5 meter table as an alternative in C63.10-2013 through inquiry tracking number 961829.



## **2 Test Configuration of Equipment Under Test**

The EUT has been associated with peripherals and configuration operated in a manner tended to maximize its emission characteristics in a typical application. Frequency range investigated: conducted emission (150 kHz to 30 MHz) and radiated emission (9 kHz to the 10th harmonic of the highest fundamental frequency or to 40 GHz, whichever is lower). For radiated measurement, pre-scanned in three orthogonal panels, X, Y, Z. The worst cases (Y plane) were recorded in this report.

The final configuration from all the combinations and the worst-case data rates were investigated by measuring the maximum power across all the data rates and modulation modes under section 2.2.

Based on the worst configuration found above, the RF power setting is set individually to meet FCC compliance limit for the final conducted and radiated tests shown in section 2.3.





### 2.1 Carrier Frequency and Channel

Frequency Band	Channel	Freq. (MHz)	Channel	Freq. (MHz)
5150-5250 MHz Band 1 (U-NII-1)	36	5180	44	5220
	<b>38</b>	<b>5190</b>	<b>46</b>	<b>5230</b>
	40	5200	48	5240
	42	5210		

Frequency Band	Channel	Freq. (MHz)	Channel	Freq. (MHz)
5250-5350 MHz Band 2 (U-NII-2A)	52	5260	60	5300
	<b>54</b>	<b>5270</b>	<b>62</b>	<b>5310</b>
	56	5280	64	5320
	58	5290		

Frequency Band	Channel	Freq. (MHz)	Channel	Freq. (MHz)
5470-5725 MHz Band 3 (U-NII-2C)	100	5500	120	5600
	<b>102</b>	<b>5510</b>	122	5610
	104	5520	124	5620
	106	5530	126	5630
	108	5540	128	5640
	<b>110</b>	<b>5550</b>	132	5660
	112	5560	<b>134</b>	<b>5670</b>
	116	5580	136	5680
	118	5590	140	5700

Frequency Band	Channel	Freq. (MHz)	Channel	Freq. (MHz)
Straddle Channel	144	5720	<b>142</b>	<b>5710</b>
	138	5690		

Note: The above Frequency and Channel in boldface were 802.11n HT40.



## 2.2 Pre-Scanned RF Power

The data rates were set in

6 Mbps for 802.11a, MCS0 for 802.11n HT20, and MCS0 for 802.11n HT40 for Ant. 1 and Ant. 2;

MCS8 for 802.11n HT20 and MCS8 for 802.11n HT40 for MIMO <Ant. 1 + 2>;

MCS0 for 802.11n VHT20, MCS0 for 802.11n VHT40, and MCS0 for 802.11n VHT80, due to the customer declared.

### SISO <Ant. 1>

5GHz 802.11a mode			
Data Rate (MHz)	6M bps		
Channel	CH 36	CH 44	CH 48
Frequency	5180	5220	5240
Average Power (dBm)	9.14	8.68	8.79
Channel	CH 52	CH 60	CH 64
Frequency	5260	5300	5320
Average Power (dBm)	8.82	8.90	8.77
Channel	CH 100	CH 116	CH 140
Frequency	5500	5580	5700
Average Power (dBm)	8.89	8.93	8.44

5GHz 802.11n HT20 mode			
Data Rate (MHz)	MCS0		
Channel	CH 36	CH 44	CH 48
Frequency	5180	5220	5240
Average Power (dBm)	9.38	8.82	8.87
Channel	CH 52	CH 60	CH 64
Frequency	5260	5300	5320
Average Power (dBm)	8.83	9.08	9.04
Channel	CH 100	CH 116	CH 140
Frequency	5500	5580	5700
Average Power (dBm)	9.16	9.10	8.96



5GHz 802.11n HT40 mode			
Data Rate (MHz)	MCS0		
Channel	CH 38	CH 46	
Frequency	5190	5230	
Average Power (dBm)	9.03	8.53	
Channel	CH 54	CH 62	
Frequency	5270	5310	
Average Power (dBm)	9.04	8.78	
Channel	CH 102	CH 110	CH 134
Frequency	5510	5550	5670
Average Power (dBm)	8.66	9.00	9.41

5GHz 802.11ac VHT20 mode			
Data Rate (MHz)	MCS0		
Channel	CH 36	CH 44	CH 48
Frequency	5180	5220	5240
Average Power (dBm)	9.40	8.85	9.05
Channel	CH 52	CH 60	CH 64
Frequency	5260	5300	5320
Average Power (dBm)	8.93	9.14	9.03
Channel	CH 100	CH 116	CH 140
Frequency	5500	5580	5700
Average Power (dBm)	9.21	9.18	8.99



5GHz 802.11ac VHT40 mode			
Data Rate (MHz)	MCS0		
Channel	CH 38	CH 46	
Frequency	5190	5230	
Average Power (dBm)	9.24	8.64	
Channel	CH 54	CH 62	
Frequency	5270	5310	
Average Power (dBm)	8.82	8.34	
Channel	CH 102	CH 110	CH 134
Frequency	5510	5550	5670
Average Power (dBm)	8.80	9.09	9.16

5GHz 802.11ac VHT80 mode				
Data Rate (MHz)	MCS0			
Channel	CH 42	CH 58	CH 106	CH 122
Frequency	5210	5290	5530	5610
Average Power (dBm)	9.12	9.03	9.30	9.13



SISO <Ant. 2>

5GHz 802.11a mode			
Data Rate (MHz)	6M bps		
Channel	CH 36	CH 44	CH 48
Frequency	5180	5220	5240
Average Power (dBm)	9.89	9.88	9.88
Channel	CH 52	CH 60	CH 64
Frequency	5260	5300	5320
Average Power (dBm)	9.88	9.86	9.83
Channel	CH 100	CH 116	CH 140
Frequency	5500	5580	5700
Average Power (dBm)	9.44	8.89	8.81

5GHz 802.11n HT20 mode			
Data Rate (MHz)	MCS0		
Channel	CH 36	CH 44	CH 48
Frequency	5180	5220	5240
Average Power (dBm)	9.79	9.77	9.76
Channel	CH 52	CH 60	CH 64
Frequency	5260	5300	5320
Average Power (dBm)	9.58	9.70	9.76
Channel	CH 100	CH 116	CH 140
Frequency	5500	5580	5700
Average Power (dBm)	9.03	9.23	8.91



5GHz 802.11n HT40 mode			
Data Rate (MHz)	MCS0		
Channel	CH 38	CH 46	
Frequency	5190	5230	
Average Power (dBm)	9.74	9.89	
Channel	CH 54	CH 62	
Frequency	5270	5310	
Average Power (dBm)	9.72	9.72	
Channel	CH 102	CH 110	CH 134
Frequency	5510	5550	5670
Average Power (dBm)	9.16	9.29	9.01

5GHz 802.11ac VHT20 mode			
Data Rate (MHz)	MCS0		
Channel	CH 36	CH 44	CH 48
Frequency	5180	5220	5240
Average Power (dBm)	9.86	9.87	9.80
Channel	CH 52	CH 60	CH 64
Frequency	5260	5300	5320
Average Power (dBm)	9.85	9.54	9.64
Channel	CH 100	CH 116	CH 140
Frequency	5500	5580	5700
Average Power (dBm)	9.08	8.90	8.95



5GHz 802.11ac VHT40 mode			
Data Rate (MHz)	MCS0		
Channel	CH 38	CH 46	
Frequency	5190	5230	
Average Power (dBm)	9.87	9.78	
Channel	CH 54	CH 62	
Frequency	5270	5310	
Average Power (dBm)	9.70	9.76	
Channel	CH 102	CH 110	CH 134
Frequency	5510	5550	5670
Average Power (dBm)	9.34	9.13	9.01

5GHz 802.11ac VHT80 mode				
Data Rate (MHz)	MCS0			
Channel	CH 42	CH 58	CH 106	CH 122
Frequency	5210	5290	5530	5610
Average Power (dBm)	9.94	9.87	9.59	9.45



MIMO <Ant. 1 + 2>

5GHz 802.11a mode			
Data Rate (MHz)	6M bps		
Channel	CH 36	CH 44	CH 48
Frequency	5180	5220	5240
Average Power (dBm)	12.55	12.36	12.42
Channel	CH 52	CH 60	CH 64
Frequency	5260	5300	5320
Average Power (dBm)	12.45	12.47	12.41
Channel	CH 100	CH 116	CH 140
Frequency	5500	5580	5700
Average Power (dBm)	12.20	11.98	11.71

5GHz 802.11n HT20 mode			
Data Rate (MHz)	MCS8		
Channel	CH 36	CH 44	CH 48
Frequency	5180	5220	5240
Average Power (dBm)	12.72	12.41	12.49
Channel	CH 52	CH 60	CH 64
Frequency	5260	5300	5320
Average Power (dBm)	12.26	12.45	12.52
Channel	CH 100	CH 116	CH 140
Frequency	5500	5580	5700
Average Power (dBm)	12.18	12.28	11.99





5GHz 802.11n HT40 mode			
Data Rate (MHz)	MCS8		
Channel	CH 38	CH 46	
Frequency	5190	5230	
Average Power (dBm)	12.70	12.32	
Channel	CH 54	CH 62	
Frequency	5270	5310	
Average Power (dBm)	12.41	12.44	
Channel	CH 102	CH 110	CH 134
Frequency	5510	5550	5670
Average Power (dBm)	12.01	12.17	12.25

5GHz 802.11ac VHT20 mode			
Data Rate (MHz)	MCS0		
Channel	CH 36	CH 44	CH 48
Frequency	5180	5220	5240
Average Power (dBm)	12.68	12.48	12.47
Channel	CH 52	CH 60	CH 64
Frequency	5260	5300	5320
Average Power (dBm)	12.48	12.43	12.42
Channel	CH 100	CH 116	CH 140
Frequency	5500	5580	5700
Average Power (dBm)	12.16	12.12	12.04



5GHz 802.11ac VHT40 mode			
Data Rate (MHz)	MCS0		
Channel	CH 38	CH 46	
Frequency	5190	5230	
Average Power (dBm)	12.63	12.29	
Channel	CH 54	CH 62	
Frequency	5270	5310	
Average Power (dBm)	12.38	12.22	
Channel	CH 102	CH 110	CH 134
Frequency	5510	5550	5670
Average Power (dBm)	12.06	12.14	12.11

5GHz 802.11ac VHT80 mode				
Data Rate (MHz)	MCS0			
Channel	CH 42	CH 58	CH 106	CH 122
Frequency	5210	5290	5530	5610
Average Power (dBm)	12.58	12.51	12.47	12.39

Note: MIMO Ant. 1+2 is a calculated result from sum of the power MIMO Ant. 1 and MIMO Ant. 2.



### 2.3 Test Mode

Final test mode of conducted test items and radiated spurious emissions are considering the modulation and worse data rates from the power table described in section 2.2.

The radiated spurious emissions testing were performed in n-mode only for HT20/40, which covers ac-mode testing.

#### Single Antenna

Modulation	Data Rate
802.11a	6 Mbps
802.11n HT20	MCS0
802.11n HT40	MCS0
802.11ac VHT20	MCS0
802.11ac VHT40	MCS0
802.11ac VHT80	MCS0

#### MIMO Antenna

Modulation	Data Rate
802.11a	6 Mbps
802.11n HT20	MCS8
802.11n HT40	MCS8
802.11ac VHT20	MCS0
802.11ac VHT40	MCS0
802.11ac VHT80	MCS0

Test Cases	
AC Conducted Emission	Mode 1 : WLAN (5GHz) Link + Earphone + USB Cable (Charging from Adapter)



Ch. #		Band I : 5150-5250 MHz	Band II : 5250-5350 MHz	Band III : 5470-5725MHz
		802.11a	802.11a	802.11a
L	Low	36	52	100
M	Middle	44	60	116
H	High	48	64	140
Straddle Band		-	-	144

Ch. #		Band I : 5150-5250 MHz	Band II : 5250-5350 MHz	Band III : 5470-5725MHz
		802.11n HT20	802.11n HT20	802.11n HT20
L	Low	36	52	100
M	Middle	44	60	116
H	High	48	64	140
Straddle Band		-	-	144

Ch. #		Band I : 5150-5250 MHz	Band II : 5250-5350 MHz	Band III : 5470-5725MHz
		802.11n HT40	802.11n HT40	802.11n HT40
L	Low	38	54	102
M	Middle	-	-	110
H	High	46	62	134
Straddle Band		-	-	142

Ch. #		Band I : 5150-5250 MHz	Band II : 5250-5350 MHz	Band III : 5470-5725MHz
		802.11ac VHT20	802.11ac VHT20	802.11ac VHT20
L	Low	36	52	100
M	Middle	44	60	116
H	High	48	64	140

Ch. #		Band I : 5150-5250 MHz	Band II : 5250-5350 MHz	Band III : 5470-5725MHz
		802.11ac VHT40	802.11ac VHT40	802.11ac VHT40
L	Low	38	54	102
M	Middle	-	-	110
H	High	46	62	134

Ch. #		Band I : 5150-5250 MHz	Band II : 5250-5350 MHz	Band III : 5470-5725MHz
		802.11ac VHT80	802.11ac VHT80	802.11ac VHT80
L	Low	-	-	-
M	Middle	42	58	106
H	High	-	-	-
Straddle Band		-	-	138

## 2.4 Connection Diagram of Test System

### <WLAN Tx Mode>

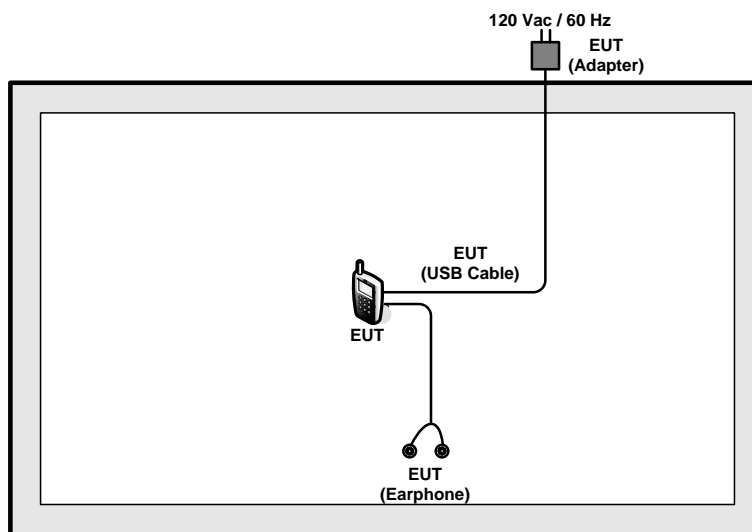

### <AC Conducted Emission Mode>

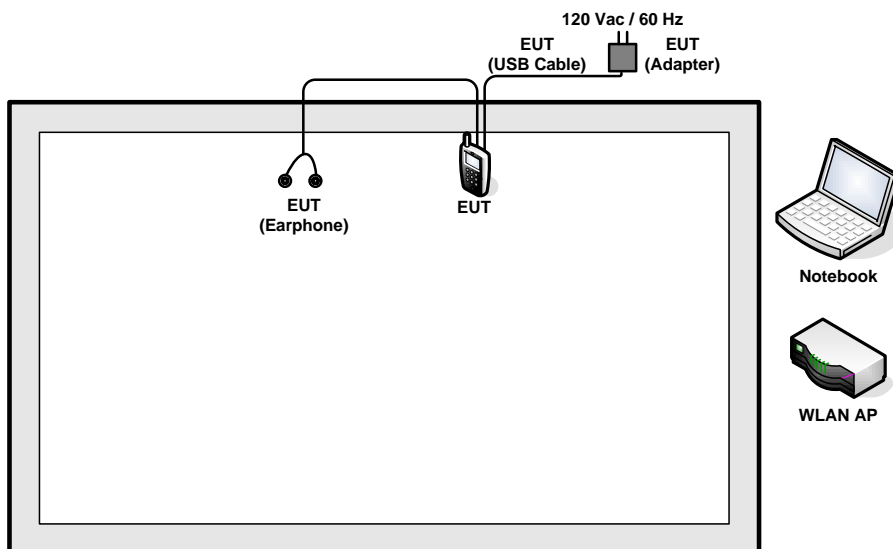



## 2.5 Support Unit used in test configuration and system

Item	Equipment	Trade Name	Model Name	FCC ID	Data Cable	Power Cord
1.	WLAN AP	IO-Data	WN-AC733GR	N/A	N/A	Unshielded, 1.8 m
2.	Notebook	DELL	Latitude E6320	FCC DoC/ Contains FCC ID: QDS-BRCM1054	N/A	AC I/P: Unshielded, 1.2 m DC O/P: Shielded, 1.8 m
3.	SD Card	SanDisk	MicroSD HC	FCC DoC	N/A	N/A

## 2.6 EUT Operation Test Setup

For WLAN RF test items, an engineering test program was provided and enabled to make EUT continuous transmit/receive.

## 2.7 Measurement Results Explanation Example

For all conducted test items:

The offset level is set in the spectrum analyzer to compensate the RF cable loss and attenuator factor between EUT conducted output port and spectrum analyzer. With the offset compensation, the spectrum analyzer reading level is exactly the EUT RF output level.

Example :

The spectrum analyzer offset is derived from RF cable loss and attenuator factor.

*Offset = RF cable loss + attenuator factor.*

Following shows an offset computation example with cable loss 4.2 dB and 10dB attenuator.

*Offset(dB) = RF cable loss(dB) + attenuator factor(dB).*

$$= 4.2 + 10 = 14.2 \text{ (dB)}$$

### 3 Test Result

#### 3.1 26dB & 99% Occupied Bandwidth Measurement

##### 3.1.1 Description of 26dB & 99% Occupied Bandwidth

This section is for reporting purpose only.

There is no restriction limits for bandwidth.

For Straddle Channel, U-NII procedures were applied for operations in the frequency band in accordance with FCC KDB 644545 D03.

##### 3.1.2 Measuring Instruments

The measuring equipment is listed in the section 4 of this test report.

##### 3.1.3 Test Procedures

1. The testing follows FCC KDB 789033 D02 General UNII Test Procedures New Rules v01. Section C) Emission bandwidth
2. Set RBW = approximately 1% of the emission bandwidth.
3. Set the VBW > RBW.
4. Detector = Peak.
5. Trace mode = max hold
6. Measure the maximum width of the emission that is 26 dB down from the peak of the emission. Compare this with the RBW setting of the analyzer. Readjust RBW and repeat measurement as needed until the RBW/EBW ratio is approximately 1%.
7. For 99% Bandwidth Measurement, the spectrum analyzer's resolution bandwidth (RBW) is set 1MHz and set the Video bandwidth (VBW)  $\geq 3 * RBW$ .
8. Measure and record the results in the test report.

##### 3.1.4 Test Setup

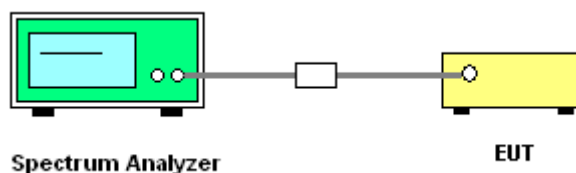



### 3.1.5 Test Result of 26dB & 99% Occupied Bandwidth

Please refer to Appendix A.

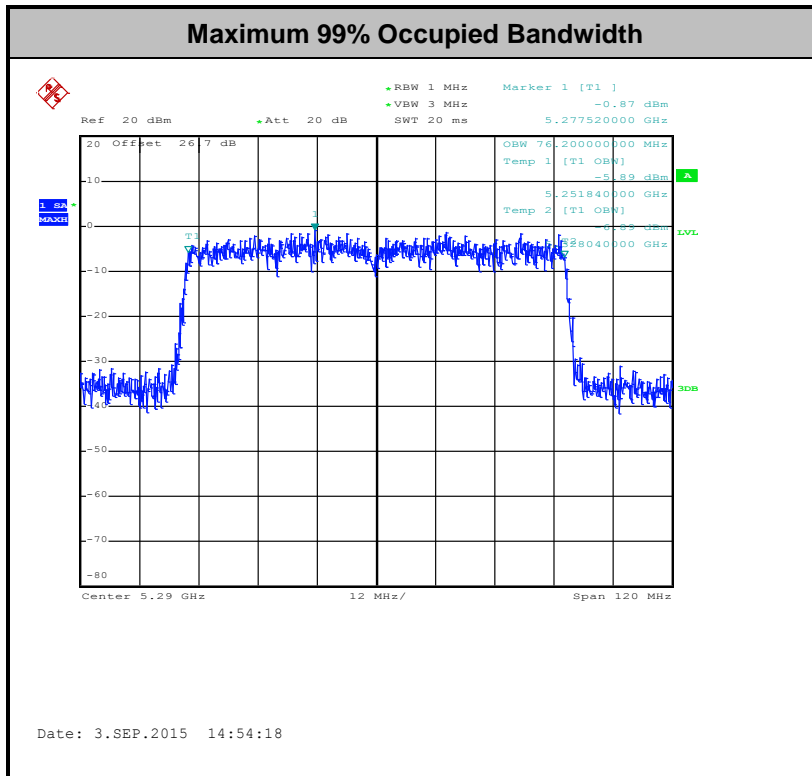
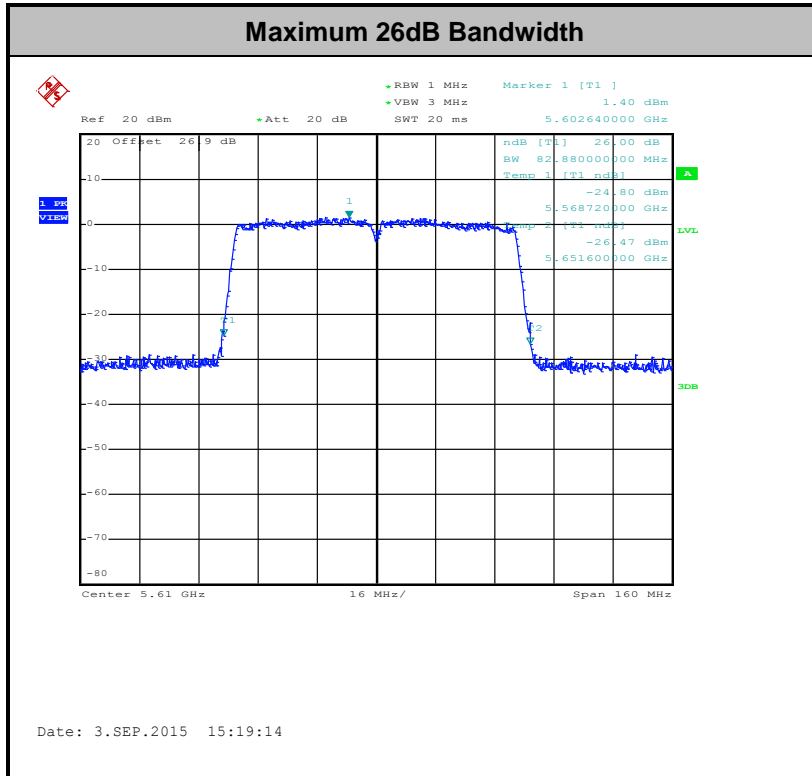

**Note:** The occupied channel bandwidth is maintained within the band of operation for all of the modulations.





## **3.2 Maximum Conducted Output Power Measurement**

### **3.2.1 Limit of Maximum Conducted Output Power**

For mobile and portable client devices in the 5.15–5.25 GHz band, the maximum conducted output power over the frequency band of operation shall not exceed 250 mW.

For the 5.25–5.35 GHz and 5.47–5.725 GHz bands, the maximum conducted output power over the frequency bands of operation shall not exceed the lesser of 250 mW or 11 dBm 10 log B, where B is the 26 dB emission bandwidth in megahertz.

For Straddle Channel, U-NII procedures and limits were applied for operations in the frequency band in accordance with FCC KDB 644545 D03.

If transmitting antennas of directional gain greater than 6 dBi are used, the peak output power shall be reduced by the amount in dB that the directional gain of the antenna exceeds 6 dBi.

Note that U-NII-2 band, devices with a maximum e.i.r.p. greater than 500 mW shall implement TPC in order to have the capability to operate at least 6 dB below the maximum permitted e.i.r.p. of 1 W.

### **3.2.2 Measuring Instruments**

The measuring equipment is listed in the section 4 of this test report.

### **3.2.3 Test Procedures**

The testing follows Method PM of FCC KDB 789033 D02 General UNII Test Procedures New Rules v01.

Method PM (Measurement using an RF average power meter):

1. Measurement is performed using a wideband RF power meter.
2. The EUT is configured to transmit continuously with a consistent duty cycle at its maximum power control level.
3. Measure the average power of the transmitter, and the average power is corrected with duty factor,  $10 \log(1/x)$ , where x is the duty cycle.

For straddle channel, the testing follows Method SA-3 (RMS detection with max hold) of FCC KDB 789033 D02 General UNII Test Procedures New Rules v01.

Compute power by integrating the spectrum across the 99% occupied bandwidth of the signal using the instrument's band power measurement function.

### 3.2.4 Test Setup

For normal channel:

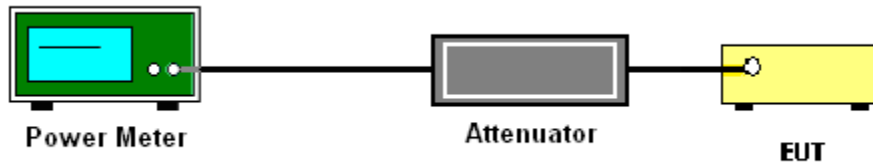

For straddle channel:

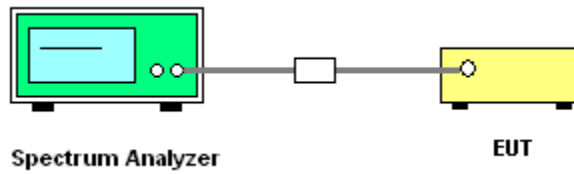

### 3.2.5 Test Result of Maximum Conducted Output Power

Please refer to Appendix A.

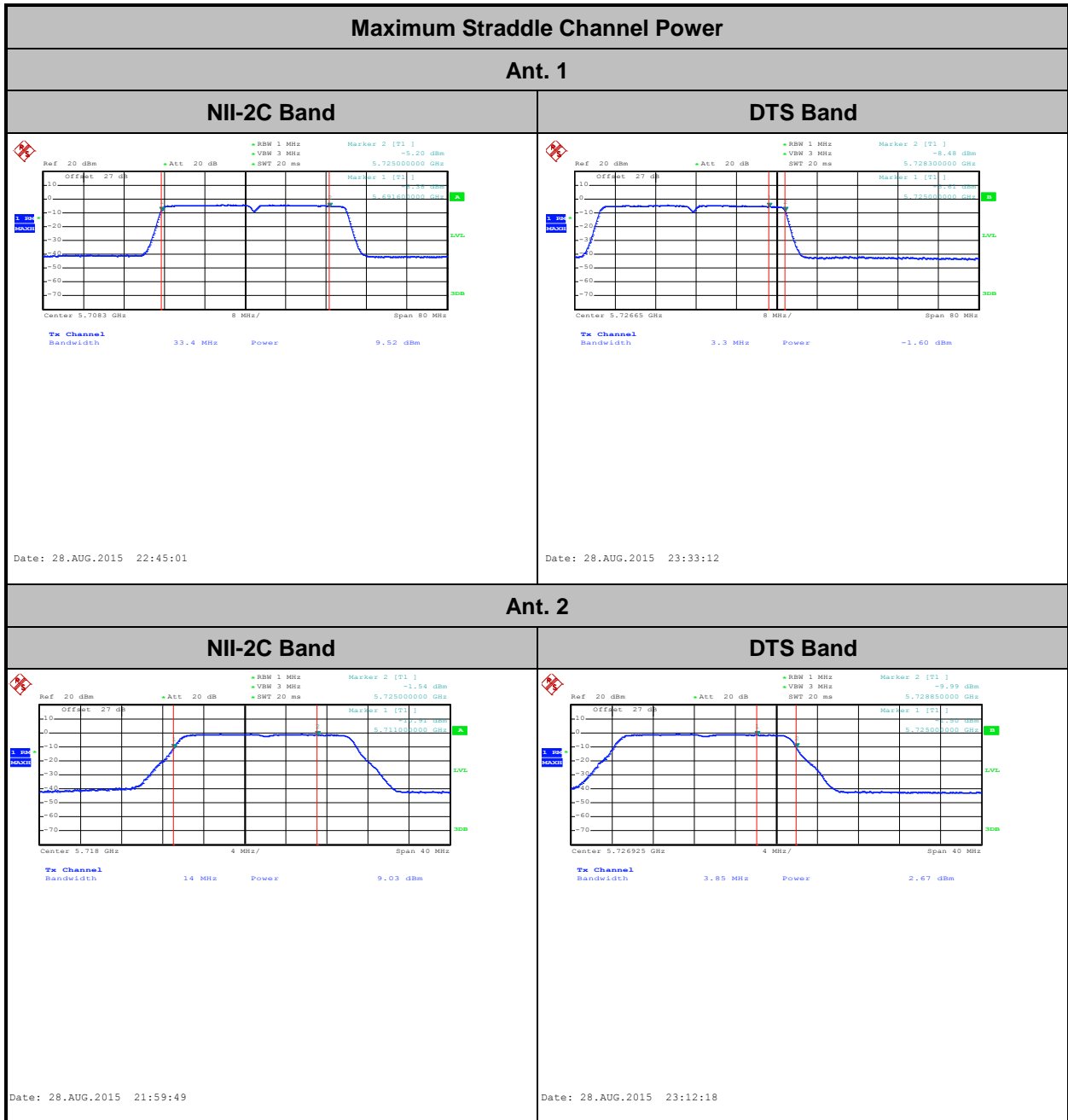

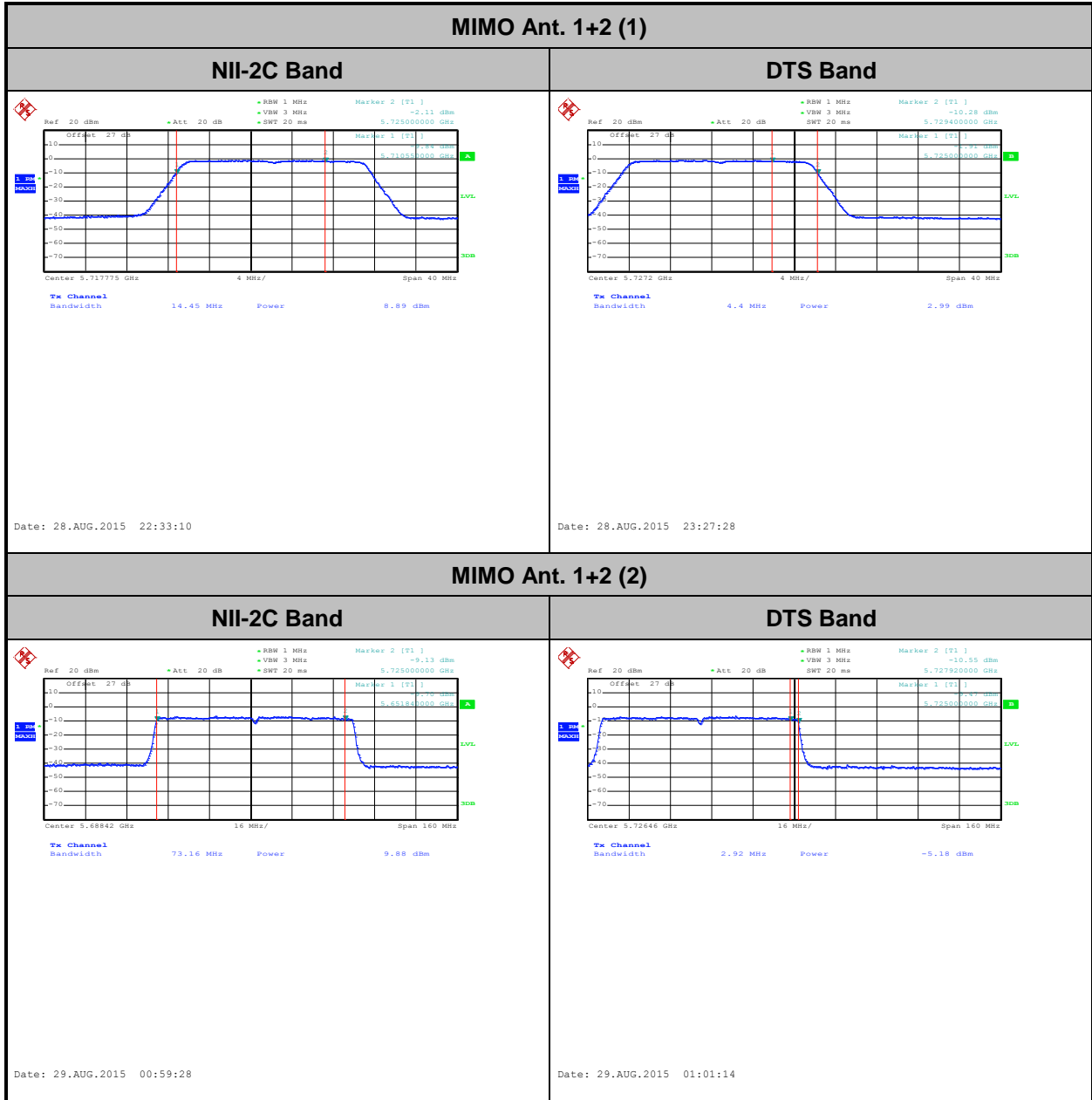



### 3.3 Power Spectral Density Measurement

#### 3.3.1 Limit of Power Spectral Density

For mobile and portable client devices in the 5.15–5.25 GHz band, the maximum power spectral density shall not exceed 11dBm in any 1 megahertz band.

For the 5.25–5.35 GHz and 5.47–5.725 GHz bands, the maximum power spectral density shall not exceed 11 dBm in any 1 megahertz band.

For Straddle Channel, U-NII procedures and limits were applied for operations in the frequency band in accordance with FCC KDB 644545 D03.

If transmitting antennas of directional gain greater than 6 dBi are used, the peak output power shall be reduced by the amount in dB that the directional gain of the antenna exceeds 6 dBi.

#### 3.3.2 Measuring Instruments

The measuring equipment is listed in the section 4 of this test report.

#### 3.3.3 Test Procedures

The testing follows FCC KDB 789033 D02 General UNII Test Procedures New Rules v01. Section F) Maximum power spectral density.

##### # Method SA-2 #

(trace averaging across on and off times of the EUT transmissions, followed by duty cycle correction).

1. The testing follows Method SA-2 of FCC KDB 789033 D02 General UNII Test Procedures New Rules v01.
  - Measure the duty cycle.
  - Set span to encompass the entire emission bandwidth (EBW) of the signal.
  - Set RBW = 1 MHz.
  - Set VBW  $\geq$  3 MHz.
  - Number of points in sweep  $\geq$  2 Span / RBW.
  - Sweep time = auto.
  - Detector = RMS
  - Trace average at least 100 traces in power averaging mode.
  - Add  $10 \log(1/x)$ , where x is the duty cycle, to the measured power in order to compute the average power during the actual transmission times. For example, add  $10 \log(1/0.25) = 6$  dB if the duty cycle is 25 percent.





### 3.4 Unwanted Emissions Measurement

This section as specified in FCC Part 15.407(b) is to measure unwanted emissions through radiated measurement for band edge spurious emissions and out of band emissions measurement. The unwanted emissions shall comply with 15.407(b)(1) to (6), and restricted bands per FCC Part15.205.

#### 3.4.1 Limit of Unwanted Emissions

(1) For transmitters operating in the 5150-5250 MHz band: all emissions outside of the 5150-5350 MHz band shall not exceed an EIRP of -27dBm/MHz.

For transmitters operating in the 5250-5350 MHz band: all emissions outside of the 5150-5350 MHz band shall not exceed an EIRP of -27 dBm/MHz. Devices operating in the 5250-5350 MHz band that generate emissions in the 5150-5250 MHz band must meet all applicable technical requirements for operation in the 5150-5250 MHz band (including indoor use) or alternatively meet an out-of-band emission EIRP limit of -27 dBm/MHz in the 5150-5250 MHz band.

For transmitters operating in the 5470-5600 MHz and 5650-5725MHz band: all emissions outside of the 5470-5600 MHz and 5650-5725MHz band shall not exceed an EIRP of -27 dBm/MHz.

(2) Unwanted spurious emissions fallen in restricted bands per FCC Part15.205 shall comply with the general field strength limits set forth in § 15.209 as below table,

Frequency (MHz)	Field Strength (microvolts/meter)	Measurement Distance (meters)
0.009 – 0.490	2400/F(kHz)	300
0.490 – 1.705	24000/F(kHz)	30
1.705 – 30.0	30	30
30 – 88	100	3
88 – 216	150	3
216 - 960	200	3
Above 960	500	3

**Note:** The following formula is used to convert the EIRP to field strength.



$$E = \frac{1000000\sqrt{30P}}{3} \mu\text{V/m, where P is the eirp (Watts)}$$

EIRP (dBm)	Field Strength at 3m (dBμV/m)
-17	78.3
-27	68.3

(3) KDB789033 v01 G)2)c) As specified in 15.407(b), emissions above 1000 MHz that are outside of the restricted bands are subject to a peak emission limit of -27 dBm/MHz (or -17 dBm/MHz as specified in 15.407(b)(4)). However, an out-of-band emission that complies with both the average and peak limits of 15.209 is not required to satisfy the -27 dBm/MHz or -17 dBm/MHz peak emission limit.

### 3.4.2 Measuring Instruments

The measuring equipment is listed in the section 4 of this test report.

### 3.4.3 Test Procedures

1. The testing follows FCC KDB 789033 D02 General UNII Test Procedures New Rules v01. Section G) Unwanted emissions measurement.

(1) Procedure for Unwanted Emissions Measurements Below 1000MHz

- RBW = 120 kHz
- VBW = 300 kHz
- Detector = Peak
- Trace mode = max hold

(2) Procedure for Peak Unwanted Emissions Measurements Above 1000 MHz

- RBW = 1 MHz
- VBW ≥ 3 MHz
- Detector = Peak
- Sweep time = auto
- Trace mode = max hold





(3) Procedures for Average Unwanted Emissions Measurements Above 1000MHz

- RBW = 1 MHz
- VBW = 10 Hz, when duty cycle is no less than 98 percent.
- $VBW \geq 1/T$ , when duty cycle is less than 98 percent where T is the minimum transmission duration over which the transmitter is on and is transmitting at its maximum power control level for the tested mode of operation.

Antenna	Band	Duty Cycle(%)	T(us)	1/T(kHz)	VBW Setting
1+2	802.11a for Ant 1	98.73	-	-	10Hz
1+2	802.11a for Ant 2	98.73	-	-	
1+2	802.11n HT20 for Ant 1	98.01	-	-	
1+2	802.11n HT20 for Ant 2	98.01	-	-	
1+2	802.11n HT40 for Ant 1	96.80	726.00	1.38	2kHz
1+2	802.11n HT40 for Ant 2	96.80	726.00	1.38	
1+2	802.11ac VHT80 for Ant 1	93.75	360.00	2.78	3kHz
1+2	802.11ac VHT80 for Ant 2	93.75	360.00	2.78	

- The EUT was placed on a turntable with 0.8 meter for frequency below 1GHz and 1.5 meter for frequency above 1GHz respectively above ground.
- The EUT was set 3 meters from the interference receiving antenna which was mounted on the top of a variable height antenna tower.
- The antenna is a broadband antenna and its height is adjusted between one meter and four meters above ground to find the maximum value of the field strength for both horizontal polarization and vertical polarization of the antenna.
- For each suspected emission, the EUT was arranged to its worst case and then adjust the antenna tower (from 1 m to 4 m) and turntable (from 0 degree to 360 degrees) to find the maximum reading.
- For testing below 1GHz, if the emission level of the EUT in peak mode was 3 dB lower than the limit specified, then peak values of EUT will be reported, otherwise, the emissions will be repeated one by one using the CISPR quasi-peak method and reported.
- For testing above 1GHz, the emission level of the EUT in peak mode was 20dB lower than average limit (that means the emission level in average mode also complies with the limit in average mode), then peak values of EUT will be reported, otherwise, the emissions will be measured in average mode again and reported.

### 3.4.4 Test Setup

For radiated emissions below 30MHz

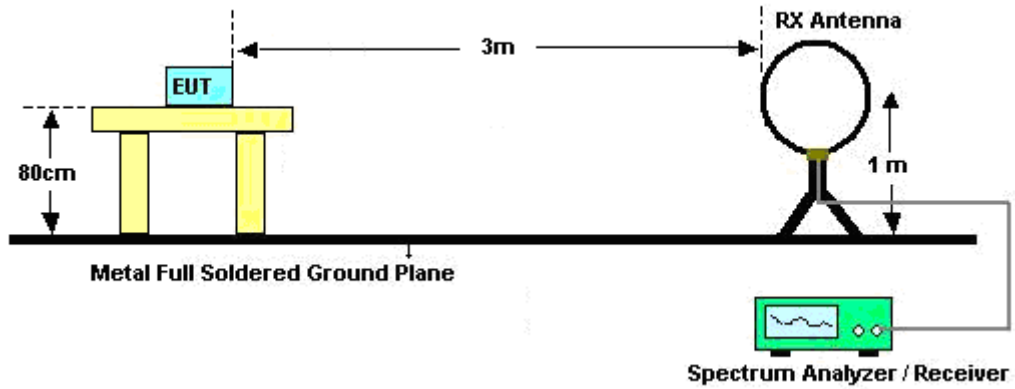

For radiated emissions from 30MHz to 1GHz

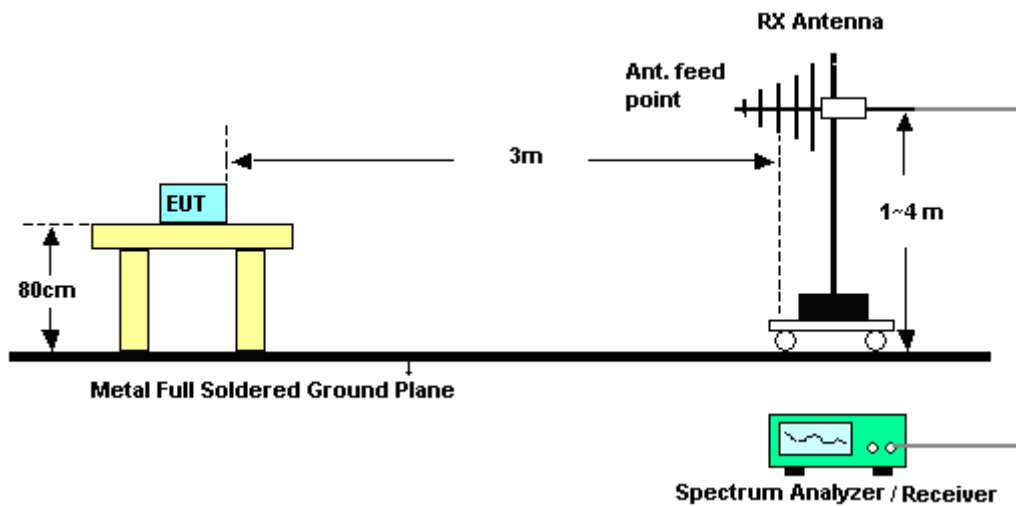

For radiated emissions above 1GHz

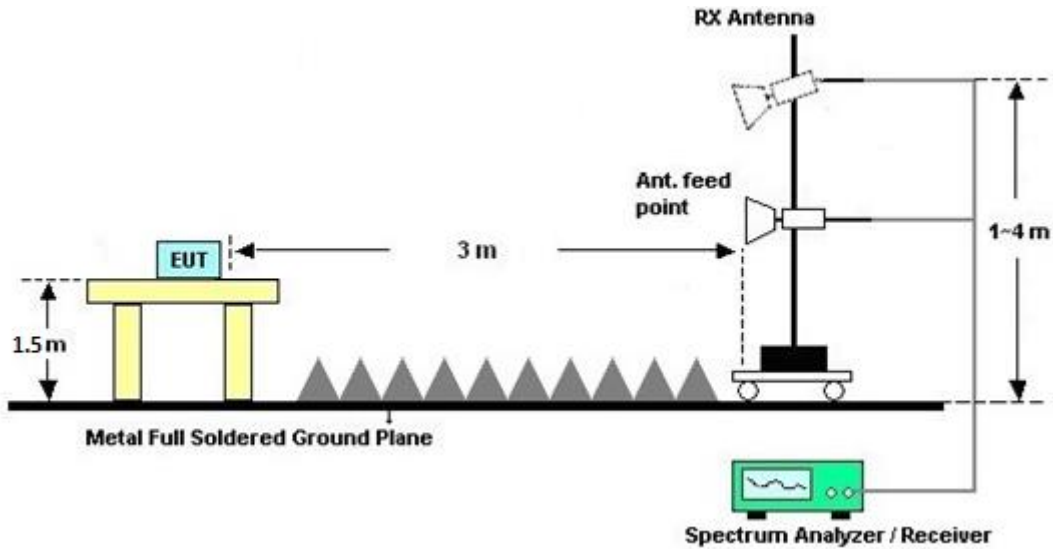

### 3.4.5 Test Results of Radiated Emissions (9 kHz ~ 30 MHz)

The low frequency, which started from 9 kHz to 30MHz, was pre-scanned and the result which was 20dB lower than the limit line per 15.31(o) was not reported.

### 3.4.6 Test Result of Radiated Band Edges

Please refer to Appendix B and Appendix C.

### 3.4.7 Test Result of Unwanted Radiated Emission (30MHz ~ 10th Harmonic)

Please refer to Appendix B and Appendix C.



### 3.5 AC Conducted Emission Measurement

#### 3.5.1 Limit of AC Conducted Emission

For equipment that is designed to be connected to the public utility (AC) power line, the radio frequency voltage that is conducted back onto the AC power line on any frequency or frequencies within the band 150 kHz to 30 MHz shall not exceed the limits in the following table.

Frequency of emission (MHz)	Conducted limit (dB $\mu$ V)	
	Quasi-peak	Average
0.15-0.5	66 to 56*	56 to 46*
0.5-5	56	46
5-30	60	50

\*Decreases with the logarithm of the frequency.

#### 3.5.2 Measuring Instruments

The measuring equipment is listed in the section 4 of this test report.

#### 3.5.3 Test Procedures

1. The EUT was placed 0.4 meter from the conducting wall of the shielding room was kept at least 80 centimeters from any other grounded conducting surface.
2. Connect EUT to the power mains through a line impedance stabilization network (LISN).
3. All the support units are connecting to the other LISN.
4. The LISN provides 50 ohm coupling impedance for the measuring instrument.
5. The FCC states that a 50 ohm, 50 microhenry LISN should be used.
6. Both sides of AC line were checked for maximum conducted interference.
7. The frequency range from 150 kHz to 30 MHz was searched.
8. Set the test-receiver system to Peak Detect Function and specified bandwidth with Maximum Hold Mode.

### 3.5.4 Test Setup

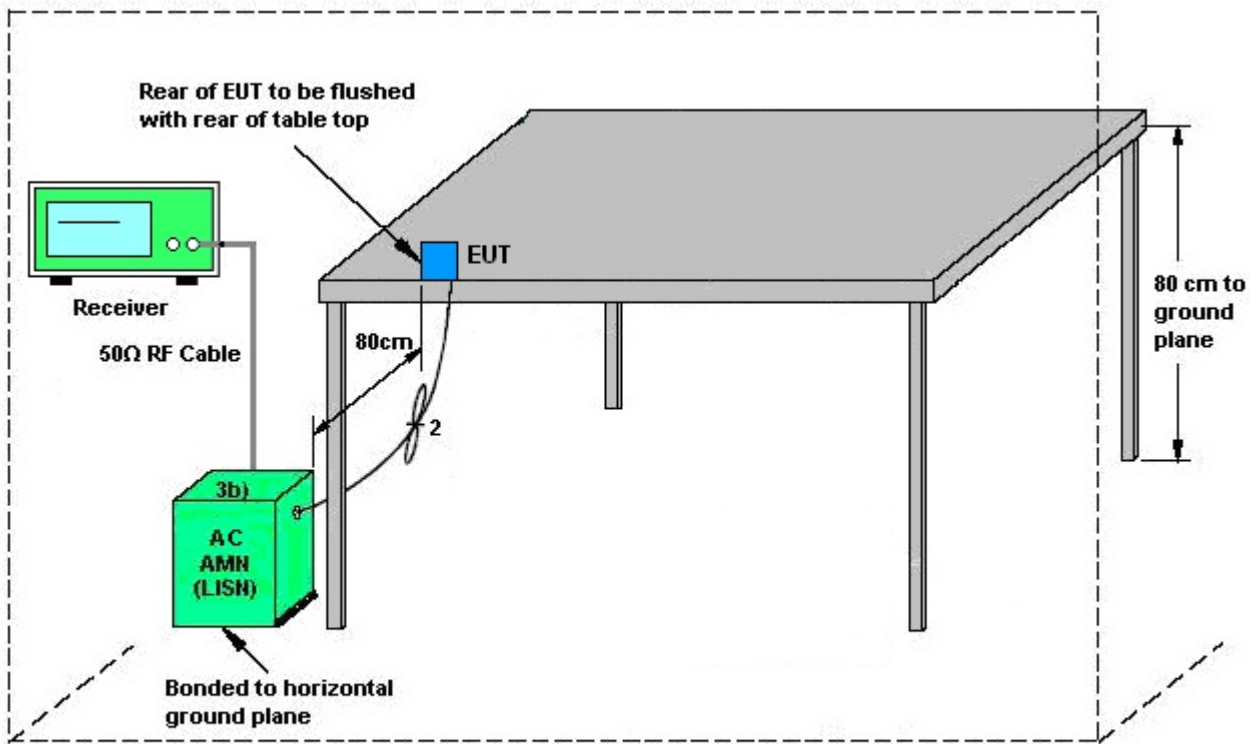

AMN = Artificial mains network (LISN)  
AE = Associated equipment  
EUT = Equipment under test  
ISN = Impedance stabilization network



### 3.5.5 Test Result of AC Conducted Emission

Test Mode :	Mode 1	Temperature :	23~25°C
Test Engineer :	Derreck Chen	Relative Humidity :	58~61%
Test Voltage :	120Vac / 60Hz	Phase :	Line
Function Type :	WLAN (5GHz) Link + Earphone + USB Cable (Charging from Adapter)		

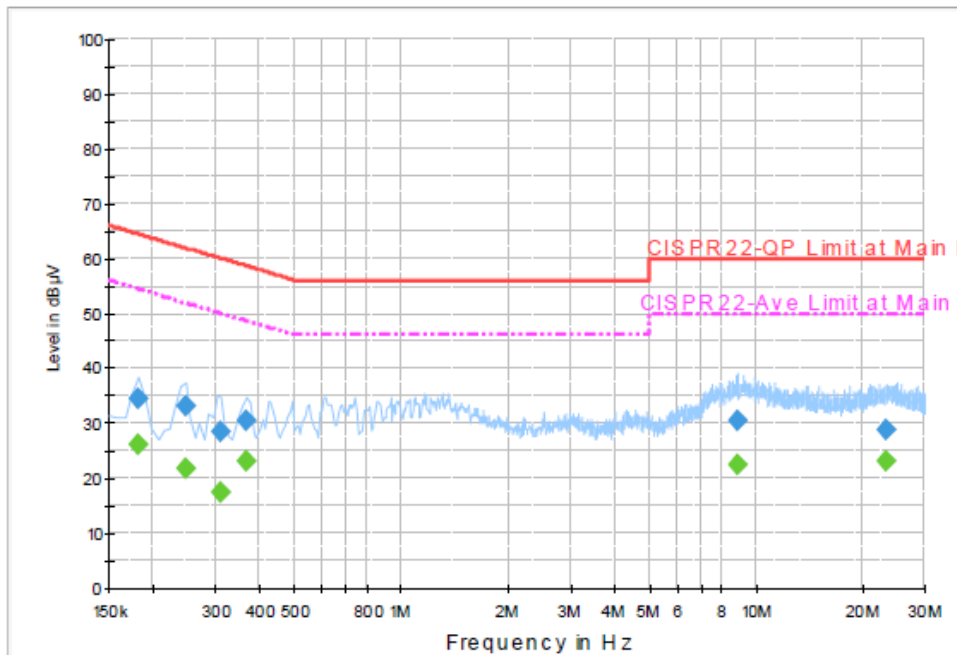

**Final Result : QuasiPeak**

Frequency (MHz)	QuasiPeak (dBµV)	Filter	Line	Corr. (dB)	Margin (dB)	Limit (dBµV)
0.182000	34.6	Off	L1	19.5	29.8	64.4
0.246000	33.2	Off	L1	19.5	28.7	61.9
0.310000	28.3	Off	L1	19.5	31.7	60.0
0.366000	30.5	Off	L1	19.5	28.1	58.6
8.918000	30.5	Off	L1	19.9	29.5	60.0
23.294000	28.8	Off	L1	20.0	31.2	60.0

**Final Result : Average**

Frequency (MHz)	Average (dBµV)	Filter	Line	Corr. (dB)	Margin (dB)	Limit (dBµV)
0.182000	26.0	Off	L1	19.5	28.4	54.4
0.246000	21.8	Off	L1	19.5	30.1	51.9
0.310000	17.5	Off	L1	19.5	32.5	50.0
0.366000	23.1	Off	L1	19.5	25.5	48.6
8.918000	22.5	Off	L1	19.9	27.5	50.0
23.294000	23.1	Off	L1	20.0	26.9	50.0



Test Mode :	Mode 1	Temperature :	23~25°C
Test Engineer :	Derreck Chen	Relative Humidity :	58~61%
Test Voltage :	120Vac / 60Hz	Phase :	Neutral
Function Type :	WLAN (5GHz) Link + Earphone + USB Cable (Charging from Adapter)		

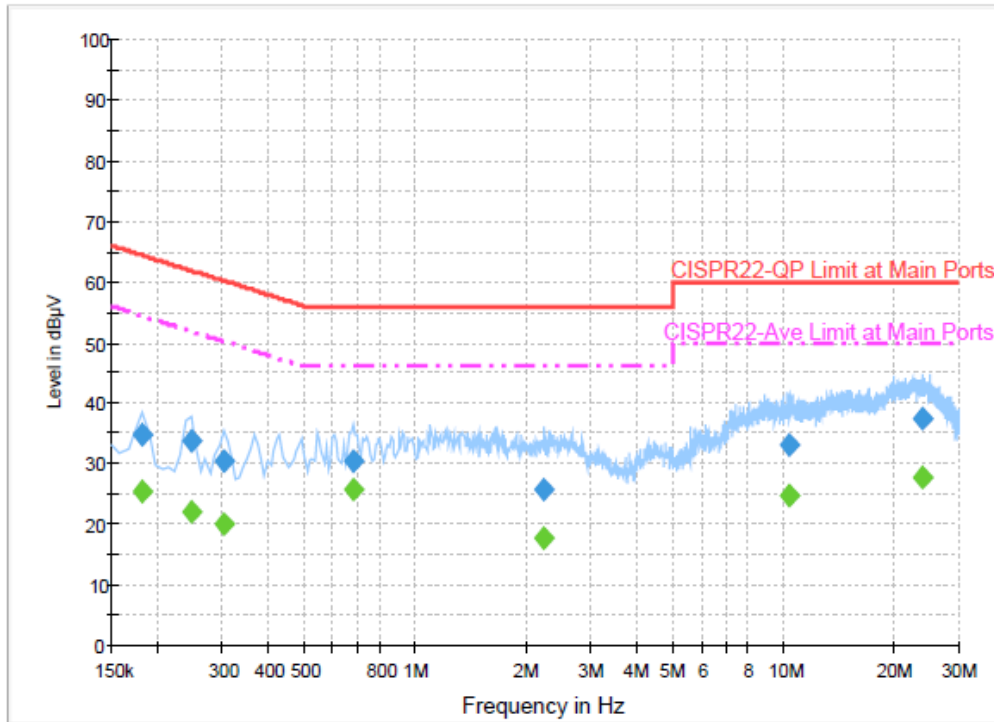

**Final Result : QuasiPeak**

Frequency (MHz)	QuasiPeak (dBµV)	Filter	Line	Corr. (dB)	Margin (dB)	Limit (dBµV)
0.182000	34.7	Off	N	19.5	29.7	64.4
0.246000	33.7	Off	N	19.5	28.2	61.9
0.302000	30.5	Off	N	19.5	29.7	60.2
0.678000	30.5	Off	N	19.6	25.5	56.0
2.246000	25.8	Off	N	19.7	30.2	56.0
10.358000	33.1	Off	N	19.8	26.9	60.0
23.926000	37.5	Off	N	20.1	22.5	60.0

**Final Result : Average**

Frequency (MHz)	Average (dBµV)	Filter	Line	Corr. (dB)	Margin (dB)	Limit (dBµV)
0.182000	25.3	Off	N	19.5	29.1	54.4
0.246000	22.2	Off	N	19.5	29.7	51.9
0.302000	20.0	Off	N	19.5	30.2	50.2
0.678000	25.7	Off	N	19.6	20.3	46.0
2.246000	17.7	Off	N	19.7	28.3	46.0
10.358000	24.7	Off	N	19.8	25.3	50.0
23.926000	27.8	Off	N	20.1	22.2	50.0

## 3.6 Frequency Stability Measurement

### 3.6.1 Limit of Frequency Stability

Manufacturers of U-NII devices are responsible for ensuring frequency stability such that an emission is maintained within the band of operation under all conditions of normal operation as specified in the user's manual.

### 3.6.2 Measuring Instruments

The measuring equipment is listed in the section 4 of this test report.

### 3.6.3 Test Procedures

1. To ensure emission at the band edge is maintained within the authorized band, those values shall be measured by radiation emissions at upper and lower frequency points, and finally compensated by frequency deviation as procedures below.
2. The EUT was operated at the maximum output power, and connected to the spectrum analyzer, which is set to maximum hold function and peak detector. The peak value of the power envelope was measured and noted. The upper and lower frequency points were respectively measured relatively 10dB lower than the measured peak value.
3. The frequency deviation was calculated by adding the upper frequency point and the lower frequency point divided by two. Those detailed values of frequency deviation are provided in table below.

### 3.6.4 Test Setup



### 3.6.5 Test Result of Frequency Stability

Please refer to Appendix A.





## **3.7 Automatically Discontinue Transmission**

### **3.7.1 Limit of Automatically Discontinue Transmission**

The device shall automatically discontinue transmission in case of either absence of information to transmit or operational failure. These provisions are not intended to preclude the transmission of control or signaling information or the use of repetitive codes used by certain digital technologies to complete frame or burst intervals. Applicants shall include in their application for equipment authorization to describe how this requirement is met.

### **3.7.2 Measuring Instruments**

The measuring equipment is listed in the section 4 of this test report.

### **3.7.3 Test Result of Automatically Discontinue Transmission**

While the EUT is not transmitting any information, the EUT can automatically discontinue transmission and become standby mode for power saving. The EUT can detect the controlling signal of ACK message transmitting from remote device and verify whether it shall resend or discontinue transmission.

### 3.8 Antenna Requirements

#### 3.8.1 Standard Applicable

According to FCC 47 CFR Section 15.407(a)(1)(2) ,if transmitting antenna directional gain is greater than 6 dBi, both the peak transmit power and the peak power spectral density shall be reduced by the amount in dB that the directional gain of the antenna exceeds 6 dBi.

#### 3.8.2 Antenna Anti-Replacement Construction

An embedded-in antenna design is used.

#### 3.8.3 Antenna Gain

FCC KDB 662911 D01 Multiple Transmitter Output v02r01

For CDD transmissions, directional gain is calculated as

$$DirectionalGain = 10 \cdot \log \left[ \frac{\sum_{j=1}^{N_{SS}} \left\{ \sum_{k=1}^{N_{ANT}} g_{j,k} \right\}^2}{N_{ANT}} \right]$$

where

Each antenna is driven by no more than one spatial stream;

$N_{SS}$  = the number of independent spatial streams of data;

$N_{ANT}$  = the total number of antennas

$g_{j,k} = 10^{G_k / 20}$  if the  $k$ th antenna is being fed by spatial stream  $j$ , or zero if it is not;  
 $G_k$  is the gain in dBi of the  $k$ th antenna.

The EUT supports CDD mode.

The power and PSD limit should be modified if the directional gain of EUT is over 6 dBi,

The directional gain “DG” is calculated as following table.



			DG for Power (dBi)	DG for PSD (dBi)	Power Limit Reduction (dB)	PSD Limit Reduction (dB)
	Ant 1 (dBi)	Ant 2 (dBi)				
Band I	-2.10	-6.20	-0.90	-0.90	0.00	0.00
Band II	-2.10	-6.20	-0.90	-0.90	0.00	0.00
Band III	-3.50	-6.10	-1.69	-1.69	0.00	0.00

$Power\ Limit\ Reduction = DG(Power) - 6dBi, (min = 0)$

$PSD\ Limit\ Reduction = DG(PSD) - 6dBi, (min = 0)$



## 4 List of Measuring Equipment

Instrument	Manufacturer	Model No.	Serial No.	Characteristics	Calibration Date	Test Date	Due Date	Remark
Power Meter	Anritsu	ML2495A	1218006	300MHz~40GHz	Oct. 18, 2014	Aug. 23, 2015 ~ Sep. 09, 2015	Oct. 17, 2015	Conducted (TH05-HY)
Spectrum Analyzer	Rohde & Schwarz	FSP40	100055	9kHz-40GHz	Jun. 18, 2015	Aug. 23, 2015 ~ Sep. 09, 2015	Jun. 17, 2016	Conducted (TH05-HY)
Power Sensor	Anritsu	MA2411B	1126017	300MHz~40GHz	Oct. 18, 2014	Aug. 23, 2015 ~ Sep. 09, 2015	Oct. 17, 2015	Conducted (TH05-HY)
Temperature Chamber	ESPEC	SU-241	92003713	-30°C~95°C	Jun. 15, 2015	Aug. 23, 2015 ~ Sep. 09, 2015	Jun. 14, 2016	Conducted (TH05-HY)
Hygrometer	Testo	608-H1	34897199	N/A	May 04, 2015	Aug. 23, 2015 ~ Sep. 09, 2015	May 03, 2016	Conducted (TH05-HY)
RF Cable	HARBOUR INDUSTRIES	LL142	Infinet CA3601-3601-DLL	0.1MHz~40GHz	Mar. 06, 2015	Aug. 23, 2015 ~ Sep. 09, 2015	Mar. 05, 2016	Conducted (TH05-HY)
EMI Test Receiver	Rohde & Schwarz	ESCS 30	100356	9kHz – 2.75GHz	Dec. 01, 2014	Aug. 28, 2015	Nov. 30, 2015	Conduction (CO05-HY)
Hygrometer	Testo	608-H1	34913912	N/A	Apr. 20, 2015	Aug. 28, 2015	Apr. 19, 2016	Conduction (CO05-HY)
LISN	Rohde & Schwarz	ENV216	100080	9kHz~30MHz	Dec. 02, 2014	Aug. 28, 2015	Dec. 01, 2015	Conduction (CO05-HY)
AC Power Source	ChainTek	APC-1000W	N/A	N/A	N/A	Aug. 28, 2015	N/A	Conduction (CO05-HY)
LF Cable	HUBER + SUHNER	RG-214/U	LF01	N/A	Jan. 07, 2015	Aug. 28, 2015	Jan. 06, 2016	Conduction (CO05-HY)
Test Software	N/A	EMC32	8.40.0	N/A	N/A	Aug. 28, 2015	N/A	Conduction (CO05-HY)
Bilog Antenna	Schaffner	CBL6111C	2726	30MHz ~ 1GHz	Sep. 27, 2014	Sep. 02, 2015 ~ Sep. 06, 2015	Sep. 26, 2015	Radiation (03CH07-HY)
Double Ridge Horn Antenna	ESCO	3117	00075962	1GHz ~ 18GHz	Aug. 21, 2015	Sep. 02, 2015 ~ Sep. 06, 2015	Aug. 20, 2016	Radiation (03CH07-HY)
Loop Antenna	TESEQ	HLA 6120	31244	9kHz~30MHz	Feb. 02, 2015	Sep. 02, 2015 ~ Sep. 06, 2015	Feb. 01, 2016	Radiation (03CH07-HY)
EMI Test Receiver	Rohde & Schwarz	ESCI 7	100724	9kHz~7GHz	Aug. 25, 2015	Sep. 02, 2015 ~ Sep. 06, 2015	Aug. 24, 2016	Radiation (03CH07-HY)
Horn Antenna	SCHWARZBECK	BBHA 9170	BBHA9170584	18GHz- 40GHz	Nov. 03, 2014	Sep. 02, 2015 ~ Sep. 06, 2015	Nov. 02, 2015	Radiation (03CH07-HY)
Hygrometer	Testo	608-H1	34897197	N/A	May. 04, 2015	Sep. 02, 2015 ~ Sep. 06, 2015	May. 03, 2016	Radiation (03CH07-HY)
Preamplifier	MITEQ	AMF-7D-0010 1800-30-10P	1590075	1GHz ~ 18GHz	Apr. 20, 2015	Sep. 02, 2015 ~ Sep. 06, 2015	Apr. 19, 2016	Radiation (03CH07-HY)
Preamplifier	COM-POWER	PA-103A	161241	10MHz-100MHz	Mar. 12, 2015	Sep. 02, 2015 ~ Sep. 06, 2015	Mar. 11, 2016	Radiation (03CH07-HY)
Preamplifier	Agilent	8449B	3008A02362	1GHz~ 26.5GHz	Oct. 21, 2014	Sep. 02, 2015 ~ Sep. 06, 2015	Oct. 20, 2015	Radiation (03CH07-HY)
Controller	ChainTek	Chaintek 3000	N/A	Control Turn table	N/A	Sep. 02, 2015 ~ Sep. 06, 2015	N/A	Radiation (03CH07-HY)
Controller	Max-Full	MF7802	MF780208368	Control Ant Mast	N/A	Sep. 02, 2015 ~ Sep. 06, 2015	N/A	Radiation (03CH07-HY)



Instrument	Manufacturer	Model No.	Serial No.	Characteristics	Calibration Date	Test Date	Due Date	Remark
Antenna Mast	Max-Full	MFA520BS	N/A	1m~4m	N/A	Sep. 02, 2015 ~ Sep. 06, 2015	N/A	Radiation (03CH07-HY)
Turn Table	ChainTek	Chaintek 3000	N/A	0~360 degree	N/A	Sep. 02, 2015 ~ Sep. 06, 2015	N/A	Radiation (03CH07-HY)
Preamplifier	MITEQ	JS44-1800400 0-33-8P	1840917	18GHz ~ 40GHz	Jun. 02, 2015	Sep. 02, 2015 ~ Sep. 06, 2015	Jun. 01, 2016	Radiation (03CH07-HY)
Signal Analyzer	Rohde & Schwarz	FSV 30	101749	10Hz~30GHz	Mar. 10, 2015	Sep. 02, 2015 ~ Sep. 06, 2015	Mar. 09, 2016	Radiation (03CH07-HY)
RF Cable	HUBER + SUHNER	SUCOFLEX 104	MY84209521	1GHz~40GHz	Dec. 04, 2014	Sep. 02, 2015 ~ Sep. 06, 2015	Dec. 03, 2015	Radiation (03CH07-HY)
RF Cable	HUBER + SUHNER	SUCOFLEX 104	MY84209521	9KHz~1GHz	Dec. 04, 2014	Sep. 02, 2015 ~ Sep. 06, 2015	Dec. 03, 2015	Radiation (03CH07-HY)
Test Software	Audix	E3	6.2009-8-24	N/A	N/A	Sep. 02, 2015 ~ Sep. 06, 2015	N/A	Radiation (03CH07-HY)
Filter	Wainwright	WLKS4500-8S S	SN19	4.5G Low Pass	Oct. 01, 2014	Sep. 02, 2015 ~ Sep. 06, 2015	Sep. 30, 2015	Radiation (03CH07-HY)
Filter	Microwave Circuits	H07G18G3	SN8009-01	7GHz HPF	Oct. 01, 2014	Sep. 02, 2015 ~ Sep. 06, 2015	Sep. 30, 2015	Radiation (03CH07-HY)



## 5 Uncertainty of Evaluation

### Uncertainty of Conducted Emission Measurement (150kHz ~ 30MHz)

Measuring Uncertainty for a Level of Confidence of 95% ( $U = 2Uc(y)$ )	2.26
-------------------------------------------------------------------------	------

### Uncertainty of Radiated Emission Measurement (30 MHz ~ 1000 MHz)

Measuring Uncertainty for a Level of Confidence of 95% ( $U = 2Uc(y)$ )	4.5
-------------------------------------------------------------------------	-----



## **Appendix A. Conducted Test Results**

Test Engineer:	Tommy Lee	Temperature:	21~25	°C
Test Date:	2015/08/23~2015/09/09	Relative Humidity:	51~54	%



**TEST RESULTS DATA**  
**26dB and 99% OBW**

Band I													
Mod.	Data Rate	NTX	CH.	Freq. (MHz)	99% Bandwidth (MHz)		26 dB Bandwidth (MHz)		IC 99% Bandwidth Power Limit (dBm)		IC 99% Bandwidth EIRP Limit (dBm)		Note
					Ant 1	Ant 2	Ant 1	Ant 2	Ant 1	Ant 2	Ant 1	Ant 2	
11a	6Mbps	2	36	5180	18.20	18.35	23.00	23.20	-	-	22.60	-	
11a	6Mbps	2	44	5220	18.35	18.10	23.00	22.75	-	-	22.58	-	
11a	6Mbps	2	48	5240	17.25	17.20	20.60	20.35	-	-	22.36	-	
HT20	MCS8	2	36	5180	19.10	18.85	23.25	23.25	-	-	22.75	-	
HT20	MCS8	2	44	5220	19.05	18.90	23.35	23.05	-	-	22.76	-	
HT20	MCS8	2	48	5240	18.05	18.05	20.80	20.80	-	-	22.56	-	
HT40	MCS8	2	38	5190	36.80	36.80	41.76	41.49	-	-	23.01	-	
HT40	MCS8	2	46	5230	36.70	36.70	41.49	41.49	-	-	23.01	-	
VHT20	MCS0	2	36	5180	18.80	18.85	23.20	23.20	-	-	22.74	-	
VHT20	MCS0	2	44	5220	18.70	18.95	23.25	23.25	-	-	22.72	-	
VHT20	MCS0	2	48	5240	18.00	18.00	21.00	20.85	-	-	22.55	-	
VHT40	MCS0	2	38	5190	36.70	36.70	41.58	41.40	-	-	23.01	-	
VHT40	MCS0	2	46	5230	36.70	36.80	41.58	41.40	-	-	23.01	-	
VHT80	MCS0	2	42	5210	75.84	75.84	82.88	82.24	-	-	23.01	-	

**TEST RESULTS DATA**  
**Average Power Table**

FCC Band I														
Mod.	Data Rate	NTX	CH.	Freq. (MHz)	Duty Factor (dB)		Average Conducted Power (dBm)			FCC Conducted Power Limit (dBm)		DG (dBi)		Pass/Fail
					Ant 1	Ant 2	Ant 1	Ant 2	SUM	Ant 1	Ant 2	Ant 1	Ant 2	
11a	6Mbps	1	36	5180	0.08	0.08	9.14	9.89		24.00	24.00	-2.10	-6.20	Pass
11a	6Mbps	1	44	5220	0.08	0.08	8.68	9.88		24.00	24.00	-2.10	-6.20	Pass
11a	6Mbps	1	48	5240	0.08	0.08	8.79	9.88		24.00	24.00	-2.10	-6.20	Pass
HT20	MCS0	1	36	5180	0.09	0.09	9.38	9.79		24.00	24.00	-2.10	-6.20	Pass
HT20	MCS0	1	44	5220	0.09	0.09	8.82	9.77		24.00	24.00	-2.10	-6.20	Pass
HT20	MCS0	1	48	5240	0.09	0.09	8.87	9.76		24.00	24.00	-2.10	-6.20	Pass
HT40	MCS0	1	38	5190	0.18	0.18	9.03	9.74		24.00	24.00	-2.10	-6.20	Pass
HT40	MCS0	1	46	5230	0.18	0.18	8.53	9.89		24.00	24.00	-2.10	-6.20	Pass
VHT20	MCS0	1	36	5180	0.09	0.09	9.40	9.86		24.00	24.00	-2.10	-6.20	Pass
VHT20	MCS0	1	44	5220	0.09	0.09	8.85	9.87		24.00	24.00	-2.10	-6.20	Pass
VHT20	MCS0	1	48	5240	0.09	0.09	9.05	9.80		24.00	24.00	-2.10	-6.20	Pass
VHT40	MCS0	1	38	5190	0.18	0.15	9.24	9.87		24.00	24.00	-2.10	-6.20	Pass
VHT40	MCS0	1	46	5230	0.18	0.15	8.64	9.78		24.00	24.00	-2.10	-6.20	Pass
VHT80	MCS0	1	42	5210	0.31	0.31	9.12	9.94		24.00	24.00	-2.10	-6.20	Pass
11a	6Mbps	2	36	5180	0.06	0.06	9.15	9.90	12.55	24.00		-0.90		Pass
11a	6Mbps	2	44	5220	0.06	0.06	8.74	9.90	12.36	24.00		-0.90		Pass
11a	6Mbps	2	48	5240	0.06	0.06	8.89	9.89	12.42	24.00		-0.90		Pass
HT20	MCS8	2	36	5180	0.09	0.09	9.41	9.99	12.72	24.00		-0.90		Pass
HT20	MCS8	2	44	5220	0.09	0.09	8.90	9.86	12.41	24.00		-0.90		Pass
HT20	MCS8	2	48	5240	0.09	0.09	8.92	9.98	12.49	24.00		-0.90		Pass
HT40	MCS8	2	38	5190	0.14	0.14	9.36	9.99	12.70	24.00		-0.90		Pass
HT40	MCS8	2	46	5230	0.14	0.14	8.53	9.97	12.32	24.00		-0.90		Pass
VHT20	MCS0	2	36	5180	0.09	0.09	9.47	9.87	12.68	24.00		-0.90		Pass
VHT20	MCS0	2	44	5220	0.09	0.09	8.92	9.96	12.48	24.00		-0.90		Pass
VHT20	MCS0	2	48	5240	0.09	0.09	9.06	9.83	12.47	24.00		-0.90		Pass
VHT40	MCS0	2	38	5190	0.12	0.12	9.24	9.97	12.63	24.00		-0.90		Pass
VHT40	MCS0	2	46	5230	0.12	0.12	8.65	9.83	12.29	24.00		-0.90		Pass
VHT80	MCS0	2	42	5210	0.28	0.28	9.15	9.95	12.58	24.00		-0.90		Pass

**TEST RESULTS DATA**  
**Power Spectral Density**

FCC Band I														
Mod.	Data Rate	NTX	CH.	Freq. (MHz)	Duty Factor (dB)		Average Power Density (dBm/MHz)			Average PSD Limit (dBm/MHz)		DG (dBi)		Pass /Fail
					Ant 1	Ant 2	Ant 1	Ant 2	SUM	Ant 1	Ant 2	Ant 1	Ant 2	
11a	6Mbps	2	36	5180	0.06	0.06			1.58	11.00			-0.90	Pass
11a	6Mbps	2	44	5220	0.06	0.06			0.89	11.00			-0.90	Pass
11a	6Mbps	2	48	5240	0.06	0.06			0.51	11.00			-0.90	Pass
HT20	MCS8	2	36	5180	0.09	0.09			1.28	11.00			-0.90	Pass
HT20	MCS8	2	44	5220	0.09	0.09			0.48	11.00			-0.90	Pass
HT20	MCS8	2	48	5240	0.09	0.09			0.04	11.00			-0.90	Pass
HT40	MCS8	2	38	5190	0.14	0.14			-1.39	11.00			-0.90	Pass
HT40	MCS8	2	46	5230	0.14	0.14			-1.97	11.00			-0.90	Pass
VHT20	MCS0	2	36	5180	0.09	0.09			1.59	11.00			-0.90	Pass
VHT20	MCS0	2	44	5220	0.09	0.09			0.94	11.00			-0.90	Pass
VHT20	MCS0	2	48	5240	0.09	0.09			0.53	11.00			-0.90	Pass
VHT40	MCS0	2	38	5190	0.12	0.12			-1.44	11.00			-0.90	Pass
VHT40	MCS0	2	46	5230	0.12	0.12			-2.14	11.00			-0.90	Pass
VHT80	MCS0	2	42	5210	0.28	0.28			-4.52	11.00			-0.90	Pass

**TEST RESULTS DATA**  
**26dB and 99% OBW**

Band II															
Mod.	Data Rate	NTX	CH.	Freq. (MHz)	99% Bandwidth (MHz)		26 dB Bandwidth (MHz)		IC 99% Bandwidth Power Limit (dBm)		IC 99% Bandwidth EIRP Limit (dBm)		FCC 26dB Bandwidth Power Limit (dBm)		Note
					Ant 1	Ant 2	Ant 1	Ant 2	Ant 1	Ant 2	Ant 1	Ant 2	Ant 1	Ant 2	
11a	6Mbps	2	52	5260	17.25	17.30	20.65	20.35	23.37		29.37		23.98		
11a	6Mbps	2	60	5300	18.35	18.30	22.90	22.75	23.62		29.62		23.98		
11a	6Mbps	2	64	5320	18.30	18.10	23.10	22.65	23.58		29.58		23.98		
HT20	MCS8	2	52	5260	18.00	18.10	20.90	20.80	23.55		29.55		23.98		
HT20	MCS8	2	60	5300	18.90	19.00	23.30	23.15	23.76		29.76		23.98		
HT20	MCS8	2	64	5320	19.15	18.95	23.30	23.20	23.78		29.78		23.98		
HT40	MCS8	2	54	5270	36.70	36.70	41.58	41.49	23.98		30.00		23.98		
HT40	MCS8	2	62	5310	36.80	36.80	41.85	41.13	23.98		30.00		23.98		
VHT20	MCS0	2	52	5260	18.05	18.10	20.95	20.75	23.56		29.56		23.98		
VHT20	MCS0	2	60	5300	19.05	18.80	23.30	23.05	23.74		29.74		23.98		
VHT20	MCS0	2	64	5320	19.05	18.90	23.40	23.15	23.76		29.76		23.98		
VHT40	MCS0	2	54	5270	36.80	36.80	41.76	41.31	23.98		30.00		23.98		
VHT40	MCS0	2	62	5310	36.70	36.70	41.58	41.31	23.98		30.00		23.98		
VHT80	MCS0	2	58	5290	76.20	76.08	82.88	82.24	23.98		30.00		23.98		

**TEST RESULTS DATA**  
**Average Power Table**

FCC Band II														
Mod.	Data Rate	NTX	CH.	Freq. (MHz)	Duty Factor (dB)		Average Conducted Power (dBm)			FCC Conducted Power Limit (dBm)		DG (dBi)		Pass/Fail
					Ant 1	Ant 2	Ant 1	Ant 2	SUM	Ant 1	Ant 2	Ant 1	Ant 2	
11a	6Mbps	1	52	5260	0.08	0.08	8.82	9.88		23.98	23.98	-2.10	-6.20	Pass
11a	6Mbps	1	60	5300	0.08	0.08	8.90	9.86		23.98	23.98	-2.10	-6.20	Pass
11a	6Mbps	1	64	5320	0.08	0.08	8.77	9.83		23.98	23.98	-2.10	-6.20	Pass
HT20	MCS0	1	52	5260	0.09	0.09	8.83	9.58		23.98	23.98	-2.10	-6.20	Pass
HT20	MCS0	1	60	5300	0.09	0.09	9.08	9.70		23.98	23.98	-2.10	-6.20	Pass
HT20	MCS0	1	64	5320	0.09	0.09	9.04	9.76		23.98	23.98	-2.10	-6.20	Pass
HT40	MCS0	1	54	5270	0.18	0.18	9.04	9.72		23.98	23.98	-2.10	-6.20	Pass
HT40	MCS0	1	62	5310	0.18	0.18	8.78	9.72		23.98	23.98	-2.10	-6.20	Pass
VHT20	MCS0	1	52	5260	0.09	0.09	8.93	9.85		23.98	23.98	-2.10	-6.20	Pass
VHT20	MCS0	1	60	5300	0.09	0.09	9.14	9.54		23.98	23.98	-2.10	-6.20	Pass
VHT20	MCS0	1	64	5320	0.09	0.09	9.03	9.64		23.98	23.98	-2.10	-6.20	Pass
VHT40	MCS0	1	54	5270	0.18	0.15	8.82	9.70		23.98	23.98	-2.10	-6.20	Pass
VHT40	MCS0	1	62	5310	0.18	0.15	8.34	9.76		23.98	23.98	-2.10	-6.20	Pass
VHT80	MCS0	1	58	5290	0.31	0.31	9.03	9.87		23.98	23.98	-2.10	-6.20	Pass
11a	6Mbps	2	52	5260	0.06	0.06	8.83	9.99	12.45	23.98		-0.90		Pass
11a	6Mbps	2	60	5300	0.06	0.06	8.93	9.94	12.47	23.98		-0.90		Pass
11a	6Mbps	2	64	5320	0.06	0.06	8.80	9.94	12.41	23.98		-0.90		Pass
HT20	MCS8	2	52	5260	0.09	0.09	8.85	9.62	12.26	23.98		-0.90		Pass
HT20	MCS8	2	60	5300	0.09	0.09	9.14	9.73	12.45	23.98		-0.90		Pass
HT20	MCS8	2	64	5320	0.09	0.09	9.07	9.91	12.52	23.98		-0.90		Pass
HT40	MCS8	2	54	5270	0.14	0.14	9.05	9.73	12.41	23.98		-0.90		Pass
HT40	MCS8	2	62	5310	0.14	0.14	8.83	9.96	12.44	23.98		-0.90		Pass
VHT20	MCS0	2	52	5260	0.09	0.09	8.98	9.92	12.48	23.98		-0.90		Pass
VHT20	MCS0	2	60	5300	0.09	0.09	9.22	9.62	12.43	23.98		-0.90		Pass
VHT20	MCS0	2	64	5320	0.09	0.09	9.10	9.70	12.42	23.98		-0.90		Pass
VHT40	MCS0	2	54	5270	0.12	0.12	8.98	9.74	12.38	23.98		-0.90		Pass
VHT40	MCS0	2	62	5310	0.12	0.12	8.49	9.83	12.22	23.98		-0.90		Pass
VHT80	MCS0	2	58	5290	0.28	0.28	9.05	9.90	12.51	23.98		-0.90		Pass

**TEST RESULTS DATA**  
**Power Spectral Density**

Band II														
Mod.	Data Rate	NTX	CH.	Freq. (MHz)	Duty Factor (dB)		Average Power Density (dBm/MHz)			Average PSD Limit (dBm/MHz)		DG (dBi)		Pass /Fail
					Ant 1	Ant 2	Ant 1	Ant 2	SUM	Ant 1	Ant 2	Ant 1	Ant 2	
11a	6Mbps	2	52	5260	0.06	0.06			0.33	11.00			-0.90	Pass
11a	6Mbps	2	60	5300	0.06	0.06			0.55	11.00			-0.90	Pass
11a	6Mbps	2	64	5320	0.06	0.06			0.47	11.00			-0.90	Pass
HT20	MCS8	2	52	5260	0.09	0.09			0.59	11.00			-0.90	Pass
HT20	MCS8	2	60	5300	0.09	0.09			0.56	11.00			-0.90	Pass
HT20	MCS8	2	64	5320	0.09	0.09			0.57	11.00			-0.90	Pass
HT40	MCS8	2	54	5270	0.14	0.14			-2.02	11.00			-0.90	Pass
HT40	MCS8	2	62	5310	0.14	0.14			-2.06	11.00			-0.90	Pass
VHT20	MCS0	2	52	5260	0.09	0.09			0.66	11.00			-0.90	Pass
VHT20	MCS0	2	60	5300	0.09	0.09			0.61	11.00			-0.90	Pass
VHT20	MCS0	2	64	5320	0.09	0.09			0.46	11.00			-0.90	Pass
VHT40	MCS0	2	54	5270	0.12	0.12			-2.26	11.00			-0.90	Pass
VHT40	MCS0	2	62	5310	0.12	0.12			-2.28	11.00			-0.90	Pass
VHT80	MCS0	2	58	5290	0.28	0.28			-4.95	11.00			-0.90	Pass

**TEST RESULTS DATA**  
**26dB and 99% OBW**

Band III															
Mod.	Data Rate	NTX	CH.	Freq. (MHz)	99% Bandwidth (MHz)		26 dB Bandwidth (MHz)		IC 99% Bandwidth Power Limit (dBm)		IC 99% Bandwidth EIRP Limit (dBm)		FCC 26dB Bandwidth Power Limit (dBm)		Note
					Ant 1	Ant 2	Ant 1	Ant 2	Ant 1	Ant 2	Ant 1	Ant 2	Ant 1	Ant 2	
11a	6Mbps	2	100	5500	18.25	17.85	22.95	22.80	23.52		29.52		23.98		
11a	6Mbps	2	116	5580	17.35	17.25	20.75	20.50	23.37		29.37		23.98		
11a	6Mbps	2	140	5700	18.00	18.05	23.10	22.85	23.55		29.55		23.98		
HT20	MCS8	2	100	5500	19.10	19.05	23.10	23.15	23.80		29.80		23.98		
HT20	MCS8	2	116	5580	18.00	18.05	20.95	20.85	23.55		29.55		23.98		
HT20	MCS8	2	140	5700	19.15	18.90	23.35	23.15	23.76		29.76		23.98		
HT40	MCS8	2	102	5510	36.60	36.70	41.76	41.22	23.98		30.00		23.98		
HT40	MCS8	2	110	5550	36.70	36.70	41.58	41.13	23.98		30.00		23.98		
HT40	MCS8	2	134	5670	36.80	36.80	41.67	41.31	23.98		30.00		23.98		
VHT20	MCS0	2	100	5500	18.95	19.00	23.40	23.20	23.78		29.78		23.98		
VHT20	MCS0	2	116	5580	18.05	18.05	20.95	20.85	23.56		29.56		23.98		
VHT20	MCS0	2	140	5700	18.80	18.80	23.50	23.15	23.74		29.74		23.98		
VHT40	MCS0	2	102	5510	36.60	36.80	41.49	41.31	23.98		30.00		23.98		
VHT40	MCS0	2	110	5550	36.60	36.70	41.40	41.31	23.98		30.00		23.98		
VHT40	MCS0	2	134	5670	36.80	36.70	41.31	41.40	23.98		30.00		23.98		
VHT80	MCS0	2	106	5530	75.96	75.84	82.72	82.08	23.98		30.00		23.98		
VHT80	MCS0	2	122	5610	75.96	75.84	82.88	82.08	23.98		30.00		23.98		

**TEST RESULTS DATA**  
**Average Power Table**

FCC Band III														
Mod.	Data Rate	NTX	CH.	Freq. (MHz)	Duty Factor (dB)		Average Conducted Power (dBm)			FCC Conducted Power Limit (dBm)		DG (dBi)		Pass/Fail
					Ant 1	Ant 2	Ant 1	Ant 2	SUM	Ant 1	Ant 2	Ant 1	Ant 2	
11a	6Mbps	1	100	5500	0.08	0.08	8.89	9.44		23.98	23.98	-3.50	-6.10	Pass
11a	6Mbps	1	116	5580	0.08	0.08	8.93	8.89		23.98	23.98	-3.50	-6.10	Pass
11a	6Mbps	1	140	5700	0.08	0.08	8.44	8.81		23.98	23.98	-3.50	-6.10	Pass
HT20	MCS0	1	100	5500	0.09	0.09	9.16	9.03		23.98	23.98	-3.50	-6.10	Pass
HT20	MCS0	1	116	5580	0.09	0.09	9.10	9.23		23.98	23.98	-3.50	-6.10	Pass
HT20	MCS0	1	140	5700	0.09	0.09	8.96	8.91		23.98	23.98	-3.50	-6.10	Pass
HT40	MCS0	1	102	5510	0.18	0.18	8.66	9.16		23.98	23.98	-3.50	-6.10	Pass
HT40	MCS0	1	110	5550	0.18	0.18	9.00	9.29		23.98	23.98	-3.50	-6.10	Pass
HT40	MCS0	1	134	5670	0.18	0.18	9.41	9.01		23.98	23.98	-3.50	-6.10	Pass
VHT20	MCS0	1	100	5500	0.09	0.09	9.21	9.08		23.98	23.98	-3.50	-6.10	Pass
VHT20	MCS0	1	116	5580	0.09	0.09	9.18	8.90		23.98	23.98	-3.50	-6.10	Pass
VHT20	MCS0	1	140	5700	0.09	0.09	8.99	8.95		23.98	23.98	-3.50	-6.10	Pass
VHT40	MCS0	1	102	5510	0.18	0.15	8.80	9.34		23.98	23.98	-3.50	-6.10	Pass
VHT40	MCS0	1	110	5550	0.18	0.15	9.09	9.13		23.98	23.98	-3.50	-6.10	Pass
VHT40	MCS0	1	134	5670	0.18	0.15	9.16	9.01		23.98	23.98	-3.50	-6.10	Pass
VHT80	MCS0	1	106	5530	0.31	0.31	9.30	9.59		23.98	23.98	-3.50	-6.10	Pass
VHT80	MCS0	1	122	5610	0.31	0.31	9.13	9.45		23.98	23.98	-3.50	-6.10	Pass
11a	6Mbps	2	100	5500	0.06	0.06	8.92	9.45	12.20	23.98		-1.69		Pass
11a	6Mbps	2	116	5580	0.06	0.06	9.03	8.92	11.98	23.98		-1.69		Pass
11a	6Mbps	2	140	5700	0.06	0.06	8.52	8.88	11.71	23.98		-1.69		Pass
HT20	MCS8	2	100	5500	0.09	0.09	9.25	9.10	12.18	23.98		-1.69		Pass
HT20	MCS8	2	116	5580	0.09	0.09	9.28	9.27	12.28	23.98		-1.69		Pass
HT20	MCS8	2	140	5700	0.09	0.09	8.98	8.98	11.99	23.98		-1.69		Pass
HT40	MCS8	2	102	5510	0.14	0.14	8.79	9.19	12.01	23.98		-1.69		Pass
HT40	MCS8	2	110	5550	0.14	0.14	9.02	9.29	12.17	23.98		-1.69		Pass
HT40	MCS8	2	134	5670	0.14	0.14	9.43	9.03	12.25	23.98		-1.69		Pass
VHT20	MCS0	2	100	5500	0.09	0.09	9.21	9.10	12.16	23.98		-1.69		Pass
VHT20	MCS0	2	116	5580	0.09	0.09	9.27	8.94	12.12	23.98		-1.69		Pass
VHT20	MCS0	2	140	5700	0.09	0.09	9.08	8.98	12.04	23.98		-1.69		Pass
VHT40	MCS0	2	102	5510	0.12	0.12	8.71	9.37	12.06	23.98		-1.69		Pass
VHT40	MCS0	2	110	5550	0.12	0.12	9.09	9.18	12.14	23.98		-1.69		Pass
VHT40	MCS0	2	134	5670	0.12	0.12	9.17	9.03	12.11	23.98		-1.69		Pass
VHT80	MCS0	2	106	5530	0.28	0.28	9.31	9.60	12.47	23.98		-1.69		Pass
VHT80	MCS0	2	122	5610	0.28	0.28	9.15	9.59	12.39	23.98		-1.69		Pass



**TEST RESULTS DATA**  
**Power Spectral Density**

Band III														
Mod.	Data Rate	NTX	CH.	Freq. (MHz)	Duty Factor (dB)		Average Power Density (dBm/MHz)			Average PSD Limit (dBm/MHz)		DG (dBi)		Pass /Fail
					Ant 1	Ant 2	Ant 1	Ant 2	SUM	Ant 1	Ant 2	Ant 1	Ant 2	
11a	6Mbps	2	100	5500	0.06	0.06			1.12	11.00		-1.69		Pass
11a	6Mbps	2	116	5580	0.06	0.06			1.75	11.00		-1.69		Pass
11a	6Mbps	2	140	5700	0.06	0.06			0.16	11.00		-1.69		Pass
HT20	MCS8	2	100	5500	0.09	0.09			1.39	11.00		-1.69		Pass
HT20	MCS8	2	116	5580	0.09	0.09			1.39	11.00		-1.69		Pass
HT20	MCS8	2	140	5700	0.09	0.09			0.33	11.00		-1.69		Pass
HT40	MCS8	2	102	5510	0.14	0.14			-1.68	11.00		-1.69		Pass
HT40	MCS8	2	110	5550	0.14	0.14			-1.72	11.00		-1.69		Pass
HT40	MCS8	2	134	5670	0.14	0.14			-2.20	11.00		-1.69		Pass
VHT20	MCS0	2	100	5500	0.09	0.09			1.18	11.00		-1.69		Pass
VHT20	MCS0	2	116	5580	0.09	0.09			1.36	11.00		-1.69		Pass
VHT20	MCS0	2	140	5700	0.09	0.09			0.21	11.00		-1.69		Pass
VHT40	MCS0	2	102	5510	0.12	0.12			-1.76	11.00		-1.69		Pass
VHT40	MCS0	2	110	5550	0.12	0.12			-1.67	11.00		-1.69		Pass
VHT40	MCS0	2	134	5670	0.12	0.12			-2.40	11.00		-1.69		Pass
VHT80	MCS0	2	106	5530	0.28	0.28			-4.36	11.00		-1.69		Pass
VHT80	MCS0	2	122	5610	0.28	0.28			-4.42	11.00		-1.69		Pass

**TEST RESULTS DATA**  
**26dB and 99% OBW**

Straddle Channel															
Mod.	Data Rate	NTX	CH.	Freq. (MHz)	99% Bandwidth (MHz)		Emission Bandwidth (MHz)		IC 99% Bandwidth Power Limit (dBm)		IC 99% Bandwidth EIRP Limit (dBm)		FCC 26dB Bandwidth Power Limit (dBm)		Note
					Ant 1	Ant 2	Ant 1	Ant 2	Ant 1	Ant 2	Ant 1	Ant 2	Ant 1	Ant 2	
11a	6Mbps	2	144	5720	18.10	18.05	23.15	22.70	-	-	-	-	-	-	
				NII-2C	14.1	14.05	16.55	16.3	22.48	28.48	23.12				
				NII-3	4	4	6.6	6.4	30.00	36.00	30.00				
HT20	MCS8	2	144	5720	18.85	18.95	23.40	23.25	-	-	-	-	-		
				NII-2C	14.45	14.6	16.7	16.6	22.60	28.60	23.20				
				NII-3	4.4	4.35	6.7	6.65	30.00	36.00	30.00				
HT40	MCS8	2	142	5710	36.70	36.80	41.58	41.31	-	-	-	-	-		
				NII-2C	33.4	33.5	35.88	35.7	23.98	30.00	23.98				
				NII-3	3.3	3.3	5.7	5.61	30.00	36.00	30.00				
VHT20	MCS0	2	144	5720	18.90	18.95	23.25	23.05	-	-	-	-	-		
				NII-2C	14.5	14.5	16.65	16.6	22.61	28.61	23.20				
				NII-3	4.4	4.45	6.6	6.45	30.00	36.00	30.00				
VHT40	MCS0	2	142	5710	36.70	36.70	41.49	41.40	-	-	-	-	-		
				NII-2C	33.4	33.4	35.79	35.79	23.98	30.00	23.98				
				NII-3	3.3	3.3	5.7	5.61	30.00	36.00	30.00				
VHT80	MCS0	2	138	5690	75.96	76.08	82.56	82.40	-	-	-	-	-		
				NII-2C	73.04	73.16	76.28	76.28	23.98	30.00	23.98				
				NII-3	2.92	2.92	6.28	6.12	30.00	36.00	30.00				

**TEST RESULTS DATA**  
**Average Power Table**

FCC Straddle Channel														
Mod.	Data Rate	NTX	CH.	Freq. (MHz)	Duty Factor (dB)		Average Conducted Power (dBm)			FCC Conducted Power Limit (dBm)		DG (dBi)		Pass/Fail
					Ant 1	Ant 2	Ant 1	Ant 2	SUM	Ant 1	Ant 2	Ant 1	Ant 2	
11a	6Mbps	1	144	5720	0.08	0.08	9.79	9.93		-	-	-3.50	-6.10	-
				NII-2C	0.08	0.08	8.88	9.03		23.17	23.17	-3.50	-6.10	Pass
				NII-3	0.08	0.08	2.55	2.67		30.00	30.00	-3.50	-6.10	Pass
HT20	MCS0	1	144	5720	0.09	0.09	9.74	9.70		-	-	-3.50	-6.10	-
				NII-2C	0.09	0.09	8.74	8.66		23.23	23.24	-3.50	-6.10	Pass
				NII-3	0.09	0.09	2.88	2.97		30.00	30.00	-3.50	-6.10	Pass
HT40	MCS0	1	142	5710	0.18	0.18	9.84	9.90		-	-	-3.50	-6.10	-
				NII-2C	0.18	0.18	9.52	9.57		23.98	23.98	-3.50	-6.10	Pass
				NII-3	0.18	0.18	-1.60	-1.44		30.00	30.00	-3.50	-6.10	Pass
VHT20	MCS0	1	144	5720	0.09	0.09	9.53	9.63		-	-	-3.50	-6.10	-
				NII-2C	0.09	0.09	8.53	8.60		23.21	23.24	-3.50	-6.10	Pass
				NII-3	0.09	0.09	2.64	2.87		30.00	30.00	-3.50	-6.10	Pass
VHT40	MCS0	1	142	5710	0.18	0.15	9.77	9.83		-	-	-3.50	-6.10	-
				NII-2C	0.18	0.15	9.44	9.48		23.98	23.98	-3.50	-6.10	Pass
				NII-3	0.18	0.15	-1.57	-1.24		30.00	30.00	-3.50	-6.10	Pass
VHT80	MCS0	1	138	5690	0.31	0.31	9.84	9.85		-	-	-3.50	-6.10	-
				NII-2C	0.31	0.31	9.69	9.71		23.98	23.98	-3.50	-6.10	Pass
				NII-3	0.31	0.31	-4.95	-5.07		30.00	30.00	-3.50	-6.10	Pass
11a	6Mbps	2	144	5720	0.06	0.06	9.65	9.98	12.83	-	-	-1.69	-	-
				NII-2C	0.06	0.06	8.74	9.09	11.93	23.12		-1.69	-	Pass
				NII-3	0.06	0.06	2.39	2.68	5.55	30.00		-1.69	-	Pass
HT20	MCS0	2	144	5720	0.09	0.09	9.88	9.97	12.94	-	-	-1.69	-	-
				NII-2C	0.09	0.09	8.89	9.04	11.98	23.20		-1.69	-	Pass
				NII-3	0.09	0.09	2.99	2.83	5.92	30.00		-1.69	-	Pass
HT40	MCS0	2	142	5710	0.14	0.14	9.69	9.93	12.82	-	-	-1.69	-	-
				NII-2C	0.14	0.14	9.37	9.59	12.49	23.98		-1.69	-	Pass
				NII-3	0.14	0.14	-1.74	-1.36	1.46	30.00		-1.69	-	Pass
VHT20	MCS0	2	144	5720	0.09	0.09	9.71	9.79	12.76	-	-	-1.69	-	-
				NII-2C	0.09	0.09	8.72	8.84	11.79	23.20		-1.69	-	Pass
				NII-3	0.09	0.09	2.81	2.71	5.77	30.00		-1.69	-	Pass
VHT40	MCS0	2	142	5710	0.12	0.12	9.64	9.84	12.75	-	-	-1.69	-	-
				NII-2C	0.12	0.12	9.30	9.49	12.41	23.98		-1.69	-	Pass
				NII-3	0.12	0.12	-1.57	-1.29	1.58	30.00		-1.69	-	Pass
VHT80	MCS0	2	138	5690	0.28	0.28	9.84	10.01	12.94	-	-	-1.69	-	-
				NII-2C	0.28	0.28	9.71	9.88	12.81	23.98		-1.69	-	Pass
				NII-3	0.28	0.28	-5.31	-5.18	-2.23	30.00		-1.69	-	Pass

**TEST RESULTS DATA**  
**Power Spectral Density**

Straddle Channel														
Mod.	Data Rate	NTX	CH.	Freq. (MHz)	Duty Factor (dB)		Average Power Density (dBm/MHz)			Average PSD Limit (dBm/MHz)		DG (dBi)		Pass /Fail
					Ant 1	Ant 2	Ant 1	Ant 2	SUM	Ant 1	Ant 2	Ant 1	Ant 2	
11a	6Mbps	2	144	NII-2C	0.06	0.06			1.75	11.00			-1.69	Pass
				NII-3	0.06	0.06			1.75	30.00			-1.69	Pass
HT20	MCS8	2	144	NII-2C	0.09	0.09			1.23	11.00			-1.69	Pass
				NII-3	0.09	0.09			1.23	30.00			-1.69	Pass
HT40	MCS8	2	142	NII-2C	0.14	0.14			-1.46	11.00			-1.69	Pass
				NII-3	0.14	0.14			-1.46	30.00			-1.69	Pass
VHT20	MCS0	2	144	NII-2C	0.09	0.09			1.42	11.00			-1.69	Pass
				NII-3	0.09	0.09			1.42	30.00			-1.69	Pass
VHT40	MCS0	2	142	NII-2C	0.12	0.12			-1.49	11.00			-1.69	Pass
				NII-3	0.12	0.12			-1.49	30.00			-1.69	Pass
VHT80	MCS0	2	138	NII-2C	0.28	0.28			-4.34	11.00			-1.69	Pass
				NII-3	0.28	0.28			-4.34	30.00			-1.69	Pass

**TEST RESULTS DATA**  
**Frequency Stability**

Band I										
Mod.	Data Rate	NTX	CH.	Freq. (MHz)	Center Frequency (MHz)	Frequency Deviation (MHz)	Frequency Stability (ppm)	Temperature (°C)	Voltage (V)	Note
11a	6Mbps	1	36	5180	5180.000	0.000	0.00	20	3.6	
11a	6Mbps	1	36	5180	5180.025	0.025	4.83	20	4.2	
11a	6Mbps	1	36	5180	5180.000	0.000	0.00	20	3.8	
11a	6Mbps	1	36	5180	5180.050	0.050	9.65	-10	3.8	
11a	6Mbps	1	36	5180	5180.000	0.000	0.00	55	3.8	

Band II										
Mod.	Data Rate	NTX	CH.	Freq. (MHz)	Center Frequency (MHz)	Frequency Deviation (MHz)	Frequency Stability (ppm)	Temperature (°C)	Voltage (V)	Note
11a	6Mbps	1	64	5320	5320.000	0.000	0.00	20	3.6	
11a	6Mbps	1	64	5320	5320.000	0.000	0.00	20	4.2	
11a	6Mbps	1	64	5320	5320.000	0.000	0.00	20	3.8	
11a	6Mbps	1	64	5320	5320.050	0.050	9.40	-10	3.8	
11a	6Mbps	1	64	5320	5320.000	0.000	0.00	55	3.8	

Band III										
Mod.	Data Rate	NTX	CH.	Freq. (MHz)	Center Frequency (MHz)	Frequency Deviation (MHz)	Frequency Stability (ppm)	Temperature (°C)	Voltage (V)	Note
11a	6Mbps	1	100	5500	5500.000	0.000	0.00	20	3.6	
11a	6Mbps	1	100	5500	5500.000	0.000	0.00	20	4.2	
11a	6Mbps	1	100	5500	5500.000	0.000	0.00	20	3.8	
11a	6Mbps	1	100	5500	5500.050	0.050	9.09	-10	3.8	
11a	6Mbps	1	100	5500	5500.000	0.000	0.00	55	3.8	



## Appendix B. Radiated Spurious Emission

Test Engineer :	Luke Chang	Temperature :	21~23°C
		Relative Humidity :	41~42%

15E Band 1 - 5150~5250MHz

WIFI 802.11a (Band Edge @ 3m)

WIFI	Note	Frequency	Level	Over	Limit	Read	Antenna	Cable	Preamp	Ant	Table	Peak	Pol.	
Ant.				Limit	Line	Level	Factor	Loss	Factor	Pos	Pos	Avg.		
1+2		( MHz )	( dBµV/m )	( dB )	( dBµV/m )	( dBµV )	( dB/m )	( dB )	( dB )	( cm )	( deg )	( P/A )	( H/V )	
802.11a CH 36 5180MHz		5037.05	58.19	-15.81	74	44.65	34.45	11.41	32.32	212	46	P	H	
		5149.7	43.39	-10.61	54	29.72	34.61	11.55	32.49	212	46	A	H	
	*	5180	99.92	-	-	86.23	34.66	11.55	32.52	212	46	P	H	
	*	5180	89.44	-	-	75.75	34.66	11.55	32.52	212	46	A	H	
													H	
														H
			5142.05	57.7	-16.3	74	43.99	34.61	11.55	32.45	199	350	P	V
			5150	43.68	-10.32	54	30.01	34.61	11.55	32.49	199	350	A	V
	*		5180	103.53	-	-	89.84	34.66	11.55	32.52	199	350	P	V
	*		5180	93.27	-	-	79.58	34.66	11.55	32.52	199	350	A	V
														V
														V
802.11a CH 44 5220MHz		5118.8	57.54	-16.46	74	43.93	34.56	11.5	32.45	206	46	P	H	
		5149.55	43.15	-10.85	54	29.48	34.61	11.55	32.49	206	46	A	H	
	*	5220	100.71	-	-	86.97	34.7	11.59	32.55	206	46	P	H	
	*	5220	90.07	-	-	76.33	34.7	11.59	32.55	206	46	A	H	
			5393.34	57.63	-16.37	74	44.23	34.94	11.74	33.28	206	46	P	H
			5395.87	43.38	-10.62	54	29.96	34.96	11.74	33.28	206	46	A	H
			5136.2	58.1	-15.9	74	44.46	34.59	11.5	32.45	160	355	P	V
			5149.7	43.2	-10.8	54	29.53	34.61	11.55	32.49	160	355	A	V
	*		5220	101.76	-	-	88.02	34.7	11.59	32.55	160	355	P	V
	*		5220	92.01	-	-	78.27	34.7	11.59	32.55	160	355	A	V
			5442.51	57.74	-16.26	74	44.41	35.01	11.8	33.48	160	355	P	V
			5388.94	43.39	-10.61	54	29.99	34.94	11.74	33.28	160	355	A	V



<b>802.11a CH 48 5240MHz</b>		5135.3	57.49	-16.51	74	43.85	34.59	11.5	32.45	169	300	P	H
		5142.8	43.11	-10.89	54	29.4	34.61	11.55	32.45	169	300	A	H
	*	5240	100.54	-	-	86.84	34.73	11.62	32.65	169	300	P	H
	*	5240	90.2	-	-	76.5	34.73	11.62	32.65	169	300	A	H
		5394.77	57.78	-16.22	74	44.36	34.96	11.74	33.28	169	300	P	H
		5394.44	43.38	-10.62	54	29.98	34.94	11.74	33.28	169	300	A	H
		5126.9	57.14	-16.86	74	43.5	34.59	11.5	32.45	144	338	P	V
		5149.55	43.17	-10.83	54	29.5	34.61	11.55	32.49	144	338	A	V
	*	5240	102.91	-	-	89.21	34.73	11.62	32.65	144	338	P	V
	*	5240	92.5	-	-	78.8	34.73	11.62	32.65	144	338	A	V
		5414.35	57.37	-16.63	74	44.04	34.98	11.74	33.39	144	338	P	V
		5384.65	43.4	-10.6	54	30	34.94	11.74	33.28	144	338	A	V
<b>Remark</b>	1. No other spurious found. 2. All results are PASS against Peak and Average limit line.												



15E Band 1 5150~5250MHz

WIFI 802.11a (Harmonic @ 3m)

WIFI	Note	Frequency	Level	Over	Limit	Read	Antenna	Cable	Preamp	Ant	Table	Peak	Pol.
Ant.				Limit	Line	Level	Factor	Loss	Factor	Pos	Pos	Avg.	
1+2		( MHz )	( dBμV/m )	( dB )	( dBμV/m )	( dBμV )	( dB/m )	( dB )	( dB )	( cm )	( deg )	( P/A )	( H/V )
802.11a CH 36 5180MHz		10360	41.95	-32.05	74	48.3	37.22	16.34	59.91	100	0	P	H
		15540	48.08	-25.92	74	45.26	40.34	20.36	57.88	100	0	P	H
													H
													H
		10360	41.46	-32.54	74	47.81	37.22	16.34	59.91	100	0	P	V
		15540	47.52	-26.48	74	44.7	40.34	20.36	57.88	100	0	P	V
													V
													V
802.11a CH 44 5220MHz		10440	41.8	-32.2	74	47.98	37.26	16.41	59.85	100	0	P	H
		15660	46.44	-27.56	74	43.35	40.49	20.41	57.81	100	0	P	H
													H
													H
		10440	41.41	-32.59	74	47.59	37.26	16.41	59.85	100	0	P	V
		15660	46.93	-27.07	74	43.84	40.49	20.41	57.81	100	0	P	V
													V
													V
802.11a CH 48 5240MHz		10480	42.51	-31.49	74	48.58	37.29	16.45	59.81	100	0	P	H
		15720	47.73	-26.27	74	44.48	40.57	20.45	57.77	100	0	P	H
													H
													H
		10480	41.88	-32.12	74	47.95	37.29	16.45	59.81	100	0	P	V
		15720	47.65	-26.35	74	44.4	40.57	20.45	57.77	100	0	P	V
													V
													V
Remark	1. No other spurious found. 2. All results are PASS against Peak and Average limit line.												





15E Band 1 5150~5250MHz

WIFI 802.11n HT20 (Band Edge @ 3m)

WIFI	Note	Frequency	Level	Over	Limit	Read	Antenna	Cable	Preamp	Ant	Table	Peak	Pol.	
Ant.				Limit	Line	Level	Factor	Loss	Factor	Pos	Pos	Avg.		
1+2		( MHz )	( dBμV/m )	( dB )	( dBμV/m )	( dBμV )	( dB/m )	( dB )	( dB )	( cm )	( deg )	( P/A )	( H/V )	
802.11n HT20 CH 36 5180MHz		5001.8	57.44	-16.56	74	43.96	34.4	11.37	32.29	227	300	P	H	
		5150	43.35	-10.65	54	29.68	34.61	11.55	32.49	227	300	A	H	
	*	5180	100.4	-	-	86.71	34.66	11.55	32.52	227	300	P	H	
	*	5180	87.61	-	-	73.92	34.66	11.55	32.52	227	300	A	H	
													H	
													H	
802.11n HT20 CH 44 5220MHz		5048.45	57.08	-16.92	74	43.55	34.47	11.41	32.35	100	302	P	H	
		5149.1	43.1	-10.9	54	29.43	34.61	11.55	32.49	100	302	A	H	
	*	5220	100.2	-	-	86.46	34.7	11.59	32.55	100	302	P	H	
	*	5220	86.62	-	-	72.88	34.7	11.59	32.55	100	302	A	H	



<b>802.11n</b> <b>HT20</b> <b>CH 48</b> <b>5240MHz</b>		5031.2	57.88	-16.12	74	44.34	34.45	11.41	32.32	131	350	P	H
		5149.7	43.12	-10.88	54	29.45	34.61	11.55	32.49	131	350	A	H
	*	5240	103.11	-	-	89.41	34.73	11.62	32.65	131	350	P	H
	*	5240	89.8	-	-	76.1	34.73	11.62	32.65	131	350	A	H
		5439.32	57.57	-16.43	74	44.24	35.01	11.8	33.48	131	350	P	H
		5397.63	43.32	-10.68	54	29.9	34.96	11.74	33.28	131	350	A	H
		5130.8	57.82	-16.18	74	44.18	34.59	11.5	32.45	120	344	P	V
		5145.65	43.09	-10.91	54	29.42	34.61	11.55	32.49	120	344	A	V
	*	5240	103.29	-	-	89.59	34.73	11.62	32.65	120	344	P	V
	*	5240	90.03	-	-	76.33	34.73	11.62	32.65	120	344	A	V
		5381.35	57.89	-16.11	74	44.49	34.94	11.74	33.28	120	344	P	V
		5391.47	43.33	-10.67	54	29.93	34.94	11.74	33.28	120	344	A	V
<b>Remark</b>	1. No other spurious found. 2. All results are PASS against Peak and Average limit line.												



15E Band 1 5150~5250MHz

WIFI 802.11n HT20 (Harmonic @ 3m)

WIFI	Note	Frequency	Level	Over	Limit	Read	Antenna	Cable	Preamp	Ant	Table	Peak	Pol.
Ant.				Limit	Line	Level	Factor	Loss	Factor	Pos	Pos	Avg.	
1+2		( MHz )	( dBμV/m )	( dB )	( dBμV/m )	(dBμV)	( dB/m )	( dB )	( dB )	( cm )	( deg )	(P/A)	(H/V)
802.11n HT20 CH 36 5180MHz		10360	41.39	-32.61	74	47.74	37.22	16.34	59.91	100	0	P	H
		15540	47.3	-26.7	74	44.48	40.34	20.36	57.88	100	0	P	H
													H
													H
		10360	41.02	-32.98	74	47.37	37.22	16.34	59.91	100	0	P	V
		15540	47.26	-26.74	74	44.44	40.34	20.36	57.88	100	0	P	V
													V
802.11n HT20 CH 44 5220MHz		10440	41.96	-32.04	74	48.14	37.26	16.41	59.85	100	0	P	H
		15660	46.95	-27.05	74	43.86	40.49	20.41	57.81	100	0	P	H
													H
													H
		10440	40.58	-33.42	74	46.76	37.26	16.41	59.85	100	0	P	V
		15660	47.34	-26.66	74	44.25	40.49	20.41	57.81	100	0	P	V
													V
802.11n HT20 CH 48 5240MHz		10480	42.88	-31.12	74	48.95	37.29	16.45	59.81	100	0	P	H
		15720	48.47	-25.53	74	45.22	40.57	20.45	57.77	100	0	P	H
													H
													H
		10480	41.61	-32.39	74	47.68	37.29	16.45	59.81	100	0	P	V
		15720	48.55	-25.45	74	45.3	40.57	20.45	57.77	100	0	P	V
													V
Remark	1. No other spurious found.												
	2. All results are PASS against Peak and Average limit line.												



15E Band 1 5150~5250MHz

WIFI 802.11n HT40 (Band Edge @ 3m)

WIFI	Note	Frequency	Level	Over	Limit	Read	Antenna	Cable	Preamp	Ant	Table	Peak	Pol.
Ant.				Limit	Line	Level	Factor	Loss	Factor	Pos	Pos	Avg.	
1+2		( MHz )	( dBμV/m )	( dB )	( dBμV/m )	( dBμV )	( dB/m )	( dB )	( dB )	( cm )	( deg )	( P/A )	( H/V )
802.11n HT40 CH 38 5190MHz		5147.3	59.61	-14.39	74	45.94	34.61	11.55	32.49	160	303	P	H
		5149.85	46.76	-7.24	54	33.09	34.61	11.55	32.49	160	303	A	H
	*	5190	97.76	-	-	84.03	34.66	11.59	32.52	160	303	P	H
	*	5190	86.9	-	-	73.17	34.66	11.59	32.52	160	303	A	H
		5451.31	57.61	-16.39	74	44.35	35.03	11.8	33.57	160	303	P	H
		5374.09	44.58	-9.42	54	31.24	34.91	11.71	33.28	160	303	A	H
		5143.7	60.89	-13.11	74	47.18	34.61	11.55	32.45	139	342	P	V
		5149.7	47.62	-6.38	54	33.95	34.61	11.55	32.49	139	342	A	V
	*	5190	99.45	-	-	85.72	34.66	11.59	32.52	139	342	P	V
	*	5190	88.85	-	-	75.12	34.66	11.59	32.52	139	342	A	V
		5377.17	58.64	-15.36	74	45.3	34.91	11.71	33.28	139	342	P	V
		5396.42	44.63	-9.37	54	31.21	34.96	11.74	33.28	139	342	A	V
802.11n HT40 CH 46 5230MHz		5003.45	57.4	-16.6	74	43.92	34.4	11.37	32.29	143	342	P	H
		5149.55	44.28	-9.72	54	30.61	34.61	11.55	32.49	143	342	A	H
	*	5230	96.91	-	-	83.21	34.73	11.62	32.65	143	342	P	H
	*	5230	86.65	-	-	72.95	34.73	11.62	32.65	143	342	A	H
		5382.78	57.57	-16.43	74	44.17	34.94	11.74	33.28	143	342	P	H
		5379.48	44.7	-9.3	54	31.33	34.94	11.71	33.28	143	342	A	H
		5146.55	56.95	-17.05	74	43.28	34.61	11.55	32.49	153	352	P	V
		5130.65	44.45	-9.55	54	30.81	34.59	11.5	32.45	153	352	A	V
	*	5230	100.3	-	-	86.6	34.73	11.62	32.65	153	352	P	V
	*	5230	89.5	-	-	75.8	34.73	11.62	32.65	153	352	A	V
		5376.18	57.43	-16.57	74	44.09	34.91	11.71	33.28	153	352	P	V
		5385.31	44.66	-9.34	54	31.26	34.94	11.74	33.28	153	352	A	V
Remark	1. No other spurious found. 2. All results are PASS against Peak and Average limit line.												



15E Band 1 5150~5250MHz

WIFI 802.11n HT40 (Harmonic @ 3m)

WIFI	Note	Frequency	Level	Over	Limit	Read	Antenna	Cable	Preamp	Ant	Table	Peak	Pol.
Ant.				Limit	Line	Level	Factor	Loss	Factor	Pos	Pos	Avg.	
1+2		( MHz )	( dBμV/m )	( dB )	( dBμV/m )	( dBμV )	( dB/m )	( dB )	( dB )	( cm )	( deg )	( P/A )	( H/V )
802.11n HT40 CH 38 5190MHz		10380	41.89	-32.11	74	48.21	37.23	16.34	59.89	100	0	P	H
		15570	47.54	-26.46	74	44.64	40.38	20.38	57.86	100	0	P	H
													H
													H
		10380	41.91	-32.09	74	48.23	37.23	16.34	59.89	100	0	P	V
		15570	47.49	-26.51	74	44.59	40.38	20.38	57.86	100	0	P	V
													V
802.11n HT40 CH 46 5230MHz		10460	41.76	-32.24	74	47.92	37.27	16.41	59.84	100	0	P	H
		15690	48.04	-25.96	74	44.87	40.53	20.43	57.79	100	0	P	H
													H
													H
		10460	41.51	-32.49	74	47.67	37.27	16.41	59.84	100	0	P	V
		15690	47.71	-26.29	74	44.54	40.53	20.43	57.79	100	0	P	V
													V
Remark	1. No other spurious found.												
	2. All results are PASS against Peak and Average limit line.												



15E Band 1 5150~5250MHz

WIFI 802.11ac VHT80 (Band Edge @ 3m)

WIFI	Note	Frequency	Level	Over	Limit	Read	Antenna	Cable	Preamp	Ant	Table	Peak	Pol.
Ant.				Limit	Line	Level	Factor	Loss	Factor	Pos	Pos	Avg.	
1+2		( MHz )	( dBμV/m )	( dB )	( dBμV/m )	( dBμV )	( dB/m )	( dB )	( dB )	( cm )	( deg )	( P/A )	( H/V )
802.11ac VHT80 CH 42 5210MHz		5140.25	57.69	-16.31	74	43.98	34.61	11.55	32.45	103	354	P	H
		5145.65	45.45	-8.55	54	31.78	34.61	11.55	32.49	103	354	A	H
	*	5210	92.6	-	-	78.86	34.7	11.59	32.55	103	354	P	H
	*	5210	83.71	-	-	69.97	34.7	11.59	32.55	103	354	A	H
		5373.21	57.4	-16.6	74	43.96	34.91	11.71	33.18	103	354	P	H
		5373.21	45.12	-8.88	54	31.68	34.91	11.71	33.18	103	354	A	H
		5144.15	60.07	-13.93	74	46.4	34.61	11.55	32.49	133	352	P	V
		5145.65	47.61	-6.39	54	33.94	34.61	11.55	32.49	133	352	A	V
	*	5210	97.59	-	-	83.85	34.7	11.59	32.55	133	352	P	V
	*	5210	85.8	-	-	72.06	34.7	11.59	32.55	133	352	A	V
		5364.41	57.94	-16.06	74	44.5	34.91	11.71	33.18	133	352	P	V
	5355.39	45.02	-8.98	54	31.6	34.89	11.71	33.18	133	352	A	V	
Remark	1. No other spurious found. 2. All results are PASS against Peak and Average limit line.												

15E Band 1 5150~5250MHz

WIFI 802.11ac VHT80 (Harmonic @ 3m)

WIFI	Note	Frequency	Level	Over	Limit	Read	Antenna	Cable	Preamp	Ant	Table	Peak	Pol.
Ant.				Limit	Line	Level	Factor	Loss	Factor	Pos	Pos	Avg.	
1+2		( MHz )	( dBμV/m )	( dB )	( dBμV/m )	( dBμV )	( dB/m )	( dB )	( dB )	( cm )	( deg )	( P/A )	( H/V )
802.11ac VHT80 CH 42 5210MHz		10420	41.2	-32.8	74	47.45	37.25	16.37	59.87	100	0	P	H
		15630	46.78	-27.22	74	43.72	40.47	20.41	57.82	100	0	P	H
													H
													H
		10420	42.07	-31.93	74	48.32	37.25	16.37	59.87	100	0	P	V
		15630	46.09	-27.91	74	43.03	40.47	20.41	57.82	100	0	P	V
													V
												V	
Remark	1. No other spurious found. 2. All results are PASS against Peak and Average limit line.												



15E Band 2 - 5250~5350MHz

WIFI 802.11a (Band Edge @ 3m)

WIFI	Note	Frequency	Level	Over	Limit	Read	Antenna	Cable	Preamp	Ant	Table	Peak	Pol.
Ant.				Limit	Line	Level	Factor	Loss	Factor	Pos	Pos	Avg.	
1+2		( MHz )	( dBµV/m )	( dB )	( dBµV/m )	( dBµV )	( dB/m )	( dB )	( dB )	( cm )	( deg )	( P/A )	( H/V )
802.11a CH 52 5260MHz		5144.75	57.31	-16.69	74	43.64	34.61	11.55	32.49	125	308	P	H
		5149.1	43.13	-10.87	54	29.46	34.61	11.55	32.49	125	308	A	H
	*	5260	100.61	-	-	86.98	34.77	11.62	32.76	125	308	P	H
	*	5260	90.13	-	-	76.5	34.77	11.62	32.76	125	308	A	H
		5356.27	57.23	-16.77	74	43.81	34.89	11.71	33.18	125	308	P	H
		5393.12	43.38	-10.62	54	29.98	34.94	11.74	33.28	125	308	A	H
		5130.95	57.29	-16.71	74	43.65	34.59	11.5	32.45	135	340	P	V
		5149.1	43.16	-10.84	54	29.49	34.61	11.55	32.49	135	340	A	V
	*	5260	102.77	-	-	89.14	34.77	11.62	32.76	135	340	P	V
	*	5260	92.11	-	-	78.48	34.77	11.62	32.76	135	340	A	V
		5431.51	57.46	-16.54	74	44.13	35.01	11.8	33.48	135	340	P	V
		5392.24	43.41	-10.59	54	30.01	34.94	11.74	33.28	135	340	A	V
802.11a CH 60 5300MHz		5149.7	57.78	-16.22	74	44.11	34.61	11.55	32.49	120	352	P	H
		5150	43.09	-10.91	54	29.42	34.61	11.55	32.49	120	352	A	H
	*	5300	100.9	-	-	87.4	34.82	11.65	32.97	120	352	P	H
	*	5300	90.55	-	-	77.05	34.82	11.65	32.97	120	352	A	H
		5372.11	57.54	-16.46	74	44.1	34.91	11.71	33.18	120	352	P	H
		5385.86	43.41	-10.59	54	30.01	34.94	11.74	33.28	120	352	A	H
		5130.2	57.49	-16.51	74	43.85	34.59	11.5	32.45	122	344	P	V
		5149.7	43.15	-10.85	54	29.48	34.61	11.55	32.49	122	344	A	V
	*	5299	101.76	-	-	88.26	34.82	11.65	32.97	122	344	P	V
	*	5299	91.44	-	-	77.94	34.82	11.65	32.97	122	344	A	V
		5391.58	57.52	-16.48	74	44.12	34.94	11.74	33.28	122	344	P	V
		5350.11	43.46	-10.54	54	30.04	34.89	11.71	33.18	122	344	A	V



<b>802.11a</b> <b>CH 64</b> <b>5320MHz</b>	*	5320	101.82	-	-	88.27	34.84	11.68	32.97	136	359	P	H
	*	5320	91.56	-	-	78.01	34.84	11.68	32.97	136	359	A	H
		5378.93	58.1	-15.9	74	44.73	34.94	11.71	33.28	136	359	P	H
		5368.81	43.48	-10.52	54	30.04	34.91	11.71	33.18	136	359	A	H
													H
													H
	*	5320	102.54	-	-	88.99	34.84	11.68	32.97	118	340	P	V
	*	5320	91.88	-	-	78.33	34.84	11.68	32.97	118	340	A	V
		5403.9	57.6	-16.4	74	44.29	34.96	11.74	33.39	118	340	P	V
		5369.03	43.56	-10.44	54	30.12	34.91	11.71	33.18	118	340	A	V
													V
													V
<b>Remark</b>	1. No other spurious found. 2. All results are PASS against Peak and Average limit line.												





15E Band 2 5250~5350MHz

WIFI 802.11a (Harmonic @ 3m)

WIFI	Note	Frequency	Level	Over	Limit	Read	Antenna	Cable	Preamp	Ant	Table	Peak	Pol.
Ant.				Limit	Line	Level	Factor	Loss	Factor	Pos	Pos	Avg.	
1+2		( MHz )	( dBµV/m )	( dB )	( dBµV/m )	( dBµV )	( dB/m )	( dB )	( dB )	( cm )	( deg )	( P/A )	( H/V )
802.11a CH 52 5260MHz		10520	42.63	-31.37	74	48.6	37.32	16.49	59.78	100	0	P	H
		15780	48	-26	74	44.64	40.63	20.46	57.73	100	0	P	H
													H
													H
		10520	41.57	-32.43	74	47.54	37.32	16.49	59.78	100	0	P	V
		15780	48.69	-25.31	74	45.33	40.63	20.46	57.73	100	0	P	V
													V
													V
802.11a CH 60 5300MHz		10600	41.75	-32.25	74	47.43	37.42	16.56	59.66	100	0	P	H
		15900	47.81	-26.19	74	44.17	40.78	20.52	57.66	100	0	P	H
													H
													H
		10600	41.23	-32.77	74	46.91	37.42	16.56	59.66	100	0	P	V
		15900	47.28	-26.72	74	43.64	40.78	20.52	57.66	100	0	P	V
													V
													V
802.11a CH 64 5320MHz		10640	42.03	-31.97	74	47.57	37.47	16.6	59.61	100	0	P	H
		15960	47.82	-26.18	74	44.03	40.86	20.55	57.62	100	0	P	H
													H
													H
		10640	41.14	-32.86	74	46.68	37.47	16.6	59.61	100	0	P	V
		15960	47.16	-26.84	74	43.37	40.86	20.55	57.62	100	0	P	V
													V
													V
Remark	1. No other spurious found. 2. All results are PASS against Peak and Average limit line.												



15E Band 2 5250~5350MHz

WIFI 802.11n HT20 (Band Edge @ 3m)

WIFI	Note	Frequency	Level	Over	Limit	Read	Antenna	Cable	Preamp	Ant	Table	Peak	Pol.
Ant.				Limit	Line	Level	Factor	Loss	Factor	Pos	Pos	Avg.	
1+2		( MHz )	( dBµV/m )	( dB )	( dBµV/m )	( dBµV )	( dB/m )	( dB )	( dB )	( cm )	( deg )	( P/A )	( H/V )
802.11n HT20 CH 52 5260MHz		5111.15	57.19	-16.81	74	43.55	34.56	11.5	32.42	131	310	P	H
		5150	43.03	-10.97	54	29.36	34.61	11.55	32.49	131	310	A	H
	*	5260	100.14	-	-	86.51	34.77	11.62	32.76	131	310	P	H
	*	5260	86.94	-	-	73.31	34.77	11.62	32.76	131	310	A	H
		5401.92	57.17	-16.83	74	43.86	34.96	11.74	33.39	131	310	P	H
		5396.42	43.31	-10.69	54	29.89	34.96	11.74	33.28	131	310	A	H
		5062.4	57.57	-16.43	74	43.97	34.49	11.46	32.35	203	344	P	V
		5149.55	43.04	-10.96	54	29.37	34.61	11.55	32.49	203	344	A	V
	*	5260	102.54	-	-	88.91	34.77	11.62	32.76	203	344	P	V
	*	5260	89.35	-	-	75.72	34.77	11.62	32.76	203	344	A	V
		5408.41	57.82	-16.18	74	44.51	34.96	11.74	33.39	203	344	P	V
		5384.76	43.34	-10.66	54	29.94	34.94	11.74	33.28	203	344	A	V
802.11n HT20 CH 60 5300MHz		5141.15	57.58	-16.42	74	43.87	34.61	11.55	32.45	138	310	P	H
		5147.3	43.02	-10.98	54	29.35	34.61	11.55	32.49	138	310	A	H
	*	5300	100.55	-	-	87.05	34.82	11.65	32.97	138	310	P	H
	*	5300	87.32	-	-	73.82	34.82	11.65	32.97	138	310	A	H
		5406.76	57.46	-16.54	74	44.15	34.96	11.74	33.39	138	310	P	H
		5385.2	43.33	-10.67	54	29.93	34.94	11.74	33.28	138	310	A	H
		5095.1	57.48	-16.52	74	43.9	34.54	11.46	32.42	202	350	P	V
		5144.6	43.06	-10.94	54	29.39	34.61	11.55	32.49	202	350	A	V
	*	5300	101.86	-	-	88.36	34.82	11.65	32.97	202	350	P	V
	*	5300	88.61	-	-	75.11	34.82	11.65	32.97	202	350	A	V
		5382.12	57.22	-16.78	74	43.82	34.94	11.74	33.28	202	350	P	V
		5350.22	43.37	-10.63	54	29.95	34.89	11.71	33.18	202	350	A	V



<b>802.11n HT20 CH 64 5320MHz</b>	*	5320	100.6	-	-	87.05	34.84	11.68	32.97	100	303	P	H
	*	5320	90.06	-	-	76.51	34.84	11.68	32.97	100	303	A	H
		5425.13	57.09	-16.91	74	43.79	34.98	11.8	33.48	100	303	P	H
		5368.7	43.41	-10.59	54	29.97	34.91	11.71	33.18	100	303	A	H
													H
													H
	*	5320	101.35	-	-	87.8	34.84	11.68	32.97	158	343	P	V
	*	5320	90.64	-	-	77.09	34.84	11.68	32.97	158	343	A	V
		5390.48	57.38	-16.62	74	43.98	34.94	11.74	33.28	158	343	P	V
		5350.66	43.48	-10.52	54	30.06	34.89	11.71	33.18	158	343	A	V
												V	
												V	
<b>Remark</b>	1. No other spurious found. 2. All results are PASS against Peak and Average limit line.												



15E Band 2 5250~5350MHz

WIFI 802.11n HT20 (Harmonic @ 3m)

WIFI	Note	Frequency	Level	Over	Limit	Read	Antenna	Cable	Preamp	Ant	Table	Peak	Pol.
Ant.				Limit	Line	Level	Factor	Loss	Factor	Pos	Pos	Avg.	
1+2		( MHz )	( dBµV/m )	( dB )	( dBµV/m )	(dBµV)	( dB/m )	( dB )	( dB )	( cm )	( deg )	(P/A)	(H/V)
802.11n HT20 CH 52 5260MHz		10520	42.86	-31.14	74	48.83	37.32	16.49	59.78	100	0	P	H
		15780	48.38	-25.62	74	45.02	40.63	20.46	57.73	100	0	P	H
													H
													H
		10520	43.13	-30.87	74	49.1	37.32	16.49	59.78	100	0	P	V
		15780	47.61	-26.39	74	44.25	40.63	20.46	57.73	100	0	P	V
													V
802.11n HT20 CH 60 5300MHz		10600	40.82	-33.18	74	46.5	37.42	16.56	59.66	100	0	P	H
		15900	48.05	-25.95	74	44.41	40.78	20.52	57.66	100	0	P	H
													H
													H
		10600	41.79	-32.21	74	47.47	37.42	16.56	59.66	100	0	P	V
		15900	47.74	-26.26	74	44.1	40.78	20.52	57.66	100	0	P	V
													V
802.11n HT20 CH 64 5320MHz		10640	42.6	-31.4	74	48.14	37.47	16.6	59.61	100	0	P	H
		15960	48.06	-25.94	74	44.27	40.86	20.55	57.62	100	0	P	H
													H
													H
		10640	41.98	-32.02	74	47.52	37.47	16.6	59.61	100	0	P	V
		15960	48.15	-25.85	74	44.36	40.86	20.55	57.62	100	0	P	V
													V
Remark	1. No other spurious found.												
	2. All results are PASS against Peak and Average limit line.												



15E Band 2 5250~5350MHz

WIFI 802.11n HT40 (Band Edge @ 3m)

WIFI	Note	Frequency	Level	Over	Limit	Read	Antenna	Cable	Preamp	Ant	Table	Peak	Pol.
Ant.				Limit	Line	Level	Factor	Loss	Factor	Pos	Pos	Avg.	
1+2		( MHz )	( dBμV/m )	( dB )	( dBμV/m )	( dBμV )	( dB/m )	( dB )	( dB )	( cm )	( deg )	( P/A )	( H/V )
802.11n HT40 CH 54 5270MHz		5006.15	57.56	-16.44	74	44.06	34.42	11.37	32.29	134	356	P	H
		5144.15	44.49	-9.51	54	30.82	34.61	11.55	32.49	134	356	A	H
	*	5270	96.61	-	-	82.95	34.77	11.65	32.76	134	356	P	H
	*	5270	85.96	-	-	72.3	34.77	11.65	32.76	134	356	A	H
		5371.34	57.65	-16.35	74	44.21	34.91	11.71	33.18	134	356	P	H
		5395.43	44.68	-9.32	54	31.26	34.96	11.74	33.28	134	356	A	H
		5052.65	57.48	-16.52	74	43.95	34.47	11.41	32.35	154	346	P	V
		5132	44.44	-9.56	54	30.8	34.59	11.5	32.45	154	346	A	V
	*	5270	99.54	-	-	85.88	34.77	11.65	32.76	154	346	P	V
	*	5270	89.11	-	-	75.45	34.77	11.65	32.76	154	346	A	V
		5429.53	57.67	-16.33	74	44.34	35.01	11.8	33.48	154	346	P	V
		5396.31	44.62	-9.38	54	31.2	34.96	11.74	33.28	154	346	A	V
802.11n HT40 CH 62 5310MHz		5042.3	57.81	-16.19	74	44.28	34.47	11.41	32.35	151	307	P	H
		5149.7	44.25	-9.75	54	30.58	34.61	11.55	32.49	151	307	A	H
	*	5310	97.55	-	-	84	34.84	11.68	32.97	151	307	P	H
	*	5310	86.74	-	-	73.19	34.84	11.68	32.97	151	307	A	H
		5366.94	57.84	-16.16	74	44.4	34.91	11.71	33.18	151	307	P	H
		5350.99	45.42	-8.58	54	32	34.89	11.71	33.18	151	307	A	H
		5079.05	57.1	-16.9	74	43.51	34.52	11.46	32.39	134	351	P	V
		5146.7	44.27	-9.73	54	30.6	34.61	11.55	32.49	134	351	A	V
	*	5310	98.56	-	-	85.01	34.84	11.68	32.97	134	351	P	V
	*	5310	88.13	-	-	74.58	34.84	11.68	32.97	134	351	A	V
		5350.88	58.18	-15.82	74	44.76	34.89	11.71	33.18	134	351	P	V
		5352.09	46.04	-7.96	54	32.62	34.89	11.71	33.18	134	351	A	V
Remark	1. No other spurious found. 2. All results are PASS against Peak and Average limit line.												



15E Band 2 5250~5350MHz

WIFI 802.11n HT40 (Harmonic @ 3m)

WIFI	Note	Frequency	Level	Over	Limit	Read	Antenna	Cable	Preamp	Ant	Table	Peak	Pol.
Ant.				Limit	Line	Level	Factor	Loss	Factor	Pos	Pos	Avg.	
1+2		( MHz )	( dBμV/m )	( dB )	( dBμV/m )	( dBμV )	( dB/m )	( dB )	( dB )	( cm )	( deg )	( P/A )	( H/V )
802.11n HT40 CH 54 5270MHz		10540	41.63	-32.37	74	47.55	37.34	16.49	59.75	100	0	P	H
		15810	47.42	-26.58	74	43.98	40.67	20.48	57.71	100	0	P	H
													H
													H
		10540	41.84	-32.16	74	47.76	37.34	16.49	59.75	100	0	P	V
		15810	49.13	-24.87	74	45.69	40.67	20.48	57.71	100	0	P	V
													V
802.11n HT40 CH 62 5310MHz		10620	42.28	-31.72	74	47.91	37.44	16.56	59.63	100	0	P	H
		15930	47.59	-26.41	74	43.88	40.82	20.53	57.64	100	0	P	H
													H
													H
		10620	41.4	-32.6	74	47.03	37.44	16.56	59.63	100	0	P	V
		15930	47.07	-26.93	74	43.36	40.82	20.53	57.64	100	0	P	V
													V
Remark	1. No other spurious found.												
	2. All results are PASS against Peak and Average limit line.												



15E Band 2 5250~5350MHz

WIFI 802.11ac VHT80 (Band Edge @ 3m)

WIFI	Note	Frequency	Level	Over	Limit	Read	Antenna	Cable	Preamp	Ant	Table	Peak	Pol.
Ant.				Limit	Line	Level	Factor	Loss	Factor	Pos	Pos	Avg.	
1+2		( MHz )	( dBμV/m )	( dB )	( dBμV/m )	( dBμV )	( dB/m )	( dB )	( dB )	( cm )	( deg )	( P/A )	( H/V )
802.11ac VHT80 CH 58 5290MHz		5136.5	56.96	-17.04	74	43.32	34.59	11.5	32.45	118	0	P	H
		5143.55	44.67	-9.33	54	30.96	34.61	11.55	32.45	118	0	A	H
	*	5290	94.29	-	-	80.7	34.8	11.65	32.86	118	0	P	H
	*	5290	84.26	-	-	70.67	34.8	11.65	32.86	118	0	A	H
		5362.21	57.86	-16.14	74	44.42	34.91	11.71	33.18	118	0	P	H
		5351.21	46.3	-7.7	54	32.88	34.89	11.71	33.18	118	0	A	H
		5093.6	57.12	-16.88	74	43.54	34.54	11.46	32.42	120	346	P	V
		5129	44.61	-9.39	54	30.97	34.59	11.5	32.45	120	346	A	V
	*	5290	96.57	-	-	82.98	34.8	11.65	32.86	120	346	P	V
	*	5290	85.68	-	-	72.09	34.8	11.65	32.86	120	346	A	V
		5350.44	58.75	-15.25	74	45.33	34.89	11.71	33.18	120	346	P	V
		5354.29	46.46	-7.54	54	33.04	34.89	11.71	33.18	120	346	A	V
Remark	1. No other spurious found. 2. All results are PASS against Peak and Average limit line.												

15E Band 2 5250~5350MHz

WIFI 802.11ac VHT80 (Harmonic @ 3m)

WIFI	Note	Frequency	Level	Over	Limit	Read	Antenna	Cable	Preamp	Ant	Table	Peak	Pol.	
Ant.				Limit	Line	Level	Factor	Loss	Factor	Pos	Pos	Avg.		
1+2		( MHz )	( dBμV/m )	( dB )	( dBμV/m )	( dBμV )	( dB/m )	( dB )	( dB )	( cm )	( deg )	( P/A )	( H/V )	
802.11ac VHT80 CH 58 5290MHz		10580	41.56	-32.44	74	47.32	37.4	16.52	59.68	100	0	P	H	
		15870	47.7	-26.3	74	44.09	40.76	20.52	57.67	100	0	P	H	
													H	
														H
		10580	42.31	-31.69	74	48.07	37.4	16.52	59.68	100	0	P	V	
		15870	47.95	-26.05	74	44.34	40.76	20.52	57.67	100	0	P	V	
														V
														V
Remark	1. No other spurious found. 2. All results are PASS against Peak and Average limit line.													



15E Band 3 - 5470~5725MHz

WIFI 802.11a (Band Edge @ 3m)

WIFI	Note	Frequency	Level	Over	Limit	Read	Antenna	Cable	Preamp	Ant	Table	Peak	Pol.	
Ant.				Limit	Line	Level	Factor	Loss	Factor	Pos	Pos	Avg.		
1+2		( MHz )	( dBµV/m )	( dB )	( dBµV/m )	( dBµV )	( dB/m )	( dB )	( dB )	( cm )	( deg )	( P/A )	( H/V )	
802.11a CH 100 5500MHz		5444.72	57.08	-16.92	74	43.75	35.01	11.8	33.48	159	349	P	H	
		5385.2	43.44	-10.56	54	30.04	34.94	11.74	33.28	159	349	A	H	
	*	5502	102.14	-	-	88.86	35.1	11.92	33.74	159	349	P	H	
	*	5502	92.45	-	-	79.17	35.1	11.92	33.74	159	349	A	H	
													H	
													H	
			5421.2	57.2	-16.8	74	43.81	34.98	11.8	33.39	132	360	P	V
			5404.08	43.4	-10.6	54	30.09	34.96	11.74	33.39	132	360	A	V
	*		5500	100.17	-	-	86.87	35.1	11.86	33.66	132	360	P	V
	*		5500	89.64	-	-	76.34	35.1	11.86	33.66	132	360	A	V
													V	
													V	
802.11a CH 116 5580MHz		5409.52	57.61	-16.39	74	44.3	34.96	11.74	33.39	204	48	P	H	
		5395.44	43.37	-10.63	54	29.95	34.96	11.74	33.28	204	48	A	H	
	*	5580	102.76	-	-	89.65	35.14	11.98	34.01	204	48	P	H	
	*	5580	92.14	-	-	79.03	35.14	11.98	34.01	204	48	A	H	
			5743.16	57.31	-16.69	74	43.91	35.24	12.33	34.17	204	48	P	H
			5761.8	43.1	-10.9	54	29.71	35.26	12.33	34.2	204	48	A	H
			5401.52	57.65	-16.35	74	44.34	34.96	11.74	33.39	164	3	P	V
			5391.92	43.37	-10.63	54	29.97	34.94	11.74	33.28	164	3	A	V
	*		5580	100.98	-	-	87.87	35.14	11.98	34.01	164	3	P	V
	*		5580	90.68	-	-	77.57	35.14	11.98	34.01	164	3	A	V
			5726.44	58.01	-15.99	74	44.67	35.23	12.26	34.15	164	3	P	V
			5756.68	43.08	-10.92	54	29.69	35.26	12.33	34.2	164	3	A	V





<b>802.11a</b> <b>CH 140</b> <b>5700MHz</b>	*	5700	103.69	-	-	90.42	35.21	12.18	34.12	250	51	P	H
	*	5700	92.59	-	-	79.32	35.21	12.18	34.12	250	51	A	H
		5726.36	58	-16	74	44.66	35.23	12.26	34.15	250	51	P	H
		5725.08	43.67	-10.33	54	30.33	35.23	12.26	34.15	250	51	A	H
													H
													H
	*	5700	102.96	-	-	89.69	35.21	12.18	34.12	252	14	P	V
	*	5700	91.54	-	-	78.27	35.21	12.18	34.12	252	14	A	V
		5747.64	57.95	-16.05	74	44.55	35.24	12.33	34.17	252	14	P	V
		5725.08	43.43	-10.57	54	30.09	35.23	12.26	34.15	252	14	A	V
													V
													V
<b>Remark</b>	1. No other spurious found. 2. All results are PASS against Peak and Average limit line.												



15E Band 3 - 5470~5725MHz

WIFI 802.11a (Harmonic @ 3m)

WIFI	Note	Frequency	Level	Over	Limit	Read	Antenna	Cable	Preamp	Ant	Table	Peak	Pol.
Ant.				Limit	Line	Level	Factor	Loss	Factor	Pos	Pos	Avg.	
1+2		( MHz )	( dBμV/m )	( dB )	( dBμV/m )	( dBμV )	( dB/m )	( dB )	( dB )	( cm )	( deg )	( P/A )	( H/V )
802.11a CH 100 5500MHz		11000	43.41	-30.59	74	47.67	37.9	16.94	59.1	100	0	P	H
		16500	49.15	-24.85	74	43.67	41.4	20.88	56.8	100	0	P	H
													H
													H
		11000	43.35	-30.65	74	47.61	37.9	16.94	59.1	100	0	P	V
		16500	48.93	-25.07	74	43.45	41.4	20.88	56.8	100	0	P	V
													V
													V
802.11a CH 116 5580MHz		11160	43.91	-30.09	74	47.5	38	17.08	58.67	100	0	P	H
		16740	49.55	-24.45	74	43.24	41.88	21.04	56.61	100	0	P	H
													H
													H
		11160	43.41	-30.59	74	47	38	17.08	58.67	100	0	P	V
		16740	49.02	-24.98	74	42.71	41.88	21.04	56.61	100	0	P	V
													V
													V
802.11a CH 140 5700MHz		11400	44.77	-29.23	74	47.38	38.14	17.31	58.06	100	0	P	H
		17100	49.86	-24.14	74	42.73	42.32	21.27	56.46	100	0	P	H
													H
													H
		11400	43.38	-30.62	74	45.99	38.14	17.31	58.06	100	0	P	V
		17100	50.24	-23.76	74	43.11	42.32	21.27	56.46	100	0	P	V
													V
													V
Remark	1. No other spurious found. 2. All results are PASS against Peak and Average limit line.												



15E Band 3 - 5470~5725MHz

WIFI 802.11n HT20 (Band Edge @ 3m)

WIFI	Note	Frequency	Level	Over	Limit	Read	Antenna	Cable	Preamp	Ant	Table	Peak	Pol.	
Ant.				Limit	Line	Level	Factor	Loss	Factor	Pos	Pos	Avg.		
1+2		( MHz )	( dBμV/m )	( dB )	( dBμV/m )	( dBμV )	( dB/m )	( dB )	( dB )	( cm )	( deg )	(P/A)	(H/V)	
802.11n HT20 CH 100 5500MHz		5407.28	57.41	-16.59	74	44.1	34.96	11.74	33.39	158	360	P	H	
		5398.16	43.44	-10.56	54	30.02	34.96	11.74	33.28	158	360	A	H	
	*	5502	101.89	-	-	88.61	35.1	11.92	33.74	158	360	P	H	
	*	5502	90.7	-	-	77.42	35.1	11.92	33.74	158	360	A	H	
													H	
														H
			5362.16	57.93	-16.07	74	44.49	34.91	11.71	33.18	165	0	P	V
			5389.36	43.38	-10.62	54	29.98	34.94	11.74	33.28	165	0	A	V
	*		5500	100.35	-	-	87.05	35.1	11.86	33.66	165	0	P	V
	*		5500	89.81	-	-	76.51	35.1	11.86	33.66	165	0	A	V
														V
														V
802.11n HT20 CH 116 5580MHz		5368.88	57.26	-16.74	74	43.82	34.91	11.71	33.18	131	0	P	H	
		5395.44	43.41	-10.59	54	29.99	34.96	11.74	33.28	131	0	A	H	
	*	5582	102.03	-	-	88.85	35.15	12.04	34.01	131	0	P	H	
	*	5582	91.51	-	-	78.33	35.15	12.04	34.01	131	0	A	H	
			5760.68	56.98	-17.02	74	43.59	35.26	12.33	34.2	131	0	P	H
			5765	43.11	-10.89	54	29.72	35.26	12.33	34.2	131	0	A	H
			5376.4	57.9	-16.1	74	44.56	34.91	11.71	33.28	144	360	P	V
			5389.68	43.4	-10.6	54	30	34.94	11.74	33.28	144	360	A	V
	*		5580	100.24	-	-	87.13	35.14	11.98	34.01	144	360	P	V
	*		5580	89.42	-	-	76.31	35.14	11.98	34.01	144	360	A	V
			5761.32	57	-17	74	43.61	35.26	12.33	34.2	144	360	P	V
			5763.32	43.12	-10.88	54	29.73	35.26	12.33	34.2	144	360	A	V



<b>802.11n HT20 CH 140 5700MHz</b>	*	5702	102.65	-	-	89.29	35.22	12.26	34.12	128	356	P	H
	*	5702	92	-	-	78.64	35.22	12.26	34.12	128	356	A	H
		5726.44	58.12	-15.88	74	44.78	35.23	12.26	34.15	128	356	P	H
		5725.08	43.84	-10.16	54	30.5	35.23	12.26	34.15	128	356	A	H
													H
													H
	*	5700	101.74	-	-	88.47	35.21	12.18	34.12	222	12	P	V
	*	5700	91.33	-	-	78.06	35.21	12.18	34.12	222	12	A	V
		5735.72	58.03	-15.97	74	44.7	35.24	12.26	34.17	222	12	P	V
		5725	43.94	-10.06	54	30.6	35.23	12.26	34.15	222	12	A	V
												V	
												V	
<b>Remark</b>	1. No other spurious found. 2. All results are PASS against Peak and Average limit line.												



15E Band 3 - 5470~5725MHz

WIFI 802.11n HT20 (Harmonic @ 3m)

WIFI	Note	Frequency	Level	Over	Limit	Read	Antenna	Cable	Preamp	Ant	Table	Peak	Pol.
Ant.				Limit	Line	Level	Factor	Loss	Factor	Pos	Pos	Avg.	
1+2		( MHz )	( dBµV/m )	( dB )	( dBµV/m )	( dBµV )	( dB/m )	( dB )	( dB )	( cm )	( deg )	( P/A )	( H/V )
802.11n HT20 CH 100 5500MHz		11000	43.84	-30.16	74	48.1	37.9	16.94	59.1	100	0	P	H
		16500	48.95	-25.05	74	43.47	41.4	20.88	56.8	100	0	P	H
													H
													H
		11000	43.37	-30.63	74	47.63	37.9	16.94	59.1	100	0	P	V
		16500	49.02	-24.98	74	43.54	41.4	20.88	56.8	100	0	P	V
													V
802.11n HT20 CH 116 5580MHz		11160	43.26	-30.74	74	46.85	38	17.08	58.67	100	0	P	H
		16740	49.47	-24.53	74	43.16	41.88	21.04	56.61	100	0	P	H
													H
													H
		11160	43.39	-30.61	74	46.98	38	17.08	58.67	100	0	P	V
		16740	48.89	-25.11	74	42.58	41.88	21.04	56.61	100	0	P	V
													V
802.11n HT20 CH 140 5700MHz		11400	43.68	-30.32	74	46.29	38.14	17.31	58.06	100	0	P	H
		17100	50.03	-23.97	74	42.9	42.32	21.27	56.46	100	0	P	H
													H
													H
		11400	43.39	-30.61	74	46	38.14	17.31	58.06	100	0	P	V
		17100	51.03	-22.97	74	43.9	42.32	21.27	56.46	100	0	P	V
													V
Remark	1. No other spurious found.												
	2. All results are PASS against Peak and Average limit line.												



15E Band 3 - 5470~5725MHz

WIFI 802.11n HT40 (Band Edge @ 3m)

WIFI	Note	Frequency	Level	Over	Limit	Read	Antenna	Cable	Preamp	Ant	Table	Peak	Pol.
Ant.				Limit	Line	Level	Factor	Loss	Factor	Pos	Pos	Avg.	
1+2		( MHz )	( dBµV/m )	( dB )	( dBµV/m )	( dBµV )	( dB/m )	( dB )	( dB )	( cm )	( deg )	(P/A)	(H/V)
802.11n HT40 CH 102 5510MHz		5466.8	59.4	-14.6	74	46.06	35.05	11.86	33.57	157	0	P	H
		5469.2	46.92	-7.08	54	33.58	35.05	11.86	33.57	157	0	A	H
	*	5510	98.64	-	-	85.36	35.1	11.92	33.74	157	0	P	H
	*	5510	87.46	-	-	74.18	35.1	11.92	33.74	157	0	A	H
		5757.24	57.13	-16.87	74	43.74	35.26	12.33	34.2	157	0	P	H
		5748.28	44.29	-9.71	54	30.89	35.24	12.33	34.17	157	0	A	H
		5467.12	59.34	-14.66	74	46	35.05	11.86	33.57	151	352	P	V
		5469.52	46.71	-7.29	54	33.37	35.05	11.86	33.57	151	352	A	V
	*	5510	97.23	-	-	83.95	35.1	11.92	33.74	151	352	P	V
	*	5510	86.74	-	-	73.46	35.1	11.92	33.74	151	352	A	V
		5742.84	57.17	-16.83	74	43.77	35.24	12.33	34.17	151	352	P	V
		5763	44.35	-9.65	54	30.96	35.26	12.33	34.2	151	352	A	V
802.11n HT40 CH 110 5550MHz		5379.12	57.83	-16.17	74	44.46	34.94	11.71	33.28	138	3	P	H
		5387.28	44.56	-9.44	54	31.16	34.94	11.74	33.28	138	3	A	H
	*	5550	98.4	-	-	85.12	35.13	11.98	33.83	138	3	P	H
	*	5550	88.19	-	-	74.91	35.13	11.98	33.83	138	3	A	H
		5751.8	57.29	-16.71	74	43.87	35.26	12.33	34.17	138	3	P	H
		5763.8	44.52	-9.48	54	31.13	35.26	12.33	34.2	138	3	A	H
		5374.64	57.51	-16.49	74	44.17	34.91	11.71	33.28	174	360	P	V
		5369.52	44.6	-9.4	54	31.16	34.91	11.71	33.18	174	360	A	V
	*	5550	97.35	-	-	84.07	35.13	11.98	33.83	174	360	P	V
	*	5550	87.72	-	-	74.44	35.13	11.98	33.83	174	360	A	V
		5762.76	57.25	-16.75	74	43.86	35.26	12.33	34.2	174	360	P	V
		5762.28	44.3	-9.7	54	30.91	35.26	12.33	34.2	174	360	A	V



<b>802.11n</b> <b>HT40</b> <b>CH 134</b> <b>5670MHz</b>		5463.12	57.02	-16.98	74	43.68	35.05	11.86	33.57	108	48	P	H
		5406	44.61	-9.39	54	31.3	34.96	11.74	33.39	108	48	A	H
	*	5670	97.57	-	-	84.28	35.2	12.18	34.09	108	48	P	H
	*	5670	87.32	-	-	74.03	35.2	12.18	34.09	108	48	A	H
		5749.96	57.74	-16.26	74	44.34	35.24	12.33	34.17	108	48	P	H
		5728.44	44.73	-9.27	54	31.39	35.23	12.26	34.15	108	48	A	H
		5377.84	57.5	-16.5	74	44.13	34.94	11.71	33.28	213	15	P	V
		5398	44.64	-9.36	54	31.22	34.96	11.74	33.28	213	15	A	V
	*	5670	98.55	-	-	85.26	35.2	12.18	34.09	213	15	P	V
	*	5670	88.92	-	-	75.63	35.2	12.18	34.09	213	15	A	V
		5763.24	57.17	-16.83	74	43.78	35.26	12.33	34.2	213	15	P	V
	5729.64	44.61	-9.39	54	31.27	35.23	12.26	34.15	213	15	A	V	
<b>Remark</b>	1. No other spurious found. 2. All results are PASS against Peak and Average limit line.												



15E Band 3 - 5470~5725MHz

WIFI 802.11n HT40 (Harmonic @ 3m)

WIFI	Note	Frequency	Level	Over	Limit	Read	Antenna	Cable	Preamp	Ant	Table	Peak	Pol.
Ant.				Limit	Line	Level	Factor	Loss	Factor	Pos	Pos	Avg.	
1+2		( MHz )	( dBµV/m )	( dB )	( dBµV/m )	( dBµV )	( dB/m )	( dB )	( dB )	( cm )	( deg )	(P/A)	(H/V)
802.11n HT40 CH 102 5510MHz		11020	43.9	-30.1	74	48.11	37.91	16.94	59.06	100	0	P	H
		16530	47.61	-26.39	74	42	41.47	20.91	56.77	100	0	P	H
													H
													H
		11020	44.18	-29.82	74	48.39	37.91	16.94	59.06	100	0	P	V
		16530	48.51	-25.49	74	42.9	41.47	20.91	56.77	100	0	P	V
													V
802.11n HT40 CH 110 5550MHz		11100	43.07	-30.93	74	46.94	37.96	17.01	58.84	100	0	P	H
		16650	49.34	-24.66	74	43.32	41.71	20.99	56.68	100	0	P	H
													H
													H
		11100	43.15	-30.85	74	47.02	37.96	17.01	58.84	100	0	P	V
		16650	49.55	-24.45	74	43.53	41.71	20.99	56.68	100	0	P	V
													V
802.11n HT40 CH 134 5670MHz		11340	43.76	-30.24	74	46.66	38.1	17.23	58.23	100	0	P	H
		17010	49.88	-24.12	74	42.68	42.39	21.22	56.41	100	0	P	H
													H
													H
		11340	43.8	-30.2	74	46.7	38.1	17.23	58.23	100	0	P	V
		17010	50.61	-23.39	74	43.41	42.39	21.22	56.41	100	0	P	V
													V
Remark	1. No other spurious found.												
	2. All results are PASS against Peak and Average limit line.												





15E Band 3 5470-5725MHz

WIFI 802.11ac VHT80 (Band Edge @ 3m)

WIFI	Note	Frequency	Level	Over	Limit	Read	Antenna	Cable	Preamp	Ant	Table	Peak	Pol.
Ant.				Limit	Line	Level	Factor	Loss	Factor	Pos	Pos	Avg.	
1+2		( MHz )	( dBμV/m )	( dB )	( dBμV/m )	( dBμV )	( dB/m )	( dB )	( dB )	( cm )	( deg )	( P/A )	( H/V )
802.11ac VHT80 CH 106 5530MHz		5440.56	59.65	-14.35	74	46.32	35.01	11.8	33.48	116	355	P	H
		5469.68	47.54	-6.46	54	34.2	35.05	11.86	33.57	116	355	A	H
	*	5530	95.72	-	-	82.52	35.11	11.92	33.83	116	355	P	H
	*	5530	85.26	-	-	72.06	35.11	11.92	33.83	116	355	A	H
		5739	57.87	-16.13	74	44.54	35.24	12.26	34.17	116	355	P	H
		5763.24	44.8	-9.2	54	31.41	35.26	12.33	34.2	116	355	A	H
		5457.68	58.33	-15.67	74	45.07	35.03	11.8	33.57	129	0	P	V
		5443.44	46.14	-7.86	54	32.81	35.01	11.8	33.48	129	0	A	V
	*	5530	95.18	-	-	81.98	35.11	11.92	33.83	129	0	P	V
	*	5530	84.43	-	-	71.23	35.11	11.92	33.83	129	0	A	V
		5763.08	57.25	-16.75	74	43.86	35.26	12.33	34.2	129	0	P	V
		5733	44.7	-9.3	54	31.38	35.23	12.26	34.17	129	0	A	V
802.11ac VHT80 CH 122 5610MHz		5369.04	58.26	-15.74	74	44.82	34.91	11.71	33.18	204	46	P	H
		5386	44.95	-9.05	54	31.55	34.94	11.74	33.28	204	46	A	H
	*	5610	96.68	-	-	83.52	35.16	12.04	34.04	204	46	P	H
	*	5610	86.12	-	-	72.96	35.16	12.04	34.04	204	46	A	H
		5756.6	58.16	-15.84	74	44.77	35.26	12.33	34.2	204	46	P	H
		5754.04	44.82	-9.18	54	31.4	35.26	12.33	34.17	204	46	A	H
		5383.12	57.36	-16.64	74	43.96	34.94	11.74	33.28	217	2	P	V
		5366	45.07	-8.93	54	31.63	34.91	11.71	33.18	217	2	A	V
	*	5610	94.87	-	-	81.71	35.16	12.04	34.04	217	2	P	V
	*	5610	85.31	-	-	72.15	35.16	12.04	34.04	217	2	A	V
		5761.72	57.16	-16.84	74	43.77	35.26	12.33	34.2	217	2	P	V
		5757.48	44.76	-9.24	54	31.37	35.26	12.33	34.2	217	2	A	V
Remark	1. No other spurious found. 2. All results are PASS against Peak and Average limit line.												



**15E Band 3 5470~5725MHz**

**WIFI 802.11ac VHT80 (Harmonic @ 3m)**

WIFI	Note	Frequency	Level	Over	Limit	Read	Antenna	Cable	Preamp	Ant	Table	Peak	Pol.
Ant.				Limit	Line	Level	Factor	Loss	Factor	Pos	Pos	Avg.	
1+2		( MHz )	( dBμV/m )	( dB )	( dBμV/m )	( dBμV )	( dB/m )	( dB )	( dB )	( cm )	( deg )	( P/A )	( H/V )
802.11ac VHT80 CH 106 5530MHz		11060	42.67	-31.33	74	46.69	37.94	16.97	58.93	100	0	P	H
		16590	48.39	-25.61	74	42.59	41.57	20.96	56.73	100	0	P	H
													H
													H
		11060	43.17	-30.83	74	47.19	37.94	16.97	58.93	100	0	P	V
		16590	49.14	-24.86	74	43.34	41.57	20.96	56.73	100	0	P	V
													V
802.11ac VHT80 CH 122 5610MHz		11220	44.66	-29.34	74	48.05	38.03	17.12	58.54	100	0	P	H
		16830	49.83	-24.17	74	43.19	42.06	21.12	56.54	100	0	P	H
													H
													H
		11220	44.85	-29.15	74	48.24	38.03	17.12	58.54	100	0	P	V
		16830	50.03	-23.97	74	43.39	42.06	21.12	56.54	100	0	P	V
													V
Remark	1. No other spurious found.												
	2. All results are PASS against Peak and Average limit line.												



15E Band 3 - Straddle Channel  
WIFI 802.11a (Band Edge @ 3m)

WIFI	Note	Frequency	Level	Over	Limit	Read	Antenna	Cable	Preamp	Ant	Table	Peak	Pol.
Ant.				Limit	Line	Level	Factor	Loss	Factor	Pos	Pos	Avg.	
1+2		( MHz )	( dBµV/m )	( dB )	( dBµV/m )	( dBµV )	( dB/m )	( dB )	( dB )	( cm )	( deg )	( P/A )	( H/V )
802.11a CH 144 5720MHz	*	5720	104.44	-	-	91.1	35.23	12.26	34.15	197	47	P	H
	*	5720	93.5	-	-	80.16	35.23	12.26	34.15	197	47	A	H
													H
													H
													H
													H
	*	5720	104.16	-	-	90.82	35.23	12.26	34.15	169	14	P	V
	*	5720	93.1	-	-	79.76	35.23	12.26	34.15	169	14	A	V
													V
													V
												V	
												V	
<b>Remark</b>	1. No other spurious found. 2. All results are PASS against Peak and Average limit line.												

15E Band 3 - Straddle Channel  
WIFI 802.11a (Harmonic @ 3m)

WIFI	Note	Frequency	Level	Over	Limit	Read	Antenna	Cable	Preamp	Ant	Table	Peak	Pol.
Ant.				Limit	Line	Level	Factor	Loss	Factor	Pos	Pos	Avg.	
1+2		( MHz )	( dBµV/m )	( dB )	( dBµV/m )	( dBµV )	( dB/m )	( dB )	( dB )	( cm )	( deg )	( P/A )	( H/V )
802.11a CH 144 5720MHz		11440	43.46	-30.54	74	45.92	38.16	17.35	57.97	100	0	P	H
		17160	49.84	-24.16	74	42.75	42.27	21.32	56.5	100	0	P	H
													H
													H
		11440	44.14	-29.86	74	46.6	38.16	17.35	57.97	100	0	P	V
		17160	49.4	-24.6	74	42.31	42.27	21.32	56.5	100	0	P	V
													V
													V
<b>Remark</b>	1. No other spurious found. 2. All results are PASS against Peak and Average limit line.												



15E Band 3 - Straddle Channel

WIFI 802.11n HT20 (Band Edge @ 3m)

WIFI	Note	Frequency	Level	Over	Limit	Read	Antenna	Cable	Preamp	Ant	Table	Peak	Pol.
Ant.				Limit	Line	Level	Factor	Loss	Factor	Pos	Pos	Avg.	
1+2		( MHz )	( dBμV/m )	( dB )	( dBμV/m )	( dBμV )	( dB/m )	( dB )	( dB )	( cm )	( deg )	( P/A )	( H/V )
802.11n HT20 CH 144 5720MHz	*	5720	103.73	-	-	90.39	35.23	12.26	34.15	100	48	P	H
	*	5720	90.96	-	-	77.62	35.23	12.26	34.15	100	48	A	H
													H
													H
													H
													H
	*	5720	104.24	-	-	90.9	35.23	12.26	34.15	204	10	P	V
	*	5720	91.29	-	-	77.95	35.23	12.26	34.15	204	10	A	V
													V
													V
												V	
												V	
<b>Remark</b>	1. No other spurious found. 2. All results are PASS against Peak and Average limit line.												

15E Band 3 - Straddle Channel

WIFI 802.11n HT20 (Harmonic @ 3m)

WIFI	Note	Frequency	Level	Over	Limit	Read	Antenna	Cable	Preamp	Ant	Table	Peak	Pol.
Ant.				Limit	Line	Level	Factor	Loss	Factor	Pos	Pos	Avg.	
1+2		( MHz )	( dBμV/m )	( dB )	( dBμV/m )	( dBμV )	( dB/m )	( dB )	( dB )	( cm )	( deg )	( P/A )	( H/V )
802.11n HT20 CH 144 5720MHz		11440	43.21	-30.79	74	45.67	38.16	17.35	57.97	100	0	P	H
		17160	49.86	-24.14	74	42.77	42.27	21.32	56.5	100	0	P	H
													H
													H
		11440	43.33	-30.67	74	45.79	38.16	17.35	57.97	100	0	P	V
		17160	49.75	-24.25	74	42.66	42.27	21.32	56.5	100	0	P	V
													V
													V
<b>Remark</b>	1. No other spurious found. 2. All results are PASS against Peak and Average limit line.												



15E Band 3 - Straddle Channel

WIFI 802.11n HT40 (Band Edge @ 3m)

WIFI	Note	Frequency	Level	Over	Limit	Read	Antenna	Cable	Preamp	Ant	Table	Peak	Pol.
Ant.				Limit	Line	Level	Factor	Loss	Factor	Pos	Pos	Avg.	
1+2		( MHz )	( dBµV/m )	( dB )	( dBµV/m )	( dBµV )	( dB/m )	( dB )	( dB )	( cm )	( deg )	(P/A)	(H/V)
802.11n HT40 CH 142 5710MHz	*	5710	100.28	-	-	86.95	35.22	12.26	34.15	100	48	P	H
	*	5710	88.88	-	-	75.55	35.22	12.26	34.15	100	48	A	H
													H
													H
													H
													H
	*	5710	100.13	-	-	86.8	35.22	12.26	34.15	241	7	P	V
	*	5710	88.8	-	-	75.47	35.22	12.26	34.15	241	7	A	V
													V
													V
<b>Remark</b>	1. No other spurious found. 2. All results are PASS against Peak and Average limit line.												

15E Band 3 - Straddle Channel

WIFI 802.11n HT40 (Harmonic @ 3m)

WIFI	Note	Frequency	Level	Over	Limit	Read	Antenna	Cable	Preamp	Ant	Table	Peak	Pol.
Ant.				Limit	Line	Level	Factor	Loss	Factor	Pos	Pos	Avg.	
1+2		( MHz )	( dBµV/m )	( dB )	( dBµV/m )	( dBµV )	( dB/m )	( dB )	( dB )	( cm )	( deg )	(P/A)	(H/V)
802.11n HT40 CH 142 5710MHz		11420	43.97	-30.03	74	46.53	38.15	17.31	58.02	100	0	P	H
		17130	50.27	-23.73	74	43.16	42.29	21.3	56.48	100	0	P	H
													H
													H
		11420	43.83	-30.17	74	46.39	38.15	17.31	58.02	100	0	P	V
		17130	50.2	-23.8	74	43.09	42.29	21.3	56.48	100	0	P	V
													V
<b>Remark</b>	1. No other spurious found. 2. All results are PASS against Peak and Average limit line.												



15E Band 3 - Straddle Channel

WIFI 802.11ac VHT80 (Band Edge @ 3m)

WIFI	Note	Frequency	Level	Over	Limit	Read	Antenna	Cable	Preamp	Ant	Table	Peak	Pol.
Ant.				Limit	Line	Level	Factor	Loss	Factor	Pos	Pos	Avg.	
1+2		( MHz )	( dBμV/m )	( dB )	( dBμV/m )	( dBμV )	( dB/m )	( dB )	( dB )	( cm )	( deg )	( P/A )	( H/V )
802.11ac VHT80 CH 138 5690MHz	*	5690	97.17	-	-	83.9	35.21	12.18	34.12	251	50	P	H
	*	5690	86.54	-	-	73.27	35.21	12.18	34.12	251	50	A	H
													H
													H
													H
													H
	*	5690	97.89	-	-	84.62	35.21	12.18	34.12	212	16	P	V
	*	5690	86.86	-	-	73.59	35.21	12.18	34.12	212	16	A	V
													V
													V
												V	
												V	
<b>Remark</b>	1. No other spurious found. 2. All results are PASS against Peak and Average limit line.												

15E Band 3 - Straddle Channel

WIFI 802.11ac VHT80 (Harmonic @ 3m)

WIFI	Note	Frequency	Level	Over	Limit	Read	Antenna	Cable	Preamp	Ant	Table	Peak	Pol.
Ant.				Limit	Line	Level	Factor	Loss	Factor	Pos	Pos	Avg.	
1+2		( MHz )	( dBμV/m )	( dB )	( dBμV/m )	( dBμV )	( dB/m )	( dB )	( dB )	( cm )	( deg )	( P/A )	( H/V )
802.11ac VHT80 CH 138 5690MHz		11380	44.02	-29.98	74	46.72	38.13	17.27	58.1	100	0	P	H
		17070	49.79	-24.21	74	42.61	42.35	21.27	56.44	100	0	P	H
													H
													H
		11380	43.91	-30.09	74	46.61	38.13	17.27	58.1	100	0	P	V
		17070	50	-24	74	42.82	42.35	21.27	56.44	100	0	P	V
													V
												V	
<b>Remark</b>	1. No other spurious found. 2. All results are PASS against Peak and Average limit line.												



15E Emission below 1GHz

WIFI 802.11a (LF @ 3m)

WIFI	Note	Frequency	Level	Over	Limit	Read	Antenna	Cable	Preamp	Ant	Table	Peak	Pol.	
Ant.				Limit	Line	Level	Factor	Loss	Factor	Pos	Pos	Avg.		
1+2		( MHz )	( dBμV/m )	( dB )	( dBμV/m )	( dBμV )	( dB/m )	( dB )	( dB )	( cm )	( deg )	( P/A )	( H/V )	
802.11a LF		31.89	28	-12	40	39.89	17.76	1.77	31.42	173	61	P	H	
		55.65	19.94	-20.06	40	42.97	6.4	1.77	31.2	-	-	P	H	
		74.01	14.25	-25.75	40	36.69	6.72	2.06	31.22	-	-	P	H	
		652.8	24.51	-21.49	46	30.41	20.37	4.22	30.49	-	-	P	H	
		738.2	26.79	-19.21	46	30.62	22.16	4.41	30.4	-	-	P	H	
		936.3	28.5	-17.5	46	29.77	24.3	4.8	30.37	-	-	P	H	
														H
														H
														H
														H
														H
														H
														H
			30.81	25.81	-14.19	40	37.22	18.28	1.77	31.46	100	72	P	V
			58.35	16.82	-23.18	40	40.15	6.16	1.77	31.26	-	-	P	V
			77.79	18.36	-21.64	40	40.6	6.9	2.06	31.2	-	-	P	V
			727.7	25.59	-20.41	46	29.74	21.84	4.41	30.4	-	-	P	V
			838.3	27.19	-18.81	46	29.75	23.12	4.7	30.38	-	-	P	V
			925.1	28.44	-17.56	46	29.84	24.15	4.8	30.35	-	-	P	V
														V
													V	
													V	
													V	
													V	
													V	
Remark	1. No other spurious found. 2. All results are PASS against limit line.													



15E Emission below 1GHz  
WIFI 802.11n HT20 (LF @ 3m)

WIFI	Note	Frequency	Level	Over	Limit	Read	Antenna	Cable	Preamp	Ant	Table	Peak	Pol.	
Ant.				Limit	Line	Level	Factor	Loss	Factor	Pos	Pos	Avg.		
1+2		( MHz )	( dBμV/m )	( dB )	( dBμV/m )	( dBμV )	( dB/m )	( dB )	( dB )	( cm )	( deg )	( P/A )	( H/V )	
802.11n HT20 LF		30.54	28.26	-11.74	40	39.67	18.28	1.77	31.46	221	63	P	H	
		55.65	19.57	-20.43	40	42.6	6.4	1.77	31.2	-	-	P	H	
		75.9	14.37	-25.63	40	36.68	6.83	2.06	31.2	-	-	P	H	
		738.2	27.09	-18.91	46	30.92	22.16	4.41	30.4	-	-	P	H	
		848.1	28.34	-17.66	46	30.76	23.28	4.7	30.4	-	-	P	H	
		932.1	29.27	-16.73	46	30.53	24.3	4.8	30.36	-	-	P	H	
														H
														H
														H
														H
														H
														H
			31.08	25.88	-14.12	40	37.29	18.28	1.77	31.46	100	87	P	V
			54.3	19.16	-20.84	40	41.79	6.8	1.77	31.2	-	-	P	V
			77.52	18.66	-21.34	40	40.9	6.9	2.06	31.2	-	-	P	V
			638.8	24.49	-21.51	46	30.39	20.4	4.22	30.52	-	-	P	V
			844.6	28.11	-17.89	46	30.55	23.25	4.7	30.39	-	-	P	V
			913.9	28.71	-17.29	46	30.56	23.68	4.8	30.33	-	-	P	V
														V
														V
													V	
													V	
													V	
													V	
<b>Remark</b>	1. No other spurious found. 2. All results are PASS against limit line.													





15E Emission below 1GHz  
WIFI 802.11n HT40 (LF @ 3m)

WIFI	Note	Frequency	Level	Over	Limit	Read	Antenna	Cable	Preamp	Ant	Table	Peak	Pol.	
Ant.				Limit	Line	Level	Factor	Loss	Factor	Pos	Pos	Avg.		
1+2		( MHz )	( dBμV/m )	( dB )	( dBμV/m )	( dBμV )	( dB/m )	( dB )	( dB )	( cm )	( deg )	( P/A )	( H/V )	
802.11n HT40 LF		30.81	25.18	-14.82	40	36.59	18.28	1.77	31.46	153	41	P	H	
		55.65	19.89	-20.11	40	42.92	6.4	1.77	31.2	-	-	P	H	
		75.36	14.05	-25.95	40	36.36	6.83	2.06	31.2	-	-	P	H	
		720.7	25.93	-20.07	46	30.47	21.45	4.41	30.4	-	-	P	H	
		905.5	28.16	-17.84	46	30.29	23.38	4.8	30.31	-	-	P	H	
		948.2	29.25	-16.75	46	30.32	24.39	4.94	30.4	-	-	P	H	
														H
														H
														H
														H
														H
														H
														H
			30.27	23.77	-16.23	40	34.7	18.8	1.77	31.5	100	79	P	V
			54.57	19.82	-20.18	40	42.45	6.8	1.77	31.2	-	-	P	V
			78.06	19.27	-20.73	40	41.48	6.93	2.06	31.2	-	-	P	V
			715.8	25.69	-20.31	46	30.44	21.24	4.41	30.4	-	-	P	V
			844.6	27.12	-18.88	46	29.56	23.25	4.7	30.39	-	-	P	V
			937.7	28.34	-17.66	46	29.62	24.3	4.8	30.38	-	-	P	V
														V
													V	
													V	
													V	
													V	
													V	
Remark	1. No other spurious found. 2. All results are PASS against limit line.													



15E Emission below 1GHz  
WIFI 802.11ac VHT80 (LF @ 3m)

WIFI	Note	Frequency	Level	Over	Limit	Read	Antenna	Cable	Preamp	Ant	Table	Peak	Pol.	
Ant.				Limit	Line	Level	Factor	Loss	Factor	Pos	Pos	Avg.		
1+2		( MHz )	( dBµV/m )	( dB )	( dBµV/m )	( dBµV )	( dB/m )	( dB )	( dB )	( cm )	( deg )	( P/A )	( H/V )	
802.11ac VHT80 LF		31.08	27.56	-12.44	40	38.97	18.28	1.77	31.46	223	41	P	H	
		41.07	19.27	-20.73	40	35.4	13.3	1.77	31.2	-	-	P	H	
		55.92	19.6	-20.4	40	42.73	6.32	1.77	31.22	-	-	P	H	
		660.5	25.13	-20.87	46	30.95	20.31	4.35	30.48	-	-	P	H	
		843.9	27.41	-18.59	46	29.86	23.24	4.7	30.39	-	-	P	H	
		953.8	28.7	-17.3	46	29.63	24.51	4.94	30.38	-	-	P	H	
														H
														H
														H
														H
														H
														H
			31.35	26.53	-13.47	40	37.9	18.28	1.77	31.42	100	102	P	V
			54.03	19.85	-20.15	40	42.48	6.8	1.77	31.2	-	-	P	V
			77.25	18.8	-21.2	40	41.04	6.9	2.06	31.2	-	-	P	V
			787.2	26.85	-19.15	46	30.63	21.93	4.62	30.33	-	-	P	V
			874.7	27.72	-18.28	46	30.46	22.95	4.66	30.35	-	-	P	V
			947.5	29.27	-16.73	46	30.34	24.38	4.94	30.39	-	-	P	V
														V
														V
													V	
													V	
													V	
													V	
Remark	1. No other spurious found. 2. All results are PASS against limit line.													



**Note symbol**

*	<b>Fundamental Frequency</b> which can be ignored. However, the level of any unwanted emissions shall not exceed the level of the fundamental frequency per 15.209(c).
!	Test result is <b>over limit</b> line.
P/A	<b>Peak</b> or <b>Average</b>
H/V	<b>Horizontal</b> or <b>Vertical</b>



A calculation example for radiated spurious emission is shown as below:

WIFI	Note	Frequency	Level	Over	Limit	Read	Antenna	Cable	Preamp	Ant	Table	Peak	Pol.
Ant.				Limit	Line	Level	Factor	Loss	Factor	Pos	Pos	Avg.	
1+2		( MHz )	( dBμV/m )	( dB )	( dBμV/m )	( dBμV )	( dB/m )	( dB )	( dB )	( cm )	( deg )	(P/A)	(H/V)
802.11b		2390	55.45	-18.55	74	54.51	32.22	4.58	35.86	103	308	P	H
CH 01													
2412MHz		2390	43.54	-10.46	54	42.6	32.22	4.58	35.86	103	308	A	H

- Level(dBμV/m) =  
Antenna Factor(dB/m) + Cable Loss(dB) + Read Level(dBμV) - Preamp Factor(dB)
- Over Limit(dB) = Level(dBμV/m) – Limit Line(dBμV/m)

**For Peak Limit @ 2390MHz:**

- Level(dBμV/m)  
= Antenna Factor(dB/m) + Cable Loss(dB) + Read Level(dBμV) - Preamp Factor(dB)  
= 32.22(dB/m) + 4.58(dB) + 54.51(dBμV) – 35.86 (dB)  
= 55.45 (dBμV/m)
- Over Limit(dB)  
= Level(dBμV/m) – Limit Line(dBμV/m)  
= 55.45(dBμV/m) – 74(dBμV/m)  
= -18.55(dB)

**For Average Limit @ 2390MHz:**

- Level(dBμV/m)  
= Antenna Factor(dB/m) + Cable Loss(dB) + Read Level(dBμV) - Preamp Factor(dB)  
= 32.22(dB/m) + 4.58(dB) + 42.6(dBμV) – 35.86 (dB)  
= 43.54 (dBμV/m)
- Over Limit(dB)  
= Level(dBμV/m) – Limit Line(dBμV/m)  
= 43.54(dBμV/m) – 54(dBμV/m)  
= -10.46(dB)

Both peak and average measured complies with the limit line, so test result is “PASS”.



## Appendix C. Radiated Spurious Emission

Test Engineer :	Luke Chang	Temperature :	21~23°C
		Relative Humidity :	41~42%

**Band 1 - 5150~5250MHz**  
**WIFI 802.11a (Band Edge @ 3m)**

WIFI	Band 1 5150~5250MHz Band Edge @ 3m	
ANT	802.11a CH36 5180MHz	
1+2	Horizontal	Vertical
<b>Peak</b>	<p>Level (dBuV/m) vs Frequency (MHz) plot for Horizontal orientation. The y-axis ranges from 0 to 117 dBuV/m, and the x-axis ranges from 5000 to 5150 MHz. A red horizontal line indicates the FCC CLASS-B limit at 73.1 dBuV/m. The measured signal (blue line) is significantly below this limit, with a peak at approximately 5180 MHz. A small peak is labeled '1'.</p> <p>Site : 03CH07-HY Condition : FCC CLASS-B 3m HF-ANT_130829 HORIZONTAL RBW:1000.000kHz VBW:3000.000kHz SWT:Auto Detector : Peak</p>	<p>Level (dBuV/m) vs Frequency (MHz) plot for Vertical orientation. The y-axis ranges from 0 to 117 dBuV/m, and the x-axis ranges from 5000 to 5150 MHz. A red horizontal line indicates the FCC CLASS-B limit at 73.1 dBuV/m. The measured signal (blue line) is significantly below this limit, with a peak at approximately 5180 MHz. A small peak is labeled '1'.</p> <p>Site : 03CH07-HY Condition : FCC CLASS-B 3m HF-ANT_130829 VERTICAL RBW:1000.000kHz VBW:3000.000kHz SWT:Auto Detector : Peak</p>
<b>Avg.</b>	<p>Level (dBuV/m) vs Frequency (MHz) plot for Horizontal orientation. The y-axis ranges from 0 to 117 dBuV/m, and the x-axis ranges from 5000 to 5150 MHz. A red horizontal line indicates the FCC CLASS-B (AVG) limit at 58.5 dBuV/m. The measured signal (blue line) is consistently below this limit.</p> <p>Site : 03CH07-HY Condition : FCC CLASS-B (AVG) 3m HF-ANT_130829 HORIZONTAL RBW:1000.000kHz VBW:0.010kHz SWT:Auto Detector : Peak</p>	<p>Level (dBuV/m) vs Frequency (MHz) plot for Vertical orientation. The y-axis ranges from 0 to 117 dBuV/m, and the x-axis ranges from 5000 to 5150 MHz. A red horizontal line indicates the FCC CLASS-B (AVG) limit at 58.5 dBuV/m. The measured signal (blue line) is consistently below this limit.</p> <p>Site : 03CH07-HY Condition : FCC CLASS-B (AVG) 3m HF-ANT_130829 VERTICAL RBW:1000.000kHz VBW:0.010kHz SWT:Auto Detector : Peak</p>



WIFI	Band 1 5150~5250MHz Band Edge @ 3m	
ANT	802.11a CH44 5220MHz – Low channel location	
1+2	Horizontal	Vertical
Peak	<p>Site : 03CH07-HY Condition : FCC CLASS-B 3m HF-ANT_130829 HORIZONTAL RBW:1000.000kHz VBW:3000.000kHz SWT:Auto Detector : Peak</p>	<p>Site : 03CH07-HY Condition : FCC CLASS-B 3m HF-ANT_130829 VERTICAL RBW:1000.000kHz VBW:3000.000kHz SWT:Auto Detector : Peak</p>
Avg.	<p>Site : 03CH07-HY Condition : FCC CLASS-B (AVG) 3m HF-ANT_130829 HORIZONTAL RBW:1000.000kHz VBW:0.010kHz SWT:Auto Detector : Peak</p>	<p>Site : 03CH07-HY Condition : FCC CLASS-B (AVG) 3m HF-ANT_130829 VERTICAL RBW:1000.000kHz VBW:0.010kHz SWT:Auto Detector : Peak</p>

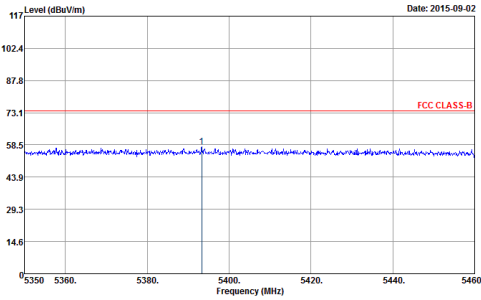
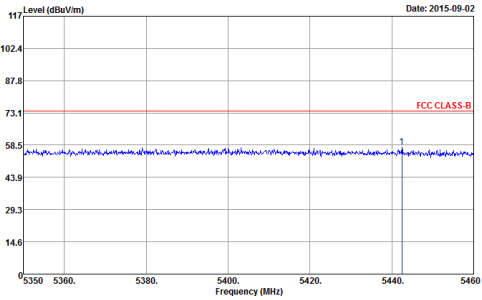
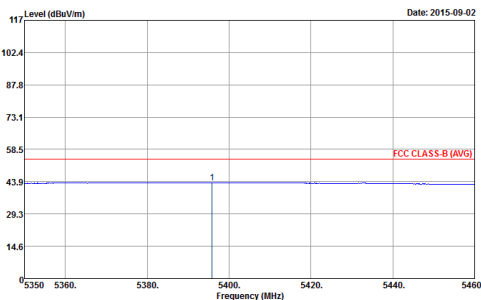
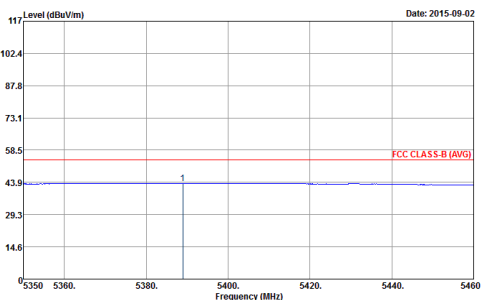

WIFI	Band 1 5150~5250MHz Band Edge @ 3m	
ANT	802.11a CH44 5220MHz - High channel location	
1+2	Horizontal	Vertical
Peak	 <p>Site : 03CH07-HY Condition : FCC CLASS-B 3m HF-ANT_130829 HORIZONTAL RBW: 1000.000kHz VBW: 5000.000kHz SWT:Auto Detector : Peak</p>	 <p>Site : 03CH07-HY Condition : FCC CLASS-B 3m HF-ANT_130829 VERTICAL RBW: 1000.000kHz VBW: 5000.000kHz SWT:Auto Detector : Peak</p>
Avg.	 <p>Site : 03CH07-HY Condition : FCC CLASS-B (AVG) 3m HF-ANT_130829 HORIZONTAL RBW: 1000.000kHz VBW: 0.010kHz SWT:Auto Detector : Peak</p>	 <p>Site : 03CH07-HY Condition : FCC CLASS-B (AVG) 3m HF-ANT_130829 VERTICAL RBW: 1000.000kHz VBW: 0.010kHz SWT:Auto Detector : Peak</p>

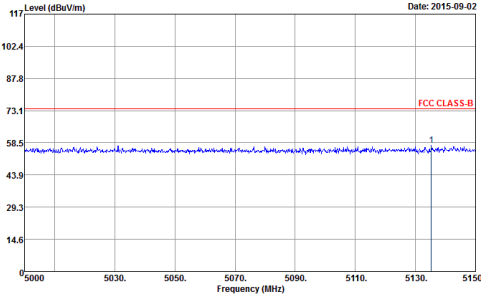
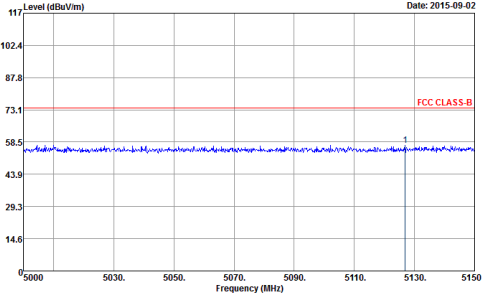
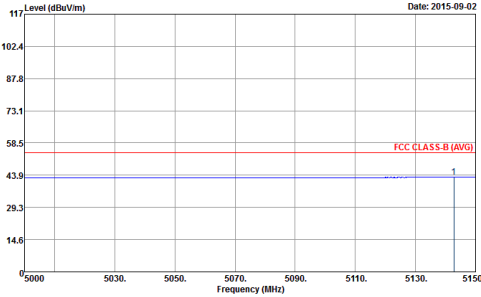
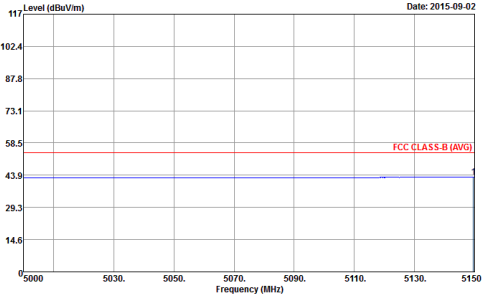

WIFI	Band 1 5150~5250MHz Band Edge @ 3m	
ANT	802.11a CH48 5240MHz - Low channel location	
1+2	Horizontal	Vertical
Peak	 <p>Level (dBuV/m) vs Frequency (MHz) plot for Horizontal orientation. The y-axis ranges from 14.6 to 117 dBuV/m, and the x-axis ranges from 5000 to 5150 MHz. A red horizontal line indicates the FCC CLASS-B limit at 73.1 dBuV/m. The measured signal (blue line) is significantly below this limit, with a peak value of approximately 58.5 dBuV/m. A small peak is visible at 5130 MHz.</p> <p>Site : 03CH07-HY            Condition : FCC CLASS-B 3m HF-ANT_130829 HORIZONTAL            RBW:1000.000KHz VBW:3000.000KHz SWT:Auto            Detector : Peak</p>	 <p>Level (dBuV/m) vs Frequency (MHz) plot for Vertical orientation. The y-axis ranges from 14.6 to 117 dBuV/m, and the x-axis ranges from 5000 to 5150 MHz. A red horizontal line indicates the FCC CLASS-B limit at 73.1 dBuV/m. The measured signal (blue line) is significantly below this limit, with a peak value of approximately 58.5 dBuV/m. A small peak is visible at 5130 MHz.</p> <p>Site : 03CH07-HY            Condition : FCC CLASS-B 3m HF-ANT_130829 VERTICAL            RBW:1000.000KHz VBW:3000.000KHz SWT:Auto            Detector : Peak</p>
Avg.	 <p>Level (dBuV/m) vs Frequency (MHz) plot for Horizontal orientation (Average). The y-axis ranges from 14.6 to 117 dBuV/m, and the x-axis ranges from 5000 to 5150 MHz. A red horizontal line indicates the FCC CLASS-B (AVG) limit at 58.5 dBuV/m. The measured signal (blue line) is consistently below this limit, with a peak value of approximately 43.9 dBuV/m. A small peak is visible at 5130 MHz.</p> <p>Site : 03CH07-HY            Condition : FCC CLASS-B (AVG) 3m HF-ANT_130829 HORIZONTAL            RBW:1000.000KHz VBW:0.010KHz SWT:Auto            Detector : Peak</p>	 <p>Level (dBuV/m) vs Frequency (MHz) plot for Vertical orientation (Average). The y-axis ranges from 14.6 to 117 dBuV/m, and the x-axis ranges from 5000 to 5150 MHz. A red horizontal line indicates the FCC CLASS-B (AVG) limit at 58.5 dBuV/m. The measured signal (blue line) is consistently below this limit, with a peak value of approximately 43.9 dBuV/m. A small peak is visible at 5130 MHz.</p> <p>Site : 03CH07-HY            Condition : FCC CLASS-B (AVG) 3m HF-ANT_130829 VERTICAL            RBW:1000.000KHz VBW:0.010KHz SWT:Auto            Detector : Peak</p>



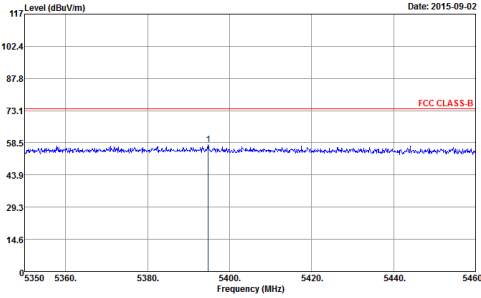
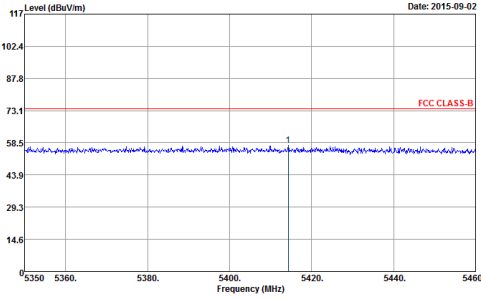
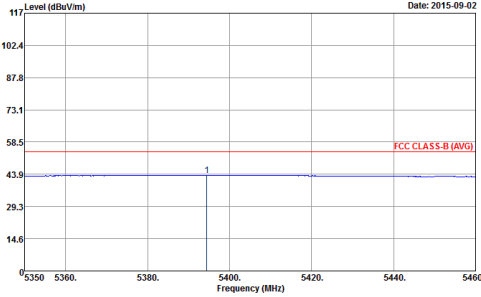
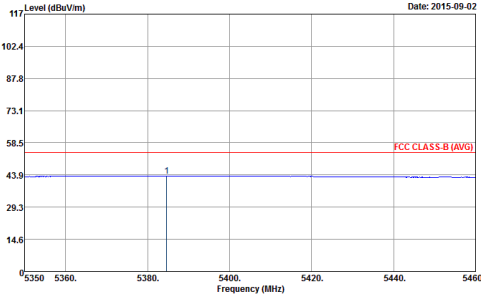

WIFI	Band 1 5150~5250MHz Band Edge @ 3m	
ANT	802.11a CH48 5240MHz - High channel location	
1+2	Horizontal	Vertical
Peak	 <p>Site : 03CH07-HY            Condition : FCC CLASS-B 3m HF-ANT_130829 HORIZONTAL            RBW:1000.000kHz VBW:3000.000kHz SWT:Auto            Detector : Peak</p>	 <p>Site : 03CH07-HY            Condition : FCC CLASS-B 3m HF-ANT_130829 VERTICAL            RBW:1000.000kHz VBW:3000.000kHz SWT:Auto            Detector : Peak</p>
Avg.	 <p>Site : 03CH07-HY            Condition : FCC CLASS-B (AVG) 3m HF-ANT_130829 HORIZONTAL            RBW:1000.000kHz VBW:0.010kHz SWT:Auto            Detector : Peak</p>	 <p>Site : 03CH07-HY            Condition : FCC CLASS-B (AVG) 3m HF-ANT_130829 VERTICAL            RBW:1000.000kHz VBW:0.010kHz SWT:Auto            Detector : Peak</p>



Band 1 5150~5250MHz
WIFI 802.11n HT20 (Band Edge @ 3m)

Table with 4 quadrants: Peak Horizontal, Peak Vertical, Avg. Horizontal, Avg. Vertical. Each quadrant contains a graph of Level (dBuV/m) vs Frequency (MHz) and technical details like Site, Condition, and Detector.



WIFI	Band 1 5150~5250MHz Band Edge @ 3m	
ANT	802.11n HT20 CH44 5220MHz - Low channel location	
1+2	Horizontal	Vertical
Peak	<p>Site : 03CH07-HY Condition : FCC CLASS-B 3m HF-ANT_130829 HORIZONTAL RBW:1000.000KHz VBW:3000.000KHz SWT:Auto Detector : Peak</p>	<p>Site : 03CH07-HY Condition : FCC CLASS-B 3m HF-ANT_130829 VERTICAL RBW:1000.000KHz VBW:3000.000KHz SWT:Auto Detector : Peak</p>
Avg.	<p>Site : 03CH07-HY Condition : FCC CLASS-B (AVG) 3m HF-ANT_130829 HORIZONTAL RBW:1000.000KHz VBW:0.010KHz SWT:Auto Detector : Peak</p>	<p>Site : 03CH07-HY Condition : FCC CLASS-B (AVG) 3m HF-ANT_130829 VERTICAL RBW:1000.000KHz VBW:0.010KHz SWT:Auto Detector : Peak</p>

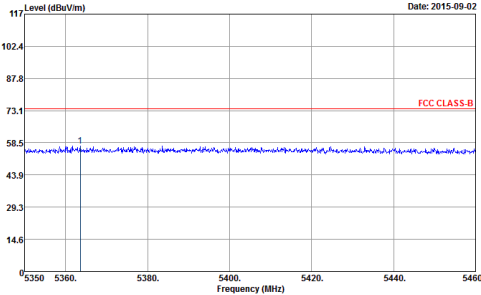
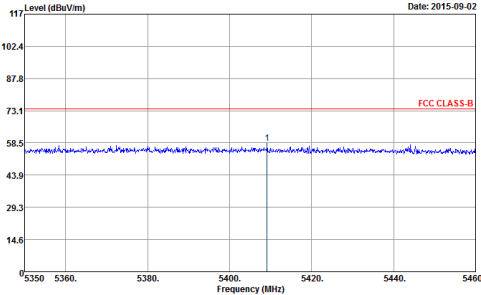
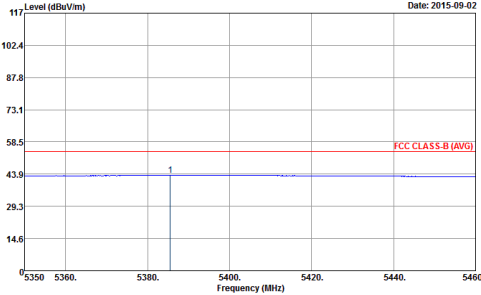
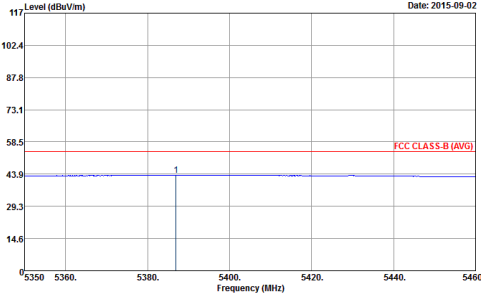

WIFI	Band 1 5150~5250MHz Band Edge @ 3m	
ANT	802.11n HT20 CH44 5220MHz - High channel location	
1+2	Horizontal	Vertical
Peak	 <p>Site : 03CH07-HY            Condition : FCC CLASS-B 3m HF-ANT_130829 HORIZONTAL            RBW:1000.000kHz VBW:3000.000kHz SWT:Auto            Detector : Peak</p>	 <p>Site : 03CH07-HY            Condition : FCC CLASS-B 3m HF-ANT_130829 VERTICAL            RBW:1000.000kHz VBW:3000.000kHz SWT:Auto            Detector : Peak</p>
Avg.	 <p>Site : 03CH07-HY            Condition : FCC CLASS-B (AVG) 3m HF-ANT_130829 HORIZONTAL            RBW:1000.000kHz VBW:0.010kHz SWT:Auto            Detector : Peak</p>	 <p>Site : 03CH07-HY            Condition : FCC CLASS-B (AVG) 3m HF-ANT_130829 VERTICAL            RBW:1000.000kHz VBW:0.010kHz SWT:Auto            Detector : Peak</p>



WIFI	Band 1 5150~5250MHz Band Edge @ 3m	
ANT	802.11n HT20 CH48 5240MHz - Low channel location	
1+2	Horizontal	Vertical
Peak	<p>Site : 03CH07-HY Condition : FCC CLASS-B 3m HF-ANT_130829 HORIZONTAL RBW:1000.000kHz VBW:3000.000kHz SWT:Auto Detector : Peak</p>	<p>Site : 03CH07-HY Condition : FCC CLASS-B 3m HF-ANT_130829 VERTICAL RBW:1000.000kHz VBW:3000.000kHz SWT:Auto Detector : Peak</p>
Avg.	<p>Site : 03CH07-HY Condition : FCC CLASS-B (AVG) 3m HF-ANT_130829 HORIZONTAL RBW:1000.000kHz VBW:0.010kHz SWT:Auto Detector : Peak</p>	<p>Site : 03CH07-HY Condition : FCC CLASS-B (AVG) 3m HF-ANT_130829 VERTICAL RBW:1000.000kHz VBW:0.010kHz SWT:Auto Detector : Peak</p>

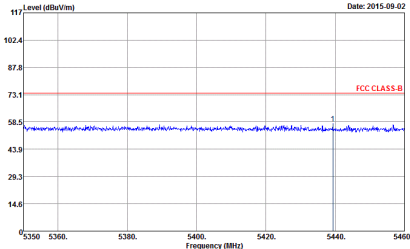
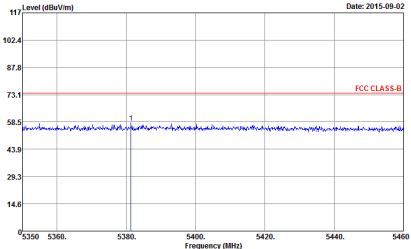
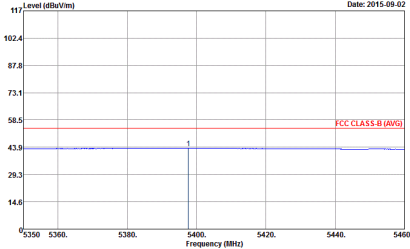
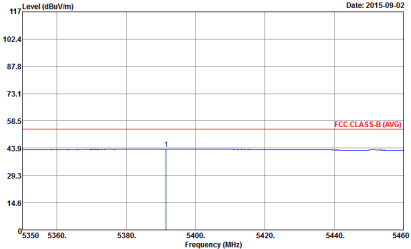

WIFI	Band 1 5150~5250MHz Band Edge @ 3m	
ANT	802.11n HT20 CH48 5240MHz - High channel location	
1+2	Horizontal	Vertical
Peak	 <p>Site : 03CH07-HY Condition : FCC CLASS-B 3m HF-ANT_130829 HORIZONTAL Detector : Peak</p>	 <p>Site : 03CH07-HY Condition : FCC CLASS-B 3m HF-ANT_130829 VERTICAL Detector : Peak</p>
Avg.	 <p>Site : 03CH07-HY Condition : FCC CLASS-B (AVG) 3m HF-ANT_130829 HORIZONTAL Detector : Peak</p>	 <p>Site : 03CH07-HY Condition : FCC CLASS-B (AVG) 3m HF-ANT_130829 VERTICAL Detector : Peak</p>



Band 1 5150~5250MHz
WIFI 802.11n HT40 (Band Edge @ 3m)

Table with 4 quadrants: Peak Horizontal, Peak Vertical, Avg. Horizontal, Avg. Vertical. Each quadrant contains a graph of Level (dBuV/m) vs Frequency (MHz) and associated test parameters.

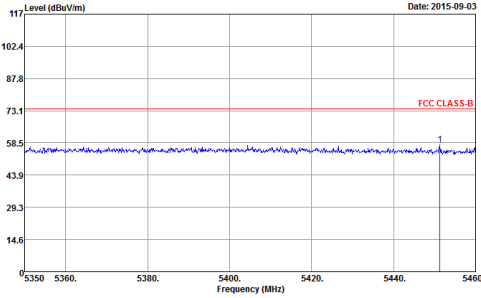
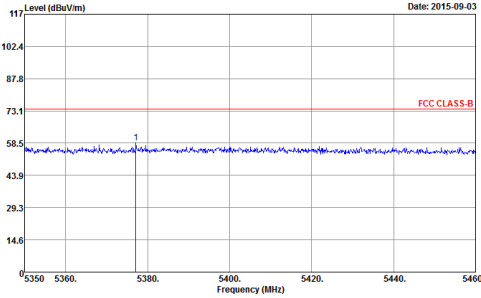
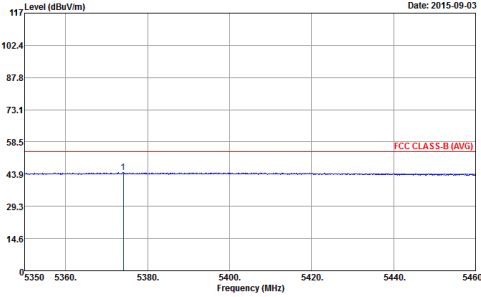
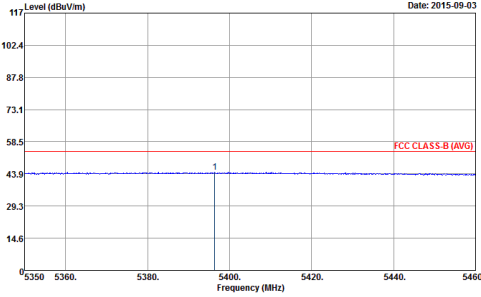

WIFI	Band 1 5150~5250MHz Band Edge @ 3m	
ANT	802.11n HT40 CH38 5190MHz - High channel location	
1+2	Horizontal	Vertical
Peak	 <p>Site : 03CH07-HY            Condition : FCC CLASS-B 3m HF-ANT_130829 HORIZONTAL            RBW:1000.000kHz VBW:3000.000kHz SWT:Auto            Detector : Peak</p>	 <p>Site : 03CH07-HY            Condition : FCC CLASS-B 3m HF-ANT_130829 VERTICAL            RBW:1000.000kHz VBW:3000.000kHz SWT:Auto            Detector : Peak</p>
Avg.	 <p>Site : 03CH07-HY            Condition : FCC CLASS-B (AVG) 3m HF-ANT_130829 HORIZONTAL            RBW:1000.000kHz VBW:2.000kHz SWT:Auto            Detector : Peak</p>	 <p>Site : 03CH07-HY            Condition : FCC CLASS-B (AVG) 3m HF-ANT_130829 VERTICAL            RBW:1000.000kHz VBW:2.000kHz SWT:Auto            Detector : Peak</p>



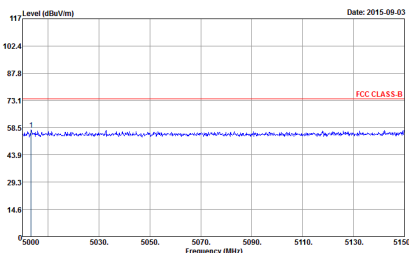
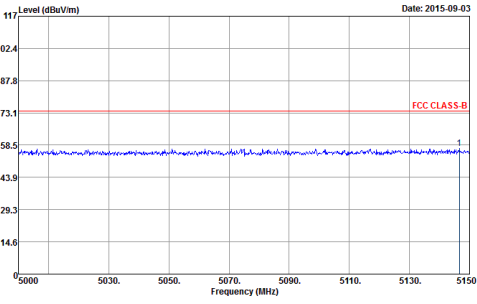
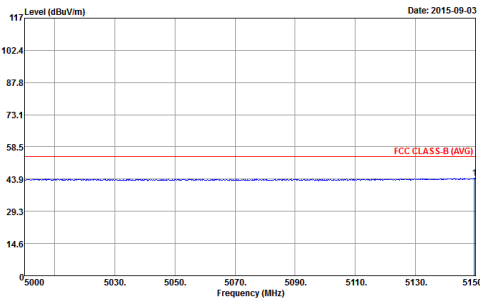
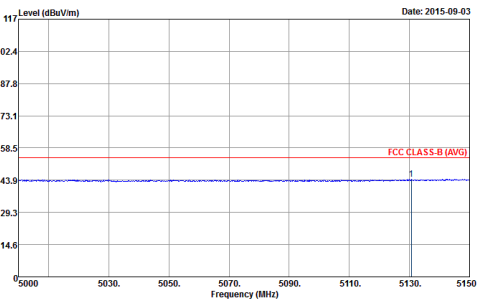

WIFI	Band 1 5150~5250MHz Band Edge @ 3m	
ANT	802.11n HT40 CH46 5230MHz - Low channel location	
1+2	Horizontal	Vertical
Peak	 <p>Level (dBuV/m) vs Frequency (MHz) for Horizontal orientation. The plot shows a blue signal line fluctuating around a mean level of approximately 58.5 dBuV/m, with a red horizontal line indicating the FCC CLASS-B limit at 73.1 dBuV/m. The x-axis ranges from 5000 to 5150 MHz, and the y-axis ranges from 14.6 to 117 dBuV/m.</p> <p>Site : 03CH07-HY            Condition : FCC CLASS-B 3m HF-ANT_130829 HORIZONTAL            RBW:1000.000kHz VBW:3000.000kHz SWT:Auto            Detector : Peak</p>	 <p>Level (dBuV/m) vs Frequency (MHz) for Vertical orientation. The plot shows a blue signal line fluctuating around a mean level of approximately 58.5 dBuV/m, with a red horizontal line indicating the FCC CLASS-B limit at 73.1 dBuV/m. The x-axis ranges from 5000 to 5150 MHz, and the y-axis ranges from 14.6 to 117 dBuV/m.</p> <p>Site : 03CH07-HY            Condition : FCC CLASS-B 3m HF-ANT_130829 VERTICAL            RBW:1000.000kHz VBW:3000.000kHz SWT:Auto            Detector : Peak</p>
Avg.	 <p>Level (dBuV/m) vs Frequency (MHz) for Horizontal orientation. The plot shows a blue signal line fluctuating around a mean level of approximately 43.9 dBuV/m, with a red horizontal line indicating the FCC CLASS-B (AVG) limit at 58.5 dBuV/m. The x-axis ranges from 5000 to 5150 MHz, and the y-axis ranges from 14.6 to 117 dBuV/m.</p> <p>Site : 03CH07-HY            Condition : FCC CLASS-B (AVG) 3m HF-ANT_130829 HORIZONTAL            RBW:1000.000kHz VBW:2.000kHz SWT:Auto            Detector : Peak</p>	 <p>Level (dBuV/m) vs Frequency (MHz) for Vertical orientation. The plot shows a blue signal line fluctuating around a mean level of approximately 43.9 dBuV/m, with a red horizontal line indicating the FCC CLASS-B (AVG) limit at 58.5 dBuV/m. The x-axis ranges from 5000 to 5150 MHz, and the y-axis ranges from 14.6 to 117 dBuV/m.</p> <p>Site : 03CH07-HY            Condition : FCC CLASS-B (AVG) 3m HF-ANT_130829 VERTICAL            RBW:1000.000kHz VBW:2.000kHz SWT:Auto            Detector : Peak</p>

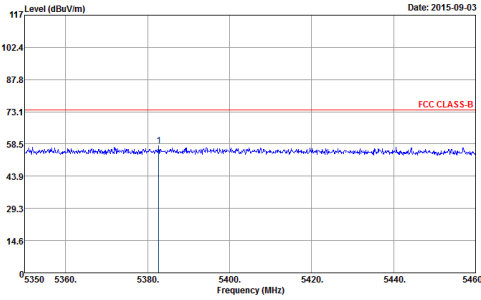
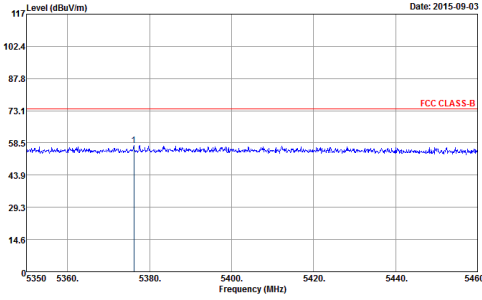
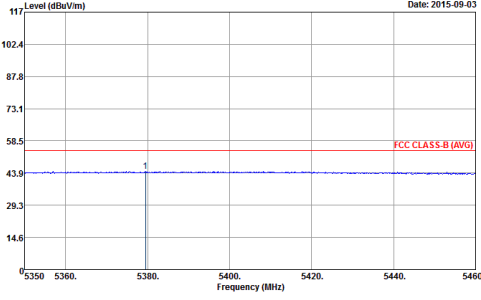
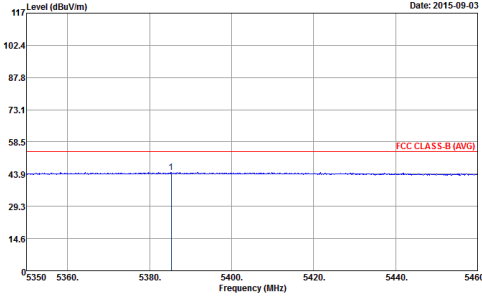

WIFI	Band 1 5150~5250MHz Band Edge @ 3m	
ANT	802.11n HT40 CH46 5230MHz - High channel location	
1+2	Horizontal	Vertical
Peak	 <p>Site : 03CH07-HY Condition : FCC CLASS-B 3m HF-ANT_130829 HORIZONTAL Detector : Peak</p>	 <p>Site : 03CH07-HY Condition : FCC CLASS-B 3m HF-ANT_130829 VERTICAL Detector : Peak</p>
Avg.	 <p>Site : 03CH07-HY Condition : FCC CLASS-B (AVG) 3m HF-ANT_130829 HORIZONTAL Detector : Peak</p>	 <p>Site : 03CH07-HY Condition : FCC CLASS-B (AVG) 3m HF-ANT_130829 VERTICAL Detector : Peak</p>



Band 1 5150~5250MHz
WIFI 802.11ac VHT80 (Band Edge @ 3m)

Table with 4 columns: WIFI, ANT, 1+2, and two sub-columns for Horizontal and Vertical. Rows include Peak and Avg. measurements with corresponding graphs and site details.

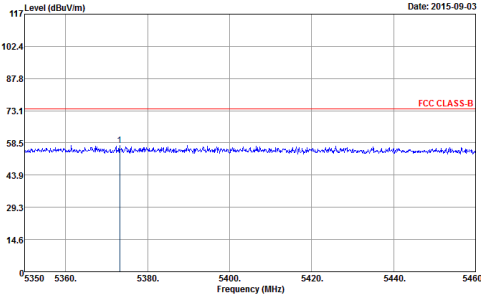
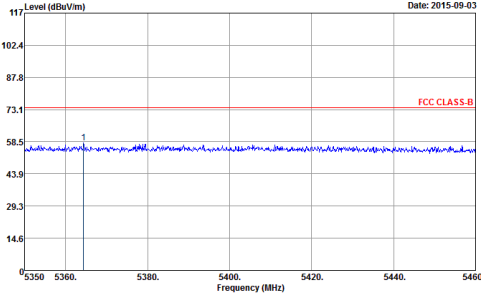
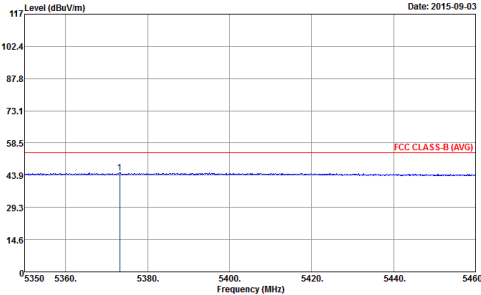
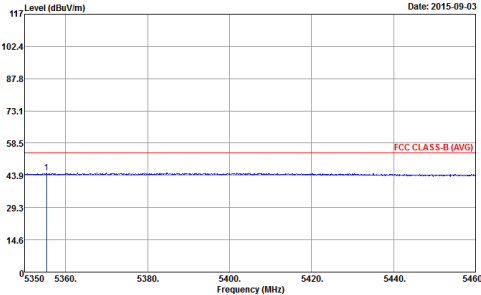

WIFI	Band 1 5150~5250MHz Band Edge @ 3m	
ANT	802.11ac VHT80 CH42 5210MHz - High channel location	
1+2	Horizontal	Vertical
Peak	 <p>Level (dBuV/m) vs Frequency (MHz) plot for Horizontal orientation. The y-axis ranges from 14.6 to 117 dBuV/m, and the x-axis ranges from 5350 to 5460 MHz. A red horizontal line indicates the FCC CLASS-B limit at 73.1 dBuV/m. The measured signal (blue line) is significantly below this limit, with a peak at approximately 5365 MHz.</p> <p>Site : 03CH07-HY  Condition : FCC CLASS-B 3m HF-ANT_130829 HORIZONTAL  RBW:1000.000kHz VBW:3000.000kHz SWT:Auto  Detector : Peak</p>	 <p>Level (dBuV/m) vs Frequency (MHz) plot for Vertical orientation. The y-axis ranges from 14.6 to 117 dBuV/m, and the x-axis ranges from 5350 to 5460 MHz. A red horizontal line indicates the FCC CLASS-B limit at 73.1 dBuV/m. The measured signal (blue line) is significantly below this limit, with a peak at approximately 5365 MHz.</p> <p>Site : 03CH07-HY  Condition : FCC CLASS-B 3m HF-ANT_130829 VERTICAL  RBW:1000.000kHz VBW:3000.000kHz SWT:Auto  Detector : Peak</p>
Avg.	 <p>Level (dBuV/m) vs Frequency (MHz) plot for Horizontal orientation showing average values. The y-axis ranges from 14.6 to 117 dBuV/m, and the x-axis ranges from 5350 to 5460 MHz. A red horizontal line indicates the FCC CLASS-B (AVG) limit at 58.5 dBuV/m. The measured signal (blue line) is consistently below this limit.</p> <p>Site : 03CH07-HY  Condition : FCC CLASS-B (AVG) 3m HF-ANT_130829 HORIZONTAL  RBW:1000.000kHz VBW:3.000kHz SWT:Auto  Detector : Peak</p>	 <p>Level (dBuV/m) vs Frequency (MHz) plot for Vertical orientation showing average values. The y-axis ranges from 14.6 to 117 dBuV/m, and the x-axis ranges from 5350 to 5460 MHz. A red horizontal line indicates the FCC CLASS-B (AVG) limit at 58.5 dBuV/m. The measured signal (blue line) is consistently below this limit.</p> <p>Site : 03CH07-HY  Condition : FCC CLASS-B (AVG) 3m HF-ANT_130829 VERTICAL  RBW:1000.000kHz VBW:3.000kHz SWT:Auto  Detector : Peak</p>



**Band 1 - 5150~5250MHz**

**WIFI 802.11a (Harmonic @ 3m)**

<b>WIFI</b>	<b>Band 1 5150~5250MHz Harmonic @ 3m</b>	
<b>ANT</b>	<b>802.11a CH36 5180MHz</b>	
<b>1+2</b>	<b>Horizontal</b>	<b>Vertical</b>
<b>Peak Avg.</b>	<p>Site : 03CH07-HY Condition : FCC CLASS-B 3m SHF-EHF_131029 HORIZONTAL Detector : Peak</p>	<p>Site : 03CH07-HY Condition : FCC CLASS-B 3m SHF-EHF_131029 VERTICAL Detector : Peak</p>

<b>WIFI</b>	<b>Band 1 5150~5250MHz Harmonic @ 3m</b>	
<b>ANT</b>	<b>802.11a CH44 5220MHz</b>	
<b>1+2</b>	<b>Horizontal</b>	<b>Vertical</b>
<b>Peak Avg.</b>	<p>Site : 03CH07-HY Condition : FCC CLASS-B 3m SHF-EHF_131029 HORIZONTAL Detector : Peak</p>	<p>Site : 03CH07-HY Condition : FCC CLASS-B 3m SHF-EHF_131029 VERTICAL Detector : Peak</p>



WIFI	Band 1 5150-5250MHz Harmonic @ 3m	
ANT	802.11a CH48 5240MHz	
1+2	Horizontal	Vertical
Peak Avg.	<p>Site : 03CH07-HY Condition : FCC CLASS-B 3m SHF-EHF_131029 HORIZONTAL Detector : Peak</p>	<p>Site : 03CH07-HY Condition : FCC CLASS-B 3m SHF-EHF_131029 VERTICAL Detector : Peak</p>



**Band 1 5150~5250MHz**  
**WIFI 802.11n HT20 (Harmonic @ 3m)**

<b>WIFI</b>	<b>Band 1 5150~5250MHz Harmonic @ 3m</b>	
<b>ANT</b>	<b>802.11n HT20 CH36 5180MHz</b>	
<b>1+2</b>	<b>Horizontal</b>	<b>Vertical</b>
<b>Peak Avg.</b>	<p>Site : 03CH07-HY Condition : FCC CLASS-B 3m SHF-EHF_131029 HORIZONTAL Detector : Peak</p>	<p>Site : 03CH07-HY Condition : FCC CLASS-B 3m SHF-EHF_131029 VERTICAL Detector : Peak</p>

<b>WIFI</b>	<b>Band 1 5150~5250MHz Harmonic @ 3m</b>	
<b>ANT</b>	<b>802.11n HT20 CH44 5220MHz</b>	
<b>1+2</b>	<b>Horizontal</b>	<b>Vertical</b>
<b>Peak Avg.</b>	<p>Site : 03CH07-HY Condition : FCC CLASS-B 3m SHF-EHF_131029 HORIZONTAL Detector : Peak</p>	<p>Site : 03CH07-HY Condition : FCC CLASS-B 3m SHF-EHF_131029 VERTICAL Detector : Peak</p>



WIFI	Band 1 5150-5250MHz Harmonic @ 3m	
ANT	802.11n HT20 CH48 5240MHz	
1+2	Horizontal	Vertical
Peak Avg.	<p>Site : 03CH07-HY Condition : FCC CLASS-B 3m SHF-EHF_131029 HORIZONTAL Detector : Peak</p>	<p>Site : 03CH07-HY Condition : FCC CLASS-B 3m SHF-EHF_131029 VERTICAL Detector : Peak</p>





**Band 1 5150~5250MHz**  
**WIFI 802.11n HT40 (Harmonic @ 3m)**

<b>WIFI</b>	<b>Band 1 5150~5250MHz Harmonic @ 3m</b>	
<b>ANT</b>	<b>802.11n HT40 CH38 5190MHz</b>	
<b>1+2</b>	<b>Horizontal</b>	<b>Vertical</b>
<b>Peak</b> <b>Avg.</b>	<p>Site : 03CH07-HY Condition : FCC CLASS-B 3m SHF-EHF_131029 HORIZONTAL Detector : Peak</p>	<p>Site : 03CH07-HY Condition : FCC CLASS-B 3m SHF-EHF_131029 VERTICAL Detector : Peak</p>

<b>WIFI</b>	<b>Band 1 5150~5250MHz Harmonic @ 3m</b>	
<b>ANT</b>	<b>802.11n HT40 CH46 5230MHz</b>	
<b>1+2</b>	<b>Horizontal</b>	<b>Vertical</b>
<b>Peak</b> <b>Avg.</b>	<p>Site : 03CH07-HY Condition : FCC CLASS-B 3m SHF-EHF_131029 HORIZONTAL Detector : Peak</p>	<p>Site : 03CH07-HY Condition : FCC CLASS-B 3m SHF-EHF_131029 VERTICAL Detector : Peak</p>



**Band 1 5150~5250MHz**  
**WIFI 802.11ac VHT80 (Harmonic @ 3m)**

WIFI	Band 1 5150~5250MHz Harmonic @ 3m	
ANT	802.11ac VHT80 CH42 5210MHz	
1+2	Horizontal	Vertical
<p><b>Peak</b> <b>Avg.</b></p>	<p>Site : 03CH07-HY            Condition : FCC CLASS-B 3m SHF-EHF_131029 HORIZONTAL            Detector : Peak</p>	<p>Site : 03CH07-HY            Condition : FCC CLASS-B 3m SHF-EHF_131029 VERTICAL            Detector : Peak</p>



**Band 2 - 5250~5350MHz**  
**WIFI 802.11a (Band Edge @ 3m)**

WIFI	Band 2 5250~5350MHz Band Edge @ 3m	
ANT	802.11a CH52 5260MHz - Low channel location	
1+2	Horizontal	Vertical
<b>Peak</b>	<p>Site : 03CH07-HY            Condition : FCC CLASS-B 3m HF-ANT_130829 HORIZONTAL            Detector : Peak            RBW:1000.000kHz VBW:3000.000kHz SWT:Auto</p>	<p>Site : 03CH07-HY            Condition : FCC CLASS-B 3m HF-ANT_130829 VERTICAL            Detector : Peak            RBW:1000.000kHz VBW:3000.000kHz SWT:Auto</p>
<b>Avg.</b>	<p>Site : 03CH07-HY            Condition : FCC CLASS-B (AVG) 3m HF-ANT_130829 HORIZONTAL            Detector : Peak            RBW:1000.000kHz VBW:0.010kHz SWT:Auto</p>	<p>Site : 03CH07-HY            Condition : FCC CLASS-B (AVG) 3m HF-ANT_130829 VERTICAL            Detector : Peak            RBW:1000.000kHz VBW:0.010kHz SWT:Auto</p>

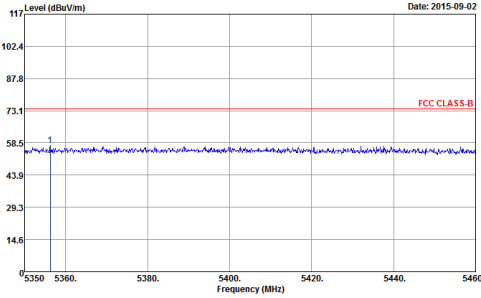
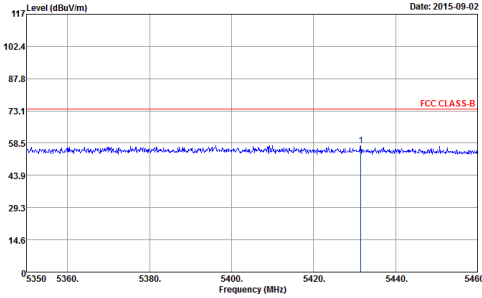
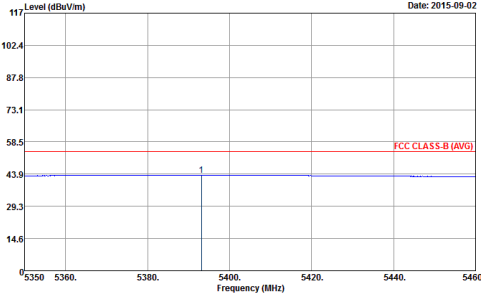
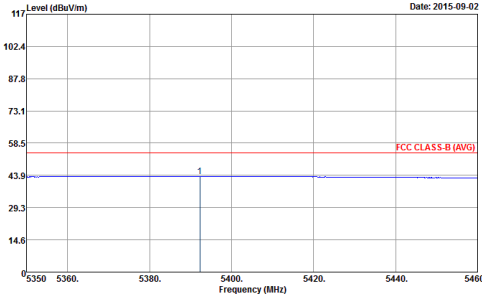

WIFI	Band 2 5250~5350MHz Band Edge @ 3m	
ANT	802.11a CH52 5260MHz - High channel location	
1+2	Horizontal	Vertical
Peak	 <p>Site : 03CH07-HY            Condition : FCC CLASS-B 3m HF-ANT_130829 HORIZONTAL            RBW:1000.000KHz VBW:3000.000KHz SWT:Auto            Detector : Peak</p>	 <p>Site : 03CH07-HY            Condition : FCC CLASS-B 3m HF-ANT_130829 VERTICAL            RBW:1000.000KHz VBW:3000.000KHz SWT:Auto            Detector : Peak</p>
Avg.	 <p>Site : 03CH07-HY            Condition : FCC CLASS-B (AVG) 3m HF-ANT_130829 HORIZONTAL            RBW:1000.000KHz VBW:0.010KHz SWT:Auto            Detector : Peak</p>	 <p>Site : 03CH07-HY            Condition : FCC CLASS-B (AVG) 3m HF-ANT_130829 VERTICAL            RBW:1000.000KHz VBW:0.010KHz SWT:Auto            Detector : Peak</p>

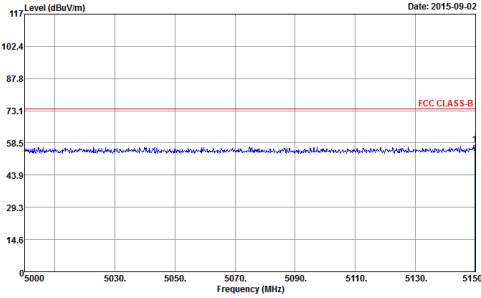
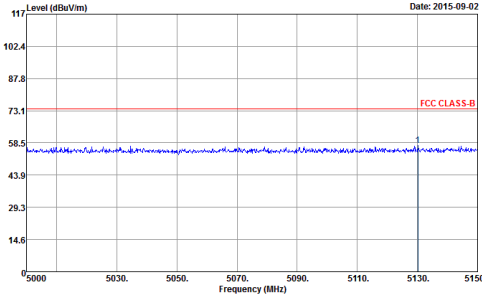
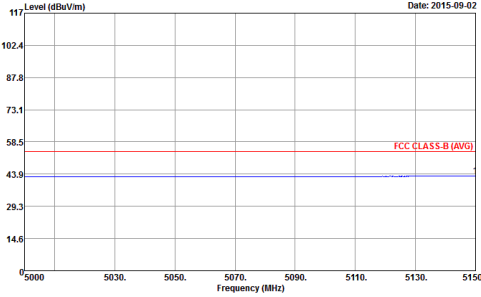
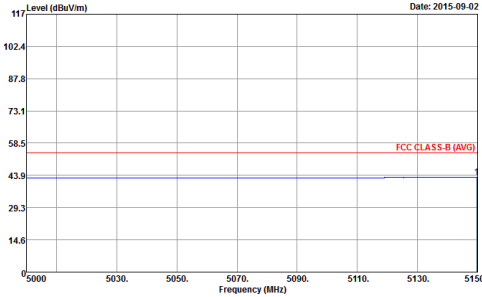

WIFI	Band 2 5250~5350MHz Band Edge @ 3m	
ANT	802.11a CH60 5300MHz - Low channel location	
1+2	Horizontal	Vertical
Peak	 <p>Site : 03CH07-HY Condition : FCC CLASS-B 3m HF-ANT_130829 HORIZONTAL RBW:1000.000kHz VBW:3000.000kHz SWT:Auto Detector : Peak</p>	 <p>Site : 03CH07-HY Condition : FCC CLASS-B 3m HF-ANT_130829 VERTICAL RBW:1000.000kHz VBW:3000.000kHz SWT:Auto Detector : Peak</p>
Avg.	 <p>Site : 03CH07-HY Condition : FCC CLASS-B (AVG) 3m HF-ANT_130829 HORIZONTAL RBW:1000.000kHz VBW:0.010kHz SWT:Auto Detector : Peak</p>	 <p>Site : 03CH07-HY Condition : FCC CLASS-B (AVG) 3m HF-ANT_130829 VERTICAL RBW:1000.000kHz VBW:0.010kHz SWT:Auto Detector : Peak</p>

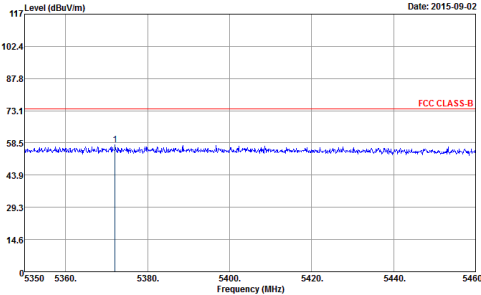
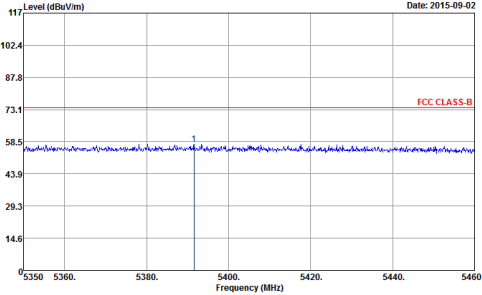
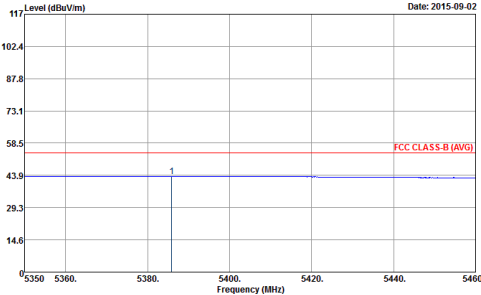
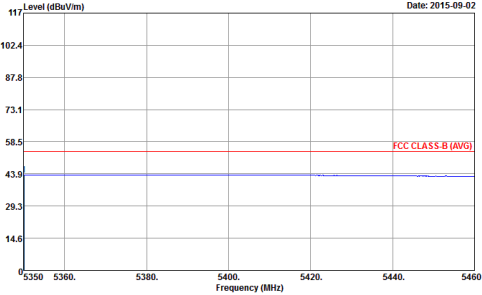

WIFI	Band 2 5250~5350MHz Band Edge @ 3m	
ANT	802.11a CH60 5300MHz - High channel location	
1+2	Horizontal	Vertical
Peak	 <p>Level (dBuV/m) vs Frequency (MHz) plot for Horizontal orientation. The y-axis ranges from 14.6 to 117 dBuV/m, and the x-axis ranges from 5350 to 5460 MHz. A red horizontal line indicates the FCC CLASS-B limit at 73.1 dBuV/m. The measured signal (blue line) is significantly below this limit, with a peak at approximately 5375 MHz.</p> <p>Site : 03CH07-HY            Condition : FCC CLASS-B 3m HF-ANT_130829 HORIZONTAL            RBW:1000.000KHz VBW:3000.000KHz SWT:Auto            Detector : Peak</p>	 <p>Level (dBuV/m) vs Frequency (MHz) plot for Vertical orientation. The y-axis ranges from 14.6 to 117 dBuV/m, and the x-axis ranges from 5350 to 5460 MHz. A red horizontal line indicates the FCC CLASS-B limit at 73.1 dBuV/m. The measured signal (blue line) is significantly below this limit, with a peak at approximately 5375 MHz.</p> <p>Site : 03CH07-HY            Condition : FCC CLASS-B 3m HF-ANT_130829 VERTICAL            RBW:1000.000KHz VBW:3000.000KHz SWT:Auto            Detector : Peak</p>
Avg.	 <p>Level (dBuV/m) vs Frequency (MHz) plot for Horizontal orientation showing average values. The y-axis ranges from 14.6 to 117 dBuV/m, and the x-axis ranges from 5350 to 5460 MHz. A red horizontal line indicates the FCC CLASS-B (AVG) limit at 58.5 dBuV/m. The measured signal (blue line) is consistently below this limit, with a peak at approximately 5375 MHz.</p> <p>Site : 03CH07-HY            Condition : FCC CLASS-B (AVG) 3m HF-ANT_130829 HORIZONTAL            RBW:1000.000KHz VBW:0.010KHz SWT:Auto            Detector : Peak</p>	 <p>Level (dBuV/m) vs Frequency (MHz) plot for Vertical orientation showing average values. The y-axis ranges from 14.6 to 117 dBuV/m, and the x-axis ranges from 5350 to 5460 MHz. A red horizontal line indicates the FCC CLASS-B (AVG) limit at 58.5 dBuV/m. The measured signal (blue line) is consistently below this limit, with a peak at approximately 5375 MHz.</p> <p>Site : 03CH07-HY            Condition : FCC CLASS-B (AVG) 3m HF-ANT_130829 VERTICAL            RBW:1000.000KHz VBW:0.010KHz SWT:Auto            Detector : Peak</p>

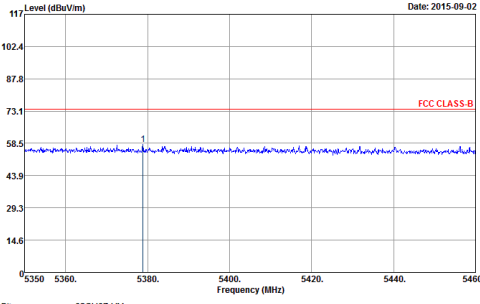
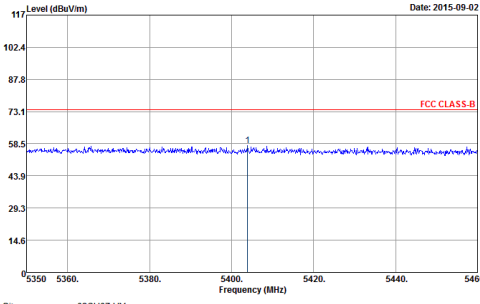
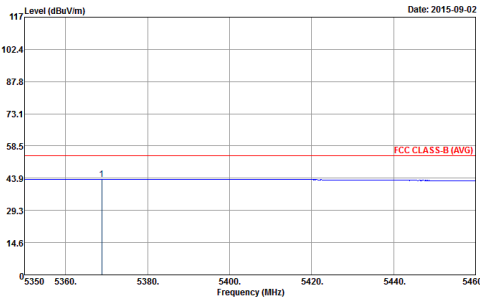
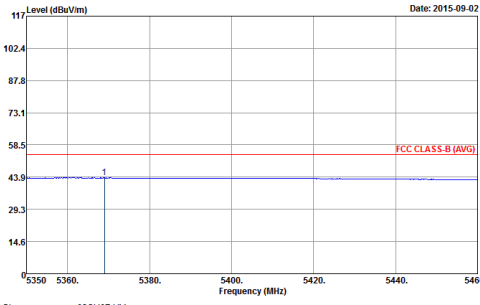

WIFI	Band 2 5250~5350MHz Band Edge @ 3m	
ANT	802.11a CH64 5320MHz	
1+2	Horizontal	Vertical
Peak	 <p>Date: 2015-09-02</p> <p>Site : 03CH07-HY Condition : FCC CLASS-B 3m HF-ANT_130829 HORIZONTAL RBW:1000.000KHz VBW:3000.000KHz SWT:Auto Detector : Peak</p>	 <p>Date: 2015-09-02</p> <p>Site : 03CH07-HY Condition : FCC CLASS-B 3m HF-ANT_130829 VERTICAL RBW:1000.000KHz VBW:3000.000KHz SWT:Auto Detector : Peak</p>
Avg.	 <p>Date: 2015-09-02</p> <p>Site : 03CH07-HY Condition : FCC CLASS-B (AVG) 3m HF-ANT_130829 HORIZONTAL RBW:1000.000KHz VBW:0.010KHz SWT:Auto Detector : Peak</p>	 <p>Date: 2015-09-02</p> <p>Site : 03CH07-HY Condition : FCC CLASS-B (AVG) 3m HF-ANT_130829 VERTICAL RBW:1000.000KHz VBW:0.010KHz SWT:Auto Detector : Peak</p>



Band 2 5250~5350MHz
WIFI 802.11n HT20 (Band Edge @ 3m)

Table with 4 columns: WIFI, ANT, 1+2, and Peak/Avg. It contains four spectral plots showing Level (dBuV/m) vs Frequency (MHz) for Horizontal and Vertical orientations. Each plot includes a red line for FCC CLASS-B limits and a blue line for the measured signal. The top row shows peak values, and the bottom row shows average values.



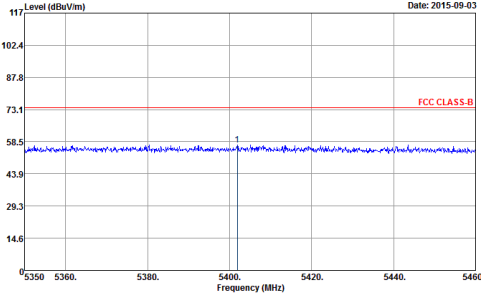
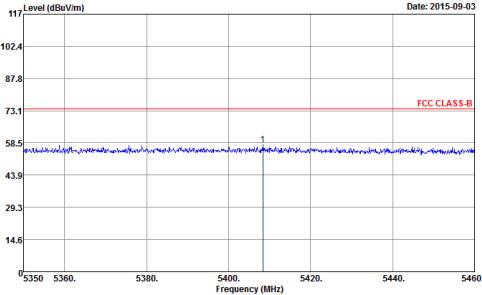
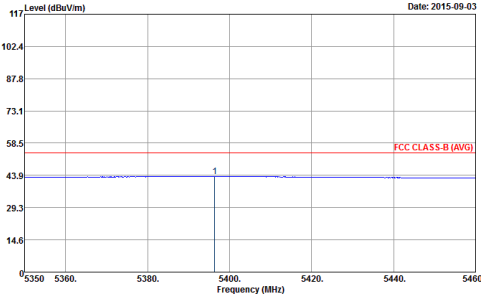
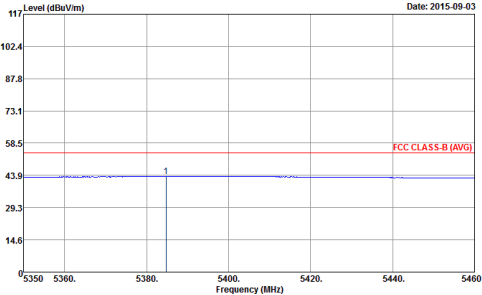

WIFI	Band 2 5250~5350MHz Band Edge @ 3m	
ANT	802.11n HT20 CH52 5260MHz - High channel location	
1+2	Horizontal	Vertical
Peak	 <p>Level (dBuV/m) vs Frequency (MHz) plot for Horizontal orientation. The y-axis ranges from 14.6 to 117 dBuV/m, and the x-axis ranges from 5350 to 5460 MHz. A red horizontal line indicates the FCC CLASS-B limit at 73.1 dBuV/m. A blue trace shows the measured signal with a peak at 5400 MHz. A vertical blue line labeled '1' marks the peak at 5400 MHz.</p> <p>Site : 03CH07-HY  Condition : FCC CLASS-B 3m HF-ANT_130829 HORIZONTAL  RBW:1000.000kHz VBW:3000.000kHz SWT:Auto  Detector : Peak</p>	 <p>Level (dBuV/m) vs Frequency (MHz) plot for Vertical orientation. The y-axis ranges from 14.6 to 117 dBuV/m, and the x-axis ranges from 5350 to 5460 MHz. A red horizontal line indicates the FCC CLASS-B limit at 73.1 dBuV/m. A blue trace shows the measured signal with a peak at 5400 MHz. A vertical blue line labeled '1' marks the peak at 5400 MHz.</p> <p>Site : 03CH07-HY  Condition : FCC CLASS-B 3m HF-ANT_130829 VERTICAL  RBW:1000.000kHz VBW:3000.000kHz SWT:Auto  Detector : Peak</p>
Avg.	 <p>Level (dBuV/m) vs Frequency (MHz) plot for Horizontal orientation. The y-axis ranges from 14.6 to 117 dBuV/m, and the x-axis ranges from 5350 to 5460 MHz. A red horizontal line indicates the FCC CLASS-B (AVG) limit at 58.5 dBuV/m. A blue trace shows the averaged signal with a peak at 5400 MHz. A vertical blue line labeled '1' marks the peak at 5400 MHz.</p> <p>Site : 03CH07-HY  Condition : FCC CLASS-B (AVG) 3m HF-ANT_130829 HORIZONTAL  RBW:1000.000kHz VBW:0.010kHz SWT:Auto  Detector : Peak</p>	 <p>Level (dBuV/m) vs Frequency (MHz) plot for Vertical orientation. The y-axis ranges from 14.6 to 117 dBuV/m, and the x-axis ranges from 5350 to 5460 MHz. A red horizontal line indicates the FCC CLASS-B (AVG) limit at 58.5 dBuV/m. A blue trace shows the averaged signal with a peak at 5400 MHz. A vertical blue line labeled '1' marks the peak at 5400 MHz.</p> <p>Site : 03CH07-HY  Condition : FCC CLASS-B (AVG) 3m HF-ANT_130829 VERTICAL  RBW:1000.000kHz VBW:0.010kHz SWT:Auto  Detector : Peak</p>



WIFI	Band 2 5250~5350MHz Band Edge @ 3m	
ANT	802.11n HT20 CH60 5300MHz - Low channel location	
1+2	Horizontal	Vertical
Peak	<p>Level (dBuV/m) vs Frequency (MHz) plot for Horizontal orientation. The y-axis ranges from 14.6 to 117 dBuV/m, and the x-axis ranges from 5000 to 5150 MHz. A red horizontal line indicates the FCC CLASS-B limit at 73.1 dBuV/m. The blue trace shows a signal level around 58.5 dBuV/m with a small peak at 5140 MHz.</p> <p>Site : 03CH07-HY Condition : FCC CLASS-B 3m HF-ANT_130829 HORIZONTAL RBW:1000.000kHz VBW:3000.000kHz SWT:Auto Detector : Peak</p>	<p>Level (dBuV/m) vs Frequency (MHz) plot for Vertical orientation. The y-axis ranges from 14.6 to 117 dBuV/m, and the x-axis ranges from 5000 to 5150 MHz. A red horizontal line indicates the FCC CLASS-B limit at 73.1 dBuV/m. The blue trace shows a signal level around 58.5 dBuV/m with a small peak at 5140 MHz.</p> <p>Site : 03CH07-HY Condition : FCC CLASS-B 3m HF-ANT_130829 VERTICAL RBW:1000.000kHz VBW:3000.000kHz SWT:Auto Detector : Peak</p>
Avg.	<p>Level (dBuV/m) vs Frequency (MHz) plot for Horizontal orientation. The y-axis ranges from 14.6 to 117 dBuV/m, and the x-axis ranges from 5000 to 5150 MHz. A red horizontal line indicates the FCC CLASS-B (AVG) limit at 58.5 dBuV/m. The blue trace shows a signal level around 43.9 dBuV/m with a small peak at 5140 MHz.</p> <p>Site : 03CH07-HY Condition : FCC CLASS-B (AVG) 3m HF-ANT_130829 HORIZONTAL RBW:1000.000kHz VBW:0.010kHz SWT:Auto Detector : Peak</p>	<p>Level (dBuV/m) vs Frequency (MHz) plot for Vertical orientation. The y-axis ranges from 14.6 to 117 dBuV/m, and the x-axis ranges from 5000 to 5150 MHz. A red horizontal line indicates the FCC CLASS-B (AVG) limit at 58.5 dBuV/m. The blue trace shows a signal level around 43.9 dBuV/m with a small peak at 5140 MHz.</p> <p>Site : 03CH07-HY Condition : FCC CLASS-B (AVG) 3m HF-ANT_130829 VERTICAL RBW:1000.000kHz VBW:0.010kHz SWT:Auto Detector : Peak</p>

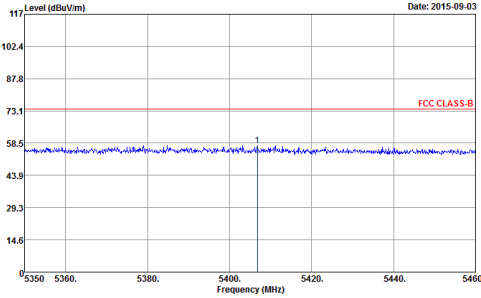
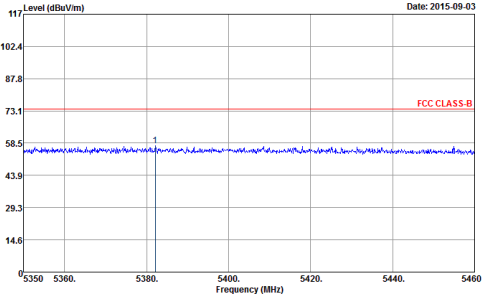
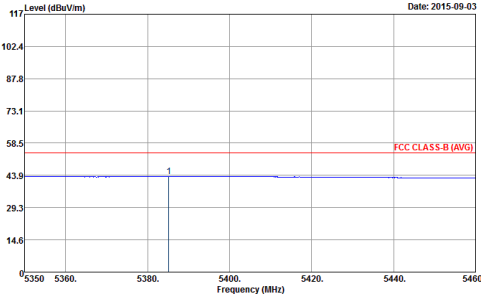
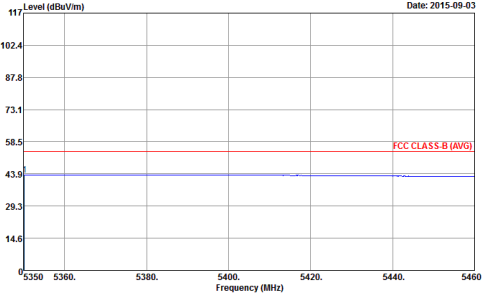

WIFI	Band 2 5250~5350MHz Band Edge @ 3m	
ANT	802.11n HT20 CH60 5300MHz - High channel location	
1+2	Horizontal	Vertical
Peak	 <p>Date: 2015-09-03</p> <p>Level (dBuV/m): 117, 102.4, 87.8, 73.1, 58.5, 43.9, 29.3, 14.6</p> <p>Frequency (MHz): 5350, 5360, 5380, 5400, 5420, 5440, 5460</p> <p>Site : 03CH07-HY Condition : FCC CLASS-B 3m HF-ANT_130829 HORIZONTAL RBW:1000.000kHz VBW:3000.000kHz SWT:Auto Detector : Peak</p>	 <p>Date: 2015-09-03</p> <p>Level (dBuV/m): 117, 102.4, 87.8, 73.1, 58.5, 43.9, 29.3, 14.6</p> <p>Frequency (MHz): 5350, 5360, 5380, 5400, 5420, 5440, 5460</p> <p>Site : 03CH07-HY Condition : FCC CLASS-B 3m HF-ANT_130829 VERTICAL RBW:1000.000kHz VBW:3000.000kHz SWT:Auto Detector : Peak</p>
Avg.	 <p>Date: 2015-09-03</p> <p>Level (dBuV/m): 117, 102.4, 87.8, 73.1, 58.5, 43.9, 29.3, 14.6</p> <p>Frequency (MHz): 5350, 5360, 5380, 5400, 5420, 5440, 5460</p> <p>Site : 03CH07-HY Condition : FCC CLASS-B (AVG) 3m HF-ANT_130829 HORIZONTAL RBW:1000.000kHz VBW:0.010kHz SWT:Auto Detector : Peak</p>	 <p>Date: 2015-09-03</p> <p>Level (dBuV/m): 117, 102.4, 87.8, 73.1, 58.5, 43.9, 29.3, 14.6</p> <p>Frequency (MHz): 5350, 5360, 5380, 5400, 5420, 5440, 5460</p> <p>Site : 03CH07-HY Condition : FCC CLASS-B (AVG) 3m HF-ANT_130829 VERTICAL RBW:1000.000kHz VBW:0.010kHz SWT:Auto Detector : Peak</p>

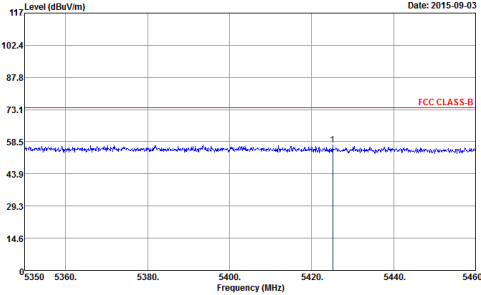
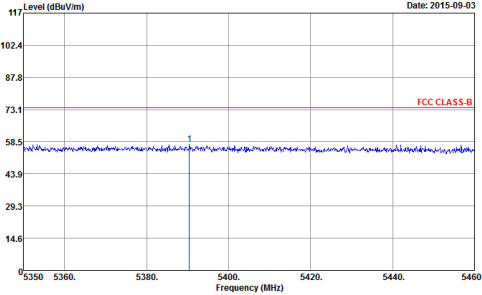
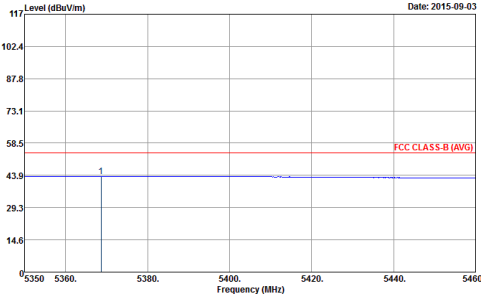
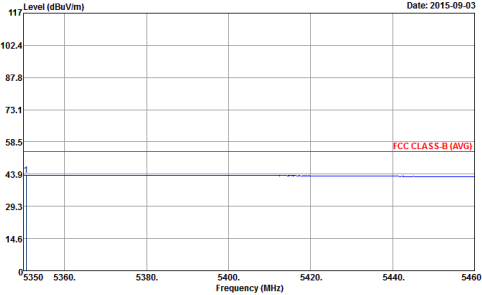

WIFI	Band 2 5250~5350MHz Band Edge @ 3m	
ANT	802.11n HT20 CH64 5320MHz	
1+2	Horizontal	Vertical
Peak	 <p>Level (dBuV/m) vs Frequency (MHz) plot for Horizontal orientation. The y-axis ranges from 14.6 to 117 dBuV/m, and the x-axis ranges from 5350 to 5460 MHz. A red horizontal line indicates the FCC CLASS-B limit at 73.1 dBuV/m. The measured signal (blue line) is significantly below this limit, with a peak value of approximately 58.5 dBuV/m. A small peak is visible at 5320 MHz.</p> <p>Site : 03CH07-HY  Condition : FCC CLASS-B 3m HF-ANT_130829 HORIZONTAL  RBW:1000.000KHz VBW:3000.000KHz SWT:Auto  Detector : Peak</p>	 <p>Level (dBuV/m) vs Frequency (MHz) plot for Vertical orientation. The y-axis ranges from 14.6 to 117 dBuV/m, and the x-axis ranges from 5350 to 5460 MHz. A red horizontal line indicates the FCC CLASS-B limit at 73.1 dBuV/m. The measured signal (blue line) is significantly below this limit, with a peak value of approximately 58.5 dBuV/m. A small peak is visible at 5320 MHz.</p> <p>Site : 03CH07-HY  Condition : FCC CLASS-B 3m HF-ANT_130829 VERTICAL  RBW:1000.000KHz VBW:3000.000KHz SWT:Auto  Detector : Peak</p>
Avg.	 <p>Level (dBuV/m) vs Frequency (MHz) plot for Horizontal orientation. The y-axis ranges from 14.6 to 117 dBuV/m, and the x-axis ranges from 5350 to 5460 MHz. A red horizontal line indicates the FCC CLASS-B (AVG) limit at 58.5 dBuV/m. The measured signal (blue line) is consistently below this limit, with an average value of approximately 43.9 dBuV/m. A small peak is visible at 5320 MHz.</p> <p>Site : 03CH07-HY  Condition : FCC CLASS-B (AVG) 3m HF-ANT_130829 HORIZONTAL  RBW:1000.000KHz VBW:0.010KHz SWT:Auto  Detector : Peak</p>	 <p>Level (dBuV/m) vs Frequency (MHz) plot for Vertical orientation. The y-axis ranges from 14.6 to 117 dBuV/m, and the x-axis ranges from 5350 to 5460 MHz. A red horizontal line indicates the FCC CLASS-B (AVG) limit at 58.5 dBuV/m. The measured signal (blue line) is consistently below this limit, with an average value of approximately 43.9 dBuV/m. A small peak is visible at 5320 MHz.</p> <p>Site : 03CH07-HY  Condition : FCC CLASS-B (AVG) 3m HF-ANT_130829 VERTICAL  RBW:1000.000KHz VBW:0.010KHz SWT:Auto  Detector : Peak</p>



**Band 2 5250~5350MHz  
WIFI 802.11n HT40 (Band Edge @ 3m)**

WIFI	Band 2 5250~5350MHz Band Edge @ 3m	
ANT	802.11n HT40 CH54 5270 MHz- Low channel location	
1+2	Horizontal	Vertical
<b>Peak</b>	<p>Site : 03CH07-HY Condition : FCC CLASS-B 3m HF-ANT_130829 HORIZONTAL Detector : Peak RBW:1000.000kHz VBW:3000.000kHz SWT:Auto</p>	<p>Site : 03CH07-HY Condition : FCC CLASS-B 3m HF-ANT_130829 VERTICAL Detector : Peak RBW:1000.000kHz VBW:3000.000kHz SWT:Auto</p>
<b>Avg.</b>	<p>Site : 03CH07-HY Condition : FCC CLASS-B (AVG) 3m HF-ANT_130829 HORIZONTAL Detector : Peak RBW:1000.000kHz VBW:2.000kHz SWT:Auto</p>	<p>Site : 03CH07-HY Condition : FCC CLASS-B (AVG) 3m HF-ANT_130829 VERTICAL Detector : Peak RBW:1000.000kHz VBW:2.000kHz SWT:Auto</p>

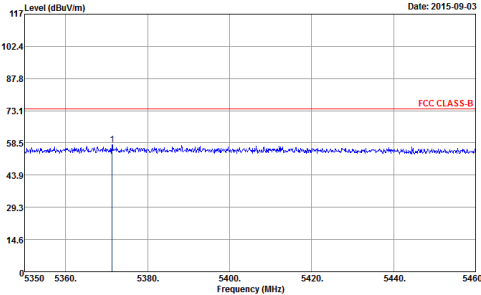
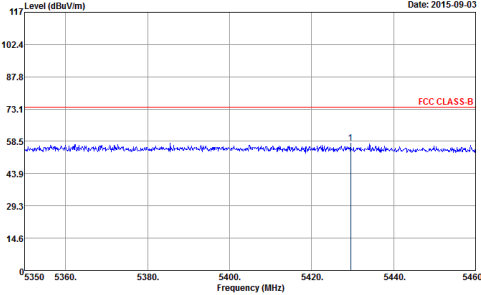
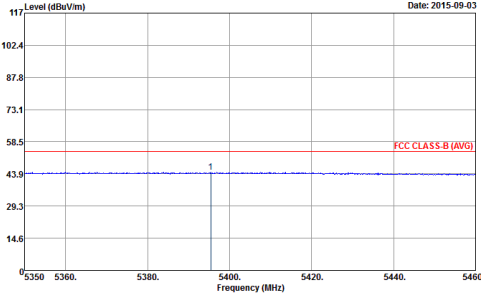
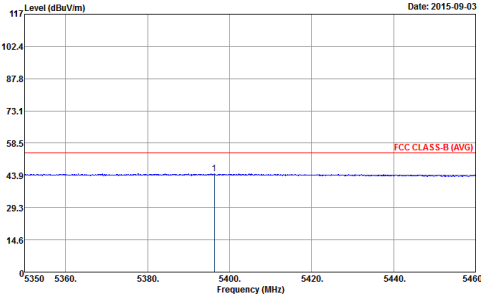

WIFI	Band 2 5250~5350MHz Band Edge @ 3m	
ANT	802.11n HT40 CH54 5270 MHz - High channel location	
1+2	Horizontal	Vertical
Peak	 <p>Level (dBuV/m) vs Frequency (MHz) plot for Horizontal orientation. The y-axis ranges from 14.6 to 117 dBuV/m. The x-axis ranges from 5350 to 5460 MHz. A red horizontal line indicates the FCC CLASS-B limit at 73.1 dBuV/m. The measured signal is significantly below this limit, with a peak at approximately 5375 MHz.</p> <p>Site : 03CH07-HY            Condition : FCC CLASS-B 3m HF-ANT_130829 HORIZONTAL            RBW:1000.000KHz VBW:3000.000KHz SWT:Auto            Detector : Peak</p>	 <p>Level (dBuV/m) vs Frequency (MHz) plot for Vertical orientation. The y-axis ranges from 14.6 to 117 dBuV/m. The x-axis ranges from 5350 to 5460 MHz. A red horizontal line indicates the FCC CLASS-B limit at 73.1 dBuV/m. The measured signal is significantly below this limit, with a peak at approximately 5375 MHz.</p> <p>Site : 03CH07-HY            Condition : FCC CLASS-B 3m HF-ANT_130829 VERTICAL            RBW:1000.000KHz VBW:3000.000KHz SWT:Auto            Detector : Peak</p>
Avg.	 <p>Level (dBuV/m) vs Frequency (MHz) plot for Horizontal orientation showing average values. The y-axis ranges from 14.6 to 117 dBuV/m. The x-axis ranges from 5350 to 5460 MHz. A red horizontal line indicates the FCC CLASS-B (AVG) limit at 58.5 dBuV/m. The measured signal is below this limit, with a peak at approximately 5375 MHz.</p> <p>Site : 03CH07-HY            Condition : FCC CLASS-B (AVG) 3m HF-ANT_130829 HORIZONTAL            RBW:1000.000KHz VBW:2.000KHz SWT:Auto            Detector : Peak</p>	 <p>Level (dBuV/m) vs Frequency (MHz) plot for Vertical orientation showing average values. The y-axis ranges from 14.6 to 117 dBuV/m. The x-axis ranges from 5350 to 5460 MHz. A red horizontal line indicates the FCC CLASS-B (AVG) limit at 58.5 dBuV/m. The measured signal is below this limit, with a peak at approximately 5375 MHz.</p> <p>Site : 03CH07-HY            Condition : FCC CLASS-B (AVG) 3m HF-ANT_130829 VERTICAL            RBW:1000.000KHz VBW:2.000KHz SWT:Auto            Detector : Peak</p>

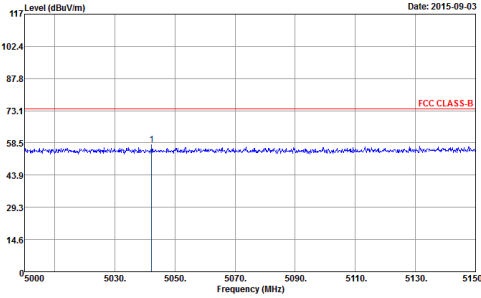
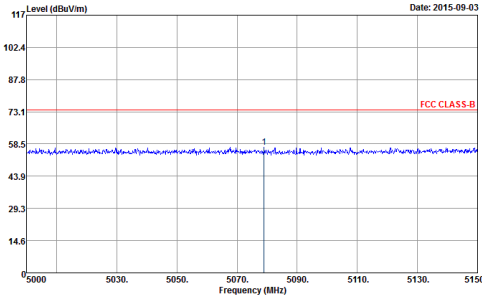
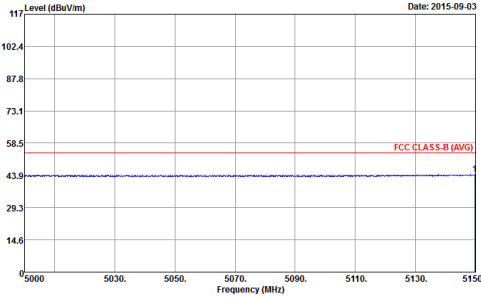
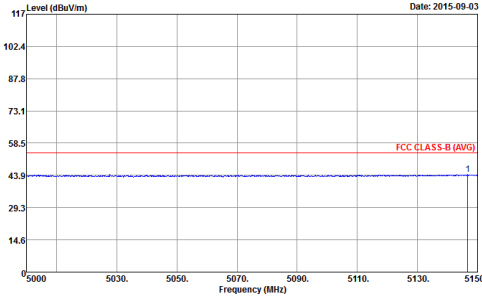

WIFI	Band 2 5250~5350MHz Band Edge @ 3m	
ANT	802.11n HT40 CH62 5310 MHz - Low channel location	
1+2	Horizontal	Vertical
Peak	 <p>Site : 03CH07-HY Condition : FCC CLASS-B 3m HF-ANT_130829 HORIZONTAL RBW:1000.000kHz VBW:3000.000kHz SWT:Auto Detector : Peak</p>	 <p>Site : 03CH07-HY Condition : FCC CLASS-B 3m HF-ANT_130829 VERTICAL RBW:1000.000kHz VBW:3000.000kHz SWT:Auto Detector : Peak</p>
Avg.	 <p>Site : 03CH07-HY Condition : FCC CLASS-B (AVG) 3m HF-ANT_130829 HORIZONTAL RBW:1000.000kHz VBW:2.000kHz SWT:Auto Detector : Peak</p>	 <p>Site : 03CH07-HY Condition : FCC CLASS-B (AVG) 3m HF-ANT_130829 VERTICAL RBW:1000.000kHz VBW:2.000kHz SWT:Auto Detector : Peak</p>

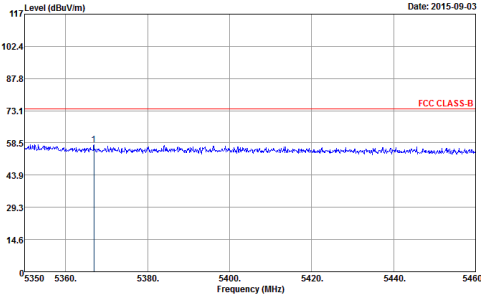
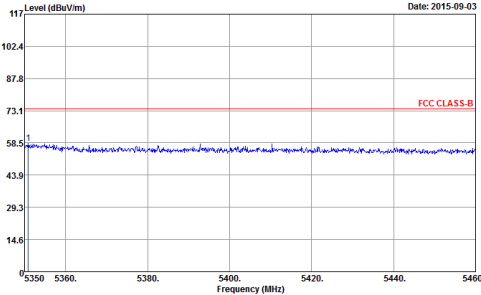
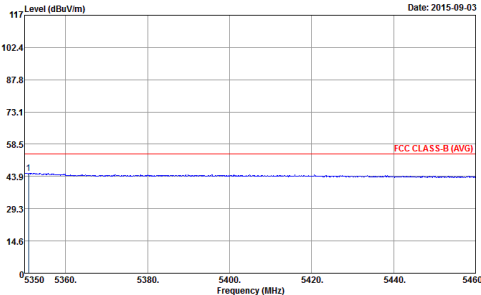
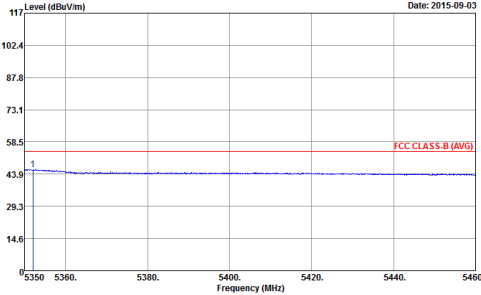

WIFI	Band 2 5250~5350MHz Band Edge @ 3m	
ANT	802.11n HT40 CH62 5310 MHz - High channel location	
1+2	Horizontal	Vertical
Peak	 <p>Site : 03CH07-HY            Condition : FCC CLASS-B 3m HF-ANT_130829 HORIZONTAL            RBW:1000.000kHz VBW:3000.000kHz SWT:Auto            Detector : Peak</p>	 <p>Site : 03CH07-HY            Condition : FCC CLASS-B 3m HF-ANT_130829 VERTICAL            RBW:1000.000kHz VBW:3000.000kHz SWT:Auto            Detector : Peak</p>
Avg.	 <p>Site : 03CH07-HY            Condition : FCC CLASS-B (AVG) 3m HF-ANT_130829 HORIZONTAL            RBW:1000.000kHz VBW:2.000kHz SWT:Auto            Detector : Peak</p>	 <p>Site : 03CH07-HY            Condition : FCC CLASS-B (AVG) 3m HF-ANT_130829 VERTICAL            RBW:1000.000kHz VBW:2.000kHz SWT:Auto            Detector : Peak</p>





**Band 2 5250~5350MHz**  
**WIFI 802.11ac VHT80 (Band Edge @ 3m)**

WIFI	Band 2 5250~5350MHz Band Edge @ 3m	
ANT	802.11ac VHT80 CH58 5290MHz - Low channel location	
1+2	Horizontal	Vertical
<b>Peak</b>	<p>Level (dBuV/m) vs Frequency (MHz) plot for Horizontal polarization. The y-axis ranges from 14.6 to 117 dBuV/m, and the x-axis ranges from 5000 to 5150 MHz. A red horizontal line indicates the FCC CLASS-B limit at 73.1 dBuV/m. The measured signal (blue line) is consistently below this limit, with a peak value of approximately 58.5 dBuV/m. A small peak is visible at 5130 MHz.</p> <p>Site : 03CH07-HY            Condition : FCC CLASS-B 3m HF-ANT_130829 HORIZONTAL            RBW:1000.000kHz VBW:3000.000kHz SWT:Auto            Detector : Peak</p>	<p>Level (dBuV/m) vs Frequency (MHz) plot for Vertical polarization. The y-axis ranges from 14.6 to 117 dBuV/m, and the x-axis ranges from 5000 to 5150 MHz. A red horizontal line indicates the FCC CLASS-B limit at 73.1 dBuV/m. The measured signal (blue line) is consistently below this limit, with a peak value of approximately 58.5 dBuV/m. A small peak is visible at 5130 MHz.</p> <p>Site : 03CH07-HY            Condition : FCC CLASS-B 3m HF-ANT_130829 VERTICAL            RBW:1000.000kHz VBW:3000.000kHz SWT:Auto            Detector : Peak</p>
<b>Avg.</b>	<p>Level (dBuV/m) vs Frequency (MHz) plot for Horizontal polarization. The y-axis ranges from 14.6 to 117 dBuV/m, and the x-axis ranges from 5000 to 5150 MHz. A red horizontal line indicates the FCC CLASS-B (AVG) limit at 58.5 dBuV/m. The measured signal (blue line) is consistently below this limit, with an average value of approximately 43.9 dBuV/m. A small peak is visible at 5130 MHz.</p> <p>Site : 03CH07-HY            Condition : FCC CLASS-B (AVG) 3m HF-ANT_130829 HORIZONTAL            RBW:1000.000kHz VBW:3.000kHz SWT:Auto            Detector : Peak</p>	<p>Level (dBuV/m) vs Frequency (MHz) plot for Vertical polarization. The y-axis ranges from 14.6 to 117 dBuV/m, and the x-axis ranges from 5000 to 5150 MHz. A red horizontal line indicates the FCC CLASS-B (AVG) limit at 58.5 dBuV/m. The measured signal (blue line) is consistently below this limit, with an average value of approximately 43.9 dBuV/m. A small peak is visible at 5130 MHz.</p> <p>Site : 03CH07-HY            Condition : FCC CLASS-B (AVG) 3m HF-ANT_130829 VERTICAL            RBW:1000.000kHz VBW:3.000kHz SWT:Auto            Detector : Peak</p>

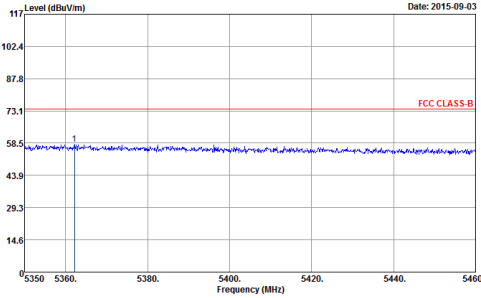
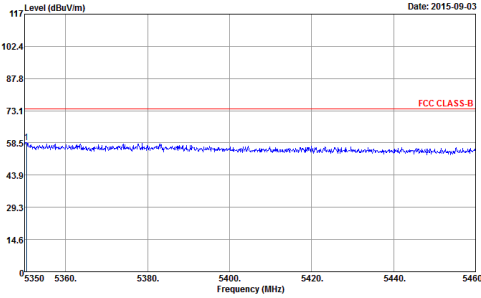
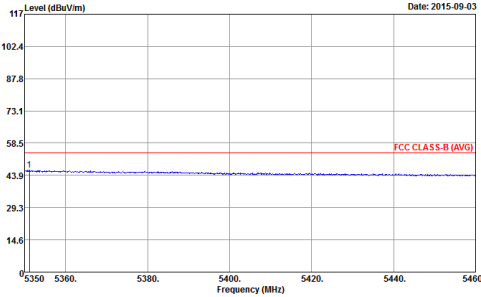
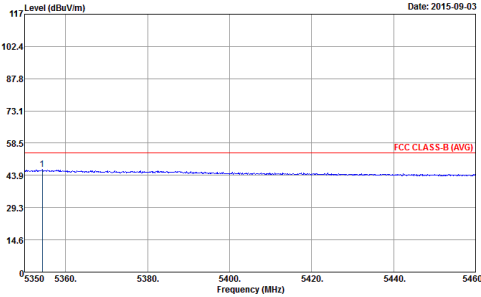

WIFI	Band 2 5250~5350MHz Band Edge @ 3m	
ANT	802.11ac VHT80 CH58 5290MHz - High channel location	
1+2	Horizontal	Vertical
Peak	 <p>Level (dBuV/m) vs Frequency (MHz) plot for Horizontal orientation. The y-axis ranges from 14.6 to 117 dBuV/m, and the x-axis ranges from 5350 to 5460 MHz. A red horizontal line indicates the FCC CLASS-B limit at 73.1 dBuV/m. The measured signal (blue line) is significantly below this limit, with a peak value of approximately 58.5 dBuV/m. A small peak is labeled '1' at approximately 5355 MHz.</p> <p>Site : 03CH07-HY  Condition : FCC CLASS-B 3m HF-ANT_130829 HORIZONTAL  RBW:1000.000kHz VBW:3000.000kHz SWT:Auto  Detector : Peak</p>	 <p>Level (dBuV/m) vs Frequency (MHz) plot for Vertical orientation. The y-axis ranges from 14.6 to 117 dBuV/m, and the x-axis ranges from 5350 to 5460 MHz. A red horizontal line indicates the FCC CLASS-B limit at 73.1 dBuV/m. The measured signal (blue line) is significantly below this limit, with a peak value of approximately 58.5 dBuV/m.</p> <p>Site : 03CH07-HY  Condition : FCC CLASS-B 3m HF-ANT_130829 VERTICAL  RBW:1000.000kHz VBW:3000.000kHz SWT:Auto  Detector : Peak</p>
Avg.	 <p>Level (dBuV/m) vs Frequency (MHz) plot for Horizontal orientation. The y-axis ranges from 14.6 to 117 dBuV/m, and the x-axis ranges from 5350 to 5460 MHz. A red horizontal line indicates the FCC CLASS-B (AVG) limit at 58.5 dBuV/m. The measured signal (blue line) is consistently below this limit, with an average value of approximately 43.9 dBuV/m. A small peak is labeled '1' at approximately 5355 MHz.</p> <p>Site : 03CH07-HY  Condition : FCC CLASS-B (AVG) 3m HF-ANT_130829 HORIZONTAL  RBW:1000.000kHz VBW:3.000kHz SWT:Auto  Detector : Peak</p>	 <p>Level (dBuV/m) vs Frequency (MHz) plot for Vertical orientation. The y-axis ranges from 14.6 to 117 dBuV/m, and the x-axis ranges from 5350 to 5460 MHz. A red horizontal line indicates the FCC CLASS-B (AVG) limit at 58.5 dBuV/m. The measured signal (blue line) is consistently below this limit, with an average value of approximately 43.9 dBuV/m.</p> <p>Site : 03CH07-HY  Condition : FCC CLASS-B (AVG) 3m HF-ANT_130829 VERTICAL  RBW:1000.000kHz VBW:3.000kHz SWT:Auto  Detector : Peak</p>



Band 2 - 5250~5350MHz
WIFI 802.11a (Harmonic @ 3m)

Table with 3 columns: WIFI, ANT, and 1+2. It contains two graphs showing Level (dBuV/m) vs Frequency (MHz) for Horizontal and Vertical orientations. The graphs include FCC CLASS-B and FCC CLASS-B (AVG) limits and two peak markers labeled 1 and 2.

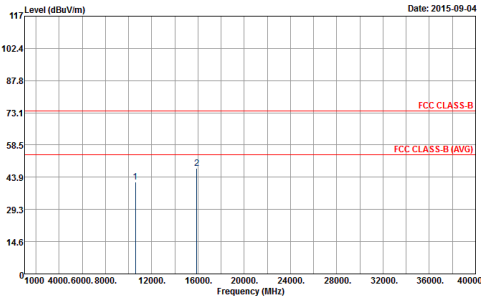
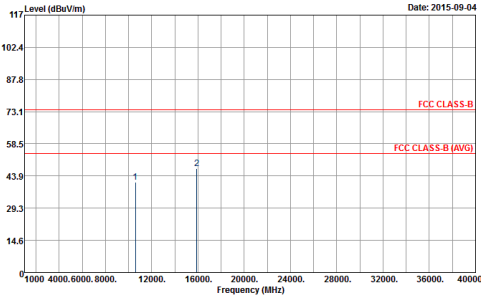

WIFI	Band 2 5250-5350MHz Harmonic @ 3m	
ANT	802.11a CH60 5300MHz	
1+2	Horizontal	Vertical
Peak Avg.	 <p>Site : 03CH07-HY Condition : FCC CLASS-B 3m SHF-EHF_131029 HORIZONTAL Detector : Peak</p>	 <p>Site : 03CH07-HY Condition : FCC CLASS-B 3m SHF-EHF_131029 VERTICAL Detector : Peak</p>

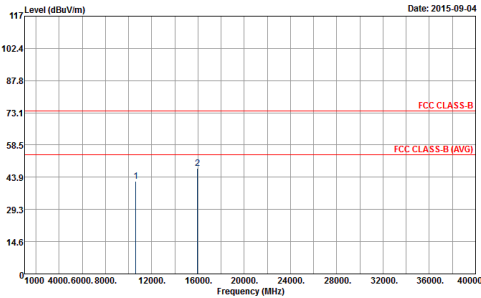
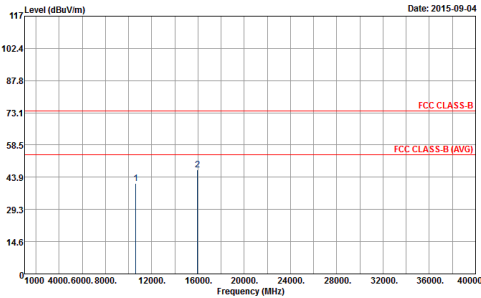

WIFI	Band 2 5250-5350MHz Harmonic @ 3m	
ANT	802.11a CH64 5320MHz	
1+2	Horizontal	Vertical
Peak Avg.	 <p>Site : 03CH07-HY Condition : FCC CLASS-B 3m SHF-EHF_131029 HORIZONTAL Detector : Peak</p>	 <p>Site : 03CH07-HY Condition : FCC CLASS-B 3m SHF-EHF_131029 VERTICAL Detector : Peak</p>



**Band 2 5250~5350MHz  
WIFI 802.11n HT20 (Harmonic @ 3m)**

WIFI	Band 2 5250~5350MHz Harmonic @ 3m	
ANT	802.11n HT20 CH52 5260MHz	
1+2	Horizontal	Vertical
<p><b>Peak</b> <b>Avg.</b></p>	<p>Site : 03CH07-HY Condition : FCC CLASS-B 3m SHF-EHF_131029 HORIZONTAL Detector : Peak</p>	<p>Site : 03CH07-HY Condition : FCC CLASS-B 3m SHF-EHF_131029 VERTICAL Detector : Peak</p>



WIFI	Band 2 5250-5350MHz Harmonic @ 3m	
ANT	802.11n HT20 CH60 5300MHz	
1+2	Horizontal	Vertical
<b>Peak</b> <b>Avg.</b>	<p>Site : 03CH07-HY Condition : FCC CLASS-B 3m SHF-EHF_131029 HORIZONTAL Detector : Peak</p>	<p>Site : 03CH07-HY Condition : FCC CLASS-B 3m SHF-EHF_131029 VERTICAL Detector : Peak</p>

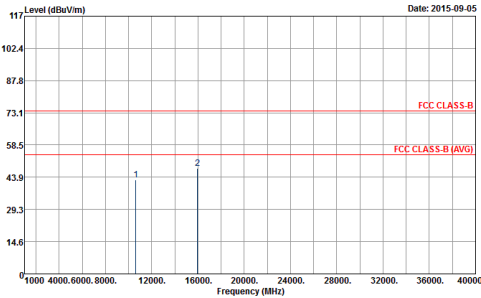
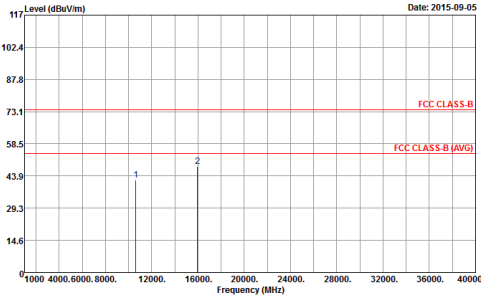

WIFI	Band 2 5250-5350MHz Harmonic @ 3m	
ANT	802.11n HT20 CH64 5320MHz	
1+2	Horizontal	Vertical
Peak Avg.	 <p>Site : 03CH07-HY Condition : FCC CLASS-B 3m SHF-EHF_131029 HORIZONTAL Detector : Peak</p>	 <p>Site : 03CH07-HY Condition : FCC CLASS-B 3m SHF-EHF_131029 VERTICAL Detector : Peak</p>





Band 2 5250~5350MHz
WIFI 802.11n HT40 (Harmonic @ 3m)

Table with 3 columns: WIFI, ANT, 1+2. It contains two graphs showing Level (dBuV/m) vs Frequency (MHz) for Horizontal and Vertical orientations. The graphs include FCC CLASS-B and FCC CLASS-B (AVG) limits and show two peaks labeled 1 and 2.



WIFI	Band 2 5250-5350MHz Harmonic @ 3m	
ANT	802.11n HT40 CH62 5310 MHz	
1+2	Horizontal	Vertical
Peak Avg.	<p>Site : 03CH07-HY Condition : FCC CLASS-B 3m SHF-EHF_131029 HORIZONTAL Detector : Peak</p>	<p>Site : 03CH07-HY Condition : FCC CLASS-B 3m SHF-EHF_131029 VERTICAL Detector : Peak</p>



Band 2 5250~5350MHz
WIFI 802.11ac VHT80 (Harmonic @ 3m)

Table with 3 columns: WIFI, ANT, 1+2. It contains two graphs showing Level (dBuV/m) vs Frequency (MHz) for Horizontal and Vertical orientations. The graphs include FCC CLASS-B and FCC CLASS-B (AVG) limits and two peaks labeled 1 and 2.



**Band 3 - 5470~5725MHz**  
**WIFI 802.11a (Band Edge @ 3m)**

WIFI	Band 3 5470~5725MHz Band Edge @ 3m	
ANT	802.11a CH100 5500MHz	
1+2	Horizontal	Vertical
<b>Peak</b>	<p>Date: 2015-09-02</p> <p>Site : 03CH07-HY            Condition : FCC CLASS-B 3m HF-ANT_130829 HORIZONTAL            RBW: 1000.000kHz VBW: 3000.000kHz SWT: Auto            Detector : Peak</p>	<p>Date: 2015-09-02</p> <p>Site : 03CH07-HY            Condition : FCC CLASS-B 3m HF-ANT_130829 VERTICAL            RBW: 1000.000kHz VBW: 3000.000kHz SWT: Auto            Detector : Peak</p>
<b>Avg.</b>	<p>Date: 2015-09-02</p> <p>Site : 03CH07-HY            Condition : FCC CLASS-B (AVG) 3m HF-ANT_130829 HORIZONTAL            RBW: 1000.000kHz VBW: 0.010kHz SWT: Auto            Detector : Peak</p>	<p>Date: 2015-09-02</p> <p>Site : 03CH07-HY            Condition : FCC CLASS-B (AVG) 3m HF-ANT_130829 VERTICAL            RBW: 1000.000kHz VBW: 0.010kHz SWT: Auto            Detector : Peak</p>

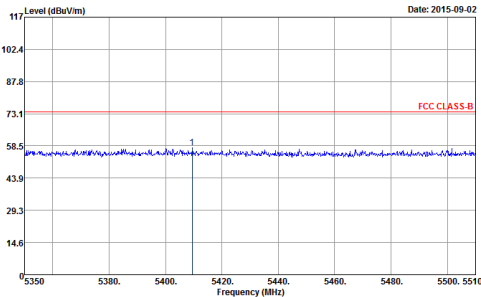
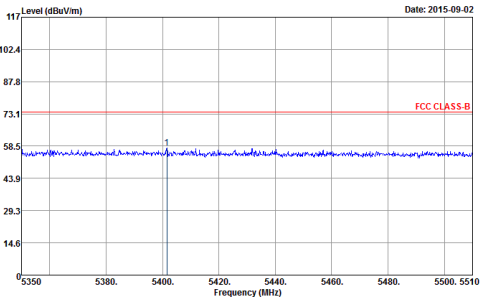
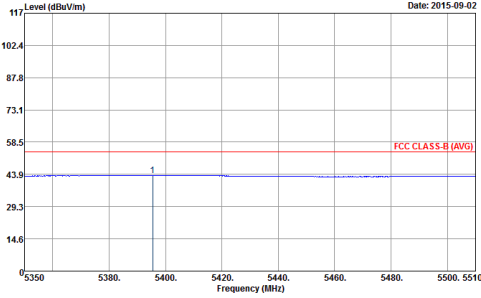
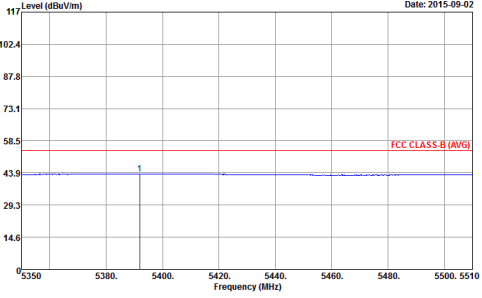

WIFI	Band 3 5470~5725MHz Band Edge @ 3m	
ANT	802.11a CH116 5580MHz - Low channel location	
1+2	Horizontal	Vertical
Peak	 <p>Date: 2015-09-02</p> <p>Site : 03CH07-HY Condition : FCC CLASS-B 3m HF-ANT_130829 HORIZONTAL RBW:1000.000kHz VBW:3000.000kHz SWT:Auto Detector : Peak</p>	 <p>Date: 2015-09-02</p> <p>Site : 03CH07-HY Condition : FCC CLASS-B 3m HF-ANT_130829 VERTICAL RBW:1000.000kHz VBW:3000.000kHz SWT:Auto Detector : Peak</p>
Avg.	 <p>Date: 2015-09-02</p> <p>Site : 03CH07-HY Condition : FCC CLASS-B (AVG) 3m HF-ANT_130829 HORIZONTAL RBW:1000.000kHz VBW:0.010kHz SWT:Auto Detector : Peak</p>	 <p>Date: 2015-09-02</p> <p>Site : 03CH07-HY Condition : FCC CLASS-B (AVG) 3m HF-ANT_130829 VERTICAL RBW:1000.000kHz VBW:0.010kHz SWT:Auto Detector : Peak</p>

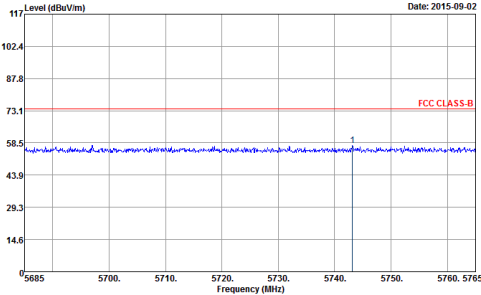
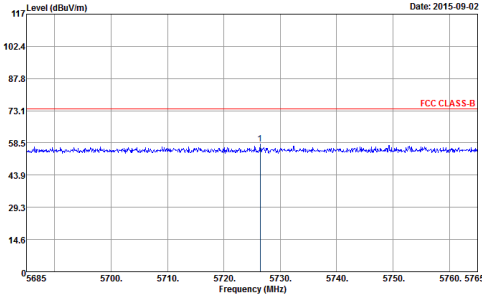
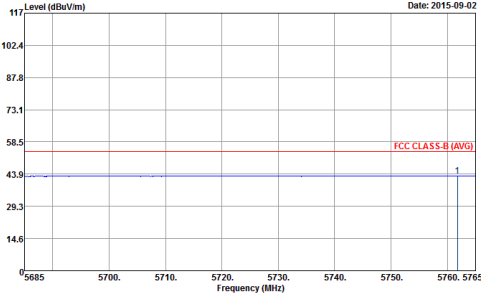
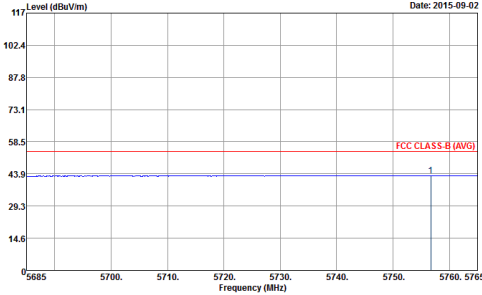

WIFI	Band 3 5470~5725MHz Band Edge @ 3m	
ANT	802.11a CH116 5580MHz - High channel location	
1+2	Horizontal	Vertical
Peak	 <p>Site : 03CH07-HY            Condition : FCC CLASS-B 3m HF-ANT_130829 HORIZONTAL            RBW:1000.000kHz VBW:3000.000kHz SWT:Auto            Detector : Peak</p>	 <p>Site : 03CH07-HY            Condition : FCC CLASS-B 3m HF-ANT_130829 VERTICAL            RBW:1000.000kHz VBW:3000.000kHz SWT:Auto            Detector : Peak</p>
Avg.	 <p>Site : 03CH07-HY            Condition : FCC CLASS-B (AVG) 3m HF-ANT_130829 HORIZONTAL            RBW:1000.000kHz VBW:0.010kHz SWT:Auto            Detector : Peak</p>	 <p>Site : 03CH07-HY            Condition : FCC CLASS-B (AVG) 3m HF-ANT_130829 VERTICAL            RBW:1000.000kHz VBW:0.010kHz SWT:Auto            Detector : Peak</p>

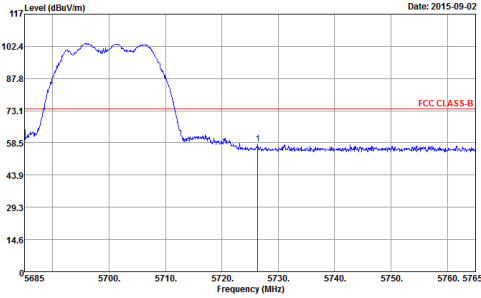
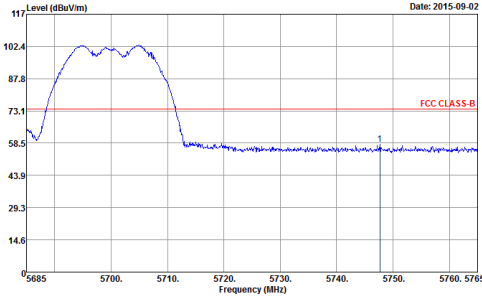
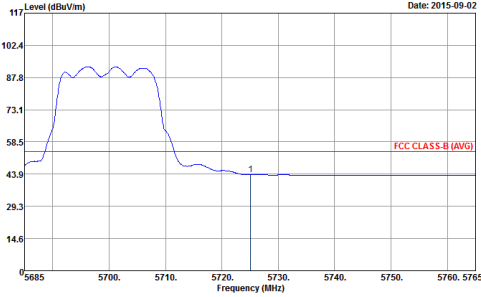
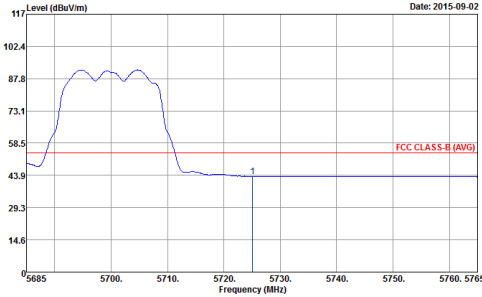

WIFI	Band 3 5470~5725MHz Band Edge @ 3m	
ANT	802.11a CH140 5700MHz	
1+2	Horizontal	Vertical
Peak	 <p>Level (dBuV/m) vs Frequency (MHz) plot for Horizontal orientation. The plot shows a signal between 5685 and 5765 MHz. A red horizontal line indicates the FCC CLASS-B limit at 73.1 dBuV/m. The signal peaks at approximately 102.4 dBuV/m. A vertical marker '1' is placed at 5720 MHz.</p> <p>Site : 03CH07-HY            Condition : FCC CLASS-B 3m HF-ANT_130829 HORIZONTAL            RBW:1000.000kHz VBW:3000.000kHz SWT:Auto            Detector : Peak</p>	 <p>Level (dBuV/m) vs Frequency (MHz) plot for Vertical orientation. The plot shows a signal between 5685 and 5765 MHz. A red horizontal line indicates the FCC CLASS-B limit at 73.1 dBuV/m. The signal peaks at approximately 102.4 dBuV/m. A vertical marker '1' is placed at 5720 MHz.</p> <p>Site : 03CH07-HY            Condition : FCC CLASS-B 3m HF-ANT_130829 VERTICAL            RBW:1000.000kHz VBW:3000.000kHz SWT:Auto            Detector : Peak</p>
Avg.	 <p>Level (dBuV/m) vs Frequency (MHz) plot for Horizontal orientation. The plot shows a signal between 5685 and 5765 MHz. A red horizontal line indicates the FCC CLASS-B (AVG) limit at 58.5 dBuV/m. The signal peaks at approximately 87.8 dBuV/m. A vertical marker '1' is placed at 5720 MHz.</p> <p>Site : 03CH07-HY            Condition : FCC CLASS-B (AVG) 3m HF-ANT_130829 HORIZONTAL            RBW:1000.000kHz VBW:0.010kHz SWT:Auto            Detector : Peak</p>	 <p>Level (dBuV/m) vs Frequency (MHz) plot for Vertical orientation. The plot shows a signal between 5685 and 5765 MHz. A red horizontal line indicates the FCC CLASS-B (AVG) limit at 58.5 dBuV/m. The signal peaks at approximately 87.8 dBuV/m. A vertical marker '1' is placed at 5720 MHz.</p> <p>Site : 03CH07-HY            Condition : FCC CLASS-B (AVG) 3m HF-ANT_130829 VERTICAL            RBW:1000.000kHz VBW:0.010kHz SWT:Auto            Detector : Peak</p>



Band 3 5470~5725MHz
WIFI 802.11n HT20 (Band Edge @ 3m)

Table with 4 columns: WIFI, ANT, 1+2, and Peak/Avg. It contains two rows of spectral plots for Horizontal and Vertical orientations, comparing Peak and Average (Avg.) results against the FCC CLASS-B limit.



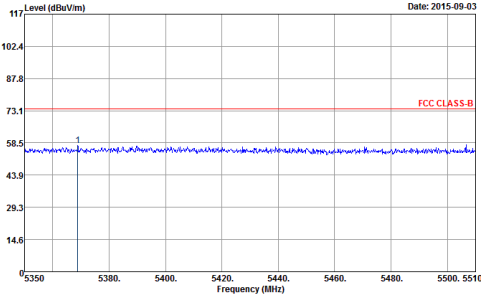
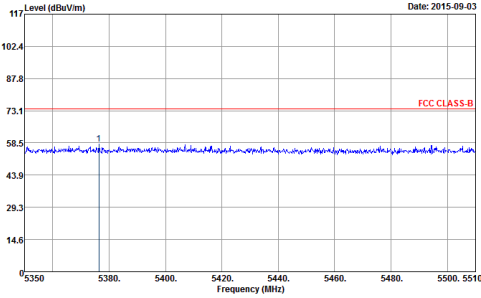
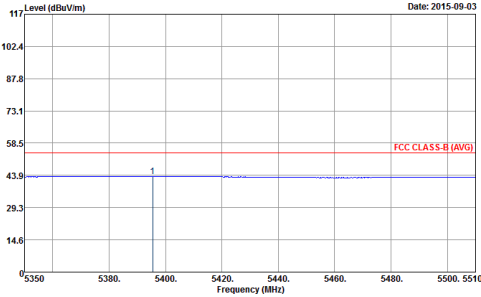
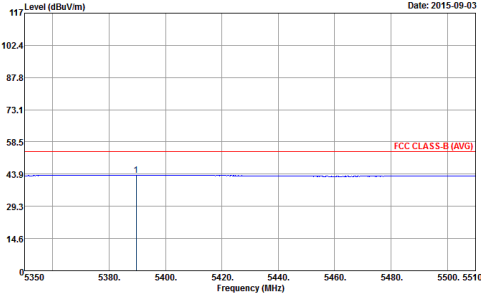

WIFI	Band 3 5470~5725MHz Band Edge @ 3m	
ANT	802.11n HT20 CH116 5580MHz - Low channel location	
1+2	Horizontal	Vertical
Peak	 <p>Level (dBuV/m) vs Frequency (MHz) plot for Horizontal orientation. The y-axis ranges from 14.6 to 117 dBuV/m, and the x-axis ranges from 5350 to 5510 MHz. A red horizontal line indicates the FCC CLASS-B limit at 73.1 dBuV/m. A blue signal line is visible below this limit, with a peak labeled '1' at approximately 5380 MHz. The plot date is 2015-09-03.</p> <p>Site : 03CH07-HY  Condition : FCC CLASS-B 3m HF-ANT_130829 HORIZONTAL  RBW:1000.000kHz VBW:3000.000kHz SWT:Auto  Detector : Peak</p>	 <p>Level (dBuV/m) vs Frequency (MHz) plot for Vertical orientation. The y-axis ranges from 14.6 to 117 dBuV/m, and the x-axis ranges from 5350 to 5510 MHz. A red horizontal line indicates the FCC CLASS-B limit at 73.1 dBuV/m. A blue signal line is visible below this limit, with a peak labeled '1' at approximately 5380 MHz. The plot date is 2015-09-03.</p> <p>Site : 03CH07-HY  Condition : FCC CLASS-B 3m HF-ANT_130829 VERTICAL  RBW:1000.000kHz VBW:3000.000kHz SWT:Auto  Detector : Peak</p>
Avg.	 <p>Level (dBuV/m) vs Frequency (MHz) plot for Horizontal orientation showing average values. The y-axis ranges from 14.6 to 117 dBuV/m, and the x-axis ranges from 5350 to 5510 MHz. A red horizontal line indicates the FCC CLASS-B (AVG) limit at 58.5 dBuV/m. A blue signal line is visible below this limit, with a peak labeled '1' at approximately 5380 MHz. The plot date is 2015-09-03.</p> <p>Site : 03CH07-HY  Condition : FCC CLASS-B (AVG) 3m HF-ANT_130829 HORIZONTAL  RBW:1000.000kHz VBW:0.010kHz SWT:Auto  Detector : Peak</p>	 <p>Level (dBuV/m) vs Frequency (MHz) plot for Vertical orientation showing average values. The y-axis ranges from 14.6 to 117 dBuV/m, and the x-axis ranges from 5350 to 5510 MHz. A red horizontal line indicates the FCC CLASS-B (AVG) limit at 58.5 dBuV/m. A blue signal line is visible below this limit, with a peak labeled '1' at approximately 5380 MHz. The plot date is 2015-09-03.</p> <p>Site : 03CH07-HY  Condition : FCC CLASS-B (AVG) 3m HF-ANT_130829 VERTICAL  RBW:1000.000kHz VBW:0.010kHz SWT:Auto  Detector : Peak</p>

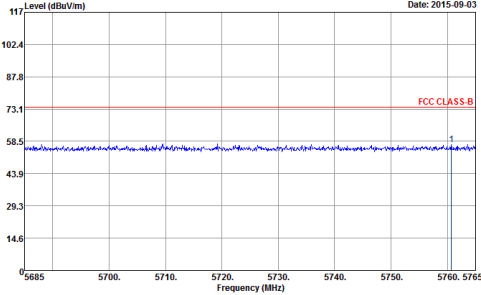
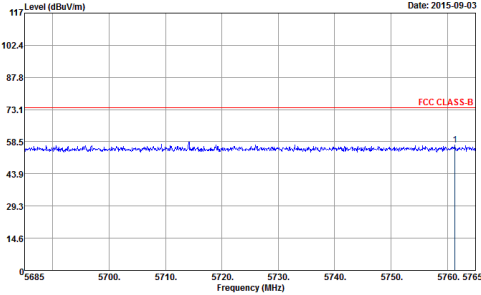
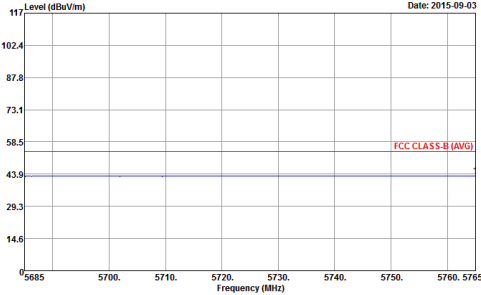
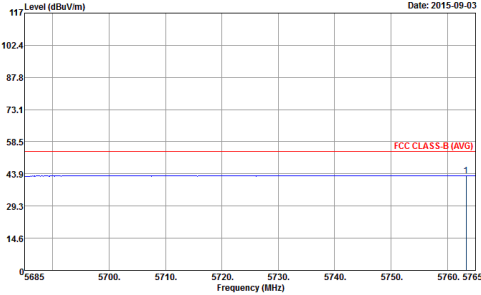

WIFI	Band 3 5470~5725MHz Band Edge @ 3m	
ANT	802.11n HT20 CH116 5580MHz - High channel location	
1+2	Horizontal	Vertical
Peak	 <p>Date: 2015-09-03</p> <p>Site : 03CH07-HY Condition : FCC CLASS-B 3m HF-ANT_130829 HORIZONTAL RBW:1000.000kHz VBW:3000.000kHz SWT:Auto Detector : Peak</p>	 <p>Date: 2015-09-03</p> <p>Site : 03CH07-HY Condition : FCC CLASS-B 3m HF-ANT_130829 VERTICAL RBW:1000.000kHz VBW:3000.000kHz SWT:Auto Detector : Peak</p>
Avg.	 <p>Date: 2015-09-03</p> <p>Site : 03CH07-HY Condition : FCC CLASS-B (AVG) 3m HF-ANT_130829 HORIZONTAL RBW:1000.000kHz VBW:0.010kHz SWT:Auto Detector : Peak</p>	 <p>Date: 2015-09-03</p> <p>Site : 03CH07-HY Condition : FCC CLASS-B (AVG) 3m HF-ANT_130829 VERTICAL RBW:1000.000kHz VBW:0.010kHz SWT:Auto Detector : Peak</p>



WIFI	Band 3 5470~5725MHz Band Edge @ 3m	
ANT	802.11n HT20 CH140 5700MHz	
1+2	Horizontal	Vertical
Peak	<p>Date: 2015-09-03</p> <p>Site : 03CH07-HY Condition : FCC CLASS-B 3m HF-ANT_130829 HORIZONTAL Detector : Peak</p>	<p>Date: 2015-09-03</p> <p>Site : 03CH07-HY Condition : FCC CLASS-B 3m HF-ANT_130829 VERTICAL Detector : Peak</p>
Avg.	<p>Date: 2015-09-03</p> <p>Site : 03CH07-HY Condition : FCC CLASS-B (AVG) 3m HF-ANT_130829 HORIZONTAL Detector : Peak</p>	<p>Date: 2015-09-03</p> <p>Site : 03CH07-HY Condition : FCC CLASS-B (AVG) 3m HF-ANT_130829 VERTICAL Detector : Peak</p>



**Band 3 5470~5725MHz  
WIFI 802.11n HT40 (Band Edge @ 3m)**

WIFI	Band 3 5470~5725MHz Band Edge @ 3m	
ANT	802.11n HT40 CH102 5510MHz - Low channel location	
1+2	Horizontal	Vertical
<b>Peak</b>	<p>Level (dBuV/m) vs Frequency (MHz) plot for Horizontal orientation. The y-axis ranges from 14.6 to 117 dBuV/m. The x-axis ranges from 5350 to 5510 MHz. A red horizontal line indicates the FCC CLASS-B limit at 73.1 dBuV/m. The blue signal line shows a sharp peak at approximately 5475 MHz, reaching about 102.4 dBuV/m.</p> <p>Site : 03CH07-HY Condition : FCC CLASS-B 3m HF-ANT_130829 HORIZONTAL RBW:1000.000kHz VBW:3000.000kHz SWT:Auto Detector : Peak</p>	<p>Level (dBuV/m) vs Frequency (MHz) plot for Vertical orientation. The y-axis ranges from 14.6 to 117 dBuV/m. The x-axis ranges from 5350 to 5510 MHz. A red horizontal line indicates the FCC CLASS-B limit at 73.1 dBuV/m. The blue signal line shows a sharp peak at approximately 5475 MHz, reaching about 102.4 dBuV/m.</p> <p>Site : 03CH07-HY Condition : FCC CLASS-B 3m HF-ANT_130829 VERTICAL RBW:1000.000kHz VBW:3000.000kHz SWT:Auto Detector : Peak</p>
<b>Avg.</b>	<p>Level (dBuV/m) vs Frequency (MHz) plot for Horizontal orientation. The y-axis ranges from 14.6 to 117 dBuV/m. The x-axis ranges from 5350 to 5510 MHz. A red horizontal line indicates the FCC CLASS-B (AVG) limit at 58.5 dBuV/m. The blue signal line shows a peak at approximately 5475 MHz, reaching about 87.8 dBuV/m.</p> <p>Site : 03CH07-HY Condition : FCC CLASS-B (AVG) 3m HF-ANT_130829 HORIZONTAL RBW:1000.000kHz VBW:2.000kHz SWT:Auto Detector : Peak</p>	<p>Level (dBuV/m) vs Frequency (MHz) plot for Vertical orientation. The y-axis ranges from 14.6 to 117 dBuV/m. The x-axis ranges from 5350 to 5510 MHz. A red horizontal line indicates the FCC CLASS-B (AVG) limit at 58.5 dBuV/m. The blue signal line shows a peak at approximately 5475 MHz, reaching about 87.8 dBuV/m.</p> <p>Site : 03CH07-HY Condition : FCC CLASS-B (AVG) 3m HF-ANT_130829 VERTICAL RBW:1000.000kHz VBW:2.000kHz SWT:Auto Detector : Peak</p>

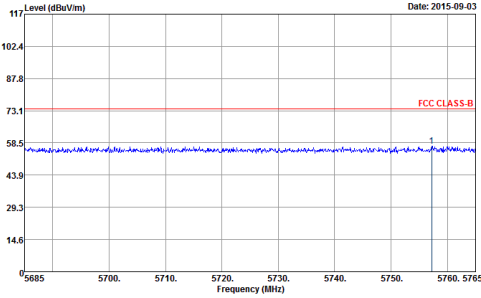
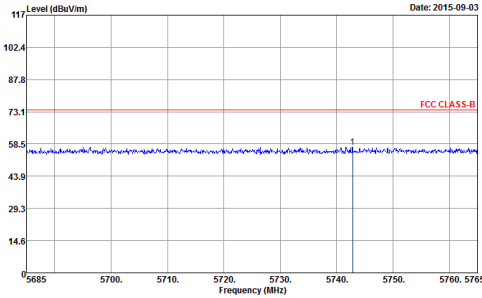
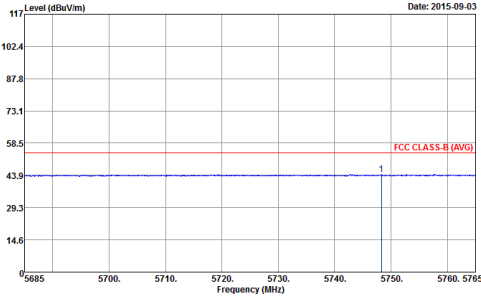
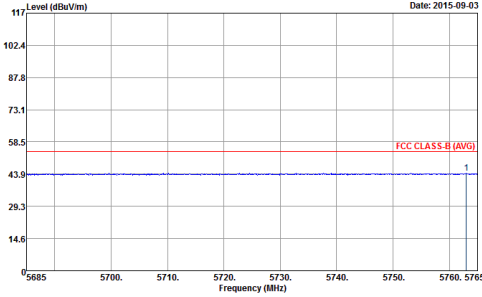

WIFI	Band 3 5470~5725MHz Band Edge @ 3m	
ANT	802.11n HT40 CH102 5510MHz - High channel location	
1+2	Horizontal	Vertical
Peak	 <p>Level (dBuV/m) vs Frequency (MHz) plot for Horizontal orientation. The plot shows a blue signal line fluctuating around a mean level of approximately 58.5 dBuV/m. A red horizontal line at 73.1 dBuV/m is labeled 'FCC CLASS-B'. A small peak is visible at approximately 5750 MHz. The x-axis ranges from 5685 to 5765 MHz, and the y-axis ranges from 14.6 to 117 dBuV/m.</p> <p>Site : 03CH07-HY            Condition : FCC CLASS-B 3m HF-ANT_130829 HORIZONTAL            RBW:1000.000kHz VBW:3000.000kHz SWT:Auto            Detector : Peak</p>	 <p>Level (dBuV/m) vs Frequency (MHz) plot for Vertical orientation. The plot shows a blue signal line fluctuating around a mean level of approximately 58.5 dBuV/m. A red horizontal line at 73.1 dBuV/m is labeled 'FCC CLASS-B'. A small peak is visible at approximately 5750 MHz. The x-axis ranges from 5685 to 5765 MHz, and the y-axis ranges from 14.6 to 117 dBuV/m.</p> <p>Site : 03CH07-HY            Condition : FCC CLASS-B 3m HF-ANT_130829 VERTICAL            RBW:1000.000kHz VBW:3000.000kHz SWT:Auto            Detector : Peak</p>
Avg.	 <p>Level (dBuV/m) vs Frequency (MHz) plot for Horizontal orientation showing average values. The blue signal line is flat at approximately 58.5 dBuV/m. A red horizontal line at 58.5 dBuV/m is labeled 'FCC CLASS-B (AVG)'. A small peak is visible at approximately 5750 MHz. The x-axis ranges from 5685 to 5765 MHz, and the y-axis ranges from 14.6 to 117 dBuV/m.</p> <p>Site : 03CH07-HY            Condition : FCC CLASS-B (AVG) 3m HF-ANT_130829 HORIZONTAL            RBW:1000.000kHz VBW:2.000kHz SWT:Auto            Detector : Peak</p>	 <p>Level (dBuV/m) vs Frequency (MHz) plot for Vertical orientation showing average values. The blue signal line is flat at approximately 58.5 dBuV/m. A red horizontal line at 58.5 dBuV/m is labeled 'FCC CLASS-B (AVG)'. A small peak is visible at approximately 5750 MHz. The x-axis ranges from 5685 to 5765 MHz, and the y-axis ranges from 14.6 to 117 dBuV/m.</p> <p>Site : 03CH07-HY            Condition : FCC CLASS-B (AVG) 3m HF-ANT_130829 VERTICAL            RBW:1000.000kHz VBW:2.000kHz SWT:Auto            Detector : Peak</p>

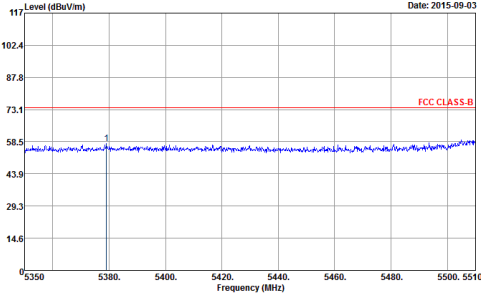
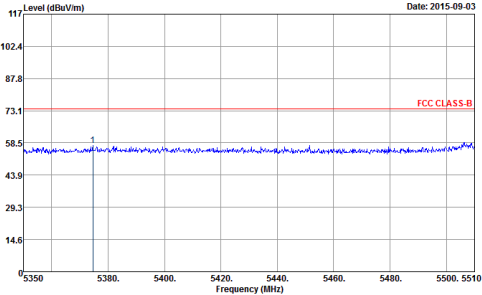
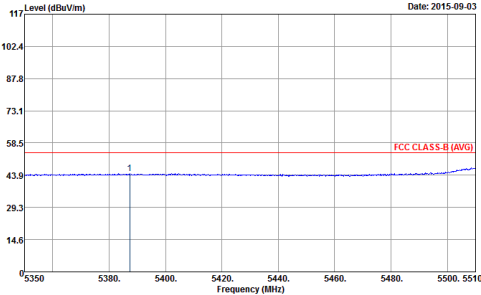
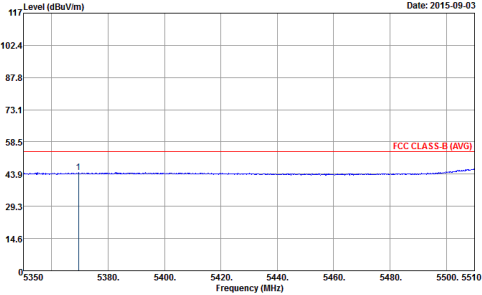

WIFI	Band 3 5470~5725MHz Band Edge @ 3m	
ANT	802.11n HT40 CH110 5550MHz - Low channel location	
1+2	Horizontal	Vertical
Peak	 <p>Level (dBuV/m) vs Frequency (MHz) - Horizontal Peak</p> <p>Site : 03CH07-HY            Condition : FCC CLASS-B 3m HF-ANT_130829 HORIZONTAL            RBW:1000.000kHz VBW:3000.000kHz SWT:Auto            Detector : Peak</p>	 <p>Level (dBuV/m) vs Frequency (MHz) - Vertical Peak</p> <p>Site : 03CH07-HY            Condition : FCC CLASS-B 3m HF-ANT_130829 VERTICAL            RBW:1000.000kHz VBW:3000.000kHz SWT:Auto            Detector : Peak</p>
Avg.	 <p>Level (dBuV/m) vs Frequency (MHz) - Horizontal Avg</p> <p>Site : 03CH07-HY            Condition : FCC CLASS-B (AVG) 3m HF-ANT_130829 HORIZONTAL            RBW:1000.000kHz VBW:2.000kHz SWT:Auto            Detector : Peak</p>	 <p>Level (dBuV/m) vs Frequency (MHz) - Vertical Avg</p> <p>Site : 03CH07-HY            Condition : FCC CLASS-B (AVG) 3m HF-ANT_130829 VERTICAL            RBW:1000.000kHz VBW:2.000kHz SWT:Auto            Detector : Peak</p>



WIFI	Band 3 5470~5725MHz Band Edge @ 3m	
ANT	802.11n HT40 CH110 5550MHz - High channel location	
1+2	Horizontal	Vertical
Peak	<p>Site : 03CH07-HY Condition : FCC CLASS-B 3m HF-ANT_130829 HORIZONTAL RBW:1000.000kHz VBW:3000.000kHz SWT:Auto Detector : Peak</p>	<p>Site : 03CH07-HY Condition : FCC CLASS-B 3m HF-ANT_130829 VERTICAL RBW:1000.000kHz VBW:3000.000kHz SWT:Auto Detector : Peak</p>
Avg.	<p>Site : 03CH07-HY Condition : FCC CLASS-B (AVG) 3m HF-ANT_130829 HORIZONTAL RBW:1000.000kHz VBW:2.000kHz SWT:Auto Detector : Peak</p>	<p>Site : 03CH07-HY Condition : FCC CLASS-B (AVG) 3m HF-ANT_130829 VERTICAL RBW:1000.000kHz VBW:2.000kHz SWT:Auto Detector : Peak</p>

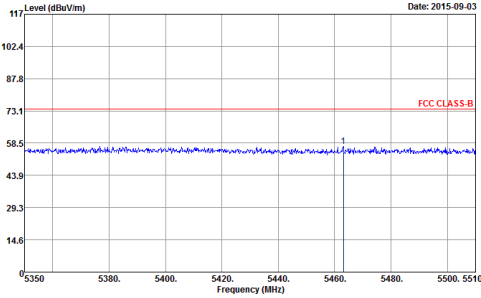
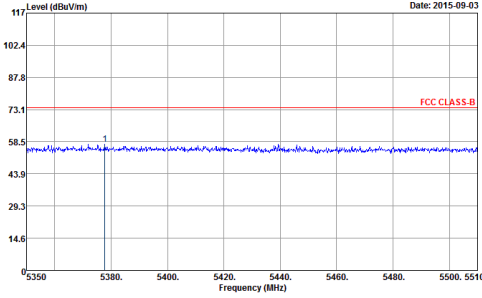
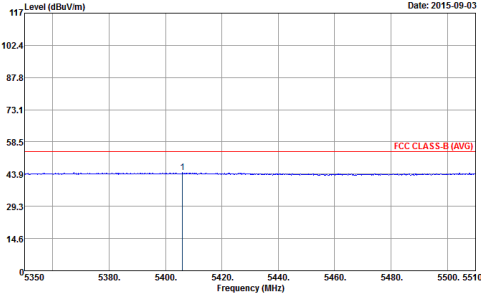
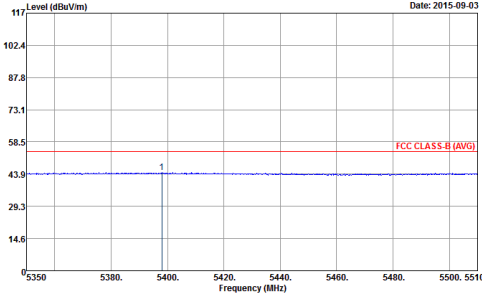

WIFI	Band 3 5470~5725MHz Band Edge @ 3m	
ANT	802.11n HT40 CH134 5670MHz - Low channel location	
1+2	Horizontal	Vertical
Peak	 <p>Site : 03CH07-HY Condition : FCC CLASS-B 3m HF-ANT_130829 HORIZONTAL RBW:1000.000kHz VBW:3000.000kHz SWT:Auto Detector : Peak</p>	 <p>Site : 03CH07-HY Condition : FCC CLASS-B 3m HF-ANT_130829 VERTICAL RBW:1000.000kHz VBW:3000.000kHz SWT:Auto Detector : Peak</p>
Avg.	 <p>Site : 03CH07-HY Condition : FCC CLASS-B (AVG) 3m HF-ANT_130829 HORIZONTAL RBW:1000.000kHz VBW:2.000kHz SWT:Auto Detector : Peak</p>	 <p>Site : 03CH07-HY Condition : FCC CLASS-B (AVG) 3m HF-ANT_130829 VERTICAL RBW:1000.000kHz VBW:2.000kHz SWT:Auto Detector : Peak</p>



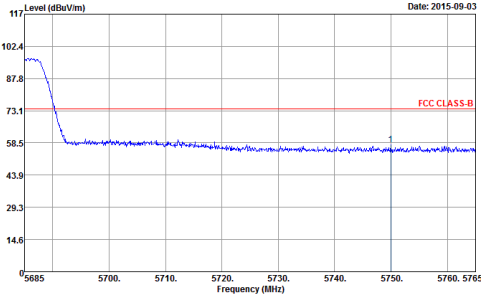
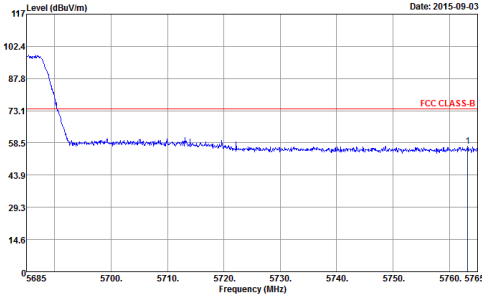
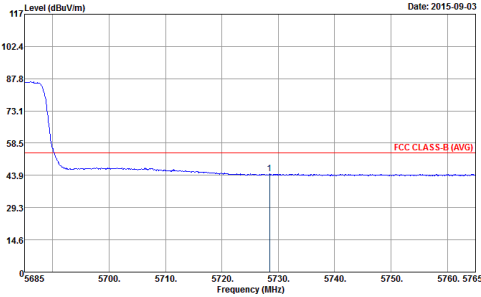
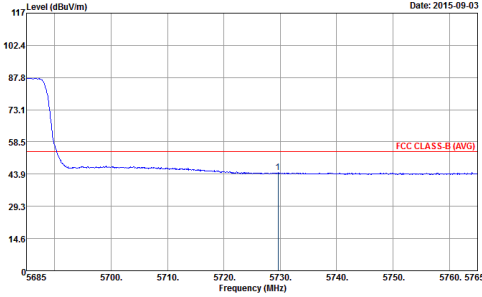

WIFI	Band 3 5470~5725MHz Band Edge @ 3m	
ANT	802.11n HT40 CH134 5670MHz - High channel location	
1+2	Horizontal	Vertical
Peak	 <p>Level (dBuV/m) vs Frequency (MHz) plot for Horizontal orientation. The y-axis ranges from 14.6 to 117 dBuV/m, and the x-axis ranges from 5685 to 5765 MHz. A red horizontal line indicates the FCC CLASS-B limit at 73.1 dBuV/m. The measured signal (blue line) starts at approximately 102.4 dBuV/m at 5685 MHz and drops to about 58.5 dBuV/m by 5700 MHz, remaining below the limit.</p> <p>Site : 03CH07-HY  Condition : FCC CLASS-B 3m HF-ANT_130829 HORIZONTAL  RBW:1000.000kHz VBW:3000.000kHz SWT:Auto  Detector : Peak</p>	 <p>Level (dBuV/m) vs Frequency (MHz) plot for Vertical orientation. The y-axis ranges from 14.6 to 117 dBuV/m, and the x-axis ranges from 5685 to 5765 MHz. A red horizontal line indicates the FCC CLASS-B limit at 73.1 dBuV/m. The measured signal (blue line) starts at approximately 102.4 dBuV/m at 5685 MHz and drops to about 58.5 dBuV/m by 5700 MHz, remaining below the limit.</p> <p>Site : 03CH07-HY  Condition : FCC CLASS-B 3m HF-ANT_130829 VERTICAL  RBW:1000.000kHz VBW:3000.000kHz SWT:Auto  Detector : Peak</p>
Avg.	 <p>Level (dBuV/m) vs Frequency (MHz) plot for Horizontal orientation. The y-axis ranges from 14.6 to 117 dBuV/m, and the x-axis ranges from 5685 to 5765 MHz. A red horizontal line indicates the FCC CLASS-B (AVG) limit at 58.5 dBuV/m. The measured signal (blue line) starts at approximately 87.8 dBuV/m at 5685 MHz and drops to about 43.9 dBuV/m by 5700 MHz, remaining below the limit.</p> <p>Site : 03CH07-HY  Condition : FCC CLASS-B (AVG) 3m HF-ANT_130829 HORIZONTAL  RBW:1000.000kHz VBW:2.000kHz SWT:Auto  Detector : Peak</p>	 <p>Level (dBuV/m) vs Frequency (MHz) plot for Vertical orientation. The y-axis ranges from 14.6 to 117 dBuV/m, and the x-axis ranges from 5685 to 5765 MHz. A red horizontal line indicates the FCC CLASS-B (AVG) limit at 58.5 dBuV/m. The measured signal (blue line) starts at approximately 87.8 dBuV/m at 5685 MHz and drops to about 43.9 dBuV/m by 5700 MHz, remaining below the limit.</p> <p>Site : 03CH07-HY  Condition : FCC CLASS-B (AVG) 3m HF-ANT_130829 VERTICAL  RBW:1000.000kHz VBW:2.000kHz SWT:Auto  Detector : Peak</p>



Band 3 5470~5725MHz
WIFI 802.11ac VHT80 (Band Edge @ 3m)

Table with 4 quadrants: Peak Horizontal, Peak Vertical, Avg. Horizontal, Avg. Vertical. Each quadrant contains a spectral plot of Level (dBuV/m) vs Frequency (MHz) with FCC CLASS-B limits and test parameters.

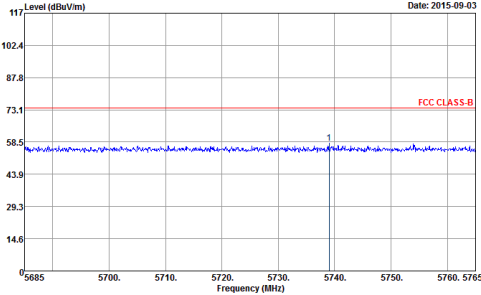
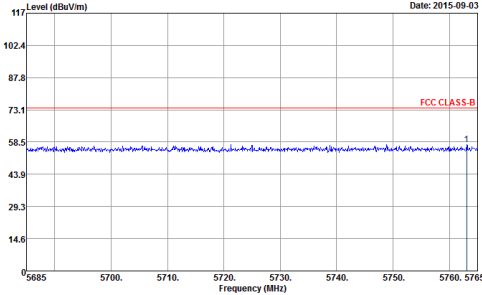
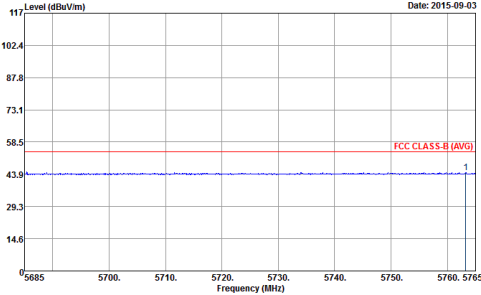
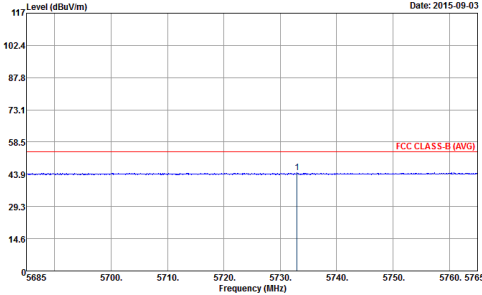

WIFI	Band 3 5470~5725MHz Band Edge @ 3m	
ANT	802.11ac VHT80 CH106 5530MHz - High channel location	
1+2	Horizontal	Vertical
Peak	 <p>Level (dBuV/m) vs Frequency (MHz) plot for Horizontal orientation. The y-axis ranges from 14.6 to 117 dBuV/m, and the x-axis ranges from 5685 to 5765 MHz. A red horizontal line indicates the FCC CLASS-B limit at 73.1 dBuV/m. The measured signal (blue line) is significantly below this limit, with a peak at approximately 5740 MHz.</p> <p>Site : 03CH07-HY            Condition : FCC CLASS-B 3m HF-ANT_130829 HORIZONTAL            RBW:1000.000KHz VBW:3000.000KHz SWT:Auto            Detector : Peak</p>	 <p>Level (dBuV/m) vs Frequency (MHz) plot for Vertical orientation. The y-axis ranges from 14.6 to 117 dBuV/m, and the x-axis ranges from 5685 to 5765 MHz. A red horizontal line indicates the FCC CLASS-B limit at 73.1 dBuV/m. The measured signal (blue line) is significantly below this limit, with a peak at approximately 5740 MHz.</p> <p>Site : 03CH07-HY            Condition : FCC CLASS-B 3m HF-ANT_130829 VERTICAL            RBW:1000.000KHz VBW:3000.000KHz SWT:Auto            Detector : Peak</p>
Avg.	 <p>Level (dBuV/m) vs Frequency (MHz) plot for Horizontal orientation showing average values. The y-axis ranges from 14.6 to 117 dBuV/m, and the x-axis ranges from 5685 to 5765 MHz. A red horizontal line indicates the FCC CLASS-B (AVG) limit at 58.5 dBuV/m. The measured signal (blue line) is consistently below this limit.</p> <p>Site : 03CH07-HY            Condition : FCC CLASS-B (AVG) 3m HF-ANT_130829 HORIZONTAL            RBW:1000.000KHz VBW:3.000KHz SWT:Auto            Detector : Peak</p>	 <p>Level (dBuV/m) vs Frequency (MHz) plot for Vertical orientation showing average values. The y-axis ranges from 14.6 to 117 dBuV/m, and the x-axis ranges from 5685 to 5765 MHz. A red horizontal line indicates the FCC CLASS-B (AVG) limit at 58.5 dBuV/m. The measured signal (blue line) is consistently below this limit.</p> <p>Site : 03CH07-HY            Condition : FCC CLASS-B (AVG) 3m HF-ANT_130829 VERTICAL            RBW:1000.000KHz VBW:3.000KHz SWT:Auto            Detector : Peak</p>

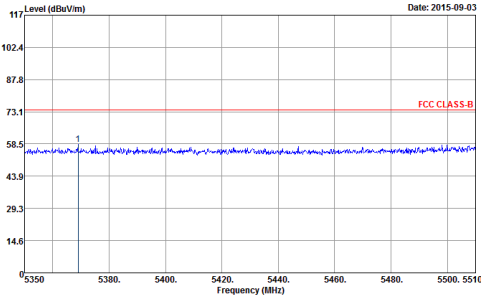
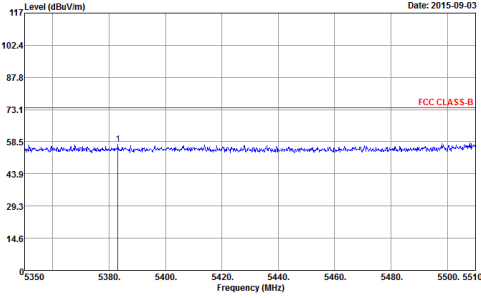
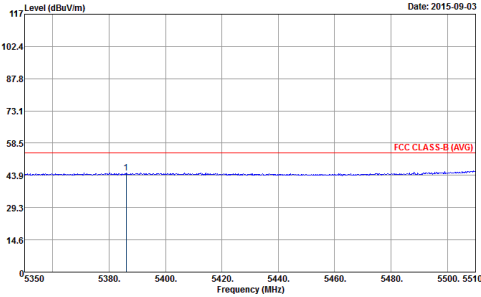
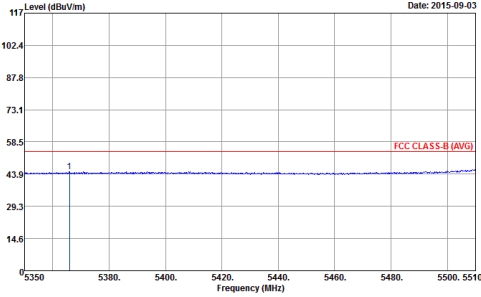

WIFI	Band 3 5470~5725MHz Band Edge @ 3m	
ANT	802.11ac VHT80 CH122 5610MHz - Low channel location	
1+2	Horizontal	Vertical
Peak	 <p>Date: 2015-09-03</p> <p>Site : 03CH07-HY Condition : FCC CLASS-B 3m HF-ANT_130829 HORIZONTAL Detector : Peak</p>	 <p>Date: 2015-09-03</p> <p>Site : 03CH07-HY Condition : FCC CLASS-B 3m HF-ANT_130829 VERTICAL Detector : Peak</p>
Avg.	 <p>Date: 2015-09-03</p> <p>Site : 03CH07-HY Condition : FCC CLASS-B (AVG) 3m HF-ANT_130829 HORIZONTAL Detector : Peak</p>	 <p>Date: 2015-09-03</p> <p>Site : 03CH07-HY Condition : FCC CLASS-B (AVG) 3m HF-ANT_130829 VERTICAL Detector : Peak</p>

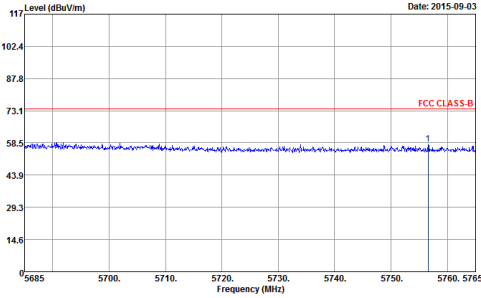
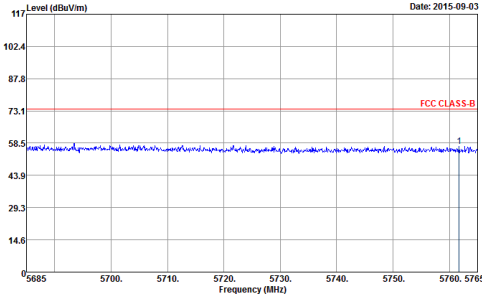
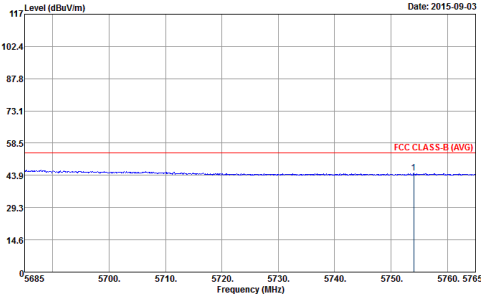
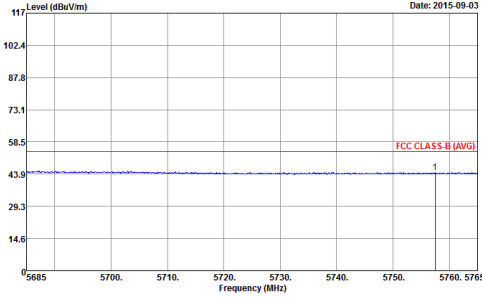

WIFI	Band 3 5470~5725MHz Band Edge @ 3m	
ANT	802.11ac VHT80 CH122 5610MHz - High channel location	
1+2	Horizontal	Vertical
Peak	 <p>Level (dBuV/m) vs Frequency (MHz) - Date: 2015-09-03</p> <p>Site : 03CH07-HY Condition : FCC CLASS-B 3m HF-ANT_130829 HORIZONTAL RBW:1000.000kHz VBW:3000.000kHz SWT:Auto Detector : Peak</p>	 <p>Level (dBuV/m) vs Frequency (MHz) - Date: 2015-09-03</p> <p>Site : 03CH07-HY Condition : FCC CLASS-B 3m HF-ANT_130829 VERTICAL RBW:1000.000kHz VBW:3000.000kHz SWT:Auto Detector : Peak</p>
Avg.	 <p>Level (dBuV/m) vs Frequency (MHz) - Date: 2015-09-03</p> <p>Site : 03CH07-HY Condition : FCC CLASS-B (AVG) 3m HF-ANT_130829 HORIZONTAL RBW:1000.000kHz VBW:3.000kHz SWT:Auto Detector : Peak</p>	 <p>Level (dBuV/m) vs Frequency (MHz) - Date: 2015-09-03</p> <p>Site : 03CH07-HY Condition : FCC CLASS-B (AVG) 3m HF-ANT_130829 VERTICAL RBW:1000.000kHz VBW:3.000kHz SWT:Auto Detector : Peak</p>



Band 3 - 5470~5725MHz
WIFI 802.11a (Harmonic @ 3m)

Table with 3 columns: WIFI, ANT, and 1+2. It contains two spectral plots: Horizontal and Vertical. Each plot shows Level (dBuV/m) vs Frequency (MHz) with FCC CLASS-B and FCC CLASS-B (AVG) limits. The plots show two peaks labeled 1 and 2, both below the FCC CLASS-B (AVG) limit.



WIFI	Band 3 5470-5725MHz Harmonic @ 3m	
ANT	802.11a CH116 5580MHz	
1+2	Horizontal	Vertical
Peak Avg.	<p>Site : 03CH07-HY Condition : FCC CLASS-B 3m SHF-EHF_131029 HORIZONTAL Detector : Peak</p>	<p>Site : 03CH07-HY Condition : FCC CLASS-B 3m SHF-EHF_131029 VERTICAL Detector : Peak</p>

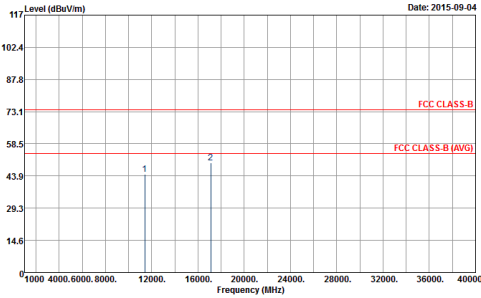
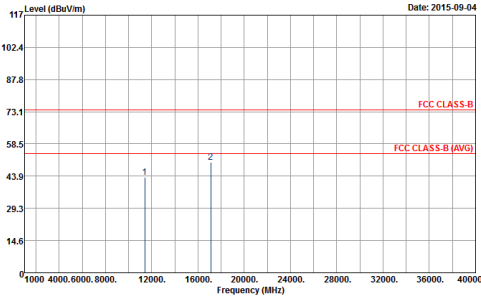

WIFI	Band 3 5470-5725MHz Harmonic @ 3m	
ANT	802.11a CH140 5700MHz	
1+2	Horizontal	Vertical
Peak Avg.	 <p>Site : 03CH07-HY Condition : FCC CLASS-B 3m SHF-EHF_131029 HORIZONTAL Detector : Peak</p>	 <p>Site : 03CH07-HY Condition : FCC CLASS-B 3m SHF-EHF_131029 VERTICAL Detector : Peak</p>





**Band 3 5470~5725MHz**  
**WIFI 802.11n HT20 (Harmonic @ 3m)**

WIFI	Band 3 5470~5725MHz Harmonic @ 3m	
ANT	802.11n HT20 CH100 5500MHz	
1+2	Horizontal	Vertical
Peak Avg.	<p>Site : 03CH07-HY Condition : FCC CLASS-B 3m SHF-EHF_131029 HORIZONTAL Detector : Peak</p>	<p>Site : 03CH07-HY Condition : FCC CLASS-B 3m SHF-EHF_131029 VERTICAL Detector : Peak</p>



WIFI	Band 3 5470-5725MHz Harmonic @ 3m	
ANT	802.11n HT20 CH116 5580MHz	
1+2	Horizontal	Vertical
Peak Avg.	<p>Site : 03CH07-HY Condition : FCC CLASS-B 3m SHF-EHF_131029 HORIZONTAL Detector : Peak</p>	<p>Site : 03CH07-HY Condition : FCC CLASS-B 3m SHF-EHF_131029 VERTICAL Detector : Peak</p>



WIFI	Band 3 5470-5725MHz Harmonic @ 3m	
ANT	802.11n HT20 CH140 5700MHz	
1+2	Horizontal	Vertical
Peak Avg.	<p>Site : 03CH07-HY Condition : FCC CLASS-B 3m SHF-EHF_131029 HORIZONTAL Detector : Peak</p>	<p>Site : 03CH07-HY Condition : FCC CLASS-B 3m SHF-EHF_131029 VERTICAL Detector : Peak</p>

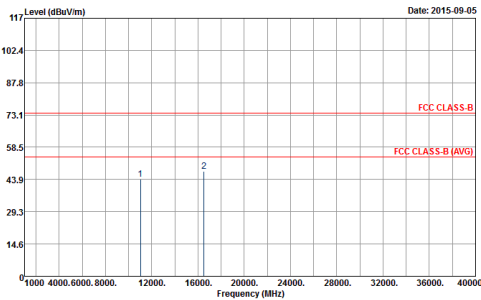
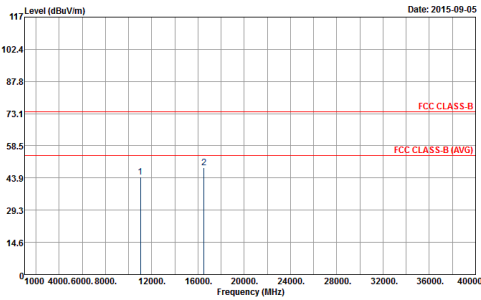

**Band 3 5470~5725MHz  
WIFI 802.11n HT40 (Harmonic @ 3m)**

WIFI	Band 3 5470~5725MHz Harmonic @ 3m	
ANT	802.11n HT40 CH102 5510MHz	
1+2	Horizontal	Vertical
<p><b>Peak</b> <b>Avg.</b></p>	 <p>Site : 03CH07-HY Condition : FCC CLASS-B 3m SHF-EHF_131029 HORIZONTAL Detector : Peak</p>	 <p>Site : 03CH07-HY Condition : FCC CLASS-B 3m SHF-EHF_131029 VERTICAL Detector : Peak</p>



WIFI	Band 3 5470-5725MHz Harmonic @ 3m	
ANT	802.11n HT40 CH110 5550MHz	
1+2	Horizontal	Vertical
Peak Avg.	<p>Site : 03CH07-HY Condition : FCC CLASS-B 3m SHF-EHF_131029 HORIZONTAL Detector : Peak</p>	<p>Site : 03CH07-HY Condition : FCC CLASS-B 3m SHF-EHF_131029 VERTICAL Detector : Peak</p>



WIFI	Band 3 5470-5725MHz Harmonic @ 3m	
ANT	802.11n HT40 CH134 5670MHz	
1+2	Horizontal	Vertical
Peak Avg.	<p>Site : 03CH07-HY Condition : FCC CLASS-B 3m SHF-EHF_131029 HORIZONTAL Detector : Peak</p>	<p>Site : 03CH07-HY Condition : FCC CLASS-B 3m SHF-EHF_131029 VERTICAL Detector : Peak</p>



Band 3 5470~5725MHz
WIFI 802.11ac VHT80 (Harmonic @ 3m)

Table with 3 columns: WIFI, ANT, 1+2. It contains two spectral plots comparing Horizontal and Vertical antenna configurations. Each plot shows Level (dBuV/m) vs Frequency (MHz) with FCC CLASS-B and FCC CLASS-B (AVG) limits. The plots show two peaks labeled 1 and 2, both well below the limits.



WIFI	Band 3 5470-5725MHz Harmonic @ 3m	
ANT	802.11ac VHT80 CH122 5610MHz	
1+2	Horizontal	Vertical
Peak Avg.	<p>Site : 03CH07-HY Condition : FCC CLASS-B 3m SHF-EHF_131029 HORIZONTAL Detector : Peak</p>	<p>Site : 03CH07-HY Condition : FCC CLASS-B 3m SHF-EHF_131029 VERTICAL Detector : Peak</p>





**Band 3 - Straddle Channel**  
**WIFI 802.11a (Harmonic @ 3m)**

WIFI	Band 3 Straddle Channel Harmonic @ 3m	
ANT	802.11a CH144 5720MHz	
1+2	Horizontal	Vertical
<b>Peak</b> <b>Avg.</b>	<p>Site : 03CH07-HY            Condition : FCC CLASS-B 3m SHF-EHF_131029 HORIZONTAL            Detector : Peak</p>	<p>Site : 03CH07-HY            Condition : FCC CLASS-B 3m SHF-EHF_131029 VERTICAL            Detector : Peak</p>



**Band 3 – Straddle Channel**  
**WIFI 802.11n HT20 (Harmonic @ 3m)**

WIFI	Band 3 Straddle Channel Harmonic @ 3m	
ANT	802.11n HT20 CH144 5720MHz	
1+2	Horizontal	Vertical
<b>Peak</b>  <b>Avg.</b>	<p>Site : 03CH07-HY            Condition : FCC CLASS-B 3m SHF-EHF_131029 HORIZONTAL            Detector : Peak</p>	<p>Site : 03CH07-HY            Condition : FCC CLASS-B 3m SHF-EHF_131029 VERTICAL            Detector : Peak</p>



Band 3 – Straddle Channel
WIFI 802.11n HT40 (Harmonic @ 3m)

Table with 3 columns: WIFI, ANT, 1+2. It contains two graphs showing Level (dBuV/m) vs Frequency (MHz) for Horizontal and Vertical orientations. The graphs include FCC CLASS-B and FCC CLASS-B (AVG) limits and two peaks labeled 1 and 2.



**Band 3 – Straddle Channel  
WIFI 802.11ac VHT80 (Harmonic @ 3m)**

WIFI	Band 3 Straddle Channel Harmonic @ 3m	
ANT	802.11ac VHT80 CH138 5690MHZ	
1+2	Horizontal	Vertical
<p><b>Peak</b> <b>Avg.</b></p>	<p>Site : 03CH07-HY Condition : FCC CLASS-B 3m SHF-EHF_131029 HORIZONTAL Detector : Peak</p>	<p>Site : 03CH07-HY Condition : FCC CLASS-B 3m SHF-EHF_131029 VERTICAL Detector : Peak</p>



Emission below 1GHz  
5GHz WIFI 802.11a (LF)

WIFI	5GHz WIFI	
ANT	802.11a LF	
1+2	Horizontal	Vertical
QP / Peak	<p>Site : 03CH07-HY Condition : FCC CLASS-B 3m LF-ANT(131102) HORIZONTAL</p>	<p>Site : 03CH07-HY Condition : FCC CLASS-B 3m LF-ANT(131102) VERTICAL</p>



Emission below 1GHz  
5GHz WIFI 802.11n HT20 (LF)

WIFI	5GHz WIFI	
ANT	802.11n HT20 LF	
1+2	Horizontal	Vertical
QP / Peak	<p>Site : 03CH07-HY Condition : FCC CLASS-B 3m LF-ANT(131102) HORIZONTAL</p>	<p>Site : 03CH07-HY Condition : FCC CLASS-B 3m LF-ANT(131102) VERTICAL</p>



Emission below 1GHz  
5GHz WIFI 802.11n HT40 (LF)

WIFI	5GHz WIFI	
ANT	802.11n HT40 LF	
1+2	Horizontal	Vertical
QP / Peak	<p>Site : 03CH07-HY Condition : FCC CLASS-B 3m LF-ANT(131102) HORIZONTAL</p>	<p>Site : 03CH07-HY Condition : FCC CLASS-B 3m LF-ANT(131102) VERTICAL</p>



Emission below 1GHz  
5GHz WIFI 802.11ac VHT80 (LF)

WIFI	5GHz WIFI	
ANT	802.11ac VHT80 LF	
1+2	Horizontal	Vertical
QP / Peak	<p>Horizontal plot showing Level (dBuV/m) vs Frequency (MHz) for FCC CLASS-B. The plot shows a blue signal line and a red stepped limit line. The signal is well below the limit. Date: 2015-09-06. Site: 03CH07-HY, Condition: FCC CLASS-B 3m LF-ANT(131102) HORIZONTAL.</p>	<p>Vertical plot showing Level (dBuV/m) vs Frequency (MHz) for FCC CLASS-B. The plot shows a blue signal line and a red stepped limit line. The signal is well below the limit. Date: 2015-09-06. Site: 03CH07-HY, Condition: FCC CLASS-B 3m LF-ANT(131102) VERTICAL.</p>