



FCC RF TEST REPORT

47 CFR FCC Part 15 Subpart C § 15.249

Equipment : GSM/WCDMA/LTE Phone + Bluetooth, DTS/UNII
a/b/g/n/ac, ANT+, and NFC
BRAND NAME : Sony
FCC ID : PY7-PM0907

We, SPORTON INTERNATIONAL INC., would like to declare that the tested sample has been evaluated in accordance with the test procedures and has been in compliance with the applicable technical standards.

The test results in this report apply exclusively to the tested model / sample. Without written approval of SPORTON INTERNATIONAL INC., the test report shall not be reproduced except in full.

Reviewed by: Joseph Lin / Supervisor

Approved by: Jones Tsai / Manager



SPORTON INTERNATIONAL INC.

No. 52, Hwa Ya 1st Rd., Hwa Ya Technology Park, Kwei-Shan District, Tao Yuan City, Taiwan, R.O.C.



Table of Contents

1. SUMMARY OF THE TEST RESULT 2
2. GENERAL INFORMATION..... 3
2.1 Applicant..... 3
2.2 Manufacturer..... 3
2.3 Product Details 3
2.4 Table for Test Modes..... 4
2.5 Table for Testing Locations 5
2.6 Table for Supporting Units..... 5
2.7 Test Configurations 6
3. TEST RESULT 7
3.1 AC Power Line Conducted Emissions Measurement..... 7
3.2 20dB and & 99% Occupied Bandwidth 12
3.3 Field Strength of Fundamental Emissions and Radiated Spurious Emissions..... 15
3.4 Antenna Requirements 28
4. LIST OF MEASURING EQUIPMENT 29



REVISION HISTORY

REPORT NO.	VERSION	DESCRIPTION	ISSUED DATE
FR571613E	Rev. 01	Initial issue of report	Sep. 17, 2015



1. SUMMARY OF THE TEST RESULT

Applied Standard:				
Part	FCC Rule	Description of Test	Result	Under Limit
3.1	15.207	AC Power Line Conducted Emissions	Complies	20.40 dB at 0.622MHz
3.2	2.1049	20dB & 99% Occupied Bandwidth	Complies	-
3.3	15.249(a)	Field Strength of Fundamental Emissions	Complies	19.43 dB at 2480.000MHz
3.3	15.249(a)(d)	Radiated Spurious Emissions	Complies	13.21 dB at 32.160MHz
3.4	15.203	Antenna Requirements	Complies	-

Remark: The FR571613E report reuses test data from the FR571614E report.

Uncertainty of Conducted Emission Measurement (150kHz ~ 30MHz)

Measuring Uncertainty for a Level of Confidence of 95% (U = 2Uc(y))	2.26
---	------

Uncertainty of Radiated Emission Measurement (30 MHz ~ 1000 MHz)

Measuring Uncertainty for a Level of Confidence of 95% (U = 2Uc(y))	4.90
---	------



2. GENERAL INFORMATION

2.1 Applicant

Sony Mobile Communications Inc.
Nya Vattentornet, 22188 Lund, Sweden

2.2 Manufacturer

Sony Mobile Communications Inc.
1-8-15 Konan, Minato-ku, Tokyo, 108-0075, Japan

2.3 Product Details

For more detailed features description, please refer to the manufacturer's specifications or user's manual.

Items	Description
Modulation	GFSK
Channel Bandwidth (99%)	1.026MHz
Max. Field Strength (Peak)	94.57dBμV/m
Max. Field Strength (Average)	68.19dBμV/m
ANT+ Channel Number	78
ANT+ Frequency Range	2403-2480MHz

EUT Information List				
IMEI	HW Version	SW Version	S/N	Performed Test Item
IMEI: 004402541707513	A	32.0.B.0.192	CB5A279FVJ	RF conducted measurement
IMEI: 004402541706515			CB5A279A2H8	Radiated Spurious Emission
IMEI: 004402541706721			CB5A279A2DY	Conducted Emission



Accessory List	
AC Adapter	Model No. : UCH20
	Type No. : AC-0061-US
	S/N :
	5815W22500090 (for radiated spurious emission) 2115W15500021 (for conducted emission)
Earphone	Model No. : MDR-NC31E
	Type No. : AG-1110
USB Cable	Model No. : UCB11
	Type No. : AI-0120
	S/N :
	1522A7390009100 (for radiated spurious emission) 1522A73000065C4 (for conducted emission)

Note:

1. Above EUT list and accessory list used are electrically identical per declared by manufacturer.
2. Above the accessories list are used to exercise the EUT during test.
3. For other wireless features of this EUT, test report will be issued separately.

2.4 Table for Test Modes

Investigation has been done on all the possible configurations for searching the worst cases. The following table is a list of the test modes shown in this test report.

Test Items	Mode
AC Power Line Conducted Emissions	CTX
Field Strength of Fundamental Emissions	CTX
Bandwidth	CTX
Radiated Emissions	CTX

Note:

1. CTX=continuously transmitting.
2. The programmed RF utility, "CMD" installed in the notebook to make the EUT get into the engineering modes to continuously transmit.



2.5 Table for Testing Locations

Test Site	SPORTON INTERNATIONAL INC.
Test Site Location	No. 52, Hwa Ya 1 st Rd., Hwa Ya Technology Park, Kwei-Shan District, Tao Yuan City, Taiwan, R.O.C. TEL: +886-3-327-3456 FAX: +886-3-328-4978
Test Site No.	Sporton Site No.
	TH05-HY

Note: The test site complies with ANSI C63.4 2009 requirement.

Test Site	SPORTON INTERNATIONAL INC.
Test Site Location	No.58, Aly. 75, Ln. 564, Wenhua 3rd Rd. Kwei-Shan District, Tao Yuan City, Taiwan, R.O.C. TEL: +886-3-327-0855
Test Site No.	Sporton Site No.
	03CH10-HY

Note: The test site complies with ANSI C63.4 2009 requirement.

2.6 Table for Supporting Units

Item	Equipment	Trade Name	Model Name	FCC ID	Data Cable	Power Cord
1.	SD Card	SanDisk	MicroSD HC	FCC DoC	N/A	N/A

2.7 Test Configurations

<AC Conducted Emissions>

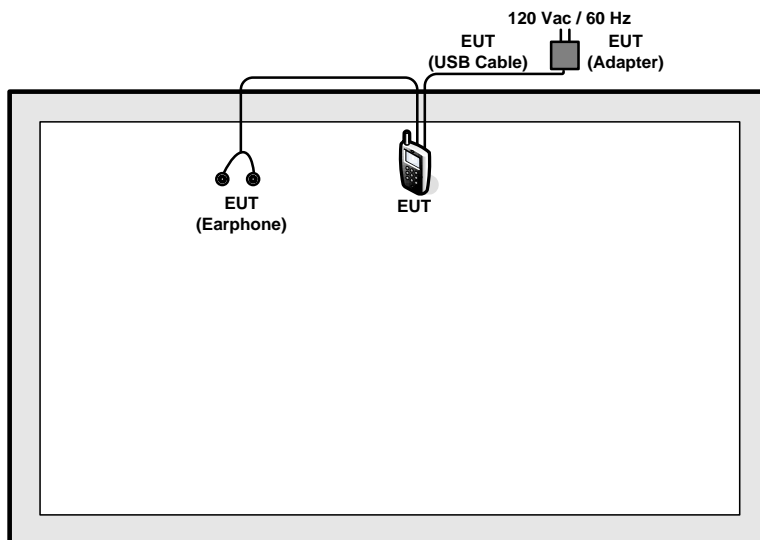

<Radiated Spurious Emissions>

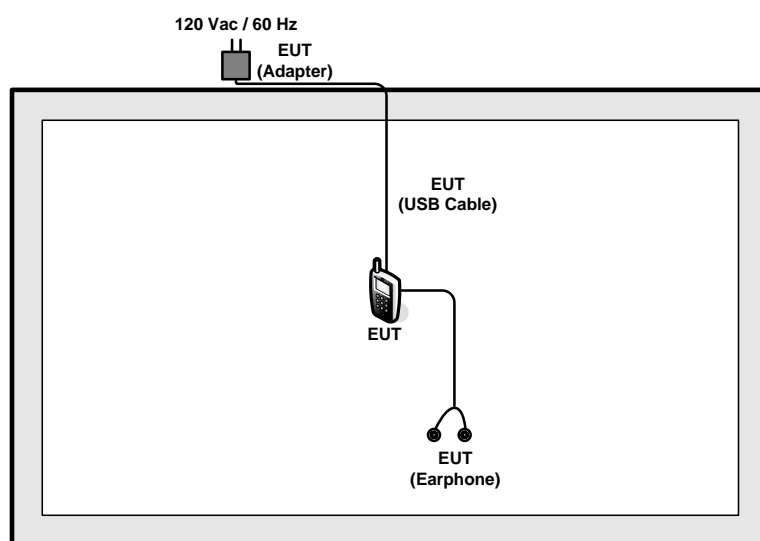



3. TEST RESULT

3.1 AC Power Line Conducted Emissions Measurement

3.1.1 Limit

For a Low-power Radio-frequency device which is designed to be connected to the AC power line, the radio frequency voltage that is conducted back onto the AC power line on any frequency or frequencies within the band 150 kHz to 30 MHz shall not exceed below limits table.

Frequency (MHz)	QP Limit (dBµV)	AV Limit (dBµV)
0.15~0.5	66~56	56~46
0.5~5	56	46
5~30	60	50

3.1.2 Measuring Instruments

Please refer to section 4 of equipment list in this report.

3.1.3 Test Procedures

1. Configure the EUT according to ANSI C63.4. The EUT or host of EUT has to be placed 0.4 meter far from the conducting wall of the shielding room and at least 80 centimeters from any other grounded conducting surface.
2. Connect EUT or host of EUT to the power mains through a line impedance stabilization network (LISN).
3. All the support units are connected to the other LISNs. The LISN should provide 50uH/50ohms coupling impedance.
4. The frequency range from 150 kHz to 30 MHz was searched.
5. Set the test-receiver system to Peak Detect Function and Specified Bandwidth (IF bandwidth = 9kHz) with Maximum Hold Mode.
6. The measurement has to be done between each power line and ground at the power terminal.

3.1.4 Test Setup Layout

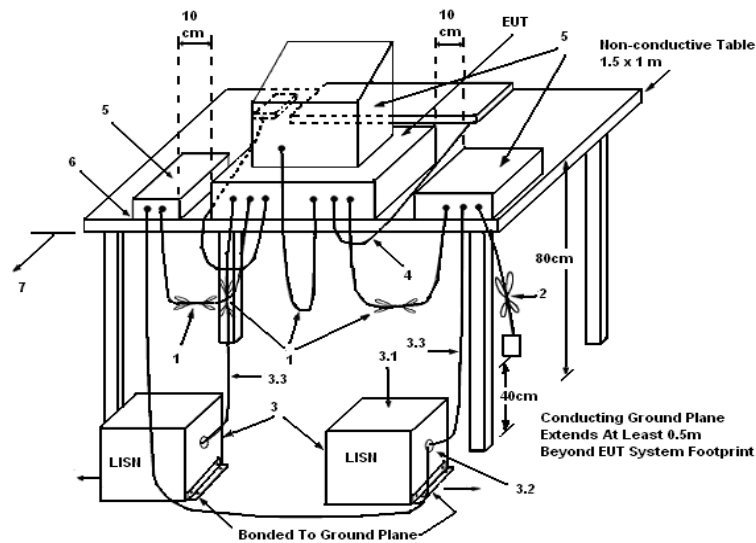

LEGEND:

- (1) Interconnecting cables that hang closer than 40 cm to the ground plane shall be folded back and forth in the center forming a bundle 30 to 40 cm long.
- (2) I/O cables that are not connected to a peripheral shall be bundled in the center. The end of the cable may be terminated, if required, using the correct terminating impedance. The overall length shall not exceed 1 m.
- (3) EUT connected to one LISN. Unused LISN measuring port connectors shall be terminated in 50 Ω. LISN can be placed on top of, or immediately beneath, reference ground plane.
 - (3.1) All other equipment powered from additional LISN(s).
 - (3.2) Multiple outlet strip can be used for multiple power cords of non-EUT equipment.
 - (3.3) LISN at least 80 cm from nearest part of EUT chassis.
- (4) Cables of hand-operated devices, such as keyboards, mice, etc., shall be placed as for normal use.
- (5) Non-EUT components of EUT system being tested.
- (6) Rear of EUT, including peripherals, shall all be aligned and flush with rear of tabletop.
- (7) Rear of tabletop shall be 40 cm removed from a vertical conducting plane that is bonded to the ground plane.

3.1.5 Test Deviation

There is no deviation with the original standard.

3.1.6 EUT Operation during Test

The EUT was placed on the test table and programmed in transmitting function.

3.1.7 Results of AC Power Line Conducted Emissions Measurement

Test Date	Aug. 15, 2015	Test Site No.	CO05-HY
Temperature	23~25°C	Humidity	58~61%
Test Engineer	Eric Jeng		
Mode	ANT+ Tx (2441 MHz) + Earphone + USB Cable (Charging from Adapter)		

Line

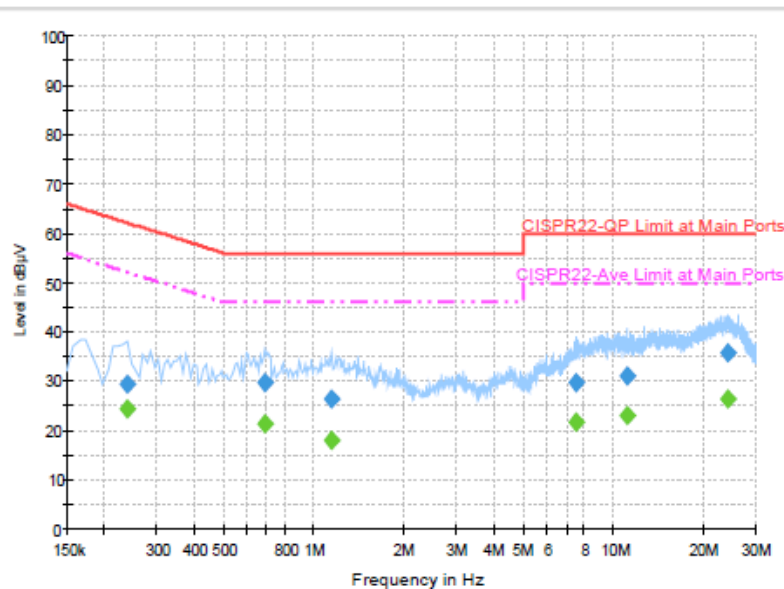

Final Result: Quasi-Peak

Frequency (MHz)	Quasi-Peak (dBµV)	Filter	Line	Corr. (dB)	Margin (dB)	Limit (dBµV)
0.238000	29.6	Off	L1	19.5	32.6	62.2
0.686000	29.8	Off	L1	19.6	26.2	56.0
1.150000	26.4	Off	L1	19.6	29.6	56.0
7.550000	29.7	Off	L1	19.8	30.3	60.0
11.118000	31.0	Off	L1	19.9	29.0	60.0
24.126000	35.8	Off	L1	20.0	24.2	60.0



Test Date	Aug. 15, 2015	Test Site No.	CO05-HY
Temperature	23~25°C	Humidity	58~61%
Test Engineer	Eric Jeng		
Mode	ANT+ Tx (2441 MHz) + Earphone + USB Cable (Charging from Adapter)		

Line

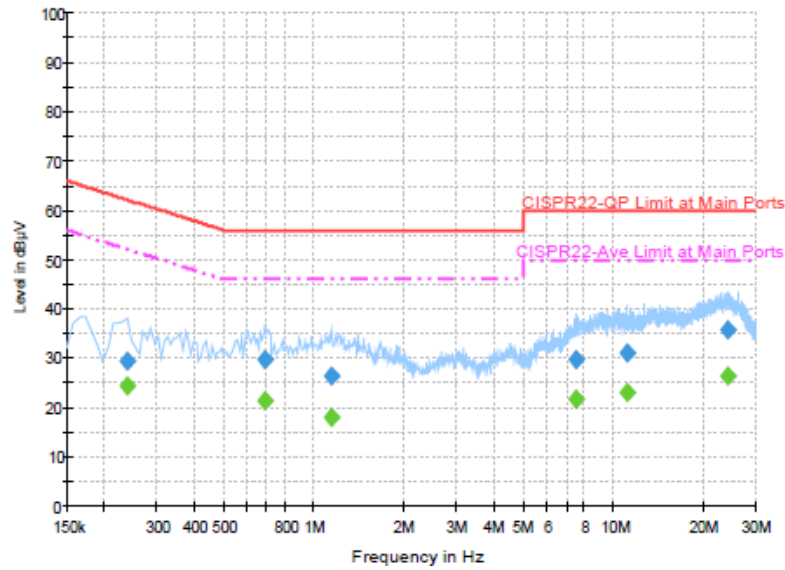

Final Result: Average

Frequency (MHz)	Average (dBµV)	Filter	Line	Corr. (dB)	Margin (dB)	Limit (dBµV)
0.238000	24.3	Off	L1	19.5	27.9	52.2
0.686000	21.4	Off	L1	19.6	24.6	46.0
1.150000	18.1	Off	L1	19.6	27.9	46.0
7.550000	21.8	Off	L1	19.8	28.2	50.0
11.118000	23.2	Off	L1	19.9	26.8	50.0
24.126000	26.4	Off	L1	20.0	23.6	50.0



Test Date	Aug. 15, 2015	Test Site No.	CO05-HY
Temperature	23~25°C	Humidity	58~61%
Test Engineer	Eric Jeng		
Mode	ANT+ Tx (2441 MHz) + Earphone + USB Cable (Charging from Adapter)		

Neutral

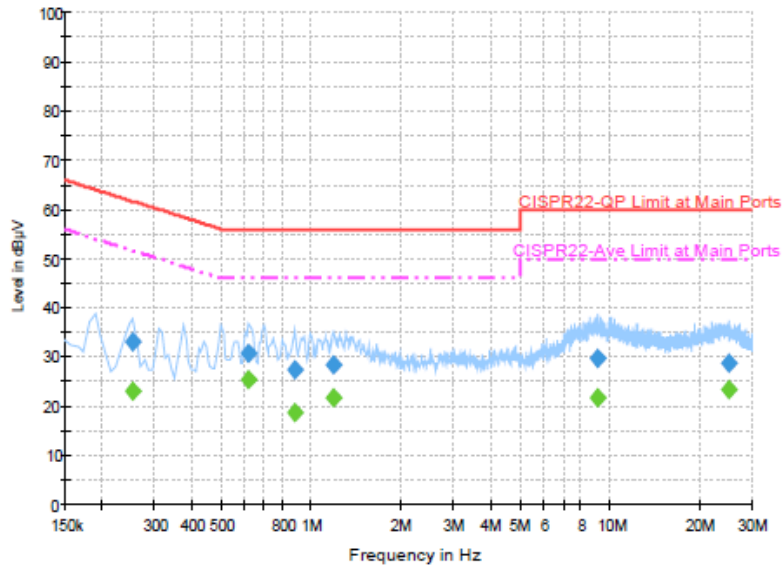

Final Result: Quasi-Peak

Frequency (MHz)	Quasi-Peak (dBµV)	Filter	Line	Corr. (dB)	Margin (dB)	Limit (dBµV)
0.254000	33.0	Off	N	19.4	28.6	61.6
0.622000	30.9	Off	N	19.4	25.1	56.0
0.886000	27.4	Off	N	19.5	28.6	56.0
1.190000	28.4	Off	N	19.6	27.6	56.0
9.174000	29.7	Off	N	19.8	30.3	60.0
24.958000	28.9	Off	N	20.1	31.1	60.0

Final Result: Average

Frequency (MHz)	Average (dBµV)	Filter	Line	Corr. (dB)	Margin (dB)	Limit (dBµV)
0.254000	23.0	Off	N	19.4	28.6	51.6
0.622000	25.6	Off	N	19.4	20.4	46.0
0.886000	18.9	Off	N	19.5	27.1	46.0
1.190000	21.6	Off	N	19.6	24.4	46.0
9.174000	21.8	Off	N	19.8	28.2	50.0
24.958000	23.3	Off	N	20.1	26.7	50.0

3.2 20dB and & 99% Occupied Bandwidth

3.2.1 Limit

Intentional radiators must be designed to ensure that the 20 dB bandwidth of the emissions in the specific band.

3.2.2 Measuring Instruments

Please refer to section 4 of equipment list in this report.

3.2.3 Test Procedures

1. The transmitter output port was connected to the spectrum analyzer.
2. Measured the spectrum width with highest power setting.

3.2.4 Test Setup Layout

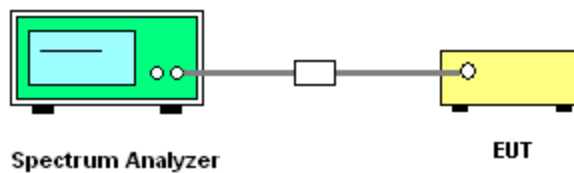

3.2.5 Test Deviation

There is no deviation with the original standard.

3.2.6 EUT Operation during Test

The EUT was programmed to be in continuously transmitting mode.



3.2.7 Test Result of 20dB Spectrum Bandwidth

Final Test Date	Aug. 04, 2015	Test Site No.	TH05-HY
Temperature	22~25°C	Humidity	51~55%
Test Engineer	osolemio Chang		

Frequency	20dB BW (MHz)	99% OBW (MHz)
2403MHz	1.050	1.026
2441MHz	1.050	1.026
2480MHz	1.050	1.026

20 dB Bandwidth Plot on 2403MHz

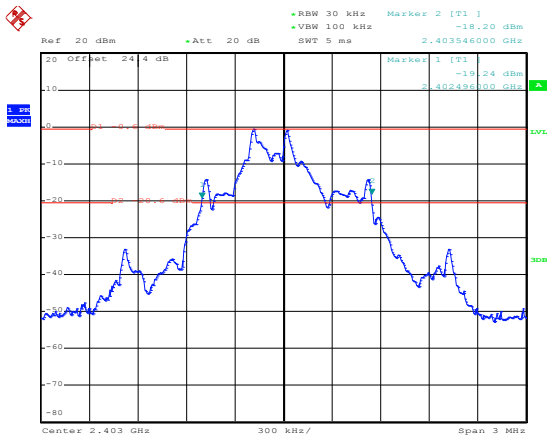

Date: 4.AUG.2015 01:44:20

99% Bandwidth Plot on 2403MHz

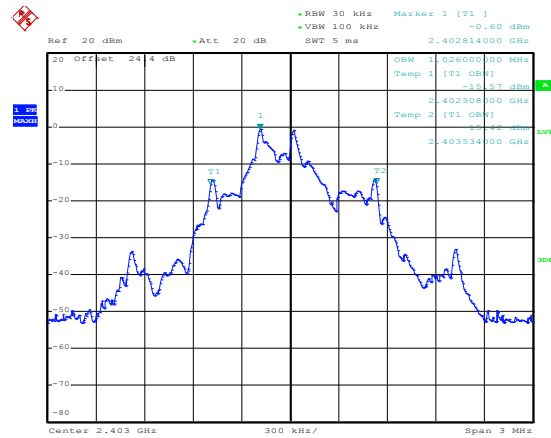

Date: 4.AUG.2015 01:45:57



20 dB Bandwidth Plot on 2441MHz

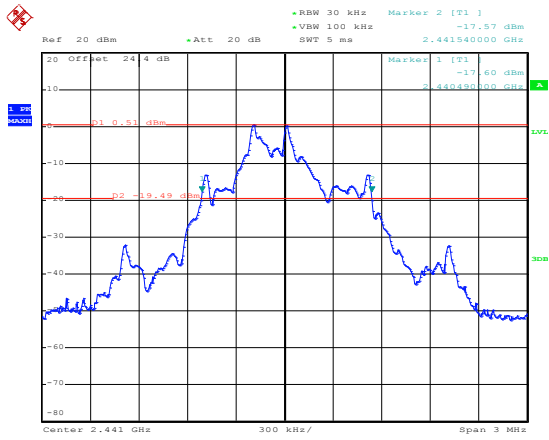

Date: 4.AUG.2015 01:14:13

99% Bandwidth Plot on 2441MHz

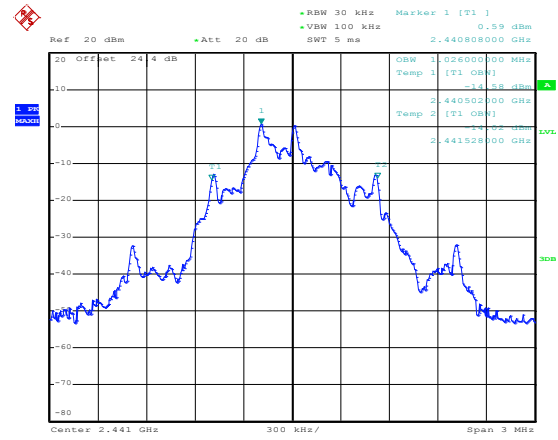

Date: 4.AUG.2015 02:04:53

20 dB Bandwidth Plot on 2480MHz

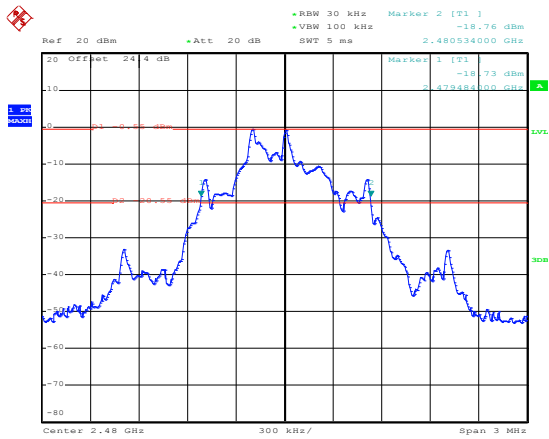

Date: 4.AUG.2015 01:54:49

99% Bandwidth Plot on 2480MHz

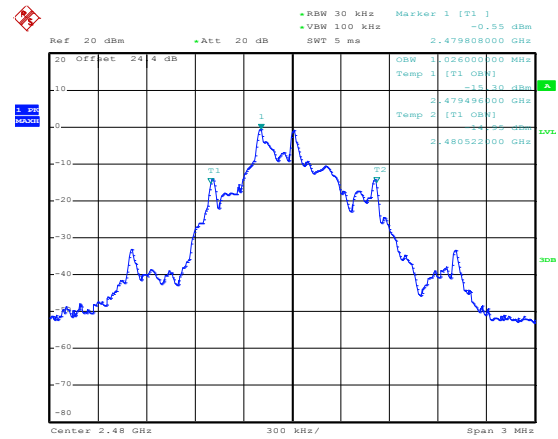

Date: 4.AUG.2015 01:53:14



3.3 Field Strength of Fundamental Emissions and Radiated Spurious Emissions

3.3.1 Limit

The field strength measured at 3 meters shall not exceed the limits in the following table:

Fundamental Frequencies(MHz)	Field Strength(millivolts/m)	
	Fundamental	Harmonics
902~928	50	0.5
2400~2483.5	50	0.5
5725~5875	50	0.5

Note: The limits shown in the above table are based on measurements using an average detector, except for the fundamental emission in the frequency band 902-928 MHz, which is based on measurements using a CISPR quasi-peak detector.

Emissions radiated outside of the specified frequency bands, except for harmonics, shall be attenuated by at least 50 dB below the level of the fundamental or to the general field strength limits listed in 15.209 as below, whichever is less stringent.

Frequency (MHz)	Field Strength (microvolts/meter)	Measurement Distance (meters)
0.009 – 0.490	2400/F(kHz)	300
0.490 – 1.705	24000/F(kHz)	30
1.705 – 30.0	30	30
30 – 88	100	3
88 – 216	150	3
216 - 960	200	3
Above 960	500	3



3.3.2 Measuring Instruments

Please refer to section 4 of equipment list in this report.

3.3.3 Test Procedures

1. The EUT was placed on a turntable with 0.8 meter for frequency below 1GHz and 1.5 meter for frequency above 1GHz respectively above ground.
2. The EUT was set 3 meters from the interference receiving antenna, which was mounted on the top of a variable height antenna tower.
3. For each suspected emission, the EUT was arranged to its worst case and then tune the Antenna tower (from 1 m to 4 m) and turntable (from 0 degree to 360 degrees) to find the maximum reading. A pre-amp and a high pass filter are used for the test in order to get better signal level to comply with the guidelines.
4. Set to the maximum power setting and enable the EUT transmit continuously.

Remark:

1. Corrected Reading: Antenna Factor + Cable Loss + Read Level - Preamp Factor = Level
2. For average measurement: use duty cycle correction factor method per 15.35(c).

Duty cycle = On time/100 milliseconds

On time = $N1*L1+N2*L2+...+Nn-1*LNn-1+Nn*Ln$

Where N1 is number of type 1 pulses, L1 is length of type 1 pulses, etc.

Average Emission Level = Peak Emission Level + 20*log(Duty cycle)

3.3.4 Test Setup Layout

For radiated emissions below 30MHz

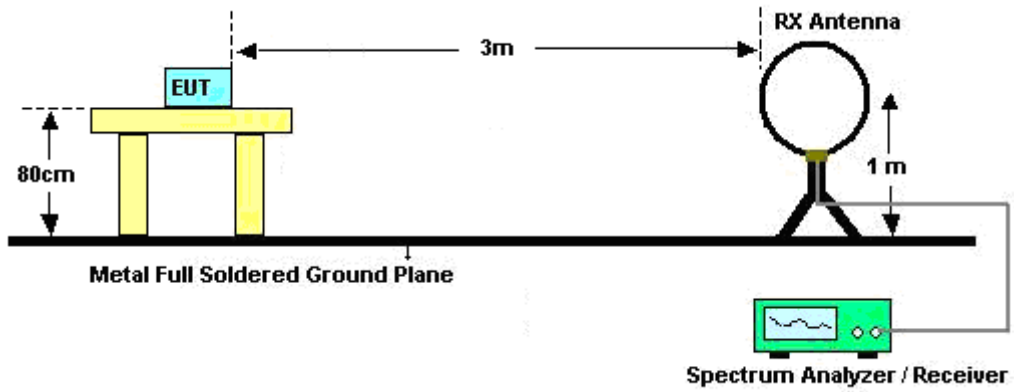

For radiated emissions from 30MHz to 1GHz

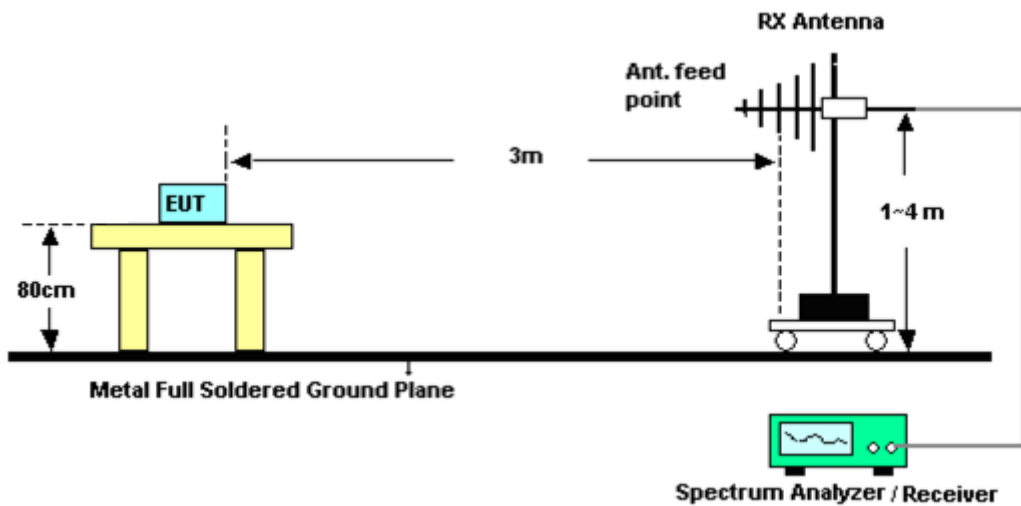

For radiated emissions above 1GHz

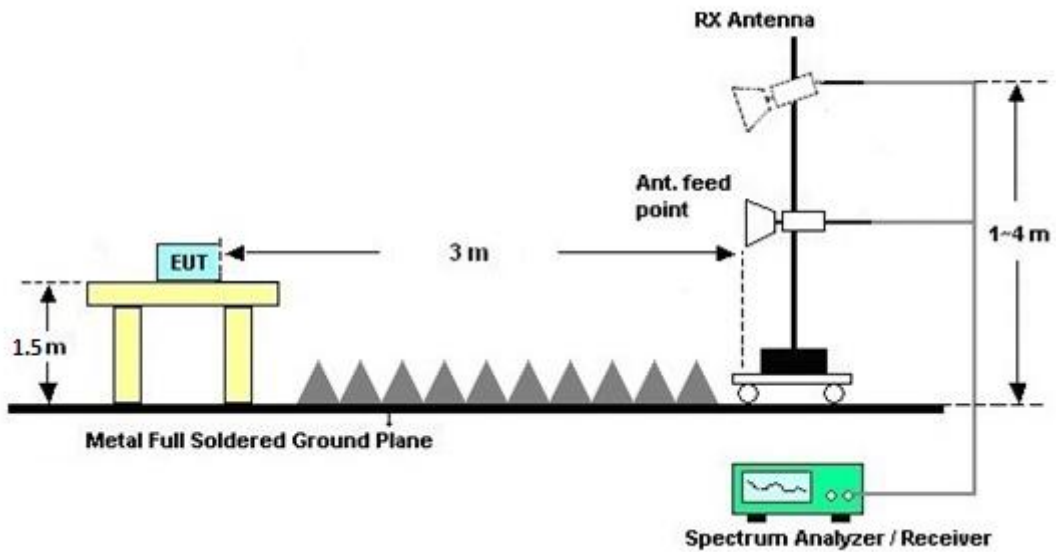

3.3.5 Test Deviation

There is no deviation with the original standard.

3.3.6 EUT Operation during Test

The EUT was programmed to be in continuously transmitting mode.

3.3.7 Test Results of Radiated Spurious Emissions (9 kHz ~ 30 MHz)

The low frequency, which started from 9 kHz to 30MHz, was pre-scanned and the result which was 20dB lower than the limit line per 15.31(o) was not reported.



3.3.8 Duty cycle correction factor for average measurement

On time (One Pulse) Plot on 2441MHz

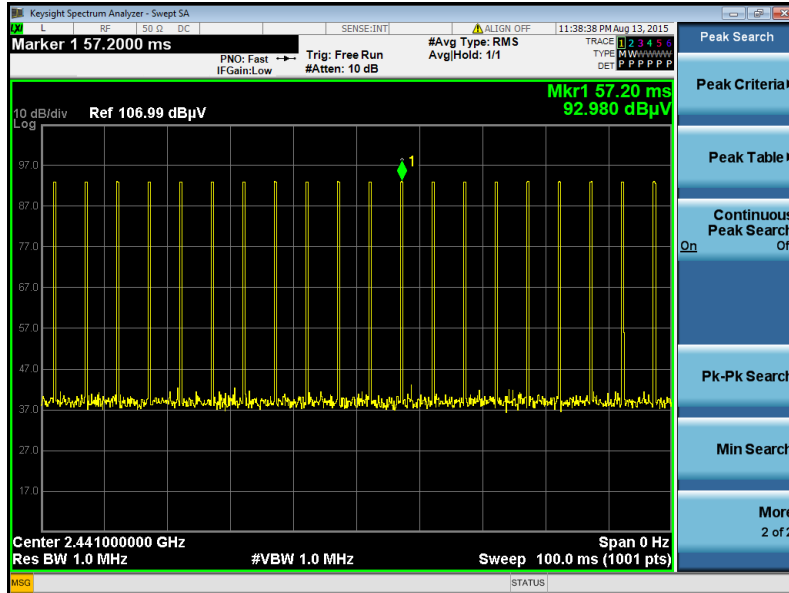

On time (Count Pulses) Plot on 2441MHz

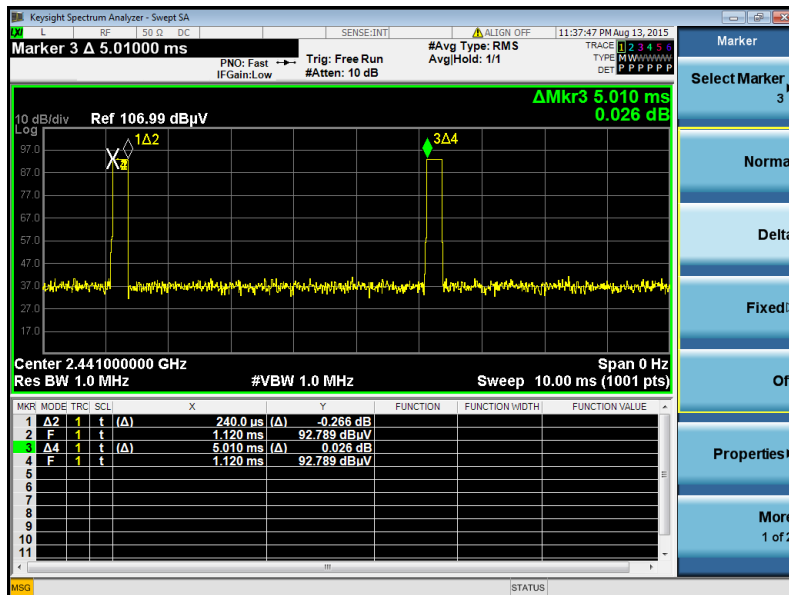

Note:

1. Worst case Duty cycle = on time/100 milliseconds = $10 * 0.24 / 100 = 4.80 \%$
2. Worst case Duty cycle correction factor = $20 * \log(\text{Duty cycle}) = -26.38 \text{ dB}$



3.3.9 Test Result of Field Strength of Fundamental Emissions and Spurious Emissions

Test Date	Aug.13, 201~ Aug. 14, 2015	Test Engineer	Stan Hsieh
Temperature	23~25°C	Humidity	45~47%

<30MHz ~ 1GHz>

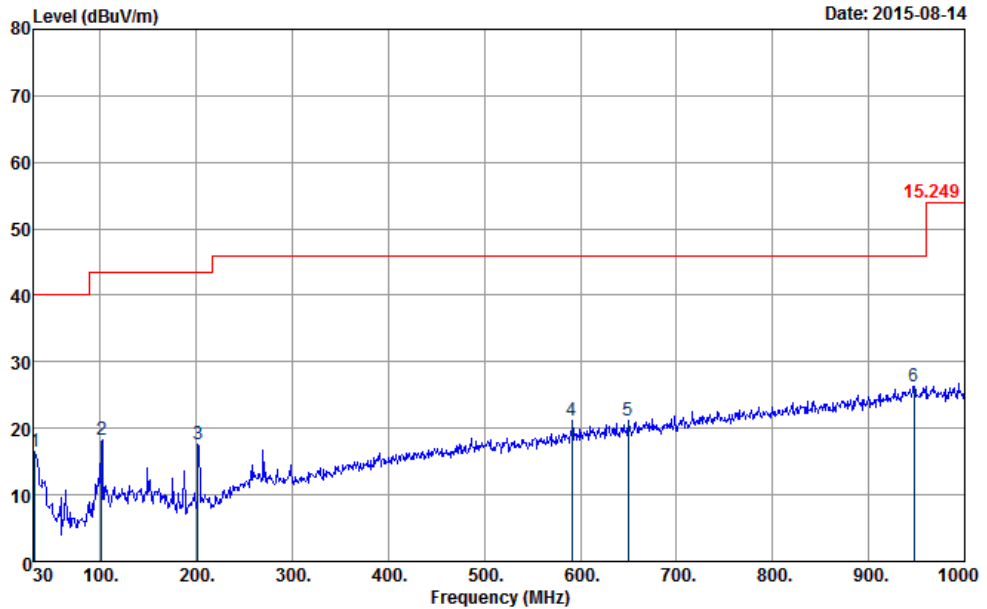

Site : 03CH10-HY
 Condition : 15.249 3m BI-LOG 6111D-LF HORIZONTAL
 Detector : Peak

	Freq	Level	Over Limit	Limit Line	ReadAntenna Level	Antenna Factor	Cable Loss	Preamp Factor	A/Pos	T/Pos	Remark
	MHz	dBuV/m	dB	dBuV/m	dBuV	dB/m	dB	dB	cm	deg	
1	31.62	16.41	-23.59	40.00	29.66	18.92	0.65	32.82	---	---	Peak
2	101.01	18.30	-25.20	43.50	39.29	10.50	1.14	32.63	---	---	Peak
3	201.72	17.70	-25.80	43.50	38.80	10.15	1.48	32.73	---	---	Peak
4	591.20	21.08	-24.92	46.00	32.09	19.44	2.57	33.02	---	---	Peak
5	649.30	21.15	-24.85	46.00	31.30	20.19	2.67	33.01	---	---	Peak
6	947.50	26.40	-19.60	46.00	30.64	24.26	3.29	31.79	100	221	Peak

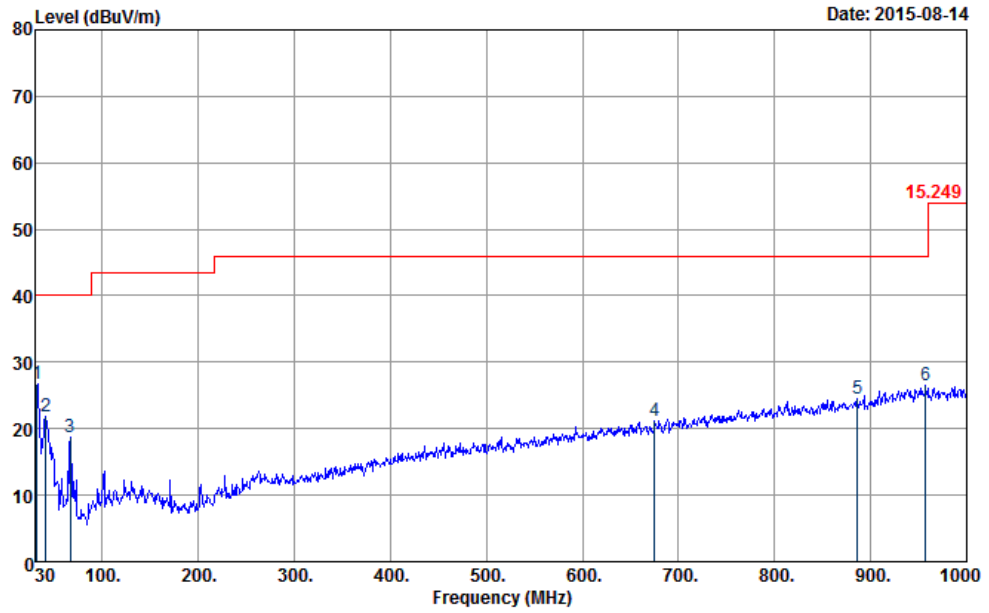

Site : 03CH10-HY
 Condition : 15.249 3m BI-LOG 6111D-LF VERTICAL
 Detector : Peak

	Freq	Level	Over Limit	Limit Line	ReadAntenna Level	Antenna Factor	Cable Loss	Preamp Factor	A/Pos	T/Pos	Remark
	MHz	dBuV/m	dB	dBuV/m	dBuV	dB/m	dB	dB	cm	deg	
1	32.16	26.79	-13.21	40.00	40.04	18.92	0.65	32.82	156	96	Peak
2	40.80	21.83	-18.17	40.00	40.04	13.94	0.65	32.80	---	---	Peak
3	66.72	18.77	-21.23	40.00	44.05	6.52	0.93	32.73	---	---	Peak
4	675.20	21.13	-24.87	46.00	31.06	20.40	2.67	33.00	---	---	Peak
5	886.60	24.56	-21.44	46.00	30.73	23.01	3.20	32.38	---	---	Peak
6	957.30	26.48	-19.52	46.00	30.60	24.27	3.29	31.68	---	---	Peak



<1GHz ~ 25GHz>

2403MHz

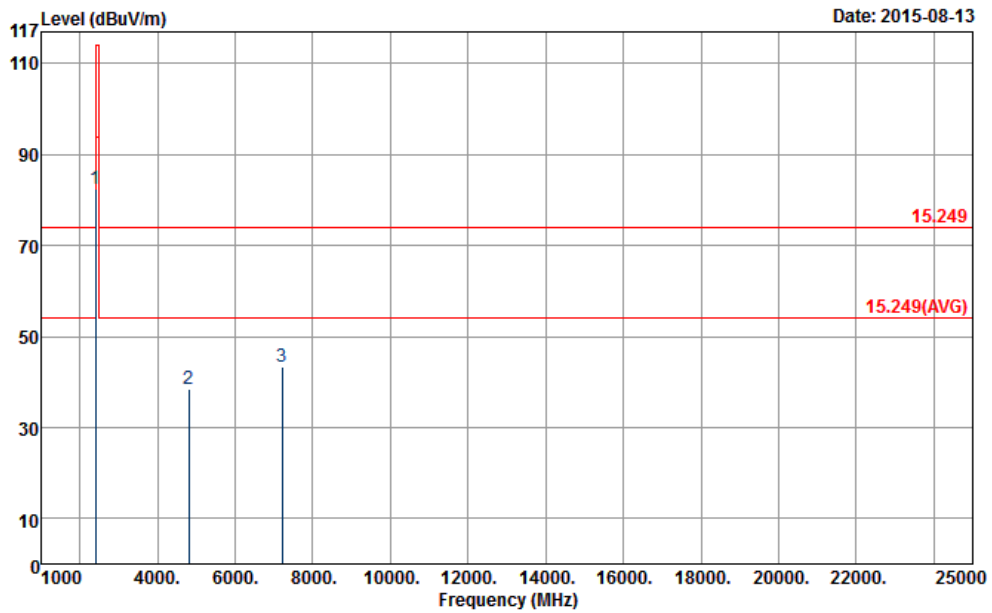

Site : 03CH10-HY
 Condition : 15.249 3m HORN_9170_40G_1404 HORIZONTAL

Mode : 1

	Freq	Level	Over Limit	Limit Line	ReadAntenna Level	Antenna Factor	Cable Loss	Preamp Factor	A/Pos	T/Pos	Remark
	MHz	dBuV/m	dB	dBuV/m	dBuV	dB/m	dB	dB	cm	deg	
1	2403.00	82.31	-31.69	114.00	82.86	27.28	5.39	33.22	373	41	Peak
2	4806.00	38.37	-35.63	74.00	60.01	31.42	7.58	60.64	100	0	Peak
3	7212.00	43.35	-30.65	74.00	58.57	35.96	9.44	60.62	100	0	Peak

Frequency (MHz)	Level (dBμV/m)	Over Limit (dB)	Limit Line (dBμV/m)	Read Level (dBμV)	Antenna Factor (dB)	Cable Loss (dB)	Preamp Factor (dB)	Ant Pos (cm)	Table Pos (deg)	Remark
2403	82.31	-31.69	114	82.86	27.28	5.39	33.22	373	41	Peak
2403	55.93	-38.07	94	-	-	-	-	-	-	Average

Note: For average measurement: use duty cycle correction factor method per 15.35(c).
 Average measurement was not performed if peak level went lower than the average limit.
 Test result of emissions which are 20 dB lower than the limit is not reported per 15.31.

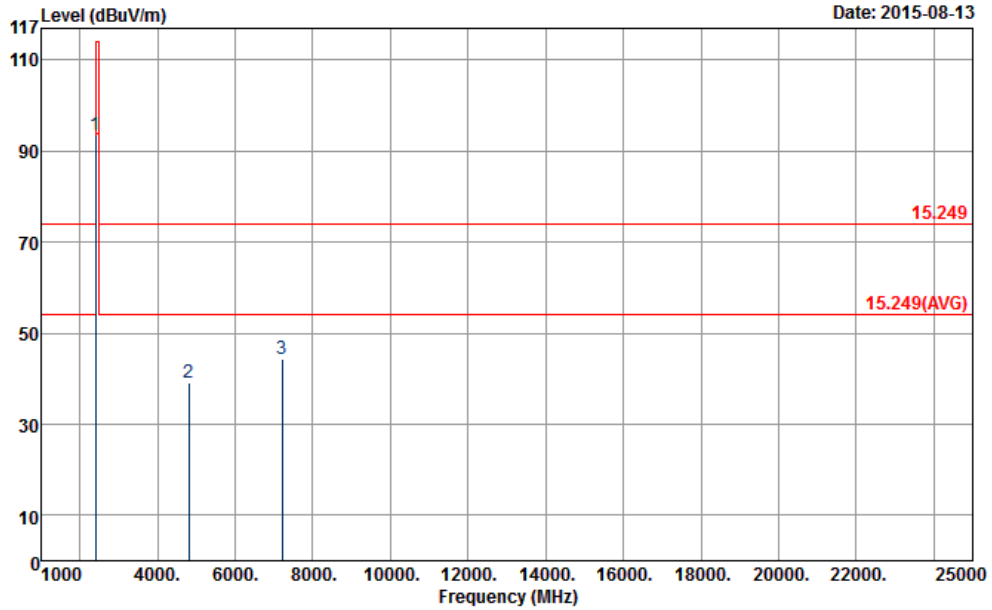

Site : 03CH10-HY
 Condition : 15.249 3m HORN_9170_40G_1404 VERTICAL
 Detector : Peak

	Freq	Level	Over Limit	Limit Line	ReadAntenna Level	Antenna Factor	Cable Loss	Preamp Factor	A/Pos	T/Pos	Remark
	MHz	dBuV/m	dB	dBuV/m	dBuV	dB/m	dB	dB	cm	deg	
1	2403.00	93.50	-20.50	114.00	94.05	27.28	5.39	33.22	365	14	Peak
2	4806.00	39.10	-34.90	74.00	60.74	31.42	7.58	60.64	100	0	Peak
3	7212.00	44.17	-29.83	74.00	59.39	35.96	9.44	60.62	100	0	Peak

Frequency (MHz)	Level (dBuV/m)	Over Limit (dB)	Limit Line (dBuV/m)	Read Level (dBuV)	Antenna Factor (dB)	Cable Loss (dB)	Preamp Factor (dB)	Ant Pos (cm)	Table Pos (deg)	Remark
2403	93.5	-20.5	114	94.05	27.28	5.39	33.22	365	14	Peak
2403	67.12	-26.88	94	-	-	-	-	-	-	Average

Note: For average measurement: use duty cycle correction factor method per 15.35(c).
 Average measurement was not performed if peak level went lower than the average limit.
 Test result of emissions which are 20 dB lower than the limit is not reported per 15.31.



2441MHz

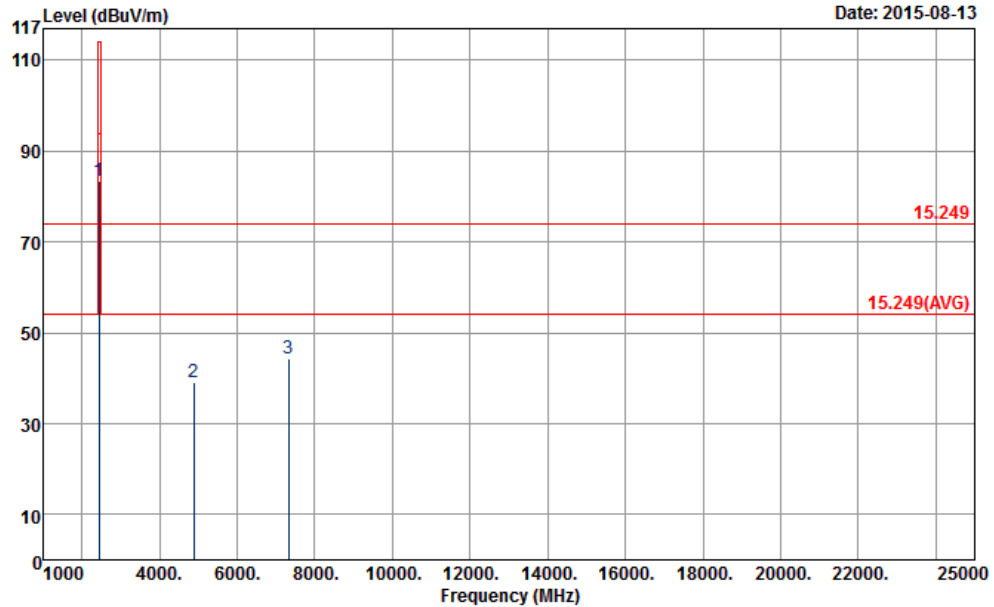

Site : 03CH10-HY
 Condition : 15.249 3m HORN_9170_406_1404 HORIZONTAL
 Detector : Peak

	Freq	Level	Over Limit	Limit Line	ReadAntenna Level	Antenna Factor	Cable Loss	Preamp Factor	A/Pos	T/Pos	Remark
	MHz	dBuV/m	dB	dBuV/m	dBuV	dB/m	dB	dB	cm	deg	
1	2441.00	83.45	-30.55	114.00	83.86	27.37	5.42	33.20	349	36	Peak
2	4884.00	39.23	-34.77	74.00	60.37	31.56	7.82	60.52	100	0	Peak
3	7320.00	44.25	-29.75	74.00	59.52	36.22	9.49	60.98	100	0	Peak

Frequency (MHz)	Level (dBµV/m)	Over Limit (dB)	Limit Line (dBµV/m)	Read Level (dBµV)	Antenna Factor (dB)	Cable Loss (dB)	Preamp Factor (dB)	Ant Pos (cm)	Table Pos (deg)	Remark
2441	83.45	-30.55	114	83.86	27.37	5.42	33.2	349	36	Peak
2441	57.07	-36.93	94	-	-	-	-	-	-	Average

Note: For average measurement: use duty cycle correction factor method per 15.35(c).
 Average measurement was not performed if peak level went lower than the average limit.
 Test result of emissions which are 20 dB lower than the limit is not reported per 15.31.

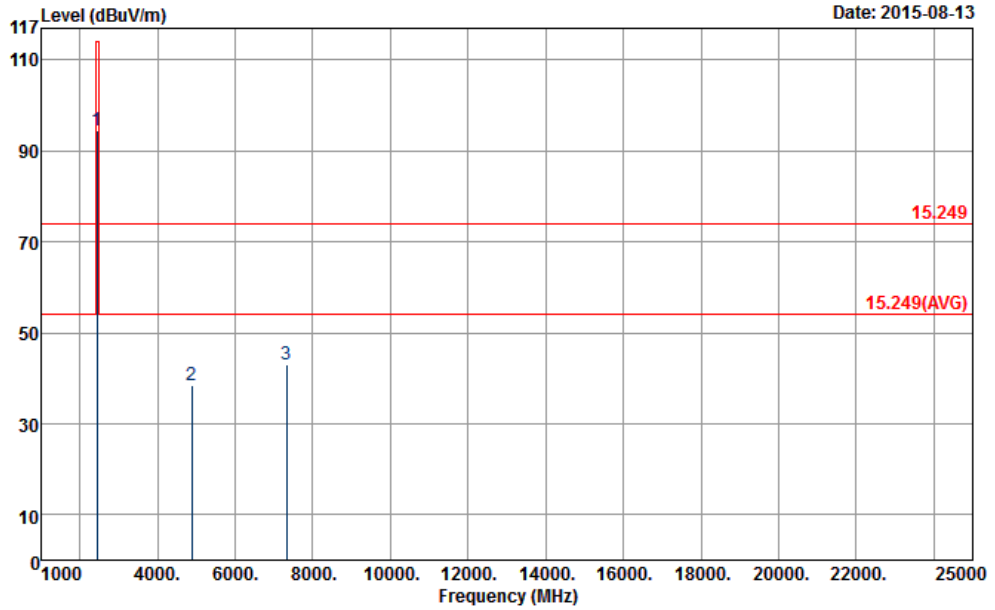

Site : 03CH10-HY
 Condition : 15.249 3m HORN_9170_406_1404 VERTICAL
 Detector : Peak

	Freq	Level	Over Limit	Limit Line	ReadAntenna Level	Antenna Factor	Cable Loss	Preamp Factor	A/Pos	T/Pos	Remark
	MHz	dBuV/m	dB	dBuV/m	dBuV	dB/m	dB	dB	cm	deg	
1	2441.00	94.44	-19.56	114.00	94.85	27.37	5.42	33.20	348	10	Peak
2	4884.00	38.62	-35.38	74.00	59.76	31.56	7.82	60.52	100	0	Peak
3	7320.00	43.06	-30.94	74.00	58.33	36.22	9.49	60.98	100	0	Peak

Frequency (MHz)	Level (dBμV/m)	Over Limit (dB)	Limit Line (dBμV/m)	Read Level (dBμV)	Antenna Factor (dB)	Cable Loss (dB)	Preamp Factor (dB)	Ant Pos (cm)	Table Pos (deg)	Remark
2441	94.44	-19.56	114	94.85	27.37	5.42	33.2	348	10	Peak
2441	68.06	-25.94	94	-	-	-	-	-	-	Average

Note: For average measurement: use duty cycle correction factor method per 15.35(c).
 Average measurement was not performed if peak level went lower than the average limit.
 Test result of emissions which are 20 dB lower than the limit is not reported per 15.31.



2480MHz

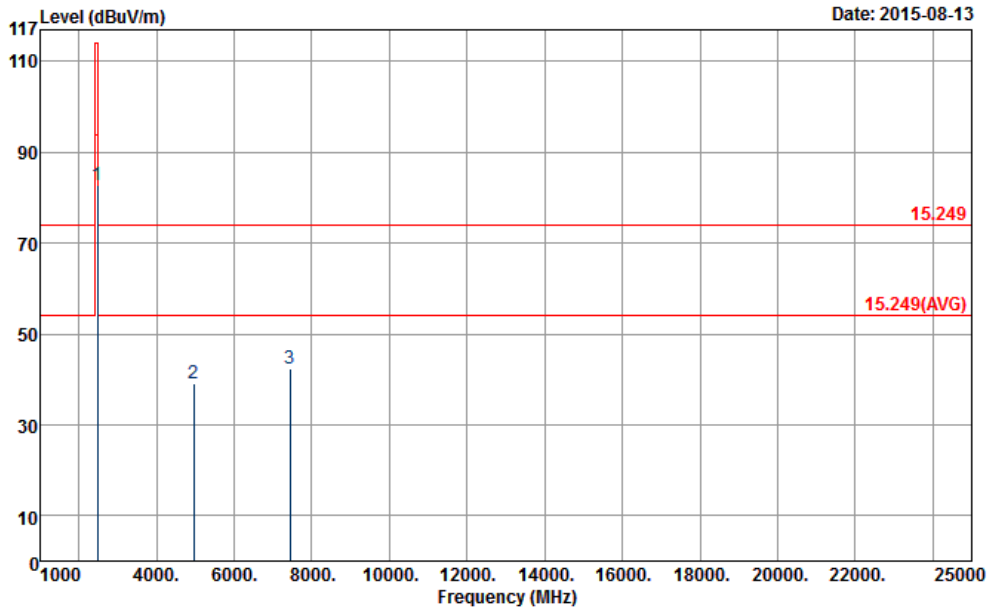

Site : 03CH10-HY
 Condition : 15.249 3m HORN_9170_406_1404 HORIZONTAL
 Detector : Peak

	Freq	Level	Over Limit	Limit Line	ReadAntenna Level	Antenna Factor	Cable Loss	Preamp Factor	A/Pos	T/Pos	Remark
	MHz	dBuV/m	dB	dBuV/m	dBuV	dB/m	dB	dB	cm	deg	
1	2480.00	82.66	-31.34	114.00	82.94	27.46	5.44	33.18	343	40	Peak
2	4962.00	39.04	-34.96	74.00	59.62	31.73	8.05	60.36	100	0	Peak
3	7440.00	42.37	-31.63	74.00	57.61	36.49	9.61	61.34	100	0	Peak

Frequency (MHz)	Level (dBμV/m)	Over Limit (dB)	Limit Line (dBμV/m)	Read Level (dBμV)	Antenna Factor (dB)	Cable Loss (dB)	Preamp Factor (dB)	Ant Pos (cm)	Table Pos (deg)	Remark
2480	82.66	-31.34	114	82.94	27.46	5.44	33.18	343	40	Peak
2480	56.28	-37.72	94	-	-	-	-	-	-	Average

Note: For average measurement: use duty cycle correction factor method per 15.35(c).
 Average measurement was not performed if peak level went lower than the average limit.
 Test result of emissions which are 20 dB lower than the limit is not reported per 15.31.

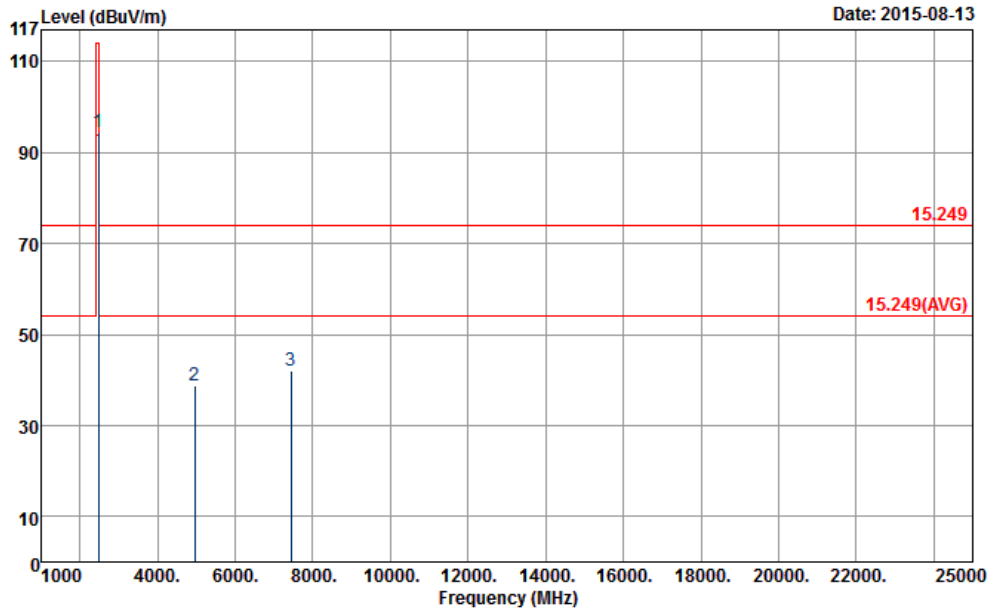

Site : 03CH10-HY
 Condition : 15.249 3m HORN_9170_40G_1404 VERTICAL
 Detector : Peak

	Freq	Level	Over Limit	Limit Line	ReadAntenna Level	Antenna Factor	Cable Loss	Preamp Factor	A/Pos	T/Pos	Remark
	MHz	dBuV/m	dB	dBuV/m	dBuV	dB/m	dB	dB	cm	deg	
1	2480.00	94.57	-19.43	114.00	94.85	27.46	5.44	33.18	300	359	Peak
2	4962.00	38.82	-35.18	74.00	59.40	31.73	8.05	60.36	100	0	Peak
3	7440.00	42.20	-31.80	74.00	57.44	36.49	9.61	61.34	100	0	Peak

Frequency (MHz)	Level (dBμV/m)	Over Limit (dB)	Limit Line (dBμV/m)	Read Level (dBμV)	Antenna Factor (dB)	Cable Loss (dB)	Preamp Factor (dB)	Ant Pos (cm)	Table Pos (deg)	Remark
2480	94.57	-19.43	114	94.85	27.46	5.44	33.18	300	359	Peak
2480	68.19	-25.81	94	-	-	-	-	-	-	Average

Note: For average measurement: use duty cycle correction factor method per 15.35(c).
 Average measurement was not performed if peak level went lower than the average limit.
 Test result of emissions which are 20 dB lower than the limit is not reported per 15.31.



3.4 Antenna Requirements

3.4.1 Limit

Except for special regulations, the Low-power Radio-frequency Devices must not be equipped with any jacket for installing an antenna with extension cable. An intentional radiator shall be designed to ensure that no antenna other than that furnished by the responsible party shall be used with the device. The use of a permanently attached antenna or of an antenna that uses a unique coupling to the intentional radiator shall be considered sufficient to comply with the provisions of this Section. The manufacturer may design the unit so that the user can replace a broken antenna, but the use of a standard antenna jack or electrical connector is prohibited.

3.4.2 Antenna Connector Construction

Embedded in Antenna.



4. LIST OF MEASURING EQUIPMENT

Instrument	Manufacturer	Model No.	Serial No.	Characteristics	Calibration Date	Test Date	Due Date	Remark
Power Meter	Agilent	E4416A	GB41292344	300MHz~40GHz	Jan. 14, 2015	Aug. 04, 2015	Jan. 13, 2016	Conducted (TH05-HY)
Power Sensor	Agilent	E9327A	US40441548	300MHz~40GHz	Jan. 14, 2015	Aug. 04, 2015	Jan. 13, 2016	Conducted (TH05-HY)
Spectrum Analyzer	Rohde & Schwarz	FSP40	100055	9kHz-40GHz	Jun. 18, 2015	Aug. 04, 2015	Jun. 17, 2016	Conducted (TH05-HY)
Hygrometer	Testo	608-H1	34897199	N/A	May 04, 2015	Aug. 04, 2015	May 03, 2016	Conducted (TH05-HY)
RF Cable	HARBOUR INDUSTRIES	LL142	Infinet CA3601-3601 -DLL	0.1MHz~40GHz	Mar. 06, 2015	Aug. 04, 2015	Mar. 05, 2016	Conducted (TH05-HY)
EMI Test Receiver	Rohde & Schwarz	ESCS 30	100356	9kHz - 2.75GHz	Dec. 01, 2014	Aug. 15, 2015	Nov. 30, 2015	Conduction (CO05-HY)
Hygrometer	Testo	608-H1	34913912	N/A	Apr. 20, 2015	Aug. 15, 2015	Apr. 19, 2016	Conduction (CO05-HY)
LISN	Rohde & Schwarz	ENV216	100080	9kHz~30MHz	Dec. 02, 2014	Aug. 15, 2015	Dec. 01, 2015	Conduction (CO05-HY)
AC Power Source()	ChainTek	APC-1000W	N/A	N/A	N/A	Aug. 15, 2015	N/A	Conduction (CO05-HY)
LF Cable	HUBER + SUHNER	RG-214/U	LF01	N/A	Jan. 07, 2015	Aug. 15, 2015	Jan. 06, 2016	Conduction (CO05-HY)
Test Software	N/A	EMC32	8.40.0	N/A	N/A	Aug. 15, 2015	N/A	Conduction (CO05-HY)
Horn Antenna	SCHWARZBECK	BBHA 9170	BBHA917058 4	18GHz- 40GHz	Nov. 03, 2014	Aug. 13, 2015~ Aug. 14, 2015	Nov. 02, 2015	Radiation (03CH10-HY)
Loop Antenna	TESEQ	HLA 6120	31244	9kHz~30MHz	Feb. 02, 2015	Aug. 13, 2015~ Aug. 14, 2015	Feb. 01, 2016	Radiation (03CH10-HY)
RF Cable	HUBER + SUHNER	SUCOFLEX 104	MY84209521	9kHz~1GHz	Dec. 04, 2014	Aug. 13, 2015~ Aug. 14, 2015	Dec. 03, 2015	Radiation (03CH10-HY)
Amplifier	SONOMA	310N	187311	9kHz~1GHz	Nov. 24, 2014	Aug. 13, 2015~ Aug. 14, 2015	Nov. 23, 2015	Radiation (03CH10-HY)
Bilog Antenna	TESEQ	CBL 6111D	35413	30MHz~1GHz	Oct. 24, 2014	Aug. 13, 2015~ Aug. 14, 2015	Oct. 23, 2015	Radiation (03CH10-HY)
EMI Test Receiver	Keysight	N9038A	MY54130085	20Hz ~ 8.4GHz	Nov. 05, 2014	Aug. 13, 2015~ Aug. 14, 2015	Nov. 04, 2015	Radiation (03CH10-HY)
Horn Antenna	SCHWARZBECK	BBHA 9120 D	9120D-1325	1GHz ~ 18GHz	Oct. 03, 2014	Aug. 13, 2015~ Aug. 14, 2015	Oct. 02, 2015	Radiation (03CH10-HY)
Hygrometer	TECPEL	DTM-303B	TP140320	N/A	Nov. 17, 2014	Aug. 13, 2015~ Aug. 14, 2015	Nov. 16, 2015	Radiation (03CH10-HY)
Preamplifier	Keysight	83017A	MY53270078	1GHz~26.5GHz	Nov. 20, 2014	Aug. 13, 2015~ Aug. 14, 2015	Nov. 19, 2015	Radiation (03CH10-HY)
Preamplifier	MITEQ	AMF-7D-001 01800-30-10 P	1902246	1GHz~18GHz	Nov. 25, 2014	Aug. 13, 2015~ Aug. 14, 2015	Nov. 24, 2015	Radiation (03CH10-HY)
Spectrum Analyzer	Keysight	N9010A	MY54200485	10Hz ~ 44GHz	Oct. 14, 2014	Aug. 13, 2015~ Aug. 14, 2015	Oct. 13, 2015	Radiation (03CH10-HY)
Test Software	N/A	E3	6.2009-8-24	N/A	N/A	Aug. 13, 2015~ Aug. 14, 2015	N/A	Radiation (03CH10-HY)



Instrument	Manufacturer	Model No.	Serial No.	Characteristics	Calibration Date	Test Date	Due Date	Remark
RF Cable	HUBER + SUHNER	SUCOFLEX 104	MY249564 MY249524 MY283184	25GHz~40GHz	Nov. 06, 2014	Aug. 13, 2015~ Aug. 14, 2015	Nov. 05, 2015	Radiation (03CH10-HY)
RF Cable	HUBER + SUHNER	SUCOFLEX 104	MY249564 MY249524 MY283184	30MHz~1GHz	Nov. 06, 2014	Aug. 13, 2015~ Aug. 14, 2015	Nov. 05, 2015	Radiation (03CH10-HY)
RF Cable	HUBER + SUHNER	SUCOFLEX 104	MY249564 MY249524 MY283184	1GHz~25GHz	Nov. 06, 2014	Aug. 13, 2015~ Aug. 14, 2015	Nov. 05, 2015	Radiation (03CH10-HY)
Controller	EMEC	EM 1000	N/A	Control Turn table & Ant Mast	N/A	Aug. 13, 2015~ Aug. 14, 2015	N/A	Radiation (03CH10-HY)
Antenna Mast	EMEC	AM-BS-4500 -B	N/A	1~4m	N/A	Aug. 13, 2015~ Aug. 14, 2015	N/A	Radiation (03CH10-HY)
Turn Table	EMEC	TT 2200	N/A	0-360 degree	N/A	Aug. 13, 2015~ Aug. 14, 2015	N/A	Radiation (03CH10-HY)
Preamplifier	MITEQ	JS44-18004 000-33-8P	1840917	18GHz ~ 40GHz	Jun. 02, 2015	Aug. 13, 2015~ Aug. 14, 2015	Jun. 01, 2016	Radiation (03CH10-HY)

Note: Test equipment calibration is traceable to the procedure of ISO17025.