



FCC RF Test Report

APPLICANT : Sony Mobile Communications Inc.
EQUIPMENT : GSM/WCDMA/LTE Phone + Bluetooth, DTS/UNII
a/b/g/n/ac, ANT+, and NFC
BRAND NAME : Sony
FCC ID : PY7-PM0907
STANDARD : FCC Part 15 Subpart E §15.407
CLASSIFICATION : (NII) Unlicensed National Information Infrastructure

The product was received on Jul. 16, 2015 and testing was completed on Aug. 15, 2015. We, SPORTON INTERNATIONAL INC., would like to declare that the tested sample has been evaluated in accordance with the test procedures and has been in compliance with the applicable technical standards.

The test results in this report apply exclusively to the tested model / sample. Without written approval of SPORTON INTERNATIONAL INC., the test report shall not be reproduced except in full.

Reviewed by: Joseph Lin / Supervisor

Approved by: Jones Tsai / Manager



SPORTON INTERNATIONAL INC.

No. 52, Hwa Ya 1st Rd., Hwa Ya Technology Park, Kwei-Shan District, Tao Yuan City, Taiwan, R.O.C.

SPORTON INTERNATIONAL INC.

TEL : 886-3-327-3456

FAX : 886-3-328-4978

FCC ID : PY7-PM0907

Page Number : 1 of 36

Report Issued Date : Sep. 17, 2015

Report Version : Rev. 01

Report Template No.: BU5-FR15EWLB4 AC MA Version 1.0



TABLE OF CONTENTS

REVISION HISTORY 3

SUMMARY OF TEST RESULT 4

1 GENERAL DESCRIPTION 5

 1.1 Applicant 5

 1.2 Manufacturer 5

 1.3 Feature of Equipment Under Test 5

 1.4 Modification of EUT 6

 1.5 Testing Location 6

 1.6 Applicable Standards 7

2 TEST CONFIGURATION OF EQUIPMENT UNDER TEST 8

 2.1 Carrier Frequency and Channel 8

 2.2 Pre-Scanned RF Power 8

 2.3 Test Mode 12

 2.4 Connection Diagram of Test System 13

 2.5 Support Unit used in test configuration and system 14

 2.6 EUT Operation Test Setup 14

 2.7 Measurement Results Explanation Example 14

3 TEST RESULT 15

 3.1 6dB Bandwidth Measurement 15

 3.2 Maximum Conducted Output Power Measurement 17

 3.3 Power Spectral Density Measurement 18

 3.4 Unwanted Emissions Measurement 21

 3.5 AC Conducted Emission Measurement 26

 3.6 Frequency Stability Measurement 30

 3.7 Automatically Discontinue Transmission 31

 3.8 Antenna Requirements 32

4 LIST OF MEASURING EQUIPMENT 34

5 UNCERTAINTY OF EVALUATION 36

APPENDIX A. CONDUCTED TEST RESULTS

APPENDIX B. RADIATED TEST RESULTS

APPENDIX C. RADIATED SPURIOUS EMISSION



REVISION HISTORY

REPORT NO.	VERSION	DESCRIPTION	ISSUED DATE
FR571613G	Rev. 01	Initial issue of report	Sep. 17, 2015



SUMMARY OF TEST RESULT

Report Section	FCC Rule	Description	Limit	Result	Remark
3.1	15.403(i)	6dB Bandwidth	> 500kHz	Pass	-
3.2	15.407(a)	Maximum Conducted Output Power	≤ 30 dBm	Pass	-
3.3	15.407(a)	Power Spectral Density	≤ 30 dBm/500kHz	Pass	-
3.4	15.407(b)	Unwanted Emissions	≤ -17, -27 dBm/MHz & 15.209(a)	Pass	Under limit 7.58 dB at 5714.600 MHz
3.5	15.207	AC Conducted Emission	15.207(a)	Pass	Under limit 22.30 dB at 0.614 MHz
3.6	15.407(g)	Frequency Stability	Within Operation Band	Pass	-
3.7	15.407(c)	Automatically Discontinue Transmission	Discontinue Transmission	Pass	-
3.8	15.203 & 15.407(a)	Antenna Requirement	N/A	Pass	-

Remark: The FR571613G report reuses test data from the FR571614G report.



1 General Description

1.1 Applicant

Sony Mobile Communications Inc.
Nya Vattentorget, 22188 Lund, Sweden

1.2 Manufacturer

Sony Mobile Communications Inc.
1-8-15 Konan, Minato-ku, Tokyo, 108-0075, Japan

1.3 Feature of Equipment Under Test

GSM/WCDMA/LTE, Bluetooth, DTS/UNII a/b/g/n/ac, ANT+, NFC, and GPS

Product Specification subjective to this standard	
Antenna Type	Main Antenna : Monopole Antenna Aux. Antenna : Monopole Antenna
Antenna Gain	Main Antenna : -4.10 dBi Aux. Antenna : -2.20 dBi

EUT Information List				
IMEI	HW Version	SW Version	S/N	Performed Test Item
004402541707638	A	32.0.B.0.192	CB5A279FXM	RF conducted measurement
004402541706580			CB5A279A2P9	Radiated Spurious Emission
004402541706721			CB5A279A2DY	Conducted Emission

Accessory List	
AC Adapter	Model No. : UCH20
	Type No. : AC-0061-US
	S/N : 5815W22500090 (for radiated spurious emission) 2115W15500021 (for conducted emission)
Earphone	Model No. : MDR-NC31E
	Type No. : AG-1110
USB Cable	Model No. : UCB11
	Type No. : AI-0120
	S/N : 1522A7390009100 (for radiated spurious emission) 1522A73000065C4 (for conducted emission)

Note:

- Above EUT list and accessory list used are electrically identical per declared by manufacturer.
- Above the accessories list are used to exercise the EUT during test.
- For other wireless features of this EUT, test report will be issued separately.



1.4 Modification of EUT

No modifications are made to the EUT during all test items.

1.5 Testing Location

Sporton Lab is accredited to ISO 17025 by Taiwan Accreditation Foundation (TAF code : 1190) and the FCC designation No. TW1022 under the FCC 2.948(e) by Mutual Recognition Agreement (MRA) in FCC Test.

Test Site	SPORTON INTERNATIONAL INC.	
Test Site Location	No. 52, Hwa Ya 1 st Rd., Hwa Ya Technology Park, Kwei-Shan District, Tao Yuan City, Taiwan, R.O.C. TEL: +886-3-327-3456 FAX: +886-3-328-4978	
Test Site No.	Sporton Site No.	
	TH05-HY	CO05-HY

Test Site	SPORTON INTERNATIONAL INC.	
Test Site Location	No.58, Aly. 75, Ln. 564, Wenhua 3rd Rd. Guishan Dist, Taoyuan City, Taiwan (R.O.C.) TEL: +886-3-327-0868 FAX: +886-3-327-0855	
Test Site No.	Sporton Site No.	
	03CH11-HY	

Note: The test site complies with ANSI C63.4 2009 requirement.



1.6 Applicable Standards

According to the specifications of the manufacturer, the EUT must comply with the requirements of the following standards:

- ♦ FCC Part 15 Subpart E
- ♦ FCC KDB 789033 D02 General UNII Test Procedures New Rules v01
- ♦ FCC KDB 662911 D01 Multiple Transmitter Output v02r01.
- ♦ FCC KDB 644545 D03 Guidance for IEEE 802 11ac New Rules v01
- ♦ ANSI C63.10-2009

Remark:

1. All test items were verified and recorded according to the standards and without any deviation during the test.
2. FCC permits the use of the 1.5 meter table as an alternative in C63.10-2013 through inquiry tracking number 961829.



2 Test Configuration of Equipment Under Test

The EUT has been associated with peripherals and configuration operated in a manner tended to maximize its emission characteristics in a typical application. Frequency range investigated: conducted emission (150 kHz to 30 MHz) and radiated emission (9 kHz to the 10th harmonic of the highest fundamental frequency or to 40 GHz, whichever is lower). For radiated measurement, pre-scanned in three orthogonal panels, X, Y, Z. The worst cases (X plane) were recorded in this report.

The final configuration from all the combinations and the worst-case data rates were investigated by measuring the maximum power across all the data rates and modulation modes under section 2.2.

Based on the worst configuration found above, the RF power setting is set individually to meet FCC compliance limit for the final conducted and radiated tests shown in section 2.3.

2.1 Carrier Frequency and Channel

Frequency Band	Channel	Freq. (MHz)	Channel	Freq. (MHz)
5725-5850 MHz Band 4 (U-NII-3)	149	5745	157	5785
	151	5755	159	5795
	153	5765	161	5805
	155	5775	165	5825

Note: The above Frequency and Channel in boldface were 802.11n HT40.

2.2 Pre-Scanned RF Power

The data rates were set in

6 Mbps for 802.11a, MCS0 for 802.11n HT20, and MCS0 for 802.11n HT40 for Ant. 1 and Ant. 2;

MCS8 for 802.11n HT20 and MCS8 for 802.11n HT40 for MIMO <Ant. 1 + 2>;

MCS0 for 802.11n VHT20, MCS0 for 802.11n VHT40, and MCS0 for 802.11n VHT80, due to the customer declared.



SISO <Ant. 1>

5GHz 802.11a mode			
Data Rate (MHz)	6M bps		
Channel	CH149	CH157	CH165
Frequency	5745	5785	5825
Average Power (dBm)	9.62	9.80	9.61

5GHz 802.11n HT20 mode			
Data Rate (MHz)	MCS0		
Channel	CH149	CH157	CH165
Frequency	5745	5785	5825
Average Power (dBm)	9.81	9.58	9.72

5GHz 802.11n HT40 mode		
Data Rate (MHz)	MCS0	
Channel	CH151	CH159
Frequency	5755	5795
Average Power (dBm)	9.59	9.72

5GHz 802.11ac VHT20 mode			
Data Rate (MHz)	MCS0		
Channel	CH149	CH157	CH165
Frequency	5745	5785	5825
Average Power (dBm)	9.80	9.52	9.75

5GHz 802.11ac VHT40 mode		
Data Rate (MHz)	MCS0	
Channel	CH151	CH159
Frequency	5755	5795
Average Power (dBm)	9.50	9.59

5GHz 802.11ac VHT80 mode	
Data Rate (MHz)	MCS0
Channel	CH155
Frequency	5775
Average Power (dBm)	9.77



SISO <Ant. Port 2>

5GHz 802.11a mode			
Data Rate (MHz)	6M bps		
Channel	CH149	CH157	CH165
Frequency	5745	5785	5825
Average Power (dBm)	9.51	9.61	9.54

5GHz 802.11n HT20 mode			
Data Rate (MHz)	MCS0		
Channel	CH149	CH157	CH165
Frequency	5745	5785	5825
Average Power (dBm)	9.51	9.54	9.61

5GHz 802.11n HT40 mode		
Data Rate (MHz)	MCS0	
Channel	CH151	CH159
Frequency	5755	5795
Average Power (dBm)	9.60	9.53

5GHz 802.11ac VHT20 mode			
Data Rate (MHz)	MCS0		
Channel	CH149	CH157	CH165
Frequency	5745	5785	5825
Average Power (dBm)	9.54	9.51	9.58

5GHz 802.11ac VHT40 mode		
Data Rate (MHz)	MCS0	
Channel	CH151	CH159
Frequency	5755	5795
Average Power (dBm)	9.56	9.67

5GHz 802.11ac VHT80 mode	
Data Rate (MHz)	MCS0
Channel	CH155
Frequency	5775
Average Power (dBm)	9.75



MIMO <Ant. 1+2>

5GHz 802.11a mode			
Data Rate (MHz)	6M bps		
Channel	CH149	CH157	CH165
Frequency	5745	5785	5825
Average Power (dBm)	12.81	12.83	12.73

5GHz 802.11n HT20 mode			
Data Rate (MHz)	MCS8		
Channel	CH149	CH157	CH165
Frequency	5745	5785	5825
Average Power (dBm)	12.86	12.65	12.85

5GHz 802.11n HT40 mode		
Data Rate (MHz)	MCS8	
Channel	CH151	CH159
Frequency	5755	5795
Average Power (dBm)	12.85	12.73

5GHz 802.11ac VHT20 mode			
Data Rate (MHz)	MCS0		
Channel	CH149	CH157	CH165
Frequency	5745	5785	5825
Average Power (dBm)	12.84	12.73	12.81

5GHz 802.11ac VHT40 mode		
Data Rate (MHz)	MCS0	
Channel	CH151	CH159
Frequency	5755	5795
Average Power (dBm)	12.84	12.71

5GHz 802.11ac VHT80 mode	
Data Rate (MHz)	MCS0
Channel	CH155
Frequency	5775
Average Power (dBm)	12.86

Note: MIMO Ant. 1+2 is a calculated result from sum of the power MIMO Ant. 1 and MIMO Ant. 2.



2.3 Test Mode

Final test mode of conducted test items and radiated spurious emissions are considering the modulation and worse data rates from the power table described in section 2.2.

The radiated spurious emissions testing were performed in n-mode only for HT20/40, which covers ac-mode testing.

Modulation	Data Rate
802.11a	6 Mbps
802.11n HT20	MCS0 / MCS8
802.11n HT40	MCS0 / MCS8
802.11ac VHT20	MCS0
802.11ac VHT40	MCS0
802.11ac VHT80	MCS0

AC Conducted Emission	Mode 1 : WLAN (5GHz) Link + Earphone + USB Cable (Charging from Adapter)
------------------------------	--

Ch. #		Band IV : 5725-5850 MHz		
		802.11a	802.11n HT20	802.11n HT40
L	Low	149	149	151
M	Middle	157	157	-
H	High	165	165	159

Ch. #		Band IV : 5725-5850 MHz		
		802.11ac VHT20	802.11ac VHT40	802.11ac VHT80
L	Low	149	151	-
M	Middle	157	-	155
H	High	165	159	-

2.4 Connection Diagram of Test System

<WLAN Tx Mode>

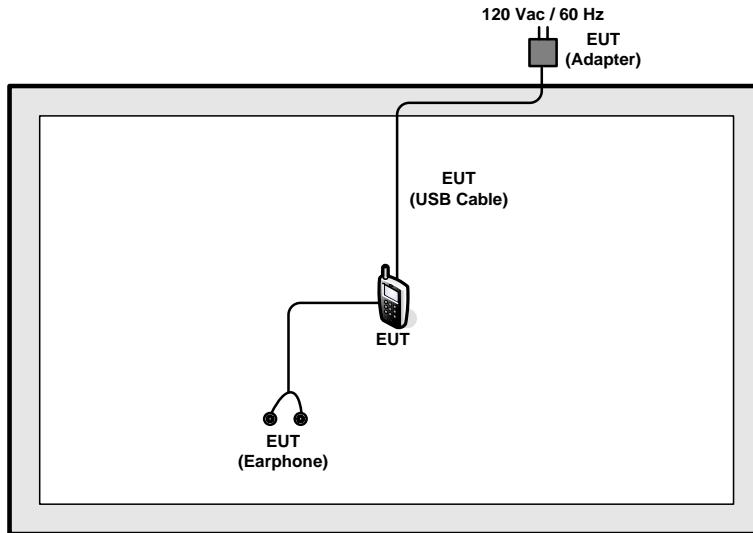

<AC Conducted Emission Mode>

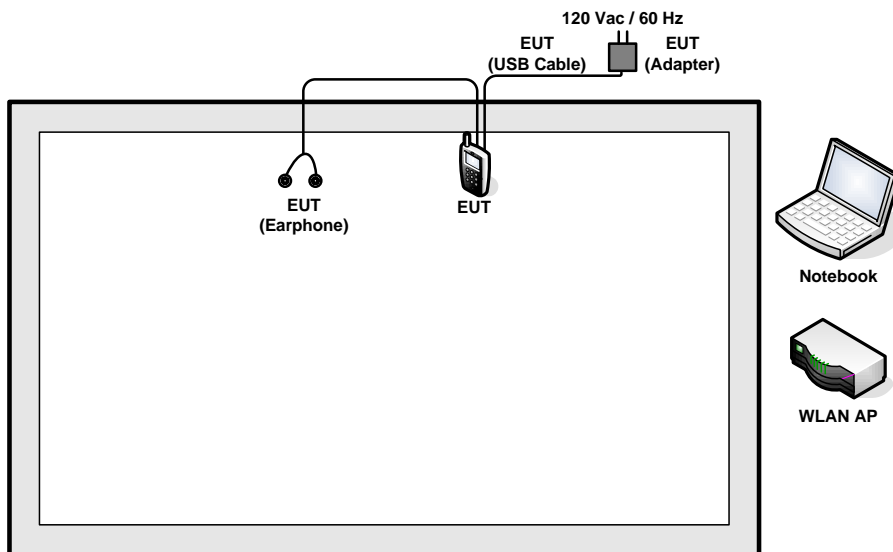



2.5 Support Unit used in test configuration and system

Item	Equipment	Trade Name	Model Name	FCC ID	Data Cable	Power Cord
1.	WLAN AP	D-Link	DIR-865L	KA2IR865LA1	N/A	Unshielded, 1.8 m
2.	Notebook	DELL	Latitude E6320	FCC DoC/ Contains FCC ID: QDS-BRCM1054	N/A	AC I/P: Unshielded, 1.2 m DC O/P: Shielded, 1.8 m
3.	SD Card	SanDisk	MicroSD HC	FCC DoC	N/A	N/A

2.6 EUT Operation Test Setup

For WLAN RF test items, an engineering test program was provided and enabled to make EUT continuous transmit/receive.

2.7 Measurement Results Explanation Example

For all conducted test items:

The offset level is set in the spectrum analyzer to compensate the RF cable loss and attenuator factor between EUT conducted output port and spectrum analyzer. With the offset compensation, the spectrum analyzer reading level is exactly the EUT RF output level.

Example :

The spectrum analyzer offset is derived from RF cable loss and attenuator factor.

Offset = RF cable loss + attenuator factor.

Following shows an offset computation example with cable loss 4.2 dB and 10dB attenuator.

$$\begin{aligned} \text{Offset(dB)} &= \text{RF cable loss(dB)} + \text{attenuator factor(dB)}. \\ &= 4.2 + 10 = 14.2 \text{ (dB)} \end{aligned}$$

3 Test Result

3.1 6dB Bandwidth Measurement

3.1.1 Description of 6dB Bandwidth

The minimum 6 dB bandwidth shall be at least 500 kHz.

3.1.2 Measuring Instruments

The measuring equipment is listed in the section 4 of this test report.

3.1.3 Test Procedures

1. The testing follows FCC KDB 789033 D02 General UNII Test Procedures New Rules v01.
Section C) Emission bandwidth for the band 5.725-5.85GHz
2. Set RBW = 100kHz.
3. Set the VBW $\geq 3 \times$ RBW.
4. Detector = Peak.
5. Trace mode = max hold
6. Measure the maximum width of the emission that is 6 dB down from the peak of the emission.
7. Measure and record the results in the test report.

3.1.4 Test Setup





3.1.5 Test Result of 6dB Bandwidth

Please refer to Appendix A.

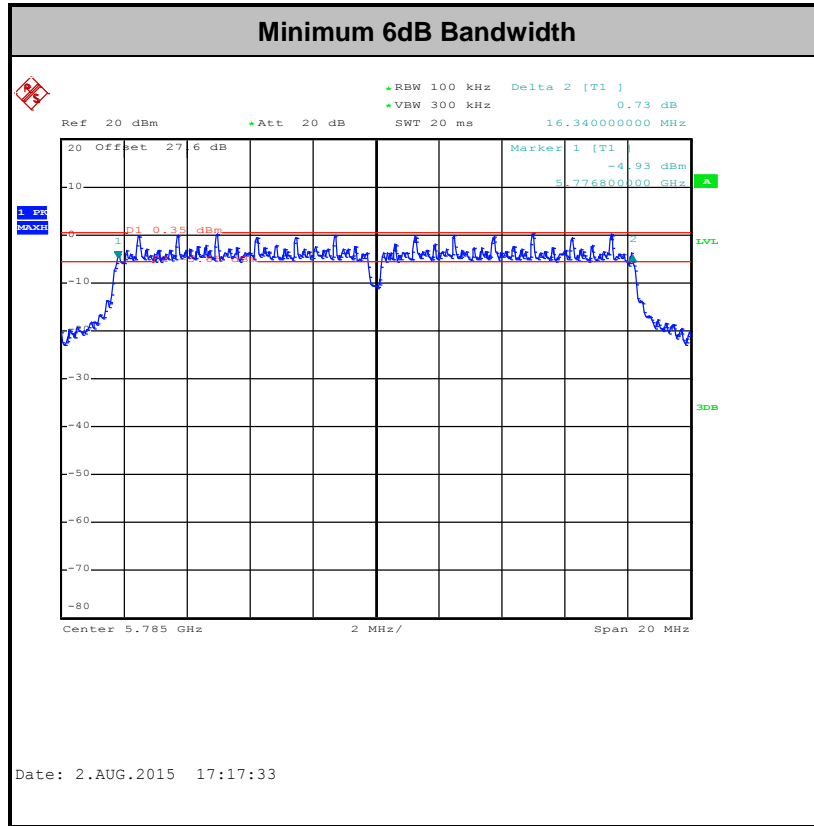

3.2 Maximum Conducted Output Power Measurement

3.2.1 Limit of Maximum Conducted Output Power

For the band 5.725–5.85 GHz, the maximum conducted output power over the frequency band of operation shall not exceed 1 W.

If transmitting antennas of directional gain greater than 6 dBi are used, the peak output power shall be reduced by the amount in dB that the directional gain of the antenna exceeds 6 dBi.

3.2.2 Measuring Instruments

The measuring equipment is listed in the section 4 of this test report.

3.2.3 Test Procedures

The testing follows Method PM of FCC KDB 789033 D02 General UNII Test Procedures New Rules v01.

Method PM (Measurement using an RF average power meter):

1. Measurement is performed using a wideband RF power meter.
2. The EUT is configured to transmit continuously with a consistent duty cycle at its maximum power control level.
3. Measure the average power of the transmitter, and the average power is corrected with duty factor, $10 \log(1/x)$, where x is the duty cycle.

3.2.4 Test Setup

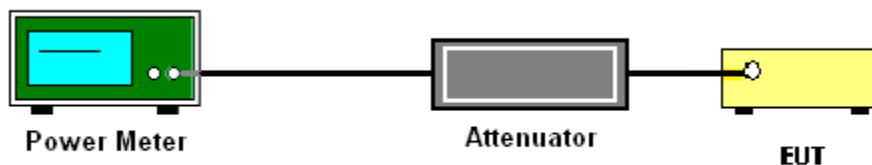

3.2.5 Test Result of Maximum Conducted Output Power

Please refer to Appendix A.



3.3 Power Spectral Density Measurement

3.3.1 Limit of Power Spectral Density

For the band 5.725–5.85 GHz, the maximum power spectral density shall not exceed 30 dBm in any 500-kHz band.

If transmitting antennas of directional gain greater than 6 dBi are used, the peak output power shall be reduced by the amount in dB that the directional gain of the antenna exceeds 6 dBi.

3.3.2 Measuring Instruments

The measuring equipment is listed in the section 4 of this test report.

3.3.3 Test Procedures

The testing follows FCC KDB 789033 D02 General UNII Test Procedures New Rules v01. Section F) Maximum power spectral density.

Method SA-2

(trace averaging across on and off times of the EUT transmissions, followed by duty cycle correction).

1. The testing follows Method SA-2 of FCC KDB 789033 D01 General UNII Test Procedures v01r03.
 - Measure the duty cycle.
 - Set span to encompass the entire emission bandwidth (EBW) of the signal.
 - Set RBW = 300 kHz.
 - Set VBW \geq 1 MHz.
 - Number of points in sweep \geq 2 Span / RBW.
 - Sweep time = auto.
 - Detector = RMS
 - Trace average at least 100 traces in power averaging mode.
 - Add $10 \log(500\text{kHz}/\text{RBW})$ to the test result.
 - Add $10 \log(1/x)$, where x is the duty cycle, to the measured power in order to compute the average power during the actual transmission times. For example, add $10 \log(1/0.25) = 6$ dB if the duty cycle is 25 percent.

2. The RF output of EUT was connected to the spectrum analyzer by a low loss cable.
3. Each plot has already offset with cable loss, and attenuator loss. Measure the PPSD and record it.
4. For **MIMO mode**, calculation method follows FCC KDB 662911 D01 Multiple Transmitter Output v02r01.

Method (1): Measure and sum the spectra across the outputs.

The total final Power Spectral Density is from a device with 2 transmitter outputs. The spectrum measurements of the individual outputs are all performed with the same span and number of points, the spectrum value in the first spectral bin of output 1 is summed with that in the first spectral bin of output 2 to obtain the value for the first frequency bin of the summed spectrum.

3.3.4 Test Setup

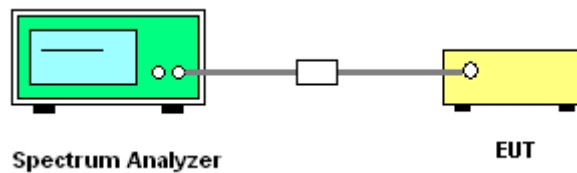



3.3.5 Test Result of Power Spectral Density

Please refer to Appendix A.

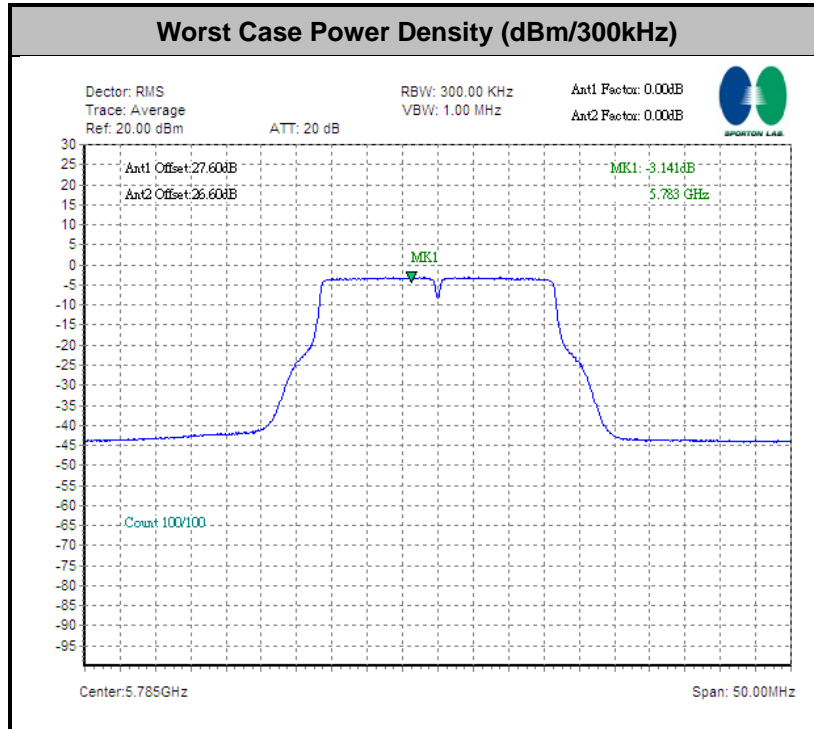



3.4 Unwanted Emissions Measurement

This section as specified in FCC Part 15.407(b) is to measure unwanted emissions through radiated measurement for band edge spurious emissions and out of band emissions measurement. The unwanted emissions shall comply with 15.407(b)(1) to (6), and restricted bands per FCC Part15.205.

3.4.1 Limit of Unwanted Emissions

- (1) For transmitters operating in the 5725-5850 MHz band: all emissions within the frequency range from the band edge to 10 MHz above or below the band edge shall not exceed an EIRP of -17 dBm/MHz (78.3dBµV/m); for frequencies 10 MHz or greater above or below the band edge, emissions shall not exceed an EIRP of -27 dBm/MHz (68.3dBµV/m).
- (2) Unwanted spurious emissions fallen in restricted bands per FCC Part15.205 shall comply with the general field strength limits set forth in § 15.209 as below table,

Frequency (MHz)	Field Strength (microvolts/meter)	Measurement Distance (meters)
0.009 – 0.490	2400/F(kHz)	300
0.490 – 1.705	24000/F(kHz)	30
1.705 – 30.0	30	30
30 – 88	100	3
88 – 216	150	3
216 - 960	200	3
Above 960	500	3

Note: The following formula is used to convert the EIRP to field strength.

$$E = \frac{1000000\sqrt{30P}}{3} \mu\text{V/m, where P is the eirp (Watts)}$$

EIRP (dBm)	Field Strength at 3m (dBµV/m)
-17	78.3
- 27	68.3

- (3) KDB789033 v01r03 H)2)c)(i) As specified in 15.407(b), emissions above 1000 MHz that are outside of the restricted bands are subject to a peak emission limit of -27 dBm/MHz (or -17 dBm/MHz as specified in 15.407(b)(4)). However, an out-of-band emission that complies with both the average and peak limits of 15.209 is not required to satisfy the -27 dBm/MHz or -17 dBm/MHz peak emission limit.



3.4.2 Measuring Instruments

The measuring equipment is listed in the section 4 of this test report.

3.4.3 Test Procedures

1. The testing follows FCC KDB 789033 D02 General UNII Test Procedures New Rules v01. Section G) Unwanted emissions measurement.

(1) Procedure for Unwanted Emissions Measurements Below 1000MHz

- RBW = 120 kHz
- VBW = 300 kHz
- Detector = Peak
- Trace mode = max hold

(2) Procedure for Peak Unwanted Emissions Measurements Above 1000 MHz

- RBW = 1 MHz
- VBW ≥ 3 MHz
- Detector = Peak
- Sweep time = auto
- Trace mode = max hold

(3) Procedures for Average Unwanted Emissions Measurements Above 1000MHz

- RBW = 1 MHz
- VBW = 10 Hz, when duty cycle is no less than 98 percent.
- $VBW \geq 1/T$, when duty cycle is less than 98 percent where T is the minimum transmission duration over which the transmitter is on and is transmitting at its maximum power control level for the tested mode of operation.

Antenna	Band	Duty Cycle(%)	T(us)	1/T(kHz)	VBW Setting
1+2	802.11a for Ant1	100	-	-	10Hz
1+2	802.11a for Ant2	100	-	-	
1+2	802.11n HT20 for Ant1	98.67	-	-	
1+2	802.11n HT20 for Ant2	98.67	-	-	
1+2	802.11n HT40 for Ant1	97.35	736.00	1.36	3kHz
1+2	802.11n HT40 for Ant2	97.37	740.00	1.35	
1+2	802.11ac VHT80 for Ant1	94.85	368.00	2.72	
1+2	802.11ac VHT80 for Ant2	94.79	364.00	2.75	



2. The EUT was placed on a turntable with 0.8 meter for frequency below 1GHz and 1.5 meter for frequency above 1GHz respectively above ground.
3. The EUT was set 3 meters from the interference receiving antenna which was mounted on the top of a variable height antenna tower.
4. The antenna is a broadband antenna and its height is adjusted between one meter and four meters above ground to find the maximum value of the field strength for both horizontal polarization and vertical polarization of the antenna.
5. For each suspected emission, the EUT was arranged to its worst case and then adjust the antenna tower (from 1 m to 4 m) and turntable (from 0 degree to 360 degrees) to find the maximum reading.
6. For testing below 1GHz, if the emission level of the EUT in peak mode was 3 dB lower than the limit specified, then peak values of EUT will be reported, otherwise, the emissions will be repeated one by one using the CISPR quasi-peak method and reported.
7. For testing above 1GHz, the emission level of the EUT in peak mode was 20dB lower than average limit (that means the emission level in average mode also complies with the limit in average mode), then peak values of EUT will be reported, otherwise, the emissions will be measured in average mode again and reported.

3.4.4 Test Setup

For radiated emissions below 30MHz

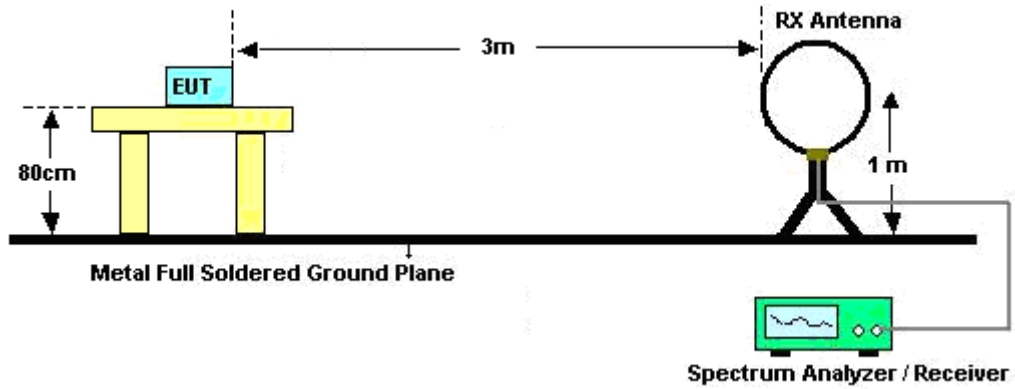

For radiated emissions from 30MHz to 1GHz

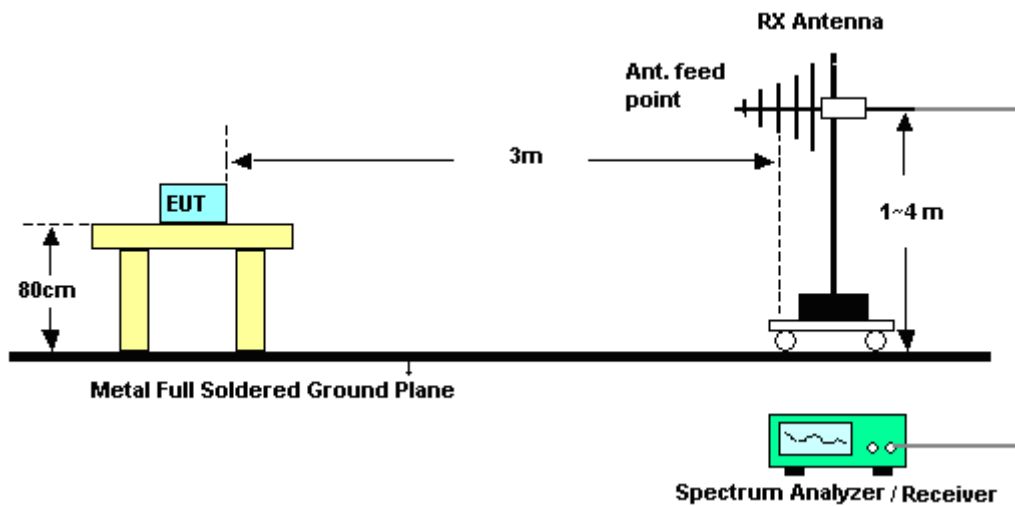

For radiated emissions above 1GHz

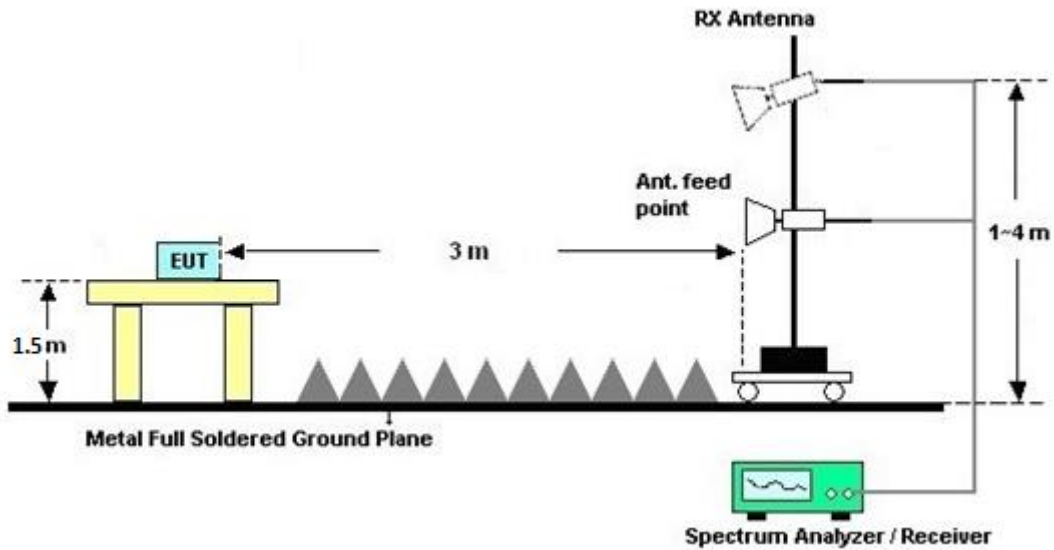

3.4.5 Test Results of Radiated Emissions (9 kHz ~ 30 MHz)

The low frequency, which started from 9 kHz to 30MHz, was pre-scanned and the result which was 20dB lower than the limit line per 15.31(o) was not reported.

3.4.6 Test Result of Radiated Band Edges

Please refer to Appendix B and C of this test report.

3.4.7 Test Result of Unwanted Radiated Emission (30MHz ~ 10th Harmonic)

Please refer to Appendix B and C of this test report.



3.5 AC Conducted Emission Measurement

3.5.1 Limit of AC Conducted Emission

For equipment that is designed to be connected to the public utility (AC) power line, the radio frequency voltage that is conducted back onto the AC power line on any frequency or frequencies within the band 150 kHz to 30 MHz shall not exceed the limits in the following table.

Frequency of emission (MHz)	Conducted limit (dB μ V)	
	Quasi-peak	Average
0.15-0.5	66 to 56*	56 to 46*
0.5-5	56	46
5-30	60	50

*Decreases with the logarithm of the frequency.

3.5.2 Measuring Instruments

The measuring equipment is listed in the section 4 of this test report.

3.5.3 Test Procedures

1. The EUT was placed 0.4 meter from the conducting wall of the shielding room was kept at least 80 centimeters from any other grounded conducting surface.
2. Connect EUT to the power mains through a line impedance stabilization network (LISN).
3. All the support units are connecting to the other LISN.
4. The LISN provides 50 ohm coupling impedance for the measuring instrument.
5. The FCC states that a 50 ohm, 50 microhenry LISN should be used.
6. Both sides of AC line were checked for maximum conducted interference.
7. The frequency range from 150 kHz to 30 MHz was searched.
8. Set the test-receiver system to Peak Detect Function and specified bandwidth with Maximum Hold Mode.

3.5.4 Test Setup

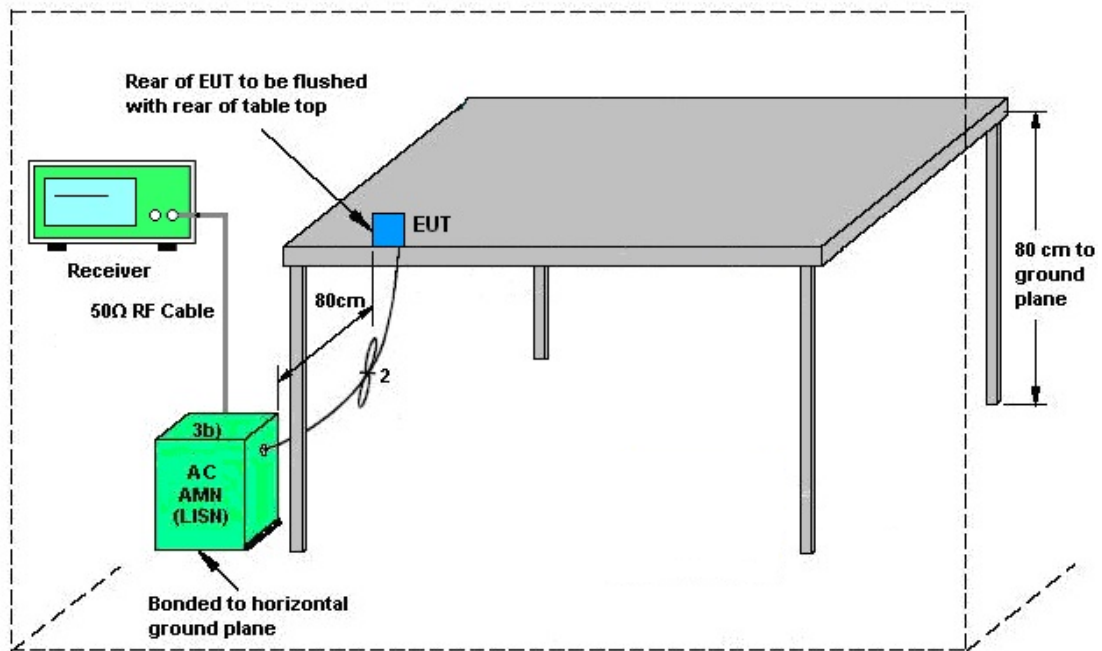

AMN = Artificial mains network (LISN)
AE = Associated equipment
EUT = Equipment under test
ISN = Impedance stabilization network



3.5.5 Test Result of AC Conducted Emission

Test Mode :	Mode 1	Temperature :	23~25°C
Test Engineer :	Eric Jeng	Relative Humidity :	58~61%
Test Voltage :	120Vac / 60Hz	Phase :	Line
Function Type :	WLAN (5GHz) Link + Earphone + USB Cable (Charging from Adapter)		

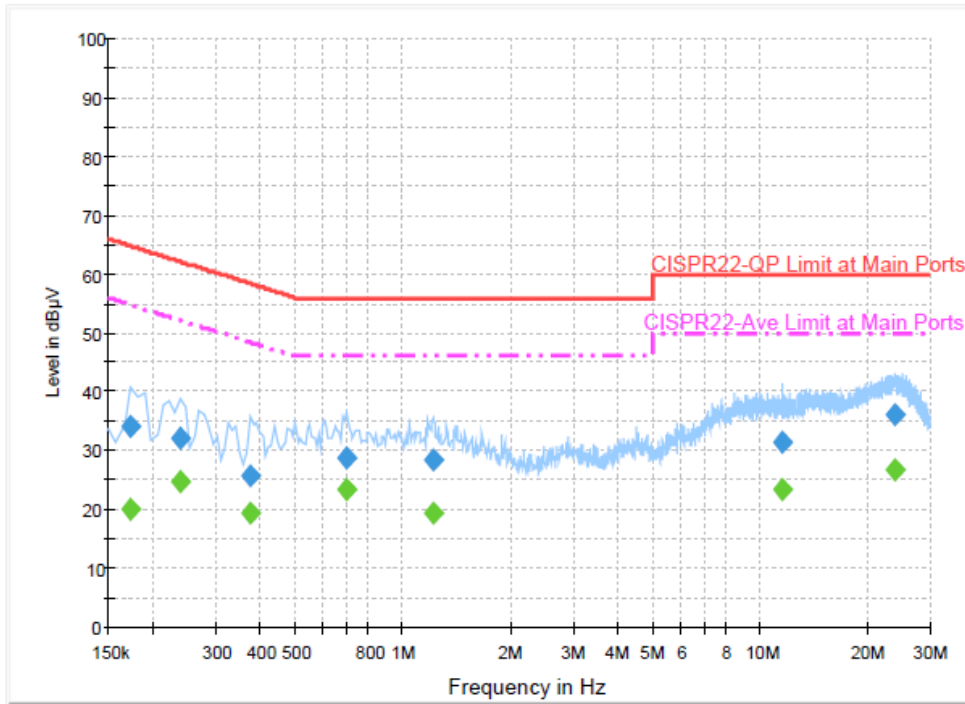

Final Result : QuasiPeak

Frequency (MHz)	QuasiPeak (dBµV)	Filter	Line	Corr. (dB)	Margin (dB)	Limit (dBµV)
0.174000	34.1	Off	L1	19.5	30.7	64.8
0.238000	32.1	Off	L1	19.5	30.1	62.2
0.374000	25.7	Off	L1	19.5	32.7	58.4
0.694000	28.9	Off	L1	19.6	27.1	56.0
1.214000	28.5	Off	L1	19.6	27.5	56.0
11.582000	31.6	Off	L1	19.9	28.4	60.0
23.902000	36.0	Off	L1	20.0	24.0	60.0

Final Result : Average

Frequency (MHz)	Average (dBµV)	Filter	Line	Corr. (dB)	Margin (dB)	Limit (dBµV)
0.174000	20.2	Off	L1	19.5	34.6	54.8
0.238000	24.8	Off	L1	19.5	27.4	52.2
0.374000	19.3	Off	L1	19.5	29.1	48.4
0.694000	23.3	Off	L1	19.6	22.7	46.0
1.214000	19.4	Off	L1	19.6	26.6	46.0
11.582000	23.3	Off	L1	19.9	26.7	50.0
23.902000	26.8	Off	L1	20.0	23.2	50.0



Test Mode :	Mode 1	Temperature :	23~25°C
Test Engineer :	Eric Jeng	Relative Humidity :	58~61%
Test Voltage :	120Vac / 60Hz	Phase :	Neutral
Function Type :	WLAN (5GHz) Link + Earphone + USB Cable (Charging from Adapter)		

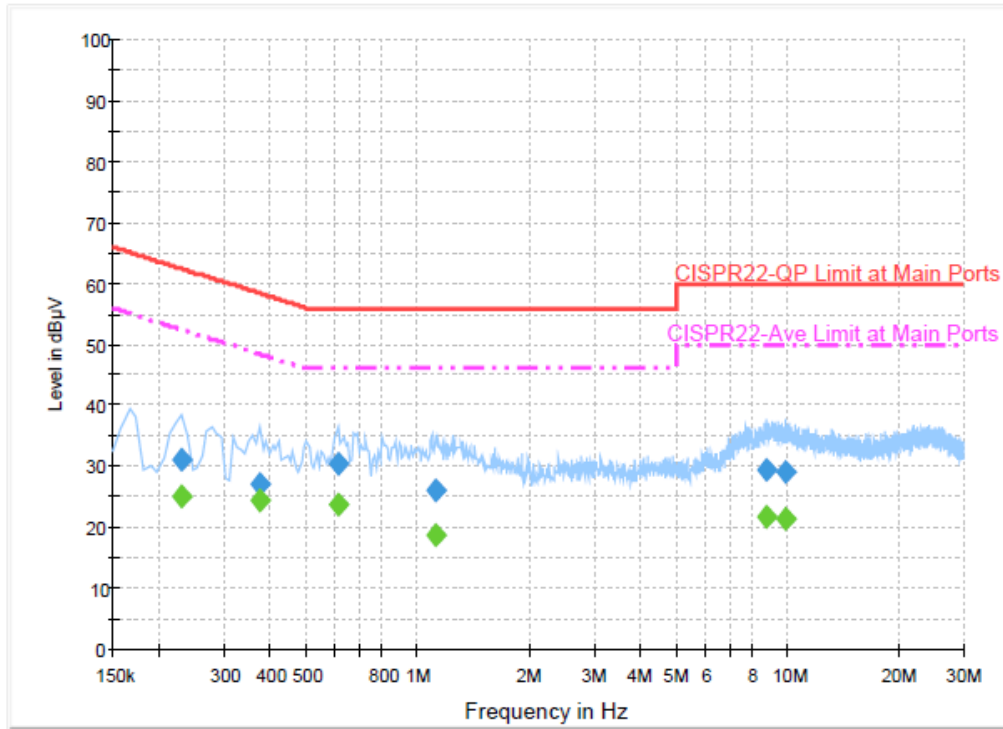

Final Result : QuasiPeak

Frequency (MHz)	QuasiPeak (dBµV)	Filter	Line	Corr. (dB)	Margin (dB)	Limit (dBµV)
0.230000	31.2	Off	N	19.6	31.2	62.4
0.374000	27.0	Off	N	19.5	31.4	58.4
0.614000	30.4	Off	N	19.5	25.6	56.0
1.126000	25.9	Off	N	19.5	30.1	56.0
8.790000	29.6	Off	N	19.8	30.4	60.0
9.942000	29.0	Off	N	19.9	31.0	60.0

Final Result : Average

Frequency (MHz)	Average (dBµV)	Filter	Line	Corr. (dB)	Margin (dB)	Limit (dBµV)
0.230000	25.2	Off	N	19.6	27.2	52.4
0.374000	24.5	Off	N	19.5	23.9	48.4
0.614000	23.7	Off	N	19.5	22.3	46.0
1.126000	18.7	Off	N	19.5	27.3	46.0
8.790000	21.7	Off	N	19.8	28.3	50.0
9.942000	21.4	Off	N	19.9	28.6	50.0

3.6 Frequency Stability Measurement

3.6.1 Limit of Frequency Stability

Manufacturers of U-NII devices are responsible for ensuring frequency stability such that an emission is maintained within the band of operation under all conditions of normal operation as specified in the user's manual.

3.6.2 Measuring Instruments

The measuring equipment is listed in the section 4 of this test report.

3.6.3 Test Procedures

1. To ensure emission at the band edge is maintained within the authorized band, those values shall be measured by radiation emissions at upper and lower frequency points, and finally compensated by frequency deviation as procedures below.
2. The EUT was operated at the maximum output power, and connected to the spectrum analyzer, which is set to maximum hold function and peak detector. The peak value of the power envelope was measured and noted. The upper and lower frequency points were respectively measured relatively 10dB lower than the measured peak value.
3. The frequency deviation was calculated by adding the upper frequency point and the lower frequency point divided by two. Those detailed values of frequency deviation are provided in table below.

3.6.4 Test Setup



3.6.5 Test Result of Frequency Stability

Please refer to Appendix A.



3.7 Automatically Discontinue Transmission

3.7.1 Limit of Automatically Discontinue Transmission

The device shall automatically discontinue transmission in case of either absence of information to transmit or operational failure. These provisions are not intended to preclude the transmission of control or signaling information or the use of repetitive codes used by certain digital technologies to complete frame or burst intervals. Applicants shall include in their application for equipment authorization to describe how this requirement is met.

3.7.2 Measuring Instruments

The measuring equipment is listed in the section 4 of this test report.

3.7.3 Test Result of Automatically Discontinue Transmission

While the EUT is not transmitting any information, the EUT can automatically discontinue transmission and become standby mode for power saving. The EUT can detect the controlling signal of ACK message transmitting from remote device and verify whether it shall resend or discontinue transmission.

3.8 Antenna Requirements

3.8.1 Standard Applicable

According to FCC 47 CFR Section 15.407(a)(1)(2) ,if transmitting antenna directional gain is greater than 6 dBi, both the peak transmit power and the peak power spectral density shall be reduced by the amount in dB that the directional gain of the antenna exceeds 6 dBi.

3.8.2 Antenna Anti-Replacement Construction

An embedded-in antenna design is used.

3.8.3 Antenna Gain

FCC KDB 662911 D01 Multiple Transmitter Output v02r01

For CDD transmissions, directional gain is calculated as

$$DirectionalGain = 10 \cdot \log \left[\frac{\sum_{j=1}^{N_{SS}} \left\{ \sum_{k=1}^{N_{ANT}} g_{j,k} \right\}^2}{N_{ANT}} \right]$$

where

Each antenna is driven by no more than one spatial stream;

N_{SS} = the number of independent spatial streams of data;

N_{ANT} = the total number of antennas

$g_{j,k} = 10^{G_k / 20}$ if the k th antenna is being fed by spatial stream j , or zero if it is not;
 G_k is the gain in dBi of the k th antenna.



The EUT supports CDD mode.

The power and PSD limit should be modified if the directional gain of EUT is over 6 dBi,

The directional gain "DG" is calculated as following table.

			DG for Power (dBi)	DG for PSD (dBi)	Power Limit Reduction (dB)	PSD Limit Reduction (dB)
	Ant 1 (dBi)	Ant 2 (dBi)				
Band IV	-4.10	-2.20	-0.09	-0.09	0.00	0.00

$$\text{Power Limit Reduction} = DG(\text{Power}) - 6\text{dBi}, (\text{min} = 0)$$

$$\text{PSD Limit Reduction} = DG(\text{PSD}) - 6\text{dBi}, (\text{min} = 0)$$



4 List of Measuring Equipment

Instrument	Manufacturer	Model No.	Serial No.	Characteristics	Calibration Date	Test Date	Due Date	Remark
Power Meter	Anritsu	ML2495A	1218006	300MHz~40GHz	Oct. 18, 2014	Aug. 02, 2015	Oct. 17, 2015	Conducted (TH05-HY)
Power Sensor	Anritsu	MA2411B	1207363	300MHz~40GHz	Oct. 18, 2014	Aug. 02, 2015	Oct. 17, 2015	Conducted (TH05-HY)
Spectrum Analyzer	Rohde & Schwarz	FSP40	100057	9kHz-40GHz	Oct. 17, 2014	Aug. 02, 2015	Oct. 16, 2015	Conducted (TH05-HY)
Temperature Chamber	ESPEC	SU-241	92003713	-30°C~95°C	Jun. 15, 2015	Aug. 02, 2015	Jun. 14, 2016	Conducted (TH05-HY)
Hygrometer	Testo	608-H1	34897199	N/A	May 04, 2015	Aug. 02, 2015	May 03, 2016	Conducted (TH05-HY)
RF Cable	HARBOUR INDUSTRIES	LL142	Infinet CA3601-3601-DLL	0.1MHz~40GHz	Mar. 06, 2015	Aug. 02, 2015	Mar. 05, 2016	Conducted (TH05-HY)
Horn Antenna	SCHWARZBECK	BBHA 9170	BBHA9170584	18GHz- 40GHz	Nov. 03, 2014	Aug. 11, 2015 ~ Aug. 13, 2015	Nov. 02, 2015	Radiation (03CH11-HY)
Loop Antenna	TESEQ	HLA 6120	31244	9kHz~30MHz	Feb. 02, 2015	Aug. 11, 2015 ~ Aug. 13, 2015	Feb. 01, 2016	Radiation (03CH11-HY)
RF Cable	HUBER + SUHNER	SUCOFLEX 104	MY84209521	9kHz~1GHz	Dec. 04, 2014	Aug. 11, 2015 ~ Aug. 13, 2015	Dec. 03, 2015	Radiation (03CH11-HY)
EMI Test Receiver	Keysight	N9038A	MY54130085	20Hz ~ 8.4GHz	Nov. 05, 2014	Aug. 11, 2015 ~ Aug. 13, 2015	Nov. 04, 2015	Radiation (03CH11-HY)
Amplifier	SONOMA	310N	187312	9kHz~1GHz	Nov. 24, 2014	Aug. 11, 2015 ~ Aug. 13, 2015	Nov. 23, 2015	Radiation (03CH11-HY)
Bilog Antenna	TESEQ	CBL 6111D	35414	30MHz~1GHz	Oct. 24, 2014	Aug. 11, 2015 ~ Aug. 13, 2015	Oct. 23, 2015	Radiation (03CH11-HY)
Horn Antenna	SCHWARZBECK	BBHA 9120 D	9120D-1326	1GHz ~ 18GHz	Oct. 03, 2014	Aug. 11, 2015 ~ Aug. 13, 2015	Oct. 02, 2015	Radiation (03CH11-HY)
Hygrometer	TECPEL	DTN-303B	TP140325	N/A	Nov. 19, 2014	Aug. 11, 2015 ~ Aug. 13, 2015	Nov. 18, 2015	Radiation (03CH11-HY)
Preamplifier	Keysight	83017A	MY53270080	1GHz~26.5GHz	Nov. 20, 2014	Aug. 11, 2015 ~ Aug. 13, 2015	Nov. 19, 2015	Radiation (03CH11-HY)
Preamplifier	MITEQ	AMF-7D-0010 1800-30-10P	1902247	1GHz~18GHz	Jul. 01, 2015	Aug. 11, 2015 ~ Aug. 13, 2015	Jun. 30, 2016	Radiation (03CH11-HY)
Spectrum Analyzer	Keysight	N9010A	MY54200486	10Hz ~ 44GHZ	Sep. 24, 2014	Aug. 11, 2015 ~ Aug. 13, 2015	Sep. 23, 2015	Radiation (03CH11-HY)
RF Cable	HUBER + SUHNER	SUCOFLEX 104	MY24967/4 MY28419/4 MY28654/4	25GHz~40GHz	Nov. 06, 2014	Aug. 11, 2015 ~ Aug. 13, 2015	Nov. 05, 2015	Radiation (03CH11-HY)
RF Cable	HUBER + SUHNER	SUCOFLEX 104	MY24967/4 MY28419/4 MY28654/4	30MHz~1GHz	Nov. 06, 2014	Aug. 11, 2015 ~ Aug. 13, 2015	Nov. 05, 2015	Radiation (03CH11-HY)
RF Cable	HUBER + SUHNER	SUCOFLEX 104	MY24967/4 MY28419/4 MY28654/4	1GHz~25GHz	Nov. 06, 2014	Aug. 11, 2015 ~ Aug. 13, 2015	Nov. 05, 2015	Radiation (03CH11-HY)



Instrument	Manufacturer	Model No.	Serial No.	Characteristics	Calibration Date	Test Date	Due Date	Remark
Controller	EMEC	EM 1000	N/A	Control Turn table & Ant Mast	N/A	Aug. 11, 2015 ~ Aug. 13, 2015	N/A	Radiation (03CH11-HY)
Antenna Mast	EMEC	AM-BS-4500-B	N/A	1~4m	N/A	Aug. 11, 2015 ~ Aug. 13, 2015	N/A	Radiation (03CH11-HY)
Turn Table	EMEC	TT 2000	N/A	0-360 degree	N/A	Aug. 11, 2015 ~ Aug. 13, 2015	N/A	Radiation (03CH11-HY)
Preamplifier	MITEQ	JS44-18004000-33-8P	1840917	18GHz ~ 40GHz	Jun. 02, 2015	Aug. 11, 2015 ~ Aug. 13, 2015	Jun. 01, 2016	Radiation (03CH11-HY)
Filter	Wainwright	WLKS4500-8SS	SN19	4.5G Low Pass	Oct. 01, 2014	Aug. 11, 2015 ~ Aug. 13, 2015	Sep. 30, 2015	Radiation (03CH11-HY)
Filter	Microwave Circuits	H07G18G3	SN8009-01	7GHz HPF	Oct. 01, 2014	Aug. 11, 2015 ~ Aug. 13, 2015	Sep. 30, 2015	Radiation (03CH11-HY)
Test Software	Audix	E3	6.2009-8-24	N/A	N/A	Aug. 11, 2015 ~ Aug. 13, 2015	N/A	Radiation (03CH11-HY)
EMI Test Receiver	Rohde & Schwarz	ESCS 30	100356	9kHz – 2.75GHz	Dec. 01, 2014	Aug. 15, 2015	Nov. 30, 2015	Conduction (CO05-HY)
Hygrometer	Testo	608-H1	34913912	N/A	Apr. 20, 2015	Aug. 15, 2015	Apr. 19, 2016	Conduction (CO05-HY)
LISN	Rohde & Schwarz	ENV216	100080	9kHz~30MHz	Dec. 02, 2014	Aug. 15, 2015	Dec. 01, 2015	Conduction (CO05-HY)
AC Power Source()	ChainTek	APC-1000W	N/A	N/A	N/A	Aug. 15, 2015	N/A	Conduction (CO05-HY)
LF Cable	HUBER + SUHNER	RG-214/U	LF01	N/A	Jan. 07, 2015	Aug. 15, 2015	Jan. 06, 2016	Conduction (CO05-HY)
Test Software	N/A	EMC32	8.40.0	N/A	N/A	Aug. 15, 2015	N/A	Conduction (CO05-HY)



5 Uncertainty of Evaluation

Uncertainty of Conducted Emission Measurement (150kHz ~ 30MHz)

Measuring Uncertainty for a Level of Confidence of 95% ($U = 2Uc(y)$)	2.26
---	------

Uncertainty of Radiated Emission Measurement (30 MHz ~ 1000 MHz)

Measuring Uncertainty for a Level of Confidence of 95% ($U = 2Uc(y)$)	4.80
---	------



Appendix A. Conducted Test Results

Test Engineer:	Stuart Lin	Temperature:	21~25	°C
Test Date:	2015/8/2	Relative Humidity:	51~54	%

TEST RESULTS DATA
6dB BANDWIDTH

FCC Band IV									
Mod.	Data Rate	NTX	CH.	Freq. (MHz)	6 dB Bandwidth (MHz)		FCC 6 dB Bandwidth Min. Limit (MHz)		Pass/Fail
					Ant 1	Ant 2	Ant 1	Ant 2	
11a	6Mbps	2	149	5745	16.36	16.34	0.5		Pass
11a	6Mbps	2	157	5785	16.34	16.36	0.5		Pass
11a	6Mbps	2	165	5825	16.36	16.36	0.5		Pass
HT20	MCS8	2	149	5745	17.60	17.62	0.5		Pass
HT20	MCS8	2	157	5785	17.58	17.58	0.5		Pass
HT20	MCS8	2	165	5825	17.56	17.56	0.5		Pass
HT40	MCS8	2	151	5755	36.32	36.32	0.5		Pass
HT40	MCS8	2	159	5795	36.32	36.32	0.5		Pass
VHT20	MCS0	2	149	5745	17.56	17.56	0.5		Pass
VHT20	MCS0	2	157	5785	17.56	17.56	0.5		Pass
VHT20	MCS0	2	165	5825	17.56	17.56	0.5		Pass
VHT40	MCS0	2	151	5755	36.32	36.32	0.5		Pass
VHT40	MCS0	2	159	5795	36.32	36.32	0.5		Pass
VHT80	MCS0	2	155	5775	76.00	76.32	0.5		Pass

TEST RESULTS DATA
Average Power Table

Band IV														
Mod.	Data Rate	NTX	CH.	Freq. (MHz)	Duty Factor (dB)		Average Conducted Power (dBm)			FCC Conducted Power Limit (dBm)		DG (dBi)		Pass/Fail
					Ant 1	Ant 2	Ant 1	Ant 2	SUM	Ant 1	Ant 2	Ant 1	Ant 2	
11a	6Mbps	1	149	5745	0.08	0.06	9.62	9.51		30.00	30.00	-4.10	-2.20	Pass
11a	6Mbps	1	157	5785	0.08	0.06	9.80	9.61		30.00	30.00	-4.10	-2.20	Pass
11a	6Mbps	1	165	5825	0.08	0.06	9.61	9.54		30.00	30.00	-4.10	-2.20	Pass
HT20	MCS0	1	149	5745	0.09	0.06	17.62	9.81		30.00	30.00	-4.10	-2.20	Pass
HT20	MCS0	1	157	5785	0.09	0.06	16.62	9.58		30.00	30.00	-4.10	-2.20	Pass
HT20	MCS0	1	165	5825	0.09	0.06	17.14	9.72		30.00	30.00	-4.10	-2.20	Pass
HT40	MCS0	1	151	5755	0.15	0.15	9.59	9.60		30.00	30.00	-4.10	-2.20	Pass
HT40	MCS0	1	159	5795	0.15	0.15	9.72	9.53		30.00	30.00	-4.10	-2.20	Pass
VHT20	MCS0	1	149	5745	0.09	0.06	9.80	9.54		30.00	30.00	-4.10	-2.20	Pass
VHT20	MCS0	1	157	5785	0.09	0.06	9.52	9.51		30.00	30.00	-4.10	-2.20	Pass
VHT20	MCS0	1	165	5825	0.09	0.06	9.75	9.58		30.00	30.00	-4.10	-2.20	Pass
VHT40	MCS0	1	151	5755	0.15	0.15	9.50	9.56		30.00	30.00	-4.10	-2.20	Pass
VHT40	MCS0	1	159	5795	0.15	0.15	9.59	9.67		30.00	30.00	-4.10	-2.20	Pass
VHT80	MCS0	1	155	5775	0.29	0.29	9.77	9.75		30.00	30.00	-4.10	-2.20	Pass
11a	6Mbps	2	149	5745	0.00	0.00	9.98	9.62	12.81	30.00			-0.09	Pass
11a	6Mbps	2	157	5785	0.00	0.00	9.83	9.80	12.83	30.00			-0.09	Pass
11a	6Mbps	2	165	5825	0.00	0.00	9.70	9.73	12.73	30.00			-0.09	Pass
HT20	MCS8	2	149	5745	0.06	0.06	10.00	9.70	12.86	30.00			-0.09	Pass
HT20	MCS8	2	157	5785	0.06	0.06	9.69	9.60	12.65	30.00			-0.09	Pass
HT20	MCS8	2	165	5825	0.06	0.06	9.97	9.70	12.85	30.00			-0.09	Pass
HT40	MCS8	2	151	5755	0.12	0.12	9.98	9.71	12.85	30.00			-0.09	Pass
HT40	MCS8	2	159	5795	0.12	0.12	9.88	9.57	12.73	30.00			-0.09	Pass
VHT20	MCS0	2	149	5745	0.06	0.06	9.98	9.67	12.84	30.00			-0.09	Pass
VHT20	MCS0	2	157	5785	0.06	0.06	9.68	9.77	12.73	30.00			-0.09	Pass
VHT20	MCS0	2	165	5825	0.06	0.06	9.88	9.73	12.81	30.00			-0.09	Pass
VHT40	MCS0	2	151	5755	0.12	0.12	9.68	9.34	12.84	30.00			-0.09	Pass
VHT40	MCS0	2	159	5795	0.12	0.12	9.40	9.37	12.71	30.00			-0.09	Pass
VHT80	MCS0	2	155	5775	0.23	0.23	9.56	9.28	12.86	30.00			-0.09	Pass

TEST RESULTS DATA
Power Spectral Density

FCC Band IV																
Mod.	Data Rate	NTX	CH.	Freq. (MHz)	Duty Factor (dB)		10log (500kHz /RBW) Factor (dB)		Average Power Density (dBm/500kHz)			Average PSD Limit (dBm/500kHz)		DG (dBi)		Pass /Fail
					Ant 1	Ant 2	Ant 1	Ant 2	Ant 1	Ant 2	SUM	Ant 1	Ant 2	Ant 1	Ant 2	
11a	6Mbps	2	149	5745	0.00	0.00	2.22				-1.25	30.00		-0.09	Pass	
11a	6Mbps	2	157	5785	0.00	0.00	2.22				-0.92	30.00		-0.09	Pass	
11a	6Mbps	2	165	5825	0.00	0.00	2.22				-1.16	30.00		-0.09	Pass	
HT20	MCS8	2	149	5745	0.06	0.06	2.22				-1.57	30.00		-0.09	Pass	
HT20	MCS8	2	157	5785	0.06	0.06	2.22				-1.24	30.00		-0.09	Pass	
HT20	MCS8	2	165	5825	0.06	0.06	2.22				-1.66	30.00		-0.09	Pass	
HT40	MCS8	2	151	5755	0.12	0.12	2.22				-4.05	30.00		-0.09	Pass	
HT40	MCS8	2	159	5795	0.12	0.12	2.22				-4.32	30.00		-0.09	Pass	
VHT20	MCS0	2	149	5745	0.06	0.06	2.22				-1.35	30.00		-0.09	Pass	
VHT20	MCS0	2	157	5785	0.06	0.06	2.22				-1.22	30.00		-0.09	Pass	
VHT20	MCS0	2	165	5825	0.06	0.06	2.22				-1.65	30.00		-0.09	Pass	
VHT40	MCS0	2	151	5755	0.12	0.12	2.22				-4.19	30.00		-0.09	Pass	
VHT40	MCS0	2	159	5795	0.12	0.12	2.22				-4.32	30.00		-0.09	Pass	
VHT80	MCS0	2	155	5775	0.23	0.23	2.22				-2.14	30.00		-0.09	Pass	

TEST RESULTS DATA
Frequency Stability

Band IV										
Mod.	Data Rate	NTX	CH.	Freq. (MHz)	Center Frequency (MHz)	Frequency Deviation (MHz)	Frequency Stability (ppm)	Temperature (°C)	Voltage (V)	Note
11a	6Mbps	1	149	5745	5744.950	-0.050	-8.70	20	3.6	
11a	6Mbps	1	149	5745	5744.950	-0.050	-8.70	20	4.2	
11a	6Mbps	1	149	5745	5745.025	0.025	4.35	20	3.8	
11a	6Mbps	1	149	5745	5745.000	0.000	0.00	-30	3.8	
11a	6Mbps	1	149	5745	5745.000	0.000	0.00	50	3.8	



Appendix B. Radiated Spurious Emission

Test Engineer :	Nick Yu and Jesse Wang	Temperature :	22~24°C
		Relative Humidity :	55~58%

15E Band 4 - 5725~5850MHz

WIFI 802.11a (Band Edge @ 3m)

WIFI	Note	Frequency	Level	Over	Limit	Read	Antenna	Cable	Preamp	Ant	Table	Peak	Pol.	
Ant.				Limit	Line	Level	Factor	Loss	Factor	Pos	Pos	Avg.		
1+2		(MHz)	(dBμV/m)	(dB)	(dBμV/m)	(dBμV)	(dB/m)	(dB)	(dB)	(cm)	(deg)	(P/A)	(H/V)	
802.11a CH 149 5745MHz		5709.16	50.24	-23.76	74	42.2	32.29	9.39	33.64	100	113	P	H	
		5722.92	51.92	-26.38	78.3	43.81	32.31	9.44	33.64	100	113	P	H	
		5715	38.56	-15.44	54	30.52	32.29	9.39	33.64	100	113	A	H	
	*	5745	101.07	-	-	92.94	32.34	9.44	33.65	100	113	P	H	
	*	5745	95.26	-	-	87.13	32.34	9.44	33.65	100	113	A	H	
														H
														H
														H
			5710	49.89	-24.11	74	41.85	32.29	9.39	33.64	328	101	P	V
			5724.52	55.16	-23.14	78.3	47.05	32.31	9.44	33.64	328	101	P	V
			5715	38.28	-15.72	54	30.24	32.29	9.39	33.64	328	101	A	V
	*		5745	100.31	-	-	92.18	32.34	9.44	33.65	328	101	P	V
	*		5745	95.01	-	-	86.88	32.34	9.44	33.65	328	101	A	V
														V
													V	
													V	



WIFI	Note	Frequency	Level	Over	Limit	Read	Antenna	Cable	Preamp	Ant	Table	Peak	Pol.
Ant.				Limit	Line	Level	Factor	Loss	Factor	Pos	Pos	Avg.	
1+2		(MHz)	(dBμV/m)	(dB)	(dBμV/m)	(dBμV)	(dB/m)	(dB)	(dB)	(cm)	(deg)	(P/A)	(H/V)
802.11a CH 157 5785MHz		5692.12	49.16	-24.84	74	41.13	32.27	9.39	33.63	100	114	P	H
		5720.84	48.61	-29.69	78.3	40.55	32.31	9.39	33.64	100	114	P	H
		5715	37.49	-16.51	54	29.45	32.29	9.39	33.64	100	114	A	H
	*	5785	100.92	-	-	92.7	32.39	9.49	33.66	100	114	P	H
	*	5785	95.98	-	-	87.76	32.39	9.49	33.66	100	114	A	H
		5856.72	49.1	-29.2	78.3	40.73	32.51	9.54	33.68	100	114	P	H
		5883.76	50.03	-23.97	74	41.63	32.53	9.57	33.7	100	114	P	H
		5862.64	37.97	-16.03	54	29.61	32.51	9.54	33.69	100	114	A	H
		5691.24	50.11	-23.89	74	42.08	32.27	9.39	33.63	377	99	P	V
		5724.52	48.35	-29.95	78.3	40.24	32.31	9.44	33.64	377	99	P	V
		5714.12	37.19	-16.81	54	29.15	32.29	9.39	33.64	377	99	A	V
	*	5785	100.75	-	-	92.53	32.39	9.49	33.66	377	99	P	V
	*	5785	95.88	-	-	87.66	32.39	9.49	33.66	377	99	A	V
		5858.24	48.82	-29.48	78.3	40.46	32.51	9.54	33.69	377	99	P	V
		5881.6	49.87	-24.13	74	41.46	32.53	9.57	33.69	377	99	P	V
		5863.2	37.62	-16.38	54	29.26	32.51	9.54	33.69	377	99	A	V



WIFI	Note	Frequency	Level	Over	Limit	Read	Antenna	Cable	Preamp	Ant	Table	Peak	Pol.	
Ant.				Limit	Line	Level	Factor	Loss	Factor	Pos	Pos	Avg.		
1+2		(MHz)	(dBμV/m)	(dB)	(dBμV/m)	(dBμV)	(dB/m)	(dB)	(dB)	(cm)	(deg)	(P/A)	(H/V)	
802.11a CH 165 5825MHz	*	5825	101.11	-	-	92.8	32.46	9.52	33.67	100	114	P	H	
	*	5825	95.63	-	-	87.32	32.46	9.52	33.67	100	114	A	H	
		5850.32	50.91	-27.39	78.3	42.57	32.48	9.54	33.68	100	114	P	H	
		5863.44	49.81	-24.19	74	41.45	32.51	9.54	33.69	100	114	P	H	
		5860	38.61	-15.39	54	30.25	32.51	9.54	33.69	100	114	A	H	
														H
														H
														H
	*	5825	100.24	-	-	91.93	32.46	9.52	33.67	393	107	P	V	
	*	5825	94.9	-	-	86.59	32.46	9.52	33.67	393	107	A	V	
		5856.16	49.71	-28.59	78.3	41.34	32.51	9.54	33.68	393	107	P	V	
		5889.92	50.01	-23.99	74	41.58	32.56	9.57	33.7	393	107	P	V	
		5860	38.39	-15.61	54	30.03	32.51	9.54	33.69	393	107	A	V	
														V
														V
														V
													V	
Remark	1. No other spurious found. 2. All results are PASS against Peak and Average limit line.													



15E Band 4 5725~5850MHz
WIFI 802.11a (Harmonic @ 3m)

WIFI	Note	Frequency	Level	Over	Limit	Read	Antenna	Cable	Preamp	Ant	Table	Peak	Pol.	
Ant.				Limit	Line	Level	Factor	Loss	Factor	Pos	Pos	Avg.		
1+2		(MHz)	(dBµV/m)	(dB)	(dBµV/m)	(dBµV)	(dB/m)	(dB)	(dB)	(cm)	(deg)	(P/A)	(H/V)	
802.11a CH 149 5745MHz		11490	45.45	-28.55	74	57.23	40.01	13.95	65.74	100	0	P	H	
		17235	45.15	-28.85	74	50.87	41.41	16.95	64.08	100	0	P	H	
													H	
													H	
		11490	45.01	-28.99	74	56.79	40.01	13.95	65.74	100	0	P	V	
		17235	45.26	-28.74	74	50.98	41.41	16.95	64.08	100	0	P	V	
														V
														V
802.11a CH 157 5785MHz		11570	44.76	-29.24	74	56.53	39.89	14	65.66	100	0	P	H	
		17355	45.39	-28.61	74	50.91	41.67	17.03	64.22	100	0	P	H	
													H	
													H	
		11570	44.29	-29.71	74	56.06	39.89	14	65.66	100	0	P	V	
		17355	45.45	-28.55	74	50.97	41.67	17.03	64.22	100	0	P	V	
														V
														V
802.11a CH 165 5825MHz		11650	44.43	-29.57	74	56.22	39.78	14.05	65.62	100	0	P	H	
		17472	44.03	-29.97	74	49.38	41.93	17.08	64.36	100	0	P	H	
													H	
													H	
		11650	44	-30	74	55.79	39.78	14.05	65.62	100	0	P	V	
		17472	44.51	-29.49	74	49.86	41.93	17.08	64.36	100	0	P	V	
														V
														V
Remark	1. No other spurious found. 2. All results are PASS against Peak and Average limit line.													



15E Band 4 5725~5850MHz
 WIFI 802.11n HT20 (Band Edge @ 3m)

WIFI	Note	Frequency	Level	Over	Limit	Read	Antenna	Cable	Preamp	Ant	Table	Peak	Pol.	
Ant.				Limit	Line	Level	Factor	Loss	Factor	Pos	Pos	Avg.		
1+2		(MHz)	(dBμV/m)	(dB)	(dBμV/m)	(dBμV)	(dB/m)	(dB)	(dB)	(cm)	(deg)	(P/A)	(H/V)	
802.11n HT20 CH 149 5745MHz		5713.24	49.73	-24.27	74	41.69	32.29	9.39	33.64	100	116	P	H	
		5723.56	52.1	-26.2	78.3	43.99	32.31	9.44	33.64	100	116	P	H	
		5714.44	38.33	-15.67	54	30.29	32.29	9.39	33.64	100	116	A	H	
	*	5745	99.54	-	-	91.41	32.34	9.44	33.65	100	116	P	H	
	*	5745	93.34	-	-	85.21	32.34	9.44	33.65	100	116	A	H	
														H
														H
														H
			5703	49.83	-24.17	74	41.78	32.29	9.39	33.63	370	102	P	V
			5723.88	53.62	-24.68	78.3	45.51	32.31	9.44	33.64	370	102	P	V
			5715	39.11	-14.89	54	31.07	32.29	9.39	33.64	370	102	A	V
	*		5745	99.53	-	-	91.4	32.34	9.44	33.65	370	102	P	V
	*		5745	93.21	-	-	85.08	32.34	9.44	33.65	370	102	A	V
														V
													V	
													V	



WIFI	Note	Frequency	Level	Over	Limit	Read	Antenna	Cable	Preamp	Ant	Table	Peak	Pol.
Ant.				Limit	Line	Level	Factor	Loss	Factor	Pos	Pos	Avg.	
1+2		(MHz)	(dBμV/m)	(dB)	(dBμV/m)	(dBμV)	(dB/m)	(dB)	(dB)	(cm)	(deg)	(P/A)	(H/V)
802.11n HT20 CH 157 5785MHz		5685.24	49.02	-24.98	74	40.99	32.27	9.39	33.63	100	116	P	H
		5717.56	48.74	-29.56	78.3	40.68	32.31	9.39	33.64	100	116	P	H
		5714.28	37.48	-16.52	54	29.44	32.29	9.39	33.64	100	116	A	H
	*	5785	99.56	-	-	91.34	32.39	9.49	33.66	100	116	P	H
	*	5785	93.37	-	-	85.15	32.39	9.49	33.66	100	116	A	H
		5859	49.44	-28.86	78.3	41.08	32.51	9.54	33.69	100	116	P	H
		5885.52	49.4	-24.6	74	41	32.53	9.57	33.7	100	116	P	H
		5861.04	37.88	-16.12	54	29.52	32.51	9.54	33.69	100	116	A	H
		5707.08	49.11	-24.89	74	41.07	32.29	9.39	33.64	382	107	P	V
		5720.04	49.97	-28.33	78.3	41.91	32.31	9.39	33.64	382	107	P	V
		5714.92	37.2	-16.8	54	29.16	32.29	9.39	33.64	382	107	A	V
	*	5785	98.85	-	-	90.63	32.39	9.49	33.66	382	107	P	V
	*	5785	93.51	-	-	85.29	32.39	9.49	33.66	382	107	A	V
		5853.68	50.17	-28.13	78.3	41.8	32.51	9.54	33.68	382	107	P	V
		5863.92	49.18	-24.82	74	40.82	32.51	9.54	33.69	382	107	P	V
	5865.52	37.63	-16.37	54	29.27	32.51	9.54	33.69	382	107	A	V	



WIFI	Note	Frequency	Level	Over	Limit	Read	Antenna	Cable	Preamp	Ant	Table	Peak	Pol.	
Ant.				Limit	Line	Level	Factor	Loss	Factor	Pos	Pos	Avg.		
1+2		(MHz)	(dBμV/m)	(dB)	(dBμV/m)	(dBμV)	(dB/m)	(dB)	(dB)	(cm)	(deg)	(P/A)	(H/V)	
802.11n HT20 CH 165 5825MHz	*	5825	98.64	-	-	90.33	32.46	9.52	33.67	100	115	P	H	
	*	5825	93.99	-	-	85.68	32.46	9.52	33.67	100	115	A	H	
		5852.08	49.6	-28.7	78.3	41.26	32.48	9.54	33.68	100	115	P	H	
		5876	50.38	-23.62	74	42	32.53	9.54	33.69	100	115	P	H	
		5860	38.71	-15.29	54	30.35	32.51	9.54	33.69	100	115	A	H	
														H
														H
														H
	*	5825	99.19	-	-	90.88	32.46	9.52	33.67	342	92	P	V	
	*	5825	93.06	-	-	84.75	32.46	9.52	33.67	342	92	A	V	
		5850.16	50.67	-27.63	78.3	42.33	32.48	9.54	33.68	342	92	P	V	
		5861.36	50.61	-23.39	74	42.25	32.51	9.54	33.69	342	92	P	V	
		5860	38.56	-15.44	54	30.2	32.51	9.54	33.69	342	92	A	V	
														V
													V	
													V	
Remark	1. No other spurious found. 2. All results are PASS against Peak and Average limit line.													



15E Band 4 5725~5850MHz

WIFI 802.11n HT20 (Harmonic @ 3m)

WIFI	Note	Frequency	Level	Over	Limit	Read	Antenna	Cable	Preamp	Ant	Table	Peak	Pol.
Ant.				Limit	Line	Level	Factor	Loss	Factor	Pos	Pos	Avg.	
1+2		(MHz)	(dBµV/m)	(dB)	(dBµV/m)	(dBµV)	(dB/m)	(dB)	(dB)	(cm)	(deg)	(P/A)	(H/V)
802.11n HT20 CH 149 5745MHz		11490	44.76	-29.24	74	56.54	40.01	13.95	65.74	100	0	P	H
		17232	43.79	-30.21	74	49.53	41.41	16.93	64.08	100	0	P	H
													H
													H
		11490	44.77	-29.23	74	56.55	40.01	13.95	65.74	100	0	P	V
		17232	44.58	-29.42	74	50.32	41.41	16.93	64.08	100	0	P	V
													V
802.11n HT20 CH 157 5785MHz		11570	45.26	-28.74	74	57.03	39.89	14	65.66	100	0	P	H
		17352	45.53	-28.47	74	51.08	41.67	17	64.22	100	0	P	H
													H
													H
		11570	44.51	-29.49	74	56.28	39.89	14	65.66	100	0	P	V
		17352	45.25	-28.75	74	50.8	41.67	17	64.22	100	0	P	V
													V
802.11n HT20 CH 165 5825MHz		11650	44.76	-29.24	74	56.55	39.78	14.05	65.62	100	0	P	H
		17472	43.9	-30.1	74	49.25	41.93	17.08	64.36	100	0	P	H
													H
													H
		11650	44.04	-29.96	74	55.83	39.78	14.05	65.62	100	0	P	V
		17472	43.9	-30.1	74	49.25	41.93	17.08	64.36	100	0	P	V
													V
Remark	1. No other spurious found.												
	2. All results are PASS against Peak and Average limit line.												



**15E Band 4 5725~5850MHz
WIFI 802.11n HT40 (Band Edge @ 3m)**

WIFI	Note	Frequency	Level	Over	Limit	Read	Antenna	Cable	Preamp	Ant	Table	Peak	Pol.
Ant.				Limit	Line	Level	Factor	Loss	Factor	Pos	Pos	Avg.	
1+2		(MHz)	(dBμV/m)	(dB)	(dBμV/m)	(dBμV)	(dB/m)	(dB)	(dB)	(cm)	(deg)	(P/A)	(H/V)
802.11n HT40 CH 151 5755MHz		5714.52	53.89	-20.11	74	45.85	32.29	9.39	33.64	100	116	P	H
		5722.2	55.7	-22.6	78.3	47.59	32.31	9.44	33.64	100	116	P	H
		5714.92	45.26	-8.74	54	37.22	32.29	9.39	33.64	100	116	A	H
	*	5755	95.93	-	-	87.78	32.36	9.44	33.65	100	116	P	H
	*	5755	89.81	-	-	81.66	32.36	9.44	33.65	100	116	A	H
		5850.16	49.14	-29.16	78.3	40.8	32.48	9.54	33.68	100	116	P	H
		5860.72	48.68	-25.32	74	40.32	32.51	9.54	33.69	100	116	P	H
		5884.88	41.28	-12.72	54	32.88	32.53	9.57	33.7	100	116	A	H
		5710.92	54.44	-19.56	74	46.4	32.29	9.39	33.64	387	103	P	V
		5720.6	55.48	-22.82	78.3	47.42	32.31	9.39	33.64	387	103	P	V
		5714.6	45.94	-8.06	54	37.9	32.29	9.39	33.64	387	103	A	V
	*	5755	96.52	-	-	88.37	32.36	9.44	33.65	387	103	P	V
	*	5755	89.91	-	-	81.76	32.36	9.44	33.65	387	103	A	V
		5852.8	49.5	-28.8	78.3	41.16	32.48	9.54	33.68	387	103	P	V
		5885.12	49.76	-24.24	74	41.36	32.53	9.57	33.7	387	103	P	V
	5864.32	41.32	-12.68	54	32.96	32.51	9.54	33.69	387	103	A	V	



WIFI	Note	Frequency	Level	Over	Limit	Read	Antenna	Cable	Preamp	Ant	Table	Peak	Pol.
Ant.				Limit	Line	Level	Factor	Loss	Factor	Pos	Pos	Avg.	
1+2		(MHz)	(dBμV/m)	(dB)	(dBμV/m)	(dBμV)	(dB/m)	(dB)	(dB)	(cm)	(deg)	(P/A)	(H/V)
802.11n HT40 CH 159 5795MHz		5703.08	49.48	-24.52	74	41.43	32.29	9.39	33.63	100	115	P	H
		5717.48	49.72	-28.58	78.3	41.68	32.29	9.39	33.64	100	115	P	H
		5708.04	40.83	-13.17	54	32.79	32.29	9.39	33.64	100	115	A	H
	*	5795	96.18	-	-	87.94	32.41	9.49	33.66	100	115	P	H
	*	5795	88.69	-	-	80.45	32.41	9.49	33.66	100	115	A	H
		5853.12	50.48	-27.82	78.3	42.14	32.48	9.54	33.68	100	115	P	H
		5864.64	49.9	-24.1	74	41.54	32.51	9.54	33.69	100	115	P	H
		5882	41.72	-12.28	54	33.31	32.53	9.57	33.69	100	115	A	H
		5689.56	49.11	-24.89	74	41.08	32.27	9.39	33.63	360	95	P	V
		5718.36	50.66	-27.64	78.3	42.6	32.31	9.39	33.64	360	95	P	V
		5713	41.27	-12.73	54	33.23	32.29	9.39	33.64	360	95	A	V
	*	5795	96.78	-	-	88.54	32.41	9.49	33.66	360	95	P	V
	*	5795	89.8	-	-	81.56	32.41	9.49	33.66	360	95	A	V
		5851.6	51.84	-26.46	78.3	43.5	32.48	9.54	33.68	360	95	P	V
		5876.96	49.14	-24.86	74	40.76	32.53	9.54	33.69	360	95	P	V
	5860.48	42.16	-11.84	54	33.8	32.51	9.54	33.69	360	95	A	V	
Remark	1. No other spurious found. 2. All results are PASS against Peak and Average limit line.												



15E Band 4 5725~5850MHz

WIFI 802.11n HT40 (Harmonic @ 3m)

WIFI	Note	Frequency	Level	Over	Limit	Read	Antenna	Cable	Preamp	Ant	Table	Peak	Pol.
Ant.				Limit	Line	Level	Factor	Loss	Factor	Pos	Pos	Avg.	
1+2		(MHz)	(dBμV/m)	(dB)	(dBμV/m)	(dBμV)	(dB/m)	(dB)	(dB)	(cm)	(deg)	(P/A)	(H/V)
802.11n HT40 CH 151 5755MHz		11510	45.71	-28.29	74	57.46	40	13.95	65.7	100	0	P	H
		17265	43.93	-30.07	74	49.61	41.49	16.95	64.12	100	0	P	H
													H
													H
		11510	43.86	-30.14	74	55.61	40	13.95	65.7	100	0	P	V
		17265	43.65	-30.35	74	49.33	41.49	16.95	64.12	100	0	P	V
													V
802.11n HT40 CH 159 5795MHz		11590	46	-28	74	57.79	39.86	14	65.65	100	0	P	H
		17388	44.44	-29.56	74	49.93	41.74	17.03	64.26	100	0	P	H
													H
													H
		11590	44.94	-29.06	74	56.73	39.86	14	65.65	100	0	P	V
		17388	44.32	-29.68	74	49.81	41.74	17.03	64.26	100	0	P	V
													V
Remark	1. No other spurious found.												
	2. All results are PASS against Peak and Average limit line.												



15E Band 4 5725~5850MHz
WIFI 802.11ac VHT80 (Band Edge @ 3m)

WIFI	Note	Frequency	Level	Over	Limit	Read	Antenna	Cable	Preamp	Ant	Table	Peak	Pol.
Ant.				Limit	Line	Level	Factor	Loss	Factor	Pos	Pos	Avg.	
1+2		(MHz)	(dBμV/m)	(dB)	(dBμV/m)	(dBμV)	(dB/m)	(dB)	(dB)	(cm)	(deg)	(P/A)	(H/V)
802.11ac VHT80 CH 155 5775MHz		5711.56	53.96	-20.04	74	45.92	32.29	9.39	33.64	100	115	P	H
		5722.92	53.75	-24.55	78.3	45.64	32.31	9.44	33.64	100	115	P	H
		5713.08	44.74	-9.26	54	36.7	32.29	9.39	33.64	100	115	A	H
	*	5775	93.27	-	-	85.04	32.39	9.49	33.65	100	115	P	H
	*	5775	85.69	-	-	77.46	32.39	9.49	33.65	100	115	A	H
		5852.64	51.9	-26.4	78.3	43.56	32.48	9.54	33.68	100	115	P	H
		5864.88	53.07	-20.93	74	44.71	32.51	9.54	33.69	100	115	P	H
		5872.64	44.53	-9.47	54	36.15	32.53	9.54	33.69	100	115	A	H
		5714.28	54.32	-19.68	74	46.28	32.29	9.39	33.64	386	96	P	V
		5718.76	55.56	-22.74	78.3	47.5	32.31	9.39	33.64	386	96	P	V
		5714.6	46.42	-7.58	54	38.38	32.29	9.39	33.64	386	96	A	V
	*	5775	93.73	-	-	85.5	32.39	9.49	33.65	386	96	P	V
	*	5775	86.54	-	-	78.31	32.39	9.49	33.65	386	96	A	V
		5858.72	52.35	-25.95	78.3	43.99	32.51	9.54	33.69	386	96	P	V
		5860.4	50.88	-23.12	74	42.52	32.51	9.54	33.69	386	96	P	V
	5869.04	43.7	-10.3	54	35.34	32.51	9.54	33.69	386	96	A	V	
Remark	1. No other spurious found. 2. All results are PASS against Peak and Average limit line.												



15E Band 4 5725~5850MHz

WIFI 802.11ac VHT80 (Harmonic @ 3m)

WIFI	Note	Frequency	Level	Over	Limit	Read	Antenna	Cable	Preamp	Ant	Table	Peak	Pol.	
Ant.				Limit	Line	Level	Factor	Loss	Factor	Pos	Pos	Avg.		
1+2		(MHz)	(dBμV/m)	(dB)	(dBμV/m)	(dBμV)	(dB/m)	(dB)	(dB)	(cm)	(deg)	(P/A)	(H/V)	
802.11ac VHT80 CH 155 5775MHz		11550	44.58	-29.42	74	56.36	39.92	13.97	65.67	100	0	P	H	
		17328	43.84	-30.16	74	49.42	41.6	17	64.18	100	0	P	H	
													H	
													H	
			11550	43.85	-30.15	74	55.63	39.92	13.97	65.67	100	0	P	V
			17328	44.13	-29.87	74	49.71	41.6	17	64.18	100	0	P	V
													V	
													V	
Remark	1. No other spurious found. 2. All results are PASS against Peak and Average limit line.													



15E Emission below 1GHz

5GHz WIFI 802.11a (LF @ 3m)

WIFI	Note	Frequency	Level	Over	Limit	Read	Antenna	Cable	Preamp	Ant	Table	Peak	Pol.	
Ant.				Limit	Line	Level	Factor	Loss	Factor	Pos	Pos	Avg.		
1+2		(MHz)	(dBμV/m)	(dB)	(dBμV/m)	(dBμV)	(dB/m)	(dB)	(dB)	(cm)	(deg)	(P/A)	(H/V)	
5GHz 802.11a LF		100.47	23.96	-19.54	43.5	44.28	10.18	1.28	31.78	-	-	P	H	
		116.67	26.78	-16.72	43.5	45.95	11.33	1.28	31.78	100	139	P	H	
		118.02	25.4	-18.1	43.5	44.54	11.36	1.28	31.78	-	-	P	H	
		818.7	22.5	-23.5	46	30.86	20.07	3.4	31.83	-	-	P	H	
		850.2	23.06	-22.94	46	31.09	20.2	3.44	31.67	-	-	P	H	
		931.4	22.93	-23.07	46	30.2	20.24	3.68	31.19	-	-	P	H	
														H
														H
														H
														H
														H
														H
														H
			56.73	21.82	-18.18	40	46.83	5.75	1.04	31.8	127	94	P	V
			79.14	18.52	-21.48	40	42.8	6.47	1.04	31.79	-	-	P	V
			97.5	18.93	-24.57	43.5	39.7	9.73	1.28	31.78	-	-	P	V
			640.2	20.32	-25.68	46	30.3	19.1	2.96	32.04	-	-	P	V
			720.7	20.84	-25.16	46	30.19	19.52	3.14	32.01	-	-	P	V
			894.3	22.32	-23.68	46	30.13	20.1	3.55	31.46	-	-	P	V
														V
													V	
													V	
													V	
													V	
													V	
Remark	1. No other spurious found. 2. All results are PASS against limit line.													



15E Emission below 1GHz
5GHz WIFI 802.11n HT20 (LF @ 3m)

WIFI	Note	Frequency	Level	Over	Limit	Read	Antenna	Cable	Preamp	Ant	Table	Peak	Pol.	
Ant.				Limit	Line	Level	Factor	Loss	Factor	Pos	Pos	Avg.		
1+2		(MHz)	(dBμV/m)	(dB)	(dBμV/m)	(dBμV)	(dB/m)	(dB)	(dB)	(cm)	(deg)	(P/A)	(H/V)	
5GHz 802.11n HT20 LF		57.27	15.99	-24.01	40	41.1	5.65	1.04	31.8	-	-	P	H	
		101.55	15.16	-28.34	43.5	35.31	10.35	1.28	31.78	-	-	P	H	
		154.74	13.93	-29.57	43.5	34.44	9.81	1.46	31.78	-	-	P	H	
		304.9	17.07	-28.93	46	33.52	13.2	2.11	31.76	-	-	P	H	
		806.8	22.94	-23.06	46	31.59	19.84	3.4	31.89	100	149	P	H	
		967.8	23.03	-30.97	54	29.66	20.48	3.78	30.89	-	-	P	H	
														H
														H
														H
														H
														H
														H
														H
														H
														H
			53.22	19.95	-20.05	40	44.14	6.57	1.04	31.8	-	-	P	V
			58.89	20.69	-19.31	40	46.08	5.37	1.04	31.8	125	101	P	V
			119.91	17.26	-26.24	43.5	36.36	11.4	1.28	31.78	-	-	P	V
			551.3	19.46	-26.54	46	29.99	18.67	2.77	31.97	-	-	P	V
			866.3	22.48	-23.52	46	30.54	20.1	3.44	31.6	-	-	P	V
		945.4	22.54	-23.46	46	29.38	20.55	3.68	31.07	-	-	P	V	
													V	
													V	
													V	
													V	
													V	
													V	
Remark	1. No other spurious found. 2. All results are PASS against limit line.													



15E Emission below 1GHz
5GHz WIFI 802.11n HT40 (LF @ 3m)

WIFI	Note	Frequency	Level	Over	Limit	Read	Antenna	Cable	Preamp	Ant	Table	Peak	Pol.	
Ant.				Limit	Line	Level	Factor	Loss	Factor	Pos	Pos	Avg.		
1+2		(MHz)	(dBμV/m)	(dB)	(dBμV/m)	(dBμV)	(dB/m)	(dB)	(dB)	(cm)	(deg)	(P/A)	(H/V)	
5GHz 802.11n HT40 LF		31.08	16.56	-23.44	40	30.26	17.46	0.67	31.83	-	-	P	H	
		101.55	15.37	-28.13	43.5	35.52	10.35	1.28	31.78	-	-	P	H	
		173.91	13.42	-30.08	43.5	34.99	8.57	1.64	31.78	-	-	P	H	
		654.9	21.35	-24.65	46	31.32	19.05	3.02	32.04	-	-	P	H	
		828.5	24.41	-21.59	46	32.69	20.1	3.4	31.78	100	124	P	H	
		920.9	22.86	-23.14	46	30.37	20.2	3.55	31.26	-	-	P	H	
														H
														H
														H
														H
														H
														H
														H
														H
			60.78	24.27	-15.73	40	49.91	5.12	1.04	31.8	127	84	P	V
			73.2	18.87	-21.13	40	44.1	5.52	1.04	31.79	-	-	P	V
			104.52	17.62	-25.88	43.5	37.3	10.82	1.28	31.78	-	-	P	V
			431.6	18.53	-27.47	46	31.48	16.47	2.41	31.83	-	-	P	V
			552.7	20.95	-25.05	46	31.5	18.65	2.77	31.97	-	-	P	V
			955.9	22.9	-23.1	46	29.73	20.48	3.68	30.99	-	-	P	V
													V	
													V	
													V	
													V	
													V	
													V	
Remark	1. No other spurious found. 2. All results are PASS against limit line.													



15E Emission below 1GHz

5GHz WIFI 11ac VHT80 (LF @ 3m)

WIFI	Note	Frequency	Level	Over	Limit	Read	Antenna	Cable	Preamp	Ant	Table	Peak	Pol.	
Ant.				Limit	Line	Level	Factor	Loss	Factor	Pos	Pos	Avg.		
1+2		(MHz)	(dBμV/m)	(dB)	(dBμV/m)	(dBμV)	(dB/m)	(dB)	(dB)	(cm)	(deg)	(P/A)	(H/V)	
5GHz 802.11ac VHT80 LF		101.82	14.77	-28.73	43.5	34.88	10.39	1.28	31.78	-	-	P	H	
		152.58	11.74	-31.76	43.5	32.16	9.9	1.46	31.78	-	-	P	H	
		203.34	12.12	-31.38	43.5	33.79	8.47	1.64	31.78	-	-	P	H	
		556.2	19.65	-26.35	46	30.27	18.58	2.77	31.97	-	-	P	H	
		846.7	22.33	-23.67	46	30.38	20.2	3.44	31.69	-	-	P	H	
		957.3	23.06	-22.94	46	29.91	20.45	3.68	30.98	100	127	P	H	
														H
														H
														H
														H
														H
														H
														H
														H
														H
														H
														H
														H
			44.04	23.06	-16.94	40	43.82	10.38	0.67	31.81	-	-	P	V
			69.69	21.09	-18.91	40	46.67	5.17	1.04	31.79	-	-	P	V
		89.13	31.33	-12.17	43.5	53.46	8.37	1.28	31.78	121	68	P	V	
		543.6	20.17	-25.83	46	30.79	18.57	2.77	31.96	-	-	P	V	
		761.3	22.01	-23.99	46	31.03	19.7	3.25	31.97	-	-	P	V	
		909	22.46	-23.54	46	30.17	20.1	3.55	31.36	-	-	P	V	
													V	
													V	
													V	
													V	
													V	
													V	
													V	
													V	
Remark	1. No other spurious found. 2. All results are PASS against limit line.													



Note symbol

*	Fundamental Frequency which can be ignored. However, the level of any unwanted emissions shall not exceed the level of the fundamental frequency per 15.209(c).
!	Test result is over limit line.
P/A	Peak or Average
H/V	Horizontal or Vertical



A calculation example for radiated spurious emission is shown as below:

WIFI	Note	Frequency	Level	Over	Limit	Read	Antenna	Cable	Preamp	Ant	Table	Peak	Pol.
Ant.				Limit	Line	Level	Factor	Loss	Factor	Pos	Pos	Avg.	
1+2		(MHz)	(dBμV/m)	(dB)	(dBμV/m)	(dBμV)	(dB/m)	(dB)	(dB)	(cm)	(deg)	(P/A)	(H/V)
802.11b		2390	55.45	-18.55	74	54.51	32.22	4.58	35.86	103	308	P	H
CH 01													
2412MHz		2390	43.54	-10.46	54	42.6	32.22	4.58	35.86	103	308	A	H

- Level(dBμV/m) =
Antenna Factor(dB/m) + Cable Loss(dB) + Read Level(dBμV) - Preamp Factor(dB)
- Over Limit(dB) = Level(dBμV/m) – Limit Line(dBμV/m)

For Peak Limit @ 2390MHz:

- Level(dBμV/m)
= Antenna Factor(dB/m) + Cable Loss(dB) + Read Level(dBμV) - Preamp Factor(dB)
= 32.22(dB/m) + 4.58(dB) + 54.51(dBμV) – 35.86 (dB)
= 55.45 (dBμV/m)
- Over Limit(dB)
= Level(dBμV/m) – Limit Line(dBμV/m)
= 55.45(dBμV/m) – 74(dBμV/m)
= -18.55(dB)

For Average Limit @ 2390MHz:

- Level(dBμV/m)
= Antenna Factor(dB/m) + Cable Loss(dB) + Read Level(dBμV) - Preamp Factor(dB)
= 32.22(dB/m) + 4.58(dB) + 42.6(dBμV) – 35.86 (dB)
= 43.54 (dBμV/m)
- Over Limit(dB)
= Level(dBμV/m) – Limit Line(dBμV/m)
= 43.54(dBμV/m) – 54(dBμV/m)
= -10.46(dB)

Both peak and average measured complies with the limit line, so test result is “PASS”.



Appendix C. Radiated Spurious Emission Plots

Test Engineer :	Nick Yu and Jesse Wang	Temperature :	22~24°C
		Relative Humidity :	55~58%

Band 4 - 5725~5850MHz

WIFI 802.11a (Band Edge @ 3m)

WIFI	Band 4 5725~5850MHz Band Edge @ 3m	
ANT	802.11a CH149 5745MHz	
1+2	Horizontal	Vertical
Peak	<p>Site : 03CH11-HY Condition : FCC CLASS-B_BAND 4 3m HORN 9120D-HF HORIZONTAL RBW:1000.000KHz VBW:3000.000KHz SWT:Auto Detector : Peak</p>	<p>Site : 03CH11-HY Condition : FCC CLASS-B_BAND 4 3m HORN 9120D-HF VERTICAL RBW:1000.000KHz VBW:3000.000KHz SWT:Auto Detector : Peak</p>
Avg.	<p>Site : 03CH11-HY Condition : FCC CLASS-B (AVG) 3m HORN 9120D-HF HORIZONTAL RBW:1000.000KHz VBW:0.010KHz SWT:Auto Detector : Peak</p>	<p>Site : 03CH11-HY Condition : FCC CLASS-B (AVG) 3m HORN 9120D-HF VERTICAL RBW:1000.000KHz VBW:0.010KHz SWT:Auto Detector : Peak</p>

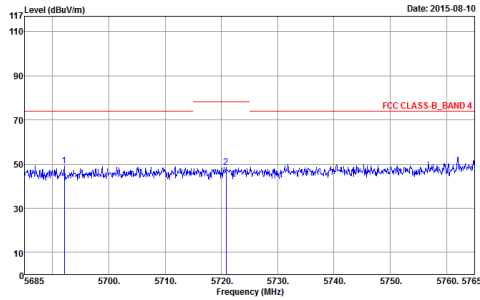
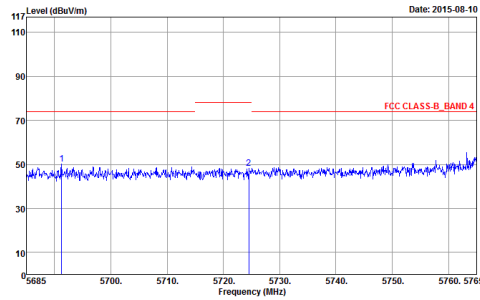
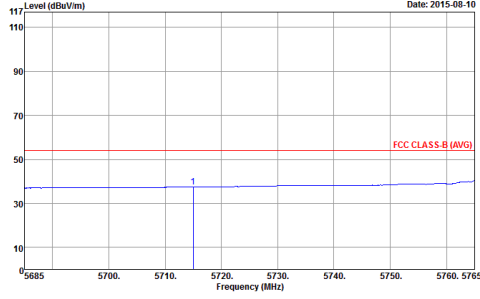
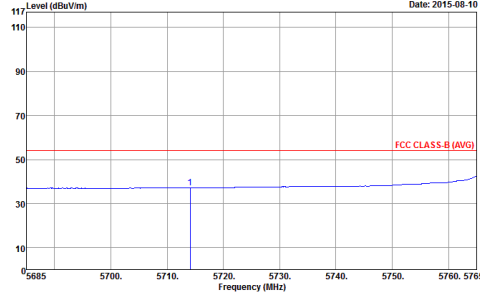

WIFI	Band 4 5725~5850MHz Band Edge @ 3m	
ANT	802.11a CH157 5785MHz – Low Channel Location	
1+2	Horizontal	Vertical
<p>Peak</p>	 <p>Site : 03CH11-HY Condition : FCC CLASS-B_BAND 4 3m HORN 9120D-HF HORIZONTAL Detector : Peak</p>	 <p>Site : 03CH11-HY Condition : FCC CLASS-B_BAND 4 3m HORN 9120D-HF VERTICAL Detector : Peak</p>
<p>Avg.</p>	 <p>Site : 03CH11-HY Condition : FCC CLASS-B (AVG) 3m HORN 9120D-HF HORIZONTAL Detector : Peak</p>	 <p>Site : 03CH11-HY Condition : FCC CLASS-B (AVG) 3m HORN 9120D-HF VERTICAL Detector : Peak</p>

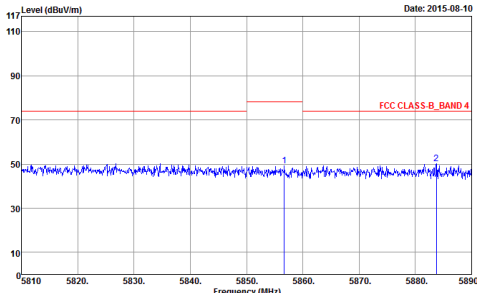
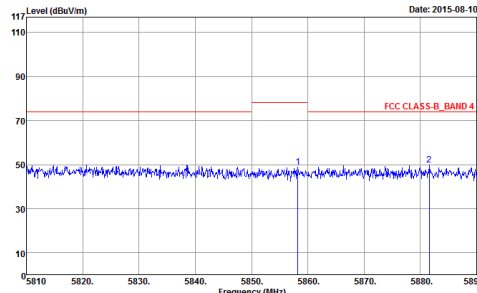
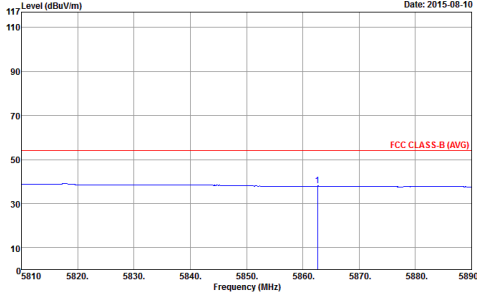
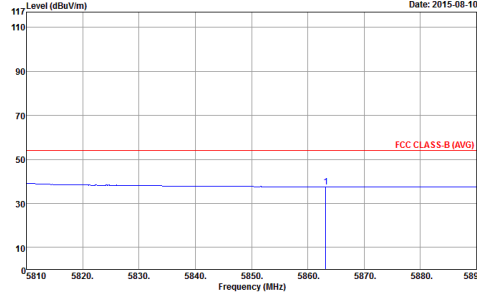

WIFI	Band 4 5725~5850MHz Band Edge @ 3m	
ANT	802.11a CH157 5785MHz – High Channel Location	
1+2	Horizontal	Vertical
<p>Peak</p>	 <p>Site : 03CH11-HY Condition : FCC CLASS-B_BAND 4 3m HORN 9120D-HF HORIZONTAL Detector : Peak</p>	 <p>Site : 03CH11-HY Condition : FCC CLASS-B_BAND 4 3m HORN 9120D-HF VERTICAL Detector : Peak</p>
<p>Avg.</p>	 <p>Site : 03CH11-HY Condition : FCC CLASS-B (AVG) 3m HORN 9120D-HF HORIZONTAL Detector : Peak</p>	 <p>Site : 03CH11-HY Condition : FCC CLASS-B (AVG) 3m HORN 9120D-HF VERTICAL Detector : Peak</p>

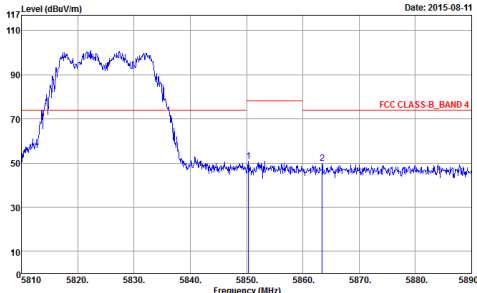
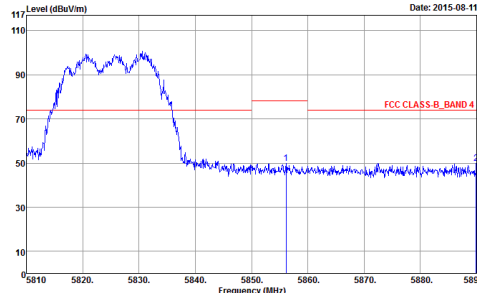
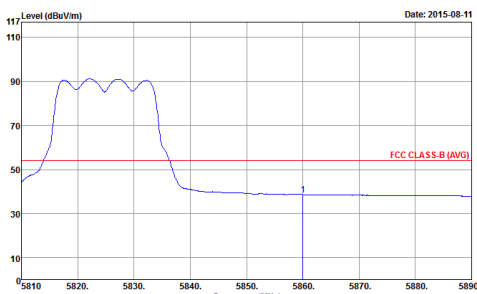
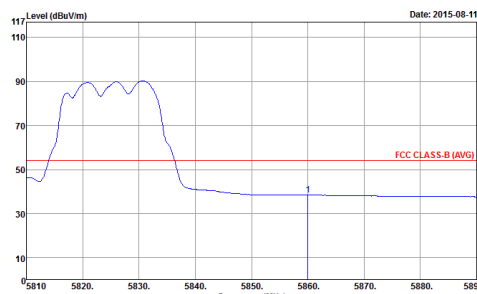

WIFI	Band 4 5725~5850MHz Band Edge @ 3m	
ANT	802.11a CH165 5825MHz	
1+2	Horizontal	Vertical
Peak	 <p>Site : 03CH11-HY Condition : FCC CLASS-B_BAND 4 3m HORN 9120D-HF HORIZONTAL Detector : Peak</p>	 <p>Site : 03CH11-HY Condition : FCC CLASS-B_BAND 4 3m HORN 9120D-HF VERTICAL Detector : Peak</p>
Avg.	 <p>Site : 03CH11-HY Condition : FCC CLASS-B (AVG) 3m HORN 9120D-HF HORIZONTAL Detector : Peak</p>	 <p>Site : 03CH11-HY Condition : FCC CLASS-B (AVG) 3m HORN 9120D-HF VERTICAL Detector : Peak</p>

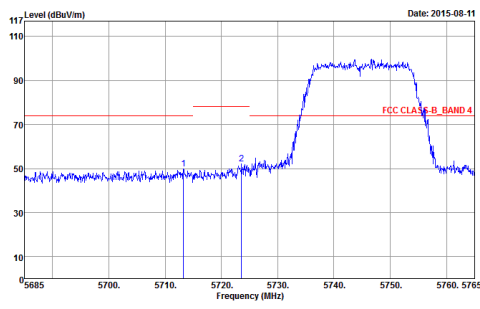
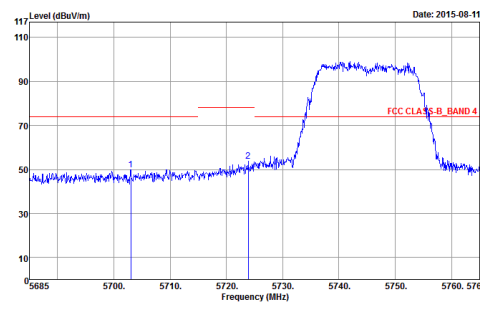
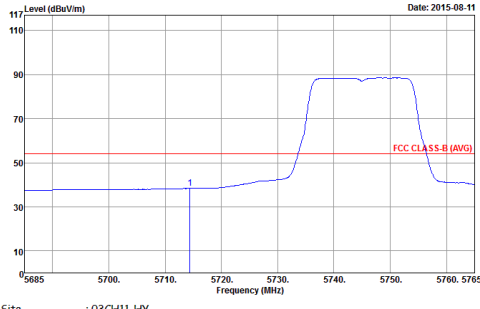
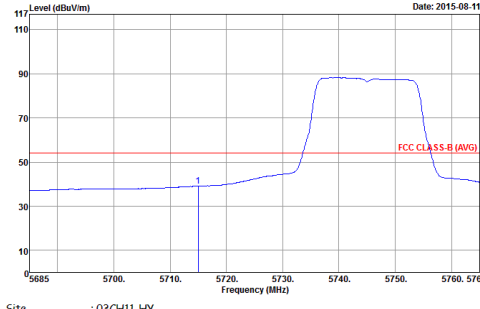

Band 4 5725~5850MHz
WIFI 802.11n HT20 (Band Edge @ 3m)

WIFI	Band 4 5725~5850MHz Band Edge @ 3m	
ANT	802.11n HT20 CH149 5745MHz	
1+2	Horizontal	Vertical
Peak	 <p>Site : 03CH11-HY Condition : FCC CLASS-B_BAND 4 3m HORN 9120D-HF HORIZONTAL RBW:1000.000KHz VBW:3000.000KHz SWT:Auto Detector : Peak</p>	 <p>Site : 03CH11-HY Condition : FCC CLASS-B_BAND 4 3m HORN 9120D-HF VERTICAL RBW:1000.000KHz VBW:3000.000KHz SWT:Auto Detector : Peak</p>
Avg.	 <p>Site : 03CH11-HY Condition : FCC CLASS-B (AVG) 3m HORN 9120D-HF HORIZONTAL RBW:1000.000KHz VBW:0.010KHz SWT:Auto Detector : Peak</p>	 <p>Site : 03CH11-HY Condition : FCC CLASS-B (AVG) 3m HORN 9120D-HF VERTICAL RBW:1000.000KHz VBW:0.010KHz SWT:Auto Detector : Peak</p>

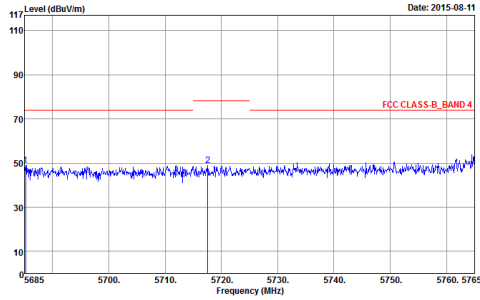
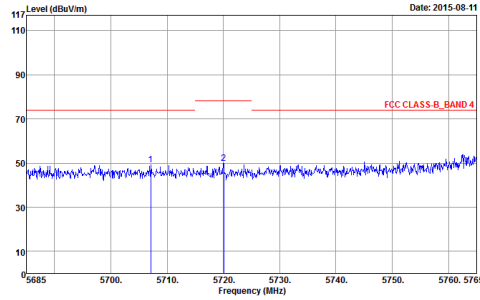
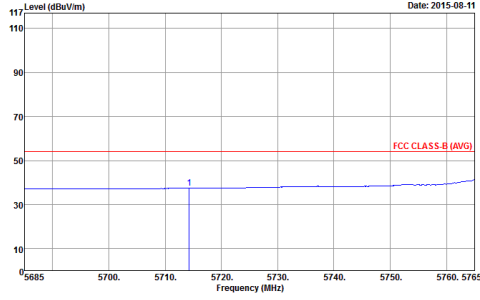
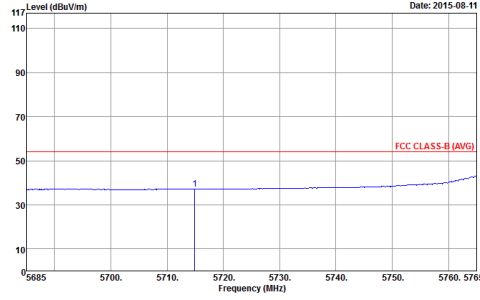

WIFI	Band 4 5725~5850MHz Band Edge @ 3m	
ANT	802.11n HT20 CH157 5785MHz – Low Channel Location	
1+2	Horizontal	Vertical
Peak	 <p>Site : 03CH11-HY Condition : FCC CLASS-B_BAND 4 3m HORN 9120D-HF HORIZONTAL Detector : Peak</p>	 <p>Site : 03CH11-HY Condition : FCC CLASS-B_BAND 4 3m HORN 9120D-HF VERTICAL Detector : Peak</p>
Avg.	 <p>Site : 03CH11-HY Condition : FCC CLASS-B (AVG) 3m HORN 9120D-HF HORIZONTAL Detector : Peak</p>	 <p>Site : 03CH11-HY Condition : FCC CLASS-B (AVG) 3m HORN 9120D-HF VERTICAL Detector : Peak</p>

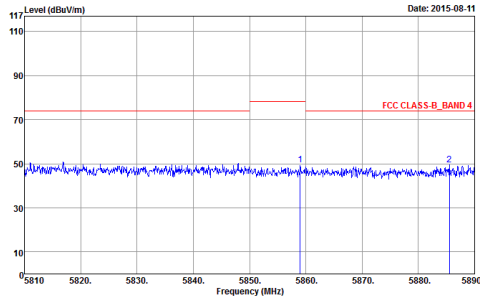
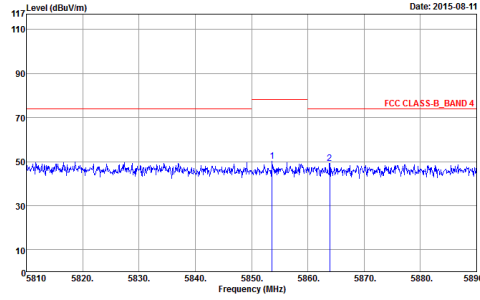
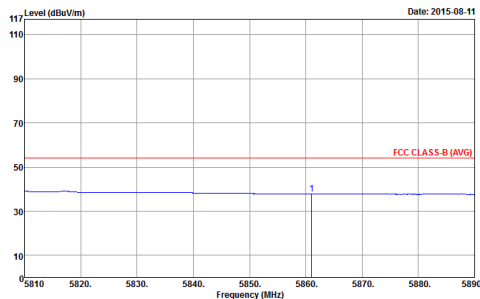
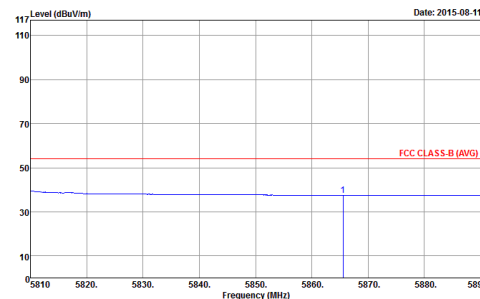

WIFI	Band 4 5725~5850MHz Band Edge @ 3m	
ANT	802.11n HT20 CH157 5785MHz – High Channel Location	
1+2	Horizontal	Vertical
Peak	 <p>Site : 03CH11-HY Condition : FCC CLASS-B_BAND 4 3m HORN 9120D-HF HORIZONTAL Detector : Peak</p>	 <p>Site : 03CH11-HY Condition : FCC CLASS-B_BAND 4 3m HORN 9120D-HF VERTICAL Detector : Peak</p>
Avg.	 <p>Site : 03CH11-HY Condition : FCC CLASS-B (AVG) 3m HORN 9120D-HF HORIZONTAL Detector : Peak</p>	 <p>Site : 03CH11-HY Condition : FCC CLASS-B (AVG) 3m HORN 9120D-HF VERTICAL Detector : Peak</p>

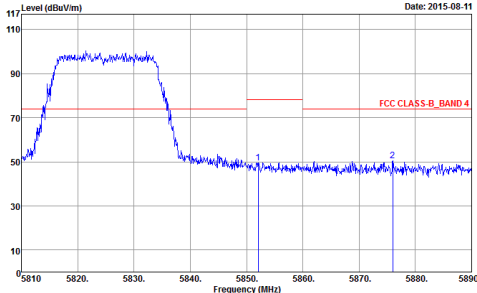
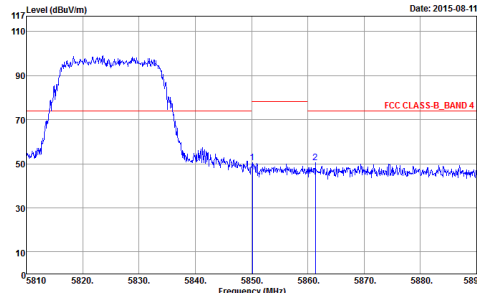
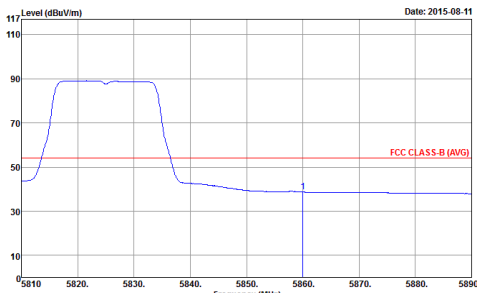
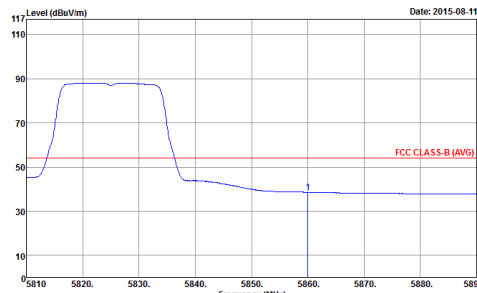

WIFI	Band 4 5725~5850MHz Band Edge @ 3m	
ANT	802.11n HT20 CH165 5825MHz	
1+2	Horizontal	Vertical
Peak	 <p>Site : 03CH11-HY Condition : FCC CLASS-B_BAND 4 3m HORN 9120D-HF HORIZONTAL Detector : Peak</p>	 <p>Site : 03CH11-HY Condition : FCC CLASS-B_BAND 4 3m HORN 9120D-HF VERTICAL Detector : Peak</p>
Avg.	 <p>Site : 03CH11-HY Condition : FCC CLASS-B (AVG) 3m HORN 9120D-HF HORIZONTAL Detector : Peak</p>	 <p>Site : 03CH11-HY Condition : FCC CLASS-B (AVG) 3m HORN 9120D-HF VERTICAL Detector : Peak</p>



Band 4 5725~5850MHz
WIFI 802.11n HT40 (Band Edge @ 3m)

WIFI	Band 4 5725~5850MHz Band Edge @ 3m	
ANT	802.11n HT40 CH151 5755MHz – Low Channel Location	
1+2	Horizontal	Vertical
<p>Peak</p>	<p>Site : 03CH11-HY Condition : FCC CLASS-B_BAND 4 3m HORN 9120D-HF HORIZONTAL Detector : Peak</p>	<p>Site : 03CH11-HY Condition : FCC CLASS-B_BAND 4 3m HORN 9120D-HF VERTICAL Detector : Peak</p>
<p>Avg.</p>	<p>Site : 03CH11-HY Condition : FCC CLASS-B (AVG) 3m HORN 9120D-HF HORIZONTAL Detector : Peak</p>	<p>Site : 03CH11-HY Condition : FCC CLASS-B (AVG) 3m HORN 9120D-HF VERTICAL Detector : Peak</p>

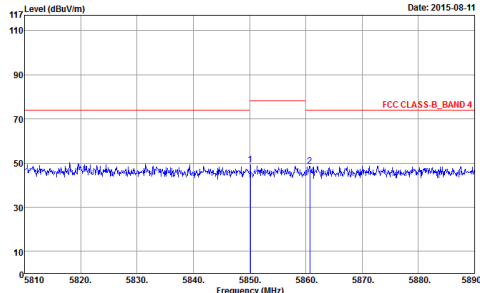
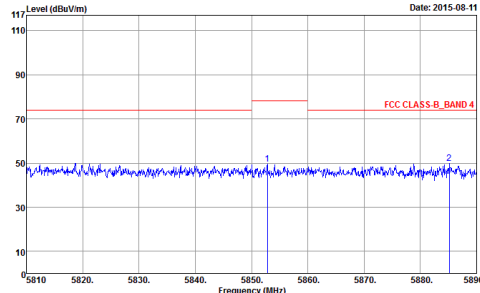
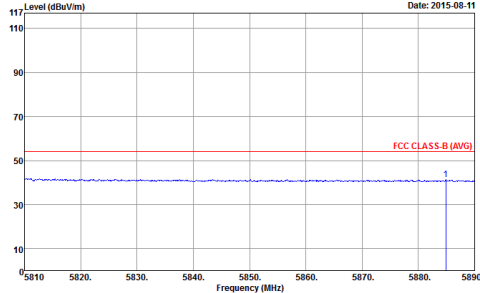
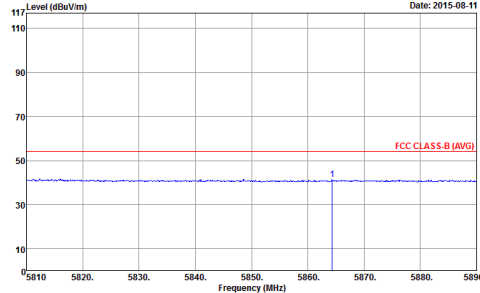

WIFI	Band 4 5725~5850MHz Band Edge @ 3m	
ANT	802.11n HT40 CH151 5755MHz – High Channel Location	
1+2	Horizontal	Vertical
Peak	 <p>Site : 03CH11-HY Condition : FCC CLASS-B_BAND 4 3m HORN 9120D-HF HORIZONTAL Detector : Peak</p>	 <p>Site : 03CH11-HY Condition : FCC CLASS-B_BAND 4 3m HORN 9120D-HF VERTICAL Detector : Peak</p>
Avg.	 <p>Site : 03CH11-HY Condition : FCC CLASS-B (AVG) 3m HORN 9120D-HF HORIZONTAL Detector : Peak</p>	 <p>Site : 03CH11-HY Condition : FCC CLASS-B (AVG) 3m HORN 9120D-HF VERTICAL Detector : Peak</p>

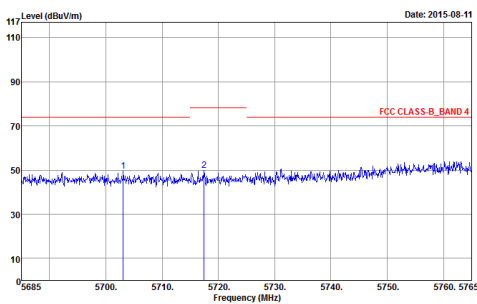
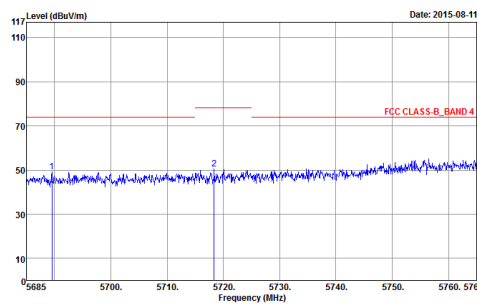
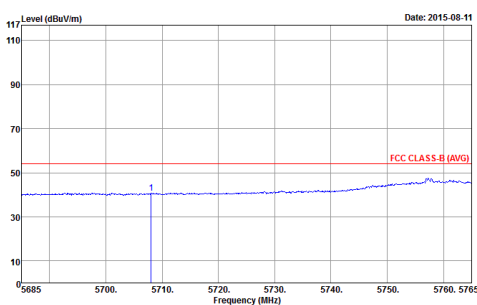
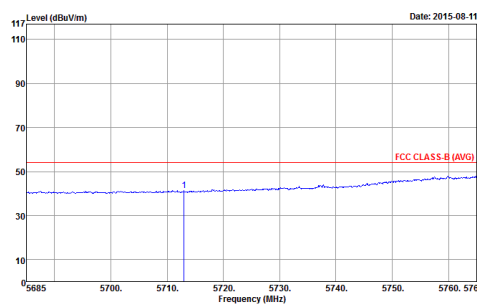

WIFI	Band 4 5725~5850MHz Band Edge @ 3m	
ANT	802.11n HT40 CH159 5795MHz – Low Channel Location	
1+2	Horizontal	Vertical
Peak	 <p>Site : 03CH11-HY Condition : FCC CLASS-B_BAND 4 3m HORN 9120D-HF HORIZONTAL : RBW:1000.000KHz VBW:3000.000KHz SWT:Auto Detector : Peak</p>	 <p>Site : 03CH11-HY Condition : FCC CLASS-B_BAND 4 3m HORN 9120D-HF VERTICAL : RBW:1000.000KHz VBW:3000.000KHz SWT:Auto Detector : Peak</p>
Avg.	 <p>Site : 03CH11-HY Condition : FCC CLASS-B (AVG) 3m HORN 9120D-HF HORIZONTAL : RBW:1000.000KHz VBW:3.000KHz SWT:Auto Detector : Peak</p>	 <p>Site : 03CH11-HY Condition : FCC CLASS-B (AVG) 3m HORN 9120D-HF VERTICAL : RBW:1000.000KHz VBW:3.000KHz SWT:Auto Detector : Peak</p>

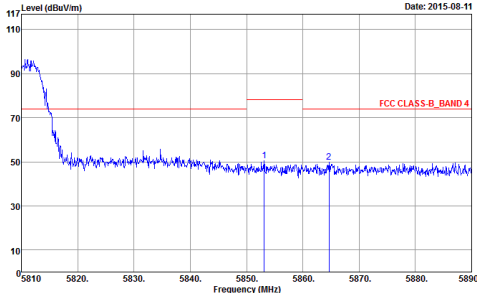
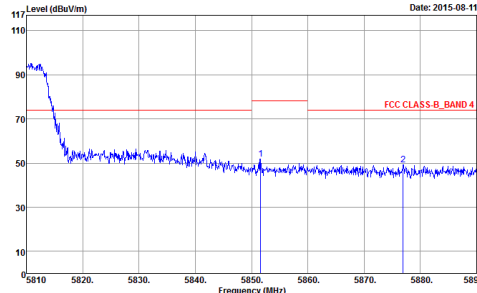
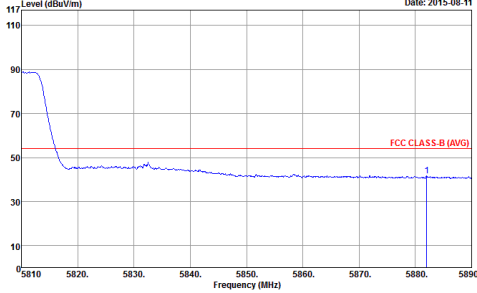
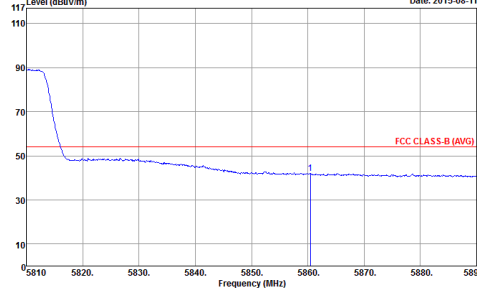

WIFI	Band 4 5725~5850MHz Band Edge @ 3m	
ANT	802.11n HT40 CH159 5795MHz – High Channel Location	
1+2	Horizontal	Vertical
<p>Peak</p>	 <p>Site : 03CH11-HY Condition : FCC CLASS-B_BAND 4 3m HORN 9120D-HF HORIZONTAL Detector : Peak</p>	 <p>Site : 03CH11-HY Condition : FCC CLASS-B_BAND 4 3m HORN 9120D-HF VERTICAL Detector : Peak</p>
<p>Avg.</p>	 <p>Site : 03CH11-HY Condition : FCC CLASS-B (AVG) 3m HORN 9120D-HF HORIZONTAL Detector : Peak</p>	 <p>Site : 03CH11-HY Condition : FCC CLASS-B (AVG) 3m HORN 9120D-HF VERTICAL Detector : Peak</p>



Band 4 5725~5850MHz
WIFI 802.11ac VHT80 (Band Edge @ 3m)

WIFI	Band 4 5725~5850MHz Band Edge @ 3m	
ANT	802.11ac VHT80 CH155 5775MHz – Low Channel Location	
1+2	Horizontal	Vertical
Peak	<p>Site : 03CH11-HY Condition : FCC CLASS-B_BAND 4 3m HORN 9120D-HF HORIZONTAL Detector : Peak</p>	<p>Site : 03CH11-HY Condition : FCC CLASS-B_BAND 4 3m HORN 9120D-HF VERTICAL Detector : Peak</p>
Avg.	<p>Site : 03CH11-HY Condition : FCC CLASS-B (AVG) 3m HORN 9120D-HF HORIZONTAL Detector : Peak</p>	<p>Site : 03CH11-HY Condition : FCC CLASS-B (AVG) 3m HORN 9120D-HF VERTICAL Detector : Peak</p>

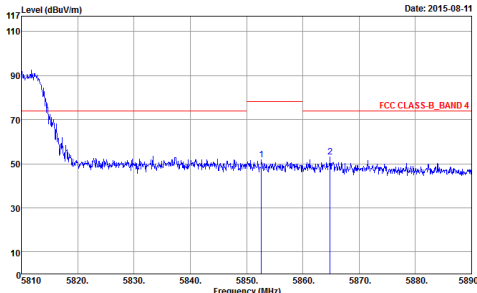
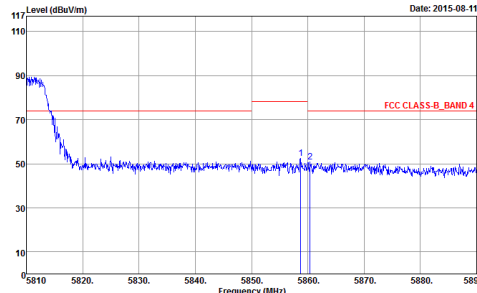
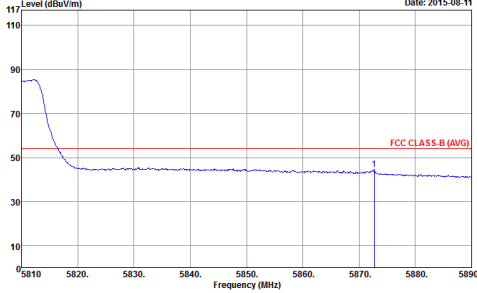
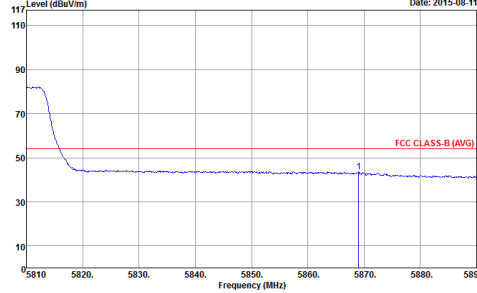

WIFI	Band 4 5725~5850MHz Band Edge @ 3m	
ANT	802.11ac VHT80 CH155 5775MHz – High Channel Location	
1+2	Horizontal	Vertical
Peak	 <p>Site : 03CH11-HY Condition : FCC CLASS-B_BAND 4 3m HORN 9120D-HF HORIZONTAL Detector : Peak</p>	 <p>Site : 03CH11-HY Condition : FCC CLASS-B_BAND 4 3m HORN 9120D-HF VERTICAL Detector : Peak</p>
Avg.	 <p>Site : 03CH11-HY Condition : FCC CLASS-B (AVG) 3m HORN 9120D-HF HORIZONTAL Detector : Peak</p>	 <p>Site : 03CH11-HY Condition : FCC CLASS-B (AVG) 3m HORN 9120D-HF VERTICAL Detector : Peak</p>



Band 4 - 5725~5850MHz

WIFI 802.11a (Harmonic @ 3m)

WIFI	Band 4 5725~5850MHz Harmonic @ 3m	
ANT	802.11a CH149 5745MHz	
1+2	Horizontal	Vertical
Peak Avg.	<p>Site : 03CH11-HY Condition : FCC CLASS-B_BAND 4 3m 9170 SHF HORM_I50809 HORIZONTAL Detector : Peak</p>	<p>Site : 03CH11-HY Condition : FCC CLASS-B_BAND 4 3m 9170 SHF HORM_I50809 VERTICAL Detector : Peak</p>

WIFI	Band 4 5725~5850MHz Harmonic @ 3m	
ANT	802.11a CH157 5785MHz	
1+2	Horizontal	Vertical
Peak Avg.	<p>Site : 03CH11-HY Condition : FCC CLASS-B_BAND 4 3m 9170 SHF HORM_I50809 HORIZONTAL Detector : Peak</p>	<p>Site : 03CH11-HY Condition : FCC CLASS-B_BAND 4 3m 9170 SHF HORM_I50809 VERTICAL Detector : Peak</p>



WIFI	Band 4 5725-5850MHz Harmonic @ 3m	
ANT	802.11a CH165 5825MHz	
1+2	Horizontal	Vertical
Peak Avg.	<p>Site : 03CH11-HY Condition : FCC CLASS-B_BAND 4 3m 9170 SHF HORM_I50809 HORIZONTAL Detector : Peak</p>	<p>Site : 03CH11-HY Condition : FCC CLASS-B_BAND 4 3m 9170 SHF HORM_I50809 VERTICAL Detector : Peak</p>



Band 4 5725~5850MHz
WIFI 802.11n HT20 (Harmonic @ 3m)

WIFI	Band 4 5725~5850MHz Harmonic @ 3m	
ANT	802.11n HT20 CH149 5745MHz	
1+2	Horizontal	Vertical
Peak Avg.	<p>Site : 03CH11-HY Condition : FCC CLASS-B_BAND 4 3m 9170 SHF HORM_I50809 HORIZONTAL Detector : Peak</p>	<p>Site : 03CH11-HY Condition : FCC CLASS-B_BAND 4 3m 9170 SHF HORM_I50809 VERTICAL Detector : Peak</p>

WIFI	Band 4 5725~5850MHz Harmonic @ 3m	
ANT	802.11n HT20 CH157 5785MHz	
1+2	Horizontal	Vertical
Peak Avg.	<p>Site : 03CH11-HY Condition : FCC CLASS-B_BAND 4 3m 9170 SHF HORM_I50809 HORIZONTAL Detector : Peak</p>	<p>Site : 03CH11-HY Condition : FCC CLASS-B_BAND 4 3m 9170 SHF HORM_I50809 VERTICAL Detector : Peak</p>



WIFI	Band 4 5725~5850MHz Harmonic @ 3m	
ANT	802.11n HT20 CH165 5825MHz	
1+2	Horizontal	Vertical
Peak Avg.	<p style="font-size: small;">Date: 2015-08-11</p> <p style="font-size: x-small;">Site : 03CH11-HY Condition : FCC CLASS-B_BAND 4 3m 9170 SHF HORM_I50809 HORIZONTAL Detector : Peak</p>	<p style="font-size: small;">Date: 2015-08-11</p> <p style="font-size: x-small;">Site : 03CH11-HY Condition : FCC CLASS-B_BAND 4 3m 9170 SHF HORM_I50809 VERTICAL Detector : Peak</p>



Band 4 5725~5850MHz
WIFI 802.11n HT40 (Harmonic @ 3m)

WIFI	Band 4 5725~5850MHz Harmonic @ 3m	
ANT	802.11n HT40 CH151 5755MHz	
1+2	Horizontal	Vertical
Peak Avg.	<p>Site : 03CH11-HY Condition : FCC CLASS-B_BAND 4 3m 9170 SHF HORM_I50809 HORIZONTAL Detector : Peak</p>	<p>Site : 03CH11-HY Condition : FCC CLASS-B_BAND 4 3m 9170 SHF HORM_I50809 VERTICAL Detector : Peak</p>

WIFI	Band 4 5725~5850MHz Harmonic @ 3m	
ANT	802.11n HT40 CH159 5795MHz	
1+2	Horizontal	Vertical
Peak Avg.	<p>Site : 03CH11-HY Condition : FCC CLASS-B_BAND 4 3m 9170 SHF HORM_I50809 HORIZONTAL Detector : Peak</p>	<p>Site : 03CH11-HY Condition : FCC CLASS-B_BAND 4 3m 9170 SHF HORM_I50809 VERTICAL Detector : Peak</p>

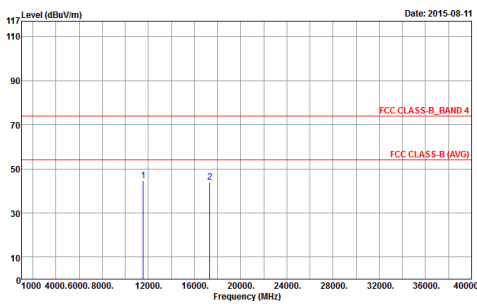
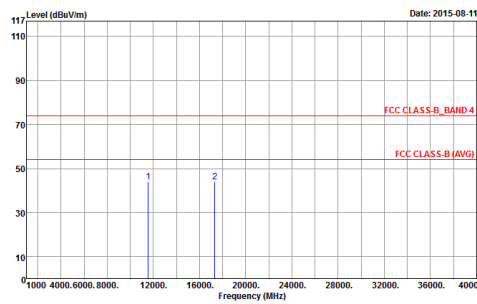

Band 4 5725~5850MHz
WIFI 802.11ac VHT80 (Harmonic @ 3m)

WIFI	Band 4 5725~5850MHz Harmonic @ 3m	
ANT	802.11ac VHT80 CH155 5775MHz	
1+2	Horizontal	Vertical
Peak	 <p>Site : 03CH11-HY Condition : FCC CLASS-B_BAND 4 3m 9170 SHF HORM_I50809 HORIZONTAL Detector : Peak</p>	 <p>Site : 03CH11-HY Condition : FCC CLASS-B_BAND 4 3m 9170 SHF HORM_I50809 VERTICAL Detector : Peak</p>
Avg.		



Emission below 1GHz

5GHz WIFI 802.11a (LF)

WIFI	5GHz 5725~5850MHz	
ANT	802.11a LF	
1+2	Horizontal	Vertical
QP / Peak	<p>Site : 03CH11-HY Condition : FCC CLASS-B 3m CBL6112 HORIZONTAL Detector : Peak</p>	<p>Site : 03CH11-HY Condition : FCC CLASS-B 3m CBL6112 VERTICAL Detector : Peak</p>

Emission below 1GHz

5GHz WIFI 802.11n HT20 (LF)

WIFI	5GHz 5725~5850MHz	
ANT	802.11n HT20 LF	
1+2	Horizontal	Vertical
QP / Peak	<p>Site : 03CH11-HY Condition : FCC CLASS-B_BAND 4 3m CBL6112 HORIZONTAL Detector : Peak</p>	<p>Site : 03CH11-HY Condition : FCC CLASS-B_BAND 4 3m CBL6112 VERTICAL Detector : Peak</p>



Emission below 1GHz

5GHz WIFI 802.11n HT40 (LF)

WIFI	5GHz 5725~5850MHz	
ANT	802.11n HT40 LF	
1+2	Horizontal	Vertical
QP / Peak	<p>Site : 03CH11-HY Condition : FCC CLASS-B_BAND 4 3m CBL6112 HORIZONTAL Detector : Peak</p>	<p>Site : 03CH11-HY Condition : FCC CLASS-B_BAND 4 3m CBL6112 VERTICAL Detector : Peak</p>

Emission below 1GHz

5GHz WIFI 802.11ac VHT80 (LF)

WIFI	5GHz 5725~5850MHz	
ANT	802.11ac VHT80 LF	
1+2	Horizontal	Vertical
QP / Peak	<p>Site : 03CH11-HY Condition : FCC CLASS-B_BAND 4 3m CBL6112 HORIZONTAL Detector : Peak</p>	<p>Site : 03CH11-HY Condition : FCC CLASS-B_BAND 4 3m CBL6112 VERTICAL Detector : Peak</p>