



# FCC RF Test Report

APPLICANT : Sony Mobile Communications Inc.  
EQUIPMENT : GSM/WCDMA/LTE Phone + Bluetooth, DTS/UNII  
a/b/g/n/ac, ANT+, and NFC  
BRAND NAME : Sony  
FCC ID : PY7-PM0907  
STANDARD : FCC 47 CFR Part 2, 22(H), 24(E), 27(L)  
CLASSIFICATION : PCS Licensed Transmitter Held to Ear (PCE)

The product was received on Jul. 16, 2015 and testing was completed on Sep. 07, 2015. We, SPORTON INTERNATIONAL INC., would like to declare that the tested sample has been evaluated in accordance with the test procedures given in ANSI / TIA / EIA-603-C-2004 and has been in compliance with the applicable technical standards.

The test results in this report apply exclusively to the tested model / sample. Without written approval of SPORTON INTERNATIONAL INC., the test report shall not be reproduced except in full.

Reviewed by: Joseph Lin / Supervisor

Approved by: Jones Tsai / Manager



## SPORTON INTERNATIONAL INC.

No. 52, Hwa Ya 1<sup>st</sup> Rd., Hwa Ya Technology Park, Kwei-Shan District, Tao Yuan City, Taiwan, R.O.C.

SPORTON INTERNATIONAL INC.

TEL : 886-3-327-3456

FAX : 886-3-328-4978

FCC ID : PY7-PM0907

Page Number : 1 of 21

Report Issued Date : Sep. 17, 2015

Report Version : Rev. 01

Report Template No.: BU5-FG22/24/27 Version 1.0



# TABLE OF CONTENTS

**REVISION HISTORY.....3**

**SUMMARY OF TEST RESULT .....4**

**1 GENERAL DESCRIPTION.....5**

    1.1 Applicant.....5

    1.2 Manufacturer .....5

    1.3 Product Feature of Equipment Under Test .....5

    1.4 Modification of EUT .....6

    1.5 Maximum ERP/EIRP Power, Frequency Tolerance, and Emission Designator .....6

    1.6 Testing Location .....7

    1.7 Applicable Standards .....7

**2 TEST CONFIGURATION OF EQUIPMENT UNDER TEST.....8**

    2.1 Test Mode.....8

    2.2 Connection Diagram of Test System .....9

    2.3 Support Unit used in test configuration .....9

    2.4 Measurement Results Explanation Example .....9

**3 CONDUCTED TEST RESULT.....10**

    3.1 Measuring Instruments.....10

    3.2 Test Setup .....10

    3.3 Test Result of Conducted Test.....10

    3.4 Conducted Output Power.....11

    3.5 Peak-to-Average Ratio .....11

    3.6 99% Occupied Bandwidth and 26dB Bandwidth Measurement.....12

    3.7 Conducted Band Edge .....13

    3.8 Conducted Spurious Emission .....14

    3.9 Frequency Stability.....15

**4 RADIATED TEST ITEMS .....16**

    4.1 Measuring Instruments.....16

    4.2 Test Setup .....16

    4.3 Test Result of Radiated Test.....16

    4.4 Effective Radiated Power and Effective Isotropic Radiated Power Measurement .....17

    4.5 Field Strength of Spurious Radiation Measurement .....18

**5 LIST OF MEASURING EQUIPMENT .....19**

**6 UNCERTAINTY OF EVALUATION.....21**

**APPENDIX A. TEST RESULTS OF CONDUCTED TEST**

**APPENDIX B. TEST RESULTS OF RADIATED TEST**



### REVISION HISTORY

REPORT NO.	VERSION	DESCRIPTION	ISSUED DATE
FG571613A	Rev. 01	Initial issue of report	Sep. 17, 2015



## SUMMARY OF TEST RESULT

Report Section	FCC Rule	Description	Limit	Result	Remark
3.4	§2.1046	Conducted Output Power	Reporting Only	PASS	-
3.5	§24.232(d)	Peak-to-Average Ratio	< 13 dB	PASS	-
3.6	§2.1049 §22.917(b) §24.238(b) §27.53(g)	Occupied Bandwidth	Reporting Only	PASS	-
3.7	§2.1051 §22.917(a) §24.238(a) §27.53(h)	Band Edge Measurement	< 43+10log10(P[Watts])	PASS	-
3.8	§2.1051 §22.917(a) §24.238(a) §27.53(h)	Conducted Emission	< 43+10log10(P[Watts])	PASS	-
3.9	§2.1055 §22.355	Frequency Stability for Temperature & Voltage	< 2.5 ppm for Part 22	PASS	-
	§2.1055 §24.235 §27.54		Within Authorized Band		
4.4	§22.913(a)(2)	Effective Radiated Power	< 7 Watts	PASS	-
	§24.232(c)	Equivalent Isotropic Radiated Power	< 2 Watts	PASS	-
	§27.50(d)(4)	Equivalent Isotropic Radiated Power	< 1 Watts	PASS	-
4.5	§2.1053 §22.917(a) §24.238(a) §27.53(h)	Field Strength of Spurious Radiation	< 43+10log10(P[Watts])	PASS	Under limit 36.27 dB at 7635.000 MHz

**Remark:** Except effective Radiated Power and Equivalent Isotropic Radiated Power of GSM850 (GSM), GSM1900 (GPRS Class 8), and WCDMA Band IV are carrying out, FG571613A report reuses test data from the FG571612A report.



# 1 General Description

## 1.1 Applicant

Sony Mobile Communications Inc.  
Nya Vattentorget, 22188 Lund, Sweden

## 1.2 Manufacturer

Sony Mobile Communications Inc.  
1-8-15 Konan, Minato-ku, Tokyo, 108-0075, Japan

## 1.3 Product Feature of Equipment Under Test

GSM/WCDMA/LTE, Bluetooth, DTS/UNII a/b/g/n/ac, ANT+, NFC, and GPS

Product Specification subjective to this standard	
Antenna Type	Monopole Antenna

EUT Information List				
IMEI	HW Version	SW Version	S/N	Performed Test Item
004402455354849	A	32.0.A.0.323	CB5A27GY3U	RF conducted measurement
004402455358089			CB5A27GY3S	Radiated Spurious Emission
004402455357545			CB5A27GXY9	ERP/EIRP Test
004402455368252			CB5A27HTJS	

Accessory List	
AC Adapter	Model No. : UCH20
	Type No. : AC-0061-US
	S/N : 5815W22500089
Earphone	Model No. : MDR-NC31E
	Type No. : AG-1110
USB Cable	Model No. : UCB11
	Type No. : AI-0120
	S/N : 1522A73000065C4

**Note:**

1. Above EUT list and accessory list used are electrically identical per declared by manufacturer.
2. Above the accessories list are used to exercise the EUT during test.
3. For other wireless features of this EUT, test report will be issued separately.



### 1.4 Modification of EUT

No modifications are made to the EUT during all test items.

### 1.5 Maximum ERP/EIRP Power, Frequency Tolerance, and Emission Designator

FCC Rule	System	Type of Modulation	Maximum ERP/EIRP (W)	Frequency Tolerance (ppm)	Emission Designator
Part 22	GSM850 GSM	GMSK	0.3690	0.0299 ppm	244KGXW
Part 22	GSM850 EDGE class 8	8PSK	0.1563	0.0108 ppm	248KG7W
Part 22	WCDMA Band V RMC 12.2Kbps	QPSK	0.0904	0.0143 ppm	4M16F9W
Part 24	GSM1900 GPRS class 8	GMSK	0.3664	0.0165 ppm	245KGXW
Part 24	GSM1900 EDGE class 8	8PSK	0.2148	0.0112 ppm	245KG7W
Part 24	WCDMA Band II RMC 12.2Kbps	QPSK	0.0733	0.0048 ppm	4M16F9W
Part 27	WCDMA Band IV RMC 12.2Kbps	QPSK	0.1227	0.0040 ppm	4M15F9W



### 1.6 Testing Location

Sporton Lab is accredited to ISO 17025 by Taiwan Accreditation Foundation (TAF code : 1190) and the FCC designation No. TW1022 under the FCC 2.948(e) by Mutual Recognition Agreement (MRA) in FCC Test.

<b>Test Site</b>	SPORTON INTERNATIONAL INC.	
<b>Test Site Location</b>	No. 52, Hwa Ya 1 <sup>st</sup> Rd., Hwa Ya Technology Park, Kwei-Shan District, Tao Yuan City, Taiwan, R.O.C. TEL: +886-3-327-3456 FAX: +886-3-328-4978	
<b>Test Site No.</b>	<b>Sporton Site No.</b>	
	TH03-HY	03CH07-HY

### 1.7 Applicable Standards

According to the specifications of the manufacturer, the EUT must comply with the requirements of the following standards:

- ♦ 47 CFR Part 2, 22(H), 24(E), 27(L)
- ♦ ANSI / TIA / EIA-603-C-2004
- ♦ FCC KDB 971168 D01 Power Meas. License Digital Systems v02r02

**Remark:** All test items were verified and recorded according to the standards and without any deviation during the test.



## 2 Test Configuration of Equipment Under Test

### 2.1 Test Mode

Antenna port conducted and radiated test items were performed according to KDB 971168 D01 Power Meas. License Digital Systems v02r02 with maximum output power.

Radiated measurements were performed with rotating EUT in different three orthogonal test planes to find the maximum emission.

Radiated emissions were investigated as following frequency range:

1. 30 MHz to 9000 MHz for GSM850 and WCDMA Band V.
2. 30 MHz to 18000 MHz for WCDMA Band IV.
3. 30 MHz to 19000 MHz for GSM1900 and WCDMA Band II.

All modes and data rates and positions were investigated.

Test modes are chosen to be reported as the worst case configuration below:

Test Modes		
Band	Radiated TCs	Conducted TCs
GSM 850	<ul style="list-style-type: none"><li>■ GSM Link</li><li>■ EDGE class 8 Link</li></ul>	<ul style="list-style-type: none"><li>■ GSM Link</li><li>■ EDGE class 8 Link</li></ul>
GSM 1900	<ul style="list-style-type: none"><li>■ GPRS class 8 Link</li><li>■ EDGE class 8 Link</li></ul>	<ul style="list-style-type: none"><li>■ GPRS class 8 Link</li><li>■ EDGE class 8 Link</li></ul>
WCDMA Band V	<ul style="list-style-type: none"><li>■ RMC 12.2Kbps Link</li></ul>	<ul style="list-style-type: none"><li>■ RMC 12.2Kbps Link</li></ul>
WCDMA Band II	<ul style="list-style-type: none"><li>■ RMC 12.2Kbps Link</li></ul>	<ul style="list-style-type: none"><li>■ RMC 12.2Kbps Link</li></ul>
WCDMA Band IV	<ul style="list-style-type: none"><li>■ RMC 12.2Kbps Link</li></ul>	<ul style="list-style-type: none"><li>■ RMC 12.2Kbps Link</li></ul>



## 2.2 Connection Diagram of Test System

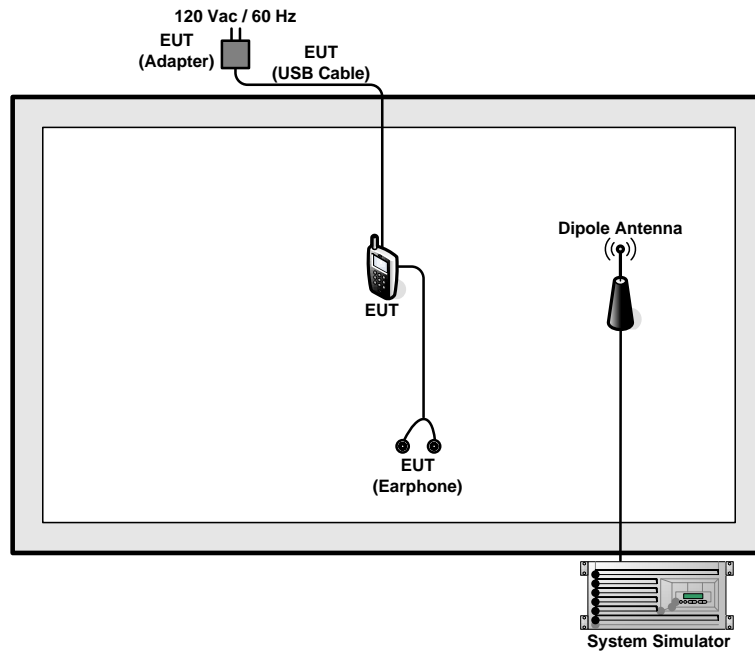

## 2.3 Support Unit used in test configuration

Item	Equipment	Trade Name	Model No.	FCC ID	Data Cable	Power Cord
1.	System Simulator	R&S	CMU 200	N/A	N/A	Unshielded, 1.8 m

## 2.4 Measurement Results Explanation Example

### For all conducted test items:

The offset level is set in the spectrum analyzer to compensate the RF cable loss and attenuator factor between RF conducted output port and spectrum analyzer. With the offset compensation, the spectrum analyzer reading level will be exactly the RF output level.

The spectrum analyzer offset is derived from RF cable loss and attenuator factor.

$$\text{Offset} = \text{RF cable loss} + \text{attenuator factor}.$$

The following shows an offset computation example with RF cable loss 4.2 dB and a 10dB attenuator.

Example :

$$\begin{aligned} \text{Offset(dB)} &= \text{RF cable loss(dB)} + \text{attenuator factor(dB)} \\ &= 4.2 + 10 = 14.2 \text{ (dB)} \end{aligned}$$

### 3 Conducted Test Result

#### 3.1 Measuring Instruments

See list of measuring instruments of this test report.

#### 3.2 Test Setup

##### 3.2.1 Conducted Output Power

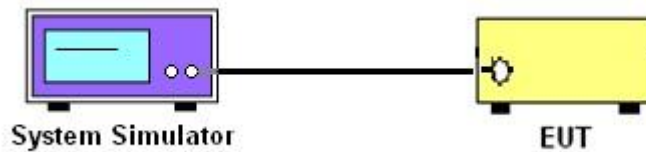

##### 3.2.2 Peak-to-Average Ratio, Occupied Bandwidth, Conducted Band-Edge and Conducted Spurious Emission

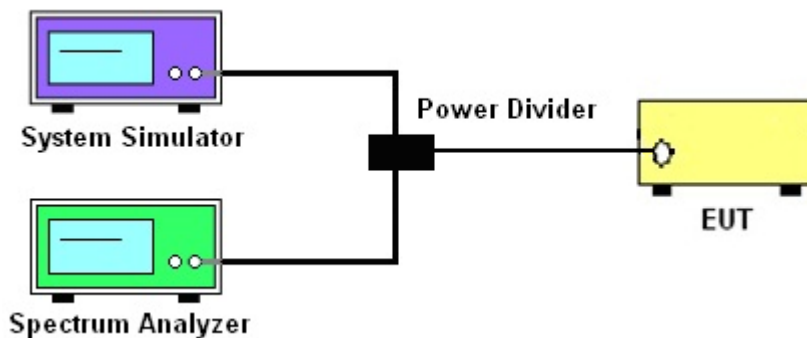

##### 3.2.3 Frequency Stability

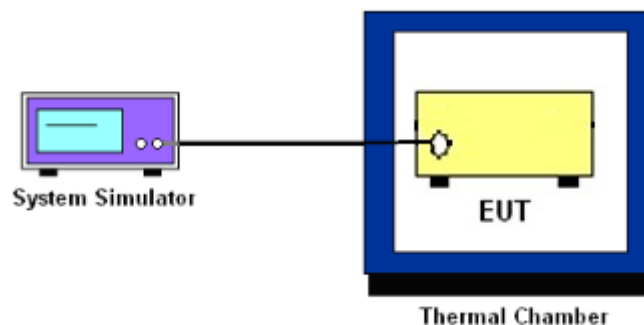

### 3.3 Test Result of Conducted Test

Please refer to Appendix A.



## 3.4 Conducted Output Power

### 3.4.1 Description of the Conducted Output Power

A system simulator was used to establish communication with the EUT. Its parameters were set to enforce EUT transmitting at the maximum power. The measured power in the radio frequency on the transmitter output terminals shall be reported.

### 3.4.2 Test Procedures

1. The transmitter output port was connected to the system simulator.
2. Set EUT at maximum power through system simulator.
3. Select lowest, middle, and highest channels for each band and different modulation.
4. Measure the maximum burst average power for GSM and maximum average power for other modulation signal.

## 3.5 Peak-to-Average Ratio

### 3.5.1 Description of the PAR Measurement

The peak-to-average ratio (PAR) of the transmission may not exceed 13 dB.

### 3.5.2 Test Procedures

1. The testing follows FCC KDB 971168 D01 v02r02 Section 5.7.1.
2. The EUT was connected to spectrum analyzer and system simulator via a power divider.
3. Set EUT to transmit at maximum output power.
4. When the duty cycle is less than 98%, then signal gating will be implemented on the spectrum analyzer by triggering from the system simulator.
5. Set the CCDF (Complementary Cumulative Distribution Function) option of the spectrum analyzer.

Record the maximum PAPR level associated with a probability of 0.1%.



### 3.6 99% Occupied Bandwidth and 26dB Bandwidth Measurement

#### 3.6.1 Description of 99% Occupied Bandwidth and 26dB Bandwidth Measurement

The 99% occupied bandwidth is the width of a frequency band such that, below the lower and above the upper frequency limits, the mean powers emitted are each equal to a specified percentage 0.5% of the total mean transmitted power.

The emission bandwidth is defined as the width of the signal between two points, located at the two sides of the carrier frequency, outside of which all emissions are attenuated at least 26 dB below the transmitter power.

#### 3.6.2 Test Procedures

1. The testing follows FCC KDB 971168 D01 v02r02 Section 4.2.
2. The EUT was connected to the spectrum analyzer and system simulator via a power divider.
3. The RF output of the EUT was connected to the spectrum analyzer by RF cable and attenuator. The path loss was compensated to the results for each measurement.
4. The 99% occupied bandwidth were measured, set RBW= 1% of span, VBW= 3\*RBW, sample detector, trace maximum hold.
5. The 26dB bandwidth were measured, set RBW= 1% of EBW, VBW= 3\*RBW, peak detector, trace maximum hold.



### 3.7 Conducted Band Edge

#### 3.7.1 Description of Conducted Band Edge Measurement

The power of any emission outside of the authorized operating frequency ranges must be lower than the transmitter power (P) by a factor of at least  $43 + 10 \log (P)$  dB.

#### 3.7.2 Test Procedures

1. The testing follows FCC KDB 971168 D01 v02r02 Section 6.0.
2. The EUT was connected to the spectrum analyzer and system simulator via a power divider.
3. The RF output of EUT was connected to the spectrum analyzer by an RF cable and attenuator. The path loss was compensated to the results for each measurement.
4. The band edges of low and high channels for the highest RF powers were measured.
5. The RF fundamental frequency should be excluded against the limit line in the operating frequency band.
6. The limit line is derived from  $43 + 10\log(P)$  dB below the transmitter power P(Watts)  
 $= P(W) - [43 + 10\log(P)]$  (dB)  
 $= [30 + 10\log(P)]$  (dBm) -  $[43 + 10\log(P)]$  (dB)  
 $= -13\text{dBm}$ .



### 3.8 Conducted Spurious Emission

#### 3.8.1 Description of Conducted Spurious Emission Measurement

The power of any emission outside of the authorized operating frequency ranges must be lower than the transmitter power (P) by a factor of at least  $43 + 10 \log (P)$  dB.

It is measured by means of a calibrated spectrum analyzer and scanned from 30 MHz up to a frequency including its 10<sup>th</sup> harmonic.

#### 3.8.2 Test Procedures

1. The testing follows FCC KDB 971168 D01 v02r02 Section 6.0.
2. The EUT was connected to the spectrum analyzer and system simulator via a power divider.
3. The RF output of EUT was connected to the spectrum analyzer by an RF cable and attenuator. The path loss was compensated to the results for each measurement.
4. The middle channel for the highest RF power within the transmitting frequency was measured.
5. The conducted spurious emission for the whole frequency range was taken.
6. The RF fundamental frequency should be excluded against the limit line in the operating frequency band.
7. The limit line is derived from  $43 + 10\log(P)$  dB below the transmitter power P(Watts)  
=  $P(W) - [43 + 10\log(P)]$  (dB)  
=  $[30 + 10\log(P)]$  (dBm) -  $[43 + 10\log(P)]$  (dB)  
= -13dBm.



### 3.9 Frequency Stability

#### 3.9.1 Description of Frequency Stability Measurement

The frequency stability shall be measured by variation of ambient temperature and variation of primary supply voltage to ensure that the fundamental emission stays within the authorized frequency block. The frequency stability of the transmitter shall be maintained within  $\pm 0.00025\%$  ( $\pm 2.5\text{ppm}$ ) of the center frequency.

#### 3.9.2 Test Procedures for Temperature Variation

1. The testing follows FCC KDB 971168 D01 v02r02 Section 9.0.
2. The EUT was set up in the thermal chamber and connected with the system simulator.
3. With power OFF, the temperature was decreased to  $-30^{\circ}\text{C}$  and the EUT was stabilized before testing. Power was applied and the maximum change in frequency was recorded within one minute.
4. With power OFF, the temperature was raised in  $10^{\circ}\text{C}$  steps up to  $50^{\circ}\text{C}$ . The EUT was stabilized at each step for at least half an hour. Power was applied and the maximum frequency change was recorded within one minute.

#### 3.9.3 Test Procedures for Voltage Variation

1. The testing follows FCC KDB 971168 D01 v02r02 Section 9.0.
2. The EUT was placed in a temperature chamber at  $25\pm 5^{\circ}\text{C}$  and connected with the system simulator.
3. The power supply voltage to the EUT was varied from 85% to 115% of the nominal value measured at the input to the EUT.
4. The variation in frequency was measured for the worst case.

## 4 Radiated Test Items

### 4.1 Measuring Instruments

See list of measuring instruments of this test report.

### 4.2 Test Setup

#### 4.2.1 For radiated test from 30MHz to 1GHz

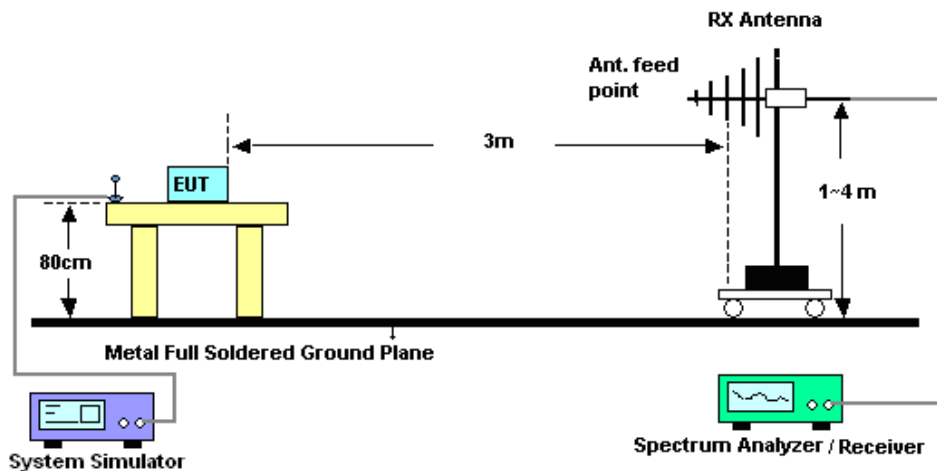

#### 4.2.2 For radiated test above 1GHz

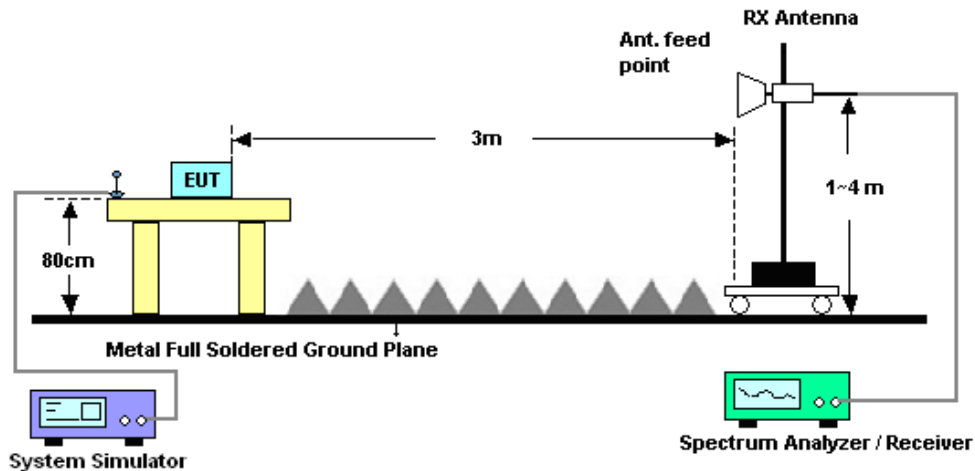

### 4.3 Test Result of Radiated Test

Please refer to Appendix B.





### 4.4 Effective Radiated Power and Effective Isotropic Radiated Power Measurement

#### 4.4.1 Description of the ERP/EIRP Measurement

The substitution method, in ANSI / TIA / EIA-603-C-2004, was used for ERP/EIRP measurement, and the spectrum analyzer configuration follows KDB 971168 D01 Power Meas. License Digital Systems v02r02. The ERP of mobile transmitters must not exceed 7 Watts (Cellular Band) and the EIRP of mobile transmitters are limited to 2 Watts (PCS Band) and 1 Watts (AWS Band).

#### 4.4.2 Test Procedures

1. The testing follows FCC KDB 971168 D01 v02r02 Section 5.2.1. (for CDMA/WCDMA), Section 5.2.2.2 (for GSM/GPRS/EDGE) and ANSI / TIA-603-C-2004 Section 2.2.17.
2. The EUT was placed on a non-conductive rotating platform 0.8 meters high in a semi-anechoic chamber. The radiated emission at the fundamental frequency was measured at 3 m with a test antenna and a spectrum analyzer with RMS detector per section 5. of KDB 971168 D01.
3. During the measurement, the system simulator parameters were set to force the EUT transmitting at maximum output power. The maximum emission was recorded from analyzer power level (LVL) from the 360 degrees rotation of the turntable and the test antenna raised and lowered over a range from 1 to 4 meters in both horizontally and vertically polarized orientations.
4. Effective Isotropic Radiated Power (EIRP) was measured by substitution method according to TIA/EIA-603-C. The EUT was replaced by the substitution antenna at same location, and then a known power from S.G. was applied into the dipole antenna through a Tx cable, and then recorded the maximum Analyzer reading through raised and lowered the test antenna. The correction factor (in dB) = S.G. - Tx Cable loss + Substitution antenna gain - Analyzer reading. Then the EUT's EIRP was calculated with the correction factor,  $EIRP = LVL + \text{Correction factor}$  and  $ERP = EIRP - 2.15$ . Take the record of the output power at substitution antenna.

	GSM/GPRS/EDGE	WCDMA/HSPA
SPAN	500kHz	10MHz
RBW	10kHz	100kHz
VBW	30kHz	300kHz
Detector	RMS	RMS
Trace	Average	Average
Average Type	Power	Power
Sweep Count	100	100



## 4.5 Field Strength of Spurious Radiation Measurement

### 4.5.1 Description of Field Strength of Spurious Radiated Measurement

The power of any emission outside of the authorized operating frequency ranges must be attenuated below the transmitter power (P) by a factor of at least  $43 + 10 \log (P)$  dB. The spectrum is scanned from 30 MHz up to a frequency including its 10th harmonic.

### 4.5.2 Test Procedures

1. The testing follows FCC KDB 971168 D01 v02r02 Section 5.8 and ANSI / TIA-603-C-2004 Section 2.2.12.
2. The EUT was placed on a rotatable wooden table 0.8 meters above the ground.
3. The EUT was set 3 meters from the receiving antenna, which was mounted on the antenna tower.
4. The table was rotated 360 degrees to determine the position of the highest spurious emission.
5. The height of the receiving antenna is varied between one meter and four meters to search for the maximum spurious emission for both horizontal and vertical polarizations.
6. Make the measurement with the spectrum analyzer's RBW = 1MHz, VBW = 3MHz, taking record of maximum spurious emission.
7. A horn antenna was substituted in place of the EUT and was driven by a signal generator.
8. Tune the output power of signal generator to the same emission level with EUT maximum spurious emission.
9. Taking the record of output power at antenna port.
10. Repeat step 7 to step 8 for another polarization.
11.  $EIRP \text{ (dBm)} = S.G. \text{ Power} - Tx \text{ Cable Loss} + Tx \text{ Antenna Gain}$
12.  $ERP \text{ (dBm)} = EIRP - 2.15$
13. The RF fundamental frequency should be excluded against the limit line in the operating frequency band.
14. The limit line is derived from  $43 + 10\log(P)$  dB below the transmitter power P(Watts)  
 $= P(W) - [43 + 10\log(P)] \text{ (dB)}$   
 $= [30 + 10\log(P)] \text{ (dBm)} - [43 + 10\log(P)] \text{ (dB)}$   
 $= -13\text{dBm}.$



## 5 List of Measuring Equipment

Instrument	Manufacturer	Model No.	Serial No.	Characteristics	Calibration Date	Test Date	Due Date	Remark
Spectrum Analyzer	Rohde & Schwarz	FSP30	101329	9kHz~30GHz	Jun. 24, 2015	Aug. 21, 2015	Jun. 23, 2016	Conducted (TH03-HY)
Hygrometer	Testo	608-H1	34893241	N/A	May 04, 2015	Aug. 21, 2015	May 03, 2016	Conducted (TH03-HY)
Temperature Chamber	ESPEC	SU-641	92013721	-30°C ~70°C	Dec. 01, 2014	Aug. 21, 2015	Nov. 30, 2015	Conduction (TH03-HY)
RF cable	WOKEN	S05	S05-130708-22	N/A	Jan. 21, 2015	Aug. 21, 2015	Jan. 20, 2016	Conducted (TH03-HY)
Bilog Antenna	Schaffner	CBL6111C	2726	30MHz ~ 1GHz	Sep. 27, 2014	Aug. 27, 2015 ~ Sep. 07, 2015	Sep. 26, 2015	Radiation (03CH07-HY)
Double Ridge Horn Antenna	ESCO	3117	00075962	1GHz ~ 18GHz	Aug. 21, 2015	Aug. 27, 2015 ~ Sep. 07, 2015	Aug. 20, 2016	Radiation (03CH07-HY)
Horn Antenna	SCHWARZBECK	BBHA 9170	BBHA9170584	18GHz- 40GHz	Nov. 03, 2014	Aug. 27, 2015 ~ Sep. 07, 2015	Nov. 02, 2015	Radiation (03CH07-HY)
Hygrometer	Testo	608-H1	34897197	N/A	May 04, 2015	Aug. 27, 2015 ~ Sep. 07, 2015	May 03, 2016	Radiation (03CH07-HY)
Preamplifier	COM-POWER	PA-103A	161241	10MHz-1000MHz	Mar. 12, 2015	Aug. 27, 2015 ~ Sep. 07, 2015	Mar. 11, 2016	Radiation (03CH07-HY)
Preamplifier	Agilent	8449B	3008A02362	1GHz~ 26.5GHz	Oct. 21, 2014	Aug. 27, 2015 ~ Sep. 07, 2015	Oct. 20, 2015	Radiation (03CH07-HY)
Preamplifier	MITEQ	JS44-18004000-33-8P	1840917	18GHz ~ 40GHz	Jun. 02, 2015	Aug. 27, 2015 ~ Sep. 07, 2015	Jun. 01, 2016	Radiation (03CH07-HY)
Signal Analyzer	Rohde & Schwarz	FSV 30	101749	10Hz~30GHz	Mar. 10, 2015	Aug. 27, 2015 ~ Sep. 07, 2015	Mar. 09, 2016	Radiation (03CH07-HY)
Controller	ChainTek	Chaintek 3000	N/A	Control Turn table	N/A	Aug. 27, 2015 ~ Sep. 07, 2015	N/A	Radiation (03CH07-HY)
Controller	Max-Full	MF7802	MF780208368	Control Ant Mast	N/A	Aug. 27, 2015 ~ Sep. 07, 2015	N/A	Radiation (03CH07-HY)
Antenna Mast	Max-Full	MFA520BS	N/A	1m~4m	N/A	Aug. 27, 2015 ~ Sep. 07, 2015	N/A	Radiation (03CH07-HY)
Turn Table	ChainTek	Chaintek 3000	N/A	0~360 degree	N/A	Aug. 27, 2015 ~ Sep. 07, 2015	N/A	Radiation (03CH07-HY)
RF Cable	HUBER + SUHNER	SUCOFLEX 104	MY84209521	1GHz~40GHz	Dec. 04, 2014	Aug. 27, 2015 ~ Sep. 07, 2015	Dec. 03, 2015	Radiation (03CH07-HY)
RF Cable	HUBER + SUHNER	SUCOFLEX 104	MY84209521	9KHz~1GHz	Dec. 04, 2014	Aug. 27, 2015 ~ Sep. 07, 2015	Dec. 03, 2015	Radiation (03CH07-HY)
Test Software	N/A	E3	6.2009-8-24 (sporton)	N/A	N/A	Aug. 27, 2015 ~ Sep. 07, 2015	N/A	Radiation (03CH07-HY)
Filter	Wainwright	WLKS1200-8SS	SN3	1.2G Low Pass	Oct. 01, 2014	Aug. 27, 2015 ~ Sep. 07, 2015	Sep. 30, 2015	Radiation (03CH07-HY)
Filter	Wainwright	WHK1.5/15G-10SS	SN32	1.5G High Pass	Oct. 01, 2014	Aug. 27, 2015 ~ Sep. 07, 2015	Sep. 30, 2015	Radiation (03CH07-HY)
Filter	Microwave	H3G018G1	SN477220	3.0G High Pass	Oct. 01, 2014	Aug. 27, 2015 ~ Sep. 07, 2015	Sep. 30, 2015	Radiation (03CH07-HY)



Instrument	Manufacturer	Model No.	Serial No.	Characteristics	Calibration Date	Test Date	Due Date	Remark
Notch Filter	Wainwright	WRCG824/84 9-40/8SS	SN35	CDMA 850	Oct. 01, 2014	Aug. 27, 2015 ~ Sep. 07, 2015	Sep. 30, 2015	Radiation (03CH07-HY)
Notch Filter	Wainwright	WRCT1850/1 910-40/8SS	SN21	1900	Oct. 01, 2014	Aug. 27, 2015 ~ Sep. 07, 2015	Sep. 30, 2015	Radiation (03CH07-HY)
Notch Filter	Wainwright	WRCG1710/1 755-1690/175 5-45/7SS	SN2	AWS Band	Oct. 01, 2014	Aug. 27, 2015 ~ Sep. 07, 2015	Sep. 30, 2015	Radiation (03CH07-HY)



## 6 Uncertainty of Evaluation

### Uncertainty of Radiated Emission Measurement (30 MHz ~ 1000 MHz)

Measuring Uncertainty for a Level of Confidence of 95% ( $U = 2Uc(y)$ )	4.50
---	------



## Appendix A. Test Results of Conducted Test

### Conducted Output Power (Average power)

Conducted Power (*Unit: dBm)						
Band	GSM850			GSM1900		
Channel	128	189	251	512	661	810
Frequency	824.2	836.4	848.8	1850.2	1880.0	1909.8
GSM	31.38	31.44	31.49	27.66	27.63	27.60
GPRS class 8	31.36	31.41	31.45	27.61	27.70	27.66
GPRS class 10	30.57	30.59	30.01	24.94	24.90	24.83
GPRS class 11	28.51	28.55	28.58	22.96	22.84	22.79
GPRS class 12	27.37	27.44	27.46	21.28	21.30	21.27
EGPRS class 8	27.36	27.34	27.35	26.24	26.24	26.20
EGPRS class 10	26.27	26.17	26.22	24.76	24.75	24.71
EGPRS class 11	24.34	24.32	24.32	22.58	22.54	22.49
EGPRS class 12	23.15	23.15	23.20	20.23	20.24	20.28

Conducted Power (*Unit: dBm)									
Band	WCDMA Band V			WCDMA Band II			WCDMA Band IV		
Channel	4132	4182	4233	9262	9400	9538	1312	1413	1513
Frequency	826.4	836.4	846.6	1852.4	1880	1907.6	1712.4	1732.6	1752.6
RMC 12.2K	24.38	24.53	24.43	20.63	20.77	20.66	20.65	20.66	20.56
HSDPA Subtest-1	23.31	23.42	23.42	19.74	19.93	19.65	19.66	19.68	19.60
HSDPA Subtest-2	23.42	23.46	23.49	19.67	19.86	19.70	19.74	19.70	19.56
HSDPA Subtest-3	22.81	22.93	22.95	19.18	19.29	19.19	19.10	19.17	19.02
HSDPA Subtest-4	22.83	22.92	22.94	19.21	19.30	19.18	19.16	19.19	19.04
HSUPA Subtest-1	23.07	23.28	23.18	19.05	19.37	19.22	19.03	19.16	19.06
HSUPA Subtest-2	21.72	21.82	21.81	18.33	18.53	18.43	18.27	18.36	18.29
HSUPA Subtest-3	21.46	21.58	21.53	18.42	18.62	18.61	18.35	18.37	18.36
HSUPA Subtest-4	22.81	22.92	22.91	18.72	18.93	18.84	18.77	18.77	18.71
HSUPA Subtest-5	23.32	23.44	23.41	19.75	19.79	19.58	19.63	19.68	19.62



## A1. GSM

### Peak-to-Average Ratio

Mode	GSM850		Limit: 13dB
Mod.	GSM	EDGE class 8	Result
Lowest CH	0.32	3.32	PASS
Middle CH	0.32	3.12	
Highest CH	0.32	3.24	

Mode	GSM1900		Limit: 13dB
Mod.	GPRS class 8	EDGE class 8	Result
Lowest CH	0.28	3.24	PASS
Middle CH	0.28	3.24	
Highest CH	0.24	3.40	

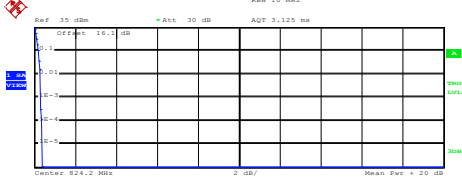
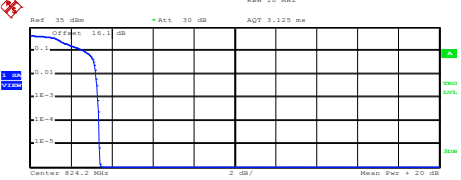
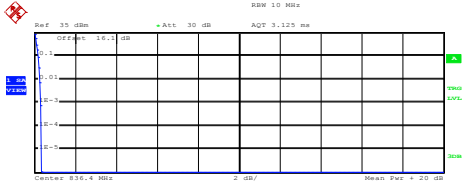
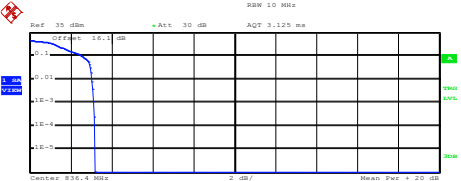
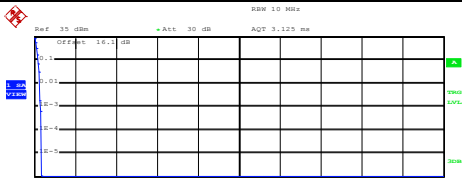
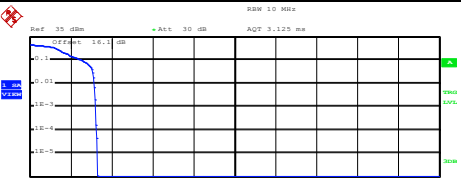

GSM850 (GSM)	GSM850 (EDGE class 8)																
<p align="center"><b>Lowest Channel</b></p>  <p>Center 824.2 MHz    2 dB/    Mean Pwr + 20 dB</p> <p>Complementary Cumulative Distribution Function (100000 samples) Trace 1 Mean 31.20 dBm Peak 31.58 dBm Crest 0.38 dB</p> <table border="1"> <tr><td>10 %</td><td>0.20 dB</td></tr> <tr><td>1 %</td><td>0.28 dB</td></tr> <tr><td>.1 %</td><td>0.32 dB</td></tr> <tr><td>.01 %</td><td>0.36 dB</td></tr> </table> <p>Date: 21.AUG.2015 09:34:11</p>	10 %	0.20 dB	1 %	0.28 dB	.1 %	0.32 dB	.01 %	0.36 dB	<p align="center"><b>Lowest Channel</b></p>  <p>Center 824.2 MHz    2 dB/    Mean Pwr + 20 dB</p> <p>Complementary Cumulative Distribution Function (100000 samples) Trace 1 Mean 25.60 dBm Peak 29.04 dBm Crest 3.44 dB</p> <table border="1"> <tr><td>10 %</td><td>2.68 dB</td></tr> <tr><td>1 %</td><td>3.24 dB</td></tr> <tr><td>.1 %</td><td>3.32 dB</td></tr> <tr><td>.01 %</td><td>3.40 dB</td></tr> </table> <p>Date: 21.AUG.2015 09:47:35</p>	10 %	2.68 dB	1 %	3.24 dB	.1 %	3.32 dB	.01 %	3.40 dB
10 %	0.20 dB																
1 %	0.28 dB																
.1 %	0.32 dB																
.01 %	0.36 dB																
10 %	2.68 dB																
1 %	3.24 dB																
.1 %	3.32 dB																
.01 %	3.40 dB																
<p align="center"><b>Middle Channel</b></p>  <p>Center 836.4 MHz    2 dB/    Mean Pwr + 20 dB</p> <p>Complementary Cumulative Distribution Function (100000 samples) Trace 1 Mean 31.26 dBm Peak 31.58 dBm Crest 0.32 dB</p> <table border="1"> <tr><td>10 %</td><td>0.20 dB</td></tr> <tr><td>1 %</td><td>0.28 dB</td></tr> <tr><td>.1 %</td><td>0.32 dB</td></tr> <tr><td>.01 %</td><td>0.36 dB</td></tr> </table> <p>Date: 21.AUG.2015 09:34:21</p>	10 %	0.20 dB	1 %	0.28 dB	.1 %	0.32 dB	.01 %	0.36 dB	<p align="center"><b>Middle Channel</b></p>  <p>Center 836.4 MHz    2 dB/    Mean Pwr + 20 dB</p> <p>Complementary Cumulative Distribution Function (100000 samples) Trace 1 Mean 26.09 dBm Peak 29.26 dBm Crest 3.17 dB</p> <table border="1"> <tr><td>10 %</td><td>2.56 dB</td></tr> <tr><td>1 %</td><td>3.04 dB</td></tr> <tr><td>.1 %</td><td>3.12 dB</td></tr> <tr><td>.01 %</td><td>3.20 dB</td></tr> </table> <p>Date: 21.AUG.2015 09:47:47</p>	10 %	2.56 dB	1 %	3.04 dB	.1 %	3.12 dB	.01 %	3.20 dB
10 %	0.20 dB																
1 %	0.28 dB																
.1 %	0.32 dB																
.01 %	0.36 dB																
10 %	2.56 dB																
1 %	3.04 dB																
.1 %	3.12 dB																
.01 %	3.20 dB																
<p align="center"><b>Highest Channel</b></p>  <p>Center 848.8 MHz    2 dB/    Mean Pwr + 20 dB</p> <p>Complementary Cumulative Distribution Function (100000 samples) Trace 1 Mean 31.10 dBm Peak 31.44 dBm Crest 0.34 dB</p> <table border="1"> <tr><td>10 %</td><td>0.20 dB</td></tr> <tr><td>1 %</td><td>0.28 dB</td></tr> <tr><td>.1 %</td><td>0.32 dB</td></tr> <tr><td>.01 %</td><td>0.36 dB</td></tr> </table> <p>Date: 21.AUG.2015 09:34:35</p>	10 %	0.20 dB	1 %	0.28 dB	.1 %	0.32 dB	.01 %	0.36 dB	<p align="center"><b>Highest Channel</b></p>  <p>Center 848.8 MHz    2 dB/    Mean Pwr + 20 dB</p> <p>Complementary Cumulative Distribution Function (100000 samples) Trace 1 Mean 25.88 dBm Peak 29.19 dBm Crest 3.31 dB</p> <table border="1"> <tr><td>10 %</td><td>2.56 dB</td></tr> <tr><td>1 %</td><td>3.16 dB</td></tr> <tr><td>.1 %</td><td>3.24 dB</td></tr> <tr><td>.01 %</td><td>3.28 dB</td></tr> </table> <p>Date: 21.AUG.2015 09:48:00</p>	10 %	2.56 dB	1 %	3.16 dB	.1 %	3.24 dB	.01 %	3.28 dB
10 %	0.20 dB																
1 %	0.28 dB																
.1 %	0.32 dB																
.01 %	0.36 dB																
10 %	2.56 dB																
1 %	3.16 dB																
.1 %	3.24 dB																
.01 %	3.28 dB																



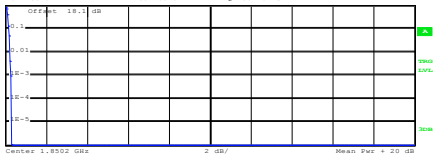
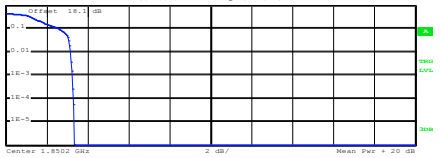
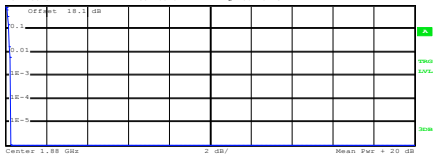
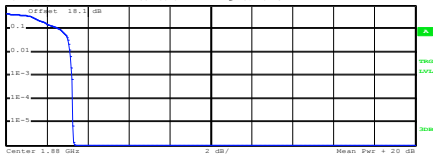
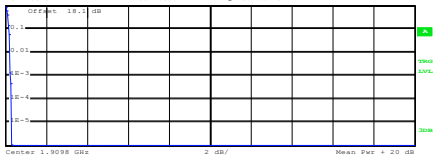
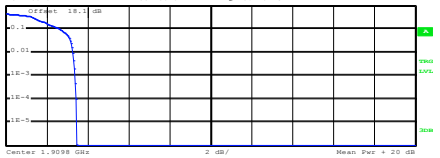

GSM1900 (GPRS class 8)	GSM1900 (EDGE class 8)																
<p align="center"><b>Lowest Channel</b></p>  <p>Center 1.8502 GHz    2 dB/    Mean Pwr + 20 dB</p> <p>Complementary Cumulative Distribution Function (100000 samples) Trace 1 Mean 27.98 dBm Peak 28.27 dBm Crest 0.29 dB</p> <table border="1"> <tr><td>10 %</td><td>0.16 dB</td></tr> <tr><td>1 %</td><td>0.24 dB</td></tr> <tr><td>.1 %</td><td>0.28 dB</td></tr> <tr><td>.01 %</td><td>0.32 dB</td></tr> </table> <p>Date: 21.AUG.2015 09:59:47</p>	10 %	0.16 dB	1 %	0.24 dB	.1 %	0.28 dB	.01 %	0.32 dB	<p align="center"><b>Lowest Channel</b></p>  <p>Center 1.8502 GHz    2 dB/    Mean Pwr + 20 dB</p> <p>Complementary Cumulative Distribution Function (100000 samples) Trace 1 Mean 24.87 dBm Peak 28.20 dBm Crest 3.32 dB</p> <table border="1"> <tr><td>10 %</td><td>2.64 dB</td></tr> <tr><td>1 %</td><td>3.16 dB</td></tr> <tr><td>.1 %</td><td>3.24 dB</td></tr> <tr><td>.01 %</td><td>3.32 dB</td></tr> </table> <p>Date: 21.AUG.2015 10:09:36</p>	10 %	2.64 dB	1 %	3.16 dB	.1 %	3.24 dB	.01 %	3.32 dB
10 %	0.16 dB																
1 %	0.24 dB																
.1 %	0.28 dB																
.01 %	0.32 dB																
10 %	2.64 dB																
1 %	3.16 dB																
.1 %	3.24 dB																
.01 %	3.32 dB																
<p align="center"><b>Middle Channel</b></p>  <p>Center 1.88 GHz    2 dB/    Mean Pwr + 20 dB</p> <p>Complementary Cumulative Distribution Function (100000 samples) Trace 1 Mean 27.72 dBm Peak 27.99 dBm Crest 0.26 dB</p> <table border="1"> <tr><td>10 %</td><td>0.16 dB</td></tr> <tr><td>1 %</td><td>0.24 dB</td></tr> <tr><td>.1 %</td><td>0.28 dB</td></tr> <tr><td>.01 %</td><td>0.28 dB</td></tr> </table> <p>Date: 21.AUG.2015 09:59:59</p>	10 %	0.16 dB	1 %	0.24 dB	.1 %	0.28 dB	.01 %	0.28 dB	<p align="center"><b>Middle Channel</b></p>  <p>Center 1.88 GHz    2 dB/    Mean Pwr + 20 dB</p> <p>Complementary Cumulative Distribution Function (100000 samples) Trace 1 Mean 24.66 dBm Peak 27.99 dBm Crest 3.32 dB</p> <table border="1"> <tr><td>10 %</td><td>2.64 dB</td></tr> <tr><td>1 %</td><td>3.12 dB</td></tr> <tr><td>.1 %</td><td>3.24 dB</td></tr> <tr><td>.01 %</td><td>3.28 dB</td></tr> </table> <p>Date: 21.AUG.2015 10:09:48</p>	10 %	2.64 dB	1 %	3.12 dB	.1 %	3.24 dB	.01 %	3.28 dB
10 %	0.16 dB																
1 %	0.24 dB																
.1 %	0.28 dB																
.01 %	0.28 dB																
10 %	2.64 dB																
1 %	3.12 dB																
.1 %	3.24 dB																
.01 %	3.28 dB																
<p align="center"><b>Highest Channel</b></p>  <p>Center 1.9098 GHz    2 dB/    Mean Pwr + 20 dB</p> <p>Complementary Cumulative Distribution Function (100000 samples) Trace 1 Mean 27.54 dBm Peak 27.84 dBm Crest 0.30 dB</p> <table border="1"> <tr><td>10 %</td><td>0.20 dB</td></tr> <tr><td>1 %</td><td>0.24 dB</td></tr> <tr><td>.1 %</td><td>0.24 dB</td></tr> <tr><td>.01 %</td><td>0.32 dB</td></tr> </table> <p>Date: 21.AUG.2015 10:00:12</p>	10 %	0.20 dB	1 %	0.24 dB	.1 %	0.24 dB	.01 %	0.32 dB	<p align="center"><b>Highest Channel</b></p>  <p>Center 1.9098 GHz    2 dB/    Mean Pwr + 20 dB</p> <p>Complementary Cumulative Distribution Function (100000 samples) Trace 1 Mean 24.44 dBm Peak 27.92 dBm Crest 3.47 dB</p> <table border="1"> <tr><td>10 %</td><td>2.64 dB</td></tr> <tr><td>1 %</td><td>3.28 dB</td></tr> <tr><td>.1 %</td><td>3.40 dB</td></tr> <tr><td>.01 %</td><td>3.44 dB</td></tr> </table> <p>Date: 21.AUG.2015 10:10:02</p>	10 %	2.64 dB	1 %	3.28 dB	.1 %	3.40 dB	.01 %	3.44 dB
10 %	0.20 dB																
1 %	0.24 dB																
.1 %	0.24 dB																
.01 %	0.32 dB																
10 %	2.64 dB																
1 %	3.28 dB																
.1 %	3.40 dB																
.01 %	3.44 dB																



**26dB Bandwidth**

Mode	GSM850	
Mod.	GSM	EDGE class 8
Lowest CH	0.314	0.297
Middle CH	0.299	0.300
Highest CH	0.314	0.293

Mode	GSM1900	
Mod.	GPRS class 8	EDGE class 8
Lowest CH	0.304	0.299
Middle CH	0.315	0.310
Highest CH	0.306	0.306



GSM850 (GSM)

Lowest Channel

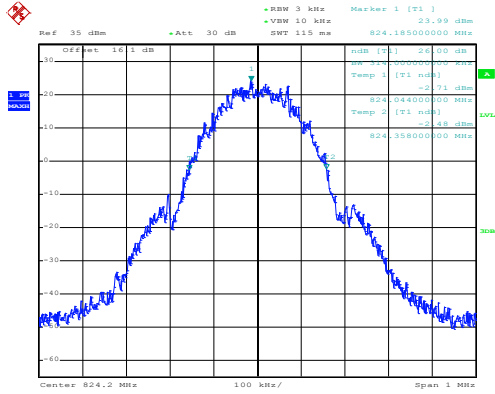

Date: 21.AUG.2015 09:25:18

GSM850 (EDGE class 8)

Lowest Channel

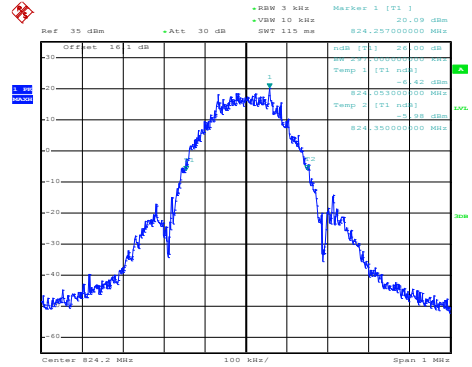

Date: 21.AUG.2015 09:39:50

Middle Channel

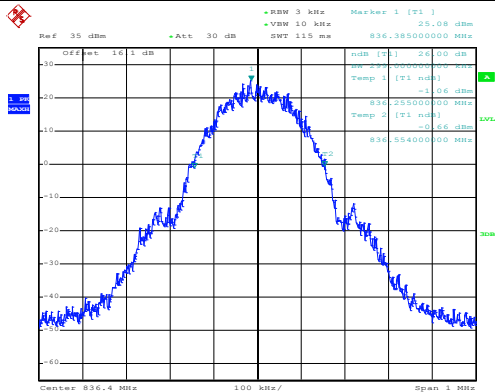

Date: 21.AUG.2015 09:25:46

Middle Channel

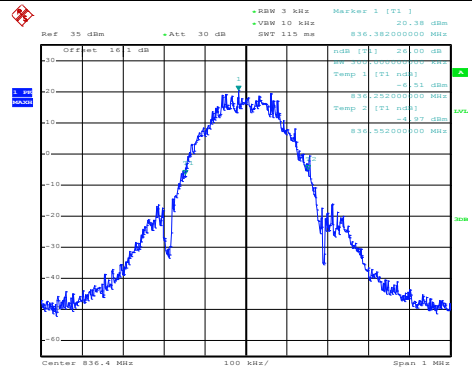

Date: 21.AUG.2015 09:40:19

Highest Channel

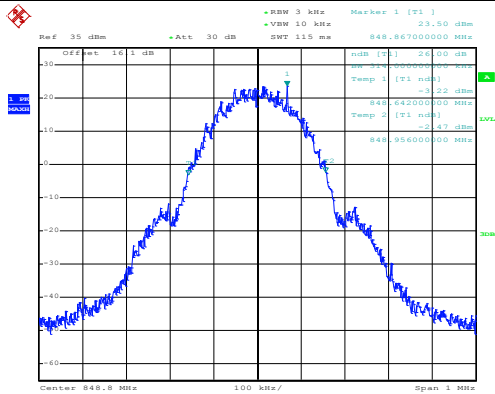

Date: 21.AUG.2015 09:26:14

Highest Channel

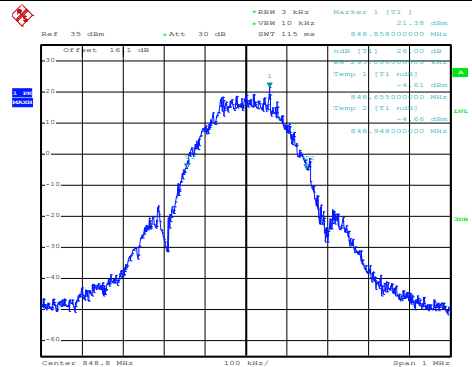

Date: 21.AUG.2015 09:40:47

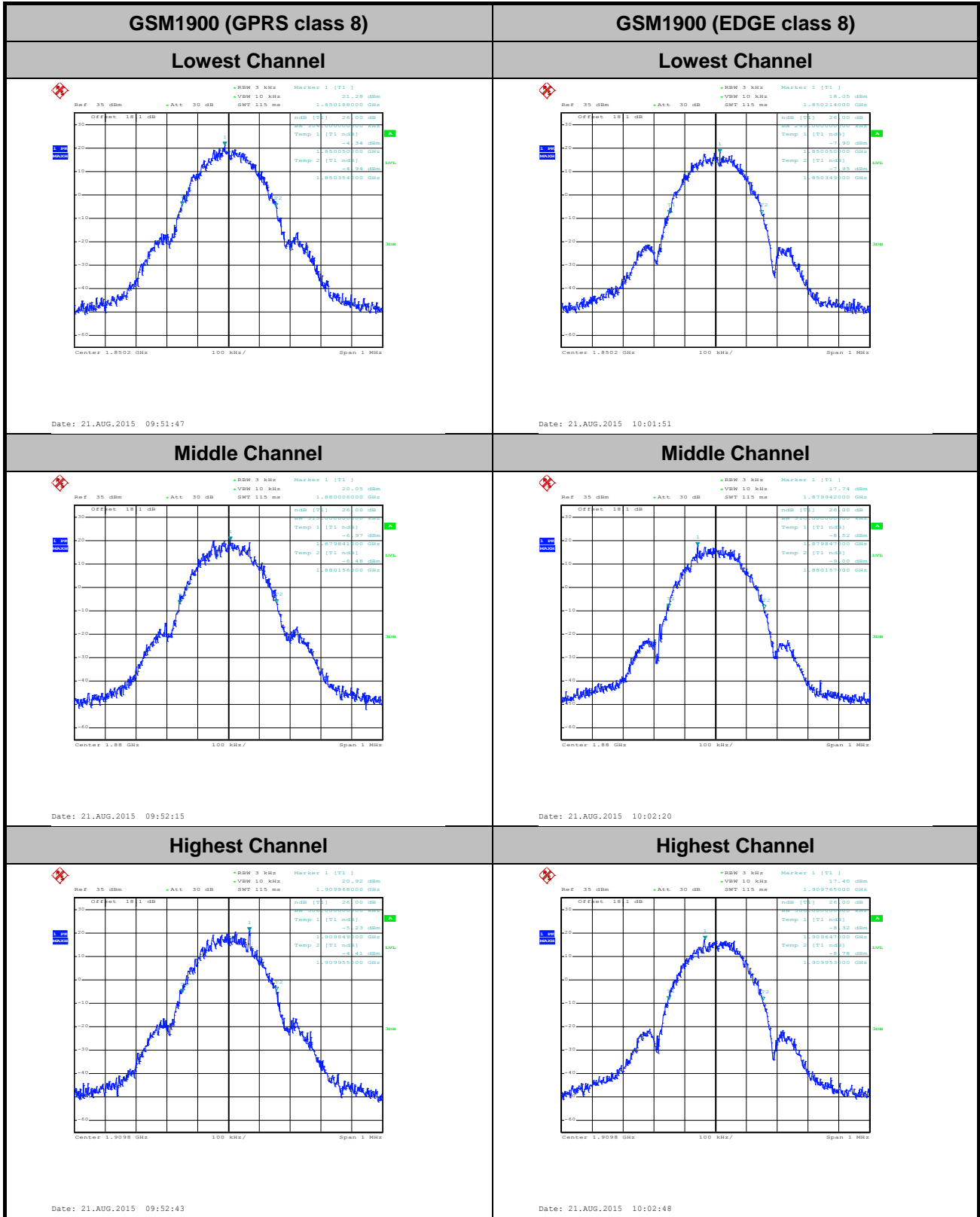



### Occupied Bandwidth

Mode	GSM850	
Mod.	GSM	EDGE class 8
Lowest CH	0.242	0.248
Middle CH	0.244	0.242
Highest CH	0.242	0.244

Mode	GSM1900	
Mod.	GPRS class 8	EDGE class 8
Lowest CH	0.245	0.244
Middle CH	0.243	0.245
Highest CH	0.242	0.245



GSM850 (GSM)

Lowest Channel

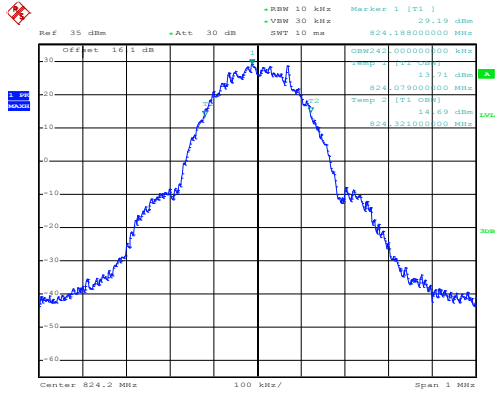

Date: 21.AUG.2015 09:27:20

GSM850 (EDGE class 8)

Lowest Channel

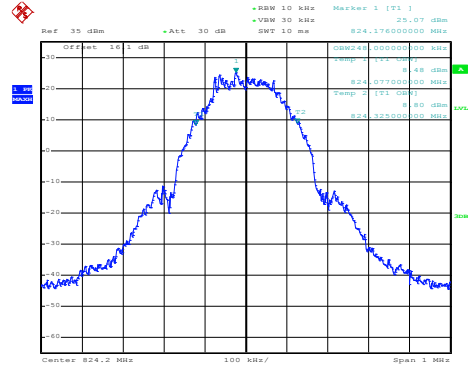

Date: 21.AUG.2015 09:41:24

Middle Channel

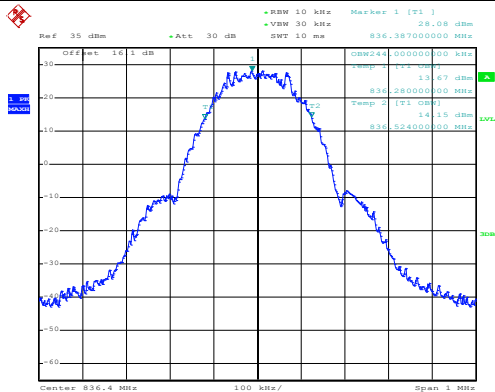

Date: 21.AUG.2015 09:27:48

Middle Channel

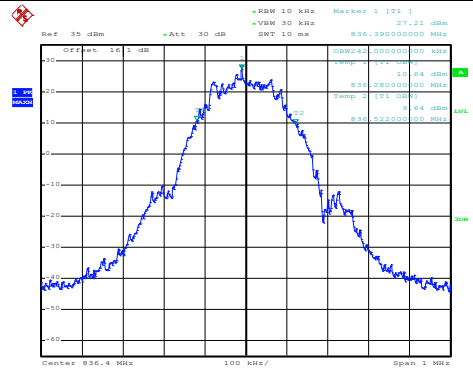

Date: 21.AUG.2015 09:41:52

Highest Channel

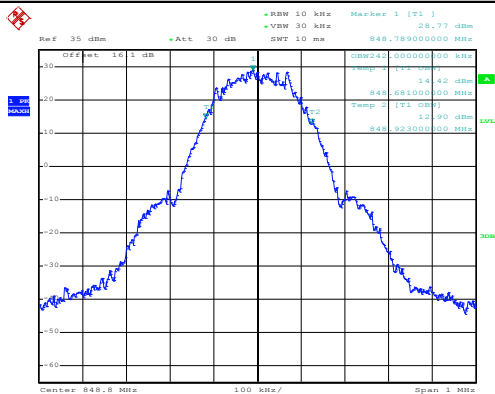

Date: 21.AUG.2015 09:28:16

Highest Channel

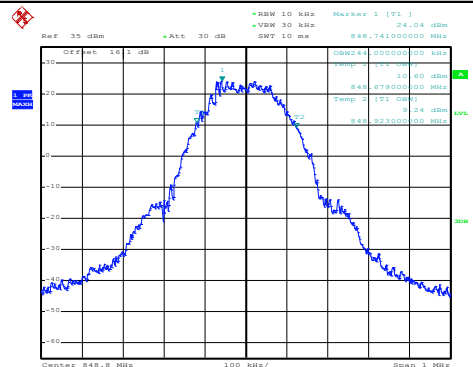

Date: 21.AUG.2015 09:42:20

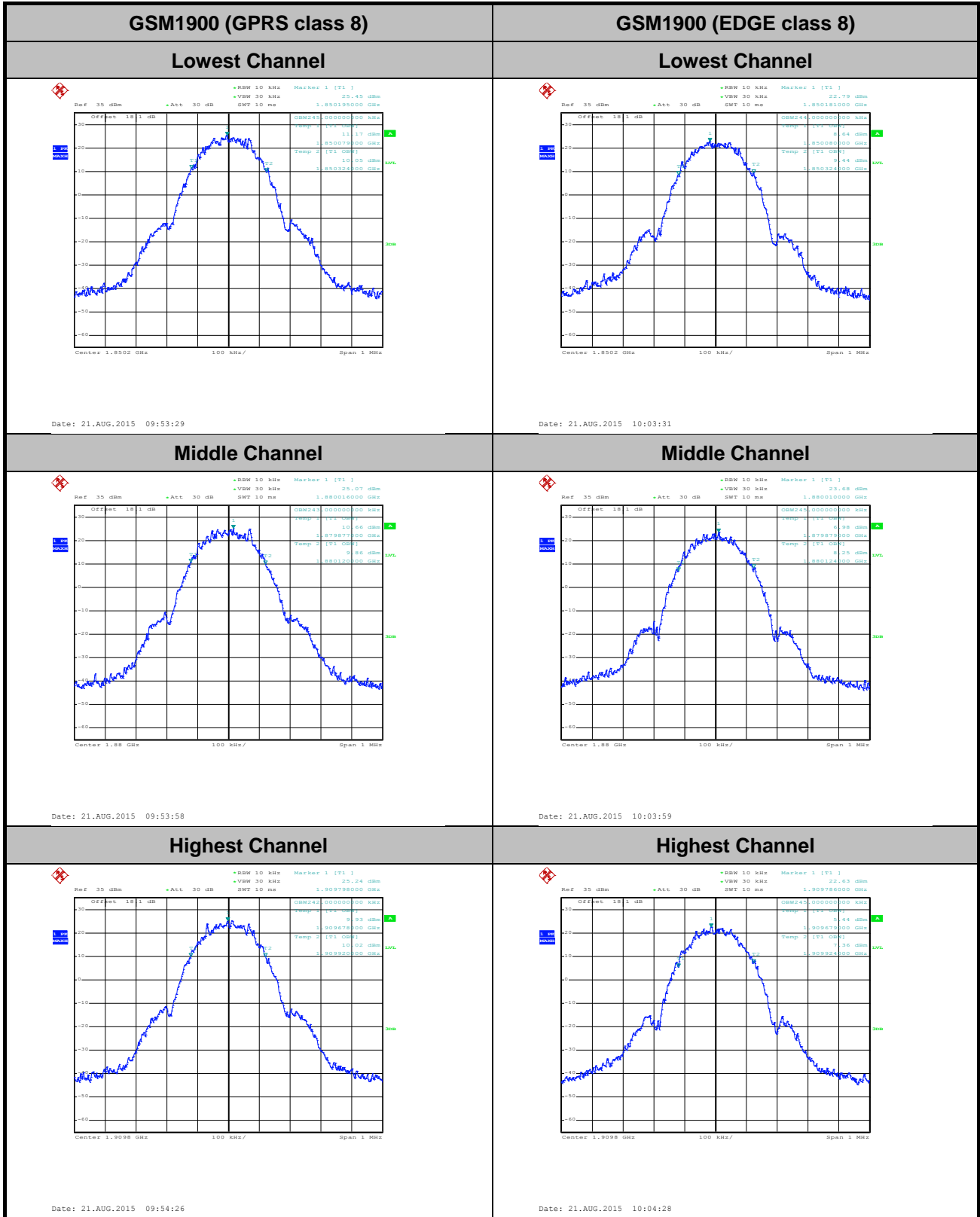



# Conducted Band Edge

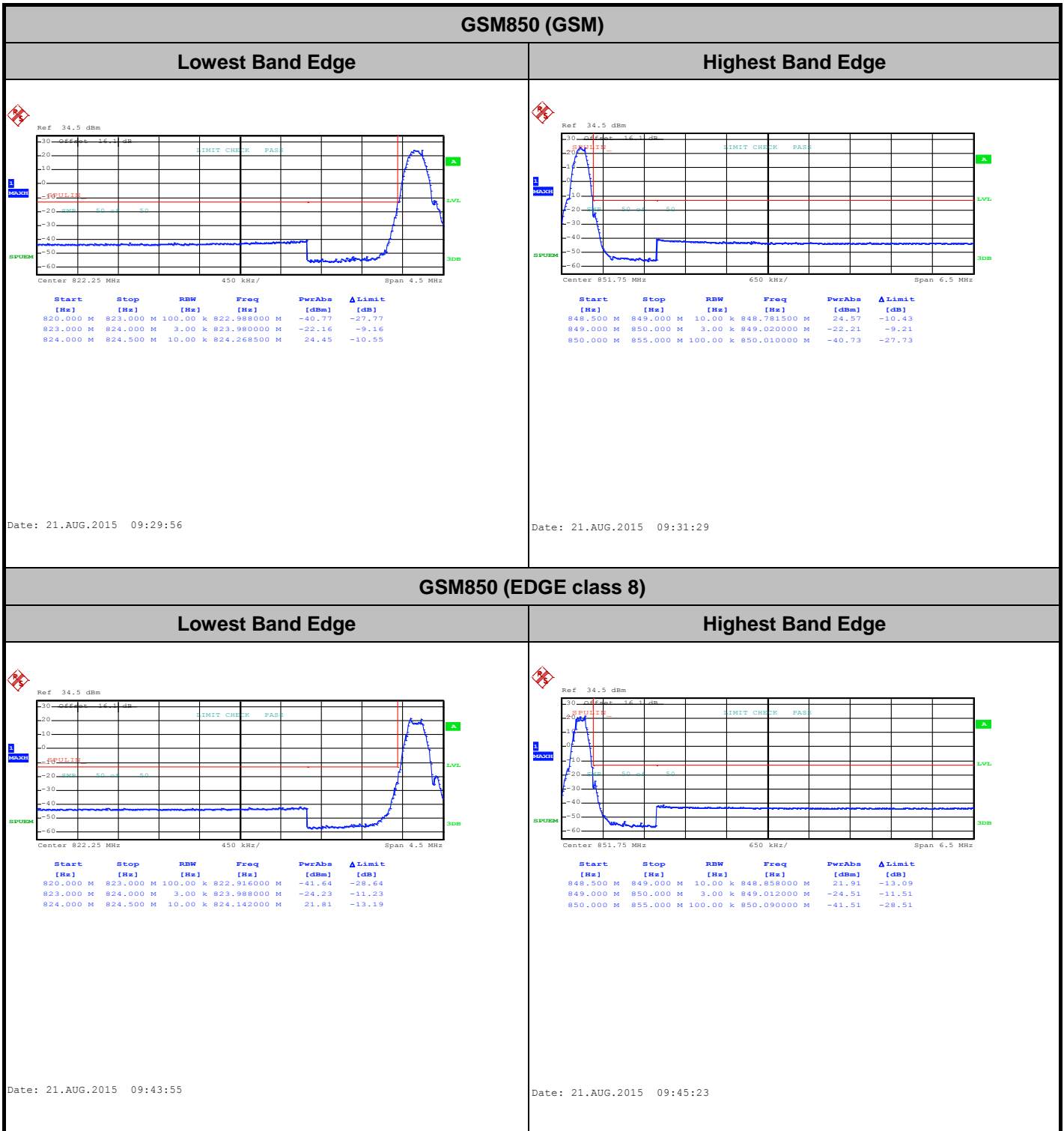





GSM1900 (GPRS class 8)

Lowest Band Edge

Highest Band Edge

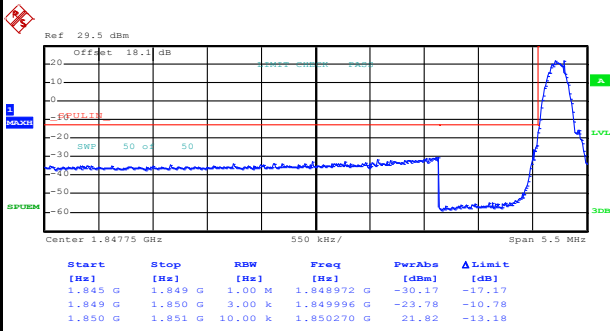

Date: 21.AUG.2015 09:56:04

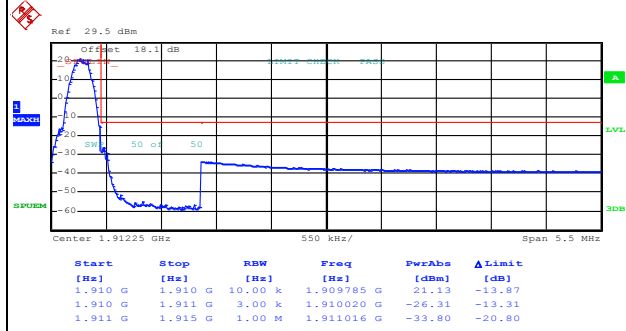

Date: 21.AUG.2015 09:57:31

GSM1900 (EDGE class 8)

Lowest Band Edge

Highest Band Edge

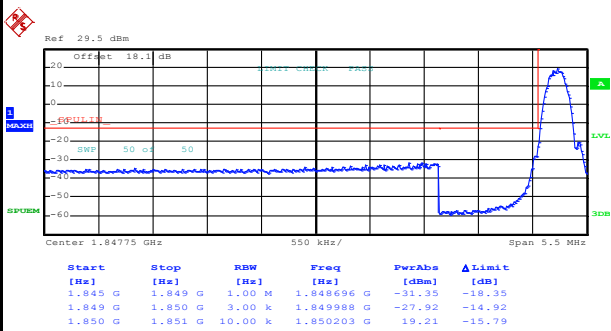

Date: 21.AUG.2015 10:06:06

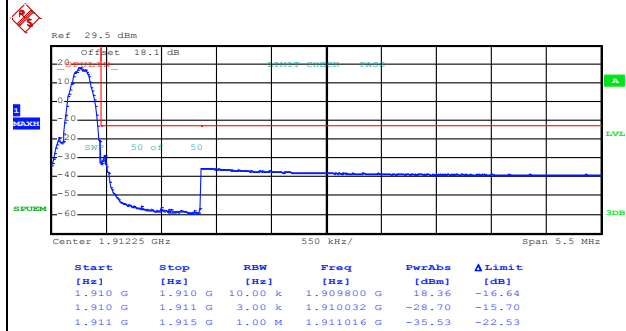

Date: 21.AUG.2015 10:07:33

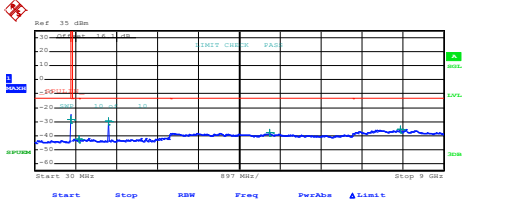
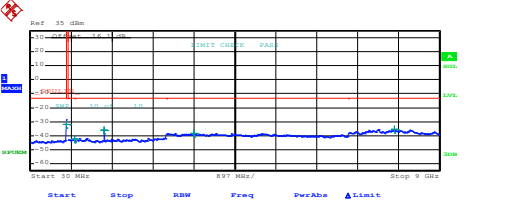
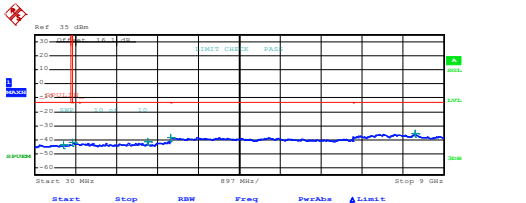
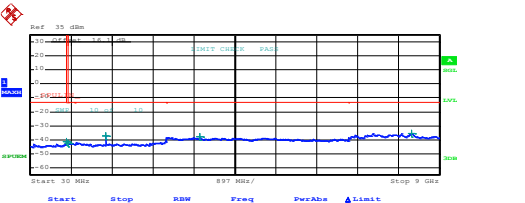
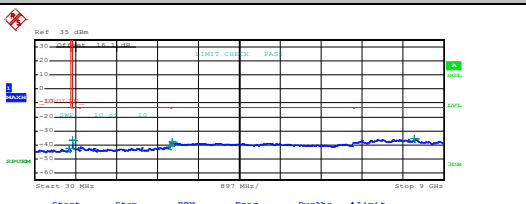
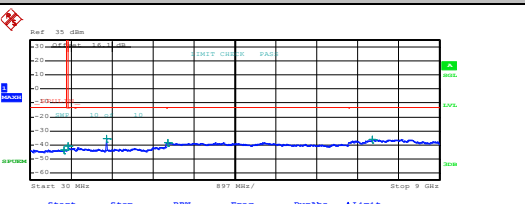

# Conducted Spurious Emission

GSM850 (GSM)	GSM850 (EDGE class 8)																																																																																				
<p style="text-align: center;"><b>Lowest Channel</b></p>  <table border="1" data-bbox="207 649 734 739"> <thead> <tr> <th>Start [Hz]</th> <th>Stop [Hz]</th> <th>RBW [Hz]</th> <th>Freq [Hz]</th> <th>Power [dBm]</th> <th>Limit [dBm]</th> <th>ΔLimit [dB]</th> </tr> </thead> <tbody> <tr><td>30.000 M</td><td>820.000 M</td><td>1.00 M</td><td>810.802500 M</td><td>-28.36</td><td>-25.36</td><td></td></tr> <tr><td>835.000 M</td><td>1.000 G</td><td>1.00 M</td><td>990.502500 M</td><td>-42.25</td><td>-29.25</td><td></td></tr> <tr><td>1.000 G</td><td>3.000 G</td><td>1.00 M</td><td>1.648500 G</td><td>-29.38</td><td>-26.38</td><td></td></tr> <tr><td>3.000 G</td><td>7.000 G</td><td>1.00 M</td><td>5.172000 G</td><td>-37.92</td><td>-24.92</td><td></td></tr> <tr><td>7.000 G</td><td>9.000 G</td><td>1.00 M</td><td>8.051000 G</td><td>-35.58</td><td>-22.58</td><td></td></tr> </tbody> </table> <p>Date: 21.AUG.2015 09:32:42</p>	Start [Hz]	Stop [Hz]	RBW [Hz]	Freq [Hz]	Power [dBm]	Limit [dBm]	ΔLimit [dB]	30.000 M	820.000 M	1.00 M	810.802500 M	-28.36	-25.36		835.000 M	1.000 G	1.00 M	990.502500 M	-42.25	-29.25		1.000 G	3.000 G	1.00 M	1.648500 G	-29.38	-26.38		3.000 G	7.000 G	1.00 M	5.172000 G	-37.92	-24.92		7.000 G	9.000 G	1.00 M	8.051000 G	-35.58	-22.58		<p style="text-align: center;"><b>Lowest Channel</b></p>  <table border="1" data-bbox="861 649 1388 739"> <thead> <tr> <th>Start [Hz]</th> <th>Stop [Hz]</th> <th>RBW [Hz]</th> <th>Freq [Hz]</th> <th>Power [dBm]</th> <th>Limit [dBm]</th> <th>ΔLimit [dB]</th> </tr> </thead> <tbody> <tr><td>30.000 M</td><td>820.000 M</td><td>1.00 M</td><td>810.802500 M</td><td>-28.22</td><td>-25.22</td><td></td></tr> <tr><td>835.000 M</td><td>1.000 G</td><td>1.00 M</td><td>990.466250 M</td><td>-42.29</td><td>-29.29</td><td></td></tr> <tr><td>1.000 G</td><td>3.000 G</td><td>1.00 M</td><td>1.648500 G</td><td>-29.78</td><td>-22.78</td><td></td></tr> <tr><td>3.000 G</td><td>7.000 G</td><td>1.00 M</td><td>3.613000 G</td><td>-38.14</td><td>-25.14</td><td></td></tr> <tr><td>7.000 G</td><td>9.000 G</td><td>1.00 M</td><td>8.014000 G</td><td>-35.27</td><td>-22.27</td><td></td></tr> </tbody> </table> <p>Date: 21.AUG.2015 09:46:01</p>	Start [Hz]	Stop [Hz]	RBW [Hz]	Freq [Hz]	Power [dBm]	Limit [dBm]	ΔLimit [dB]	30.000 M	820.000 M	1.00 M	810.802500 M	-28.22	-25.22		835.000 M	1.000 G	1.00 M	990.466250 M	-42.29	-29.29		1.000 G	3.000 G	1.00 M	1.648500 G	-29.78	-22.78		3.000 G	7.000 G	1.00 M	3.613000 G	-38.14	-25.14		7.000 G	9.000 G	1.00 M	8.014000 G	-35.27	-22.27	
Start [Hz]	Stop [Hz]	RBW [Hz]	Freq [Hz]	Power [dBm]	Limit [dBm]	ΔLimit [dB]																																																																															
30.000 M	820.000 M	1.00 M	810.802500 M	-28.36	-25.36																																																																																
835.000 M	1.000 G	1.00 M	990.502500 M	-42.25	-29.25																																																																																
1.000 G	3.000 G	1.00 M	1.648500 G	-29.38	-26.38																																																																																
3.000 G	7.000 G	1.00 M	5.172000 G	-37.92	-24.92																																																																																
7.000 G	9.000 G	1.00 M	8.051000 G	-35.58	-22.58																																																																																
Start [Hz]	Stop [Hz]	RBW [Hz]	Freq [Hz]	Power [dBm]	Limit [dBm]	ΔLimit [dB]																																																																															
30.000 M	820.000 M	1.00 M	810.802500 M	-28.22	-25.22																																																																																
835.000 M	1.000 G	1.00 M	990.466250 M	-42.29	-29.29																																																																																
1.000 G	3.000 G	1.00 M	1.648500 G	-29.78	-22.78																																																																																
3.000 G	7.000 G	1.00 M	3.613000 G	-38.14	-25.14																																																																																
7.000 G	9.000 G	1.00 M	8.014000 G	-35.27	-22.27																																																																																
<p style="text-align: center;"><b>Middle Channel</b></p>  <table border="1" data-bbox="207 1164 734 1254"> <thead> <tr> <th>Start [Hz]</th> <th>Stop [Hz]</th> <th>RBW [Hz]</th> <th>Freq [Hz]</th> <th>Power [dBm]</th> <th>Limit [dBm]</th> <th>ΔLimit [dB]</th> </tr> </thead> <tbody> <tr><td>30.000 M</td><td>820.000 M</td><td>1.00 M</td><td>855.285000 M</td><td>-43.57</td><td>-30.57</td><td></td></tr> <tr><td>835.000 M</td><td>1.000 G</td><td>1.00 M</td><td>820.488750 M</td><td>-41.79</td><td>-28.79</td><td></td></tr> <tr><td>1.000 G</td><td>3.000 G</td><td>1.00 M</td><td>2.509000 G</td><td>-41.41</td><td>-28.41</td><td></td></tr> <tr><td>3.000 G</td><td>7.000 G</td><td>1.00 M</td><td>3.051600 G</td><td>-38.46</td><td>-25.46</td><td></td></tr> <tr><td>7.000 G</td><td>9.000 G</td><td>1.00 M</td><td>8.375000 G</td><td>-35.70</td><td>-22.70</td><td></td></tr> </tbody> </table> <p>Date: 21.AUG.2015 09:33:12</p>	Start [Hz]	Stop [Hz]	RBW [Hz]	Freq [Hz]	Power [dBm]	Limit [dBm]	ΔLimit [dB]	30.000 M	820.000 M	1.00 M	855.285000 M	-43.57	-30.57		835.000 M	1.000 G	1.00 M	820.488750 M	-41.79	-28.79		1.000 G	3.000 G	1.00 M	2.509000 G	-41.41	-28.41		3.000 G	7.000 G	1.00 M	3.051600 G	-38.46	-25.46		7.000 G	9.000 G	1.00 M	8.375000 G	-35.70	-22.70		<p style="text-align: center;"><b>Middle Channel</b></p>  <table border="1" data-bbox="861 1164 1388 1254"> <thead> <tr> <th>Start [Hz]</th> <th>Stop [Hz]</th> <th>RBW [Hz]</th> <th>Freq [Hz]</th> <th>Power [dBm]</th> <th>Limit [dBm]</th> <th>ΔLimit [dB]</th> </tr> </thead> <tbody> <tr><td>30.000 M</td><td>820.000 M</td><td>1.00 M</td><td>817.235000 M</td><td>-41.57</td><td>-28.57</td><td></td></tr> <tr><td>835.000 M</td><td>1.000 G</td><td>1.00 M</td><td>820.676250 M</td><td>-42.57</td><td>-29.57</td><td></td></tr> <tr><td>1.000 G</td><td>3.000 G</td><td>1.00 M</td><td>1.672500 G</td><td>-36.95</td><td>-23.95</td><td></td></tr> <tr><td>3.000 G</td><td>7.000 G</td><td>1.00 M</td><td>3.750000 G</td><td>-37.95</td><td>-24.95</td><td></td></tr> <tr><td>7.000 G</td><td>9.000 G</td><td>1.00 M</td><td>8.389000 G</td><td>-35.02</td><td>-22.02</td><td></td></tr> </tbody> </table> <p>Date: 21.AUG.2015 09:46:31</p>	Start [Hz]	Stop [Hz]	RBW [Hz]	Freq [Hz]	Power [dBm]	Limit [dBm]	ΔLimit [dB]	30.000 M	820.000 M	1.00 M	817.235000 M	-41.57	-28.57		835.000 M	1.000 G	1.00 M	820.676250 M	-42.57	-29.57		1.000 G	3.000 G	1.00 M	1.672500 G	-36.95	-23.95		3.000 G	7.000 G	1.00 M	3.750000 G	-37.95	-24.95		7.000 G	9.000 G	1.00 M	8.389000 G	-35.02	-22.02	
Start [Hz]	Stop [Hz]	RBW [Hz]	Freq [Hz]	Power [dBm]	Limit [dBm]	ΔLimit [dB]																																																																															
30.000 M	820.000 M	1.00 M	855.285000 M	-43.57	-30.57																																																																																
835.000 M	1.000 G	1.00 M	820.488750 M	-41.79	-28.79																																																																																
1.000 G	3.000 G	1.00 M	2.509000 G	-41.41	-28.41																																																																																
3.000 G	7.000 G	1.00 M	3.051600 G	-38.46	-25.46																																																																																
7.000 G	9.000 G	1.00 M	8.375000 G	-35.70	-22.70																																																																																
Start [Hz]	Stop [Hz]	RBW [Hz]	Freq [Hz]	Power [dBm]	Limit [dBm]	ΔLimit [dB]																																																																															
30.000 M	820.000 M	1.00 M	817.235000 M	-41.57	-28.57																																																																																
835.000 M	1.000 G	1.00 M	820.676250 M	-42.57	-29.57																																																																																
1.000 G	3.000 G	1.00 M	1.672500 G	-36.95	-23.95																																																																																
3.000 G	7.000 G	1.00 M	3.750000 G	-37.95	-24.95																																																																																
7.000 G	9.000 G	1.00 M	8.389000 G	-35.02	-22.02																																																																																
<p style="text-align: center;"><b>Highest Channel</b></p>  <table border="1" data-bbox="207 1680 734 1769"> <thead> <tr> <th>Start [Hz]</th> <th>Stop [Hz]</th> <th>RBW [Hz]</th> <th>Freq [Hz]</th> <th>Power [dBm]</th> <th>Limit [dBm]</th> <th>ΔLimit [dB]</th> </tr> </thead> <tbody> <tr><td>30.000 M</td><td>820.000 M</td><td>1.00 M</td><td>776.583000 M</td><td>-42.71</td><td>-29.71</td><td></td></tr> <tr><td>835.000 M</td><td>1.000 G</td><td>1.00 M</td><td>850.072500 M</td><td>-36.59</td><td>-23.59</td><td></td></tr> <tr><td>1.000 G</td><td>3.000 G</td><td>1.00 M</td><td>2.983000 G</td><td>-40.64</td><td>-27.64</td><td></td></tr> <tr><td>3.000 G</td><td>7.000 G</td><td>1.00 M</td><td>3.051000 G</td><td>-37.97</td><td>-24.97</td><td></td></tr> <tr><td>7.000 G</td><td>9.000 G</td><td>1.00 M</td><td>8.354000 G</td><td>-35.26</td><td>-22.26</td><td></td></tr> </tbody> </table> <p>Date: 21.AUG.2015 09:33:42</p>	Start [Hz]	Stop [Hz]	RBW [Hz]	Freq [Hz]	Power [dBm]	Limit [dBm]	ΔLimit [dB]	30.000 M	820.000 M	1.00 M	776.583000 M	-42.71	-29.71		835.000 M	1.000 G	1.00 M	850.072500 M	-36.59	-23.59		1.000 G	3.000 G	1.00 M	2.983000 G	-40.64	-27.64		3.000 G	7.000 G	1.00 M	3.051000 G	-37.97	-24.97		7.000 G	9.000 G	1.00 M	8.354000 G	-35.26	-22.26		<p style="text-align: center;"><b>Highest Channel</b></p>  <table border="1" data-bbox="861 1680 1388 1769"> <thead> <tr> <th>Start [Hz]</th> <th>Stop [Hz]</th> <th>RBW [Hz]</th> <th>Freq [Hz]</th> <th>Power [dBm]</th> <th>Limit [dBm]</th> <th>ΔLimit [dB]</th> </tr> </thead> <tbody> <tr><td>30.000 M</td><td>820.000 M</td><td>1.00 M</td><td>763.058000 M</td><td>-43.63</td><td>-30.63</td><td></td></tr> <tr><td>835.000 M</td><td>1.000 G</td><td>1.00 M</td><td>850.143000 M</td><td>-40.96</td><td>-27.96</td><td></td></tr> <tr><td>1.000 G</td><td>3.000 G</td><td>1.00 M</td><td>3.698000 G</td><td>-39.51</td><td>-22.51</td><td></td></tr> <tr><td>3.000 G</td><td>7.000 G</td><td>1.00 M</td><td>3.036000 G</td><td>-38.11</td><td>-25.11</td><td></td></tr> <tr><td>7.000 G</td><td>9.000 G</td><td>1.00 M</td><td>7.534000 G</td><td>-35.98</td><td>-22.98</td><td></td></tr> </tbody> </table> <p>Date: 21.AUG.2015 09:47:01</p>	Start [Hz]	Stop [Hz]	RBW [Hz]	Freq [Hz]	Power [dBm]	Limit [dBm]	ΔLimit [dB]	30.000 M	820.000 M	1.00 M	763.058000 M	-43.63	-30.63		835.000 M	1.000 G	1.00 M	850.143000 M	-40.96	-27.96		1.000 G	3.000 G	1.00 M	3.698000 G	-39.51	-22.51		3.000 G	7.000 G	1.00 M	3.036000 G	-38.11	-25.11		7.000 G	9.000 G	1.00 M	7.534000 G	-35.98	-22.98	
Start [Hz]	Stop [Hz]	RBW [Hz]	Freq [Hz]	Power [dBm]	Limit [dBm]	ΔLimit [dB]																																																																															
30.000 M	820.000 M	1.00 M	776.583000 M	-42.71	-29.71																																																																																
835.000 M	1.000 G	1.00 M	850.072500 M	-36.59	-23.59																																																																																
1.000 G	3.000 G	1.00 M	2.983000 G	-40.64	-27.64																																																																																
3.000 G	7.000 G	1.00 M	3.051000 G	-37.97	-24.97																																																																																
7.000 G	9.000 G	1.00 M	8.354000 G	-35.26	-22.26																																																																																
Start [Hz]	Stop [Hz]	RBW [Hz]	Freq [Hz]	Power [dBm]	Limit [dBm]	ΔLimit [dB]																																																																															
30.000 M	820.000 M	1.00 M	763.058000 M	-43.63	-30.63																																																																																
835.000 M	1.000 G	1.00 M	850.143000 M	-40.96	-27.96																																																																																
1.000 G	3.000 G	1.00 M	3.698000 G	-39.51	-22.51																																																																																
3.000 G	7.000 G	1.00 M	3.036000 G	-38.11	-25.11																																																																																
7.000 G	9.000 G	1.00 M	7.534000 G	-35.98	-22.98																																																																																



GSM1900 (GPRS class 8)

GSM1900 (EDGE class 8)

Lowest Channel

Lowest Channel

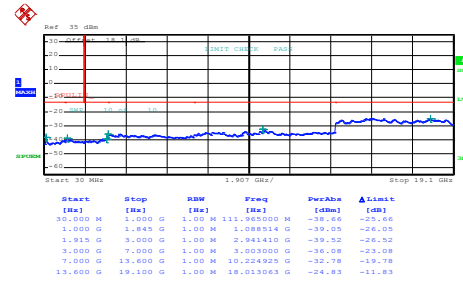
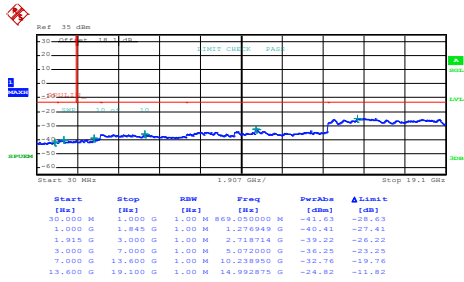

Date: 21.AUG.2015 09:58:21

Date: 21.AUG.2015 10:08:16

Middle Channel

Middle Channel

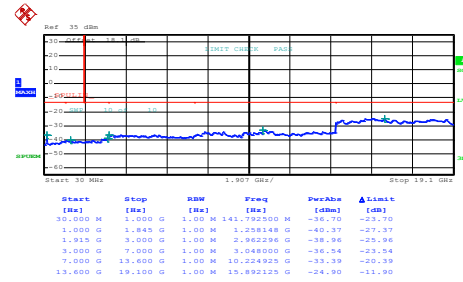
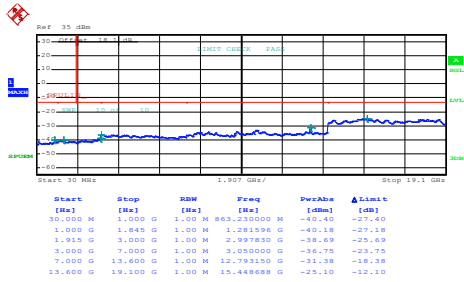

Date: 21.AUG.2015 09:58:51

Date: 21.AUG.2015 10:08:46

Highest Channel

Highest Channel

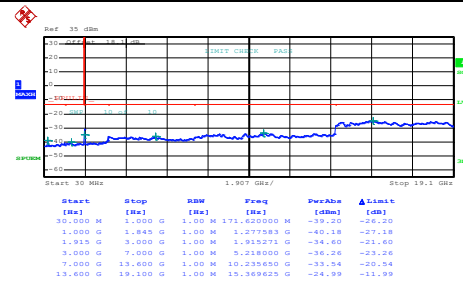
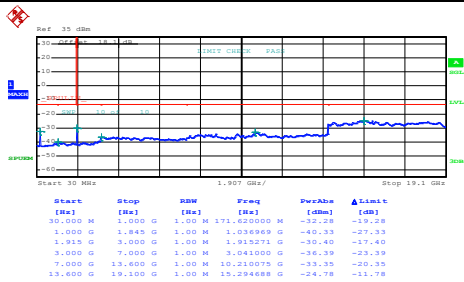

Date: 21.AUG.2015 09:59:21

Date: 21.AUG.2015 10:09:16



**Frequency Stability**

Test Conditions	Middle Channel	GSM850 (GSM)	GSM850 (EDGE class 8)	Limit
Temperature (°C)	Voltage (Volt)	Deviation (ppm)		2.5ppm
				Result
50	Normal Voltage	0.0012	0.0060	PASS
40	Normal Voltage	0.0060	0.0012	
30	Normal Voltage	0.0036	0.0072	
20(Ref.)	Normal Voltage	0.0000	0.0000	
10	Normal Voltage	0.0036	0.0036	
0	Normal Voltage	0.0060	0.0012	
-10	Normal Voltage	0.0024	0.0036	
-20	Normal Voltage	0.0048	0.0108	
-30	Normal Voltage	0.0132	0.0096	
20	Maximum Voltage	0.0012	0.0024	
20	Normal Voltage	0.0024	0.0048	
20	Battery End Point	0.0299	0.0024	

Test Conditions	Middle Channel	GSM1900 (GPRS class 8)	GSM1900 (EDGE class 8)	Limit
Temperature (°C)	Voltage (Volt)	Deviation (ppm)		Note 2.
				Result
50	Normal Voltage	0.0096	0.0064	PASS
40	Normal Voltage	0.0080	0.0032	
30	Normal Voltage	0.0032	0.0021	
20(Ref.)	Normal Voltage	0.0000	0.0000	
10	Normal Voltage	0.0011	0.0016	
0	Normal Voltage	0.0053	0.0011	
-10	Normal Voltage	0.0043	0.0112	
-20	Normal Voltage	0.0165	0.0043	
-30	Normal Voltage	0.0112	0.0090	
20	Maximum Voltage	0.0005	0.0005	
20	Normal Voltage	0.0016	0.0005	
20	Battery End Point	0.0037	0.0037	

**Note:**

1. Normal Voltage = 3.8V. ; Battery End Point (BEP) = 3.6 V. ; Maximum Voltage =4.2 V
2. The frequency fundamental emissions stay within the authorized frequency block.





## A2. WCDMA

### Peak-to-Average Ratio

Mode	WCDMA Band V	WCDMA Band II	WCDMA Band IV	Limit: 13dB
Mod.	RMC 12.2Kbps	RMC 12.2Kbps	RMC 12.2Kbps	Result
Lowest CH	3.04	3.16	3.12	<b>PASS</b>
Middle CH	3.28	3.08	3.12	
Highest CH	2.88	3.16	3.04	

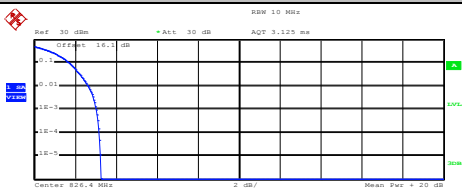
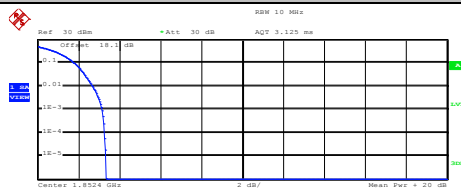
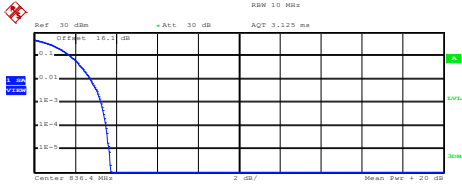
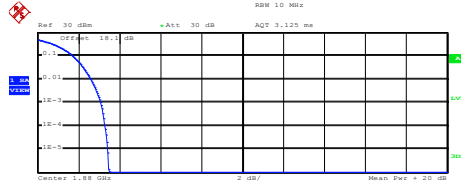

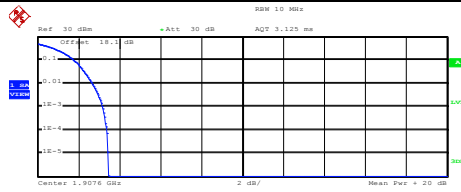
WCDMA Band V (RMC 12.2Kbps)	WCDMA Band II (RMC 12.2Kbps)																
<p style="text-align: center;"><b>Lowest Channel</b></p>  <p>Center 826.4 MHz    2 dB/    Mean Pwr + 20 dB</p> <p>Complementary Cumulative Distribution Function (100000 samples) Trace 1 Mean 19.92 dBm Peak 23.20 dBm Crest 3.28 dB</p> <table border="1"> <tr><td>10 %</td><td>1.72 dB</td></tr> <tr><td>1 %</td><td>2.64 dB</td></tr> <tr><td>.1 %</td><td>3.04 dB</td></tr> <tr><td>.01 %</td><td>3.20 dB</td></tr> </table> <p>Date: 21.AUG.2015 10:21:52</p>	10 %	1.72 dB	1 %	2.64 dB	.1 %	3.04 dB	.01 %	3.20 dB	<p style="text-align: center;"><b>Lowest Channel</b></p>  <p>Center 1.8524 GHz    2 dB/    Mean Pwr + 20 dB</p> <p>Complementary Cumulative Distribution Function (100000 samples) Trace 1 Mean 19.72 dBm Peak 23.06 dBm Crest 3.33 dB</p> <table border="1"> <tr><td>10 %</td><td>1.80 dB</td></tr> <tr><td>1 %</td><td>2.68 dB</td></tr> <tr><td>.1 %</td><td>3.16 dB</td></tr> <tr><td>.01 %</td><td>3.28 dB</td></tr> </table> <p>Date: 21.AUG.2015 10:33:57</p>	10 %	1.80 dB	1 %	2.68 dB	.1 %	3.16 dB	.01 %	3.28 dB
10 %	1.72 dB																
1 %	2.64 dB																
.1 %	3.04 dB																
.01 %	3.20 dB																
10 %	1.80 dB																
1 %	2.68 dB																
.1 %	3.16 dB																
.01 %	3.28 dB																
<p style="text-align: center;"><b>Middle Channel</b></p>  <p>Center 830.4 MHz    2 dB/    Mean Pwr + 20 dB</p> <p>Complementary Cumulative Distribution Function (100000 samples) Trace 1 Mean 19.89 dBm Peak 23.62 dBm Crest 3.73 dB</p> <table border="1"> <tr><td>10 %</td><td>1.76 dB</td></tr> <tr><td>1 %</td><td>2.76 dB</td></tr> <tr><td>.1 %</td><td>3.28 dB</td></tr> <tr><td>.01 %</td><td>3.52 dB</td></tr> </table> <p>Date: 21.AUG.2015 10:22:01</p>	10 %	1.76 dB	1 %	2.76 dB	.1 %	3.28 dB	.01 %	3.52 dB	<p style="text-align: center;"><b>Middle Channel</b></p>  <p>Center 1.88 GHz    2 dB/    Mean Pwr + 20 dB</p> <p>Complementary Cumulative Distribution Function (100000 samples) Trace 1 Mean 20.77 dBm Peak 24.26 dBm Crest 3.48 dB</p> <table border="1"> <tr><td>10 %</td><td>1.72 dB</td></tr> <tr><td>1 %</td><td>2.60 dB</td></tr> <tr><td>.1 %</td><td>3.08 dB</td></tr> <tr><td>.01 %</td><td>3.28 dB</td></tr> </table> <p>Date: 21.AUG.2015 10:34:06</p>	10 %	1.72 dB	1 %	2.60 dB	.1 %	3.08 dB	.01 %	3.28 dB
10 %	1.76 dB																
1 %	2.76 dB																
.1 %	3.28 dB																
.01 %	3.52 dB																
10 %	1.72 dB																
1 %	2.60 dB																
.1 %	3.08 dB																
.01 %	3.28 dB																
<p style="text-align: center;"><b>Highest Channel</b></p>  <p>Center 846.6 MHz    2 dB/    Mean Pwr + 20 dB</p> <p>Complementary Cumulative Distribution Function (100000 samples) Trace 1 Mean 19.91 dBm Peak 23.13 dBm Crest 3.22 dB</p> <table border="1"> <tr><td>10 %</td><td>1.64 dB</td></tr> <tr><td>1 %</td><td>2.40 dB</td></tr> <tr><td>.1 %</td><td>2.88 dB</td></tr> <tr><td>.01 %</td><td>3.08 dB</td></tr> </table> <p>Date: 21.AUG.2015 10:22:11</p>	10 %	1.64 dB	1 %	2.40 dB	.1 %	2.88 dB	.01 %	3.08 dB	<p style="text-align: center;"><b>Highest Channel</b></p>  <p>Center 1.9076 GHz    2 dB/    Mean Pwr + 20 dB</p> <p>Complementary Cumulative Distribution Function (100000 samples) Trace 1 Mean 20.18 dBm Peak 23.62 dBm Crest 3.44 dB</p> <table border="1"> <tr><td>10 %</td><td>1.76 dB</td></tr> <tr><td>1 %</td><td>2.68 dB</td></tr> <tr><td>.1 %</td><td>3.16 dB</td></tr> <tr><td>.01 %</td><td>3.40 dB</td></tr> </table> <p>Date: 21.AUG.2015 10:34:15</p>	10 %	1.76 dB	1 %	2.68 dB	.1 %	3.16 dB	.01 %	3.40 dB
10 %	1.64 dB																
1 %	2.40 dB																
.1 %	2.88 dB																
.01 %	3.08 dB																
10 %	1.76 dB																
1 %	2.68 dB																
.1 %	3.16 dB																
.01 %	3.40 dB																



WCDMA Band IV (RMC 12.2Kbps)

Lowest Channel

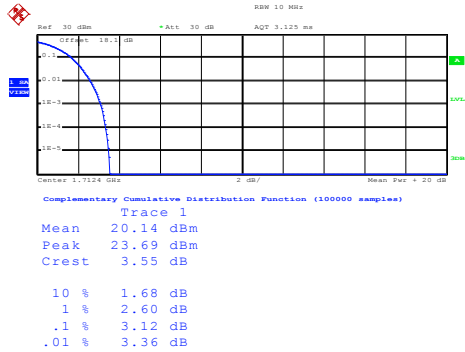

Date: 21.AUG.2015 10:44:14

Middle Channel

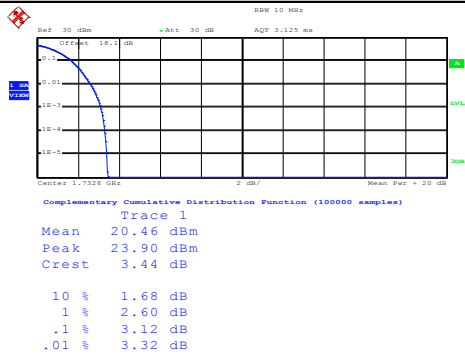

Date: 21.AUG.2015 10:44:23

Highest Channel

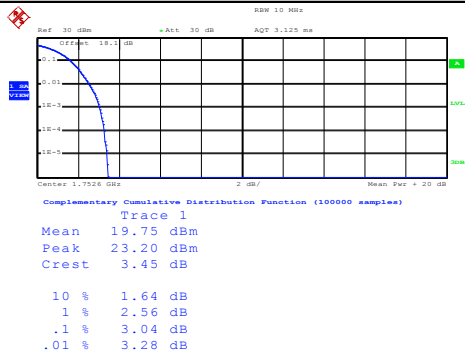

Date: 21.AUG.2015 10:44:32



**26dB Bandwidth**

Mode	WCDMA Band V	WCDMA Band II	WCDMA Band IV
Mod.	RMC 12.2Kbps	RMC 12.2Kbps	RMC 12.2Kbps
Lowest CH	4.71	4.71	4.71
Middle CH	4.71	4.71	4.72
Highest CH	4.75	4.71	4.74





WCDMA Band V (RMC 12.2Kbps)

WCDMA Band II (RMC 12.2Kbps)

Lowest Channel

Lowest Channel

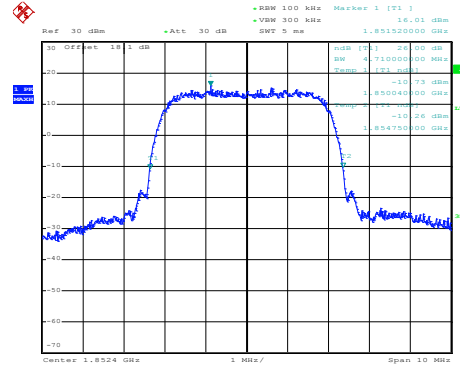
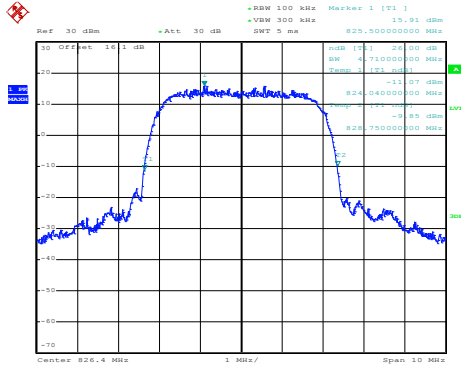

Date: 21.AUG.2015 10:13:44

Date: 21.AUG.2015 10:24:47

Middle Channel

Middle Channel

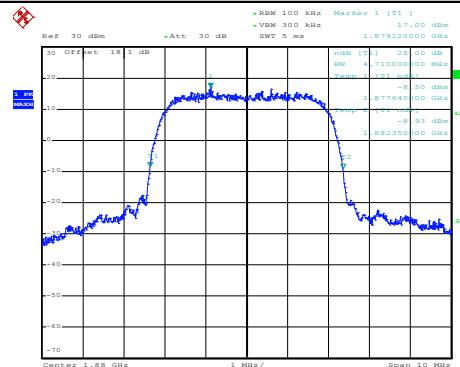
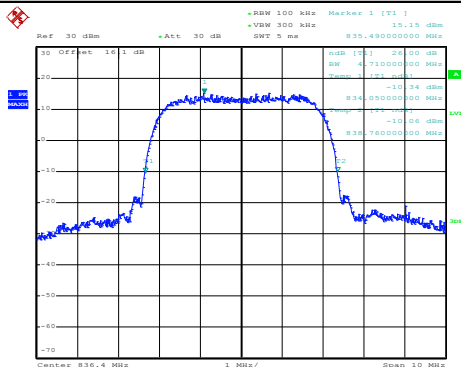

Date: 21.AUG.2015 10:14:12

Date: 21.AUG.2015 10:25:15

Highest Channel

Highest Channel

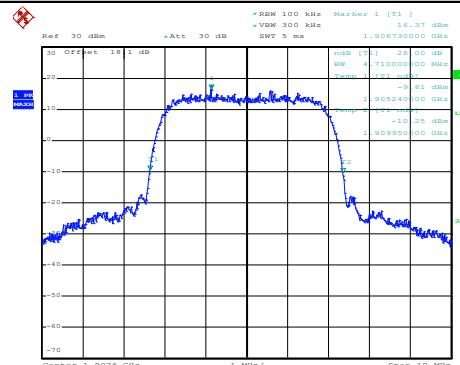
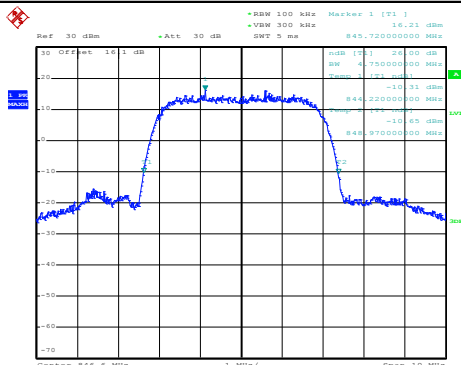

Date: 21.AUG.2015 10:14:41

Date: 21.AUG.2015 10:25:43



WCDMA Band IV (RMC 12.2Kbps)

Lowest Channel

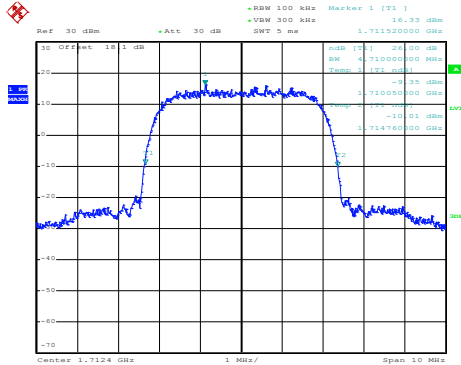

Date: 21.AUG.2015 10:36:16

Middle Channel

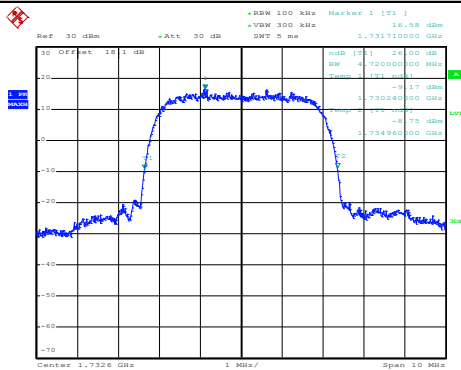

Date: 21.AUG.2015 10:36:44

Highest Channel

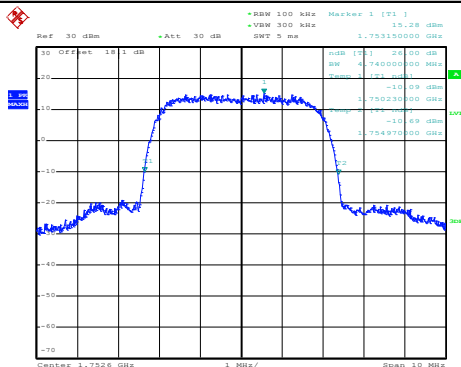

Date: 21.AUG.2015 10:37:12



### Occupied Bandwidth

Mode	WCDMA Band V	WCDMA Band II	WCDMA Band IV
Mod.	RMC 12.2Kbps	RMC 12.2Kbps	RMC 12.2Kbps
Lowest CH	4.13	4.15	4.15
Middle CH	4.13	4.16	4.15
Highest CH	4.16	4.16	4.14



WCDMA Band V (RMC 12.2Kbps)

WCDMA Band II (RMC 12.2Kbps)

Lowest Channel

Lowest Channel

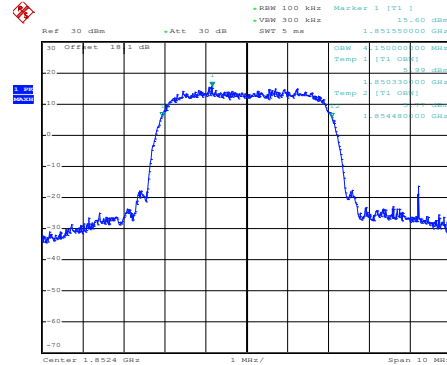
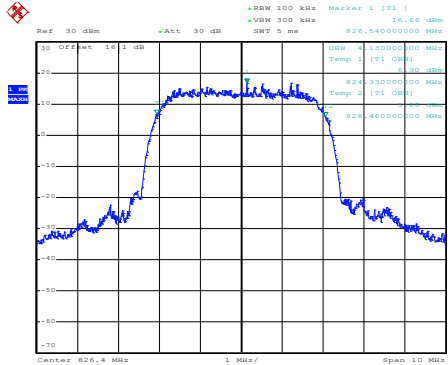

Date: 21.AUG.2015 10:15:25

Date: 21.AUG.2015 10:27:17

Middle Channel

Middle Channel

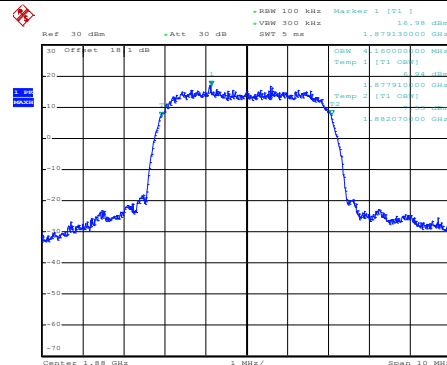
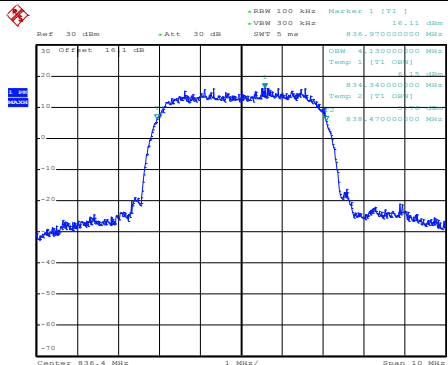

Date: 21.AUG.2015 10:15:53

Date: 21.AUG.2015 10:27:45

Highest Channel

Highest Channel

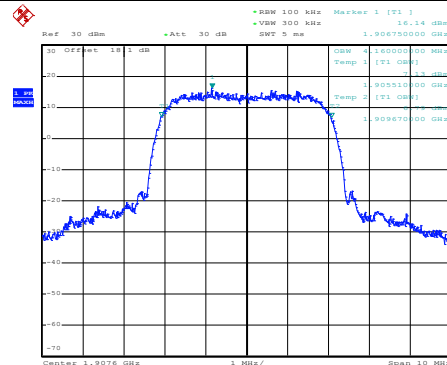
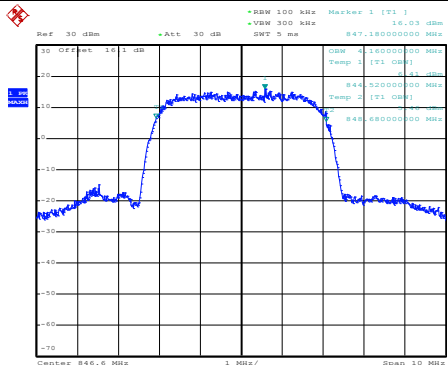

Date: 21.AUG.2015 10:16:21

Date: 21.AUG.2015 10:28:13



### WCDMA Band IV (RMC 12.2Kbps)

#### Lowest Channel

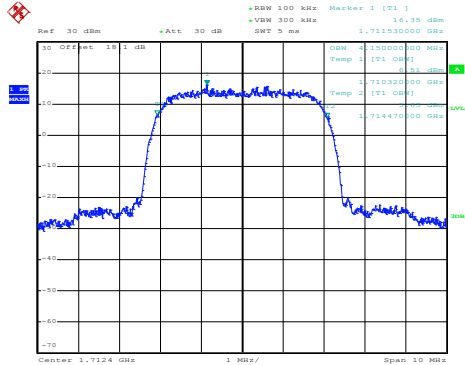

Date: 21.AUG.2015 10:38:05

#### Middle Channel

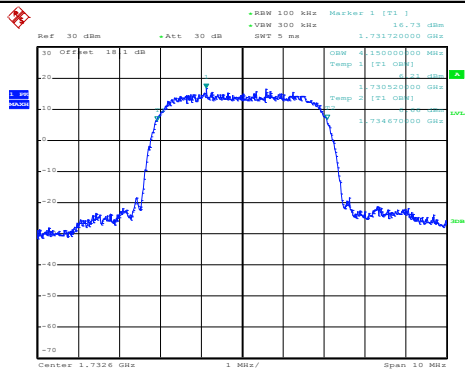

Date: 21.AUG.2015 10:38:33

#### Highest Channel

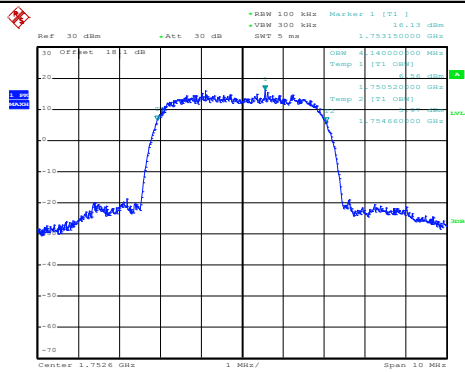

Date: 21.AUG.2015 10:39:01



# Conducted Band Edge

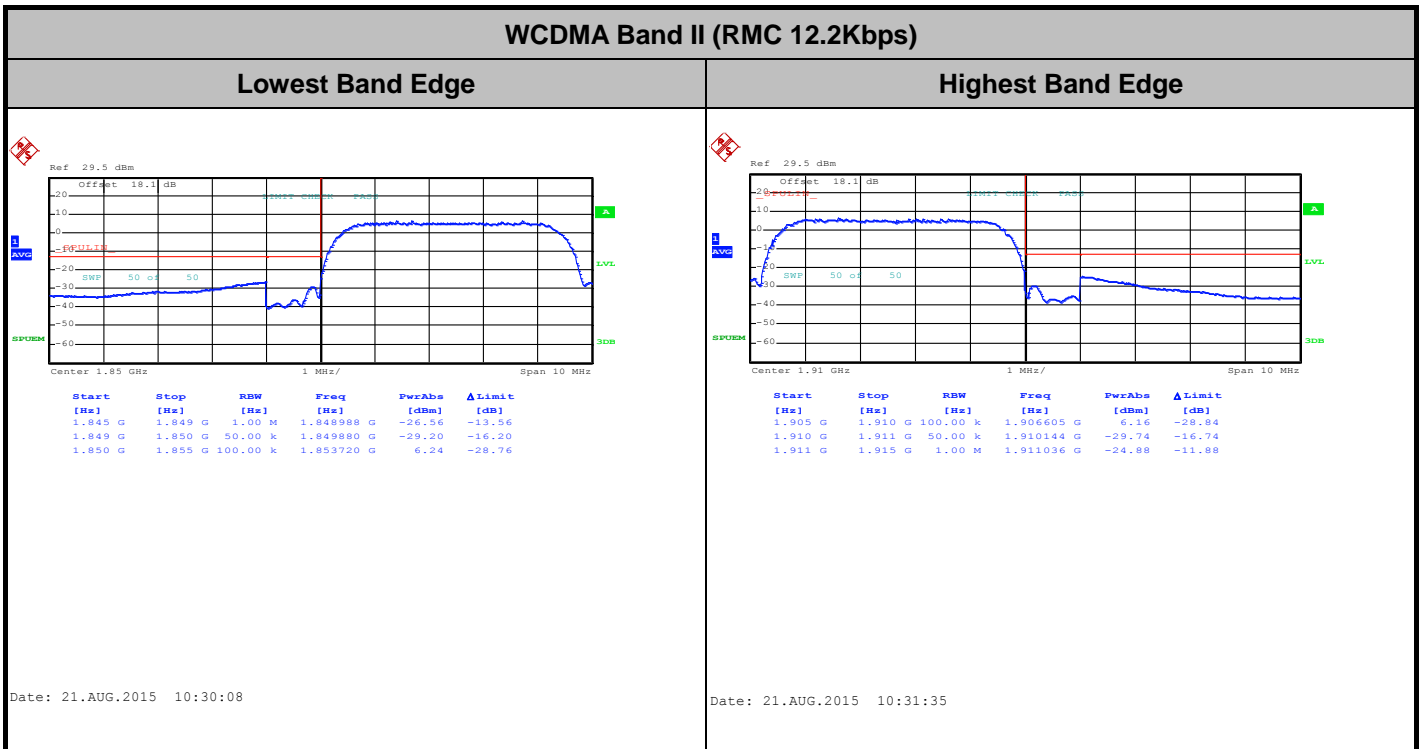
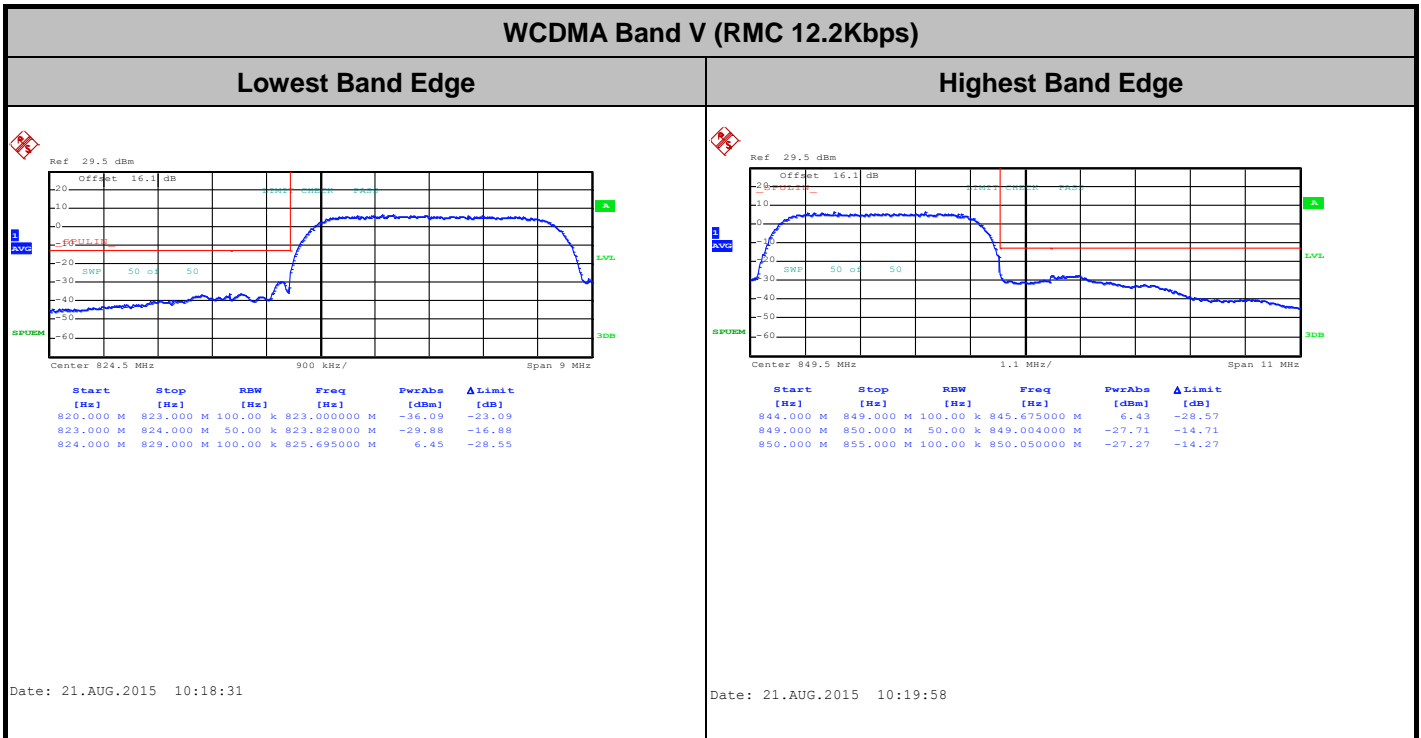



WCDMA Band IV (RMC 12.2Kbps)

Lowest Band Edge

Highest Band Edge

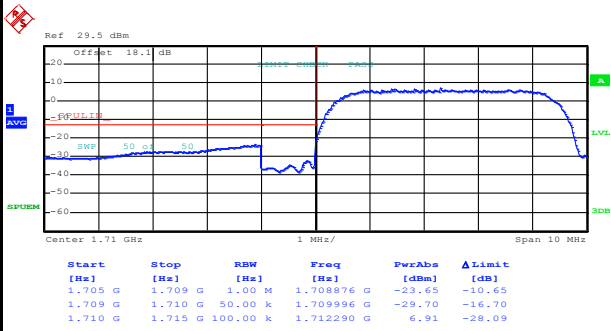

Date: 21.AUG.2015 10:40:35

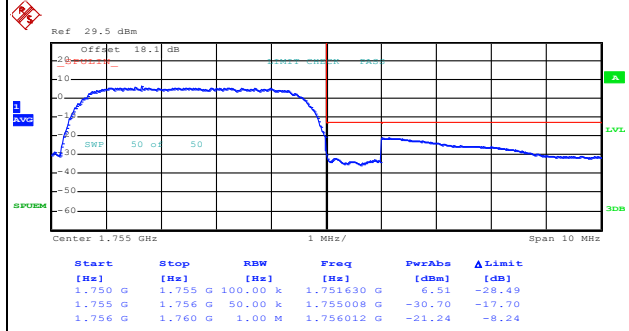

Date: 21.AUG.2015 10:42:02



# Conducted Spurious Emission

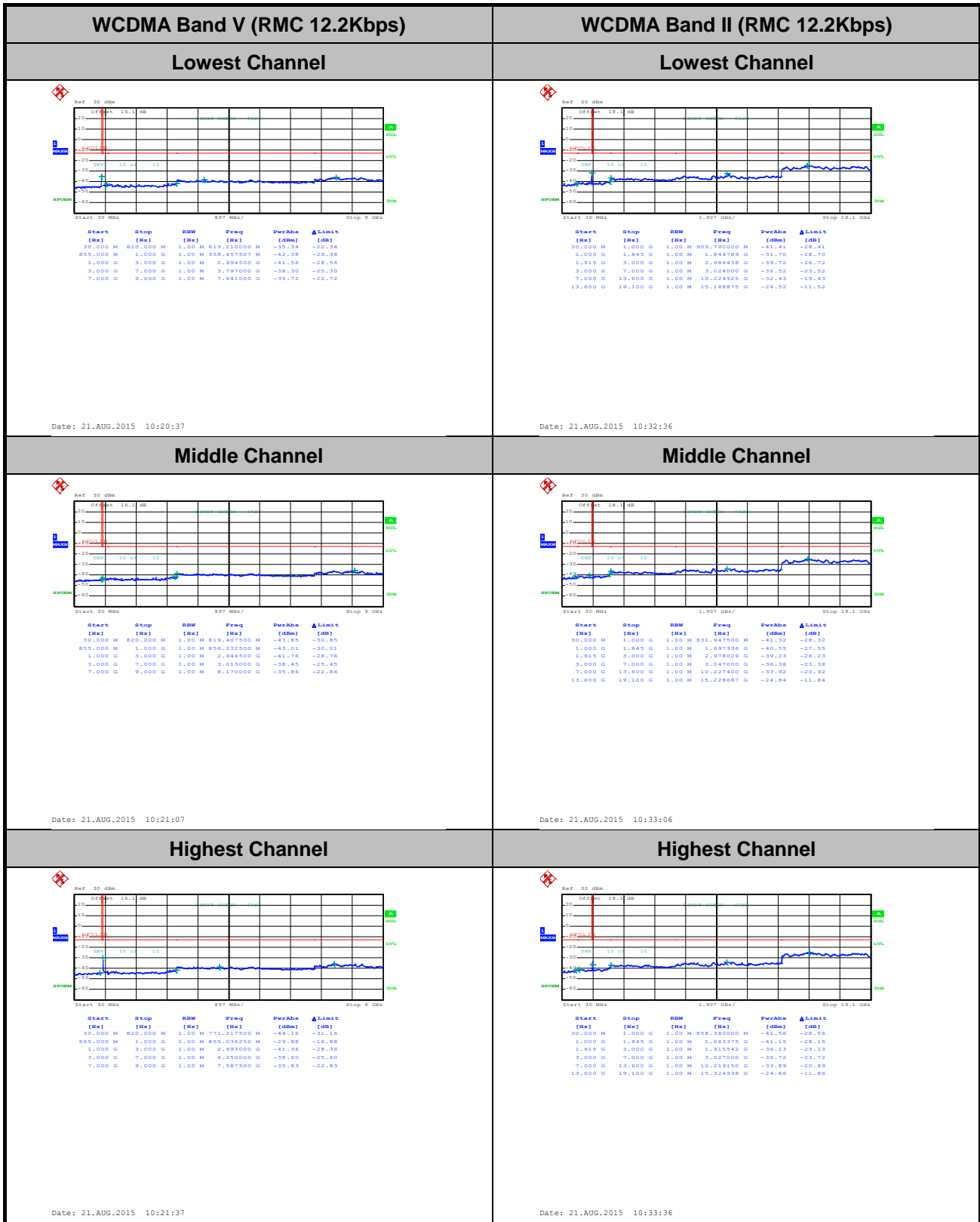





WCDMA Band IV (RMC 12.2Kbps)

Lowest Channel

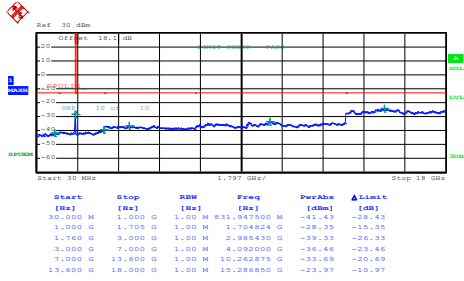

Date: 21.AUG.2015 10:42:53

Middle Channel

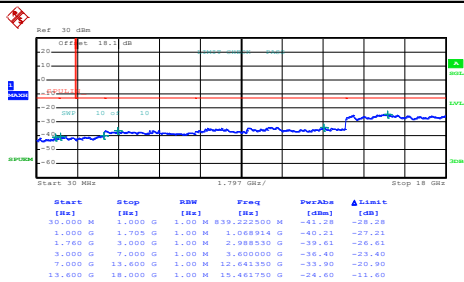

Date: 21.AUG.2015 10:43:23

Highest Channel

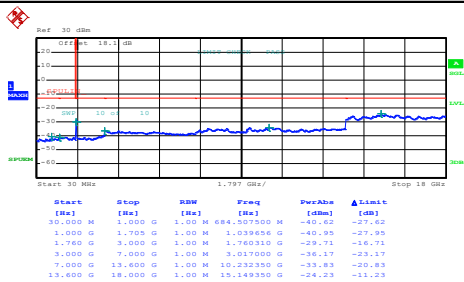

Date: 21.AUG.2015 10:43:53



**Frequency Stability**

Test Conditions	Middle Channel	WCDMA Band V (RMC 12.2Kbps)	Limit
			2.5ppm
Temperature (°C)	Voltage (Volt)	Deviation (ppm)	Result
50	Normal Voltage	0.0120	PASS
40	Normal Voltage	0.0012	
30	Normal Voltage	0.0036	
20(Ref.)	Normal Voltage	0.0000	
10	Normal Voltage	0.0024	
0	Normal Voltage	0.0132	
-10	Normal Voltage	0.0108	
-20	Normal Voltage	0.0024	
-30	Normal Voltage	0.0012	
20	Maximum Voltage	0.0143	
20	Normal Voltage	0.0084	
20	Battery End Point	0.0048	

Note: Normal Voltage = 3.8V. ; Battery End Point (BEP) = 3.6 V. ; Maximum Voltage =4.2 V



Test Conditions	Middle Channel	WCDMA Band II (RMC 12.2Kbps)	Limit Note 2.
Temperature (°C)	Voltage (Volt)	Deviation (ppm)	Result
50	Normal Voltage	0.0037	PASS
40	Normal Voltage	0.0011	
30	Normal Voltage	0.0032	
20(Ref.)	Normal Voltage	0.0000	
10	Normal Voltage	0.0027	
0	Normal Voltage	0.0011	
-10	Normal Voltage	0.0021	
-20	Normal Voltage	0.0005	
-30	Normal Voltage	0.0016	
20	Maximum Voltage	0.0043	
20	Normal Voltage	0.0048	
20	Battery End Point	0.0027	

**Note:**

- 1. Normal Voltage = 3.8V. ; Battery End Point (BEP) = 3.6 V. ; Maximum Voltage =4.2 V
- 2. The frequency fundamental emissions stay within the authorized frequency block.



Test Conditions	Middle Channel	WCDMA Band IV (RMC 12.2Kbps)	Limit Note 2.
Temperature (°C)	Voltage (Volt)	Deviation (ppm)	Result
50	Normal Voltage	0.0023	PASS
40	Normal Voltage	0.0017	
30	Normal Voltage	0.0040	
20(Ref.)	Normal Voltage	0.0000	
10	Normal Voltage	0.0012	
0	Normal Voltage	0.0012	
-10	Normal Voltage	0.0006	
-20	Normal Voltage	0.0000	
-30	Normal Voltage	0.0012	
20	Maximum Voltage	0.0029	
20	Normal Voltage	0.0006	
20	Battery End Point	0.0017	

**Note:**

- 1. Normal Voltage = 3.8V. ; Battery End Point (BEP) = 3.6 V. ; Maximum Voltage =4.2 V
- 2. The frequency fundamental emissions stay within the authorized frequency block.



## Appendix B. Test Results of Radiated Test

### ERP/EIRP

Channel	Mode	Horizontal		Vertical	
		ERP(dBm)	ERP(W)	ERP(dBm)	ERP(W)
Lowest	GSM850 GSM	24.38	0.2742	7.09	0.0051
Middle		25.56	0.3597	12.33	0.0171
Highest		25.67	0.3690	15.86	0.0385
Lowest	GSM850 EDGE class 8	20.52	0.1127	3.01	0.0020
Middle		20.98	0.1253	6.91	0.0049
Highest		21.94	0.1563	10.20	0.0105
Lowest	WCDMA Band V RMC 12.2Kbps	17.85	0.0610	1.30	0.0013
Middle		18.75	0.0750	4.90	0.0031
Highest		19.56	0.0904	7.52	0.0056
Limit	ERP < 7W	Result		PASS	

Channel	Mode	Horizontal		Vertical	
		EIRP(dBm)	EIRP(W)	EIRP(dBm)	EIRP(W)
Lowest	GSM1900 GPRS class 8	24.67	0.2931	23.88	0.2443
Middle		25.44	0.3499	24.76	0.2992
Highest		25.64	0.3664	24.83	0.3041
Lowest	GSM1900 EDGE class 8	23.28	0.2128	21.68	0.1472
Middle		22.90	0.1950	22.84	0.1923
Highest		23.32	0.2148	22.63	0.1832
Lowest	WCDMA Band II RMC 12.2Kbps	17.28	0.0535	16.30	0.0427
Middle		17.93	0.0621	17.23	0.0528
Highest		18.65	0.0733	17.78	0.0600
Limit	EIRP < 2W	Result		PASS	



Channel	Mode	Horizontal		Vertical	
		EIRP(dBm)	EIRP(W)	EIRP(dBm)	EIRP(W)
Lowest	WCDMA Band IV RMC 12.2Kbps	20.89	0.1227	19.93	0.0984
Middle		20.80	0.1202	19.98	0.0995
Highest		20.66	0.1164	19.58	0.0908
Limit	EIRP < 1W	Result		PASS	



### Radiated Spurious Emission

GSM850 (GSM)									
Channel	Frequency ( MHz )	ERP ( dBm )	Limit ( dBm )	Over Limit ( dB )	SPA Reading (dBm)	S.G. Power ( dBm )	TX Cable loss ( dB )	TX Antenna Gain (dBi)	Polarization (H/V)
Lowest	1648	-63.44	-13	-50.44	-74.01	-65.2	0.98	4.89	H
	2472	-60.02	-13	-47.02	-76.08	-61.9	1.28	5.32	H
	3296	-60.09	-13	-47.09	-77.15	-63.5	1.54	7.10	H
	1648	-62.14	-13	-49.14	-73.45	-63.9	0.98	4.89	V
	2472	-58.82	-13	-45.82	-75.85	-60.7	1.28	5.32	V
	3296	-58.49	-13	-45.49	-76.92	-61.9	1.54	7.10	V
Middle	1672	-64.42	-13	-51.42	-74.73	-66.1	0.99	4.82	H
	2509	-60.54	-13	-47.54	-76.35	-62.5	1.29	5.41	H
	3345	-60.19	-13	-47.19	-76.87	-63.8	1.56	7.32	H
	1672	-61.22	-13	-48.22	-72.4	-62.9	0.99	4.82	V
	2509	-58.84	-13	-45.84	-76.23	-60.8	1.29	5.41	V
	3345	-58.49	-13	-45.49	-76.89	-62.1	1.56	7.32	V
Highest	1696	-63.00	-13	-50.00	-73.84	-64.6	1.00	4.75	H
	2546	-59.92	-13	-46.92	-75.9	-61.9	1.31	5.44	H
	3395	-59.98	-13	-46.98	-76.86	-63.8	1.57	7.54	H
	1696	-59.60	-13	-46.60	-71.36	-61.2	1.00	4.75	V
	2544	-54.72	-13	-41.72	-72.04	-56.7	1.30	5.44	V
	3395	-58.88	-13	-45.88	-76.95	-62.7	1.57	7.54	V

Remark: Spurious emissions within 30-1000MHz were found more than 20dB below limit line.



GSM850 (EDGE class 8)									
Channel	Frequency ( MHz )	ERP ( dBm )	Limit ( dBm )	Over Limit ( dB )	SPA Reading (dBm)	S.G. Power ( dBm )	TX Cable loss ( dB )	TX Antenna Gain (dBi)	Polarization (H/V)
Lowest	1648	-65.04	-13	-52.04	-75.23	-66.8	0.98	4.89	H
	2472	-60.22	-13	-47.22	-75.86	-62.1	1.28	5.32	H
	3296	-60.39	-13	-47.39	-77	-63.8	1.54	7.10	H
	1648	-64.14	-13	-51.14	-75.24	-65.9	0.98	4.89	V
	2472	-59.32	-13	-46.32	-76.2	-61.2	1.28	5.32	V
	3296	-58.49	-13	-45.49	-76.71	-61.9	1.54	7.10	V
Middle	1672	-64.92	-13	-51.92	-75.53	-66.6	0.99	4.82	H
	2509	-60.24	-13	-47.24	-76.37	-62.2	1.29	5.41	H
	3345	-60.29	-13	-47.29	-76.92	-63.9	1.56	7.32	H
	1672	-64.12	-13	-51.12	-75.34	-65.8	0.99	4.82	V
	2509	-58.94	-13	-45.94	-76.23	-60.9	1.29	5.41	V
	3345	-58.59	-13	-45.59	-76.78	-62.2	1.56	7.32	V
Highest	1696	-64.30	-13	-51.30	-75.56	-65.9	1.00	4.75	H
	2544	-60.12	-13	-47.12	-76.12	-62.1	1.30	5.44	H
	3395	-60.08	-13	-47.08	-77.15	-63.9	1.57	7.54	H
	1696	-63.70	-13	-50.70	-75.33	-65.3	1.00	4.75	V
	2544	-59.12	-13	-46.12	-76.46	-61.1	1.30	5.44	V
	3393	-58.49	-13	-45.49	-76.75	-62.3	1.57	7.53	V

Remark: Spurious emissions within 30-1000MHz were found more than 20dB below limit line.





GSM1900 (GPRS class 8)									
Channel	Frequency ( MHz )	EIRP ( dBm )	Limit ( dBm )	Over Limit ( dB )	SPA Reading (dBm)	S.G. Power ( dBm )	TX Cable loss ( dB )	TX Antenna Gain (dBi)	Polarization (H/V)
Lowest	3700	-58.63	-13	-45.63	-77.07	-65.2	1.67	8.24	H
	5550	-54.43	-13	-41.43	-78.54	-61.5	2.65	9.72	H
	7400	-53.06	-13	-40.06	-78.78	-62.2	2.46	11.60	H
	3700	-57.63	-13	-44.63	-77.21	-64.2	1.67	8.24	V
	5550	-53.33	-13	-40.33	-78.51	-60.4	2.65	9.72	V
	7400	-51.06	-13	-38.06	-78.78	-60.2	2.46	11.60	V
Middle	3763	-57.87	-13	-44.87	-77.33	-64.5	1.69	8.32	H
	5640	-54.35	-13	-41.35	-78.26	-61.4	2.71	9.76	H
	7520	-52.11	-13	-39.11	-78.55	-61.5	2.42	11.81	H
	3763	-57.87	-13	-44.87	-77.66	-64.5	1.69	8.32	V
	5640	-53.15	-13	-40.15	-78.46	-60.2	2.71	9.76	V
	7520	-50.71	-13	-37.71	-78.91	-60.1	2.42	11.81	V
Highest	3819	-57.42	-13	-44.42	-77.71	-64.1	1.70	8.38	H
	5729	-54.07	-13	-41.07	-78.17	-61.1	2.76	9.79	H
	7639	-51.40	-13	-38.40	-78.22	-60.9	2.38	11.88	H
	3819	-57.42	-13	-44.42	-77.88	-64.1	1.70	8.38	V
	5729	-53.47	-13	-40.47	-78.39	-60.5	2.76	9.79	V
	7639	-50.00	-13	-37.00	-78.58	-59.5	2.38	11.88	V

Remark: Spurious emissions within 30-1000MHz were found more than 20dB below limit line.



GSM1900 (EDGE class 8)									
Channel	Frequency ( MHz )	EIRP ( dBm )	Limit ( dBm )	Over Limit ( dB )	SPA Reading (dBm)	S.G. Power ( dBm )	TX Cable loss ( dB )	TX Antenna Gain (dBi)	Polarization (H/V)
Lowest	3700	-58.83	-13	-45.83	-77.21	-65.4	1.67	8.24	H
	5550	-54.53	-13	-41.53	-78.53	-61.6	2.65	9.72	H
	7400	-52.76	-13	-39.76	-78.61	-61.9	2.46	11.60	H
	3700	-57.93	-13	-44.93	-77.36	-64.5	1.67	8.24	V
	5550	-53.43	-13	-40.43	-78.54	-60.5	2.65	9.72	V
	7400	-51.06	-13	-38.06	-78.51	-60.2	2.46	11.60	V
Middle	3760	-58.57	-13	-45.57	-77.53	-65.2	1.69	8.31	H
	5640	-54.45	-13	-41.45	-78.51	-61.5	2.71	9.76	H
	7520	-52.11	-13	-39.11	-78.45	-61.5	2.42	11.81	H
	3760	-57.87	-13	-44.87	-77.67	-64.5	1.69	8.31	V
	5640	-53.15	-13	-40.15	-78.36	-60.2	2.71	9.76	V
	7520	-50.81	-13	-37.81	-78.87	-60.2	2.42	11.81	V
Highest	3819	-57.82	-13	-44.82	-77.89	-64.5	1.70	8.38	H
	5729	-54.17	-13	-41.17	-78.3	-61.2	2.76	9.79	H
	7639	-51.60	-13	-38.60	-78.36	-61.1	2.38	11.88	H
	3819	-57.42	-13	-44.42	-77.88	-64.1	1.70	8.38	V
	5729	-53.47	-13	-40.47	-78.47	-60.5	2.76	9.79	V
	7639	-50.00	-13	-37.00	-78.38	-59.5	2.38	11.88	V

Remark: Spurious emissions within 30-1000MHz were found more than 20dB below limit line.



WCDMA Band V (RMC 12.2Kbps)									
Channel	Frequency ( MHz )	ERP ( dBm )	Limit ( dBm )	Over Limit ( dB )	SPA Reading (dBm)	S.G. Power ( dBm )	TX Cable loss ( dB )	TX Antenna Gain (dBi)	Polarization (H/V)
Lowest	1656	-64.77	-13	-51.77	-75.32	-66.5	0.98	4.86	H
	2479	-60.30	-13	-47.30	-75.98	-62.2	1.28	5.34	H
	3305	-60.35	-13	-47.35	-76.95	-63.8	1.54	7.14	H
	1656	-63.77	-13	-50.77	-74.99	-65.5	0.98	4.86	V
	2479	-59.20	-13	-46.20	-76.13	-61.1	1.28	5.34	V
	3305	-58.75	-13	-45.75	-77.07	-62.2	1.54	7.14	V
Middle	1672	-64.92	-13	-51.92	-75.32	-66.6	0.99	4.82	H
	2512	-60.53	-13	-47.53	-76.26	-62.5	1.29	5.41	H
	3345	-60.29	-13	-47.29	-77.02	-63.9	1.56	7.32	H
	1672	-64.42	-13	-51.42	-75.51	-66.1	0.99	4.82	V
	2512	-59.13	-13	-46.13	-76.22	-61.1	1.29	5.41	V
	3345	-58.89	-13	-45.89	-77.1	-62.5	1.56	7.32	V
Highest	1696	-64.50	-13	-51.50	-75.4	-66.1	1.00	4.75	H
	2539	-60.52	-13	-47.52	-76.5	-62.5	1.30	5.43	H
	3386	-60.12	-13	-47.12	-77.28	-63.9	1.57	7.50	H
	1696	-63.80	-13	-50.80	-75.35	-65.4	1.00	4.75	V
	2539	-58.82	-13	-45.82	-76.32	-60.8	1.30	5.43	V
	3386	-58.92	-13	-45.92	-77.03	-62.7	1.57	7.50	V

Remark: Spurious emissions within 30-1000MHz were found more than 20dB below limit line.



WCDMA Band II (RMC 12.2Kbps)									
Channel	Frequency ( MHz )	EIRP ( dBm )	Limit ( dBm )	Over Limit ( dB )	SPA Reading (dBm)	S.G. Power ( dBm )	TX Cable loss ( dB )	TX Antenna Gain (dBi)	Polarization (H/V)
Lowest	3707	-58.44	-13	-45.44	-77.4	-65.02	1.67	8.25	H
	5557	-53.97	-13	-40.97	-78.41	-61.03	2.66	9.72	H
	7409	-53.23	-13	-40.23	-78.73	-62.39	2.46	11.62	H
	3707	-56.75	-13	-43.75	-76.89	-63.33	1.67	8.25	V
	5557	-52.71	-13	-39.71	-78.37	-59.77	2.66	9.72	V
	7409	-50.39	-13	-37.39	-78.67	-59.55	2.46	11.62	V
Middle	3763	-57.76	-13	-44.76	-77.55	-64.39	1.69	8.32	H
	5640	-53.97	-13	-40.97	-78.39	-61.02	2.71	9.76	H
	7520	-51.72	-13	-38.72	-78.78	-61.11	2.42	11.81	H
	3763	-57.39	-13	-44.39	-77.81	-64.02	1.69	8.32	V
	5640	-52.72	-13	-39.72	-78.29	-59.77	2.71	9.76	V
	7520	-49.94	-13	-36.94	-78.74	-59.33	2.42	11.81	V
Highest	3819	-57.09	-13	-44.09	-77.79	-63.77	1.70	8.38	H
	5726	-53.84	-13	-40.84	-78.34	-60.88	2.76	9.79	H
	7635	-51.09	-13	-38.09	-78.59	-60.59	2.39	11.88	H
	3819	-56.35	-13	-43.35	-77.52	-63.03	1.70	8.38	V
	5726	-52.73	-13	-39.73	-78.22	-59.77	2.76	9.79	V
	7635	-49.27	-13	-36.27	-78.31	-58.77	2.39	11.88	V

Remark: Spurious emissions within 30-1000MHz were found more than 20dB below limit line.



WCDMA Band IV (RMC 12.2Kbps)									
Channel	Frequency ( MHz )	EIRP ( dBm )	Limit ( dBm )	Over Limit ( dB )	SPA Reading (dBm)	S.G. Power ( dBm )	TX Cable loss ( dB )	TX Antenna Gain (dBi)	Polarization (H/V)
Lowest	3425	-59.11	-13	-46.11	-76.97	-65.2	1.58	7.67	H
	5137	-54.52	-13	-41.52	-78.18	-61.8	2.42	9.70	H
	6850	-51.72	-13	-38.72	-78.27	-59.7	2.64	10.62	H
	3425	-57.21	-13	-44.21	-76.53	-63.3	1.58	7.67	V
	5137	-54.22	-13	-41.22	-78.47	-61.5	2.42	9.70	V
	6850	-51.12	-13	-38.12	-78.3	-59.1	2.64	10.62	V
Middle	3465	-59.15	-13	-46.15	-77.11	-65.4	1.59	7.85	H
	5198	-54.55	-13	-41.55	-78.31	-61.8	2.45	9.70	H
	6930	-52.50	-13	-39.50	-78.67	-60.6	2.61	10.72	H
	3465	-57.65	-13	-44.65	-76.89	-63.9	1.59	7.85	V
	5198	-53.55	-13	-40.55	-78.32	-60.8	2.45	9.70	V
	6930	-51.10	-13	-38.10	-78.67	-59.2	2.61	10.72	V
Highest	3505	-59.00	-13	-46.00	-76.84	-65.4	1.61	8.01	H
	5258	-53.89	-13	-40.89	-78.18	-61.1	2.49	9.70	H
	7010	-52.07	-13	-39.07	-78.3	-60.3	2.59	10.82	H
	3505	-57.20	-13	-44.20	-76.55	-63.6	1.61	8.01	V
	5258	-53.49	-13	-40.49	-78.36	-60.7	2.49	9.70	V
	7010	-50.97	-13	-37.97	-78.38	-59.2	2.59	10.82	V

Remark: Spurious emissions within 30-1000MHz were found more than 20dB below limit line.