

# FCC SAR Test Report

APPLICANT : Sony Mobile Communications Inc.  
EQUIPMENT : Smart phone  
BRAND NAME : SONY  
TYPE NAME : PM-0892-BV  
FCC ID : PY7-PM0892  
STANDARD : FCC 47 CFR Part 2 (2.1093)  
ANSI/IEEE C95.1-1992  
IEEE 1528-2003

We, SPORTON INTERNATIONAL INC., would like to declare that the tested sample has been evaluated in accordance with the procedures and had been in compliance with the applicable technical standards.

The test results in this report apply exclusively to the tested model / sample. Without written approval of SPORTON INTERNATIONAL INC., the test report shall not be reproduced except in full.

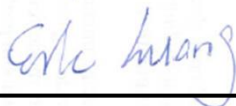

Reviewed by: Eric Huang / Deputy Manager



Approved by: Jones Tsai / Manager



## SPORTON INTERNATIONAL INC.

No.52, Hwa Ya 1st Rd., Hwa Ya Technology Park, Kwei-Shan District, Taoyuan City, Taiwan (R.O.C.)



**Table of Contents**

**1. Statement of Compliance ..... 4**

**2. Administration Data ..... 5**

**3. Guidance Standard ..... 5**

**4. Equipment Under Test (EUT) ..... 6**

    4.1 General Information ..... 6

    4.2 Device Serial Number ..... 6

    4.3 Maximum Tune-up Limit ..... 7

    4.4 General LTE SAR Test and Reporting Considerations ..... 8

**5. RF Exposure Limits..... 9**

    5.1 Uncontrolled Environment..... 9

    5.2 Controlled Environment..... 9

**6. Specific Absorption Rate (SAR).....10**

    6.1 Introduction .....10

    6.2 SAR Definition.....10

**7. System Description and Setup .....11**

**8. Measurement Procedures .....12**

    8.1 Spatial Peak SAR Evaluation.....12

    8.2 Power Reference Measurement.....13

    8.3 Area Scan .....13

    8.4 Zoom Scan.....14

    8.5 Volume Scan Procedures.....14

    8.6 Power Drift Monitoring.....14

**9. Test Equipment List .....15**

**10. System Verification .....16**

    10.1 Tissue Verification .....16

    10.2 System Performance Check Results.....17

**11. RF Exposure Positions .....18**

    11.1 Ear and handset reference point .....18

    11.2 Definition of the cheek position.....19

    11.3 Definition of the tilt position.....20

    11.4 Body Worn Accessory .....20

    11.6 Wireless Router.....21

**12. Conducted RF Output Power (Unit: dBm).....22**

**13. Antenna Location .....35**

**14. SAR Test Results .....36**

    14.1 Head SAR .....37

    14.2 Hotspot SAR .....38

    14.3 Body Worn Accessory SAR.....39

    14.4 Repeated SAR Measurement .....40

**15. Simultaneous Transmission Analysis.....41**

    15.1 Head Exposure Conditions .....42

    15.2 Hotspot Exposure Conditions.....44

    15.3 Body-Worn Accessory Exposure Conditions .....46

**16. Uncertainty Assessment .....47**

**17. References.....50**

**Appendix A. Plots of System Performance Check**

**Appendix B. Plots of High SAR Measurement**

**Appendix C. DASY Calibration Certificate**

**Appendix D. Test Setup Photos**



### Revision History

REPORT NO.	VERSION	DESCRIPTION	ISSUED DATE
FA542944	Rev. 01	Initial issue of report	Jun. 15, 2015
FA542944	Rev. 02	Update 5.5GHz WLAN test results	Jul. 13, 2015



### 1. Statement of Compliance

The maximum results of Specific Absorption Rate (SAR) found during testing for **Sony Mobile Communications Inc., Smart phone, PM-0892-BV**, are as follows.

Equipment Class	Frequency Band	Highest SAR Summary						Highest Simultaneous Transmission 1g SAR (W/kg)
		Head (Separation 0mm)		Body-worn (Separation 15mm)		Wireless Router (Separation 10mm)		
		Maximum power (dBm)	1g SAR (W/kg)	Maximum power (dBm)	1g SAR (W/kg)	Maximum power (dBm)	1g SAR (W/kg)	
PCE	GSM850 (4 Tx slots)	27.50	0.19	27.50	0.26	27.50	0.51	1.22
	GSM1900 (3 Tx slots)	26.00	0.09	26.00	0.17	26.00	0.33	
	WCDMA Band V	24.00	0.19	24.00	0.25	24.00	0.60	
	WCDMA Band II	24.00	0.15	24.00	<b>0.37</b>	24.00	<b>1.02</b>	
	LTE Band 5	24.00	0.22	24.00	0.28	24.00	0.48	
	LTE Band 7	23.00	0.11	23.00	0.22	23.00	0.39	
DTS	2.4GHz WLAN	16.00	0.67	16.00	0.09	16.00	0.20	1.22
NII	5.2GHz WLAN					11.50	0.31	1.23
	5.3GHz WLAN	11.50	0.61	11.50	0.12			
	5.5GHz WLAN	11.50	0.57	11.50	0.12			
	5.8GHz WLAN	11.50	<b>0.78</b>	11.50	0.14			
Date of Testing:		2015/05/02 ~ 2015/07/13						

Frequency Band		Highest SAR Summary						Highest Simultaneous Transmission 10g SAR (W/kg)
		Head (Separation 0mm)		Body-worn (Separation 15mm)		Wireless Router (Separation 10mm)		
		Maximum power (dBm)	10g SAR (W/kg)	Maximum power (dBm)	10g SAR (W/kg)	Maximum power (dBm)	10g SAR (W/kg)	
GSM	GSM850 (4 Tx slots)	27.50	0.15	27.50	0.20	27.50	0.28	0.61
	GSM1900 (3 Tx slots)	26.00	0.06	26.00	0.10	26.00	0.19	
WCDMA	Band V	24.00	0.15	24.00	0.15	24.00	0.33	
	Band II	24.00	0.10	24.00	<b>0.22</b>	24.00	<b>0.52</b>	
LTE	Band 5	24.00	0.17	24.00	0.21	24.00	0.27	
	Band 7	23.00	0.06	23.00	0.12	23.00	0.21	
WLAN	2.4GHz WLAN	16.00	<b>0.31</b>	16.00	0.04	16.00	0.09	0.61
	5.2GHz WLAN					11.50	0.13	0.61
	5.3GHz WLAN	11.50	0.16	11.50	0.07			
	5.5GHz WLAN	11.50	0.15	11.50	0.06			
	5.8GHz WLAN	11.50	0.19	11.50	0.08			
Date of Testing:		2015/05/02 ~ 2015/07/13						

This device is in compliance with Specific Absorption Rate (SAR) for general population/uncontrolled exposure limits (1.6 W/kg) specified in FCC 47 CFR part 2 (2.1093) and ANSI/IEEE C95.1-1992, and had been tested in accordance with the measurement methods and procedures specified in IEEE 1528-2003.



## 2. Administration Data

Testing Laboratory	
Test Site	SPORTON INTERNATIONAL INC.
Test Site Location	No.52, Hwa Ya 1st Rd., Hwa Ya Technology Park, Kwei-Shan District, Taoyuan City, Taiwan (R.O.C.) TEL: +886-3-327-3456 FAX: +886-3-328-4978

Applicant	
Company Name	Sony Mobile Communications Inc.
Address	Nya Vattentornet, 22188 Lund, Sweden

Manufacturer	
Company Name	Arima Communications Corp.
Address	6F,No.866,Jhongjheng Rd., Jhonghe Dist., New Taipei City 23586, Taiwan

## 3. Guidance Standard

The Specific Absorption Rate (SAR) testing specification, method, and procedure for this device is in accordance with the following standards:

- FCC 47 CFR Part 2 (2.1093)
- ANSI/IEEE C95.1-1992
- IEEE 1528-2003
- FCC KDB 865664 D01 SAR Measurement 100 MHz to 6 GHz v01r03
- FCC KDB 865664 D02 SAR Reporting v01r01
- FCC KDB 447498 D01 General RF Exposure Guidance v05r02
- FCC KDB 648474 D04 SAR Evaluation Considerations for Wireless Handsets v01r02
- FCC KDB 248227 D01 802.11 Wi-Fi SAR v02r01
- FCC KDB 941225 D01 3G SAR Procedures v03
- FCC KDB 941225 D05 SAR for LTE Devices v02r03
- FCC KDB 941225 D06 Hotspot Mode SAR v02



## 4. Equipment Under Test (EUT)

### 4.1 General Information

The equipment under test is a smart phone supporting, GSM850/900/1800/1900, UMTS I / II / V / VIII, LTE Band 1 / 3 / 5 / 7 / 8 / 28 / 40, 802.11a/b/g/n, Bluetooth, FM Receiver, NFC and GPS features and below is details of information. For FCC, only wireless modes in US frequency bands are tested.

Product Feature & Specification	
Equipment Name	Smart phone
Brand Name	SONY
Type Name	PM-0892-BV
FCC ID	PY7-PM0892
Wireless Technology and Frequency Range	GSM850: 824.2 MHz ~ 848.8 MHz GSM1900: 1850.2 MHz ~ 1909.8 MHz WCDMA Band V: 826.4 MHz ~ 846.6 MHz WCDMA Band II: 1852.4 MHz ~ 1907.6 MHz LTE Band 5: 824.7 MHz ~ 848.3 MHz LTE Band 7: 2502.5 MHz ~ 2567.5 MHz WLAN 2.4GHz Band: 2412 MHz ~ 2462 MHz WLAN 5.2GHz Band: 5180 MHz ~ 5240 MHz WLAN 5.3GHz Band: 5260 MHz ~ 5320 MHz WLAN 5.5GHz Band: 5500 MHz ~ 5700 MHz WLAN 5.8GHz Band: 5745 MHz ~ 5825 MHz Bluetooth: 2402 MHz ~ 2480 MHz NFC: 13.56 MHz
Mode	<ul style="list-style-type: none"> <li>· GSM/GPRS/EGPRS</li> <li>· RMC/AMR 12.2Kbps</li> <li>· HSDPA</li> <li>· HSUPA</li> <li>· DC-HSDPA</li> <li>· LTE: QPSK, 16QAM</li> <li>· 802.11a/b/g/n HT20/HT40</li> <li>· Bluetooth v3.0+EDR , Bluetooth v4.0-LE</li> <li>· NFC: ASK</li> </ul>
HW Version	A
SW Version	29.0.A.0.76
GSM / (E)GPRS Transfer mode	Class B – EUT cannot support Packet Switched and Circuit Switched Network simultaneously but can automatically switch between Packet and Circuit Switched Network.
EUT Stage	Production Unit
<b>Remark:</b> <ol style="list-style-type: none"> <li>1. This device 2.4GHz WLAN supports Hotspot, and 5.2GHz WLAN supports WiFi Direct (Group Client / Group Owner), and 5.3GHz / 5.5GHz / 5.8GHz supports WiFi Direct (Group Client only).</li> <li>2. WLAN operation in 5600 MHz ~ 5650 MHz is notched.</li> <li>3. The FCC ID PY7-PM0892 and FCC ID: PY7-PM0891 are similar device, in this report all the test case is referred to PY7-PM0891 and spot checks for all the frequency band were performed to ensure that the SAR measurements for both devices are the same.</li> </ol>	

### 4.2 Device Serial Number

Sample	Serial Number	IMEI Code
GSM / UTMS / LTE SAR measurements	WUJ01HWJY0	004402454617402
WLAN SAR measurements	WUJ01HWJRR	004402454617329
GSM / UTMS / LTE Conducted measurements	WUJ01HWJY0	004402454617402
BT/WLAN Conducted measurements	WUJ01HWJMD	004402454617220

**Note:** Several samples were used with identical hardware to support SAR testing. The manufacturer has confirmed that the device tested gave the same physical, mechanical and thermal characteristics and are within operational tolerances expected for production units.



**4.3 Maximum Tune-up Limit**

Mode	Burst Average Power (dBm)	
	GSM 850	GSM 1900
GSM (GMSK, 1 Tx slot)	33.00	30.50
GPRS/EDGE (GMSK, 1 Tx slot)	33.00	30.50
GPRS/EDGE (GMSK, 2 Tx slots)	30.00	27.00
GPRS/EDGE (GMSK, 3 Tx slots)	28.00	26.00
GPRS/EDGE (GMSK, 4 Tx slots)	27.50	24.00
EDGE (8PSK, 1 Tx slot)	28.50	27.50
EDGE (8PSK, 2 Tx slots)	25.50	24.50
EDGE (8PSK, 3 Tx slots)	23.50	22.50
EDGE (8PSK, 4 Tx slots)	24.50	24.50

Mode	Average Power (dBm)	
WCDMA	Band V	24.00
	Band II	24.00
LTE	Band 5	24.00
	Band 7	23.00
Bluetooth v3.0+EDR	Low	6.00
	Middle	7.00
	High	7.00
Bluetooth v4.0-LE		5.00

Mode	Average Power (dBm)	
2.4GHz WLAN	802.11b	16.00
	802.11g	15.00
	802.11n-HT20	12.00
	802.11n-HT40	12.00
5GHz WLAN	802.11a	11.50
	802.11n-HT20	11.50
	802.11n-HT40	11.50



**4.4 General LTE SAR Test and Reporting Considerations**

Summarized necessary items addressed in KDB 941225 D05 v02r03																																														
FCC ID	PY7-PM0892																																													
Equipment Name	Smart phone																																													
Operating Frequency Range of each LTE transmission band	LTE Band 5: 824.7 MHz ~ 848.3 MHz LTE Band 7: 2502.5 MHz ~ 2567.5 MHz																																													
Channel Bandwidth	LTE Band 5: 1.4MHz, 3MHz, 5MHz, 10MHz LTE Band 7: 5MHz, 10MHz, 15MHz, 20MHz																																													
Release and category	Rel8, cat4																																													
uplink modulations used	QPSK, and 16QAM																																													
LTE Voice / Data requirements	Data only																																													
LTE MPR permanently built-in by design	<table border="1"> <caption>Table 6.2.3-1: Maximum Power Reduction (MPR) for Power Class 3</caption> <thead> <tr> <th rowspan="2">Modulation</th> <th colspan="6">Channel bandwidth / Transmission bandwidth (RB)</th> <th rowspan="2">MPR (dB)</th> </tr> <tr> <th>1.4 MHz</th> <th>3.0 MHz</th> <th>5 MHz</th> <th>10 MHz</th> <th>15 MHz</th> <th>20 MHz</th> </tr> </thead> <tbody> <tr> <td>QPSK</td> <td>&gt; 5</td> <td>&gt; 4</td> <td>&gt; 8</td> <td>&gt; 12</td> <td>&gt; 16</td> <td>&gt; 18</td> <td>≤ 1</td> </tr> <tr> <td>16 QAM</td> <td>≤ 5</td> <td>≤ 4</td> <td>≤ 8</td> <td>≤ 12</td> <td>≤ 16</td> <td>≤ 18</td> <td>≤ 1</td> </tr> <tr> <td>16 QAM</td> <td>&gt; 5</td> <td>&gt; 4</td> <td>&gt; 8</td> <td>&gt; 12</td> <td>&gt; 16</td> <td>&gt; 18</td> <td>≤ 2</td> </tr> </tbody> </table>								Modulation	Channel bandwidth / Transmission bandwidth (RB)						MPR (dB)	1.4 MHz	3.0 MHz	5 MHz	10 MHz	15 MHz	20 MHz	QPSK	> 5	> 4	> 8	> 12	> 16	> 18	≤ 1	16 QAM	≤ 5	≤ 4	≤ 8	≤ 12	≤ 16	≤ 18	≤ 1	16 QAM	> 5	> 4	> 8	> 12	> 16	> 18	≤ 2
Modulation	Channel bandwidth / Transmission bandwidth (RB)						MPR (dB)																																							
	1.4 MHz	3.0 MHz	5 MHz	10 MHz	15 MHz	20 MHz																																								
QPSK	> 5	> 4	> 8	> 12	> 16	> 18	≤ 1																																							
16 QAM	≤ 5	≤ 4	≤ 8	≤ 12	≤ 16	≤ 18	≤ 1																																							
16 QAM	> 5	> 4	> 8	> 12	> 16	> 18	≤ 2																																							
LTE A-MPR	In the base station simulator configuration, Network Setting value is set to NS_01 to disable A-MPR during SAR testing and the LTE SAR tests was transmitting on all TTI frames (Maximum TTI)																																													
Spectrum plots for RB configuration	A properly configured base station simulator was used for the SAR and power measurement; therefore, spectrum plots for each RB allocation and offset configuration are not included in the SAR report.																																													
Transmission (H, M, L) channel numbers and frequencies in each LTE band																																														
LTE Band 5																																														
	Bandwidth 1.4 MHz		Bandwidth 3 MHz		Bandwidth 5 MHz		Bandwidth 10 MHz																																							
	Ch. #	Freq. (MHz)	Ch. #	Freq. (MHz)	Ch. #	Freq. (MHz)	Ch. #	Freq. (MHz)																																						
L	20407	824.7	20415	825.5	20425	826.5	20450	829																																						
M	20525	836.5	20525	836.5	20525	836.5	20525	836.5																																						
H	20643	848.3	20635	847.5	20625	846.5	20600	844																																						
LTE Band 7																																														
	Bandwidth 5 MHz		Bandwidth 10 MHz		Bandwidth 15 MHz		Bandwidth 20 MHz																																							
	Ch. #	Freq. (MHz)	Ch. #	Freq. (MHz)	Ch. #	Freq. (MHz)	Ch. #	Freq. (MHz)																																						
L	20775	2502.5	20800	2505	20825	2507.5	20850	2510																																						
M	21100	2535	21100	2535	21100	2535	21100	2535																																						
H	21425	2567.5	21400	2565	21375	2562.5	21350	2560																																						





**5. RF Exposure Limits**

**5.1 Uncontrolled Environment**

Uncontrolled Environments are defined as locations where there is the exposure of individuals who have no knowledge or control of their exposure. The general population/uncontrolled exposure limits are applicable to situations in which the general public may be exposed or in which persons who are exposed as a consequence of their employment may not be made fully aware of the potential for exposure or cannot exercise control over their exposure. Members of the general public would come under this category when exposure is not employment-related; for example, in the case of a wireless transmitter that exposes persons in its vicinity.

**5.2 Controlled Environment**

Controlled Environments are defined as locations where there is exposure that may be incurred by persons who are aware of the potential for exposure, (i.e. as a result of employment or occupation). In general, occupational/controlled exposure limits are applicable to situations in which persons are exposed as a consequence of their employment, who have been made fully aware of the potential for exposure and can exercise control over their exposure. The exposure category is also applicable when the exposure is of a transient nature due to incidental passage through a location where the exposure levels may be higher than the general population/uncontrolled limits, but the exposed person is fully aware of the potential for exposure and can exercise control over his or her exposure by leaving the area or by some other appropriate means.

**Limits for Occupational/Controlled Exposure (W/kg)**

Whole-Body	Partial-Body	Hands, Wrists, Feet and Ankles
0.4	8.0	20.0

**Limits for General Population/Uncontrolled Exposure (W/kg)**

Whole-Body	Partial-Body	Hands, Wrists, Feet and Ankles
0.08	1.6	4.0

1. Whole-Body SAR is averaged over the entire body, partial-body SAR is averaged over any 1gram of tissue defined as a tissue volume in the shape of a cube. SAR for hands, wrists, feet and ankles is averaged over any 10 grams of tissue defined as a tissue volume in the shape of a cube.



## 6. Specific Absorption Rate (SAR)

### 6.1 Introduction

SAR is related to the rate at which energy is absorbed per unit mass in an object exposed to a radio field. The SAR distribution in a biological body is complicated and is usually carried out by experimental techniques or numerical modeling. The standard recommends limits for two tiers of groups, occupational/controlled and general population/uncontrolled, based on a person's awareness and ability to exercise control over his or her exposure. In general, occupational/controlled exposure limits are higher than the limits for general population/uncontrolled.

### 6.2 SAR Definition

The SAR definition is the time derivative (rate) of the incremental energy (dW) absorbed by (dissipated in) an incremental mass (dm) contained in a volume element (dv) of a given density ( $\rho$ ). The equation description is as below:

$$SAR = \frac{d}{dt} \left( \frac{dW}{dm} \right) = \frac{d}{dt} \left( \frac{dW}{\rho dv} \right)$$

SAR is expressed in units of Watts per kilogram (W/kg)

$$SAR = \frac{\sigma |E|^2}{\rho}$$

Where:  $\sigma$  is the conductivity of the tissue,  $\rho$  is the mass density of the tissue and E is the RMS electrical field strength.

## 7. System Description and Setup

The DASY system used for performing compliance tests consists of the following items:

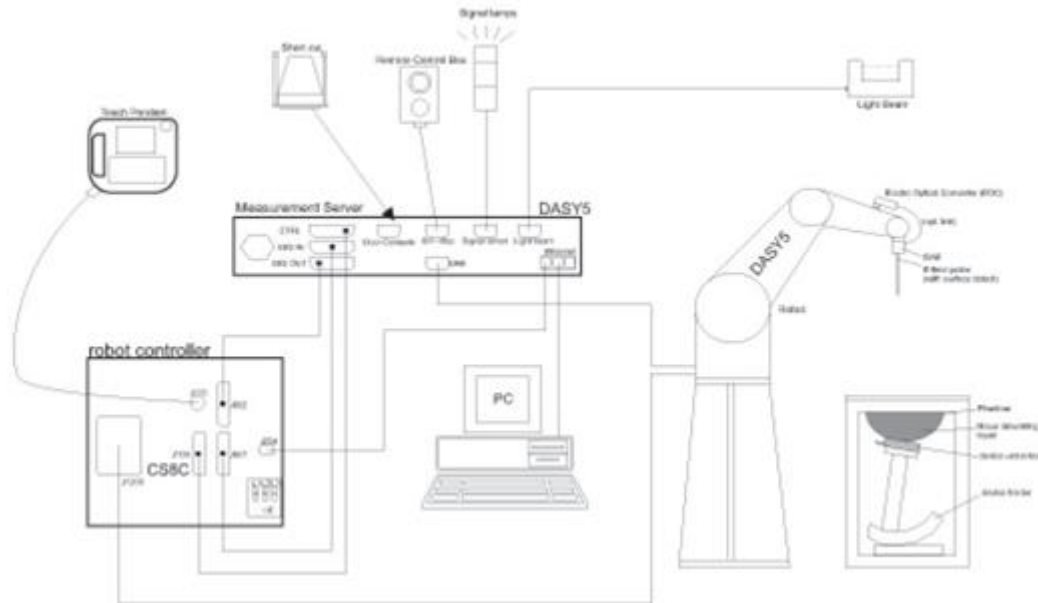

- A standard high precision 6-axis robot with controller, teach pendant and software. An arm extension for accommodating the data acquisition electronics (DAE).
- An isotropic Field probe optimized and calibrated for the targeted measurement.
- A data acquisition electronics (DAE) which performs the signal amplification, signal multiplexing, AD-conversion, offset measurements, mechanical surface detection, collision detection, etc. The unit is battery powered with standard or rechargeable batteries. The signal is optically transmitted to the EOC.
- The Electro-optical converter (EOC) performs the conversion from optical to electrical signals for the digital communication to the DAE. To use optical surface detection, a special version of the EOC is required. The EOC signal is transmitted to the measurement server.
- The function of the measurement server is to perform the time critical tasks such as signal filtering, control of the robot operation and fast movement interrupts.
- The Light Beam used is for probe alignment. This improves the (absolute) accuracy of the probe positioning.
- A computer running WinXP or Win7 and the DASY5 software.
- Remote control and teach pendant as well as additional circuitry for robot safety such as warning lamps, etc.
- The phantom, the device holder and other accessories according to the targeted measurement.

## **8. Measurement Procedures**

The measurement procedures are as follows:

### <Conducted power measurement>

- (a) For WWAN power measurement, use base station simulator to configure EUT WWAN transmission in conducted connection with RF cable, at maximum power in each supported wireless interface and frequency band.
- (b) Read the WWAN RF power level from the base station simulator.
- (c) For WLAN/BT power measurement, use engineering software to configure EUT WLAN/BT continuously transmission, at maximum RF power in each supported wireless interface and frequency band
- (d) Connect EUT RF port through RF cable to the power meter, and measure WLAN/BT output power

### <SAR measurement>

- (a) Use base station simulator to configure EUT WWAN transmission in radiated connection, and engineering software to configure EUT WLAN/BT continuously transmission, at maximum RF power, in the highest power channel.
- (b) Place the EUT in the positions as Appendix D demonstrates.
- (c) Set scan area, grid size and other setting on the DASY software.
- (d) Measure SAR results for the highest power channel on each testing position.
- (e) Find out the largest SAR result on these testing positions of each band
- (f) Measure SAR results for other channels in worst SAR testing position if the reported SAR of highest power channel is larger than 0.8 W/kg

According to the test standard, the recommended procedure for assessing the peak spatial-average SAR value consists of the following steps:

- (a) Power reference measurement
- (b) Area scan
- (c) Zoom scan
- (d) Power drift measurement

### **8.1 Spatial Peak SAR Evaluation**

The procedure for spatial peak SAR evaluation has been implemented according to the test standard. It can be conducted for 1g and 10g, as well as for user-specific masses. The DASY software includes all numerical procedures necessary to evaluate the spatial peak SAR value.

The base for the evaluation is a "cube" measurement. The measured volume must include the 1g and 10g cubes with the highest averaged SAR values. For that purpose, the center of the measured volume is aligned to the interpolated peak SAR value of a previously performed area scan.

The entire evaluation of the spatial peak values is performed within the post-processing engine (SEMCAD). The system always gives the maximum values for the 1g and 10g cubes. The algorithm to find the cube with highest averaged SAR is divided into the following stages:

- (a) Extraction of the measured data (grid and values) from the Zoom Scan
- (b) Calculation of the SAR value at every measurement point based on all stored data (A/D values and measurement parameters)
- (c) Generation of a high-resolution mesh within the measured volume
- (d) Interpolation of all measured values from the measurement grid to the high-resolution grid
- (e) Extrapolation of the entire 3-D field distribution to the phantom surface over the distance from sensor to surface
- (f) Calculation of the averaged SAR within masses of 1g and 10g

**8.2 Power Reference Measurement**

The Power Reference Measurement and Power Drift Measurements are for monitoring the power drift of the device under test in the batch process. The minimum distance of probe sensors to surface determines the closest measurement point to phantom surface. This distance cannot be smaller than the distance of sensor calibration points to probe tip as defined in the probe properties.

**8.3 Area Scan**

The area scan is used as a fast scan in two dimensions to find the area of high field values, before doing a fine measurement around the hot spot. The sophisticated interpolation routines implemented in DASY software can find the maximum found in the scanned area, within a range of the global maximum. The range (in dB0 is specified in the standards for compliance testing. For example, a 2 dB range is required in IEEE standard 1528 and IEC 62209 standards, whereby 3 dB is a requirement when compliance is assessed in accordance with the ARIB standard (Japan), if only one zoom scan follows the area scan, then only the absolute maximum will be taken as reference. For cases where multiple maximums are detected, the number of zoom scans has to be increased accordingly.

Area scan parameters extracted from FCC KDB 865664 D01v01r03 SAR measurement 100 MHz to 6 GHz.

	≤ 3 GHz	> 3 GHz
Maximum distance from closest measurement point (geometric center of probe sensors) to phantom surface	5 ± 1 mm	$\frac{1}{2} \cdot \delta \cdot \ln(2) \pm 0.5$ mm
Maximum probe angle from probe axis to phantom surface normal at the measurement location	30° ± 1°	20° ± 1°
Maximum area scan spatial resolution: $\Delta x_{Area}, \Delta y_{Area}$	≤ 2 GHz: ≤ 15 mm 2 – 3 GHz: ≤ 12 mm	3 – 4 GHz: ≤ 12 mm 4 – 6 GHz: ≤ 10 mm
	When the x or y dimension of the test device, in the measurement plane orientation, is smaller than the above, the measurement resolution must be ≤ the corresponding x or y dimension of the test device with at least one measurement point on the test device.	

**8.4 Zoom Scan**

Zoom scans are used assess the peak spatial SAR values within a cubic averaging volume containing 1 gram and 10 gram of simulated tissue. The zoom scan measures points (refer to table below) within a cube shoes base faces are centered on the maxima found in a preceding area scan job within the same procedure. When the measurement is done, the zoom scan evaluates the averaged SAR for 1 gram and 10 gram and displays these values next to the job's label.

Zoom scan parameters extracted from FCC KDB 865664 D01v01r03 SAR measurement 100 MHz to 6 GHz.

		≤ 3 GHz	> 3 GHz	
Maximum zoom scan spatial resolution: $\Delta x_{Zoom}, \Delta y_{Zoom}$		$\leq 2$ GHz: $\leq 8$ mm 2 – 3 GHz: $\leq 5$ mm*	3 – 4 GHz: $\leq 5$ mm* 4 – 6 GHz: $\leq 4$ mm*	
Maximum zoom scan spatial resolution, normal to phantom surface	uniform grid: $\Delta z_{Zoom}(n)$	$\leq 5$ mm	3 – 4 GHz: $\leq 4$ mm 4 – 5 GHz: $\leq 3$ mm 5 – 6 GHz: $\leq 2$ mm	
	graded grid	$\Delta z_{Zoom}(1)$ : between 1 <sup>st</sup> two points closest to phantom surface	$\leq 4$ mm	3 – 4 GHz: $\leq 3$ mm 4 – 5 GHz: $\leq 2.5$ mm 5 – 6 GHz: $\leq 2$ mm
		$\Delta z_{Zoom}(n>1)$ : between subsequent points	$\leq 1.5 \cdot \Delta z_{Zoom}(n-1)$	
Minimum zoom scan volume	x, y, z	$\geq 30$ mm	3 – 4 GHz: $\geq 28$ mm 4 – 5 GHz: $\geq 25$ mm 5 – 6 GHz: $\geq 22$ mm	
Note: $\delta$ is the penetration depth of a plane-wave at normal incidence to the tissue medium; see draft standard IEEE P1528-2011 for details. * When zoom scan is required and the <i>reported</i> SAR from the <i>area scan based 1-g SAR estimation</i> procedures of KDB 447498 is $\leq 1.4$ W/kg, $\leq 8$ mm, $\leq 7$ mm and $\leq 5$ mm zoom scan resolution may be applied, respectively, for 2 GHz to 3 GHz, 3 GHz to 4 GHz and 4 GHz to 6 GHz.				

**8.5 Volume Scan Procedures**

The volume scan is used for assess overlapping SAR distributions for antennas transmitting in different frequency bands. It is equivalent to an oversized zoom scan used in standalone measurements. The measurement volume will be used to enclose all the simultaneous transmitting antennas. For antennas transmitting simultaneously in different frequency bands, the volume scan is measured separately in each frequency band. In order to sum correctly to compute the 1g aggregate SAR, the EUT remain in the same test position for all measurements and all volume scan use the same spatial resolution and grid spacing. When all volume scan were completed, the software, SEMCAD postprocessor can combine and subsequently superpose these measurement data to calculating the multiband SAR.

**8.6 Power Drift Monitoring**

All SAR testing is under the EUT install full charged battery and transmit maximum output power. In DASYS measurement software, the power reference measurement and power drift measurement procedures are used for monitoring the power drift of EUT during SAR test. Both these procedures measure the field at a specified reference position before and after the SAR testing. The software will calculate the field difference in dB. If the power drifts more than 5%, the SAR will be retested.



### 9. Test Equipment List

Manufacturer	Name of Equipment	Type/Model	Serial Number	Calibration	
				Last Cal.	Due Date
SPEAG	835MHz System Validation Kit	D835V2	499	Mar. 20, 2015	Mar. 19, 2016
SPEAG	1900MHz System Validation Kit	D1900V2	5d041	Mar. 24, 2015	Mar. 23, 2016
SPEAG	2450MHz System Validation Kit	D2450V2	924	Nov. 19, 2014	Nov. 18, 2015
SPEAG	2600MHz System Validation Kit	D2600V2	1070	Nov. 19, 2014	Nov. 18, 2015
SPEAG	5GHz System Validation Kit	D5GHzV2	1006	Sep. 25, 2014	Sep. 24, 2015
SPEAG	Data Acquisition Electronics	DAE4	1388	Sep. 24, 2014	Sep. 23, 2015
SPEAG	Data Acquisition Electronics	DAE3	577	Oct. 06, 2014	Oct. 05, 2015
SPEAG	Data Acquisition Electronics	DAE4	1279	Jul. 23, 2014	Jul. 22, 2015
SPEAG	Data Acquisition Electronics	DAE3	495	May. 19, 2014	May. 18, 2015
SPEAG	Data Acquisition Electronics	DAE4	916	Dec. 29, 2014	Dec. 28, 2015
SPEAG	Dosimetric E-Field Probe	EX3DV4	3697	Sep. 29, 2014	Sep. 28, 2015
SPEAG	Dosimetric E-Field Probe	EX3DV4	3578	Mar. 31, 2015	Mar. 30, 2016
SPEAG	Dosimetric E-Field Probe	EX3DV4	3931	Sep. 25, 2014	Sep. 24, 2015
SPEAG	Dosimetric E-Field Probe	EX3DV4	3954	Nov. 21, 2014	Nov. 20, 2015
SPEAG	Dosimetric E-Field Probe	EX3DV4	3925	May. 22, 2014	May. 21, 2015
Wisewind	Thermometer	ETP-101	TM560	Oct. 21, 2014	Oct. 20, 2015
WonDer	Thermometer	WD-5015	TM685	Oct. 21, 2014	Oct. 20, 2015
Wisewind	Thermometer	HTC-1	TM642	Oct. 21, 2014	Oct. 20, 2015
Wisewind	Thermometer	HTC-1	TM281	Oct. 21, 2014	Oct. 20, 2015
H.M.IRIS	Thermometer	TH-08	TM658	Oct. 21, 2014	Oct. 20, 2015
Anritsu	Radio Communication Analyzer	MT8820C	6201074414	Feb. 06, 2015	Feb. 05, 2016
Agilent	Wireless Communication Test Set	E5515C	GB46311322	Mar. 05, 2015	Mar. 04, 2016
SPEAG	Device Holder	N/A	N/A	N/A	N/A
Agilent	Signal Generator	N5181A	MY50145381	Dec. 11, 2014	Dec. 10, 2015
Agilent	ENA Network Analyzer	E5071C	MY46316648	Feb. 11, 2015	Feb. 10, 2016
SPEAG	Dielectric Probe Kit	DAK-3.5	1138	Nov. 18, 2014	Nov. 17, 2015
Anritsu	Power Meter	ML2495A	1349001	Dec. 03, 2014	Dec. 02, 2015
Anritsu	Power Sensor	MA2411B	1306099	Dec. 03, 2014	Dec. 02, 2015
R&S	Spectrum Analyzer	FSP 7	101131	Jul. 10, 2014	Jul. 09, 2015
Anritsu	Spectrum Analyzer	MS2830A	6201396378	Jun. 17, 2015	Jun. 16, 2016
Agilent	Dual Directional Coupler	778D	50422	Note 1	
Woken	Attenuator 1	WK0602-XX	N/A	Note 1	
PE	Attenuator 2	PE7005-10	N/A	Note 1	
PE	Attenuator 3	PE7005- 3	N/A	Note 1	
AR	Power Amplifier	5S1G4M2	0328767	Note 1	
Mini-Circuits	Power Amplifier	ZVE-3W	162601250	Note 1	

**General Note:**

1. Prior to system verification and validation, the path loss from the signal generator to the system check source and the power meter, which includes the amplifier, cable, attenuator and directional coupler, was measured by the network analyzer. The reading of the power meter was offset by the path loss difference between the path to the power meter and the path to the system check source to monitor the actual power level fed to the system check source.



## 10. System Verification

### 10.1 Tissue Verification

The following tissue formulations are provided for reference only as some of the parameters have not been thoroughly verified. The composition of ingredients may be modified accordingly to achieve the desired target tissue parameters required for routine SAR evaluation.

Frequency (MHz)	Water (%)	Sugar (%)	Cellulose (%)	Salt (%)	Preventol (%)	DGBE (%)	Conductivity ( $\sigma$ )	Permittivity ( $\epsilon_r$ )
For Head								
750	41.1	57.0	0.2	1.4	0.2	0	0.89	41.9
835	40.3	57.9	0.2	1.4	0.2	0	0.90	41.5
900	40.3	57.9	0.2	1.4	0.2	0	0.97	41.5
1800, 1900, 2000	55.2	0	0	0.3	0	44.5	1.40	40.0
2450	55.0	0	0	0	0	45.0	1.80	39.2
2600	54.8	0	0	0.1	0	45.1	1.96	39.0
For Body								
750	51.7	47.2	0	0.9	0.1	0	0.96	55.5
835	50.8	48.2	0	0.9	0.1	0	0.97	55.2
900	50.8	48.2	0	0.9	0.1	0	1.05	55.0
1800, 1900, 2000	70.2	0	0	0.4	0	29.4	1.52	53.3
2450	68.6	0	0	0	0	31.4	1.95	52.7
2600	68.1	0	0	0.1	0	31.8	2.16	52.5

#### Simulating Liquid for 5GHz, Manufactured by SPEAG

Ingredients	(% by weight)
Water	64~78%
Mineral oil	11~18%
Emulsifiers	9~15%
Additives and Salt	2~3%

#### <Tissue Dielectric Parameter Check Results>

Frequency (MHz)	Tissue Type	Liquid Temp. (°C)	Conductivity ( $\sigma$ )	Permittivity ( $\epsilon_r$ )	Conductivity Target ( $\sigma$ )	Permittivity Target ( $\epsilon_r$ )	Delta ( $\sigma$ ) (%)	Delta ( $\epsilon_r$ ) (%)	Limit (%)	Date
835	HSL	22.3	0.898	40.700	0.90	41.50	-0.22	-1.93	±5	2015/5/12
835	HSL	22.4	0.898	40.700	0.90	41.50	-0.22	-1.93	±5	2015/5/12
835	HSL	22.3	0.901	42.100	0.90	41.50	0.11	1.45	±5	2015/5/29
835	MSL	22.5	0.990	54.400	0.97	55.20	2.06	-1.45	±5	2015/5/9
835	MSL	22.3	0.985	56.500	0.97	55.20	1.55	2.36	±5	2015/5/29
1900	HSL	22.4	1.440	39.500	1.40	40.00	2.86	-1.25	±5	2015/5/9
1900	MSL	22.6	1.540	55.100	1.52	53.30	1.32	3.38	±5	2015/5/14
1900	MSL	22.3	1.550	54.300	1.52	53.30	1.97	1.88	±5	2015/5/18
2450	HSL	22.4	1.830	39.000	1.80	39.20	1.67	-0.51	±5	2015/5/8
2450	MSL	22.4	2.000	53.500	1.95	52.70	2.56	1.52	±5	2015/5/8
2600	HSL	22.4	2.040	38.000	1.96	39.00	4.08	-2.56	±5	2015/5/7
2600	MSL	22.3	2.179	54.006	2.16	52.50	0.88	2.87	±5	2015/5/2
5200	MSL	22.6	5.403	47.977	5.30	49.00	1.94	-2.09	±5	2015/5/23
5300	HSL	22.6	4.665	36.682	4.76	35.90	-2.00	2.18	±5	2015/5/23
5300	MSL	22.6	5.554	47.787	5.42	48.90	2.47	-2.28	±5	2015/5/23
5600	HSL	22.6	4.953	36.218	5.07	35.50	-2.31	2.02	±5	2015/5/23
5600	MSL	22.4	5.951	47.001	5.77	48.50	3.14	-3.09	±5	2015/7/13
5800	HSL	22.6	5.157	36.008	5.27	35.30	-2.14	2.01	±5	2015/5/23
5800	MSL	22.6	6.179	46.966	6.00	48.20	2.98	-2.56	±5	2015/5/23



**10.2 System Performance Check Results**

Comparing to the original SAR value provided by SPEAG, the verification data should be within its specification of 10 %. Below table shows the target SAR and measured SAR after normalized to 1W input power. The table below indicates the system performance check can meet the variation criterion and the plots can be referred to Appendix A of this report.

Date	Frequency (MHz)	Tissue Type	Input Power (mW)	Dipole S/N	Probe S/N	DAE S/N	Measured 1g SAR (W/kg)	Targeted 1g SAR (W/kg)	Normalized 1g SAR (W/kg)	Deviation (%)
2015/5/12	835	HSL	250	D835V2-499	EX3DV4 - SN3931	DAE3 Sn577	2.34	9.20	9.36	1.74
2015/5/12	835	HSL	250	D835V2-499	EX3DV4 - SN3925	DAE3 Sn495	2.40	9.20	9.60	4.35
2015/5/29	835	HSL	250	D835V2-499	EX3DV4 - SN3697	DAE4 Sn1388	2.37	9.20	9.48	3.04
2015/5/9	835	MSL	250	D835V2-499	EX3DV4 - SN3954	DAE4 Sn1279	2.24	9.30	8.96	-3.66
2015/5/29	835	MSL	250	D835V2-499	EX3DV4 - SN3697	DAE4 Sn1388	2.49	9.30	9.96	7.10
2015/5/9	1900	HSL	250	D1900V2-5d041	EX3DV4 - SN3954	DAE4 Sn1279	10.10	40.00	40.40	1.00
2015/5/14	1900	MSL	250	D1900V2-5d041	EX3DV4 - SN3697	DAE4 Sn1388	10.80	39.80	43.20	8.54
2015/5/18	1900	MSL	250	D1900V2-5d041	EX3DV4 - SN3697	DAE4 Sn1388	9.73	39.80	38.92	-2.21
2015/5/8	2450	HSL	250	D2450V2-924	EX3DV4 - SN3578	DAE4 Sn1388	13.50	51.90	54.00	4.05
2015/5/8	2450	MSL	250	D2450V2-924	EX3DV4 - SN3578	DAE4 Sn1388	13.30	51.40	53.20	3.50
2015/5/7	2600	HSL	250	D2600V2-1070	EX3DV4 - SN3578	DAE4 Sn1388	15.10	56.90	60.40	6.15
2015/5/2	2600	MSL	250	D2600V2-1070	EX3DV4 - SN3954	DAE4 Sn1279	14.00	55.30	56.00	1.27
2015/5/23	5200	MSL	100	D5GHzV2-1006	EX3DV4 - SN3954	DAE4 Sn1279	7.68	77.50	76.80	-0.90
2015/5/23	5300	HSL	100	D5GHzV2-1006	EX3DV4 - SN3954	DAE4 Sn1279	8.40	86.60	84.00	-3.00
2015/5/23	5300	MSL	100	D5GHzV2-1006	EX3DV4 - SN3954	DAE4 Sn1279	8.59	80.00	85.90	7.38
2015/5/23	5600	HSL	100	D5GHzV2-1006	EX3DV4 - SN3954	DAE4 Sn1279	8.59	85.80	85.90	0.12
2015/7/13	5600	MSL	100	D5GHzV2-1006	EX3DV4 - SN3954	DAE4 Sn916	8.67	85.20	86.70	1.76
2015/5/23	5800	HSL	100	D5GHzV2-1006	EX3DV4 - SN3954	DAE4 Sn1279	8.87	82.90	88.70	7.00
2015/5/23	5800	MSL	100	D5GHzV2-1006	EX3DV4 - SN3954	DAE4 Sn1279	7.89	78.40	78.90	0.64

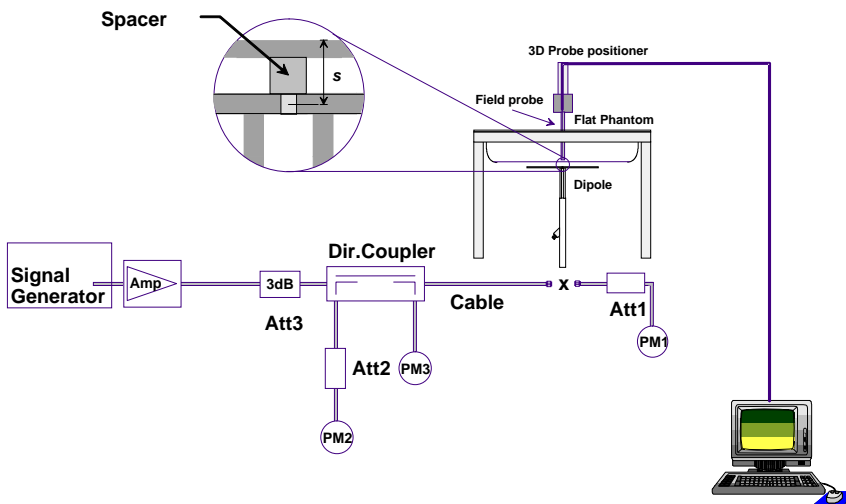

**Fig 8.3.1 System Performance Check Setup**



**Fig 8.3.2 Setup Photo**

## 11. RF Exposure Positions

### 11.1 Ear and handset reference point

Figure 9.1.1 shows the front, back, and side views of the SAM phantom. The center-of-mouth reference point is labeled "M," the left ear reference point (ERP) is marked "LE," and the right ERP is marked "RE." Each ERP is 15 mm along the B-M (back-mouth) line behind the entrance-to-ear-canal (EEC) point, as shown in Figure 9.1.2 The Reference Plane is defined as passing through the two ear reference points and point M. The line N-F (neck-front), also called the reference pivoting line, is normal to the Reference Plane and perpendicular to both a line passing through RE and LE and the B-M line (see Figure 9.1.3). Both N-F and B-M lines should be marked on the exterior of the phantom shell to facilitate handset positioning. Posterior to the N-F line the ear shape is a flat surface with 6 mm thickness at each ERP, and forward of the N-F line the ear is truncated, as illustrated in Figure 9.1.2. The ear truncation is introduced to preclude the ear lobe from interfering with handset tilt, which could lead to unstable positioning at the cheek.

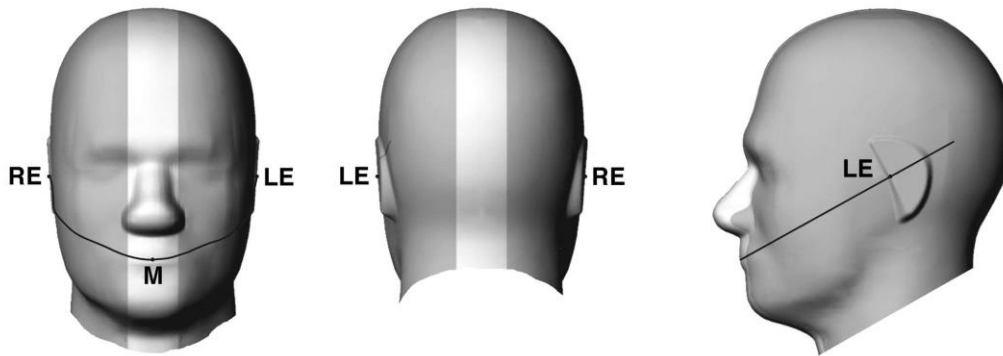

Fig 9.1.1 Front, back, and side views of SAM twin phantom

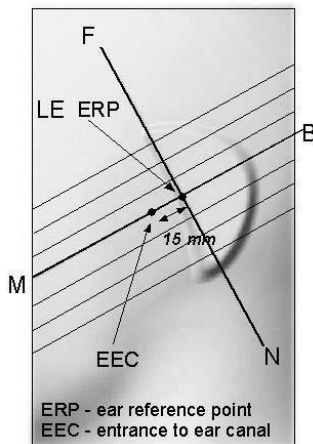

Fig 9.1.2 Close-up side view of phantom showing the ear region.

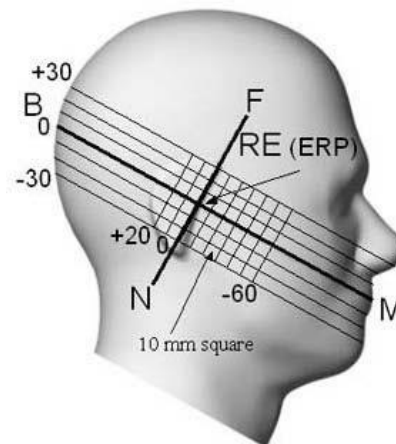
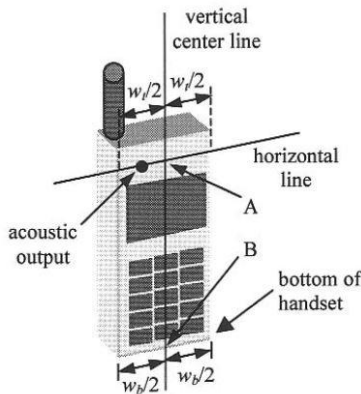

Fig 9.1.3 Side view of the phantom showing relevant markings and seven cross-sectional plane locations

**11.2 Definition of the cheek position**

1. Ready the handset for talk operation, if necessary. For example, for handsets with a cover piece (flip cover), open the cover. If the handset can transmit with the cover closed, both configurations must be tested.
2. Define two imaginary lines on the handset—the vertical centerline and the horizontal line. The vertical centerline passes through two points on the front side of the handset—the midpoint of the width  $w_t$  of the handset at the level of the acoustic output (point A in Figure 9.2.1 and Figure 9.2.2), and the midpoint of the width  $w_b$  of the bottom of the handset (point B). The horizontal line is perpendicular to the vertical centerline and passes through the center of the acoustic output (see Figure 9.2.1). The two lines intersect at point A. Note that for many handsets, point A coincides with the center of the acoustic output; however, the acoustic output may be located elsewhere on the horizontal line. Also note that the vertical centerline is not necessarily parallel to the front face of the handset (see Figure 9.2.2), especially for clamshell handsets, handsets with flip covers, and other irregularly-shaped handsets.
3. Position the handset close to the surface of the phantom such that point A is on the (virtual) extension of the line passing through points RE and LE on the phantom (see Figure 9.2.3), such that the plane defined by the vertical centerline and the horizontal line of the handset is approximately parallel to the sagittal plane of the phantom.
4. Translate the handset towards the phantom along the line passing through RE and LE until handset point A touches the pinna at the ERP.
5. While maintaining the handset in this plane, rotate it around the LE-RE line until the vertical centerline is in the plane normal to the plane containing B-M and N-F lines, i.e., the Reference Plane.
6. Rotate the handset around the vertical centerline until the handset (horizontal line) is parallel to the N-F line.
7. While maintaining the vertical centerline in the Reference Plane, keeping point A on the line passing through RE and LE, and maintaining the handset contact with the pinna, rotate the handset about the N-F line until any point on the handset is in contact with a phantom point below the pinna on the cheek. See Figure 9.2.3. The actual rotation angles should be documented in the test report.



**Fig 9.2.1 Handset vertical and horizontal reference lines—“fixed case”**

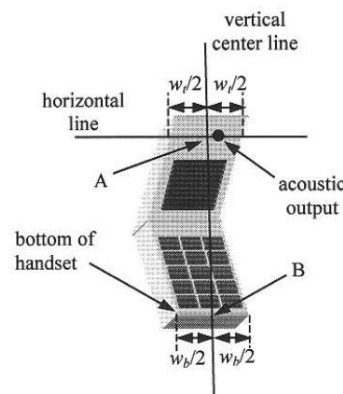

**Fig 9.2.2 Handset vertical and horizontal reference lines—“clam-shell case”**

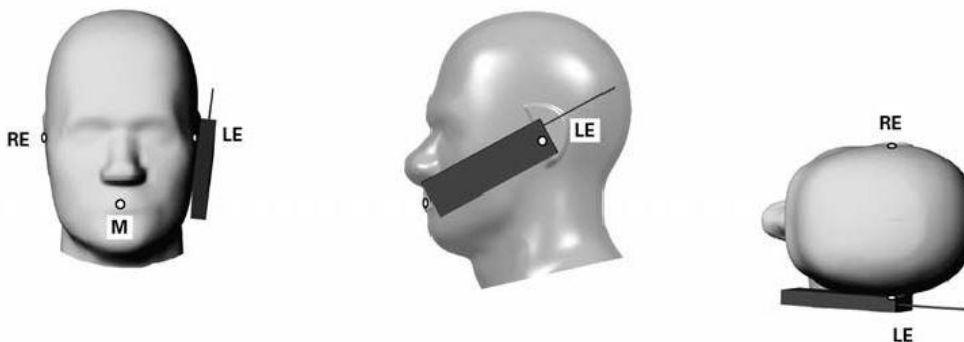

**Fig 9.2.3 cheek or touch position. The reference points for the right ear (RE), left ear (LE), and mouth (M), which establish the Reference Plane for handset positioning, are indicated.**

**11.3 Definition of the tilt position**

1. Ready the handset for talk operation, if necessary. For example, for handsets with a cover piece (flip cover), open the cover. If the handset can transmit with the cover closed, both configurations must be tested.
2. While maintaining the orientation of the handset, move the handset away from the pinna along the line passing through RE and LE far enough to allow a rotation of the handset away from the cheek by 15°.
3. Rotate the handset around the horizontal line by 15°.
4. While maintaining the orientation of the handset, move the handset towards the phantom on the line passing through RE and LE until any part of the handset touches the ear. The tilt position is obtained when the contact point is on the pinna. See Figure 9.3.1. If contact occurs at any location other than the pinna, e.g., the antenna at the back of the phantom head, the angle of the handset should be reduced. In this case, the tilt position is obtained if any point on the handset is in contact with the pinna and a second point

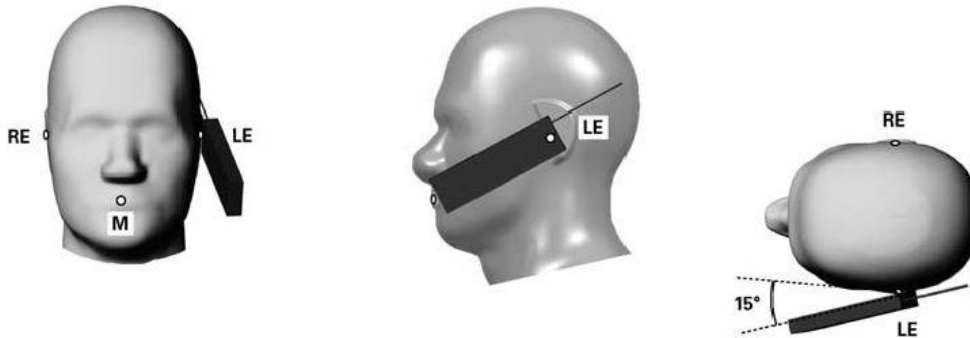
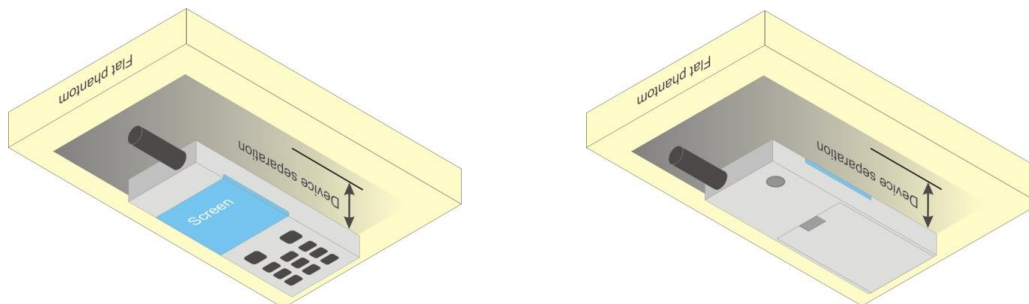

**Fig 9.3.1 Tilt position. The reference points for the right ear (RE), left ear (LE), and mouth (M), which define the Reference Plane for handset positioning, are indicated.**

**11.4 Body Worn Accessory**

Body-worn operating configurations are tested with the belt-clips and holsters attached to the device and positioned against a flat phantom in a normal use configuration (see Figure 9.4). Per KDB 648474 D04v01r02, body-worn accessory exposure is typically related to voice mode operations when handsets are carried in body-worn accessories. The body-worn accessory procedures in FCC KDB 447498 D01v05r02 should be used to test for body-worn accessory SAR compliance, without a headset connected to it. This enables the test results for such configuration to be compatible with that required for hotspot mode when the body-worn accessory test separation distance is greater than or equal to that required for hotspot mode, when applicable. When the reported SAR for body-worn accessory, measured without a headset connected to the handset is < 1.2 W/kg, the highest reported SAR configuration for that wireless mode and frequency band should be repeated for that body-worn accessory with a handset attached to the handset.

Accessories for body-worn operation configurations are divided into two categories: those that do not contain metallic components and those that do contain metallic components and those that do contain metallic components. When multiple accessories that do not contain metallic components are supplied with the device, the device is tested with only the accessory that dictates the closest spacing to the body. Then multiple accessories that contain metallic components are test with the device with each accessory. If multiple accessories share an identical metallic component (i.e. the same metallic belt-chip used with different holsters with no other metallic components) only the accessory that dictates the closest spacing to the body is tested.



**Fig 9.4 Body Worn Position**



## **11.6 Wireless Router**

Some battery-operated handsets have the capability to transmit and receive user through simultaneous transmission of WIFI simultaneously with a separate licensed transmitter. The FCC has provided guidance in FCC HDB Publication 941225 D06 v02 where SAR test considerations for handsets ( $L \times W \geq 9 \text{ cm} \times 5 \text{ cm}$ ) are based on a composite test separation distance of 10mm from the front, back and edges of the device containing transmitting antennas within 2.5cm of their edges, determined from general mixed use conditions for this type of devices. Since the hotspot SAR results may overlap with the body-worn accessory SAR requirements, the more conservative configurations can be considered, thus excluding some body-worn accessory SAR tests.

When the user enables the personal wireless router functions for the handset, actual operations include simultaneous transmission of both the WIFI transmitter and another licensed transmitter. Both transmitters often do not transmit at the same transmitting frequency and thus cannot be evaluated for SAR under actual use conditions due to the limitations of the SAR assessment probes. Therefore, SAR must be evaluated for each frequency transmission and mode separately and spatially summed with the WIFI transmitter according to FCC KDB Publication 447498 D01v05r02 publication procedures. The "Portable Hotspot" feature on the handset was NOT activated during SAR assessments, to ensure the SAR measurements were evaluated for a single transmission frequency RF signal at a time.



## 12. Conducted RF Output Power (Unit: dBm)

### <GSM Conducted Power>

**General Note:**

- Per KDB 447498 D01v05r02, the maximum output power channel is used for SAR testing and for further SAR test reduction.
- Per KDB 941225 D01v03, considering the possibility of e.g. 3rd party VoIP operation for Head and body-worn SAR test reduction for GSM and GPRS and EDGE modes is determined by the source-based time-averaged output power including tune-up tolerance. The mode with highest specified time-averaged output power should be tested for SAR compliance in the applicable exposure conditions. For modes with the same specified maximum output power and tolerance, the higher number time-slot configuration should be tested. Therefore, the EUT was set in GPRS (4Tx slots) for GSM850 and GPRS (3Tx slots) for GSM1900.
- Per KDB 941225 D01v03, for Hotspot SAR test reduction for GPRS and EDGE modes is determined by the source-based time-averaged output power including tune-up tolerance, for modes with the same specified maximum output power and tolerance, the higher number time-slot configuration should be tested, therefore, the EUT was set in GPRS (4Tx slots) for GSM850 and GPRS (3Tx slots) for GSM1900.

Band GSM850	Burst Average Power (dBm)			Tune-up Limit (dBm)	Frame-Average Power (dBm)			Tune-up Limit (dBm)
	128	189	251		128	189	251	
TX Channel	128	189	251		128	189	251	
Frequency (MHz)	824.2	836.4	848.8		824.2	836.4	848.8	
GSM (GMSK, 1 Tx slot)	31.60	32.23	31.60	33.00	22.60	23.23	22.60	24.00
GPRS (GMSK, 1 Tx slot)	31.61	32.24	31.61	33.00	22.61	23.24	22.61	24.00
GPRS (GMSK, 2 Tx slots)	29.53	30.00	29.30	30.00	23.53	24.00	23.30	24.00
GPRS (GMSK, 3 Tx slots)	26.64	27.30	26.35	28.00	22.38	23.04	22.09	23.74
GPRS (GMSK, 4 Tx slots)	25.96	26.68	25.71	27.50	22.96	23.68	22.71	24.50
EDGE (8PSK, 1 Tx slot)	26.58	26.70	26.65	28.50	17.58	17.70	17.65	19.50
EDGE (8PSK, 2 Tx slots)	24.84	25.16	24.95	25.50	18.84	19.16	18.95	19.50
EDGE (8PSK, 3 Tx slots)	22.65	22.94	22.71	23.50	18.39	18.68	18.45	19.24
EDGE (8PSK, 4 Tx slots)	23.49	24.06	23.77	24.50	20.49	21.06	20.77	21.50

Band GSM1900	Burst Average Power (dBm)			Tune-up Limit (dBm)	Frame-Average Power (dBm)			Tune-up Limit (dBm)
	512	661	810		512	661	810	
TX Channel	512	661	810		512	661	810	
Frequency (MHz)	1850.2	1880	1909.8		1850.2	1880	1909.8	
GSM (GMSK, 1 Tx slot)	30.46	30.48	30.35	30.50	21.46	21.48	21.35	21.50
GPRS (GMSK, 1 Tx slot)	30.48	30.50	30.36	30.50	21.48	21.50	21.36	21.50
GPRS (GMSK, 2 Tx slots)	25.65	25.71	25.38	27.00	19.65	19.71	19.38	21.00
GPRS (GMSK, 3 Tx slots)	25.14	25.20	24.86	26.00	20.88	20.94	20.60	21.74
GPRS (GMSK, 4 Tx slots)	23.79	23.86	23.54	24.00	20.79	20.86	20.54	21.00
EDGE (8PSK, 1 Tx slot)	25.55	25.61	25.58	27.50	16.55	16.61	16.58	18.50
EDGE (8PSK, 2 Tx slots)	23.13	23.30	23.26	24.50	17.13	17.30	17.26	18.50
EDGE (8PSK, 3 Tx slots)	21.54	21.64	21.54	22.50	17.28	17.38	17.28	18.24
EDGE (8PSK, 4 Tx slots)	22.71	22.80	22.80	24.50	19.71	19.80	19.80	21.50

**<WCDMA Conducted Power>**

1. The following tests were conducted according to the test requirements outlines in 3GPP TS 34.121 specification.
2. The procedures in KDB 941225 D01 are applied for 3GPP Rel. 6 HSPA to configure the device in the required sub-test mode(s) to determine SAR test exclusion.
3. For DC-HSDPA, the device was configured according to the H-Set 12, Fixed Reference Channel (FRC) configuration in Table C.8.1.12 of 3GPP TS 34.121-1, with the primary and the secondary serving HS-DSCH Cell enabled during the power measurement.

A summary of these settings are illustrated below:

**HSDPA Setup Configuration:**

- a. The EUT was connected to Base Station Agilent E5515C referred to the Setup Configuration.
- b. The RF path losses were compensated into the measurements.
- c. A call was established between EUT and Base Station with following setting:
  - i. Set Gain Factors ( $\beta_c$  and  $\beta_d$ ) and parameters were set according to each
  - ii. Specific sub-test in the following table, C10.1.4, quoted from the TS 34.121
  - iii. Set RMC 12.2Kbps + HSDPA mode.
  - iv. Set Cell Power = -86 dBm
  - v. Set HS-DSCH Configuration Type to FRC (H-set 1, QPSK)
  - vi. Select HSDPA Uplink Parameters
  - vii. Set Delta ACK, Delta NACK and Delta CQI = 8
  - viii. Set Ack-Nack Repetition Factor to 3
  - ix. Set CQI Feedback Cycle (k) to 4 ms
  - x. Set CQI Repetition Factor to 2
  - xi. Power Ctrl Mode = All Up bits
- d. The transmitted maximum output power was recorded.

**Table C.10.1.4:  $\beta$  values for transmitter characteristics tests with HS-DPCCH**

Sub-test	$\beta_c$	$\beta_d$	$\beta_d$ (SF)	$\beta_c/\beta_d$	$\beta_{HS}$ (Note 1, Note 2)	CM (dB) (Note 3)	MPR (dB) (Note 3)
1	2/15	15/15	64	2/15	4/15	0.0	0.0
2	12/15 (Note 4)	15/15 (Note 4)	64	12/15 (Note 4)	24/15	1.0	0.0
3	15/15	8/15	64	15/8	30/15	1.5	0.5
4	15/15	4/15	64	15/4	30/15	1.5	0.5

Note 1:  $\Delta_{ACK}, \Delta_{NACK}$  and  $\Delta_{CQI} = 30/15$  with  $\beta_{HS} = 30/15 * \beta_c$ .

Note 2: For the HS-DPCCH power mask requirement test in clause 5.2C, 5.7A, and the Error Vector Magnitude (EVM) with HS-DPCCH test in clause 5.13.1A, and HSDPA EVM with phase discontinuity in clause 5.13.1AA,  $\Delta_{ACK}$  and  $\Delta_{NACK} = 30/15$  with  $\beta_{HS} = 30/15 * \beta_c$ , and  $\Delta_{CQI} = 24/15$  with  $\beta_{HS} = 24/15 * \beta_c$ .

Note 3: CM = 1 for  $\beta_c/\beta_d = 12/15, \beta_{HS}/\beta_c = 24/15$ . For all other combinations of DPCCH, DPDCCH and HS-DPCCH the MPR is based on the relative CM difference. This is applicable for only UEs that support HSDPA in release 6 and later releases.

Note 4: For subtest 2 the  $\beta_c/\beta_d$  ratio of 12/15 for the TFC during the measurement period (TF1, TF0) is achieved by setting the signalled gain factors for the reference TFC (TF1, TF1) to  $\beta_c = 11/15$  and  $\beta_d = 15/15$ .

**Setup Configuration**

**HSUPA Setup Configuration:**

- a. The EUT was connected to Base Station Agilent E5515C referred to the Setup Configuration.
- b. The RF path losses were compensated into the measurements.
- c. A call was established between EUT and Base Station with following setting \* :
  - i. Call Configs = 5.2B, 5.9B, 5.10B, and 5.13.2B with QPSK
  - ii. Set the Gain Factors ( $\beta_c$  and  $\beta_d$ ) and parameters (AG Index) were set according to each specific sub-test in the following table, C11.1.3, quoted from the TS 34.121
  - iii. Set Cell Power = -86 dBm
  - iv. Set Channel Type = 12.2k + HSPA
  - v. Set UE Target Power
  - vi. Power Ctrl Mode= Alternating bits
  - vii. Set and observe the E-TFCl
  - viii. Confirm that E-TFCl is equal to the target E-TFCl of 75 for sub-test 1, and other subtest's E-TFCl
- d. The transmitted maximum output power was recorded.

**Table C.11.1.3:  $\beta$  values for transmitter characteristics tests with HS-DPCCH and E-DCH**

Sub-test	$\beta_c$	$\beta_d$	$\beta_d$ (SF)	$\beta_c/\beta_d$	$\beta_{HS}$ (Note 1)	$\beta_{ec}$	$\beta_{ed}$ (Note 5) (Note 6)	$\beta_{ed}$ (SF)	$\beta_{ed}$ (Codes)	CM (dB) (Note 2)	MPR (dB) (Note 2)	AG Index (Note 6)	E-TFCl
1	11/15 (Note 3)	15/15 (Note 3)	64	11/15 (Note 3)	22/15	209/225	1309/225	4	1	1.0	0.0	20	75
2	6/15	15/15	64	6/15	12/15	12/15	94/75	4	1	3.0	2.0	12	67
3	15/15	9/15	64	15/9	30/15	30/15	$\beta_{ed1}$ : 47/15 $\beta_{ed2}$ : 47/15	4 4	2	2.0	1.0	15	92
4	2/15	15/15	64	2/15	4/15	2/15	56/75	4	1	3.0	2.0	17	71
5	15/15 (Note 4)	15/15 (Note 4)	64	15/15 (Note 4)	30/15	24/15	134/15	4	1	1.0	0.0	21	81

Note 1:  $\Delta_{ACK}, \Delta_{NACK}$  and  $\Delta_{CQI} = 30/15$  with  $\beta_{hs} = 30/15 * \beta_c$ .

Note 2: CM = 1 for  $\beta_c/\beta_d = 12/15, \beta_{hs}/\beta_c = 24/15$ . For all other combinations of DPDCH, DPCCH, HS-DPCCH, E-DPDCH and E-DPCCH the MPR is based on the relative CM difference.

Note 3: For subtest 1 the  $\beta_c/\beta_d$  ratio of 11/15 for the TFC during the measurement period (TF1, TF0) is achieved by setting the signalled gain factors for the reference TFC (TF1, TF1) to  $\beta_c = 10/15$  and  $\beta_d = 15/15$ .

Note 4: For subtest 5 the  $\beta_c/\beta_d$  ratio of 15/15 for the TFC during the measurement period (TF1, TF0) is achieved by setting the signalled gain factors for the reference TFC (TF1, TF1) to  $\beta_c = 14/15$  and  $\beta_d = 15/15$ .

Note 5: In case of testing by UE using E-DPDCH Physical Layer category 1, Sub-test 3 is omitted according to TS25.306 Table 5.1g.

Note 6:  $\beta_{ed}$  can not be set directly, it is set by Absolute Grant Value.

**Setup Configuration**



**DC-HSDPA 3GPP release 8 Setup Configuration:**

- a. The EUT was connected to Base Station Agilent E5515C referred to the Setup Configuration below
- b. The RF path losses were compensated into the measurements.
- c. A call was established between EUT and Base Station with following setting:
  - i. Set RMC 12.2Kbps + HSDPA mode.
  - ii. Set Cell Power = -25 dBm
  - iii. Set HS-DSCH Configuration Type to FRC (H-set 12, QPSK)
  - iv. Select HSDPA Uplink Parameters
  - v. Set Gain Factors ( $\beta_c$  and  $\beta_d$ ) and parameters were set according to each Specific sub-test in the following table, C10.1.4, quoted from the TS 34.121
    - a). Subtest 1:  $\beta_c/\beta_d=2/15$
    - b). Subtest 2:  $\beta_c/\beta_d=12/15$
    - c). Subtest 3:  $\beta_c/\beta_d=15/8$
    - d). Subtest 4:  $\beta_c/\beta_d=15/4$
  - vi. Set Delta ACK, Delta NACK and Delta CQI = 8
  - vii. Set Ack-Nack Repetition Factor to 3
  - viii. Set CQI Feedback Cycle (k) to 4 ms
  - ix. Set CQI Repetition Factor to 2
  - x. Power Ctrl Mode = All Up bits
- d. The transmitted maximum output power was recorded.

The following tests were conducted according to the test requirements outlines in 3GPP TS 34.121 specification. A summary of these settings are illustrated below:

**C.8.1.12 Fixed Reference Channel Definition H-Set 12**

**Table C.8.1.12: Fixed Reference Channel H-Set 12**

Parameter	Unit	Value
Nominal Avg. Inf. Bit Rate	kbps	60
Inter-TTI Distance	TTI's	1
Number of HARQ Processes	Processes	6
Information Bit Payload ( $N_{INF}$ )	Bits	120
Number Code Blocks	Blocks	1
Binary Channel Bits Per TTI	Bits	960
Total Available SML's in UE	SML's	19200
Number of SML's per HARQ Proc.	SML's	3200
Coding Rate		0.15
Number of Physical Channel Codes	Codes	1
Modulation		QPSK
Note 1: The RMC is intended to be used for DC-HSDPA mode and both cells shall transmit with identical parameters as listed in the table. Note 2: Maximum number of transmission is limited to 1, i.e., retransmission is not allowed. The redundancy and constellation version 0 shall be used.		

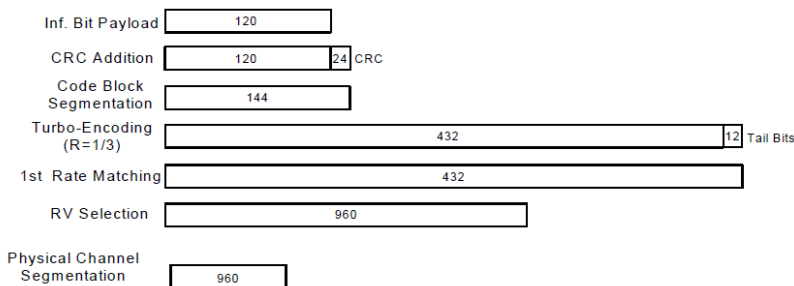

**Figure C.8.19: Coding rate for Fixed reference Channel H-Set 12 (QPSK)**

**Setup Configuration**



**<WCDMA Conducted Power>**

**General Note:**

1. Per KDB 941225 D01v03, SAR for Head / Hotspot / Body-worn exposure is measured using a 12.2 kbps RMC with TPC bits configured to all "1"s".
2. Per KDB 941225 D01v03, RMC 12.2kbps setting is used to evaluate SAR. If the maximum output power and tune-up tolerance specified for production units in HSDPA / HSUPA / DC-HSDPA is  $\leq \frac{1}{4}$  dB higher than RMC 12.2Kbps or when the highest reported SAR of the RMC12.2Kbps is scaled by the ratio of specified maximum output power and tune-up tolerance of HSDPA / HSUPA / DC-HSDPA to RMC12.2Kbps and the adjusted SAR is  $\leq 1.2$  W/kg, SAR measurement is not required for HSDPA / HSUPA / DC-HSDPA.

Band			WCDMA V			WCDMA II		
TX Channel			4132	4182	4233	9262	9400	9538
Frequency (MHz)			826.4	836.4	846.6	1852.4	1880	1907.6
MPR (dB)	3GPP Rel 99	AMR 12.2Kbps	23.92	23.90	23.95	23.98	23.93	23.92
	3GPP Rel 99	RMC 12.2Kbps	23.93	23.92	23.96	24.00	23.94	23.93
0	3GPP Rel 6	HSDPA Subtest-1	23.87	23.89	23.90	23.99	23.89	23.90
0	3GPP Rel 6	HSDPA Subtest-2	23.91	23.92	23.89	23.98	23.87	23.90
0.5	3GPP Rel 6	HSDPA Subtest-3	23.44	23.48	23.42	23.50	23.42	23.43
0.5	3GPP Rel 6	HSDPA Subtest-4	23.38	23.39	23.37	23.47	23.37	23.42
0	3GPP Rel 8	DC-HSDPA Subtest-1	23.85	23.88	23.90	23.97	23.89	23.90
0	3GPP Rel 8	DC-HSDPA Subtest-2	23.91	23.92	23.89	23.98	23.87	23.89
0.5	3GPP Rel 8	DC-HSDPA Subtest-3	23.43	23.46	23.40	23.50	23.41	23.43
0.5	3GPP Rel 8	DC-HSDPA Subtest-4	23.38	23.38	23.36	23.45	23.37	23.42
0	3GPP Rel 6	HSUPA Subtest-1	22.01	22.00	22.16	22.05	22.02	22.00
2	3GPP Rel 6	HSUPA Subtest-2	21.83	21.87	21.87	21.99	21.85	21.87
1	3GPP Rel 6	HSUPA Subtest-3	22.66	22.72	22.68	23.00	22.80	22.84
2	3GPP Rel 6	HSUPA Subtest-4	21.45	21.53	21.48	21.56	21.41	21.33
0	3GPP Rel 6	HSUPA Subtest-5	23.73	23.87	23.78	23.94	23.80	23.76



**<LTE Conducted Power>**

**General Note:**

1. Anritsu MT8820C base station simulator was used to setup the connection with EUT; the frequency band, channel bandwidth, RB allocation configuration, modulation type are set in the base station simulator to configure EUT transmitting at maximum power and at different configurations which are requested to be reported to FCC, for conducted power measurement and SAR testing.
2. Per KDB 941225 D05v02r03, when a properly configured base station simulator is used for the SAR and power measurements, spectrum plots for each RB allocation and offset configuration is not required.
3. Per KDB 941225 D05v02r03, start with the largest channel bandwidth and measure SAR for QPSK with 1 RB allocation, using the RB offset and required test channel combination with the highest maximum output power for RB offsets at the upper edge, middle and lower edge of each required test channel.
4. Per KDB 941225 D05v02r03, 50% RB allocation for QPSK SAR testing follows 1RB QPSK allocation procedure.
5. Per KDB 941225 D05v02r03, For QPSK with 100% RB allocation, SAR is not required when the highest maximum output power for 100 % RB allocation is less than the highest maximum output power in 50% and 1 RB allocations and the highest reported SAR for 1 RB and 50% RB allocation are  $\leq 0.8$  W/kg. Otherwise, SAR is measured for the highest output power channel; and if the reported SAR is  $> 1.45$  W/kg, the remaining required test channels must also be tested.
6. Per KDB 941225 D05v02r03, 16QAM output power for each RB allocation configuration is  $>$  not  $\frac{1}{2}$  dB higher than the same configuration in QPSK and the reported SAR for the QPSK configuration is  $\leq 1.45$  W/kg; Per KDB 941225 D05v02r03, 16QAM SAR testing is not required.
7. Per KDB 941225 D05v02r03, Smaller bandwidth output power for each RB allocation configuration is  $>$  not  $\frac{1}{2}$  dB higher than the same configuration in the largest supported bandwidth, and the reported SAR for the largest supported bandwidth is  $\leq 1.45$  W/kg; Per KDB 941225 D05v02r03, smaller bandwidth SAR testing is not required.



<LTE Band 5>

BW [MHz]	Modulation	RB Size	RB Offset	Power Low Ch. / Freq.	Power Middle Ch. / Freq.	Power High Ch. / Freq.	Tune-up limit (dBm)	MPR (dB)
Channel				20450	20525	20600		
Frequency (MHz)				829	836.5	844		
10	QPSK	1	0	23.62	23.69	23.65	24	0
10	QPSK	1	24	23.56	23.60	23.54		
10	QPSK	1	49	23.51	23.48	23.41		
10	QPSK	25	0	22.60	22.61	22.58	23	1
10	QPSK	25	12	22.58	22.61	22.58		
10	QPSK	25	24	22.57	22.59	22.58		
10	QPSK	50	0	22.62	22.61	22.59		
10	16QAM	1	0	22.74	22.98	22.91	23	1
10	16QAM	1	24	22.91	23.00	22.88		
10	16QAM	1	49	22.93	22.84	22.75		
10	16QAM	25	0	21.62	21.69	21.64	22	2
10	16QAM	25	12	21.63	21.69	21.64		
10	16QAM	25	24	21.67	21.67	21.65		
10	16QAM	50	0	21.66	21.68	21.64		
Channel				20425	20525	20625	Tune-up limit (dBm)	MPR (dB)
Frequency (MHz)				826.5	836.5	846.5		
5	QPSK	1	0	23.51	23.59	23.58	24	0
5	QPSK	1	12	23.54	23.57	23.58		
5	QPSK	1	24	23.46	23.46	23.44		
5	QPSK	12	0	22.61	22.66	22.68	23	1
5	QPSK	12	6	22.62	22.67	22.68		
5	QPSK	12	11	22.63	22.66	22.65		
5	QPSK	25	0	22.58	22.58	22.65		
5	16QAM	1	0	22.74	23.00	22.91	23	1
5	16QAM	1	12	22.82	22.98	22.94		
5	16QAM	1	24	22.77	22.86	22.79		
5	16QAM	12	0	21.65	21.79	21.75	22	2
5	16QAM	12	6	21.68	21.77	21.76		
5	16QAM	12	11	21.68	21.75	21.74		
5	16QAM	25	0	21.60	21.66	21.67		
Channel				20415	20525	20635	Tune-up limit (dBm)	MPR (dB)
Frequency (MHz)				825.5	836.5	847.5		
3	QPSK	1	0	23.45	23.52	23.51	24	0
3	QPSK	1	7	23.50	23.52	23.53		
3	QPSK	1	14	23.45	23.44	23.43		
3	QPSK	8	0	22.60	22.66	22.67	23	1
3	QPSK	8	4	22.59	22.65	22.63		
3	QPSK	8	7	22.60	22.63	22.62		
3	QPSK	15	0	22.63	22.62	22.61		
3	16QAM	1	0	22.67	22.88	22.83	23	1
3	16QAM	1	7	22.74	22.90	22.88		
3	16QAM	1	14	22.75	22.86	22.77		
3	16QAM	8	0	21.69	21.82	21.80	22	2
3	16QAM	8	4	21.68	21.79	21.77		
3	16QAM	8	7	21.69	21.77	21.76		
3	16QAM	15	0	21.65	21.70	21.68		



Channel				20407	20525	20643	Tune-up limit (dBm)	MPR (dB)
Frequency (MHz)				824.7	836.5	848.3		
1.4	QPSK	1	0	23.50	23.54	23.52	24	0
1.4	QPSK	1	2	23.60	23.62	23.59		
1.4	QPSK	1	5	23.50	23.53	23.48		
1.4	QPSK	3	0	23.62	23.64	23.62		
1.4	QPSK	3	1	23.56	23.57	23.57		
1.4	QPSK	3	2	23.56	23.57	23.53		
1.4	QPSK	6	0	22.61	22.63	22.60	23	1
1.4	16QAM	1	0	22.72	22.95	22.85	23	1
1.4	16QAM	1	2	22.81	23.00	22.91		
1.4	16QAM	1	5	22.72	22.87	22.81		
1.4	16QAM	3	0	22.60	22.73	22.68		
1.4	16QAM	3	1	22.54	22.67	22.63		
1.4	16QAM	3	2	22.53	22.65	22.58		
1.4	16QAM	6	0	21.71	21.79	21.74	22	2



<LTE Band 7>

BW [MHz]	Modulation	RB Size	RB Offset	Power Low Ch. / Freq.	Power Middle Ch. / Freq.	Power High Ch. / Freq.	Tune-up limit (dBm)	MPR (dB)
Channel				20850	21100	21350		
Frequency (MHz)				2510	2535	2560		
20	QPSK	1	0	22.66	22.85	22.97		
20	QPSK	1	49	22.46	22.63	22.84	23	0
20	QPSK	1	99	22.60	22.61	22.80		
20	QPSK	50	0	21.70	21.94	21.99		
20	QPSK	50	24	21.68	21.86	21.98	22	1
20	QPSK	50	49	21.69	21.93	21.98		
20	QPSK	100	0	21.68	21.84	21.98		
20	16QAM	1	0	21.68	21.91	21.96	22	1
20	16QAM	1	49	21.85	21.92	21.99		
20	16QAM	1	99	21.90	21.98	21.97		
20	16QAM	50	0	20.70	20.83	20.98	21	2
20	16QAM	50	24	20.71	20.87	21.00		
20	16QAM	50	49	20.72	20.94	20.99		
20	16QAM	100	0	20.71	20.84	20.97		
Channel				20825	21100	21375		
Frequency (MHz)				2507.5	2535	2562.5		
15	QPSK	1	0	22.58	22.84	22.96		
15	QPSK	1	37	22.45	22.69	22.95	23	0
15	QPSK	1	74	22.43	22.81	22.83		
15	QPSK	36	0	21.67	21.99	21.99		
15	QPSK	36	18	21.66	21.93	21.98	22	1
15	QPSK	36	37	21.66	21.98	21.96		
15	QPSK	75	0	21.65	21.90	21.99		
15	16QAM	1	0	21.65	21.90	21.99	22	1
15	16QAM	1	37	21.81	21.96	21.98		
15	16QAM	1	74	21.83	21.99	21.96		
15	16QAM	36	0	20.63	20.87	20.96	21	2
15	16QAM	36	18	20.67	20.93	20.97		
15	16QAM	36	37	20.68	20.97	20.98		
15	16QAM	75	0	20.64	20.89	20.96		
Channel				20800	21100	21400		
Frequency (MHz)				2505	2535	2565		
10	QPSK	1	0	22.37	22.75	22.86		
10	QPSK	1	24	22.44	22.86	22.84	23	0
10	QPSK	1	49	22.47	22.91	22.75		
10	QPSK	25	0	21.49	21.87	21.95		
10	QPSK	25	12	21.52	21.91	21.92	22	1
10	QPSK	25	24	21.56	21.96	21.90		
10	QPSK	50	0	21.55	21.94	21.96		
10	16QAM	1	0	21.57	21.97	21.98	22	1
10	16QAM	1	24	21.65	21.91	21.91		
10	16QAM	1	49	21.72	21.96	21.96		
10	16QAM	25	0	20.49	20.85	20.94	21	2
10	16QAM	25	12	20.51	20.88	20.90		
10	16QAM	25	24	20.55	20.92	20.88		
10	16QAM	50	0	20.55	20.89	20.94		



Channel				20775	21100	21425	Tune-up limit (dBm)	MPR (dB)
Frequency (MHz)				2502.5	2535	2567.5		
5	QPSK	1	0	22.40	22.82	22.81	23	0
5	QPSK	1	12	22.46	22.87	22.82		
5	QPSK	1	24	22.45	22.89	22.77		
5	QPSK	12	0	21.53	21.94	21.92	22	1
5	QPSK	12	6	21.53	21.94	21.92		
5	QPSK	12	11	21.52	21.94	21.89		
5	QPSK	25	0	21.49	21.90	21.88		
5	16QAM	1	0	21.58	22.00	21.99	22	1
5	16QAM	1	12	21.63	21.91	21.99		
5	16QAM	1	24	21.64	21.96	21.94		
5	16QAM	12	0	20.52	20.93	20.92	21	2
5	16QAM	12	6	20.53	20.93	20.91		
5	16QAM	12	11	20.52	20.93	20.89		
5	16QAM	25	0	20.48	20.87	20.86		

**<Bluetooth Conducted Power>**

Mode Band	Average power(dBm)	
	Bluetooth v3.0+EDR	Bluetooth v4.0+LE
2.4GHz Bluetooth	7.0	5.0

**Note:**

- Per KDB 447498 D01v05r02, the 1-g and 10-g SAR test exclusion thresholds for 100 MHz to 6 GHz at *test separation distances* ≤ 50 mm are determined by:  

$$[(\text{max. power of channel, including tune-up tolerance, mW}) / (\text{min. test separation distance, mm})] \cdot \sqrt{f(\text{GHz})} \leq 3.0$$
 for 1-g SAR and ≤ 7.5 for 10-g extremity SAR
  - f(GHz) is the RF channel transmit frequency in GHz
  - Power and distance are rounded to the nearest mW and mm before calculation
  - The result is rounded to one decimal place for comparison

Bluetooth Max Power (dBm)	Separation Distance (mm)	Frequency (GHz)	exclusion thresholds
7.0	< 5	2.48	1.57

**Note:**

Per KDB 447498 D01v05r02, when the minimum test separation distance is < 5 mm, a distance of 5 mm is applied to determine SAR test exclusion. The test exclusion threshold is 1.57 which is ≤ 3, SAR testing is not required.



**<WLAN Conducted Power>**

**General Note:**

1. Per KDB 248227 D01v02r01, SAR test reduction is determined according to 802.11 transmission mode configurations and certain exposure conditions with multiple test positions. In the 2.4 GHz band, separate SAR procedures are applied to DSSS and OFDM configurations to simplify DSSS test requirements. For OFDM, in both 2.4 and 5 GHz bands, an initial test configuration must be determined for each standalone and aggregated frequency band, according to the transmission mode configuration with the highest maximum output power specified for production units to perform SAR measurements. If the same highest maximum output power applies to different combinations of channel bandwidths, modulations and data rates, additional procedures are applied to determine which test configurations require SAR measurement. When applicable, an initial test position may be applied to reduce the number of SAR measurements required for next to the ear, UMPC mini-tablet or hotspot mode configurations with multiple test positions.
2. For 2.4 GHz 802.11b DSSS, either the initial test position procedure for multiple exposure test positions or the DSSS procedure for fixed exposure position is applied; these are mutually exclusive. For 2.4 GHz and 5 GHz OFDM configurations, the initial test configuration is applied to measure SAR using either the initial test position procedure for multiple exposure test position configurations or the initial test configuration procedures for fixed exposure test conditions. Based on the reported SAR of the measured configurations and maximum output power of the transmission mode configurations that are not included in the initial test configuration, the subsequent test configuration and initial test position procedures are applied to determine if SAR measurements are required for the remaining OFDM transmission configurations. In general, the number of test channels that require SAR measurement is minimized based on maximum output power measured for the test sample(s).
3. For OFDM transmission configurations in the 2.4 GHz and 5 GHz bands, When the same maximum power is specified for multiple transmission modes in a frequency band, the largest channel bandwidth, lowest order modulation, lowest data rate and lowest order 802.11a/g/n/ac mode is used for SAR measurement, on the highest measured output power channel for each frequency band.
4. DSSS and OFDM configurations are considered separately according to the required SAR procedures. SAR is measured in the initial test position using the 802.11 transmission mode configuration required by the DSSS procedure or initial test configuration and subsequent test configuration(s) according to the OFDM procedures.<sup>18</sup> The initial test position procedure is described in the following:
  - a. When the reported SAR of the initial test position is  $\leq 0.4$  W/kg, further SAR measurement is not required for the other test positions in that exposure configuration and 802.11 transmission mode combinations within the frequency band or aggregated band.
  - b. When the reported SAR of the test position is  $> 0.4$  W/kg, SAR is repeated for the 802.11 transmission mode configuration tested in the initial test position to measure the subsequent next closet/smallest test separation distance and maximum coupling test position on the highest maximum output power channel, until the report SAR is  $\leq 0.8$  W/kg or all required test position are tested.
  - c. For all positions/configurations, when the reported SAR is  $> 0.8$  W/kg, SAR is measured for these test positions/configurations on the subsequent next highest measured output power channel(s) until the reported SAR is  $\leq 1.2$  W/kg or all required channels are tested.





**<2.4GHz WLAN>**

	Mode	Channel	Frequency (MHz)	Data Rate	Average power (dBm)	Tune-Up Limit	Duty Cycle %
2.4GHz WLAN	802.11b	CH 1	2412	1Mbps	15.90	16.00	98.13
		CH 6	2437		15.76	16.00	
		CH 11	2462		15.94	16.00	
	802.11g	CH 1	2412	6Mbps	14.99	15.00	89.1
		CH 6	2437		14.69	15.00	
		CH 11	2462		14.96	15.00	
	802.11n-HT20	CH 1	2412	MCS0	11.72	12.00	88.44
		CH 6	2437		11.64	12.00	
		CH 11	2462		11.79	12.00	
	802.11n-HT40	CH 3	2422	MCS0	11.48	12.00	78.83
		CH 6	2437		11.28	12.00	
		CH 9	2452		11.26	12.00	

**<5GHz WLAN>**

	Mode	Channel	Frequency (MHz)	Data Rate	Average power (dBm)	Tune-Up Limit	Duty Cycle %
5.2GHz WLAN	802.11a	CH 36	5180	6Mbps	11.48	11.50	88.54
		CH 40	5200		11.45	11.50	
		CH 44	5220		11.46	11.50	
		CH 48	5240		11.47	11.50	
	802.11n-HT20	CH 36	5180	MCS0	11.34	11.50	88.51
		CH 40	5200		11.40	11.50	
		CH 44	5220		11.33	11.50	
		CH 48	5240		11.42	11.50	
	802.11n-HT40	CH 38	5190	MCS0	10.87	11.50	79.56
		CH 46	5230		11.05	11.50	

	Mode	Channel	Frequency (MHz)	Data Rate	Average power (dBm)	Tune-Up Limit	Duty Cycle %
5.3GHz WLAN	802.11a	CH 52	5260	6Mbps	11.47	11.50	88.54
		CH 56	5280		11.45	11.50	
		CH 60	5300		11.41	11.50	
		CH 64	5320		11.14	11.50	
	802.11n-HT20	CH 52	5260	MCS0	11.44	11.50	88.51
		CH 56	5280		11.45	11.50	
		CH 60	5300		11.49	11.50	
		CH 64	5320		11.14	11.50	
	802.11n-HT40	CH 54	5270	MCS0	11.46	11.50	79.56
		CH 62	5310		11.00	11.50	



5.5GHz WLAN	Mode	Channel	Frequency (MHz)	Data Rate	Average power (dBm)	Tune-Up Limit	Duty Cycle %
	802.11a	CH 100	5500	6Mbps	11.16	11.50	88.54
		CH 104	5520		11.40	11.50	
		CH 108	5540		11.45	11.50	
		CH 112	5560		11.10	11.50	
		CH 116	5580		11.44	11.50	
		CH 132	5660		11.48	11.50	
		CH 136	5680		11.01	11.50	
		CH 140	5700		11.49	11.50	
	802.11n-HT20	CH 100	5500	MCS0	11.44	11.50	88.51
CH 104		5520	11.32		11.50		
CH 108		5540	11.02		11.50		
CH 112		5560	11.46		11.50		
CH 116		5580	11.48		11.50		
CH 132		5660	11.10		11.50		
CH 136		5680	11.15		11.50		
CH 140		5700	11.08		11.50		
802.11n-HT40	CH 102	5510	MCS0	10.96	11.50	79.56	
	CH 110	5550		11.32	11.50		
	CH 134	5670		11.32	11.50		

5.8GHz WLAN	Mode	Channel	Frequency (MHz)	Data Rate	Average power (dBm)	Tune-Up Limit	Duty Cycle %
	802.11a	CH 149	5745	6Mbps	11.10	11.50	88.54
		CH 153	5765		11.03	11.50	
		CH 157	5785		11.01	11.50	
		CH 161	5805		11.08	11.50	
		CH 165	5825		11.20	11.50	
	802.11n-HT20	CH 149	5745	MCS0	11.05	11.50	88.51
		CH 153	5765		11.03	11.50	
		CH 157	5785		11.21	11.50	
		CH 161	5805		11.11	11.50	
		CH 165	5825		11.26	11.50	
	802.11n-HT40	CH 151	5755	MCS0	11.49	11.50	79.56
		CH 159	5795		11.24	11.50	

### 13. Antenna Location

<Mobile Phone>

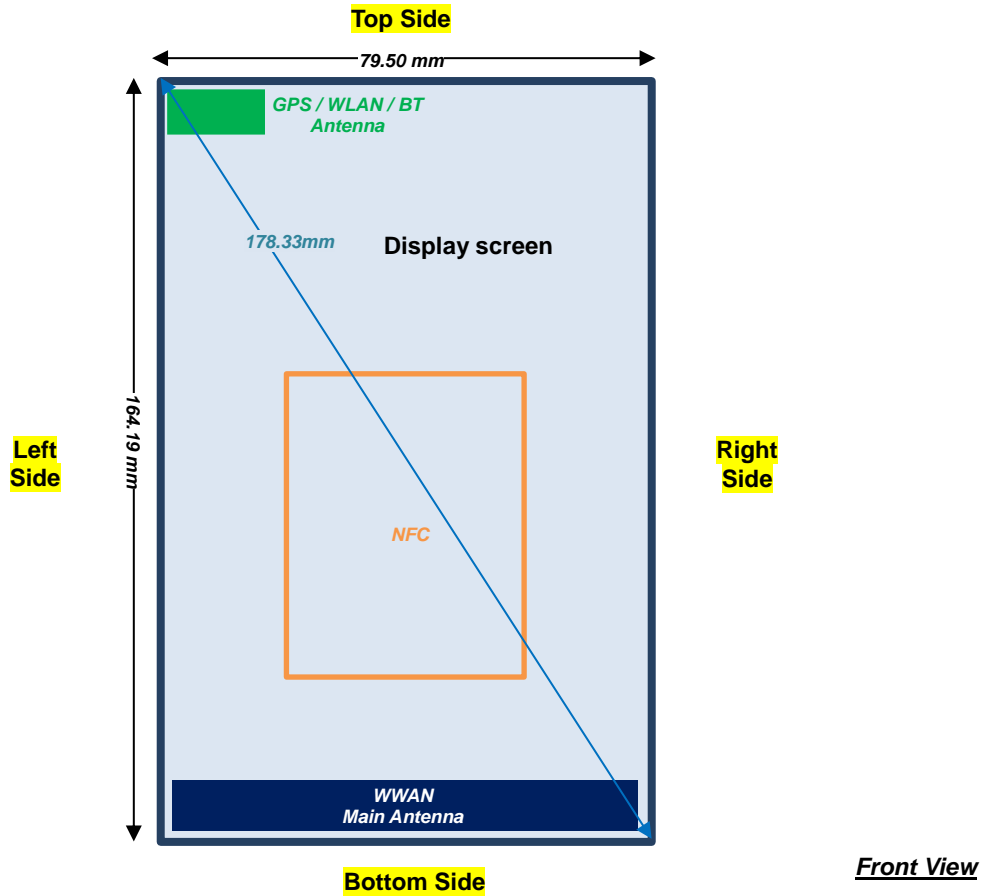

Distance of the Antenna to the EUT surface/edge						
Antennas	Back	Front	Top Side	Bottom Side	Right Side	Left Side
WWAN Main	≤ 25mm	≤ 25mm	> 25mm	≤ 25mm	≤ 25mm	≤ 25mm
BT&WLAN	≤ 25mm	≤ 25mm	≤ 25mm	> 25mm	> 25mm	≤ 25mm
Positions for SAR tests; Hotspot mode						
Antennas	Back	Front	Top Side	Bottom Side	Right Side	Left Side
WWAN Main	Yes	Yes	No	Yes	Yes	Yes
BT&WLAN	Yes	Yes	Yes	No	No	Yes

**General Note:**

- Referring to KDB 941225 D06 v02, when the overall device length and width are ≥ 9cm\*5cm, the test distance is 10 mm. SAR must be measured for all sides and surfaces with a transmitting antenna located within 25mm from that surface or edge



## 14. SAR Test Results

### General Note:

1. Per KDB 447498 D01v05r02, the reported SAR is the measured SAR value adjusted for maximum tune-up tolerance.
  - a. Tune-up scaling Factor = tune-up limit power (mW) / EUT RF power (mW), where tune-up limit is the maximum rated power among all production units.
  - b. For SAR testing of WLAN signal with non-100% duty cycle, the measured SAR is scaled-up by the duty cycle scaling factor which is equal to "1/(duty cycle)"
  - c. For WWAN: Reported SAR(W/kg)= Measured SAR(W/kg)\*Tune-up Scaling Factor
  - d. For WLAN: Reported SAR(W/kg)= Measured SAR(W/kg)\* Duty Cycle scaling factor \* Tune-up scaling factor
2. Per KDB 447498 D01v05r02, for each exposure position, testing of other required channels within the operating mode of a frequency band is not required when the *reported* 1-g or 10-g SAR for the mid-band or highest output power channel is:
  - $\leq 0.8$  W/kg or 2.0 W/kg, for 1-g or 10-g respectively, when the transmission band is  $\leq 100$  MHz
  - $\leq 0.6$  W/kg or 1.5 W/kg, for 1-g or 10-g respectively, when the transmission band is between 100 MHz and 200 MHz
  - $\leq 0.4$  W/kg or 1.0 W/kg, for 1-g or 10-g respectively, when the transmission band is  $\geq 200$  MHz
3. Per KDB 648474 D04v01r02, when the reported SAR for a body-worn accessory measured without a headset connected to the handset is  $\leq 1.2$  W/kg, SAR testing with a headset connected to the handset is not required.
4. Per KDB648474 D04v01r02, for smart phones with a display diagonal dimension  $> 15.0$  cm or an overall diagonal dimension  $> 16.0$  cm, when hotspot mode applies, 10-g extremity SAR is required only for the surfaces and edges with hotspot mode 1-g reported SAR  $> 1.2$  W/kg,
5. Per KDB 941225 D01v03, considering the possibility of e.g. 3rd party VoIP operation for Head and body-worn SAR test reduction for GSM and GPRS and EDGE modes is determined by the source-based time-averaged output power including tune-up tolerance. The mode with highest specified time-averaged output power should be tested for SAR compliance in the applicable exposure conditions. For modes with the same specified maximum output power and tolerance, the higher number time-slot configuration should be tested. Therefore, the EUT was set in GPRS (4Tx slots) for GSM850 and GPRS (3Tx slots) for GSM1900.
6. Per KDB 941225 D01v03, for Hotspot SAR test reduction for GPRS and EDGE modes is determined by the source-based time-averaged output power including tune-up tolerance, for modes with the same specified maximum output power and tolerance, the higher number time-slot configuration should be tested, therefore, the EUT was set in GPRS (4Tx slots) for GSM850 and GPRS (3Tx slots) for GSM1900.
7. Per KDB 941225 D01v03, SAR for Head / Hotspot / Body-worn exposure is measured using a 12.2 kbps RMC with TPC bits configured to all "1's".
8. Per KDB 941225 D01v03, RMC 12.2kbps setting is used to evaluate SAR. If the maximum output power and tune-up tolerance specified for production units in HSDPA / HSUPA / DC-HSDPA is  $\leq \frac{1}{4}$  dB higher than RMC 12.2Kbps or when the highest reported SAR of the RMC12.2Kbps is scaled by the ratio of specified maximum output power and tune-up tolerance of HSDPA / HSUPA / DC-HSDPA to RMC12.2Kbps and the adjusted SAR is  $\leq 1.2$  W/kg, SAR measurement is not required for HSDPA / HSUPA / DC-HSDPA.
9. Per KDB 941225 D05v02r03, start with the largest channel bandwidth and measure SAR for QPSK with 1 RB allocation, using the RB offset and required test channel combination with the highest maximum output power for RB offsets at the upper edge, middle and lower edge of each required test channel.
10. Per KDB 941225 D05v02r03, 50% RB allocation for QPSK SAR testing follows 1RB QPSK allocation procedure.
11. Per KDB 941225 D05v02r03, For QPSK with 100% RB allocation, SAR is not required when the highest maximum output power for 100 % RB allocation is less than the highest maximum output power in 50% and 1 RB allocations and the highest reported SAR for 1 RB and 50% RB allocation are  $\leq 0.8$  W/kg. Otherwise, SAR is measured for the highest output power channel; and if the reported SAR is  $> 1.45$  W/kg, the remaining required test channels must also be tested.
12. Per KDB 941225 D05v02r03, 16QAM output power for each RB allocation configuration is  $>$  not  $\frac{1}{2}$  dB higher than the same configuration in QPSK and the reported SAR for the QPSK configuration is  $\leq 1.45$  W/kg; Per KDB 941225 D05v02r03, 16QAM SAR testing is not required.
13. Per KDB 941225 D05v02r03, Smaller bandwidth output power for each RB allocation configuration is  $>$  not  $\frac{1}{2}$  dB higher than the same configuration in the largest supported bandwidth, and the reported SAR for the largest supported bandwidth is  $\leq 1.45$  W/kg; Per KDB 941225 D05v02r03, smaller bandwidth SAR testing is not required.
14. Per KDB 248227 D01v02r01, for 2.4GHz 802.11g/n SAR testing is not required when the highest reported SAR for DSSS is adjusted by the ratio of OFDM to DSSS specified maximum output power and the adjusted SAR is  $\leq 1.2$  W/kg.
15. Per KDB 248227 D01v02r01, for U-NII-1 Head and Body-worn SAR testing is not required when the U-NII-2A band highest reported SAR for a test configuration is  $\leq 1.2$  W/kg, SAR is not required for U-NII-1 band.
16. During SAR testing the WLAN transmission was verified using a spectrum analyzer.



14.1 Head SAR

<GSM SAR>

Plot No.	Band	Modulation	Mode	Test Position	Gap (mm)	Ch.	Freq. (MHz)	Average Power (dBm)	Tune-Up Limit (dBm)	Tune-up Scaling Factor	Power Drift (dB)	Measured 1g SAR (W/kg)	Reported 1g SAR (W/kg)	Measured 10g SAR (W/kg)	Reported 10g SAR (W/kg)
	GSM850	GMSK	GPRS (4 Tx slots)	Right Cheek	0mm	189	836.4	26.68	27.50	1.208	-0.037	0.125	0.151	0.100	0.121
	GSM850	GMSK	GPRS (4 Tx slots)	Right Tilted	0mm	189	836.4	26.68	27.50	1.208	-0.113	0.074	0.089	0.058	0.070
1	GSM850	GMSK	GPRS (4 Tx slots)	Left Cheek	0mm	189	836.4	26.68	27.50	1.208	0.09	0.157	0.190	0.122	0.147
	GSM850	GMSK	GPRS (4 Tx slots)	Left Tilted	0mm	189	836.4	26.68	27.50	1.208	-0.007	0.072	0.087	0.057	0.069
2	GSM1900	GMSK	GPRS (3 Tx slots)	Right Cheek	0mm	661	1880	25.20	26.00	1.202	-0.067	0.078	0.094	0.052	0.063
	GSM1900	GMSK	GPRS (3 Tx slots)	Right Tilted	0mm	661	1880	25.20	26.00	1.202	-0.183	0.054	0.065	0.035	0.042
	GSM1900	GMSK	GPRS (3 Tx slots)	Left Cheek	0mm	661	1880	25.20	26.00	1.202	-0.028	0.061	0.073	0.040	0.048
	GSM1900	GMSK	GPRS (3 Tx slots)	Left Tilted	0mm	661	1880	25.20	26.00	1.202	-0.151	0.038	0.046	0.024	0.029

<WCDMA SAR>

Plot No.	Band	Modulation	Mode	Test Position	Gap (mm)	Ch.	Freq. (MHz)	Average Power (dBm)	Tune-Up Limit (dBm)	Tune-up Scaling Factor	Power Drift (dB)	Measured 1g SAR (W/kg)	Reported 1g SAR (W/kg)	Measured 10g SAR (W/kg)	Reported 10g SAR (W/kg)
	WCDMA V	QPSK	RMC 12.2Kbps	Right Cheek	0mm	4233	846.6	23.96	24.00	1.009	0.105	0.140	0.141	0.112	0.113
	WCDMA V	QPSK	RMC 12.2Kbps	Right Tilted	0mm	4233	846.6	23.96	24.00	1.009	0.023	0.085	0.086	0.067	0.068
3	WCDMA V	QPSK	RMC 12.2Kbps	Left Cheek	0mm	4233	846.6	23.96	24.00	1.009	0.18	0.190	0.192	0.148	0.149
	WCDMA V	QPSK	RMC 12.2Kbps	Left Tilted	0mm	4233	846.6	23.96	24.00	1.009	-0.054	0.083	0.084	0.066	0.067
4	WCDMA II	QPSK	RMC 12.2Kbps	Right Cheek	0mm	9262	1852.4	24.00	24.00	1.000	-0.002	0.147	0.147	0.097	0.097
	WCDMA II	QPSK	RMC 12.2Kbps	Right Tilted	0mm	9262	1852.4	24.00	24.00	1.000	-0.186	0.100	0.100	0.066	0.066
	WCDMA II	QPSK	RMC 12.2Kbps	Left Cheek	0mm	9262	1852.4	24.00	24.00	1.000	0.165	0.140	0.140	0.091	0.091
	WCDMA II	QPSK	RMC 12.2Kbps	Left Tilted	0mm	9262	1852.4	24.00	24.00	1.000	-0.026	0.068	0.068	0.044	0.044

<LTE SAR>

Plot No.	Band	BW (MHz)	Modulation	RB Size	RB offset	Test Position	Gap (mm)	Ch.	Freq. (MHz)	Average Power (dBm)	Tune-Up Limit (dBm)	Tune-up Scaling Factor	Power Drift (dB)	Measured 1g SAR (W/kg)	Reported 1g SAR (W/kg)	Measured 10g SAR (W/kg)	Reported 10g SAR (W/kg)
	LTE Band 5	10M	QPSK	1RB	0offset	Right Cheek	0mm	20525	836.5	23.69	24.00	1.074	0.031	0.149	0.160	0.119	0.128
	LTE Band 5	10M	QPSK	25RB	0offset	Right Cheek	0mm	20525	836.5	22.61	23.00	1.094	0.136	0.117	0.128	0.092	0.101
	LTE Band 5	10M	QPSK	1RB	0offset	Right Tilted	0mm	20525	836.5	23.69	24.00	1.074	0.069	0.091	0.098	0.071	0.076
	LTE Band 5	10M	QPSK	25RB	0offset	Right Tilted	0mm	20525	836.5	22.61	23.00	1.094	0.096	0.071	0.078	0.056	0.061
5	LTE Band 5	10M	QPSK	1RB	0offset	Left Cheek	0mm	20525	836.5	23.69	24.00	1.074	0.002	0.201	0.216	0.155	0.166
	LTE Band 5	10M	QPSK	25RB	0offset	Left Cheek	0mm	20525	836.5	22.61	23.00	1.094	0.138	0.162	0.177	0.126	0.138
	LTE Band 5	10M	QPSK	1RB	0offset	Left Tilted	0mm	20525	836.5	23.69	24.00	1.074	-0.008	0.091	0.098	0.074	0.079
	LTE Band 5	10M	QPSK	25RB	0offset	Left Tilted	0mm	20525	836.5	22.61	23.00	1.094	0.061	0.072	0.079	0.059	0.065
6	LTE Band 7	20M	QPSK	1RB	0Offset	Right Cheek	0mm	21350	2560	22.97	23.00	1.007	-0.066	0.108	0.109	0.056	0.056
	LTE Band 7	20M	QPSK	50RB	0Offset	Right Cheek	0mm	21350	2560	21.99	22.00	1.002	0.02	0.077	0.077	0.042	0.042
	LTE Band 7	20M	QPSK	1RB	0Offset	Right Tilted	0mm	21350	2560	22.97	23.00	1.007	0.118	0.059	0.059	0.031	0.031
	LTE Band 7	20M	QPSK	50RB	0Offset	Right Tilted	0mm	21350	2560	21.99	22.00	1.002	0.03	0.045	0.045	0.023	0.023
	LTE Band 7	20M	QPSK	1RB	0Offset	Left Cheek	0mm	21350	2560	22.97	23.00	1.007	0.16	0.045	0.045	0.025	0.025
	LTE Band 7	20M	QPSK	50RB	0Offset	Left Cheek	0mm	21350	2560	21.99	22.00	1.002	0.083	0.043	0.043	0.023	0.023
	LTE Band 7	20M	QPSK	1RB	0Offset	Left Tilted	0mm	21350	2560	22.97	23.00	1.007	0.172	0.076	0.077	0.037	0.037
	LTE Band 7	20M	QPSK	50RB	0Offset	Left Tilted	0mm	21350	2560	21.99	22.00	1.002	-0.122	0.073	0.073	0.036	0.036



<WLAN SAR>

Plot No.	Band	Modulation	Mode	Test Position	Gap (mm)	Ch.	Freq. (MHz)	Average Power (dBm)	Tune-Up Limit (dBm)	Tune-up Scaling Factor	Duty Cycle %	Duty Cycle Scaling Factor	Power Drift (dB)	Measured 1g SAR (W/kg)	Reported 1g SAR (W/kg)	Measured 10g SAR (W/kg)	Reported 10g SAR (W/kg)
7	WLAN2.4GHz	DBPSK	802.11b 1Mbps	Right Cheek	0mm	11	2462	15.94	16.00	1.013	98.13	1.019	-0.012	0.648	0.669	0.300	0.310
	WLAN2.4GHz	DBPSK	802.11b 1Mbps	Right Tilted	0mm	11	2462	15.94	16.00	1.013	98.13	1.019	-0.058	0.459	0.474	0.207	0.214
	WLAN2.4GHz	DBPSK	802.11b 1Mbps	Left Cheek	0mm	11	2462	15.94	16.00	1.013	98.13	1.019	0.076	0.291	0.301	0.146	0.151
	WLAN2.4GHz	DBPSK	802.11b 1Mbps	Left Tilted	0mm	11	2462	15.94	16.00	1.013	98.13	1.019	0.09	0.229	0.236	0.112	0.116
8	WLAN5GHz	OFDM	802.11n-HT40 MCS0	Right Cheek	0mm	54	5270	11.46	11.50	1.009	79.56	1.257	0.17	0.473	0.600	0.122	0.155
	WLAN5GHz	OFDM	802.11n-HT40 MCS0	Right Tilted	0mm	54	5270	11.46	11.50	1.009	79.56	1.257	0.11	0.481	0.610	0.127	0.161
	WLAN5GHz	OFDM	802.11n-HT40 MCS0	Left Cheek	0mm	54	5270	11.46	11.50	1.009	79.56	1.257	-0.18	0.316	0.401	0.104	0.132
	WLAN5GHz	OFDM	802.11n-HT40 MCS0	Left Tilted	0mm	54	5270	11.46	11.50	1.009	79.56	1.257	-0.06	0.356	0.451	0.119	0.151
9	WLAN5GHz	OFDM	802.11n-HT40 MCS0	Right Cheek	0mm	110	5550	11.32	11.50	1.042	79.56	1.257	0.05	0.407	0.533	0.114	0.149
	WLAN5GHz	OFDM	802.11n-HT40 MCS0	Right Tilted	0mm	110	5550	11.32	11.50	1.042	79.56	1.257	0.05	0.433	0.567	0.118	0.154
	WLAN5GHz	OFDM	802.11n-HT40 MCS0	Left Cheek	0mm	110	5550	11.32	11.50	1.042	79.56	1.257	-0.07	0.262	0.343	0.065	0.085
	WLAN5GHz	OFDM	802.11n-HT40 MCS0	Left Tilted	0mm	110	5550	11.32	11.50	1.042	79.56	1.257	-0.11	0.320	0.419	0.081	0.106
10	WLAN5GHz	OFDM	802.11n-HT40 MCS0	Right Cheek	0mm	151	5755	11.49	11.50	1.002	79.56	1.257	0.03	0.563	0.709	0.143	0.180
	WLAN5GHz	OFDM	802.11n-HT40 MCS0	Right Tilted	0mm	151	5755	11.49	11.50	1.002	79.56	1.257	0.07	0.620	0.781	0.153	0.193
	WLAN5GHz	OFDM	802.11n-HT40 MCS0	Left Cheek	0mm	151	5755	11.49	11.50	1.002	79.56	1.257	-0.05	0.456	0.574	0.109	0.137
	WLAN5GHz	OFDM	802.11n-HT40 MCS0	Left Tilted	0mm	151	5755	11.49	11.50	1.002	79.56	1.257	-0.14	0.482	0.607	0.120	0.151

14.2 Hotspot SAR

<GSM SAR>

Plot No.	Band	Modulation	Mode	Test Position	Gap (mm)	Ch.	Freq. (MHz)	Average Power (dBm)	Tune-Up Limit (dBm)	Tune-up Scaling Factor	Power Drift (dB)	Measured 1g SAR (W/kg)	Reported 1g SAR (W/kg)	Measured 10g SAR (W/kg)	Reported 10g SAR (W/kg)
11	GSM850	GMSK	GPRS (4 Tx slots)	Front	10mm	189	836.4	26.68	27.50	1.208	-0.07	0.187	0.226	0.119	0.144
	GSM850	GMSK	GPRS (4 Tx slots)	Back	10mm	189	836.4	26.68	27.50	1.208	-0.032	0.421	0.508	0.235	0.284
	GSM850	GMSK	GPRS (4 Tx slots)	Left Side	10mm	189	836.4	26.68	27.50	1.208	0.073	0.228	0.275	0.157	0.190
	GSM850	GMSK	GPRS (4 Tx slots)	Right Side	10mm	189	836.4	26.68	27.50	1.208	-0.057	0.088	0.106	0.060	0.072
	GSM850	GMSK	GPRS (4 Tx slots)	Bottom Side	10mm	189	836.4	26.68	27.50	1.208	0.049	0.153	0.185	0.087	0.105
12	GSM1900	GMSK	GPRS (3 Tx slots)	Front	10mm	661	1880	25.20	26.00	1.202	-0.002	0.199	0.239	0.114	0.137
	GSM1900	GMSK	GPRS (3 Tx slots)	Back	10mm	661	1880	25.20	26.00	1.202	0.046	0.276	0.332	0.154	0.185
	GSM1900	GMSK	GPRS (3 Tx slots)	Left Side	10mm	661	1880	25.20	26.00	1.202	0.088	0.095	0.114	0.055	0.066
	GSM1900	GMSK	GPRS (3 Tx slots)	Right Side	10mm	661	1880	25.20	26.00	1.202	0.114	0.112	0.135	0.065	0.078
	GSM1900	GMSK	GPRS (3 Tx slots)	Bottom Side	10mm	661	1880	25.20	26.00	1.202	0.088	0.270	0.325	0.152	0.183

<WCDMA SAR>

Plot No.	Band	Modulation	Mode	Test Position	Gap (mm)	Ch.	Freq. (MHz)	Average Power (dBm)	Tune-Up Limit (dBm)	Tune-up Scaling Factor	Power Drift (dB)	Measured 1g SAR (W/kg)	Reported 1g SAR (W/kg)	Measured 10g SAR (W/kg)	Reported 10g SAR (W/kg)
13	WCDMA V	QPSK	RMC 12.2Kbps	Front	10mm	4233	846.6	23.96	24.00	1.009	-0.025	0.249	0.251	0.152	0.153
	WCDMA V	QPSK	RMC 12.2Kbps	Back	10mm	4233	846.6	23.96	24.00	1.009	-0.075	0.591	0.596	0.326	0.329
	WCDMA V	QPSK	RMC 12.2Kbps	Left Side	10mm	4233	846.6	23.96	24.00	1.009	-0.049	0.353	0.356	0.244	0.246
	WCDMA V	QPSK	RMC 12.2Kbps	Right Side	10mm	4233	846.6	23.96	24.00	1.009	-0.073	0.115	0.116	0.080	0.081
	WCDMA V	QPSK	RMC 12.2Kbps	Bottom Side	10mm	4233	846.6	23.96	24.00	1.009	0.034	0.183	0.185	0.104	0.105
14	WCDMA II	QPSK	RMC 12.2Kbps	Front	10mm	9262	1852.4	24.00	24.00	1.000	0.022	0.523	0.523	0.306	0.306
	WCDMA II	QPSK	RMC 12.2Kbps	Back	10mm	9262	1852.4	24.00	24.00	1.000	0.01	1.020	1.020	0.519	0.519
	WCDMA II	QPSK	RMC 12.2Kbps	Back	10mm	9400	1880	23.94	24.00	1.014	-0.008	0.885	0.897	0.491	0.498
	WCDMA II	QPSK	RMC 12.2Kbps	Back	10mm	9538	1732.6	23.93	24.00	1.016	-0.065	0.955	0.971	0.508	0.516
	WCDMA II	QPSK	RMC 12.2Kbps	Left Side	10mm	9262	1852.4	24.00	24.00	1.000	-0.019	0.229	0.229	0.136	0.136
	WCDMA II	QPSK	RMC 12.2Kbps	Right Side	10mm	9262	1852.4	24.00	24.00	1.000	0.064	0.329	0.329	0.194	0.194
	WCDMA II	QPSK	RMC 12.2Kbps	Bottom Side	10mm	9262	1852.4	24.00	24.00	1.000	-0.033	0.594	0.594	0.336	0.336



<LTE SAR>

Plot No.	Band	BW (MHz)	Modulation	RB Size	RB offset	Test Position	Gap (mm)	Ch.	Freq. (MHz)	Average Power (dBm)	Tune-Up Limit (dBm)	Tune-up Scaling Factor	Power Drift (dB)	Measured 1g SAR (W/kg)	Reported 1g SAR (W/kg)	Measured 10g SAR (W/kg)	Reported 10g SAR (W/kg)
	LTE Band 5	10M	QPSK	1RB	0offset	Front	10mm	20525	836.5	23.69	24.00	1.074	-0.018	0.223	0.239	0.141	0.151
	LTE Band 5	10M	QPSK	25RB	0offset	Front	10mm	20525	836.5	22.61	23.00	1.094	-0.023	0.181	0.198	0.114	0.125
15	LTE Band 5	10M	QPSK	1RB	0offset	Back	10mm	20525	836.5	23.69	24.00	1.074	-0.079	0.450	0.483	0.254	0.273
	LTE Band 5	10M	QPSK	25RB	0offset	Back	10mm	20525	836.5	22.61	23.00	1.094	-0.094	0.367	0.401	0.206	0.225
	LTE Band 5	10M	QPSK	1RB	0offset	Left Side	10mm	20525	836.5	23.69	24.00	1.074	-0.08	0.347	0.373	0.239	0.257
	LTE Band 5	10M	QPSK	25RB	0offset	Left Side	10mm	20525	836.5	22.61	23.00	1.094	-0.037	0.267	0.292	0.184	0.201
	LTE Band 5	10M	QPSK	1RB	0offset	Right Side	10mm	20525	836.5	23.69	24.00	1.074	-0.033	0.141	0.151	0.097	0.104
	LTE Band 5	10M	QPSK	25RB	0offset	Right Side	10mm	20525	836.5	22.61	23.00	1.094	-0.046	0.109	0.119	0.075	0.082
	LTE Band 5	10M	QPSK	1RB	0offset	Bottom Side	10mm	20525	836.5	23.69	24.00	1.074	0.052	0.174	0.187	0.093	0.100
	LTE Band 5	10M	QPSK	25RB	0offset	Bottom Side	10mm	20525	836.5	22.61	23.00	1.094	-0.045	0.141	0.154	0.076	0.083
	LTE Band 7	20M	QPSK	1RB	0Offset	Front	10mm	21350	2560	22.97	23.00	1.007	-0.14	0.362	0.365	0.192	0.193
	LTE Band 7	20M	QPSK	50RB	0Offset	Front	10mm	21350	2560	21.99	22.00	1.002	-0.1	0.286	0.287	0.152	0.152
16	LTE Band 7	20M	QPSK	1RB	0Offset	Back	10mm	21350	2560	22.97	23.00	1.007	-0.05	0.390	0.393	0.204	0.205
	LTE Band 7	20M	QPSK	50RB	0Offset	Back	10mm	21350	2560	21.99	22.00	1.002	-0.07	0.313	0.314	0.164	0.164
	LTE Band 7	20M	QPSK	1RB	0Offset	Left Side	10mm	21350	2560	22.97	23.00	1.007	-0.11	0.069	0.069	0.038	0.038
	LTE Band 7	20M	QPSK	50RB	0Offset	Left Side	10mm	21350	2560	21.99	22.00	1.002	-0.14	0.056	0.056	0.031	0.031
	LTE Band 7	20M	QPSK	1RB	0Offset	Right Side	10mm	21350	2560	22.97	23.00	1.007	-0.12	0.142	0.143	0.077	0.078
	LTE Band 7	20M	QPSK	50RB	0Offset	Right Side	10mm	21350	2560	21.99	22.00	1.002	-0.15	0.108	0.108	0.060	0.060
	LTE Band 7	20M	QPSK	1RB	0Offset	Bottom Side	10mm	21350	2560	22.97	23.00	1.007	-0.09	0.316	0.318	0.151	0.152
	LTE Band 7	20M	QPSK	50RB	0Offset	Bottom Side	10mm	21350	2560	21.99	22.00	1.002	-0.19	0.251	0.252	0.120	0.120

<WLAN SAR>

Plot No.	Band	Modulation	Mode	Test Position	Gap (mm)	Ch.	Freq. (MHz)	Average Power (dBm)	Tune-Up Limit (dBm)	Tune-up Scaling Factor	Duty Cycle %	Duty Cycle Scaling Factor	Power Drift (dB)	Measured 1g SAR (W/kg)	Reported 1g SAR (W/kg)	Measured 10g SAR (W/kg)	Reported 10g SAR (W/kg)
	WLAN2.4GHz	DBPSK	802.11b 1Mbps	Front	10mm	11	2462	15.94	16.00	1.013	98.13	1.019	-0.021	0.165	0.170	0.085	0.088
17	WLAN2.4GHz	DBPSK	802.11b 1Mbps	Back	10mm	11	2462	15.94	16.00	1.013	98.13	1.019	0.009	0.197	0.203	0.088	0.091
	WLAN2.4GHz	DBPSK	802.11b 1Mbps	Left Side	10mm	11	2462	15.94	16.00	1.013	98.13	1.019	-0.071	0.107	0.110	0.053	0.055
	WLAN2.4GHz	DBPSK	802.11b 1Mbps	Top Side	10mm	11	2462	15.94	16.00	1.013	98.13	1.019	-0.011	0.078	0.081	0.042	0.043
	WLAN5GHz	OFDM	802.11n-HT40 MCS0	Front	10mm	46	5230	11.05	11.50	1.108	79.56	1.257	-0.04	0.116	0.162	0.051	0.071
	WLAN5GHz	OFDM	802.11n-HT40 MCS0	Back	10mm	46	5230	11.05	11.50	1.108	79.56	1.257	-0.09	0.152	0.212	0.068	0.095
	WLAN5GHz	OFDM	802.11n-HT40 MCS0	Left Side	10mm	46	5230	11.05	11.50	1.108	79.56	1.257	-0.02	0.078	0.109	0.045	0.063
18	WLAN5GHz	OFDM	802.11n-HT40 MCS0	Top Side	10mm	46	5230	11.05	11.50	1.108	79.56	1.257	-0.17	0.225	0.313	0.095	0.132

14.3 Body Worn Accessory SAR

<GSM SAR>

Plot No.	Band	Modulation	Mode	Test Position	Gap (mm)	Ch.	Freq. (MHz)	Average Power (dBm)	Tune-Up Limit (dBm)	Tune-up Scaling Factor	Power Drift (dB)	Measured 1g SAR (W/kg)	Reported 1g SAR (W/kg)	Measured 10g SAR (W/kg)	Reported 10g SAR (W/kg)
	GSM850	GMSK	GPRS (4 Tx slots)	Front	15mm	189	836.4	26.68	27.50	1.208	-0.019	0.160	0.193	0.123	0.149
19	GSM850	GMSK	GPRS (4 Tx slots)	Back	15mm	189	836.4	26.68	27.50	1.208	-0.048	0.217	0.262	0.162	0.196
	GSM1900	GMSK	GPRS (3 Tx slots)	Front	15mm	661	1880	25.20	26.00	1.202	-0.05	0.114	0.137	0.070	0.084
20	GSM1900	GMSK	GPRS (3 Tx slots)	Back	15mm	661	1880	25.20	26.00	1.202	0.008	0.140	0.168	0.083	0.100

<WCDMA SAR>

Plot No.	Band	Modulation	Mode	Test Position	Gap (mm)	Ch.	Freq. (MHz)	Average Power (dBm)	Tune-Up Limit (dBm)	Tune-up Scaling Factor	Power Drift (dB)	Measured 1g SAR (W/kg)	Reported 1g SAR (W/kg)	Measured 10g SAR (W/kg)	Reported 10g SAR (W/kg)
	WCDMA V	QPSK	RMC 12.2Kbps	Front	15mm	4233	846.6	23.96	24.00	1.009	-0.066	0.200	0.202	0.124	0.125
21	WCDMA V	QPSK	RMC 12.2Kbps	Back	15mm	4233	846.6	23.96	24.00	1.009	-0.083	0.251	0.253	0.146	0.147
	WCDMA II	QPSK	RMC 12.2Kbps	Front	15mm	9262	1852.4	24.00	24.00	1.000	0.016	0.326	0.326	0.199	0.199
22	WCDMA II	QPSK	RMC 12.2Kbps	Back	15mm	9262	1852.4	24.00	24.00	1.000	0.006	0.373	0.373	0.221	0.221

<LTE SAR>

Plot No.	Band	BW (MHz)	Modulation	RB Size	RB offset	Test Position	Gap (mm)	Ch.	Freq. (MHz)	Average Power (dBm)	Tune-Up Limit (dBm)	Tune-up Scaling Factor	Power Drift (dB)	Measured 1g SAR (W/kg)	Reported 1g SAR (W/kg)	Measured 10g SAR (W/kg)	Reported 10g SAR (W/kg)
	LTE Band 5	10M	QPSK	1RB	0offset	Front	15mm	20525	836.5	23.69	24.00	1.074	-0.057	0.202	0.217	0.155	0.166
	LTE Band 5	10M	QPSK	25RB	0offset	Front	15mm	20525	836.5	22.61	23.00	1.094	-0.087	0.159	0.174	0.122	0.133
23	LTE Band 5	10M	QPSK	1RB	0offset	Back	15mm	20525	836.5	23.69	24.00	1.074	-0.054	0.262	0.281	0.195	0.209
	LTE Band 5	10M	QPSK	25RB	0offset	Back	15mm	20525	836.5	22.61	23.00	1.094	-0.083	0.209	0.229	0.156	0.171
	LTE Band 7	20M	QPSK	1RB	0Offset	Front	15mm	21350	2560	22.97	23.00	1.007	-0.11	0.172	0.173	0.096	0.097
	LTE Band 7	20M	QPSK	50RB	0Offset	Front	15mm	21350	2560	21.99	22.00	1.002	-0.15	0.133	0.133	0.075	0.075
24	LTE Band 7	20M	QPSK	1RB	0Offset	Back	15mm	21350	2560	22.97	23.00	1.007	-0.07	0.217	0.219	0.119	0.120
	LTE Band 7	20M	QPSK	50RB	0Offset	Back	15mm	21350	2560	21.99	22.00	1.002	-0.14	0.171	0.171	0.093	0.093

<WLAN SAR>

Plot No.	Band	Modulation	Mode	Test Position	Gap (mm)	Ch.	Freq. (MHz)	Average Power (dBm)	Tune-Up Limit (dBm)	Tune-up Scaling Factor	Duty Cycle %	Duty Cycle Scaling Factor	Power Drift (dB)	Measured 1g SAR (W/kg)	Reported 1g SAR (W/kg)	Measured 10g SAR (W/kg)	Reported 10g SAR (W/kg)
	WLAN2.4GHz	DBPSK	802.11b 1Mbps	Front	15mm	11	2462	15.94	16.00	1.013	98.13	1.019	-0.016	0.087	0.090	0.042	0.043
25	WLAN2.4GHz	DBPSK	802.11b 1Mbps	Back	15mm	11	2462	15.94	16.00	1.013	98.13	1.019	0.058	0.088	0.091	0.043	0.044
	WLAN5GHz	OFDM	802.11n-HT40 MCS0	Front	15mm	54	5270	11.46	11.50	1.009	79.56	1.257	-0.09	0.076	0.096	0.041	0.052
26	WLAN5GHz	OFDM	802.11n-HT40 MCS0	Back	15mm	54	5270	11.46	11.50	1.009	79.56	1.257	-0.05	0.094	0.119	0.052	0.066
	WLAN5GHz	OFDM	802.11n-HT40 MCS0	Front	15mm	110	5550	11.32	11.50	1.042	79.56	1.257	-0.12	0.080	0.105	0.046	0.060
27	WLAN5GHz	OFDM	802.11n-HT40 MCS0	Back	15mm	110	5550	11.32	11.50	1.042	79.56	1.257	-0.13	0.091	0.119	0.049	0.064
	WLAN5GHz	OFDM	802.11n-HT40 MCS0	Front	15mm	151	5755	11.49	11.50	1.002	79.56	1.257	-0.05	0.102	0.128	0.053	0.067
28	WLAN5GHz	OFDM	802.11n-HT40 MCS0	Back	15mm	151	5755	11.49	11.50	1.002	79.56	1.257	-0.05	0.113	0.142	0.061	0.077

14.4 Repeated SAR Measurement

No.	Band	Modulation	Mode	Test Position	Gap (mm)	Ch.	Freq. (MHz)	Average Power (dBm)	Tune-Up Limit (dBm)	Tune-up Scaling Factor	Power Drift (dB)	Measured 1g SAR (W/kg)	Ratio	Reported 1g SAR (W/kg)
1st	WCDMA II	QPSK	RMC 12.2Kbps	Back	10mm	9262	1852.4	24.00	24.00	1.000	0.01	1.020	-	1.020
2nd	WCDMA II	QPSK	RMC 12.2Kbps	Back	10mm	9262	1852.4	24.00	24.00	1.000	0.06	1.010	1.01	1.010

General Note:

1. Per KDB 865664 D01v01r03, for each frequency band, repeated SAR measurement is required only when the measured SAR is  $\geq 0.8W/kg$ .
2. Per KDB 865664 D01v01r03, if the ratio among the repeated measurement is  $\leq 1.2$  and the measured SAR  $< 1.45W/kg$ , only one repeated measurement is required.
3. The ratio is the difference in percentage between original and repeated *measured SAR*.
4. All measurement SAR result is scaled-up to account for tune-up tolerance and is compliant.



**15. Simultaneous Transmission Analysis**

NO.	Simultaneous Transmission Configurations	Portable Handset			Note
		Head	Body-worn	Hotspot	
1.	GSM(Voice) + WLAN2.4GHz(data)	Yes	Yes		
2.	WCDMA(Voice) + WLAN2.4GHz(data)	Yes	Yes		
3.	GSM(Voice) + Bluetooth(data)	Yes	Yes		
4.	WCDMA((Voice) + Bluetooth(data)	Yes	Yes		
5.	GSM(Voice) + WLAN5GHz(data)	Yes	Yes		
6.	WCDMA((Voice) + WLAN5GHz(data)	Yes	Yes		
7.	GPRS/EDGE(Data) + WLAN2.4GHz(data)	Yes	Yes	Yes	2.4GHz Hotspot
8.	WCDMA(Data) + WLAN2.4GHz(data)	Yes	Yes	Yes	2.4GHz Hotspot
9.	LTE(Data) + WLAN2.4GHz(data)	Yes	Yes	Yes	2.4GHz Hotspot
10.	GPRS/EDGE(Data) + Bluetooth(data)	Yes	Yes	Yes	Bluetooth Tethering
11.	WCDMA(Data) + Bluetooth(data)	Yes	Yes	Yes	Bluetooth Tethering
12.	LTE(Data) + Bluetooth(data)	Yes	Yes	Yes	Bluetooth Tethering
13.	GPRS/EDGE(data) + WLAN5GHz(data)	Yes	Yes	Yes	WiFi Direct
14.	WCDMA(data) + WLAN5GHz(data)	Yes	Yes	Yes	WiFi Direct
15.	LTE(data) + WLAN5GHz(data)	Yes	Yes	Yes	WiFi Direct

**General Note:**

- This device supported VoIP in EGPRS, WCDMA, LTE (e.g. 3rd party VoIP).
- This device 2.4GHz WLAN supports Hotspot, and 5.2GHz WLAN supports WiFi Direct (Group Client / Group Owner), and 5.3GHz / 5.5GHz / 5.8GHz supports WiFi Direct (Group Client only).
- The worst case WLAN reported SAR for each configuration was used for SAR summation. Therefore, the following summations represent the absolute worst cases for simultaneous transmission with WLAN.
- WLAN and Bluetooth share the same antenna, and cannot transmit simultaneously.
- EUT will choose either WLAN 2.4GHz or WLAN 5GHz according to the network signal condition; therefore, 2.4GHz WLAN and 5GHz WLAN will not operate simultaneously at any moment.
- The Scaled SAR summation is calculated based on the same configuration and test position.
- Per KDB 447498 D01v05r02, simultaneous transmission SAR is compliant if,
  - Scalar SAR summation < 1.6W/kg.
  - $SPLSR = (SAR1 + SAR2)^{1.5} / (\text{min. separation distance, mm})$ , and the peak separation distance is determined from the square root of  $[(x1-x2)^2 + (y1-y2)^2 + (z1-z2)^2]$ , where (x1, y1, z1) and (x2, y2, z2) are the coordinates of the extrapolated peak SAR locations in the zoom scan.
  - If  $SPLSR \leq 0.04$ , simultaneously transmission SAR measurement is not necessary.
  - Simultaneously transmission SAR measurement, and the reported multi-band SAR < 1.6W/kg.
- For simultaneous transmission analysis, Bluetooth SAR is estimated per KDB 447498 D01v05r02 based on the formula below.
  - $(\text{max. power of channel, including tune-up tolerance, mW}) / (\text{min. test separation distance, mm}) \cdot [\sqrt{f(\text{GHz})} / x] \text{ W/kg}$  for test separation distances  $\leq 50 \text{ mm}$ ; where  $x = 7.5$  for 1-g SAR, and  $x = 18.75$  for 10-g SAR.
  - When the minimum separation distance is < 5mm, the distance is used 5mm to determine SAR test exclusion.
  - 0.4 W/kg for 1-g SAR and 1.0 W/kg for 10-g SAR, when the test separation distances is > 50 mm.

Bluetooth Max Power	Exposure Position	Head	Hotspot	Body-worn
	Test separation	0 mm	10 mm	15 mm
7.0 dBm	Estimated 1g SAR (W/kg)	0.210 W/kg	0.105 W/kg	0.070 W/kg
	Estimated 10g SAR (W/kg)	0.084 W/kg	0.042 W/kg	0.028 W/kg



**15.1 Head Exposure Conditions**

WWAN Band		Exposure Position	1	2	3	4	1+2 Summed 1g SAR (W/kg)	1+3 Summed 1g SAR (W/kg)	1+4 Summed 1g SAR (W/kg)
			WWAN 1g SAR (W/kg)	2.4GHz WLAN 1g SAR (W/kg)	2.4GHz Bluetooth Estimated 1g SAR (W/kg)	5GHz WLAN 1g SAR (W/kg)			
GSM	GSM850	Right Cheek	0.151	0.669	0.210	0.709	<b>0.82</b>	<b>0.36</b>	<b>0.86</b>
		Right Tilted	0.089	0.474	0.210	0.781	<b>0.56</b>	<b>0.30</b>	<b>0.87</b>
		Left Cheek	0.190	0.301	0.210	0.574	<b>0.49</b>	<b>0.40</b>	<b>0.76</b>
		Left Tilted	0.087	0.236	0.210	0.607	<b>0.32</b>	<b>0.30</b>	<b>0.69</b>
	GSM1900	Right Cheek	0.094	0.669	0.210	0.709	<b>0.76</b>	<b>0.30</b>	<b>0.80</b>
		Right Tilted	0.065	0.474	0.210	0.781	<b>0.54</b>	<b>0.28</b>	<b>0.85</b>
		Left Cheek	0.073	0.301	0.210	0.574	<b>0.37</b>	<b>0.28</b>	<b>0.65</b>
		Left Tilted	0.046	0.236	0.210	0.607	<b>0.28</b>	<b>0.26</b>	<b>0.65</b>
WCDMA	WCDMA V	Right Cheek	0.141	0.669	0.210	0.709	<b>0.81</b>	<b>0.35</b>	<b>0.85</b>
		Right Tilted	0.086	0.474	0.210	0.781	<b>0.56</b>	<b>0.30</b>	<b>0.87</b>
		Left Cheek	0.192	0.301	0.210	0.574	<b>0.49</b>	<b>0.40</b>	<b>0.77</b>
		Left Tilted	0.084	0.236	0.210	0.607	<b>0.32</b>	<b>0.29</b>	<b>0.69</b>
	WCDMA II	Right Cheek	0.147	0.669	0.210	0.709	<b>0.82</b>	<b>0.36</b>	<b>0.86</b>
		Right Tilted	0.100	0.474	0.210	0.781	<b>0.57</b>	<b>0.31</b>	<b>0.88</b>
		Left Cheek	0.140	0.301	0.210	0.574	<b>0.44</b>	<b>0.35</b>	<b>0.71</b>
		Left Tilted	0.068	0.236	0.210	0.607	<b>0.30</b>	<b>0.28</b>	<b>0.68</b>
LTE	LTE Band 5	Right Cheek	0.160	0.669	0.210	0.709	<b>0.83</b>	<b>0.37</b>	<b>0.87</b>
		Right Tilted	0.098	0.474	0.210	0.781	<b>0.57</b>	<b>0.31</b>	<b>0.88</b>
		Left Cheek	0.216	0.301	0.210	0.574	<b>0.52</b>	<b>0.43</b>	<b>0.79</b>
		Left Tilted	0.098	0.236	0.210	0.607	<b>0.33</b>	<b>0.31</b>	<b>0.71</b>
	LTE Band 7	Right Cheek	0.109	0.669	0.210	0.709	<b>0.78</b>	<b>0.32</b>	<b>0.82</b>
		Right Tilted	0.059	0.474	0.210	0.781	<b>0.53</b>	<b>0.27</b>	<b>0.84</b>
		Left Cheek	0.045	0.301	0.210	0.574	<b>0.35</b>	<b>0.26</b>	<b>0.62</b>
		Left Tilted	0.077	0.236	0.210	0.607	<b>0.31</b>	<b>0.29</b>	<b>0.68</b>



WWAN Band		Exposure Position	1	2	3	4	1+2 Summed 10g SAR (W/kg)	1+3 Summed 10g SAR (W/kg)	1+4 Summed 10g SAR (W/kg)
			WWAN	2.4GHz WLAN	2.4GHz Bluetooth	5GHz WLAN			
			10g SAR (W/kg)	10g SAR (W/kg)	Estimated 10g SAR (W/kg)	10g SAR (W/kg)			
GSM	GSM850	Right Cheek	0.121	0.310	0.084	0.180	<b>0.43</b>	<b>0.21</b>	<b>0.30</b>
		Right Tilted	0.070	0.214	0.084	0.193	<b>0.28</b>	<b>0.15</b>	<b>0.26</b>
		Left Cheek	0.147	0.151	0.084	0.137	<b>0.30</b>	<b>0.23</b>	<b>0.28</b>
		Left Tilted	0.069	0.116	0.084	0.151	<b>0.19</b>	<b>0.15</b>	<b>0.22</b>
	GSM1900	Right Cheek	0.063	0.310	0.084	0.180	<b>0.37</b>	<b>0.15</b>	<b>0.24</b>
		Right Tilted	0.042	0.214	0.084	0.193	<b>0.26</b>	<b>0.13</b>	<b>0.24</b>
		Left Cheek	0.048	0.151	0.084	0.137	<b>0.20</b>	<b>0.13</b>	<b>0.19</b>
		Left Tilted	0.029	0.116	0.084	0.151	<b>0.15</b>	<b>0.11</b>	<b>0.18</b>
WCDMA	WCDMA V	Right Cheek	0.113	0.310	0.084	0.180	<b>0.42</b>	<b>0.20</b>	<b>0.29</b>
		Right Tilted	0.068	0.214	0.084	0.193	<b>0.28</b>	<b>0.15</b>	<b>0.26</b>
		Left Cheek	0.149	0.151	0.084	0.137	<b>0.30</b>	<b>0.23</b>	<b>0.29</b>
		Left Tilted	0.067	0.116	0.084	0.151	<b>0.18</b>	<b>0.15</b>	<b>0.22</b>
	WCDMA II	Right Cheek	0.097	0.310	0.084	0.180	<b>0.41</b>	<b>0.18</b>	<b>0.28</b>
		Right Tilted	0.066	0.214	0.084	0.193	<b>0.28</b>	<b>0.15</b>	<b>0.26</b>
		Left Cheek	0.091	0.151	0.084	0.137	<b>0.24</b>	<b>0.18</b>	<b>0.23</b>
		Left Tilted	0.044	0.116	0.084	0.151	<b>0.16</b>	<b>0.13</b>	<b>0.20</b>
LTE	LTE Band 5	Right Cheek	0.128	0.310	0.084	0.180	<b>0.44</b>	<b>0.21</b>	<b>0.31</b>
		Right Tilted	0.076	0.214	0.084	0.193	<b>0.29</b>	<b>0.16</b>	<b>0.27</b>
		Left Cheek	0.166	0.151	0.084	0.137	<b>0.32</b>	<b>0.25</b>	<b>0.30</b>
		Left Tilted	0.079	0.116	0.084	0.151	<b>0.20</b>	<b>0.16</b>	<b>0.23</b>
	LTE Band 7	Right Cheek	0.056	0.310	0.084	0.180	<b>0.37</b>	<b>0.14</b>	<b>0.24</b>
		Right Tilted	0.031	0.214	0.084	0.193	<b>0.25</b>	<b>0.12</b>	<b>0.22</b>
		Left Cheek	0.025	0.151	0.084	0.137	<b>0.18</b>	<b>0.11</b>	<b>0.16</b>
		Left Tilted	0.037	0.116	0.084	0.151	<b>0.15</b>	<b>0.12</b>	<b>0.19</b>



**15.2 Hotspot Exposure Conditions**

WWAN Band	Exposure Position	1	2	3	4	1+2 Summed 1g SAR (W/kg)	1+3 Summed 1g SAR (W/kg)	1+4 Summed 1g SAR (W/kg)	
		WWAN	2.4GHz WLAN	2.4GHz Bluetooth	5GHz WLAN				
		1g SAR (W/kg)	1g SAR (W/kg)	Estimated 1g SAR (W/kg)	1g SAR (W/kg)				
GSM	GSM850	Front	0.226	0.170	0.105	0.162	0.40	0.33	0.39
		Back	0.508	0.203	0.105	0.212	0.71	0.61	0.72
		Left side	0.275	0.110	0.105	0.109	0.39	0.38	0.38
		Right side	0.106				0.11	0.11	0.11
		Top side		0.081	0.105	0.313	0.08	0.11	0.31
		Bottom side	0.185				0.19	0.19	0.19
	GSM1900	Front	0.239	0.170	0.105	0.162	0.41	0.34	0.40
		Back	0.332	0.203	0.105	0.212	0.54	0.44	0.54
		Left side	0.114	0.110	0.105	0.109	0.22	0.22	0.22
		Right side	0.135				0.14	0.14	0.14
		Top side		0.081	0.105	0.313	0.08	0.11	0.31
		Bottom side	0.325				0.33	0.33	0.33
WCDMA	WCDMA V	Front	0.251	0.170	0.105	0.162	0.42	0.36	0.41
		Back	0.596	0.203	0.105	0.212	0.80	0.70	0.81
		Left side	0.356	0.110	0.105	0.109	0.47	0.46	0.47
		Right side	0.116				0.12	0.12	0.12
		Top side		0.081	0.105	0.313	0.08	0.11	0.31
		Bottom side	0.185				0.19	0.19	0.19
	WCDMA II	Front	0.523	0.170	0.105	0.162	0.69	0.63	0.69
		Back	1.020	0.203	0.105	0.212	1.22	1.13	1.23
		Left side	0.229	0.110	0.105	0.109	0.34	0.33	0.34
		Right side	0.329				0.33	0.33	0.33
		Top side		0.081	0.105	0.313	0.08	0.11	0.31
		Bottom side	0.594				0.59	0.59	0.59
LTE	LTE Band 5	Front	0.239	0.170	0.105	0.162	0.41	0.34	0.40
		Back	0.483	0.203	0.105	0.212	0.69	0.59	0.70
		Left side	0.373	0.110	0.105	0.109	0.48	0.48	0.48
		Right side	0.151				0.15	0.15	0.15
		Top side		0.081	0.105	0.313	0.08	0.11	0.31
		Bottom side	0.187				0.19	0.19	0.19
	LTE Band 7	Front	0.365	0.170	0.105	0.162	0.54	0.47	0.53
		Back	0.393	0.203	0.105	0.212	0.60	0.50	0.61
		Left side	0.069	0.110	0.105	0.109	0.18	0.17	0.18
		Right side	0.143				0.14	0.14	0.14
		Top side		0.081	0.105	0.313	0.08	0.11	0.31
		Bottom side	0.318				0.32	0.32	0.32



WWAN Band		Exposure Position	1	2	3	4	1+2 Summed 10g SAR (W/kg)	1+3 Summed 10g SAR (W/kg)	1+4 Summed 10g SAR (W/kg)
			WWAN 10g SAR (W/kg)	2.4GHz WLAN 10g SAR (W/kg)	2.4GHz Bluetooth Estimated 10g SAR (W/kg)	5GHz WLAN 10g SAR (W/kg)			
GSM	GSM850	Front	0.144	0.088	0.042	0.071	<b>0.23</b>	<b>0.19</b>	<b>0.22</b>
		Back	0.284	0.091	0.042	0.095	<b>0.38</b>	<b>0.33</b>	<b>0.38</b>
		Left side	0.190	0.055	0.042	0.063	<b>0.25</b>	<b>0.23</b>	<b>0.25</b>
		Right side	0.072				<b>0.07</b>	<b>0.07</b>	<b>0.07</b>
		Top side		0.043	0.042	0.132	<b>0.04</b>	<b>0.04</b>	<b>0.13</b>
		Bottom side	0.105				<b>0.11</b>	<b>0.11</b>	<b>0.11</b>
	GSM1900	Front	0.137	0.088	0.042	0.071	<b>0.23</b>	<b>0.18</b>	<b>0.21</b>
		Back	0.185	0.091	0.042	0.095	<b>0.28</b>	<b>0.23</b>	<b>0.28</b>
		Left side	0.066	0.055	0.042	0.063	<b>0.12</b>	<b>0.11</b>	<b>0.13</b>
		Right side	0.078				<b>0.08</b>	<b>0.08</b>	<b>0.08</b>
		Top side		0.043	0.042	0.132	<b>0.04</b>	<b>0.04</b>	<b>0.13</b>
		Bottom side	0.183				<b>0.18</b>	<b>0.18</b>	<b>0.18</b>
WCDMA	WCDMA V	Front	0.153	0.088	0.042	0.071	<b>0.24</b>	<b>0.20</b>	<b>0.22</b>
		Back	0.329	0.091	0.042	0.095	<b>0.42</b>	<b>0.37</b>	<b>0.42</b>
		Left side	0.246	0.055	0.042	0.063	<b>0.30</b>	<b>0.29</b>	<b>0.31</b>
		Right side	0.081				<b>0.08</b>	<b>0.08</b>	<b>0.08</b>
		Top side		0.043	0.042	0.132	<b>0.04</b>	<b>0.04</b>	<b>0.13</b>
		Bottom side	0.105				<b>0.11</b>	<b>0.11</b>	<b>0.11</b>
	WCDMA II	Front	0.306	0.088	0.042	0.071	<b>0.39</b>	<b>0.35</b>	<b>0.38</b>
		Back	0.519	0.091	0.042	0.095	<b>0.61</b>	<b>0.56</b>	<b>0.61</b>
		Left side	0.136	0.055	0.042	0.063	<b>0.19</b>	<b>0.18</b>	<b>0.20</b>
		Right side	0.194				<b>0.19</b>	<b>0.19</b>	<b>0.19</b>
		Top side		0.043	0.042	0.132	<b>0.04</b>	<b>0.04</b>	<b>0.13</b>
		Bottom side	0.336				<b>0.34</b>	<b>0.34</b>	<b>0.34</b>
LTE	LTE Band 5	Front	0.151	0.088	0.042	0.071	<b>0.24</b>	<b>0.19</b>	<b>0.22</b>
		Back	0.273	0.091	0.042	0.095	<b>0.36</b>	<b>0.32</b>	<b>0.37</b>
		Left side	0.257	0.055	0.042	0.063	<b>0.31</b>	<b>0.30</b>	<b>0.32</b>
		Right side	0.104				<b>0.10</b>	<b>0.10</b>	<b>0.10</b>
		Top side		0.043	0.042	0.132	<b>0.04</b>	<b>0.04</b>	<b>0.13</b>
		Bottom side	0.100				<b>0.10</b>	<b>0.10</b>	<b>0.10</b>
	LTE Band 7	Front	0.193	0.088	0.042	0.071	<b>0.28</b>	<b>0.24</b>	<b>0.26</b>
		Back	0.205	0.091	0.042	0.095	<b>0.30</b>	<b>0.25</b>	<b>0.30</b>
		Left side	0.038	0.055	0.042	0.063	<b>0.09</b>	<b>0.08</b>	<b>0.10</b>
		Right side	0.078				<b>0.08</b>	<b>0.08</b>	<b>0.08</b>
		Top side		0.043	0.042	0.132	<b>0.04</b>	<b>0.04</b>	<b>0.13</b>
		Bottom side	0.152				<b>0.15</b>	<b>0.15</b>	<b>0.15</b>



**15.3 Body-Worn Accessory Exposure Conditions**

WWAN Band		Exposure Position	1	2	3	4	1+2 Summed 1g SAR (W/kg)	1+3 Summed 1g SAR (W/kg)	1+4 Summed 1g SAR (W/kg)
			WWAN	2.4GHz WLAN	2.4GHz Bluetooth	5GHz WLAN			
			1g SAR (W/kg)	1g SAR (W/kg)	Estimated 1g SAR (W/kg)	1g SAR (W/kg)			
GSM	GSM850	Front	0.193	0.090	0.070	0.128	<b>0.28</b>	<b>0.26</b>	<b>0.32</b>
		Back	0.262	0.091	0.070	0.142	<b>0.35</b>	<b>0.33</b>	<b>0.40</b>
	GSM1900	Front	0.137	0.090	0.070	0.128	<b>0.23</b>	<b>0.21</b>	<b>0.27</b>
		Back	0.168	0.091	0.070	0.142	<b>0.26</b>	<b>0.24</b>	<b>0.31</b>
WCDMA	WCDMA V	Front	0.202	0.090	0.070	0.128	<b>0.29</b>	<b>0.27</b>	<b>0.33</b>
		Back	0.253	0.091	0.070	0.142	<b>0.34</b>	<b>0.32</b>	<b>0.40</b>
	WCDMA II	Front	0.326	0.090	0.070	0.128	<b>0.42</b>	<b>0.40</b>	<b>0.45</b>
		Back	0.373	0.091	0.070	0.142	<b>0.46</b>	<b>0.44</b>	<b>0.52</b>
LTE	LTE Band 5	Front	0.217	0.090	0.070	0.128	<b>0.31</b>	<b>0.29</b>	<b>0.35</b>
		Back	0.281	0.091	0.070	0.142	<b>0.37</b>	<b>0.35</b>	<b>0.42</b>
	LTE Band 7	Front	0.173	0.090	0.070	0.128	<b>0.26</b>	<b>0.24</b>	<b>0.30</b>
		Back	0.219	0.091	0.070	0.142	<b>0.31</b>	<b>0.29</b>	<b>0.36</b>

WWAN Band		Exposure Position	1	2	3	4	1+2 Summed 10g SAR (W/kg)	1+3 Summed 10g SAR (W/kg)	1+4 Summed 10g SAR (W/kg)
			WWAN	2.4GHz WLAN	2.4GHz Bluetooth	5GHz WLAN			
			10g SAR (W/kg)	10g SAR (W/kg)	Estimated 10g SAR (W/kg)	10g SAR (W/kg)			
GSM	GSM850	Front	0.149	0.043	0.028	0.067	<b>0.19</b>	<b>0.18</b>	<b>0.22</b>
		Back	0.196	0.044	0.028	0.077	<b>0.24</b>	<b>0.22</b>	<b>0.27</b>
	GSM1900	Front	0.084	0.043	0.028	0.067	<b>0.13</b>	<b>0.11</b>	<b>0.15</b>
		Back	0.100	0.044	0.028	0.077	<b>0.14</b>	<b>0.13</b>	<b>0.18</b>
WCDMA	WCDMA V	Front	0.125	0.043	0.028	0.067	<b>0.17</b>	<b>0.15</b>	<b>0.19</b>
		Back	0.147	0.044	0.028	0.077	<b>0.19</b>	<b>0.18</b>	<b>0.22</b>
	WCDMA II	Front	0.199	0.043	0.028	0.067	<b>0.24</b>	<b>0.23</b>	<b>0.27</b>
		Back	0.221	0.044	0.028	0.077	<b>0.27</b>	<b>0.25</b>	<b>0.30</b>
LTE	LTE Band 5	Front	0.166	0.043	0.028	0.067	<b>0.21</b>	<b>0.19</b>	<b>0.23</b>
		Back	0.209	0.044	0.028	0.077	<b>0.25</b>	<b>0.24</b>	<b>0.29</b>
	LTE Band 7	Front	0.097	0.043	0.028	0.067	<b>0.14</b>	<b>0.13</b>	<b>0.16</b>
		Back	0.120	0.044	0.028	0.077	<b>0.16</b>	<b>0.15</b>	<b>0.20</b>

**Test Engineer :** Thomas Wang, Steven Chang, Poa Pan, Mickeal Yang, Galen Zhang, Nick Yu,  
Lawrence Chen, Tom Jiang and Jerry Hu

## 16. Uncertainty Assessment

The component of uncertainty may generally be categorized according to the methods used to evaluate them. The evaluation of uncertainty by the statistical analysis of a series of observations is termed a Type A evaluation of uncertainty. The evaluation of uncertainty by means other than the statistical analysis of a series of observation is termed a Type B evaluation of uncertainty. Each component of uncertainty, however evaluated, is represented by an estimated standard deviation, termed standard uncertainty, which is determined by the positive square root of the estimated variance.

A Type A evaluation of standard uncertainty may be based on any valid statistical method for treating data. This includes calculating the standard deviation of the mean of a series of independent observations; using the method of least squares to fit a curve to the data in order to estimate the parameter of the curve and their standard deviations; or carrying out an analysis of variance in order to identify and quantify random effects in certain kinds of measurement.

A type B evaluation of standard uncertainty is typically based on scientific judgment using all of the relevant information available. These may include previous measurement data, experience, and knowledge of the behavior and properties of relevant materials and instruments, manufacture’s specification, data provided in calibration reports and uncertainties assigned to reference data taken from handbooks. Broadly speaking, the uncertainty is either obtained from an outdoor source or obtained from an assumed distribution, such as the normal distribution, rectangular or triangular distributions indicated in table below.

Uncertainty Distributions	Normal	Rectangular	Triangular	U-Shape
Multi-plying Factor <sup>(a)</sup>	1/k <sup>(b)</sup>	1/√3	1/√6	1/√2

(a) standard uncertainty is determined as the product of the multiplying factor and the estimated range of variations in the measured quantity

(b)  $\kappa$  is the coverage factor

**Table 17.1. Standard Uncertainty for Assumed Distribution**

The combined standard uncertainty of the measurement result represents the estimated standard deviation of the result. It is obtained by combining the individual standard uncertainties of both Type A and Type B evaluation using the usual “root-sum-squares” (RSS) methods of combining standard deviations by taking the positive square root of the estimated variances.

Expanded uncertainty is a measure of uncertainty that defines an interval about the measurement result within which the measured value is confidently believed to lie. It is obtained by multiplying the combined standard uncertainty by a coverage factor. Typically, the coverage factor ranges from 2 to 3. Using a coverage factor allows the true value of a measured quantity to be specified with a defined probability within the specified uncertainty range. For purpose of this document, a coverage factor two is used, which corresponds to confidence interval of about 95 %. The DASY uncertainty Budget is shown in the following tables.



Error Description	Uncertainty Value (±%)	Probability Distribution	Divisor	Ci (1g)	Ci (10g)	Standard Uncertainty (1g)	Standard Uncertainty (10g)
<b>Measurement System</b>							
Probe Calibration	6.0	Normal	1	1	1	± 6.0 %	± 6.0 %
Axial Isotropy	4.7	Rectangular	√3	0.7	0.7	± 1.9 %	± 1.9 %
Hemispherical Isotropy	9.6	Rectangular	√3	0.7	0.7	± 3.9 %	± 3.9 %
Boundary Effects	1.0	Rectangular	√3	1	1	± 0.6 %	± 0.6 %
Linearity	4.7	Rectangular	√3	1	1	± 2.7 %	± 2.7 %
System Detection Limits	1.0	Rectangular	√3	1	1	± 0.6 %	± 0.6 %
Readout Electronics	0.3	Normal	1	1	1	± 0.3 %	± 0.3 %
Response Time	0.8	Rectangular	√3	1	1	± 0.5 %	± 0.5 %
Integration Time	2.6	Rectangular	√3	1	1	± 1.5 %	± 1.5 %
RF Ambient Noise	3.0	Rectangular	√3	1	1	± 1.7 %	± 1.7 %
RF Ambient Reflections	3.0	Rectangular	√3	1	1	± 1.7 %	± 1.7 %
Probe Positioner	0.4	Rectangular	√3	1	1	± 0.2 %	± 0.2 %
Probe Positioning	2.9	Rectangular	√3	1	1	± 1.7 %	± 1.7 %
Max. SAR Eval.	1.0	Rectangular	√3	1	1	± 0.6 %	± 0.6 %
<b>Test Sample Related</b>							
Device Positioning	2.9	Normal	1	1	1	± 2.9 %	± 2.9 %
Device Holder	3.6	Normal	1	1	1	± 3.6 %	± 3.6 %
Power Drift	5.0	Rectangular	√3	1	1	± 2.9 %	± 2.9 %
<b>Phantom and Setup</b>							
Phantom Uncertainty	4.0	Rectangular	√3	1	1	± 2.3 %	± 2.3 %
Liquid Conductivity (Target)	5.0	Rectangular	√3	0.64	0.43	± 1.8 %	± 1.2 %
Liquid Conductivity (Meas.)	2.5	Normal	1	0.64	0.43	± 1.6 %	± 1.1 %
Liquid Permittivity (Target)	5.0	Rectangular	√3	0.6	0.49	± 1.7 %	± 1.4 %
Liquid Permittivity (Meas.)	2.5	Normal	1	0.6	0.49	± 1.5 %	± 1.2 %
<b>Combined Standard Uncertainty</b>						± 11.0 %	± 10.8 %
<b>Coverage Factor for 95 %</b>						K=2	
<b>Expanded Uncertainty</b>						± 22.0 %	± 21.5 %

Table 17.2. Uncertainty Budget for frequency range 300 MHz to 3 GHz



Error Description	Uncertainty Value (±%)	Probability Distribution	Divisor	Ci (1g)	Ci (10g)	Standard Uncertainty (1g)	Standard Uncertainty (10g)
<b>Measurement System</b>							
Probe Calibration	6.55	Normal	1	1	1	± 6.55 %	± 6.55 %
Axial Isotropy	4.7	Rectangular	√3	0.7	0.7	± 1.9 %	± 1.9 %
Hemispherical Isotropy	9.6	Rectangular	√3	0.7	0.7	± 3.9 %	± 3.9 %
Boundary Effects	2.0	Rectangular	√3	1	1	± 1.2 %	± 1.2 %
Linearity	4.7	Rectangular	√3	1	1	± 2.7 %	± 2.7 %
System Detection Limits	1.0	Rectangular	√3	1	1	± 0.6 %	± 0.6 %
Readout Electronics	0.3	Normal	1	1	1	± 0.3 %	± 0.3 %
Response Time	0.8	Rectangular	√3	1	1	± 0.5 %	± 0.5 %
Integration Time	2.6	Rectangular	√3	1	1	± 1.5 %	± 1.5 %
RF Ambient Noise	3.0	Rectangular	√3	1	1	± 1.7 %	± 1.7 %
RF Ambient Reflections	3.0	Rectangular	√3	1	1	± 1.7 %	± 1.7 %
Probe Positioner	0.8	Rectangular	√3	1	1	± 0.5 %	± 0.5 %
Probe Positioning	9.9	Rectangular	√3	1	1	± 5.7 %	± 5.7 %
Max. SAR Eval.	4.0	Rectangular	√3	1	1	± 2.3 %	± 2.3 %
<b>Test Sample Related</b>							
Device Positioning	2.9	Normal	1	1	1	± 2.9 %	± 2.9 %
Device Holder	3.6	Normal	1	1	1	± 3.6 %	± 3.6 %
Power Drift	5.0	Rectangular	√3	1	1	± 2.9 %	± 2.9 %
<b>Phantom and Setup</b>							
Phantom Uncertainty	4.0	Rectangular	√3	1	1	± 2.3 %	± 2.3 %
Liquid Conductivity (Target)	5.0	Rectangular	√3	0.64	0.43	± 1.8 %	± 1.2 %
Liquid Conductivity (Meas.)	2.5	Normal	1	0.64	0.43	± 1.6 %	± 1.1 %
Liquid Permittivity (Target)	5.0	Rectangular	√3	0.6	0.49	± 1.7 %	± 1.4 %
Liquid Permittivity (Meas.)	2.5	Normal	1	0.6	0.49	± 1.5 %	± 1.2 %
<b>Combined Standard Uncertainty</b>						± 12.8 %	± 12.6 %
<b>Coverage Factor for 95 %</b>						K=2	
<b>Expanded Uncertainty</b>						± 25.6 %	± 25.2 %

**Table 17.3. Uncertainty Budget for frequency range 3 GHz to 6 GHz**



## **17. References**

- [1] FCC 47 CFR Part 2 "Frequency Allocations and Radio Treaty Matters; General Rules and Regulations"
- [2] ANSI/IEEE Std. C95.1-1992, "IEEE Standard for Safety Levels with Respect to Human Exposure to Radio Frequency Electromagnetic Fields, 3 kHz to 300 GHz", September 1992
- [3] IEEE Std. 1528-2003, "Recommended Practice for Determining the Peak Spatial-Average Specific Absorption Rate (SAR) in the Human Head from Wireless Communications Devices: Measurement Techniques", December 2003
- [4] SPEAG DASY System Handbook
- [5] FCC KDB 248227 D01 v02r01, "SAR Guidance for IEEE 802.11 (WiFi) Transmitters", Jun 2015.
- [6] FCC KDB 447498 D01 v05r02, "Mobile and Portable Device RF Exposure Procedures and Equipment Authorization Policies", Feb 2014
- [7] FCC KDB 648474 D04 v01r02, "SAR Evaluation Considerations for Wireless Handsets", Dec 2013.
- [8] FCC KDB 941225 D01 v03, "3G SAR MEAUREMENT PROCEDURES", Oct 2014
- [9] FCC KDB 941225 D05 v02r03, "SAR Evaluation Considerations for LTE Devices", Dec 2013
- [10] FCC KDB 941225 D06 v02, "SAR Evaluation Procedures for Portable Devices with Wireless Router Capabilities", Oct 2014.
- [11] FCC KDB 865664 D01 v01r03, "SAR Measurement Requirements for 100 MHz to 6 GHz", Feb 2014.
- [12] FCC KDB 865664 D02 v01r01, "RF Exposure Compliance Reporting and Documentation Considerations" May 2013.