



# FCC RF Test Report

**APPLICANT** : Sony Mobile Communications Inc.  
**EQUIPMENT** : Smart phone  
**BRAND NAME** : SONY  
**TYPE NAME** : PM-0891-BV  
**FCC ID** : PY7-PM0891  
**STANDARD** : FCC Part 15 Subpart E §15.407  
**CLASSIFICATION** : (NII) Unlicensed National Information Infrastructure

The product was received on Apr. 29, 2015 and testing was completed on May 12, 2015. We, SPORTON INTERNATIONAL INC., would like to declare that the tested sample has been evaluated in accordance with the test procedures and has been in compliance with the applicable technical standards.

The test results in this report apply exclusively to the tested model / sample. Without written approval of SPORTON INTERNATIONAL INC., the test report shall not be reproduced except in full.

Reviewed by: Joseph Lin / Supervisor

Approved by: Jones Tsai / Manager



## **SPORTON INTERNATIONAL INC.**

**No. 52, Hwa Ya 1<sup>st</sup> Rd., Hwa Ya Technology Park, Kwei-Shan District, Tao Yuan City, Taiwan, R.O.C.**

SPORTON INTERNATIONAL INC.

TEL : 886-3-327-3456

FAX : 886-3-328-4978

FCC ID : PY7-PM0891

Page Number : 1 of 35

Report Issued Date : Jul. 03, 2015

Report Version : Rev. 01

Report Template No.: BU5-FR15EWLB4 Version 1.0



# TABLE OF CONTENTS

**REVISION HISTORY.....3**

**SUMMARY OF TEST RESULT .....4**

**1 GENERAL DESCRIPTION.....5**

    1.1 Applicant.....5

    1.2 Manufacturer.....5

    1.3 Feature of Equipment Under Test.....5

    1.4 Product Specification of Equipment Under Test.....6

    1.5 Modification of EUT.....7

    1.6 Testing Location.....7

    1.7 Applicable Standards.....8

**2 TEST CONFIGURATION OF EQUIPMENT UNDER TEST.....9**

    2.1 Carrier Frequency and Channel.....9

    2.2 Pre-Scanned RF Power.....10

    2.3 Test Mode.....10

    2.4 Connection Diagram of Test System.....11

    2.5 Support Unit used in test configuration and system.....12

    2.6 EUT Operation Test Setup.....12

    2.7 Measurement Results Explanation Example.....12

**3 TEST RESULT.....13**

    3.1 6dB Bandwidth Measurement.....13

    3.2 Maximum Conducted Output Power Measurement.....15

    3.3 Power Spectral Density Measurement.....16

    3.4 Unwanted Emissions Measurement.....19

    3.5 AC Conducted Emission Measurement.....23

    3.6 Frequency Stability Measurement.....29

    3.7 Automatically Discontinue Transmission.....30

    3.8 Antenna Requirements.....31

**4 LIST OF MEASURING EQUIPMENT.....32**

**5 UNCERTAINTY OF EVALUATION.....34**

**APPENDIX A. CONDUCTED TEST RESULTS**

**APPENDIX B. RADIATED TEST RESULTS**



REVISION HISTORY

REPORT NO.	VERSION	DESCRIPTION	ISSUED DATE
FR542942F	Rev. 01	Initial issue of report	Jul. 03, 2015



### SUMMARY OF TEST RESULT

Report Section	FCC Rule	Description	Limit	Result	Remark
3.1	15.403(i)	6dB Bandwidth	> 500kHz	Pass	-
3.2	15.407(a)	Maximum Conducted Output Power	≤ 30 dBm	Pass	-
3.3	15.407(a)	Power Spectral Density	≤ 30 dBm/500kHz	Pass	-
3.4	15.407(b)	Unwanted Emissions	≤ -17, -27 dBm/MHz & 15.209(a)	Pass	Under limit 3.35 dB at 5710.360 MHz
3.5	15.207	AC Conducted Emission	15.207(a)	Pass	Under limit 10.90 dB at 2.878 MHz
3.6	15.407(g)	Frequency Stability	Within Operation Band	Pass	-
3.7	15.407(c)	Automatically Discontinue Transmission	Discontinue Transmission	Pass	-
3.8	15.203 & 15.407(a)	Antenna Requirement	N/A	Pass	-



# 1 General Description

## 1.1 Applicant

**Sony Mobile Communications Inc.**  
Nya Vattentorget, 22188 Lund, Sweden

## 1.2 Manufacturer

**Arima Communications Corp.**  
6F, No. 866, Jhongjheng Rd., Jhonghe Dist., New Taipei City 23586, Taiwan

## 1.3 Feature of Equipment Under Test

The Equipment Under Test (hereafter called: EUT) is Smart phone supporting, GSM/WCDMA/LTE, Wi-Fi 2.4GHz 802.11b/g/n, Wi-Fi 5GHz 802.11a/n, Bluetooth with FM Receiver, GPS, and NFC features, and below is details of information.

Product Feature	
Equipment	Smart phone
Brand Name	SONY
Type Name	PM-0891-BV
FCC ID	PY7-PM0891
GSM Operating Band(s)	GSM 850/900/1800/1900MHz
GPRS / EGPRS Multi Slot Class	GPRS Class 12, EGPRS Class 12
WCDMA Operating Band(s)	FDD Band I / II / V / VIII
WCDMA Rel. Version	Rel. 8
LTE Operating Band(s)	FDD Band I / III / V / VII / VIII / XXVIII TDD Band XL
LTE Rel. Version	Rel. 8
Wi-Fi Specification	802.11a/b/g/n (HT20/HT40)
Bluetooth Version	v3.0+EDR / v4.0-LE
NFC Specification	ISO14443A / ISO14443B / Felica
Power Supply	Battery / AC Adapter / Car Charger

**Remark:** The above EUT's information was declared by manufacturer. Please refer to the specifications or user's manual for more detailed description.



### 1.4 Product Specification of Equipment Under Test

Product Specification subjective to this standard	
<b>Tx/Rx Channel Frequency Range</b>	5725 MHz ~ 5850 MHz
<b>Maximum Output Power</b>	802.11a : 11.20 dBm / 0.0132 W 802.11n HT20 : 11.26 dBm / 0.0134 W 802.11n HT40 : 11.49 dBm / 0.0141 W
<b>Type of Modulation</b>	OFDM (BPSK / QPSK / 16QAM / 64QAM)
<b>Antenna Type &amp; Gain</b>	PIFA Antenna with gain -0.30 dBi

EUT Information List				
IMEI	HW Version	SW Version	S/N	Performed Test Item
IMEI 1: 004402454617220 IMEI 2: 004402454617238	A	29.0.B.0.76	WUJ01HWJMD	RF conducted measurement
IMEI 1: 004402454617303 IMEI 2: 004402454617311			WUJ01HWJRA	Radiated Spurious Emission
IMEI 1: 004402454617709 IMEI 2: 004402454617717			WUJ01HWK59	Conducted Emission

Accessory List	
<b>AC Adapter</b>	Model No. : EP800
	Type No. : CAA-0002016-US B
	S/N : 3113W 45 108545 (for Radiation Spurious Emission) 3113W 38 210631 (for Conducted Emission)
<b>Battery</b>	Model No. : LIS1579ERPC
<b>Earphone 1</b>	Model No. : MH410c
	Type No. : AG-1100
	S/N : 13511E63001BFF6 (for Radiation Spurious Emission)
<b>Earphone 2</b>	Model No. : MH410c
	Type No. : AG-1103
	S/N : 1428204D011619A (for Radiation Spurious Emission) 14292040011682C (for Conducted Emission)
<b>USB Cable</b>	Model No. : EC450
	Type No. : AI-0700
	S/N : 143412DE1065866 (for Radiation Spurious Emission) 134912D1000585A (for Conducted Emission)

**Note:**

1. Above EUT list and accessory list used are electrically identical per declared by manufacturer.
2. Above the accessories list are used to exercise the EUT during test.
3. For other wireless features of this EUT, test report will be issued separately.



### 1.5 Modification of EUT

No modifications are made to the EUT during all test items.

### 1.6 Testing Location

Sporton Lab is accredited to ISO 17025 by Taiwan Accreditation Foundation (TAF code : 1190) and the FCC designation No. TW1022 under the FCC 2.948(e) by Mutual Recognition Agreement (MRA) in FCC Test.

<b>Test Site</b>	SPORTON INTERNATIONAL INC.	
<b>Test Site Location</b>	No. 52, Hwa Ya 1 <sup>st</sup> Rd., Hwa Ya Technology Park, Kwei-Shan District, Tao Yuan City, Taiwan, R.O.C. TEL: +886-3-327-3456 FAX: +886-3-328-4978	
<b>Test Site No.</b>	<b>Sporton Site No.</b>	
	TH02-HY	CO05-HY

<b>Test Site</b>	SPORTON INTERNATIONAL INC.	
<b>Test Site Location</b>	No.58, Aly. 75, Ln. 564, Wenhua 3rd Rd. Guishan District, Taoyuan City, Taiwan (R.O.C.) TEL: +886-3-327-0855	
<b>Test Site No.</b>	<b>Sporton Site No.</b>	
	03CH11-HY	

**Note:** The test site complies with ANSI C63.4 2009 requirement.



## 1.7 Applicable Standards

According to the specifications of the manufacturer, the EUT must comply with the requirements of the following standards:

- ♦ FCC Part 15 Subpart E
- ♦ FCC KDB 789033 D02 General UNII Test Procedures New Rules v01
- ♦ ANSI C63.10-2009

### **Remark:**

1. All test items were verified and recorded according to the standards and without any deviation during the test.
2. FCC permits the use of the 1.5 meter table as an alternative in C63.10-2013 through inquiry tracking number 961829.
3. This EUT has also been tested and complied with the requirements of FCC Part 15, Subpart B, recorded in a separate test report.





## 2 Test Configuration of Equipment Under Test

The EUT has been associated with peripherals and configuration operated in a manner tended to maximize its emission characteristics in a typical application. Frequency range investigated: conducted emission (150 kHz to 30 MHz) and radiated emission (9 kHz to the 10th harmonic of the highest fundamental frequency or to 40 GHz, whichever is lower). For radiated measurement, pre-scanned in three orthogonal panels, X, Y, Z. The worst cases (X plane) were recorded in this report.

The final configuration from all the combinations and the worst-case data rates were investigated by measuring the maximum power across all the data rates and modulation modes under section 2.2.

Based on the worst configuration found above, the RF power setting is set individually to meet FCC compliance limit for the final conducted and radiated tests shown in section 2.3.

### 2.1 Carrier Frequency and Channel

Frequency Band	Channel	Freq. (MHz)	Channel	Freq. (MHz)
5725-5850 MHz Band 4 (U-NII-3)	149	5745	157	5785
	<b>151</b>	<b>5755</b>	<b>159</b>	<b>5795</b>
	153	5765	161	5805
	155	5775	165	5825

**Note:** The above Frequency and Channel in boldface were 802.11n HT40.



## 2.2 Pre-Scanned RF Power

Preliminary tests were performed in different data rate and data rate associated with the highest power were chosen for full test in the following tables.

5GHz 802.11a mode								
Data Rate (MHz)	6M bps	9M bps	12M bps	18M bps	24M bps	36M bps	48M bps	54M bps
Average Power (dBm)	11.20	11.10	11.06	11.18	10.88	11.18	11.17	11.07

5GHz 802.11n HT20 mode								
Data Rate (MHz)	MCS0	MCS1	MCS2	MCS3	MCS4	MCS5	MCS6	MCS7
Average Power (dBm)	11.26	11.22	11.25	11.08	11.24	11.24	11.22	11.22

5GHz 802.11n HT40 mode								
Data Rate (MHz)	MCS0	MCS1	MCS2	MCS3	MCS4	MCS5	MCS6	MCS7
Average Power (dBm)	11.49	11.47	11.39	11.40	11.37	11.45	11.44	11.43

## 2.3 Test Mode

Final test mode of conducted test items and radiated spurious emissions are considering the modulation and worse data rates from the power table described in section 2.2.

Modulation	Data Rate
802.11a	6 Mbps
802.11n HT20	MCS0
802.11n HT40	MCS0

<b>AC Conducted Emission</b>	Mode 1 : GSM1900 Idle + Bluetooth Link + WLAN (5GHz) Link + Earphone 2 + Battery + MP3 + USB Cable (Charging from Adapter) + SIM2
<b>Remark:</b> For Radiated TCs, the tests were performed with SIM 1.	

Ch. #		Band IV : 5725-5850 MHz		
		802.11a	802.11n HT20	802.11n HT40
L	Low	149	149	151
M	Middle	157	157	-
H	High	165	165	159

## 2.4 Connection Diagram of Test System

### <WLAN Tx Mode>

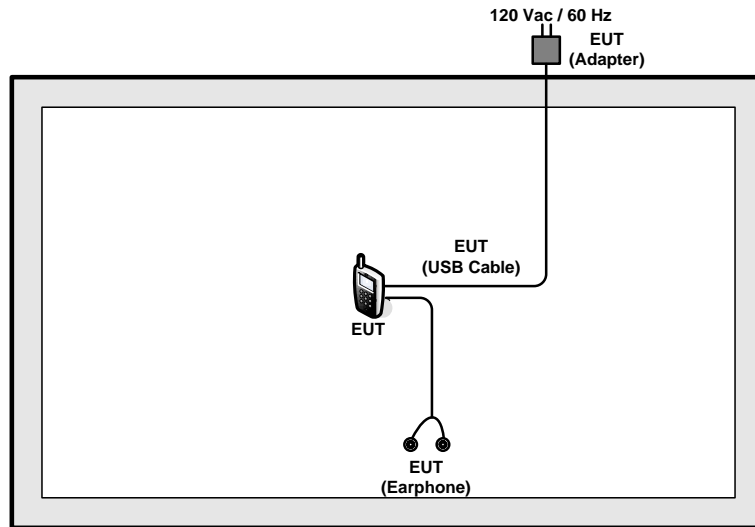

### <AC Conducted Emission Mode>

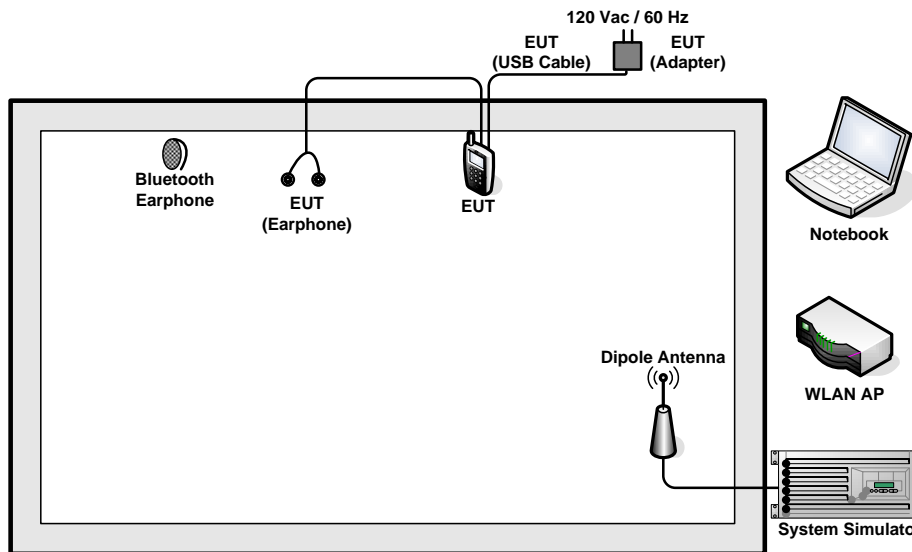



### 2.5 Support Unit used in test configuration and system

Item	Equipment	Trade Name	Model Name	FCC ID	Data Cable	Power Cord
1.	System Simulator	Anritsu	MT8820C	N/A	N/A	Unshielded, 1.8 m
2.	Notebook	DELL	Latitude E6320	FCC DoC/ Contains FCC ID: QDS-BRCM1054	N/A	AC I/P: Unshielded, 1.2 m DC O/P: Shielded, 1.8 m
3.	WLAN AP	D-Link	DIR-865L	KA2IR865LA1	N/A	Unshielded, 1.8 m
4.	Bluetooth Earphone	Sony	SBH20	PY7-RD0010	Unshielded, 0.75m	N/A
5.	SD Card	SanDisk	MicroSD HC	FCC DoC	N/A	N/A

### 2.6 EUT Operation Test Setup

For WLAN function, programmed RF utility, EUT provide functions like channel selection and power level for continuous transmitting and receiving signals.

### 2.7 Measurement Results Explanation Example

For all conducted test items:

The offset level is set in the spectrum analyzer to compensate the RF cable loss and attenuator factor between EUT conducted output port and spectrum analyzer. With the offset compensation, the spectrum analyzer reading level is exactly the EUT RF output level.

Example :

The spectrum analyzer offset is derived from RF cable loss and attenuator factor.

*Offset = RF cable loss + attenuator factor.*

Following shows an offset computation example with cable loss 4.2 dB and 10dB attenuator.

$$\begin{aligned}
 \text{Offset(dB)} &= \text{RF cable loss(dB)} + \text{attenuator factor(dB)}. \\
 &= 4.2 + 10 = 14.2 \text{ (dB)}
 \end{aligned}$$

### 3 Test Result

#### 3.1 6dB Bandwidth Measurement

##### 3.1.1 Description of 6dB Bandwidth

The minimum 6 dB bandwidth shall be at least 500 kHz.

##### 3.1.2 Measuring Instruments

The measuring equipment is listed in the section 4 of this test report.

##### 3.1.3 Test Procedures

1. The testing follows FCC KDB 789033 D02 General UNII Test Procedures New Rules v01.  
Section C) Emission bandwidth for the band 5.725-5.85GHz
2. Set RBW = 100kHz.
3. Set the VBW  $\geq 3 \times$  RBW.
4. Detector = Peak.
5. Trace mode = max hold
6. Measure the maximum width of the emission that is 6 dB down from the peak of the emission.
7. Measure and record the results in the test report.

##### 3.1.4 Test Setup





### 3.1.5 Test Result of 6dB Bandwidth

Please refer to Appendix A.

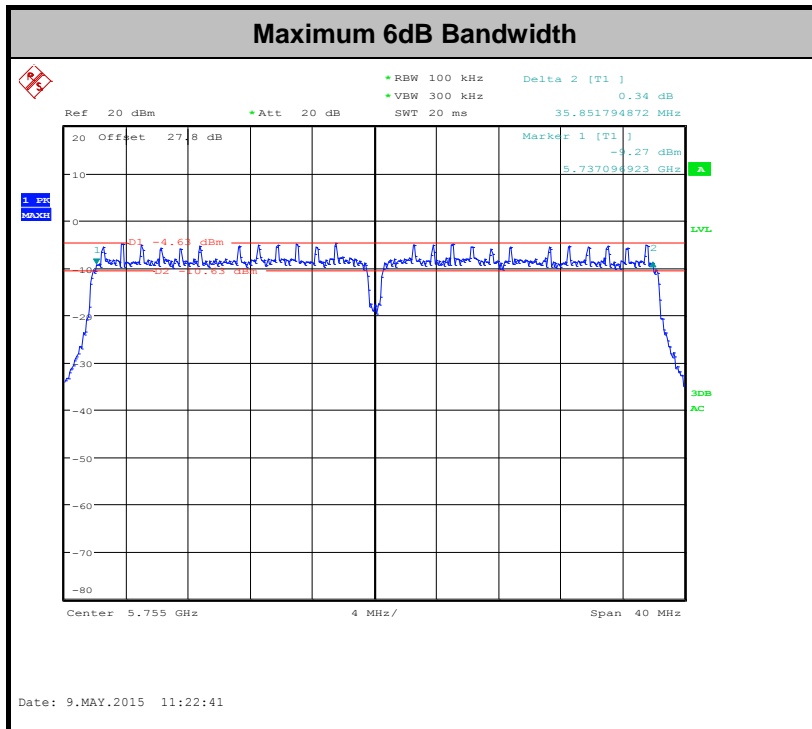

## 3.2 Maximum Conducted Output Power Measurement

### 3.2.1 Limit of Maximum Conducted Output Power

For the band 5.725–5.85 GHz, the maximum conducted output power over the frequency band of operation shall not exceed 1 W.

If transmitting antennas of directional gain greater than 6 dBi are used, the peak output power shall be reduced by the amount in dB that the directional gain of the antenna exceeds 6 dBi.

### 3.2.2 Measuring Instruments

The measuring equipment is listed in the section 4 of this test report.

### 3.2.3 Test Procedures

The testing follows Method PM of FCC KDB 789033 D02 General UNII Test Procedures New Rules v01.

Method PM (Measurement using an RF average power meter):

1. Measurement is performed using a wideband RF power meter.
2. The EUT is configured to transmit continuously with a consistent duty cycle at its maximum power control level.
3. Measure the average power of the transmitter, and the average power is corrected with duty factor,  $10 \log(1/x)$ , where  $x$  is the duty cycle.

### 3.2.4 Test Setup

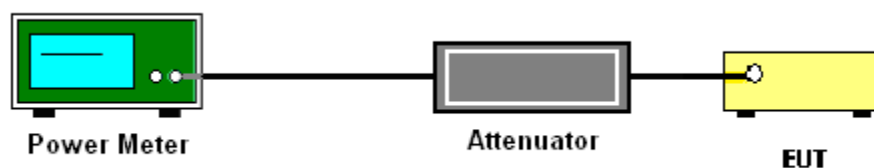

### 3.2.5 Test Result of Maximum Conducted Output Power

Please refer to Appendix A.



### 3.3 Power Spectral Density Measurement

#### 3.3.1 Limit of Power Spectral Density

For the band 5.725–5.85 GHz, the maximum power spectral density shall not exceed 30 dBm in any 500-kHz band.

If transmitting antennas of directional gain greater than 6 dBi are used, the peak output power shall be reduced by the amount in dB that the directional gain of the antenna exceeds 6 dBi.

#### 3.3.2 Measuring Instruments

The measuring equipment is listed in the section 4 of this test report.

#### 3.3.3 Test Procedures

The testing follows FCC KDB 789033 D02 General UNII Test Procedures New Rules v01. Section F) Maximum power spectral density.

##### # Method SA-2 #

(trace averaging across on and off times of the EUT transmissions, followed by duty cycle correction).

1. The testing follows Method SA-2 of FCC KDB 789033 D01 General UNII Test Procedures v01r03.
  - Measure the duty cycle.
  - Set span to encompass the entire emission bandwidth (EBW) of the signal.
  - Set RBW = 300 kHz.
  - Set VBW  $\geq$  1 MHz.
  - Number of points in sweep  $\geq$  2 Span / RBW.
  - Sweep time = auto.
  - Detector = RMS
  - Trace average at least 100 traces in power averaging mode.
  - Add  $10 \log(500\text{kHz}/\text{RBW})$  to the test result.
  - Add  $10 \log(1/x)$ , where x is the duty cycle, to the measured power in order to compute the average power during the actual transmission times. For example, add  $10 \log(1/0.25) = 6$  dB if the duty cycle is 25 percent.



2. The RF output of EUT was connected to the spectrum analyzer by a low loss cable.
3. Each plot has already offset with cable loss, and attenuator loss. Measure the PPSD and record it.

### 3.3.4 Test Setup

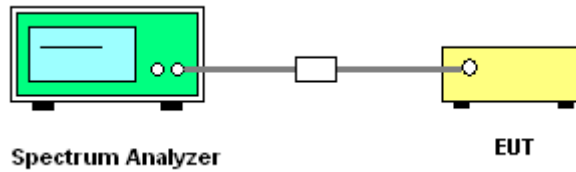



### 3.3.5 Test Result of Power Spectral Density

Please refer to Appendix A.

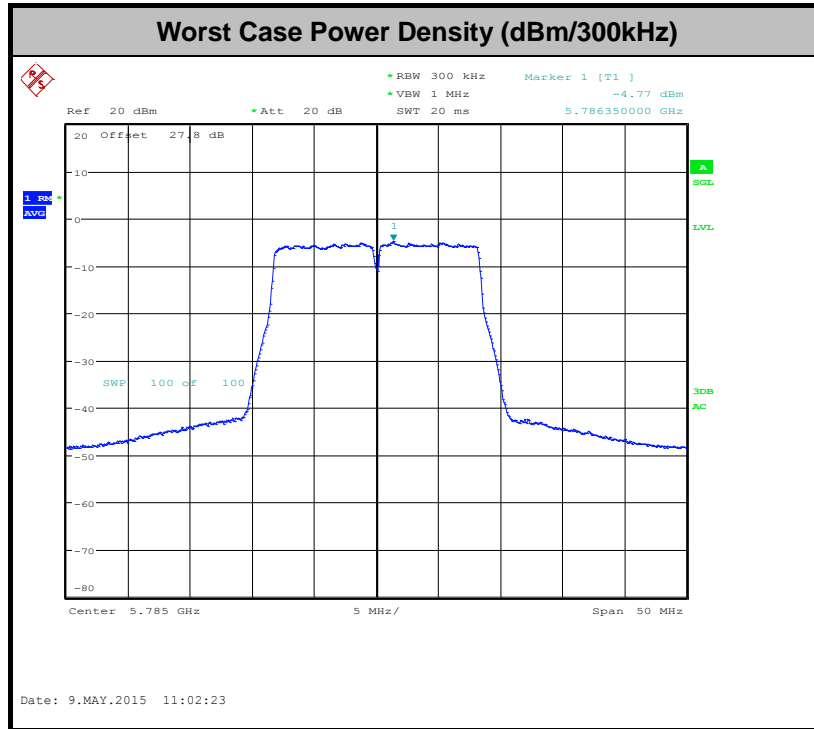

**Note:** Average Power Density (dB) = Measured value+ Duty Factor



### 3.4 Unwanted Emissions Measurement

This section as specified in FCC Part 15.407(b) is to measure unwanted emissions through radiated measurement for band edge spurious emissions and out of band emissions measurement. The unwanted emissions shall comply with 15.407(b)(1) to (6), and restricted bands per FCC Part15.205.

#### 3.4.1 Limit of Unwanted Emissions

- (1) For transmitters operating in the 5725-5850 MHz band: all emissions within the frequency range from the band edge to 10 MHz above or below the band edge shall not exceed an EIRP of -17 dBm/MHz (78.3dBµV/m); for frequencies 10 MHz or greater above or below the band edge, emissions shall not exceed an EIRP of -27 dBm/MHz (68.3dBµV/m).
- (2) Unwanted spurious emissions fallen in restricted bands per FCC Part15.205 shall comply with the general field strength limits set forth in § 15.209 as below table,

Frequency (MHz)	Field Strength (microvolts/meter)	Measurement Distance (meters)
0.009 – 0.490	2400/F(kHz)	300
0.490 – 1.705	24000/F(kHz)	30
1.705 – 30.0	30	30
30 – 88	100	3
88 – 216	150	3
216 - 960	200	3
Above 960	500	3

**Note:** The following formula is used to convert the EIRP to field strength.

$$E = \frac{1000000\sqrt{30P}}{3} \mu\text{V/m, where P is the eirp (Watts)}$$

EIRP (dBm)	Field Strength at 3m (dBµV/m)
-17	78.3
- 27	68.3

- (3) KDB789033 v01r03 H)2)c)(i) As specified in 15.407(b), emissions above 1000 MHz that are outside of the restricted bands are subject to a peak emission limit of -27 dBm/MHz (or -17 dBm/MHz as specified in 15.407(b)(4)). However, an out-of-band emission that complies with both the average and peak limits of 15.209 is not required to satisfy the -27 dBm/MHz or -17 dBm/MHz peak emission limit.



### 3.4.2 Measuring Instruments

The measuring equipment is listed in the section 4 of this test report.

### 3.4.3 Test Procedures

- The testing follows FCC KDB 789033 D02 General UNII Test Procedures New Rules v01. Section G) Unwanted emissions measurement.

(1) Procedure for Unwanted Emissions Measurements Below 1000MHz

- RBW = 120 kHz
- VBW = 300 kHz
- Detector = Peak
- Trace mode = max hold

(2) Procedure for Peak Unwanted Emissions Measurements Above 1000 MHz

- RBW = 1 MHz
- VBW ≥ 3 MHz
- Detector = Peak
- Sweep time = auto
- Trace mode = max hold

(3) Procedures for Average Unwanted Emissions Measurements Above 1000MHz

- RBW = 1 MHz
- VBW = 10 Hz, when duty cycle is no less than 98 percent.
- $VBW \geq 1/T$ , when duty cycle is less than 98 percent where T is the minimum transmission duration over which the transmitter is on and is transmitting at its maximum power control level for the tested mode of operation.

Band	Duty Cycle(%)	T(μs)	1/T(kHz)	VBW Setting
802.11a	88.54	1390.00	0.72	1kHz
802.11n HT20	88.51	1310.00	0.76	1kHz
802.11n HT40	79.56	654.00	1.53	2kHz

- The EUT was placed on a turntable with 0.8 meter for frequency below 1GHz and 1.5 meter for frequency above 1GHz respectively above ground.
- The EUT was set 3 meters from the interference receiving antenna which was mounted on the top of a variable height antenna tower.
- The antenna is a broadband antenna and its height is adjusted between one meter and four meters above ground to find the maximum value of the field strength for both horizontal polarization and vertical polarization of the antenna.

5. For each suspected emission, the EUT was arranged to its worst case and then adjust the antenna tower (from 1 m to 4 m) and turntable (from 0 degree to 360 degrees) to find the maximum reading.
6. For testing below 1GHz, if the emission level of the EUT in peak mode was 3 dB lower than the limit specified, then peak values of EUT will be reported, otherwise, the emissions will be repeated one by one using the CISPR quasi-peak method and reported.
7. For testing above 1GHz, the emission level of the EUT in peak mode was 20dB lower than average limit (that means the emission level in average mode also complies with the limit in average mode), then peak values of EUT will be reported, otherwise, the emissions will be measured in average mode again and reported.

### 3.4.4 Test Setup

For radiated emissions below 30MHz

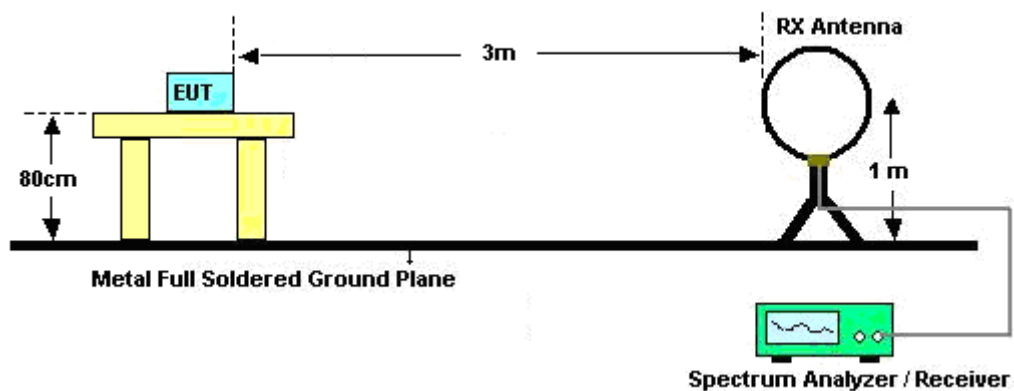

For radiated emissions from 30MHz to 1GHz

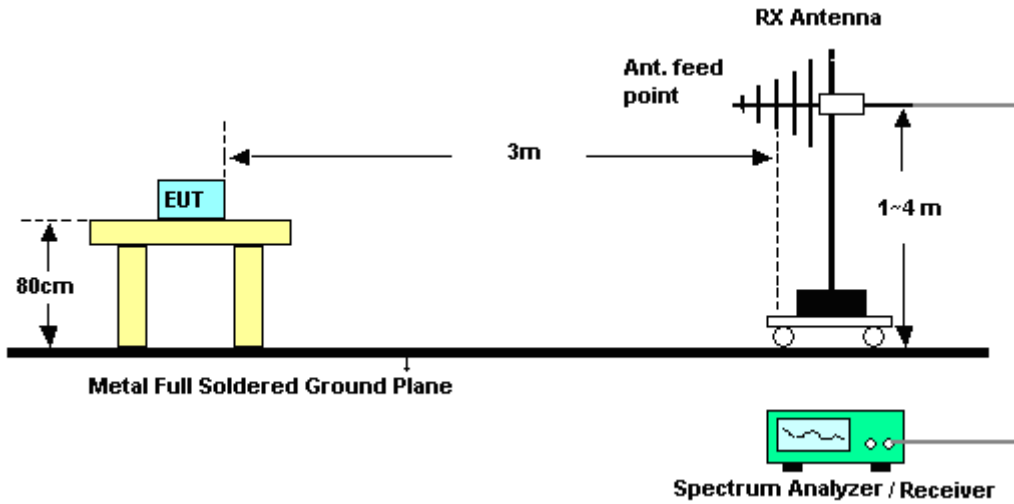

For radiated emissions above 1GHz

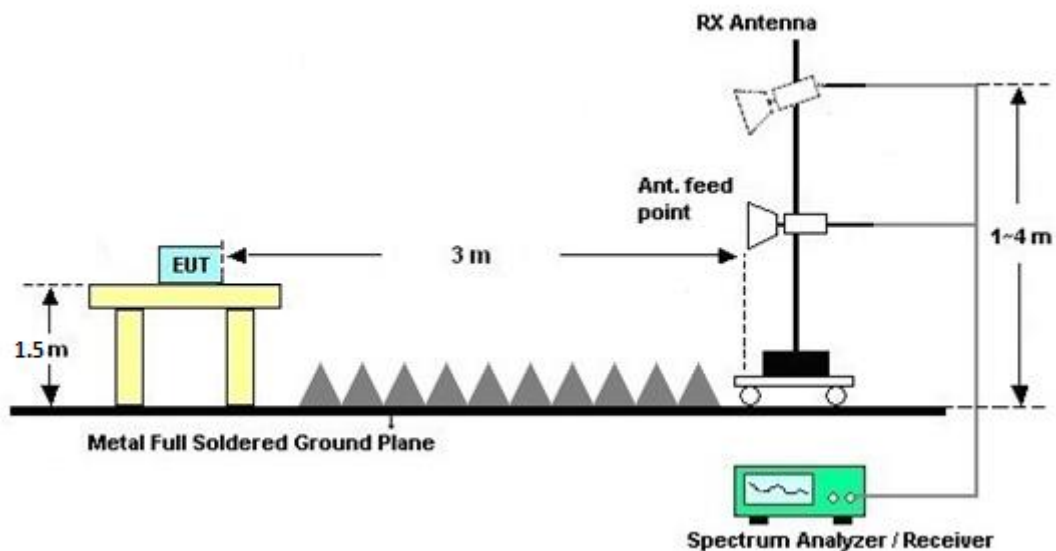

### 3.4.5 Test Results of Radiated Emissions (9 kHz ~ 30 MHz)

The low frequency, which started from 9 kHz to 30MHz, was pre-scanned and the result which was 20dB lower than the limit line per 15.31(o) was not reported.

### 3.4.6 Test Result of Radiated Band Edges

Please refer to Appendix A.

### 3.4.7 Test Result of Unwanted Radiated Emission (30MHz ~ 10th Harmonic)

Please refer to Appendix A.



### 3.5 AC Conducted Emission Measurement

#### 3.5.1 Limit of AC Conducted Emission

For equipment that is designed to be connected to the public utility (AC) power line, the radio frequency voltage that is conducted back onto the AC power line on any frequency or frequencies within the band 150 kHz to 30 MHz shall not exceed the limits in the following table.

Frequency of emission (MHz)	Conducted limit (dB $\mu$ V)	
	Quasi-peak	Average
0.15-0.5	66 to 56*	56 to 46*
0.5-5	56	46
5-30	60	50

\*Decreases with the logarithm of the frequency.

#### 3.5.2 Measuring Instruments

The measuring equipment is listed in the section 4 of this test report.

#### 3.5.3 Test Procedures

1. The EUT was placed 0.4 meter from the conducting wall of the shielding room was kept at least 80 centimeters from any other grounded conducting surface.
2. Connect EUT to the power mains through a line impedance stabilization network (LISN).
3. All the support units are connecting to the other LISN.
4. The LISN provides 50 ohm coupling impedance for the measuring instrument.
5. The FCC states that a 50 ohm, 50 microhenry LISN should be used.
6. Both sides of AC line were checked for maximum conducted interference.
7. The frequency range from 150 kHz to 30 MHz was searched.
8. Set the test-receiver system to Peak Detect Function and specified bandwidth with Maximum Hold Mode.

### 3.5.4 Test Setup

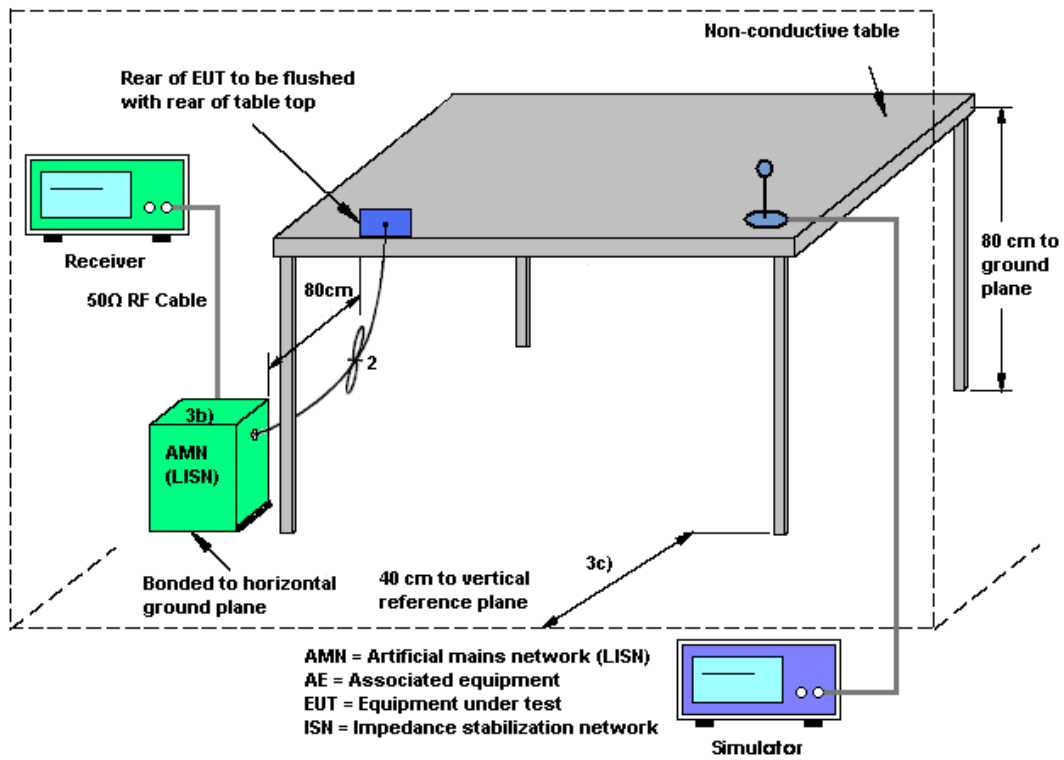



### 3.5.5 Test Result of AC Conducted Emission

Test Mode :	Mode 1	Temperature :	24~25°C
Test Engineer :	Kai-Chun Chu	Relative Humidity :	53~54%
Test Voltage :	120Vac / 60Hz	Phase :	Line
Function Type :	GSM1900 Idle + Bluetooth Link + WLAN (5GHz) Link + Earphone 2 + Battery + MP3 + USB Cable (Charging from Adapter) + SIM2		

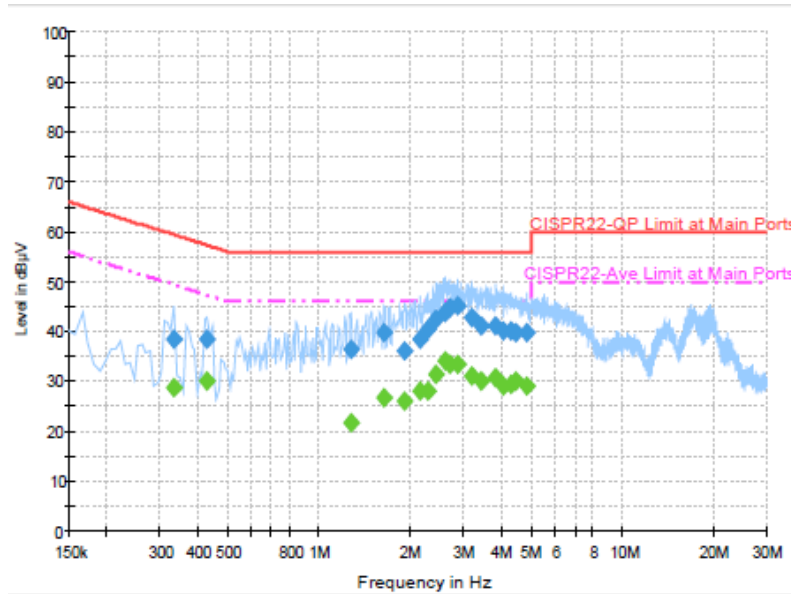

#### Final Result : QuasiPeak

Frequency (MHz)	QuasiPeak (dBµV)	Filter	Line	Corr. (dB)	Margin (dB)	Limit (dBµV)
0.334000	38.5	Off	L1	19.4	20.9	59.4
0.430000	38.6	Off	L1	19.5	18.7	57.3
1.286000	36.5	Off	L1	19.6	19.5	56.0
1.646000	39.9	Off	L1	19.6	16.1	56.0
1.926000	36.1	Off	L1	19.6	19.9	56.0
2.158000	38.5	Off	L1	19.7	17.5	56.0
2.286000	40.4	Off	L1	19.7	15.6	56.0
2.430000	42.4	Off	L1	19.7	13.6	56.0
2.598000	43.7	Off	L1	19.7	12.3	56.0
2.710000	44.9	Off	L1	19.7	11.1	56.0
2.878000	45.1	Off	L1	19.7	10.9	56.0
3.182000	42.8	Off	L1	19.7	13.2	56.0
3.454000	41.2	Off	L1	19.7	14.8	56.0
3.814000	41.1	Off	L1	19.7	14.9	56.0
4.054000	40.1	Off	L1	19.7	15.9	56.0
4.302000	40.1	Off	L1	19.7	15.9	56.0
4.478000	40.0	Off	L1	19.8	16.0	56.0
4.846000	39.8	Off	L1	19.7	16.2	56.0



Test Mode :	Mode 1	Temperature :	24~25°C
Test Engineer :	Kai-Chun Chu	Relative Humidity :	53~54%
Test Voltage :	120Vac / 60Hz	Phase :	Line
Function Type :	GSM1900 Idle + Bluetooth Link + WLAN (5GHz) Link + Earphone 2 + Battery + MP3 + USB Cable (Charging from Adapter) + SIM2		

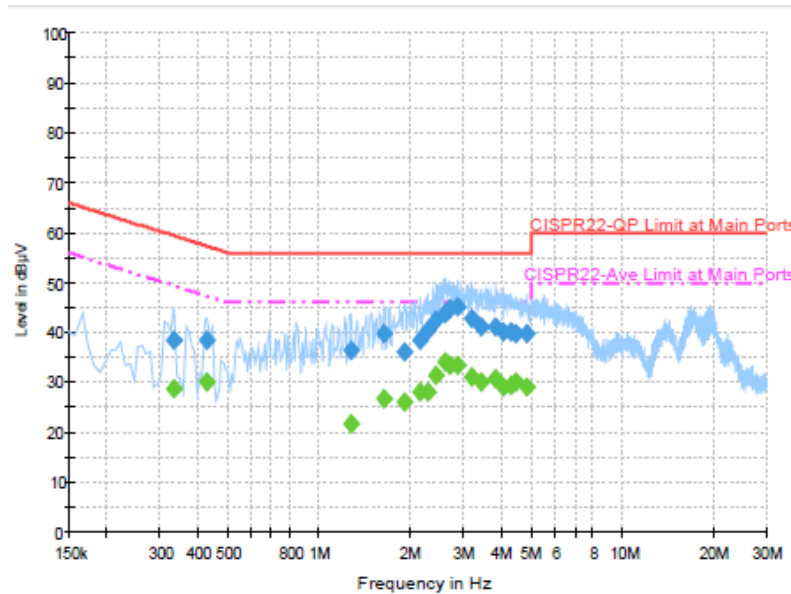

Final Result : Average

Frequency (MHz)	Average (dBµV)	Filter	Line	Corr. (dB)	Margin (dB)	Limit (dBµV)
0.334000	28.6	Off	L1	19.4	20.8	49.4
0.430000	30.2	Off	L1	19.5	17.1	47.3
1.286000	21.8	Off	L1	19.6	24.2	46.0
1.646000	26.9	Off	L1	19.6	19.1	46.0
1.926000	26.2	Off	L1	19.6	19.8	46.0
2.158000	28.0	Off	L1	19.7	18.0	46.0
2.286000	28.1	Off	L1	19.7	17.9	46.0
2.430000	31.5	Off	L1	19.7	14.5	46.0
2.598000	34.0	Off	L1	19.7	12.0	46.0
2.710000	33.4	Off	L1	19.7	12.6	46.0
2.878000	33.4	Off	L1	19.7	12.6	46.0
3.182000	31.1	Off	L1	19.7	14.9	46.0
3.454000	30.0	Off	L1	19.7	16.0	46.0
3.814000	30.6	Off	L1	19.7	15.4	46.0
4.054000	29.0	Off	L1	19.7	17.0	46.0
4.302000	29.3	Off	L1	19.7	16.7	46.0
4.478000	30.0	Off	L1	19.8	16.0	46.0
4.846000	29.0	Off	L1	19.7	17.0	46.0



Test Mode :	Mode 1	Temperature :	24~25°C
Test Engineer :	Kai-Chun Chu	Relative Humidity :	53~54%
Test Voltage :	120Vac / 60Hz	Phase :	Neutral
Function Type :	GSM1900 Idle + Bluetooth Link + WLAN (5GHz) Link + Earphone 2 + Battery + MP3 + USB Cable (Charging from Adapter) + SIM2		

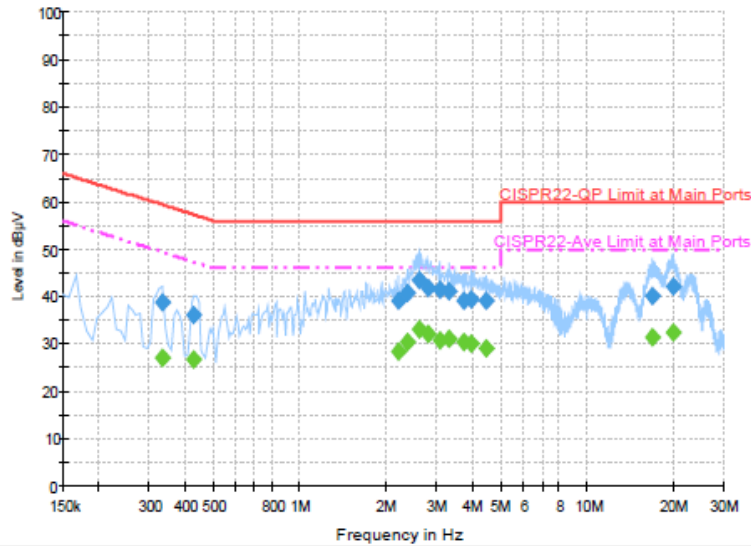

Final Result : QuasiPeak

Frequency (MHz)	QuasiPeak (dBµV)	Filter	Line	Corr. (dB)	Margin (dB)	Limit (dBµV)
0.334000	38.8	Off	N	19.4	20.6	59.4
0.430000	36.2	Off	N	19.5	21.1	57.3
2.214000	39.0	Off	N	19.7	17.0	56.0
2.374000	40.8	Off	N	19.7	15.2	56.0
2.598000	43.4	Off	N	19.6	12.6	56.0
2.806000	41.8	Off	N	19.7	14.2	56.0
3.094000	41.6	Off	N	19.7	14.4	56.0
3.318000	41.3	Off	N	19.7	14.7	56.0
3.750000	39.2	Off	N	19.7	16.8	56.0
3.982000	39.6	Off	N	19.7	16.4	56.0
4.478000	39.1	Off	N	19.7	16.9	56.0
16.862000	40.2	Off	N	20.0	19.8	60.0
19.918000	42.0	Off	N	20.1	18.0	60.0



Test Mode :	Mode 1	Temperature :	24~25°C
Test Engineer :	Kai-Chun Chu	Relative Humidity :	53~54%
Test Voltage :	120Vac / 60Hz	Phase :	Neutral
Function Type :	GSM1900 Idle + Bluetooth Link + WLAN (5GHz) Link + Earphone 2 + Battery + MP3 + USB Cable (Charging from Adapter) + SIM2		

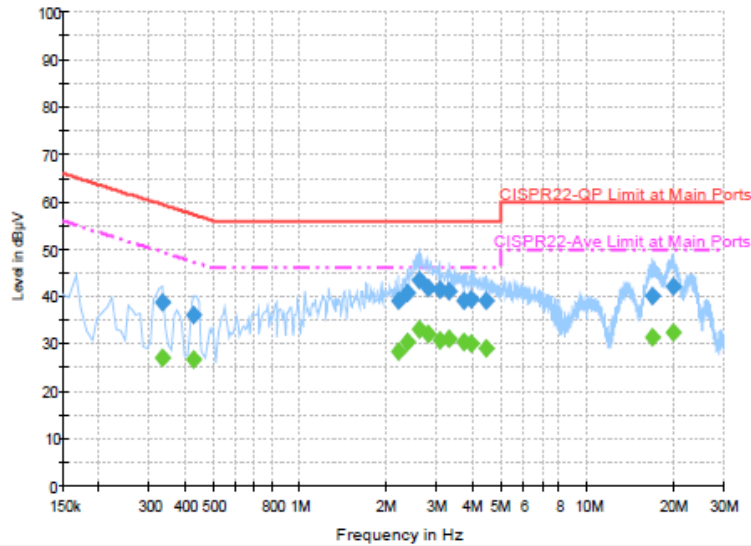

Final Result : Average

Frequency (MHz)	Average (dBµV)	Filter	Line	Corr. (dB)	Margin (dB)	Limit (dBµV)
0.334000	27.1	Off	N	19.4	22.3	49.4
0.430000	26.8	Off	N	19.5	20.5	47.3
2.214000	28.5	Off	N	19.7	17.5	46.0
2.374000	30.4	Off	N	19.7	15.6	46.0
2.598000	33.0	Off	N	19.6	13.0	46.0
2.806000	32.0	Off	N	19.7	14.0	46.0
3.094000	30.9	Off	N	19.7	15.1	46.0
3.318000	31.0	Off	N	19.7	15.0	46.0
3.750000	30.3	Off	N	19.7	15.7	46.0
3.982000	30.2	Off	N	19.7	15.8	46.0
4.478000	29.2	Off	N	19.7	16.8	46.0
16.862000	31.4	Off	N	20.0	18.6	50.0
19.918000	32.5	Off	N	20.1	17.5	50.0

## 3.6 Frequency Stability Measurement

### 3.6.1 Limit of Frequency Stability

Manufacturers of U-NII devices are responsible for ensuring frequency stability such that an emission is maintained within the band of operation under all conditions of normal operation as specified in the user's manual.

### 3.6.2 Measuring Instruments

The measuring equipment is listed in the section 4 of this test report.

### 3.6.3 Test Procedures

1. To ensure emission at the band edge is maintained within the authorized band, those values shall be measured by radiation emissions at upper and lower frequency points, and finally compensated by frequency deviation as procedures below.
2. The EUT was operated at the maximum output power, and connected to the spectrum analyzer, which is set to maximum hold function and peak detector. The peak value of the power envelope was measured and noted. The upper and lower frequency points were respectively measured relatively 10dB lower than the measured peak value.
3. The frequency deviation was calculated by adding the upper frequency point and the lower frequency point divided by two. Those detailed values of frequency deviation are provided in table below.

### 3.6.4 Test Setup

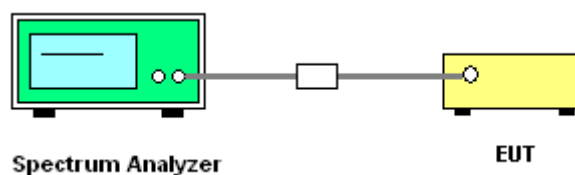

### 3.6.5 Test Result of Frequency Stability

Please refer to Appendix A.



## **3.7 Automatically Discontinue Transmission**

### **3.7.1 Limit of Automatically Discontinue Transmission**

The device shall automatically discontinue transmission in case of either absence of information to transmit or operational failure. These provisions are not intended to preclude the transmission of control or signaling information or the use of repetitive codes used by certain digital technologies to complete frame or burst intervals. Applicants shall include in their application for equipment authorization to describe how this requirement is met.

### **3.7.2 Measuring Instruments**

The measuring equipment is listed in the section 4 of this test report.

### **3.7.3 Test Result of Automatically Discontinue Transmission**

While the EUT is not transmitting any information, the EUT can automatically discontinue transmission and become standby mode for power saving. The EUT can detect the controlling signal of ACK message transmitting from remote device and verify whether it shall resend or discontinue transmission.



## **3.8 Antenna Requirements**

### **3.8.1 Standard Applicable**

According to FCC 47 CFR Section 15.407(a)(1)(2) ,if transmitting antenna directional gain is greater than 6 dBi, both the peak transmit power and the peak power spectral density shall be reduced by the amount in dB that the directional gain of the antenna exceeds 6 dBi.

### **3.8.2 Antenna Anti-Replacement Construction**

An embedded-in antenna design is used.

### **3.8.3 Antenna Gain**

The antenna gain is less than 6 dBi. Therefore, it is not necessary to reduce maximum peak output power limit.



## 4 List of Measuring Equipment

Instrument	Manufacturer	Model No.	Serial No.	Characteristics	Calibration Date	Test Date	Due Date	Remark
Power Meter	Anritsu	ML2495A	1218006	300MHz~40GHz	Oct. 18, 2014	May 09, 2015~ May 11, 2015	Oct. 17, 2015	Conducted (TH05-HY)
Power Sensor	Anritsu	MA2411B	1126017	300MHz~40GHz	Aug. 22, 2014	May 09, 2015~ May 11, 2015	Aug. 21, 2015	Conducted (TH05-HY)
Spectrum Analyzer	Rohde & Schwarz	FSP40	100057	9kHz~40GHz	Oct. 17, 2014	May 09, 2015~ May 11, 2015	Oct. 16, 2015	Conducted (TH05-HY)
Temperature Chamber	ESPEC	SU-241	92003713	-30 ~95 degree	Jun. 18, 2014	May 09, 2015~ May 11, 2015	Jun. 17, 2015	Conducted (TH05-HY)
Hygrometer	Testo	608-H2	41410069	N/A	Jul. 17, 2014	May 09, 2015~ May 11, 2015	Jul. 16, 2015	Conducted (TH05-HY)
RF cable	WOKEN	S05	S05-130708-038	N/A	Jan. 21, 2015	May 09, 2015~ May 11, 2015	Jan. 20, 2016	Conducted (TH05-HY)
Amplifier	SONOMA	310N	187312	9kHz~1GHz	Nov. 24, 2014	May 06, 2015~ May 12, 2015	Nov. 23, 2015	Radiation (03CH11-HY)
Bilog Antenna	TESEQ	CBL 6111D	35414	30MHz~1GHz	Oct. 24, 2014	May 06, 2015~ May 12, 2015	Oct. 23, 2015	Radiation (03CH11-HY)
Horn Antenna	SCHWARZBECK	BBHA 9120 D	9120D-1326	1GHz ~ 18GHz	Oct. 03, 2014	May 06, 2015~ May 12, 2015	Oct. 02, 2015	Radiation (03CH11-HY)
Hygrometer	TECPEL	DTN-303B	TP140325	N/A	Nov. 19, 2014	May 06, 2015~ May 12, 2015	Nov. 18, 2015	Radiation (03CH11-HY)
Preamplifier	Keysight	83017A	MY53270080	1GHz~26.5GHz	Nov. 20, 2014	May 06, 2015~ May 12, 2015	Nov. 19, 2015	Radiation (03CH11-HY)
Spectrum Analyzer	Keysight	N9010A	MY54200486	10Hz ~ 44GHZ	Sep. 24, 2014	May 06, 2015~ May 12, 2015	Sep. 23, 2015	Radiation (03CH11-HY)
RF Cable	HUBER + SUHNER	SUCOFLEX 104	MY24967/4 MY28419/4 MY28654/4	25GHz~40GHz	Nov. 06, 2014	May 06, 2015~ May 12, 2015	Nov. 05, 2015	Radiation (03CH11-HY)
RF Cable	HUBER + SUHNER	SUCOFLEX 104	MY24967/4 MY28419/4 MY28654/4	30MHz~1GHz	Nov. 06, 2014	May 06, 2015~ May 12, 2015	Nov. 05, 2015	Radiation (03CH11-HY)
RF Cable	HUBER + SUHNER	SUCOFLEX 104	MY24967/4 MY28419/4 MY28654/4	1GHz~25GHz	Nov. 06, 2014	May 06, 2015~ May 12, 2015	Nov. 05, 2015	Radiation (03CH11-HY)
Controller	EMEC	EM 1000	N/A	Control Turn table & Ant Mast	N/A	May 06, 2015~ May 12, 2015	N/A	Radiation (03CH11-HY)
Antenna Mast	EMEC	AM-BS-4500-B	N/A	1~4m	N/A	May 06, 2015~ May 12, 2015	N/A	Radiation (03CH11-HY)
Turn Table	EMEC	TT 2000	N/A	0-360 degree	N/A	May 06, 2015~ May 12, 2015	N/A	Radiation (03CH11-HY)
Preamplifier	MITEQ	AMF-7D-0010 1800-30-10P	1902247	1GHz~18GHz	Nov. 25, 2014	May 06, 2015~ May 12, 2015	Nov. 24, 2015	Radiation (03CH11-HY)
Preamplifier	MITEQ	JS44-1800400 0-33-8P	1840917	18GHz ~ 40GHz	Jun. 09, 2014	May 06, 2015~ May 12, 2015	Jun. 08, 2015	Radiation (03CH11-HY)
Loop Antenna	Rohde & Schwarz	HFH2-Z2	100315	9 kHz~30 MHz	Jul. 28, 2014	May 06, 2015~ May 12, 2015	Jul. 27, 2015	Radiation (03CH11-HY)





Horn Antenna	SCHWARZBECK	BBHA 9170	BBHA9170584	18GHz- 40GHz	Nov. 03, 2014	May 06, 2015~ May 12, 2015	Nov. 02, 2015	Radiation (03CH11-HY)
EMI Test Receiver	Keysight	N9038A	MY54130085	20Hz ~ 26.5GHz	Nov. 05, 2014	May 06, 2015~ May 12, 2015	Nov. 04, 2015	Radiation (03CH11-HY)
RF Cable	HUBER + SUHNER	SUCOFLEX 104	MY84209521	9KHz~1GHz	Dec. 04, 2014	May 06, 2015~ May 12, 2015	Dec. 03, 2015	Radiation (03CH11-HY)
Filter	Wainwright	WLKS1200-8S	SN3	1.2G Low Pass	Oct. 01, 2014	May 06, 2015~ May 12, 2015	Sep. 30, 2015	Radiation (03CH11-HY)
Filter	Microwave	H3G018G1	SN477220	3.0G High Pass	Oct. 01, 2014	May 06, 2015~ May 12, 2015	Sep. 30, 2015	Radiation (03CH11-HY)
Test Software	Audix	E3	6.2009-8-24	N/A	N/A	May 06, 2015~ May 12, 2015	N/A	Radiation (03CH11-HY)
AC Power Source	ChainTek	APC-1000W	N/A	N/A	N/A	May 10, 2015	N/A	Conduction (CO05-HY)
EMI Test Receiver	Rohde & Schwarz	ESCS 30	100356	9kHz – 2.75GHz	Dec. 01, 2014	May 10, 2015	Nov. 30, 2015	Conduction (CO05-HY)
Hygrometer	Testo	608-H1	34913912	N/A	Apr. 20, 2015	May 10, 2015	Apr. 19, 2016	Conduction (CO05-HY)
LISN	Rohde & Schwarz	ENV216	100080	9kHz~30MHz	Dec. 02, 2014	May 10, 2015	Dec. 01, 2015	Conduction (CO05-HY)
LF Cable	HUBER + SUHNER	RG-214/U	LF01	N/A	Jan. 02, 2015	May 10, 2015	Jan. 01, 2016	Conduction (CO05-HY)
Test Software	N/A	EMC32	8.40.0	N/A	N/A	May 10, 2015	N/A	Conduction (CO05-HY)



## 5 Uncertainty of Evaluation

### Uncertainty of Conducted Emission Measurement (150kHz ~ 30MHz)

Measuring Uncertainty for a Level of Confidence of 95% ( $U = 2Uc(y)$ )	2.26
---	------

### Uncertainty of Radiated Emission Measurement (30 MHz ~ 1000 MHz)

Measuring Uncertainty for a Level of Confidence of 95% ( $U = 2Uc(y)$ )	4.90
---	------



## **Appendix A. Conducted Test Results**

Test Engineer:	Derek Hsu	Temperature:	21~25	°C
Test Date:	2015/5/9~2015/05/11	Relative Humidity:	51~54	%

**TEST RESULTS DATA**  
**6dB and 99% OBW**

Band IV							
Mod.	Data Rate	NTX	CH.	Freq. (MHz)	6 dB Bandwidth (MHz)	FCC 6dB Bandwidth Limit (MHz)	Pass/Fail
11a	6M bps	1	149	5745	16.35	0.5	Pass
11a	6Mbps	1	157	5785	16.33	0.5	Pass
11a	6Mbps	1	165	5825	16.37	0.5	Pass
HT20	MCS 0	1	149	5745	17.58	0.5	Pass
HT20	MCS 0	1	157	5785	17.62	0.5	Pass
HT20	MCS 0	1	165	5825	17.62	0.5	Pass
HT40	MCS 0	1	151	5755	35.85	0.5	Pass
HT40	MCS 0	1	159	5795	35.85	0.5	Pass

**TEST RESULTS DATA**  
**Average Power Table**

FCC Band IV										
Mod.	Data Rate	NTX	CH.	Freq. (MHz)	Duty Factor (dB)	Average Conducted Power (dBm)	FCC Conducted Power Limit (dBm)	DG (dBi)		Pass/Fail
11a	6M bps	1	149	5745	0.53	11.10	30.00	-0.30		Pass
11a	6Mbps	1	157	5785	0.53	11.01	30.00	-0.30		Pass
11a	6Mbps	1	165	5825	0.53	11.20	30.00	-0.30		Pass
HT20	MCS 0	1	149	5745	0.53	11.05	30.00	-0.30		Pass
HT20	MCS 0	1	157	5785	0.53	11.21	30.00	-0.30		Pass
HT20	MCS 0	1	165	5825	0.53	11.26	30.00	-0.30		Pass
HT40	MCS 0	1	151	5755	0.99	11.49	30.00	-0.30		Pass
HT40	MCS 0	1	159	5795	0.99	11.24	30.00	-0.30		Pass

**TEST RESULTS DATA**  
**Power Spectral Density**

Band IV										
Mod.	Data Rate	NTX	CH.	Freq. (MHz)	Duty Factor (dB)	10log (500kHz /RBW) Factor (dB)	Average Power Density (dBm/500kHz)	Average PSD Limit (dBm/500kHz)	DG (dBi)	Pass/Fail
11a	6M bps	1	149	5745	0.53	2.22	-2.03	30.00	-0.30	Pass
11a	6Mbps	1	157	5785	0.53	2.22	-2.02	30.00	-0.30	Pass
11a	6Mbps	1	165	5825	0.53	2.22	-2.56	30.00	-0.30	Pass
HT20	MCS 0	1	149	5745	0.53	2.22	-2.17	30.00	-0.30	Pass
HT20	MCS 0	1	157	5785	0.53	2.22	-2.45	30.00	-0.30	Pass
HT20	MCS 0	1	165	5825	0.53	2.22	-2.79	30.00	-0.30	Pass
HT40	MCS 0	1	151	5755	0.99	2.22	-7.71	30.00	-0.30	Pass
HT40	MCS 0	1	159	5795	0.99	2.22	-5.02	30.00	-0.30	Pass

**TEST RESULTS DATA**  
**Frequency Stability**

Band IV										
Mod.	Data Rate	NTX	CH.	Freq. (MHz)	Center Frequency (MHz)	Frequency Deviation (MHz)	Frequency Stability (ppm)	Temperature (°C)	Voltage (V)	Note
11a	6M bps	1	149	5745	5745.000	0.000	0.00	20	3.5	
11a	6M bps	1	149	5745	5744.984	-0.016	-2.79	20	4.1	
11a	6M bps	1	149	5745	5745.000	0.000	0.00	20	3.7	
11a	6M bps	1	149	5745	5745.000	0.000	0.00	-30	3.7	
11a	6M bps	1	149	5745	5745.000	0.000	0.00	50	3.7	