



FCC RF Test Report

APPLICANT : Sony Mobile Communications Inc.
EQUIPMENT : Smart phone
BRAND NAME : SONY
TYPE NAME : PM-0891-BV
FCC ID : PY7-PM0891
STANDARD : FCC 47 CFR Part 2, 22(H), 24(E)
CLASSIFICATION : PCS Licensed Transmitter Held to Ear (PCE)

The product was received on Apr. 29, 2015 and testing was completed on May 08, 2015. We, SPORTON INTERNATIONAL INC., would like to declare that the tested sample has been evaluated in accordance with the test procedures given in ANSI / TIA / EIA-603-C-2004 and has been in compliance with the applicable technical standards.

The test results in this report apply exclusively to the tested model / sample. Without written approval of SPORTON INTERNATIONAL INC., the test report shall not be reproduced except in full.

Reviewed by: Joseph Lin / Supervisor

Approved by: Jones Tsai / Manager



SPORTON INTERNATIONAL INC.

No. 52, Hwa Ya 1st Rd., Hwa Ya Technology Park, Kwei-Shan District, Tao Yuan City, Taiwan, R.O.C.

SPORTON INTERNATIONAL INC.
TEL : 886-3-327-3456
FAX : 886-3-328-4978
FCC ID : PY7-PM0891

Page Number : 1 of 104
Report Issued Date : Jul. 06, 2015
Report Version : Rev. 01
Report Template No.: BU5-FG22/24 Version 1.2



TABLE OF CONTENTS

REVISION HISTORY.....3

SUMMARY OF TEST RESULT4

1 GENERAL DESCRIPTION.....5

 1.1 Applicant.....5

 1.2 Manufacturer5

 1.3 Product Feature of Equipment Under Test5

 1.4 Product Specification subjective to this standard.....6

 1.5 Modification of EUT7

 1.6 Maximum ERP/EIRP Power, Frequency Tolerance, and Emission Designator7

 1.7 Testing Location8

 1.8 Applicable Standards8

2 TEST CONFIGURATION OF EQUIPMENT UNDER TEST.....9

 2.1 Test Mode.....9

 2.2 Connection Diagram of Test System 11

 2.3 Support Unit used in test configuration 11

 2.4 Measurement Results Explanation Example 11

3 TEST RESULT..... 12

 3.1 Conducted Output Power Measurement..... 12

 3.2 Peak-to-Average Ratio 14

 3.3 Effective Radiated Power and Effective Isotropic Radiated Power Measurement28

 3.4 99% Occupied Bandwidth and 26dB Bandwidth Measurement.....32

 3.5 Band Edge Measurement.....52

 3.6 Conducted Spurious Emission Measurement..... 59

 3.7 Field Strength of Spurious Radiation Measurement78

 3.8 Frequency Stability Measurement.....98

4 LIST OF MEASURING EQUIPMENT 103

5 UNCERTAINTY OF EVALUATION..... 104



REVISION HISTORY

REPORT NO.	VERSION	DESCRIPTION	ISSUED DATE
FG542942A	Rev. 01	Initial issue of report	Jul. 06, 2015



SUMMARY OF TEST RESULT

Report Section	FCC Rule	Description	Limit	Result	Remark
3.1	§2.1046	Conducted Output Power	N/A	PASS	-
3.2	§24.232(d)	Peak-to-Average Ratio	<13 dB	PASS	-
3.3	§22.913(a)(2)	Effective Radiated Power	< 7 Watts	PASS	-
	§24.232(c)	Equivalent Isotropic Radiated Power	< 2 Watts	PASS	-
3.4	§2.1049	Occupied Bandwidth	N/A	PASS	-
3.5	§2.1051 §22.917(a) §24.238(a)	Band Edge Measurement	< 43+10log ₁₀ (P[Watts])	PASS	-
3.6	§2.1051 §22.917(a) §24.238(a)	Conducted Spurious Emission	< 43+10log ₁₀ (P[Watts])	PASS	-
3.7	§2.1053 §22.917(a) §24.238(a)	Field Strength of Spurious Radiation	< 43+10log ₁₀ (P[Watts])	PASS	Under limit 19.26 dB at 2512.000 MHz
3.8	§2.1055 §22.355	Frequency Stability for Temperature & Voltage	< 2.5 ppm for Part 22 Within Authorized Band	PASS	-
	§2.1055 §24.235				



1 General Description

1.1 Applicant

Sony Mobile Communications Inc.
Nya Vattentorget, 22188 Lund, Sweden

1.2 Manufacturer

Arima Communications Corp.
6F, No. 866, Jhongjheng Rd., Jhonghe Dist., New Taipei City 23586, Taiwan

1.3 Product Feature of Equipment Under Test

The Equipment Under Test (hereafter called: EUT) is Smart phone supporting, GSM / WCDMA / LTE, Wi-Fi 2.4GHz 802.11b/g/n, 5GHz 802.11a/n, Bluetooth with FM Receiver, GPS and NFC features, and below is details of information.

Product Feature	
Equipment	Smart phone
Brand Name	SONY
Type Name	PM-0891-BV
FCC ID	PY7-PM0891
GSM Operating Band(s)	GSM 850/900/1800/1900MHz
GPRS / EGPRS Multi Slot Class	GPRS Class 12, EGPRS Class 12
WCDMA Operating Band(s)	FDD Band I / II / V / VIII
WCDMA Rel. Version	Rel. 8
LTE Operating Band(s)	FDD Band I / III / V / VII / VIII / XXVII TDD Band XL
LTE Rel. Version	Rel. 8
Wi-Fi Specification	802.11a/b/g/n HT20/HT40
Bluetooth Version	v3.0 + EDR / v4.0 - LE
NFC Specification	ISO14443A / ISO14443B / Felica
Power Supply	Battery / AC Adapter / Car Charger

Remark: The above EUT's information was declared by manufacturer. Please refer to the specifications or user's manual for more detailed description.



1.4 Product Specification subjective to this standard

Product Specification subjective to this standard	
Tx Frequency	GSM850: 824.2 MHz ~ 848.8 MHz GSM1900: 1850.2 MHz ~ 1909.8MHz WCDMA Band V: 826.4 MHz ~ 846.6 MHz WCDMA Band II: 1852.4 MHz ~ 1907.6 MHz
Rx Frequency	GSM850: 869.2 MHz ~ 893.8 MHz GSM1900: 1930.2 MHz ~ 1989.8 MHz WCDMA Band V: 871.4 MHz ~ 891.6 MHz WCDMA Band II: 1932.4 MHz ~ 1987.6 MHz
Maximum Output Power to Antenna	GSM850 : 32.77 dBm GSM1900 : 29.85 dBm WCDMA Band V : 23.50 dBm WCDMA Band II : 24.00 dBm
Antenna Type	Coupling type (LDS) Antenna
Type of Modulation	GSM: GMSK GPRS: GMSK EDGE: GMSK / 8PSK WCDMA: QPSK (Uplink) HSDPA: 64QAM (Downlink) HSUPA: QPSK (Uplink)

EUT Information List				
IMEI	HW Version	SW Version	S/N	Performed Test Item
IMEI 1: 004402454617261 IMEI 2: 004402454617279	A	29.0.B.0.76	WUJ01HWJMW	RF conducted measurement
				Radiated Spurious Emission
				Effective Radiated Power and Equivalent Isotropic Radiated Power



Accessory List	
AC Adapter	Model No. : EP800
	Type No. : CAA-0002016-US B
	S/N : 3113W 45 108550
Battery	Model No. : LIS1579ERPC
Earphone 1	Model No. : MH410c
	Type No. : AG-1100
	S/N : 14341EB00068DB2
Earphone 2	Model No. : MH410c
	Type No. : AG-1103
	S/N : 142820450123D30
USB Cable	Model No. : EC450
	Type No. : AI-0700
	S/N : 134912D70008842

1.5 Modification of EUT

No modifications are made to the EUT during all test items.

1.6 Maximum ERP/EIRP Power, Frequency Tolerance, and Emission Designator

FCC Rule	System	Type of Modulation	Maximum ERP/EIRP (W)	Frequency Tolerance (ppm)	Emission Designator
Part 22	GSM850 GPRS class 8	GMSK	0.8260	0.0096 ppm	248KGXW
Part 22	GSM850 EDGE class 8	8PSK	0.2630	0.0311 ppm	251KG7W
Part 22	WCDMA Band V RMC 12.2Kbps	QPSK	0.0566	0.0167 ppm	4M21F9W
Part 24	GSM1900 GPRS class 8	GMSK	0.5047	0.0181 ppm	248KGXW
Part 24	GSM1900 EDGE class 8	8PSK	0.2065	0.0170 ppm	252KG7W
Part 24	WCDMA Band II RMC 12.2Kbps	QPSK	0.1161	0.0096 ppm	4M22F9W



1.7 Testing Location

Sporton Lab is accredited to ISO 17025 by Taiwan Accreditation Foundation (TAF code : 1190) and the FCC designation No. TW1022 under the FCC 2.948(e) by Mutual Recognition Agreement (MRA) in FCC Test.

Test Site	SPORTON INTERNATIONAL INC.
Test Site Location	No. 52, Hwa Ya 1 st Rd., Hwa Ya Technology Park, Kwei-Shan District, Tao Yuan City, Taiwan, R.O.C. TEL: +886-3-327-3456 FAX: +886-3-328-4978
Test Site No.	Sporton Site No.
	TH03-HY

Test Site	SPORTON INTERNATIONAL INC.
Test Site Location	No.58, Aly. 75, Ln. 564, Wenhua 3rd Rd. Kwei-Shan District, Tao Yuan City, Taiwan (R.O.C.) TEL: +886-3-327-0855
Test Site No.	Sporton Site No.
	03CH10-HY

1.8 Applicable Standards

According to the specifications of the manufacturer, the EUT must comply with the requirements of the following standards:

- ♦ FCC 47 CFR Part 2, 22(H), 24(E)
- ♦ ANSI / TIA / EIA-603-C-2004
- ♦ FCC KDB 971168 D01 Power Meas. License Digital Systems v02r02

Remark:

1. All test items were verified and recorded according to the standards and without any deviation during the test.
2. This EUT has also been tested and complied with the requirements of FCC Part 15, Subpart B, recorded in a separate test report.



2 Test Configuration of Equipment Under Test

2.1 Test Mode

Antenna port conducted and radiated test items were performed according to KDB 971168 D01 Power Meas. License Digital Systems v02r02 with maximum output power.

Radiated measurements were performed with rotating EUT in different three orthogonal test planes to find the maximum emission.

Radiated emissions were investigated as following frequency range:

1. 30 MHz to 9000 MHz for GSM850 and WCDMA Band V.
2. 30 MHz to 19000 MHz for GSM1900 and WCDMA Band II.

All modes and data rates and positions were investigated.

Test modes are chosen to be reported as the worst case configuration below:

Test Modes		
Band	Radiated TCs	Conducted TCs
GSM 850	<ul style="list-style-type: none">■ GPRS class 8 Link■ EDGE class 8 Link	<ul style="list-style-type: none">■ GPRS class 8 Link■ EDGE class 8 Link
GSM 1900	<ul style="list-style-type: none">■ GPRS class 8 Link■ EDGE class 8 Lin	<ul style="list-style-type: none">■ GPRS class 8 Link■ EDGE class 8 Link
WCDMA Band V	<ul style="list-style-type: none">■ RMC 12.2Kbps Link	<ul style="list-style-type: none">■ RMC 12.2Kbps Link
WCDMA Band II	<ul style="list-style-type: none">■ RMC 12.2Kbps Link	<ul style="list-style-type: none">■ RMC 12.2Kbps Link

Note: The maximum power levels are chosen to test as the worst case configuration as follows:

GPRS multi-slot class 8 mode for GMSK modulation, EDGE multi-slot class 8 mode for 8PSK modulation, RMC 12.2Kbps mode for WCDMA band V and RMC 12.2Kbps mode for WCDMA band II, only these modes were used for all tests.



Conducted Power Measurement Results:

Conducted Power (*Unit: dBm)						
Band	GSM850			GSM1900		
Channel	128	189	251	512	661	810
Frequency	824.2	836.4	848.8	1850.2	1880.0	1909.8
GSM	32.68	32.72	32.75	29.83	29.82	29.82
GPRS class 8	32.70	32.75	32.77	29.85	29.84	29.84
GPRS class 10	29.38	29.20	29.06	26.19	26.20	26.15
GPRS class 11	27.97	27.71	27.58	24.98	25.87	24.94
GPRS class 12	27.50	27.37	27.18	23.84	23.87	23.80
EGPRS class 8	26.69	26.96	26.73	25.91	25.99	25.97
EGPRS class 10	24.85	25.11	24.89	24.17	24.23	24.20
EGPRS class 11	22.90	23.20	22.97	21.89	21.96	21.99
EGPRS class 12	22.85	23.09	22.83	23.01	23.00	23.00

Conducted Power (*Unit: dBm)						
Band	WCDMA Band V			WCDMA Band II		
Channel	4132	4182	4233	9262	9400	9538
Frequency	826.4	836.4	846.6	1852.4	1880.0	1907.6
RMC 12.2K	23.50	23.45	23.48	24.00	23.97	23.96
HSDPA Subtest-1	22.56	22.52	22.56	23.98	23.95	23.99
HSDPA Subtest-2	22.15	22.11	22.13	23.97	23.92	23.98
HSDPA Subtest-3	21.79	21.75	21.78	23.50	23.46	23.49
HSDPA Subtest-4	21.71	21.67	21.68	23.50	23.43	23.49
HSUPA Subtest-1	20.53	20.51	20.53	22.07	22.02	22.02
HSUPA Subtest-2	20.53	20.51	20.52	22.00	21.88	21.98
HSUPA Subtest-3	21.55	21.53	21.54	23.00	22.89	22.99
HSUPA Subtest-4	20.03	20.00	20.01	21.59	21.53	21.46
HSUPA Subtest-5	22.07	22.08	22.04	23.99	23.86	23.94

2.2 Connection Diagram of Test System

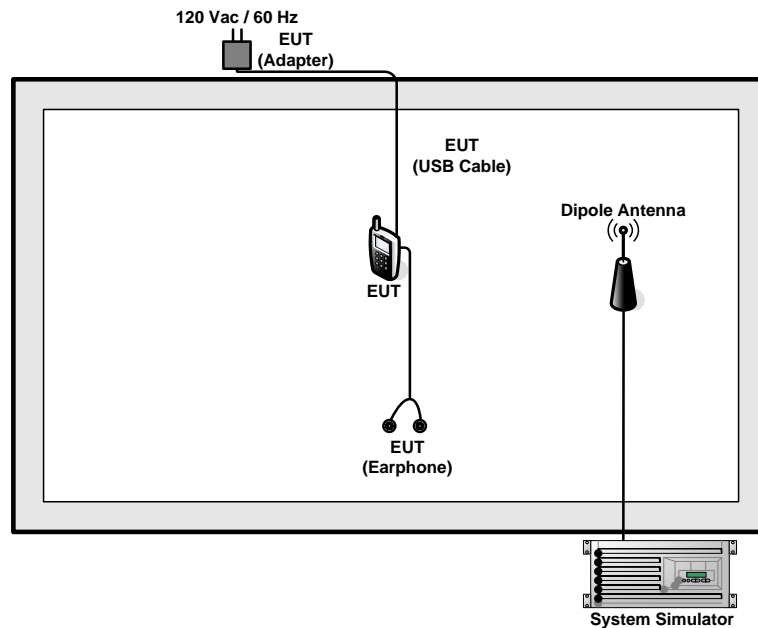

2.3 Support Unit used in test configuration

Item	Equipment	Trade Name	Model No.	FCC ID	Data Cable	Power Cord
1.	System Simulator	R&S	CMU 200	N/A	N/A	Unshielded, 1.8 m

2.4 Measurement Results Explanation Example

For all conducted test items:

The offset level is set in the spectrum analyzer to compensate the RF cable loss and attenuator factor between RF conducted output port and spectrum analyzer. With the offset compensation, the spectrum analyzer reading level will be exactly the RF output level.

The spectrum analyzer offset is derived from RF cable loss and attenuator factor.

Offset = RF cable loss + attenuator factor.

The following shows an offset computation example with RF cable loss 4.2 dB and a 10dB attenuator.

Example :

Offset(dB) = RF cable loss(dB) + attenuator factor(dB).

$$= 4.2 + 10 = 14.2 \text{ (dB)}$$

3 Test Result

3.1 Conducted Output Power Measurement

3.1.1 Description of the Conducted Output Power Measurement

A system simulator was used to establish communication with the EUT. Its parameters were set to enforce EUT transmitting at the maximum power. The measured power in the radio frequency on the transmitter output terminals shall be reported.

3.1.2 Measuring Instruments

The measuring equipment is listed in the section 4 of this test report.

3.1.3 Test Procedures

1. The transmitter output port was connected to the system simulator.
2. Set EUT at maximum power through system simulator.
3. Select lowest, middle, and highest channels for each band and different modulation.
4. Measure the maximum burst average power for GSM and maximum average power for other modulation signal.

3.1.4 Test Setup

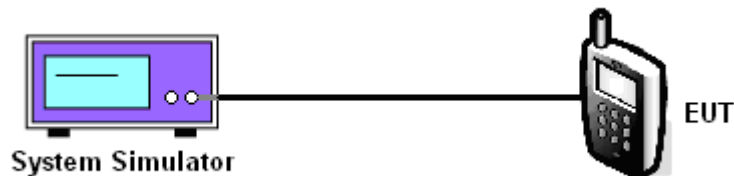



3.1.5 Test Result of Conducted Output Power

Cellular Band									
Modes	GSM850 (GPRS class 8)			GSM850 (EDGE class 8)			WCDMA Band V (RMC 12.2Kbps)		
Channel	128 (Low)	189 (Mid)	251 (High)	128 (Low)	189 (Mid)	251 (High)	4132 (Low)	4182 (Mid)	4233 (High)
Frequency (MHz)	824.2	836.4	848.8	824.2	836.4	848.8	826.4	836.4	846.6
Conducted Power (dBm)	32.70	32.75	32.77	26.69	26.96	26.73	23.50	23.45	23.48

PCS Band									
Modes	GSM1900 (GPRS class 8)			GSM1900 (EDGE class 8)			WCDMA Band II (RMC 12.2Kbps)		
Channel	512 (Low)	661 (Mid)	810 (High)	512 (Low)	661 (Mid)	810 (High)	9262 (Low)	9400 (Mid)	9538 (High)
Frequency (MHz)	1850.2	1880	1909.8	1850.2	1880	1909.8	1852.4	1880	1907.6
Conducted Power (dBm)	29.85	29.84	29.84	25.91	25.99	25.97	24.00	23.97	23.96

Note: maximum burst average power for GSM, and maximum average power for WCDMA

3.2 Peak-to-Average Ratio

3.2.1 Description of the PAR Measurement

The peak-to-average ratio (PAR) of the transmission may not exceed 13 dB.

3.2.2 Measuring Instruments

The measuring equipment is listed in the section 4 of this test report.

3.2.3 Test Procedures

1. The testing follows FCC KDB 971168 v02r02 Section 5.7.1.
2. The EUT was connected to spectrum analyzer and system simulator via a power divider.
3. Set EUT to transmit at maximum output power.
4. When the duty cycle is less than 98%, then signal gating will be implemented on the spectrum analyzer by triggering from the system simulator.
5. Set the CCDF (Complementary Cumulative Distribution Function) option of the spectrum analyzer.
Record the maximum PAPR level associated with a probability of 0.1%.

3.2.4 Test Setup

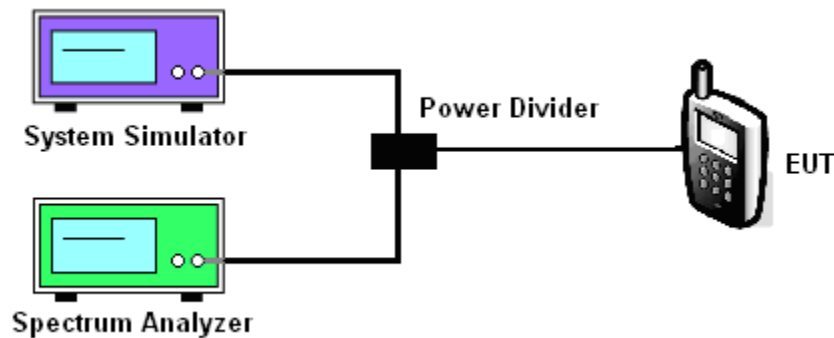



3.2.5 Test Result of Peak-to-Average Ratio

Cellular Band									
Modes	GSM850 (GPRS class 8)			GSM850 (EDGE class 8)			WCDMA Band V (RMC 12.2Kbps)		
Channel	128 (Low)	189 (Mid)	251 (High)	128 (Low)	189 (Mid)	251 (High)	4132 (Low)	4182 (Mid)	4233 (High)
Frequency (MHz)	824.2	836.4	848.8	824.2	836.4	848.8	826.4	836.4	846.6
Peak-to-Average Ratio (dB)	0.24	0.20	0.20	3.32	3.20	3.20	2.72	3.12	3.12

PCS Band									
Modes	GSM1900 (GPRS class 8)			GSM1900 (EDGE class 8)			WCDMA Band II (RMC 12.2Kbps)		
Channel	512 (Low)	661 (Mid)	810 (High)	512 (Low)	661 (Mid)	810 (High)	9262 (Low)	9400 (Mid)	9538 (High)
Frequency (MHz)	1850.2	1880	1909.8	1850.2	1880	1909.8	1852.4	1880	1907.6
Peak-to-Average Ratio (dB)	0.24	0.24	0.24	3.40	3.36	3.00	3.08	3.12	2.96



3.2.6 Test Result (Plots) of Peak-to-Average Ratio

Band :	GSM 850	Test Mode :	GPRS class 8 Link (GMSK)
---------------	---------	--------------------	--------------------------

Peak-to-Average Ratio on Channel 128 (824.2 MHz)

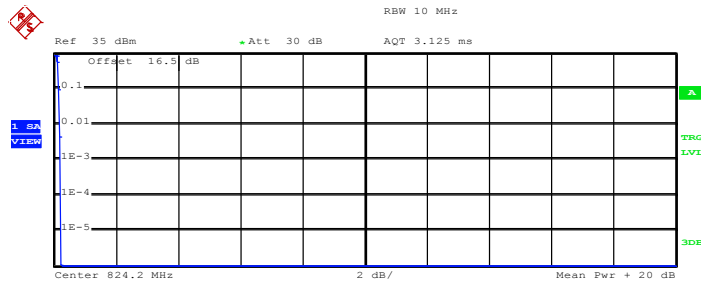

Complementary Cumulative Distribution Function (100000 samples)

Trace 1
 Mean 30.78 dBm
 Peak 31.02 dBm
 Crest 0.24 dB

10 %	0.16 dB
1 %	0.20 dB
.1 %	0.24 dB
.01 %	0.24 dB

Date: 8.MAY.2015 09:38:33

Peak-to-Average Ratio on Channel 189 (836.4 MHz)

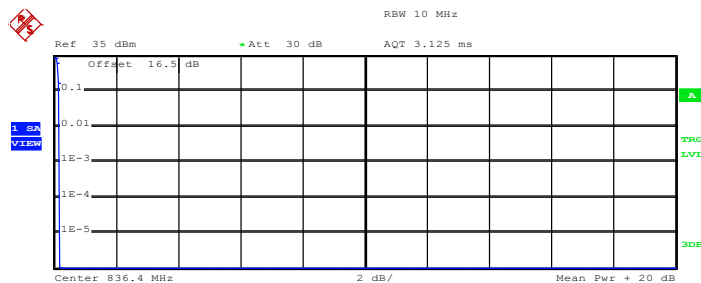

Complementary Cumulative Distribution Function (100000 samples)

Trace 1
 Mean 31.41 dBm
 Peak 31.58 dBm
 Crest 0.17 dB

10 %	0.16 dB
1 %	0.20 dB
.1 %	0.20 dB
.01 %	0.20 dB

Date: 8.MAY.2015 09:38:47



Peak-to-Average Ratio on Channel 251 (848.8 MHz)

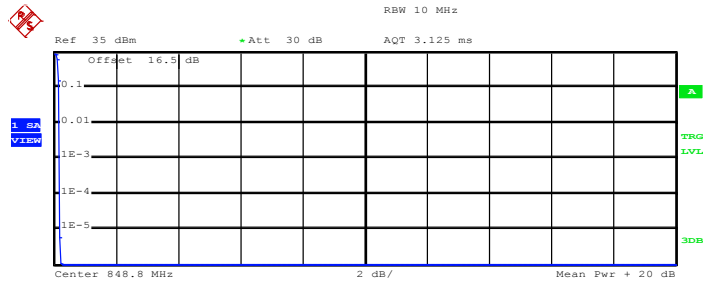

Complementary Cumulative Distribution Function (100000 samples)

Trace 1

Mean	31.90 dBm
Peak	32.15 dBm
Crest	0.24 dB
10 %	0.16 dB
1 %	0.20 dB
.1 %	0.20 dB
.01 %	0.20 dB

Date: 8.MAY.2015 09:38:59



Band :	GSM 850	Test Mode :	EDGE class 8 Link (8PSK)
---------------	---------	--------------------	--------------------------

Peak-to-Average Ratio on Channel 128 (824.2 MHz)

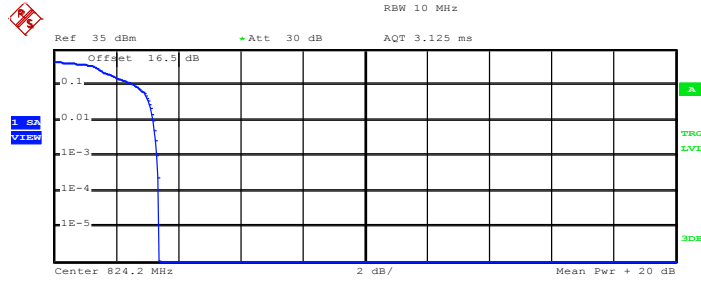

Complementary Cumulative Distribution Function (100000 samples)

Trace 1

Mean	23.84 dBm
Peak	27.21 dBm
Crest	3.36 dB
10 %	2.60 dB
1 %	3.20 dB
.1 %	3.32 dB
.01 %	3.40 dB

Date: 8.MAY.2015 09:50:00

Peak-to-Average Ratio on Channel 189 (836.4 MHz)

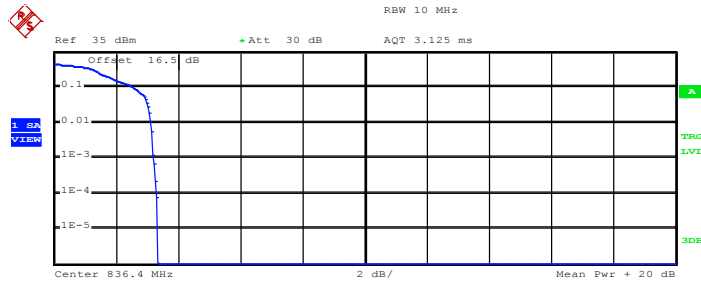

Complementary Cumulative Distribution Function (100000 samples)

Trace 1

Mean	25.07 dBm
Peak	28.41 dBm
Crest	3.33 dB
10 %	2.56 dB
1 %	3.12 dB
.1 %	3.20 dB
.01 %	3.32 dB

Date: 8.MAY.2015 09:50:12



Peak-to-Average Ratio on Channel 251 (848.8 MHz)

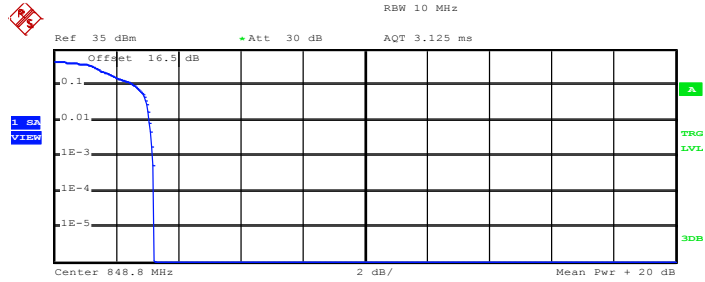

Complementary Cumulative Distribution Function (100000 samples)

Trace 1

Mean	25.90 dBm
Peak	29.11 dBm
Crest	3.21 dB
10 %	2.60 dB
1 %	3.08 dB
.1 %	3.20 dB
.01 %	3.24 dB

Date: 8.MAY.2015 09:50:24



Band :	GSM 1900	Test Mode :	GPRS class 8 Link (GMSK)
---------------	----------	--------------------	--------------------------

Peak-to-Average Ratio on Channel 512 (1850.2 MHz)

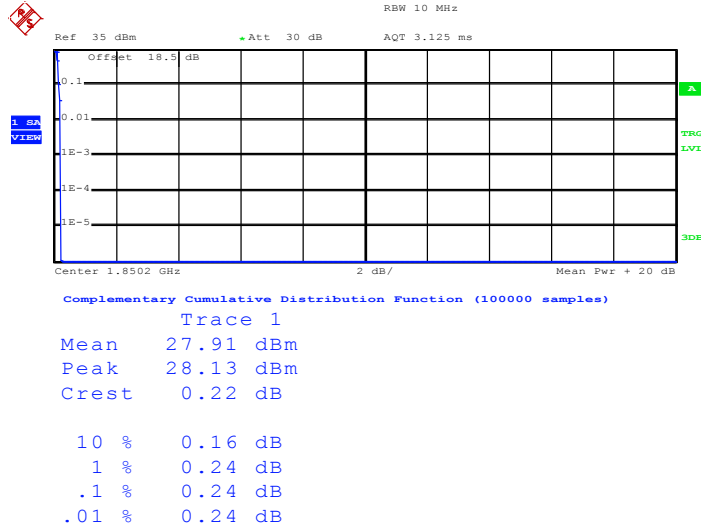

Date: 8.MAY.2015 10:03:05

Peak-to-Average Ratio on Channel 661 (1880.0 MHz)

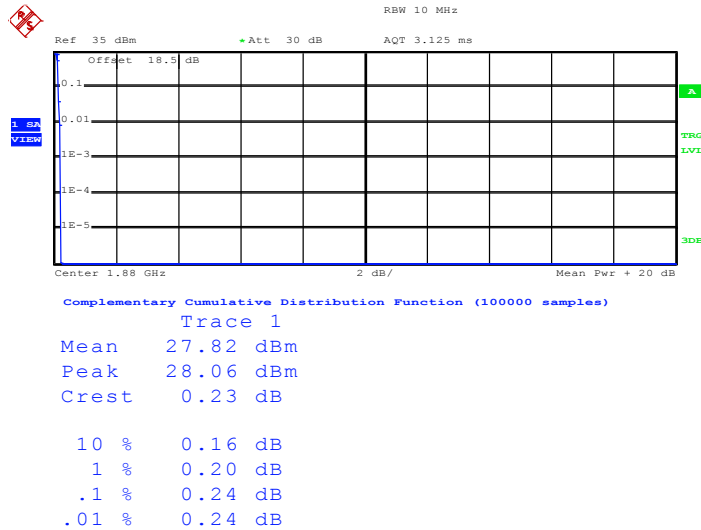

Date: 8.MAY.2015 10:03:17



Peak-to-Average Ratio on Channel 810 (1909.8 MHz)

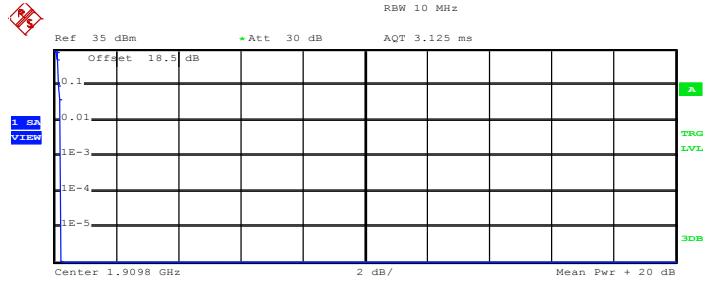

Complementary Cumulative Distribution Function (100000 samples)

Trace 1

Mean	28.04 dBm
Peak	28.27 dBm
Crest	0.23 dB
10 %	0.16 dB
1 %	0.24 dB
.1 %	0.24 dB
.01 %	0.24 dB

Date: 8.MAY.2015 10:03:31



Band :	GSM 1900	Test Mode :	EDGE class 8 Link (8PSK)
---------------	----------	--------------------	--------------------------

Peak-to-Average Ratio on Channel 512 (1850.2 MHz)

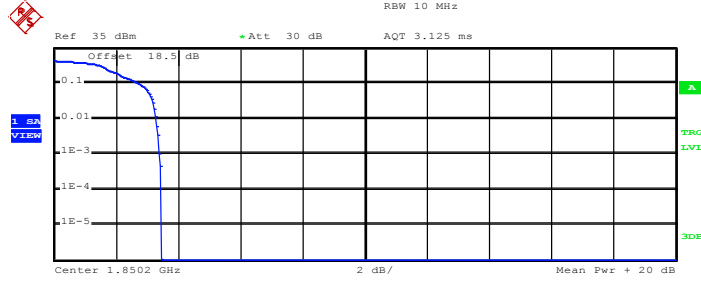

Complementary Cumulative Distribution Function (100000 samples)

Trace 1

Mean	24.45 dBm
Peak	27.91 dBm
Crest	3.46 dB
10 %	2.76 dB
1 %	3.28 dB
.1 %	3.40 dB
.01 %	3.48 dB

Date: 8.MAY.2015 10:20:50

Peak-to-Average Ratio on Channel 661 (1880.0 MHz)

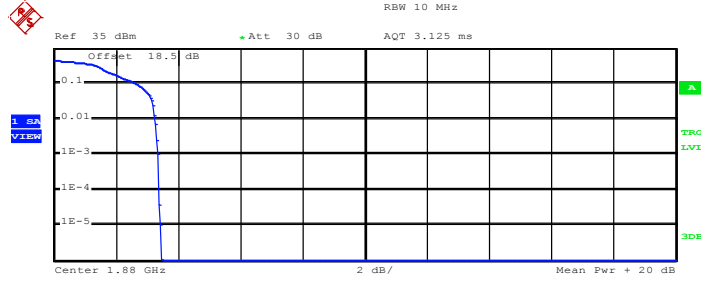

Complementary Cumulative Distribution Function (100000 samples)

Trace 1

Mean	23.83 dBm
Peak	27.28 dBm
Crest	3.45 dB
10 %	2.68 dB
1 %	3.28 dB
.1 %	3.36 dB
.01 %	3.40 dB

Date: 8.MAY.2015 10:21:05



Peak-to-Average Ratio on Channel 810 (1909.8 MHz)

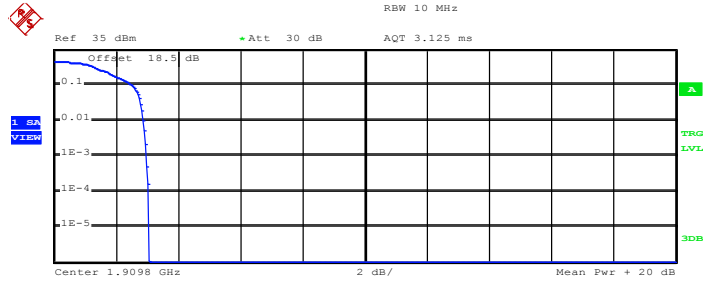

Complementary Cumulative Distribution Function (100000 samples)

Trace 1

Mean	24.78 dBm
Peak	27.84 dBm
Crest	3.07 dB
10 %	2.52 dB
1 %	2.88 dB
.1 %	3.00 dB
.01 %	3.04 dB

Date: 8.MAY.2015 10:21:17



Band :	WCDMA Band V	Test Mode :	RMC 12.2Kbps Link (QPSK)
---------------	--------------	--------------------	--------------------------

Peak-to-Average Ratio on Channel 4132 (826.4 MHz)

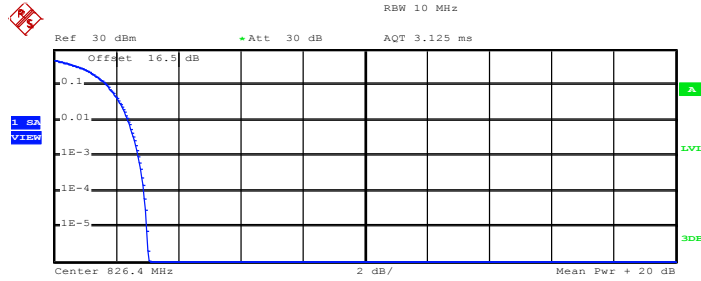

Complementary Cumulative Distribution Function (100000 samples)

Trace 1

Mean	19.09 dBm
Peak	22.14 dBm
Crest	3.05 dB
10 %	1.72 dB
1 %	2.40 dB
.1 %	2.72 dB
.01 %	2.92 dB

Date: 8.MAY.2015 10:40:14

Peak-to-Average Ratio on Channel 4182 (836.4 MHz)

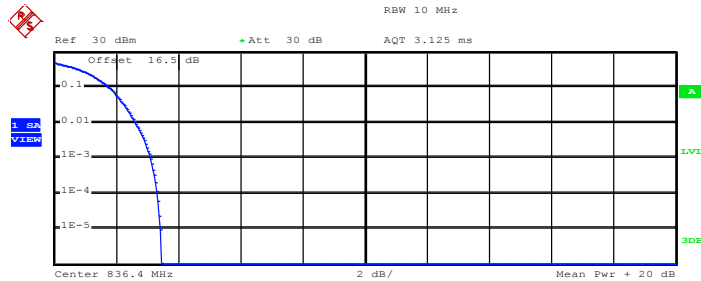

Complementary Cumulative Distribution Function (100000 samples)

Trace 1

Mean	19.02 dBm
Peak	22.49 dBm
Crest	3.47 dB
10 %	1.80 dB
1 %	2.64 dB
.1 %	3.12 dB
.01 %	3.32 dB

Date: 8.MAY.2015 10:40:22



Peak-to-Average Ratio on Channel 4233 (846.6 MHz)

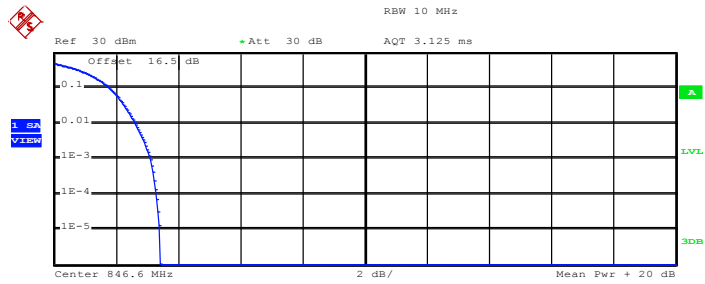

Complementary Cumulative Distribution Function (100000 samples)

Trace 1

Mean	18.92 dBm
Peak	22.35 dBm
Crest	3.43 dB
10 %	1.80 dB
1 %	2.64 dB
.1 %	3.12 dB
.01 %	3.32 dB

Date: 8.MAY.2015 10:40:30



Band :	WCDMA Band II	Test Mode :	RMC 12.2Kbps Link (QPSK)
---------------	---------------	--------------------	--------------------------

Peak-to-Average Ratio on Channel 9262 (1852.4 MHz)

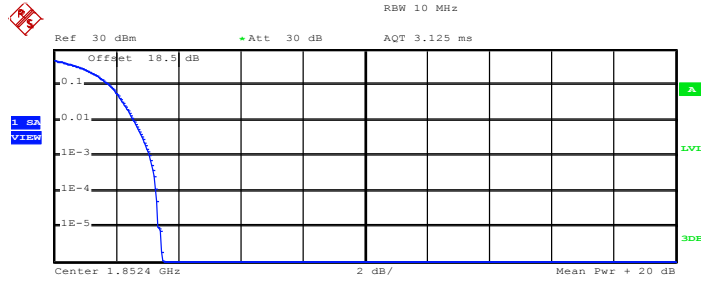

Complementary Cumulative Distribution Function (100000 samples)

Trace 1

Mean	20.41 dBm
Peak	23.90 dBm
Crest	3.49 dB
10 %	1.80 dB
1 %	2.60 dB
.1 %	3.08 dB
.01 %	3.28 dB

Date: 8.MAY.2015 10:31:08

Peak-to-Average Ratio on Channel 9400 (1880.0 MHz)

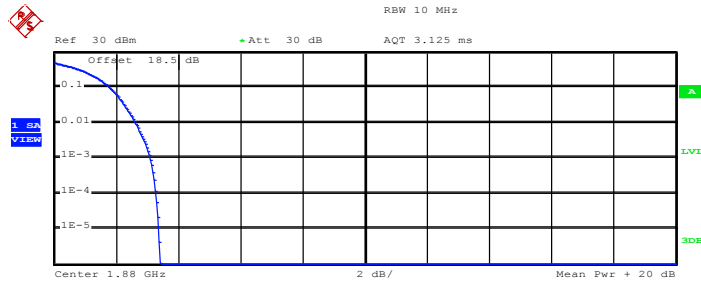

Complementary Cumulative Distribution Function (100000 samples)

Trace 1

Mean	20.22 dBm
Peak	23.62 dBm
Crest	3.40 dB
10 %	1.80 dB
1 %	2.64 dB
.1 %	3.12 dB
.01 %	3.28 dB

Date: 8.MAY.2015 10:31:17



Peak-to-Average Ratio on Channel 9538 (1907.6 MHz)

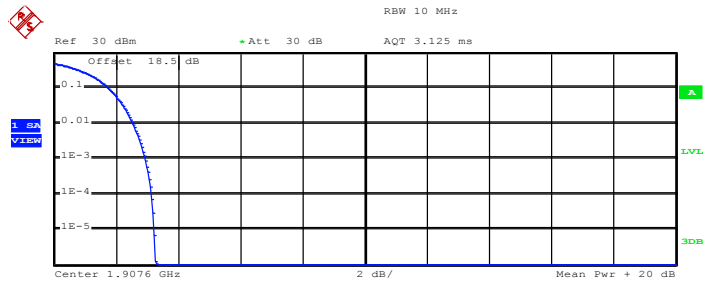

Complementary Cumulative Distribution Function (100000 samples)

Trace 1

Mean	19.91 dBm
Peak	23.20 dBm
Crest	3.28 dB
10 %	1.76 dB
1 %	2.56 dB
.1 %	2.96 dB
.01 %	3.16 dB

Date: 8.MAY.2015 10:31:26



3.3 Effective Radiated Power and Effective Isotropic Radiated Power Measurement

3.3.1 Description of the ERP/EIRP Measurement

The substitution method, in ANSI / TIA / EIA-603-C-2004, was used for ERP/EIRP measurement, and the spectrum analyzer configuration follows KDB 971168 D01 Power Meas. License Digital Systems v02r02. The ERP of mobile transmitters must not exceed 7 Watts and the EIRP of mobile transmitters are limited to 2 Watts.

3.3.2 Measuring Instruments

The measuring equipment is listed in the section 4 of this test report.

3.3.3 Test Procedures

1. The testing follows FCC KDB 971168 v02r02 Section 5.2.1. (for CDMA/WCDMA), Section 5.2.2.2 (for GSM/GPRS/EDGE) and ANSI / TIA-603-C-2004 Section 2.2.17.
2. The EUT was placed on a non-conductive rotating platform 0.8 meters high in a semi-anechoic chamber. The radiated emission at the fundamental frequency was measured at 3 m with a test antenna and a spectrum analyzer with RMS detector per section 5. of KDB 971168 D01.
3. During the measurement, the system simulator parameters were set to force the EUT transmitting at maximum output power. The maximum emission was recorded from analyzer power level (LVL) from the 360 degrees rotation of the turntable and the test antenna raised and lowered over a range from 1 to 4 meters in both horizontally and vertically polarized orientations.
4. Effective Isotropic Radiated Power (EIRP) was measured by substitution method according to TIA/EIA-603-C. The EUT was replaced by the substitution antenna at same location, and then a known power from S.G. was applied into the dipole antenna through a Tx cable, and then recorded the maximum Analyzer reading through raised and lowered the test antenna. The correction factor (in dB) = S.G. - Tx Cable loss + Substitution antenna gain - Analyzer reading. Then the EUT's EIRP was calculated with the correction factor, $EIRP = LVL + \text{Correction factor}$ and $ERP = EIRP - 2.15$. Take the record of the output power at substitution antenna.

	GSM/GPRS/EDGE	WCDMA/HSPA
SPAN	500kHz	10MHz
RBW	10kHz	100kHz
VBW	30kHz	300kHz
Detector	RMS	RMS
Trace	Average	Average
Average Type	Power	Power
Sweep Count	100	100

3.3.4 Test Setup

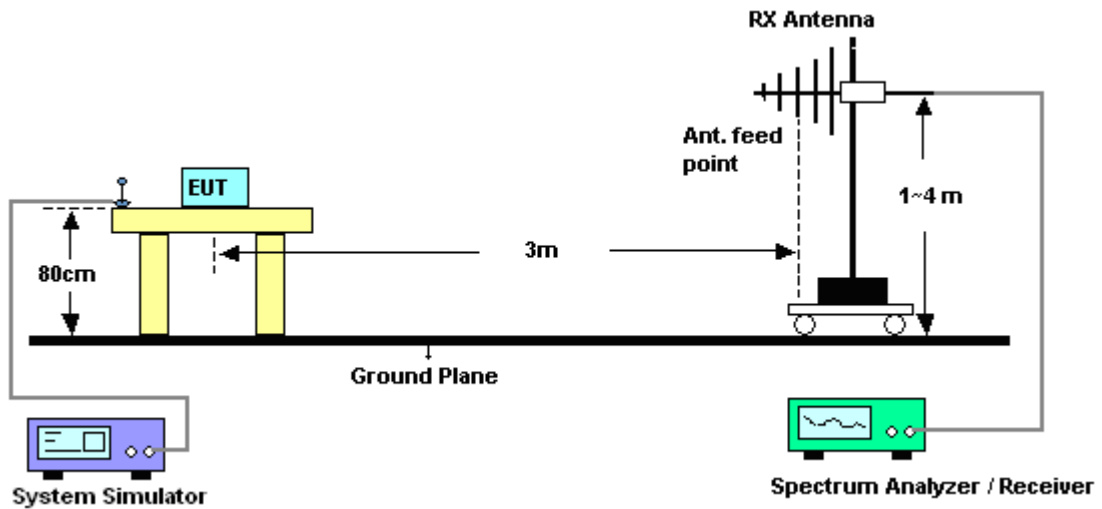



3.3.5 Test Result of ERP

GSM850 (GPRS class 8) Radiated Power ERP					
Channel	Frequency (MHz)	Horizontal		Vertical	
		ERP(dBm)	ERP(W)	ERP(dBm)	ERP(W)
Lowest	824.2	28.46	0.7015	19.98	0.0995
Middle	836.4	29.17	0.8260	21.45	0.1396
Highest	848.8	29.02	0.7980	21.81	0.1517
Limit	ERP < 7W	Result		PASS	

GSM850 (EDGE class 8) Radiated Power ERP					
Channel	Frequency (MHz)	Horizontal		Vertical	
		ERP(dBm)	ERP(W)	ERP(dBm)	ERP(W)
Lowest	824.2	21.61	0.1449	13.22	0.0210
Middle	836.4	23.77	0.2382	15.69	0.0371
Highest	848.8	24.20	0.2630	16.67	0.0465
Limit	ERP < 7W	Result		PASS	

WCDMA Band V (RMC 12.2Kbps) Radiated Power ERP					
Channel	Frequency (MHz)	Horizontal		Vertical	
		ERP(dBm)	ERP(W)	ERP(dBm)	ERP(W)
Lowest	826.4	17.53	0.0566	9.12	0.0082
Middle	836.4	17.23	0.0528	9.54	0.0090
Highest	846.6	17.21	0.0526	9.97	0.0099
Limit	ERP < 7W	Result		PASS	



3.3.6 Test Result of EIRP

GSM1900 (GPRS class 8) Radiated Power EIRP					
Channel	Frequency (MHz)	Horizontal		Vertical	
		ERP(dBm)	ERP(W)	ERP(dBm)	ERP(W)
Lowest	1850.2	26.30	0.4266	25.25	0.3350
Middle	1880.0	26.62	0.4592	25.56	0.3597
Highest	1909.8	27.03	0.5047	25.96	0.3945
Limit	EIRP < 2W	Result		PASS	

GSM1900 (EDGE class 8) Radiated Power EIRP					
Channel	Frequency (MHz)	Horizontal		Vertical	
		ERP(dBm)	ERP(W)	ERP(dBm)	ERP(W)
Lowest	1850.2	23.00	0.1995	21.86	0.1535
Middle	1880.0	22.69	0.1858	21.45	0.1396
Highest	1909.8	23.15	0.2065	21.95	0.1567
Limit	EIRP < 2W	Result		PASS	

WCDMA Band II (RMC 12.2Kbps) Radiated Power EIRP					
Channel	Frequency (MHz)	Horizontal		Vertical	
		ERP(dBm)	ERP(W)	ERP(dBm)	ERP(W)
Lowest	1852.4	19.33	0.0857	18.31	0.0678
Middle	1880.0	20.10	0.1023	19.16	0.0824
Highest	1907.6	20.65	0.1161	19.55	0.0902
Limit	EIRP < 2W	Result		PASS	

3.4 99% Occupied Bandwidth and 26dB Bandwidth Measurement

3.4.1 Description of 99% Occupied Bandwidth and 26dB Bandwidth Measurement

The 99% occupied bandwidth is the width of a frequency band such that, below the lower and above the upper frequency limits, the mean powers emitted are each equal to a specified percentage 0.5% of the total mean transmitted power.

The emission bandwidth is defined as the width of the signal between two points, located at the 2 sides of the carrier frequency, outside of which all emissions are attenuated at least 26 dB below the transmitter power.

3.4.2 Measuring Instruments

The measuring equipment is listed in the section 4 of this test report.

3.4.3 Test Procedures

1. The testing follows FCC KDB 971168 v02r02 Section 4.2.
2. The EUT was connected to the spectrum analyzer and system simulator via a power divider.
3. The RF output of the EUT was connected to the spectrum analyzer by RF cable and attenuator. The path loss was compensated to the results for each measurement.
4. The 99% occupied bandwidth were measured, set RBW= 1% of span, VBW= 3*RBW, sample detector, trace maximum hold.
5. The 26dB bandwidth were measured, set RBW= 1% of EBW, VBW= 3*RBW, peak detector, trace maximum hold.

3.4.4 Test Setup

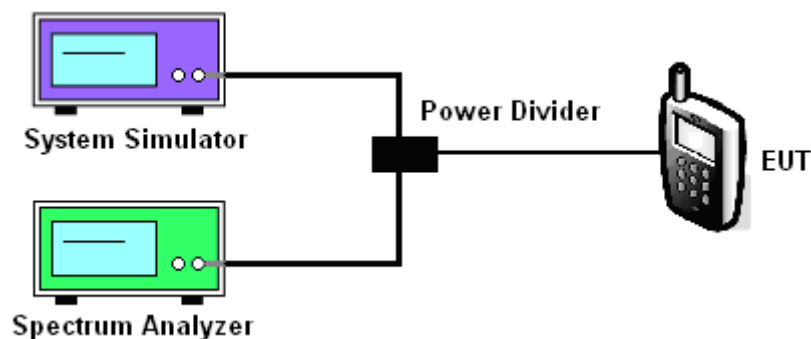



3.4.5 Test Result of Occupied Bandwidth and 26dB Bandwidth

Cellular Band						
Modes	GSM850 (GPRS class 8)			GSM850 (EDGE class 8)		
Channel	128 (Low)	189 (Mid)	251 (High)	128 (Low)	189 (Mid)	251 (High)
Frequency (MHz)	824.2	836.4	848.8	824.2	836.4	848.8
99% OBW (kHz)	246.00	248.00	246.00	250.00	251.00	248.00
26dB BW (kHz)	315.00	308.00	310.00	307.00	313.00	295.00

PCS Band						
Modes	GSM1900 (GPRS class 8)			GSM1900 (EDGE class 8)		
Channel	512 (Low)	661 (Mid)	810 (High)	512 (Low)	661 (Mid)	810 (High)
Frequency (MHz)	1850.2	1880	1909.8	1850.2	1880	1909.8
99% OBW (kHz)	248.00	245.00	245.00	252.00	252.00	251.00
26dB BW (kHz)	312.00	308.00	314.00	306.00	302.00	308.00

Cellular Band			
Modes	WCDMA Band V (RMC 12.2Kbps)		
Channel	4132 (Low)	4182 (Mid)	4233 (High)
Frequency (MHz)	826.4	836.4	846.6
99% OBW (MHz)	4.20	4.20	4.21
26dB BW (MHz)	4.86	4.83	4.83

PCS Band			
Modes	WCDMA Band II (RMC 12.2Kbps)		
Channel	9262 (Low)	9400 (Mid)	9538 (High)
Frequency (MHz)	1852.4	1880	1907.6
99% OBW (MHz)	4.22	4.20	4.20
26dB BW (MHz)	4.85	4.84	4.82



3.4.6 Test Result (Plots) of Occupied Bandwidth and 26dB Bandwidth

Band :	GSM 850	Test Mode :	GPRS class 8 Link (GMSK)
--------	---------	-------------	--------------------------

99% Occupied Bandwidth Plot on Channel 128 (824.2 MHz)

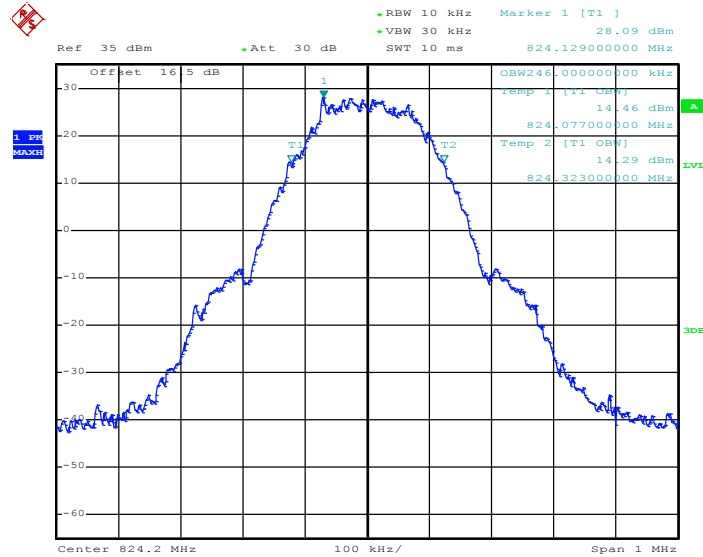

Date: 8.MAY.2015 09:32:55

26dB Bandwidth Plot on Channel 128 (824.2 MHz)

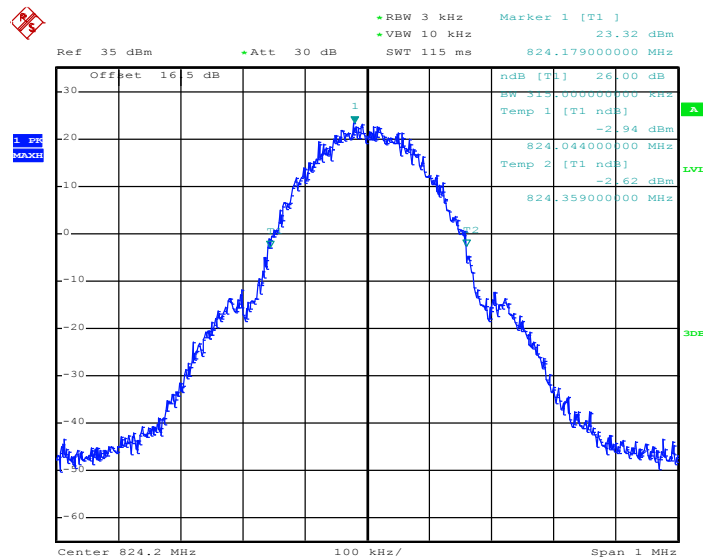

Date: 8.MAY.2015 09:31:26



99% Occupied Bandwidth Plot on Channel 189 (836.4 MHz)

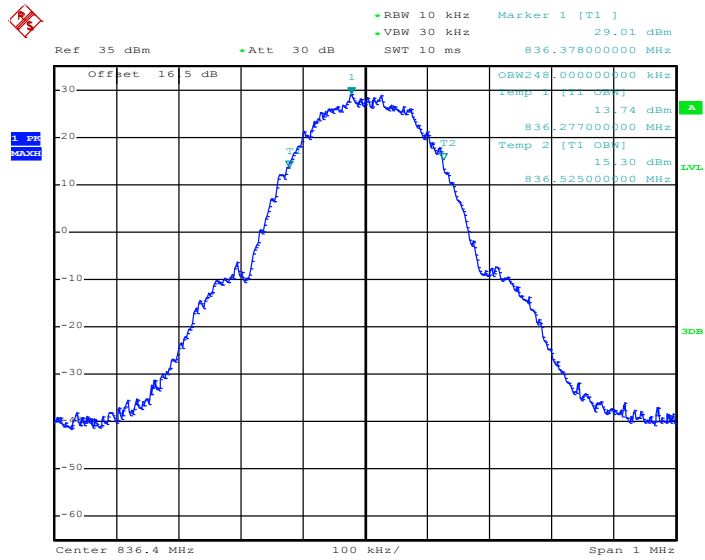

Date: 8.MAY.2015 09:33:24

26dB Bandwidth Plot on Channel 189 (836.4 MHz)

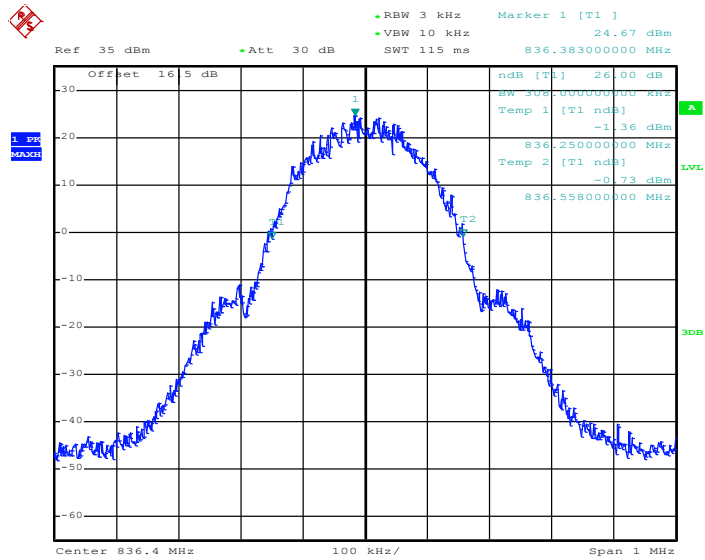

Date: 8.MAY.2015 09:31:55



99% Occupied Bandwidth Plot on Channel 251 (848.8 MHz)

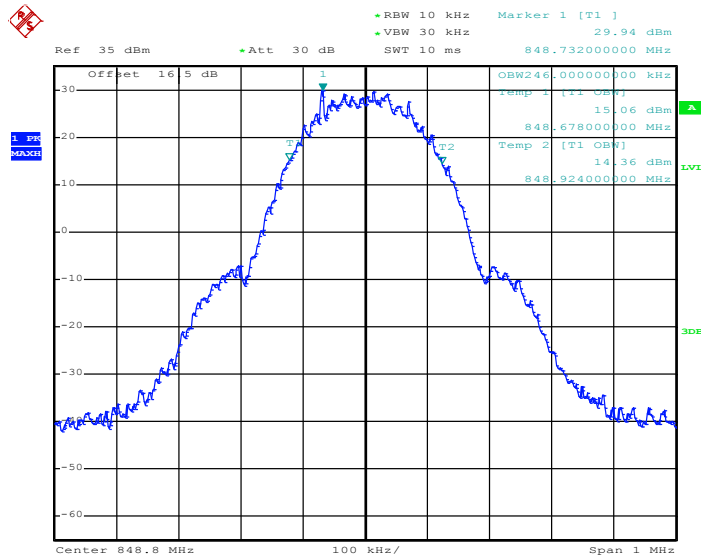

Date: 8.MAY.2015 09:33:52

26dB Bandwidth Plot on Channel 251 (848.8 MHz)

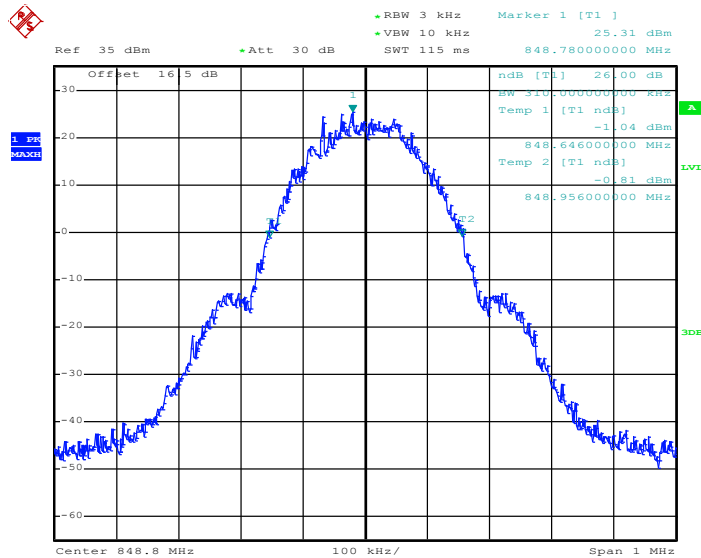

Date: 8.MAY.2015 09:32:23



Band :	GSM 850	Test Mode :	EDGE class 8 Link (8PSK)
---------------	---------	--------------------	--------------------------

99% Occupied Bandwidth Plot on Channel 128 (824.2 MHz)

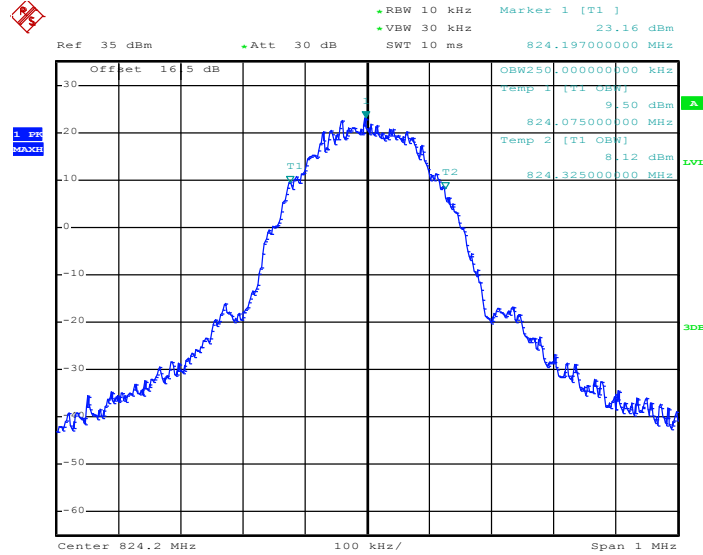

Date: 8.MAY.2015 09:44:11

26dB Bandwidth Plot on Channel 128 (824.2 MHz)

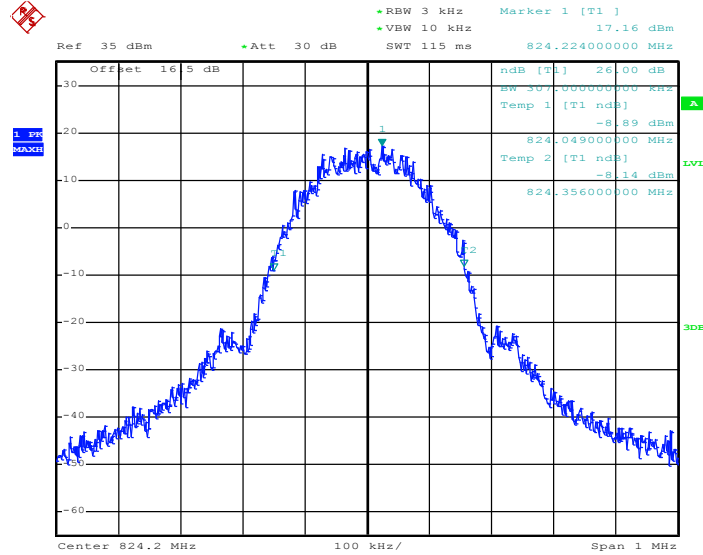

Date: 8.MAY.2015 09:42:36



99% Occupied Bandwidth Plot on Channel 189 (836.4 MHz)

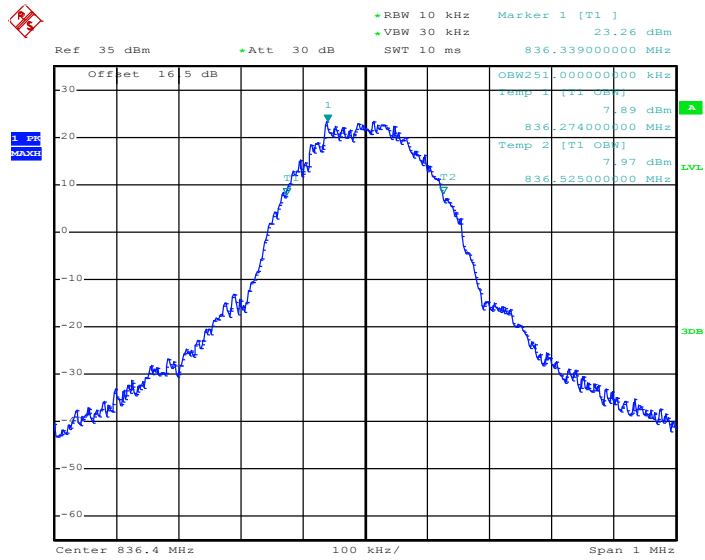

Date: 8.MAY.2015 09:44:41

26dB Bandwidth Plot on Channel 189 (836.4 MHz)

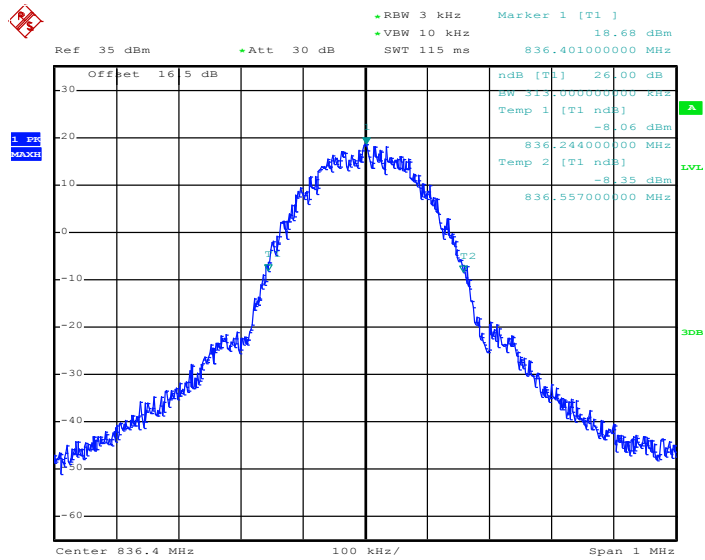

Date: 8.MAY.2015 09:43:08



99% Occupied Bandwidth Plot on Channel 251 (848.8 MHz)

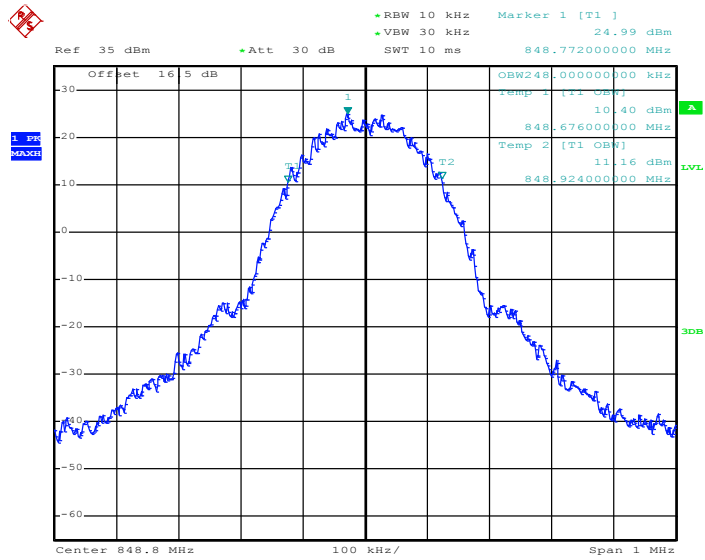

Date: 8.MAY.2015 09:45:10

26dB Bandwidth Plot on Channel 251 (848.8 MHz)

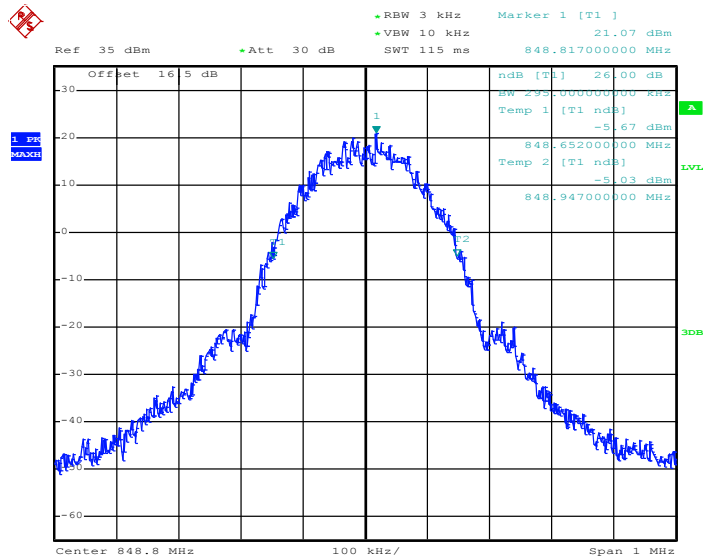

Date: 8.MAY.2015 09:43:36



Band :	GSM 1900	Test Mode :	GPRS class 8 Link (GMSK)
---------------	----------	--------------------	--------------------------

99% Occupied Bandwidth Plot on Channel 512 (1850.2 MHz)

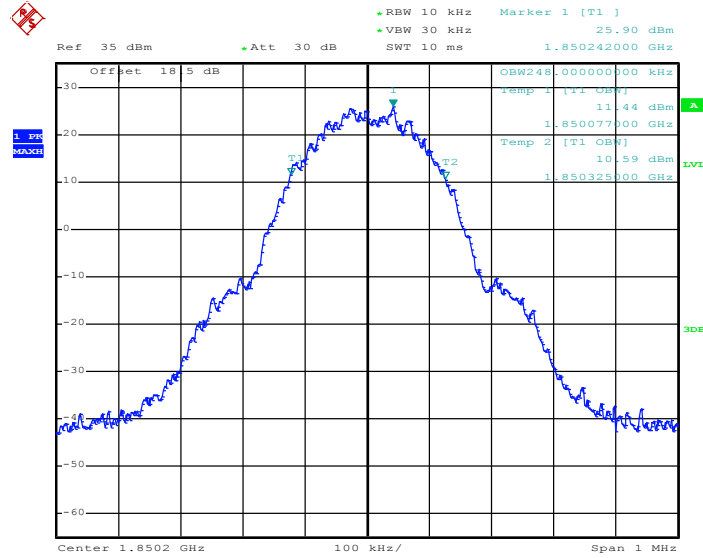

Date: 8.MAY.2015 09:57:11

26dB Bandwidth Plot on Channel 512 (1850.2 MHz)

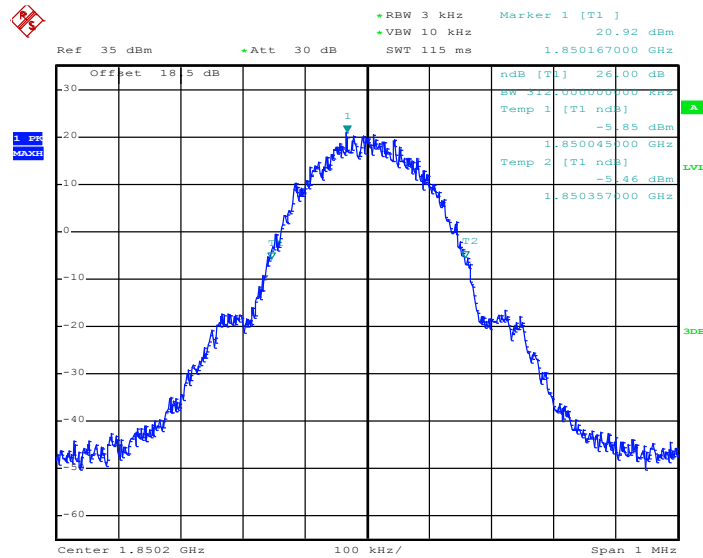

Date: 8.MAY.2015 09:55:32



99% Occupied Bandwidth Plot on Channel 661 (1880.0 MHz)

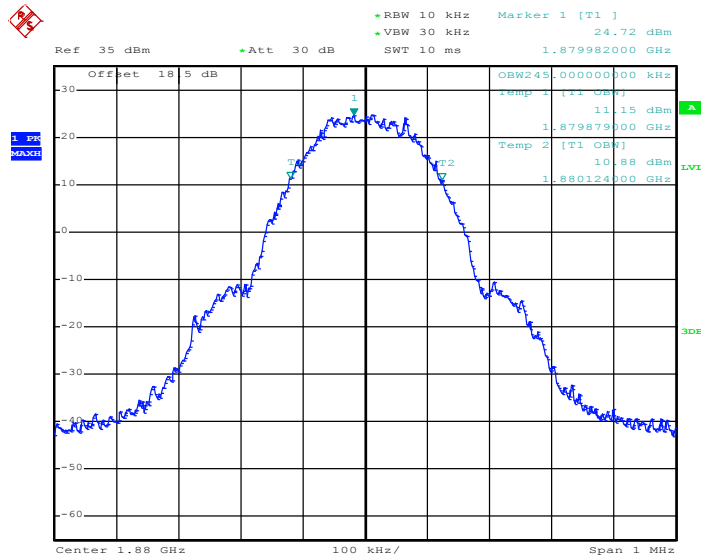

Date: 8.MAY.2015 09:57:39

26dB Bandwidth Plot on Channel 661 (1880.0 MHz)

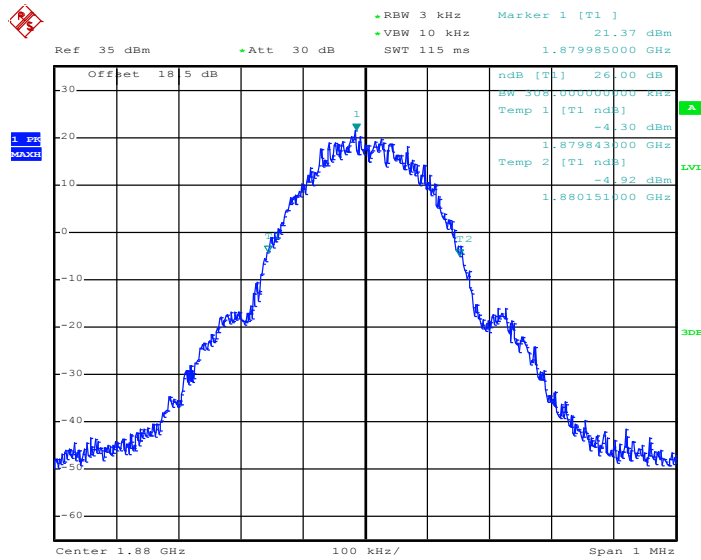

Date: 8.MAY.2015 09:56:00



99% Occupied Bandwidth Plot on Channel 810 (1909.8 MHz)

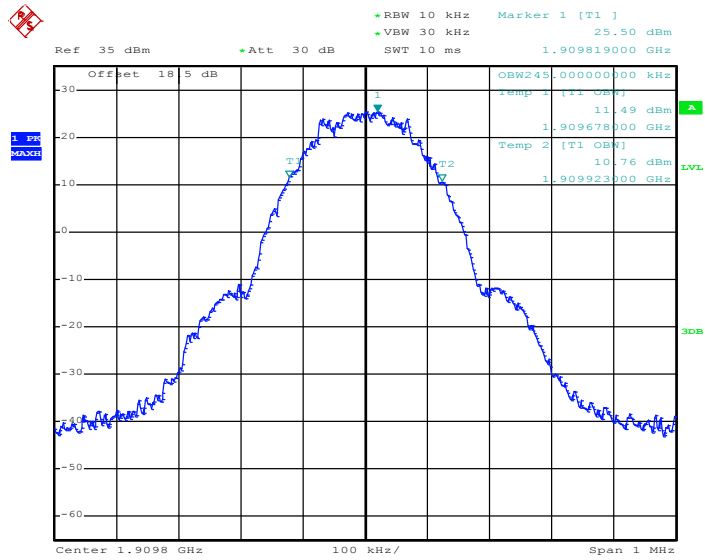

Date: 8.MAY.2015 09:58:08

26dB Bandwidth Plot on Channel 810 (1909.8 MHz)

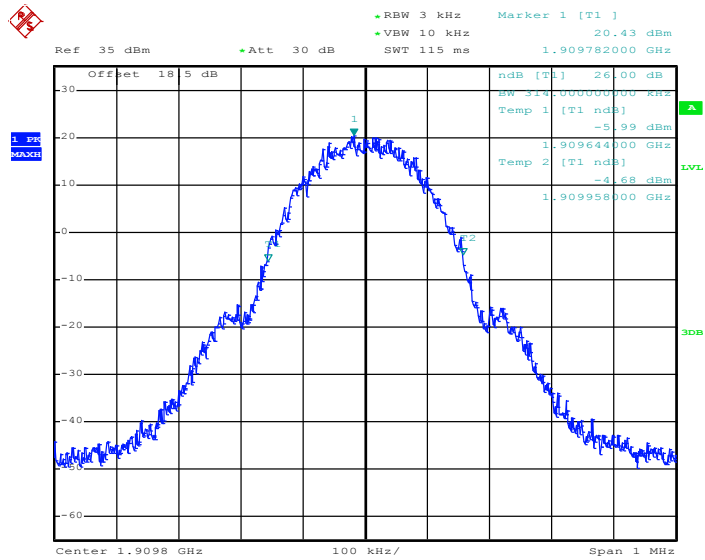

Date: 8.MAY.2015 09:56:29



Band :	GSM 1900	Test Mode :	EDGE class 8 Link (8PSK)
---------------	----------	--------------------	--------------------------

99% Occupied Bandwidth Plot on Channel 512 (1850.2 MHz)

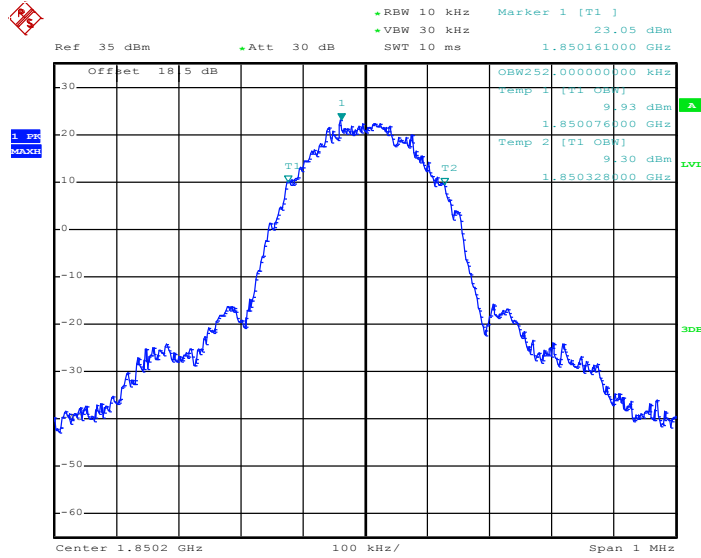

Date: 8.MAY.2015 10:08:40

26dB Bandwidth Plot on Channel 512 (1850.2 MHz)

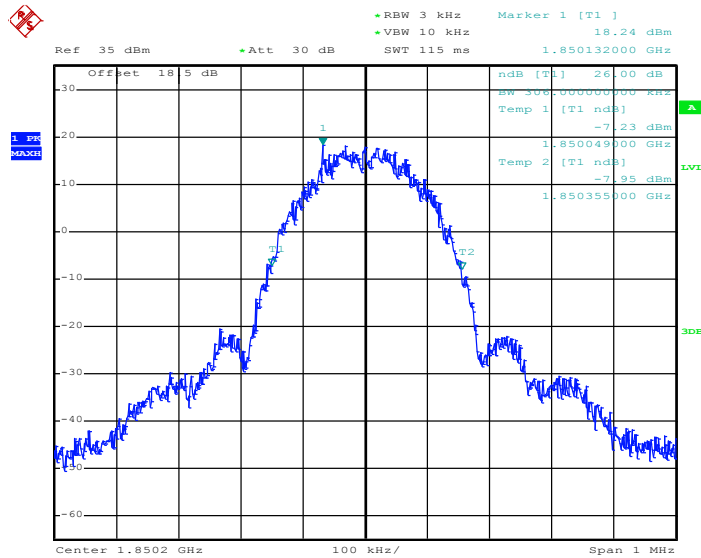

Date: 8.MAY.2015 10:07:04



99% Occupied Bandwidth Plot on Channel 661 (1880.0 MHz)

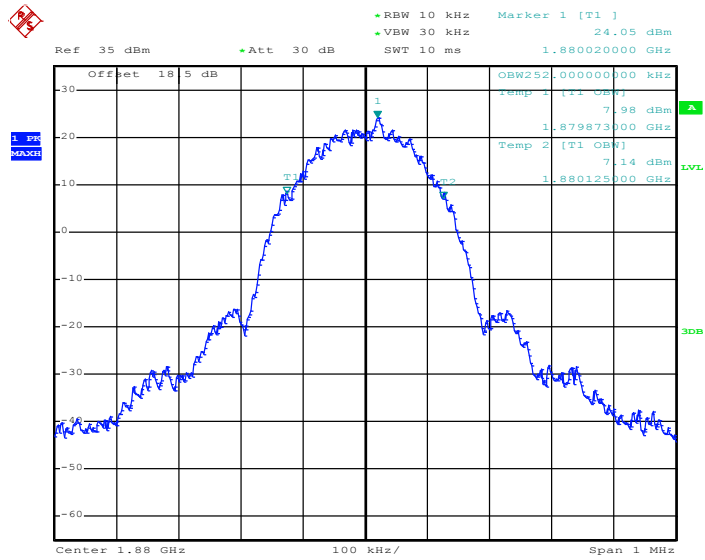

Date: 8.MAY.2015 10:09:12

26dB Bandwidth Plot on Channel 661 (1880.0 MHz)

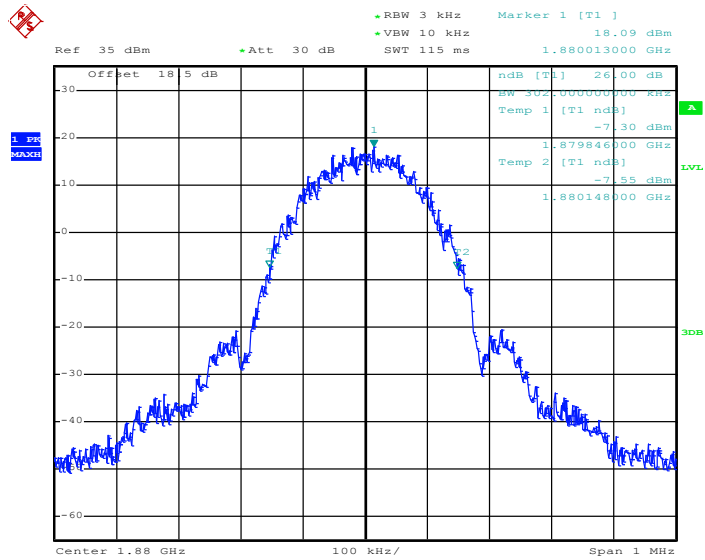

Date: 8.MAY.2015 10:07:37



99% Occupied Bandwidth Plot on Channel 810 (1909.8 MHz)

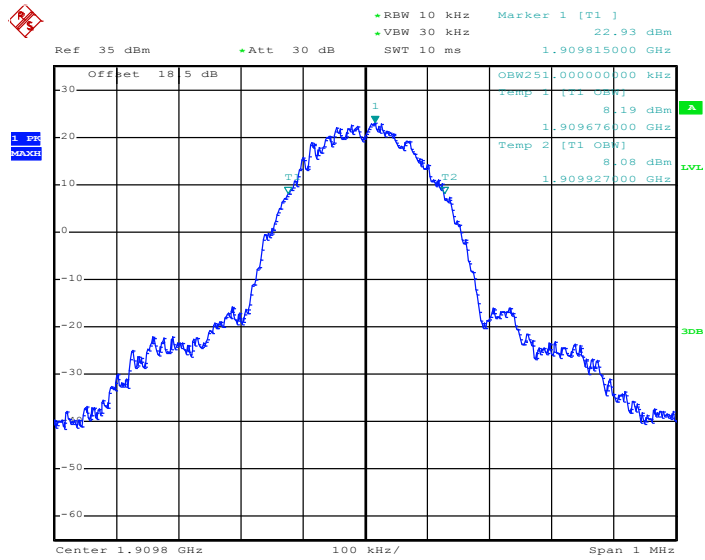

Date: 8.MAY.2015 10:09:41

26dB Bandwidth Plot on Channel 810 (1909.8 MHz)

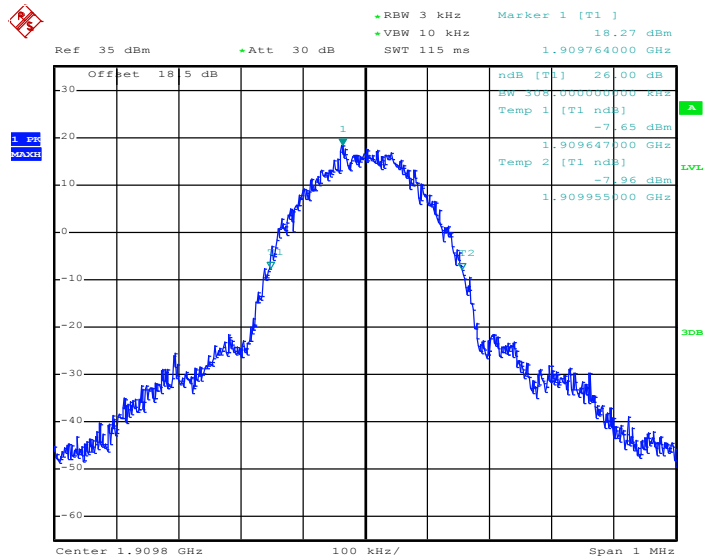

Date: 8.MAY.2015 10:08:07



Band :	WCDMA Band V	Test Mode :	RMC 12.2Kbps Link (QPSK)
---------------	--------------	--------------------	--------------------------

99% Occupied Bandwidth Plot on Channel 4132 (826.4 MHz)

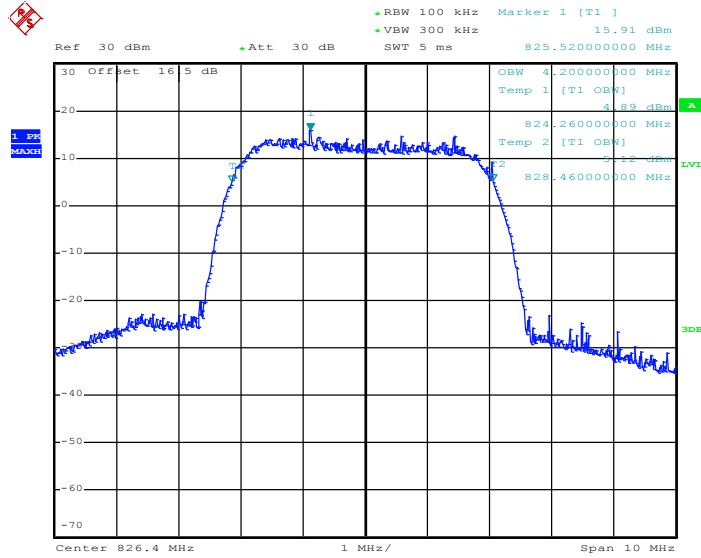

Date: 8.MAY.2015 10:34:26

26dB Bandwidth Plot on Channel 4132 (826.4 MHz)

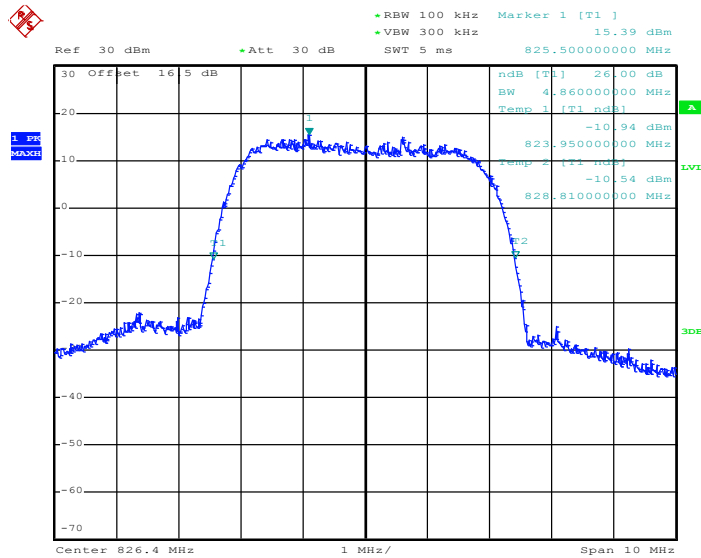

Date: 8.MAY.2015 10:32:54



99% Occupied Bandwidth Plot on Channel 4182 (836.4 MHz)

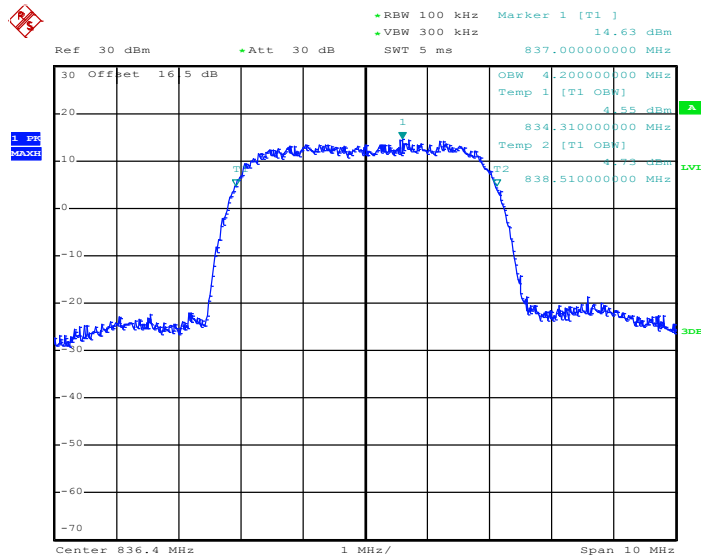

Date: 8.MAY.2015 10:34:54

26dB Bandwidth Plot on Channel 4182 (836.4 MHz)

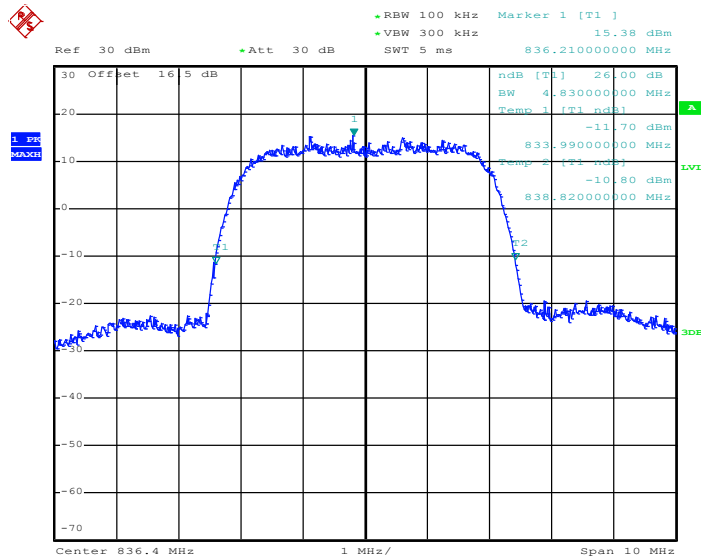

Date: 8.MAY.2015 10:33:22



99% Occupied Bandwidth Plot on Channel 4233 (846.6 MHz)

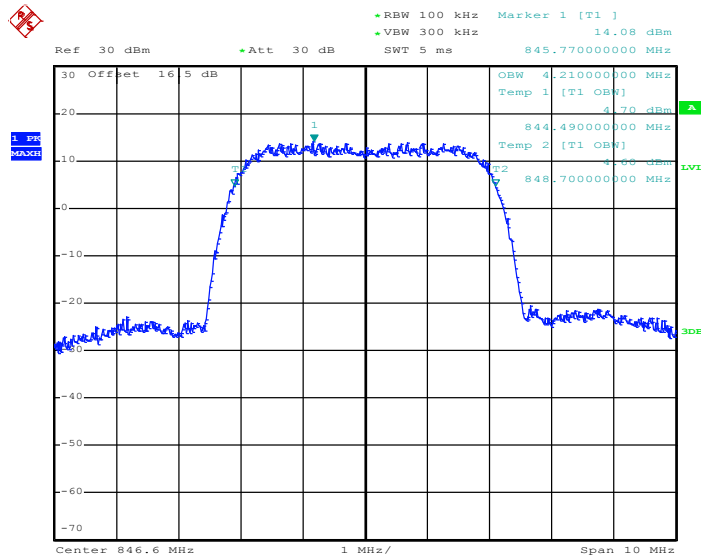

Date: 8.MAY.2015 10:35:22

26dB Bandwidth Plot on Channel 4233 (846.6 MHz)

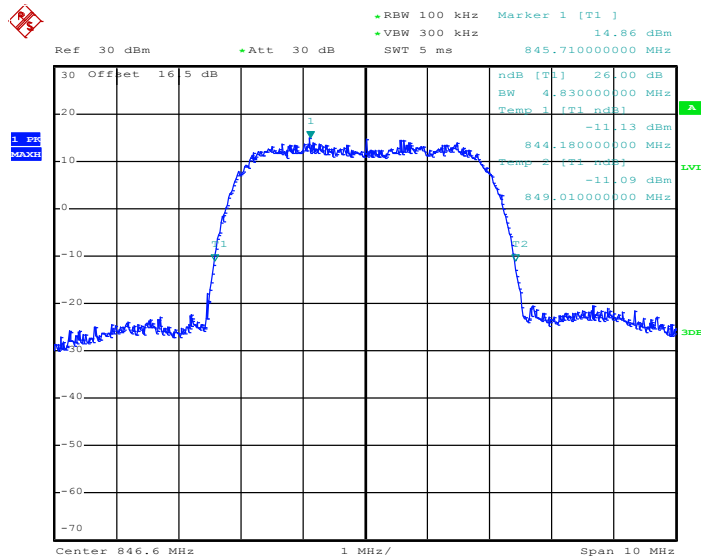

Date: 8.MAY.2015 10:33:50



Band :	WCDMA Band II	Test Mode :	RMC 12.2Kbps Link (QPSK)
---------------	---------------	--------------------	--------------------------

99% Occupied Bandwidth Plot on Channel 9262 (1852.4 MHz)

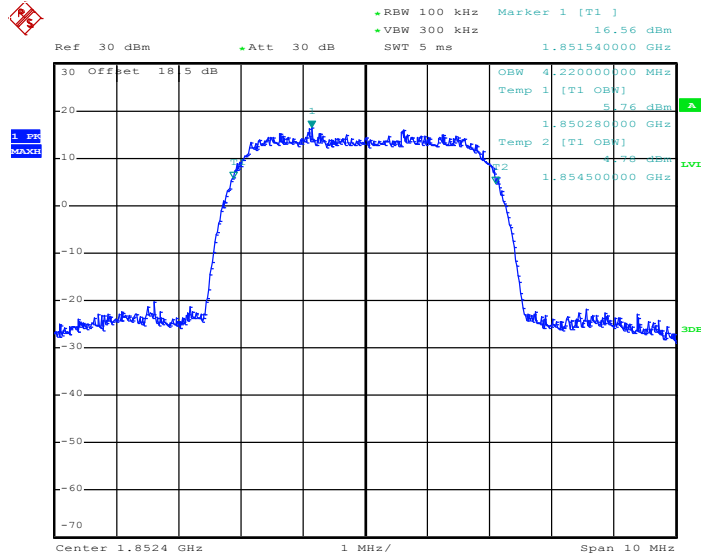

Date: 8.MAY.2015 10:25:32

26dB Bandwidth Plot on Channel 9262 (1852.4 MHz)

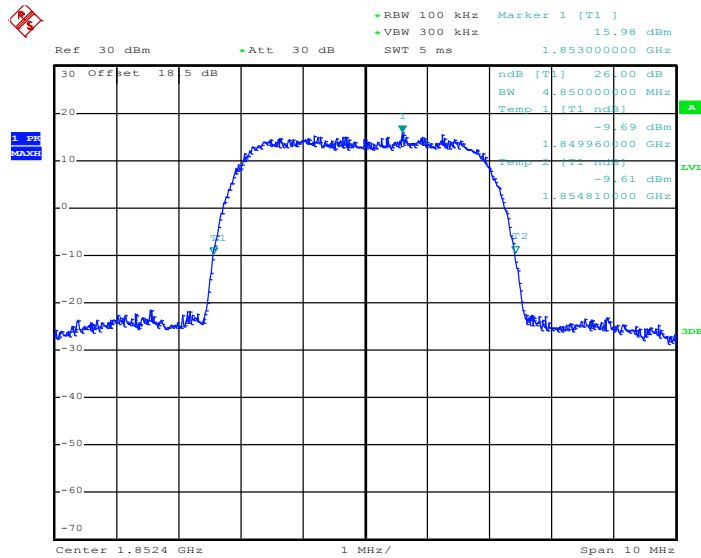

Date: 8.MAY.2015 10:24:04



99% Occupied Bandwidth Plot on Channel 9400 (1880.0 MHz)

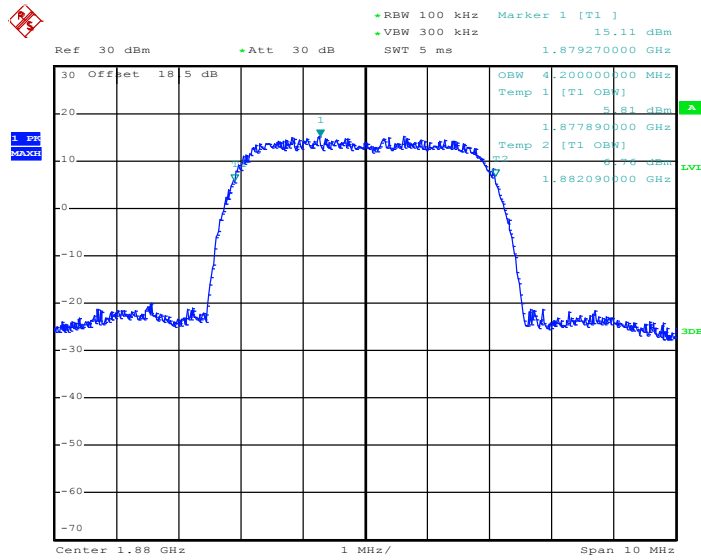

Date: 8.MAY.2015 10:26:00

26dB Bandwidth Plot on Channel 9400 (1880.0 MHz)

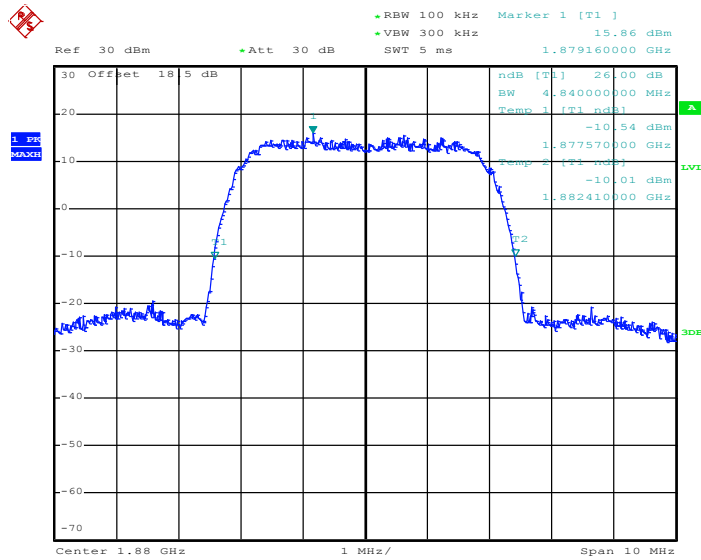

Date: 8.MAY.2015 10:24:32



99% Occupied Bandwidth Plot on Channel 9538 (1907.6 MHz)

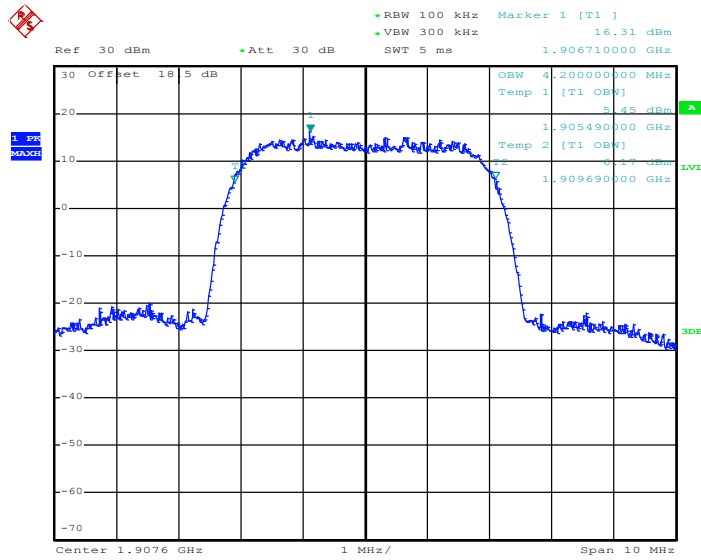

Date: 8.MAY.2015 10:26:29

26dB Bandwidth Plot on Channel 9538 (1907.6 MHz)

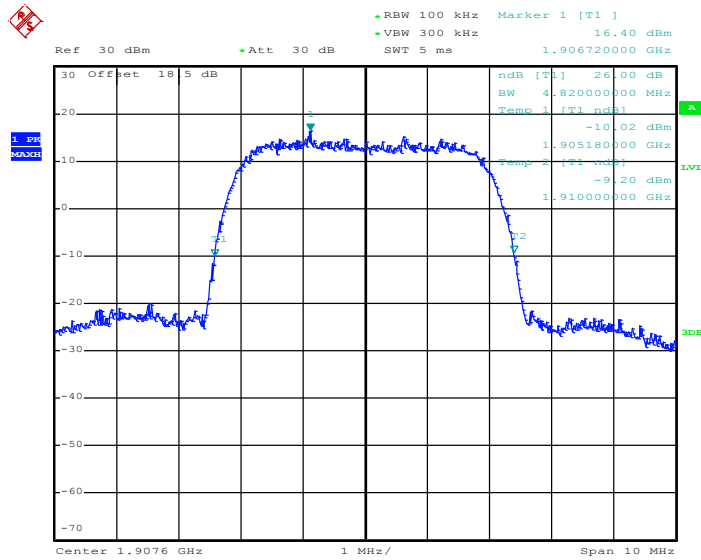

Date: 8.MAY.2015 10:25:01

3.5 Band Edge Measurement

3.5.1 Description of Band Edge Measurement

The power of any emission outside of the authorized operating frequency ranges must be lower than the transmitter power (P) by a factor of at least $43 + 10 \log (P)$ dB.

3.5.2 Measuring Instruments

The measuring equipment is listed in the section 4 of this test report.

3.5.3 Test Procedures

1. The testing follows FCC KDB 971168 v02r02 Section 6.0.
2. The EUT was connected to the spectrum analyzer and system simulator via a power divider.
3. The RF output of EUT was connected to the spectrum analyzer by an RF cable and attenuator. The path loss was compensated to the results for each measurement.
4. The band edges of low and high channels for the highest RF powers were measured.
5. The RF fundamental frequency should be excluded against the limit line in the operating frequency band.
6. The limit line is derived from $43 + 10\log(P)$ dB below the transmitter power P(Watts)
 $= P(W) - [43 + 10\log(P)] \text{ (dB)}$
 $= [30 + 10\log(P)] \text{ (dBm)} - [43 + 10\log(P)] \text{ (dB)}$
 $= -13\text{dBm}.$

3.5.4 Test Setup

<Conducted Band Edge >

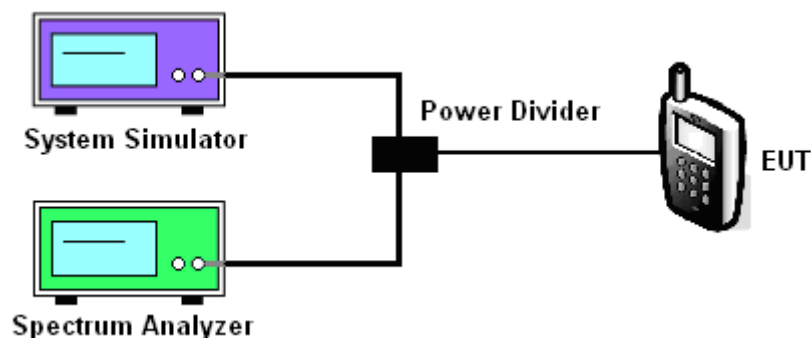



3.5.5 Test Result (Plots) of Conducted Band Edge

Band :	GSM850	Test Mode :	GPRS class 8 Link (GMSK)
--------	--------	-------------	--------------------------

Lower Band Edge Plot on Channel 128 (824.2 MHz)

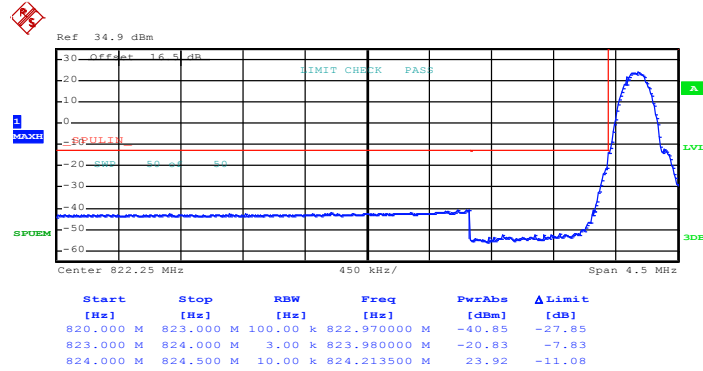

Date: 8.MAY.2015 09:35:37

Higher Band Edge Plot on Channel 251 (848.8 MHz)

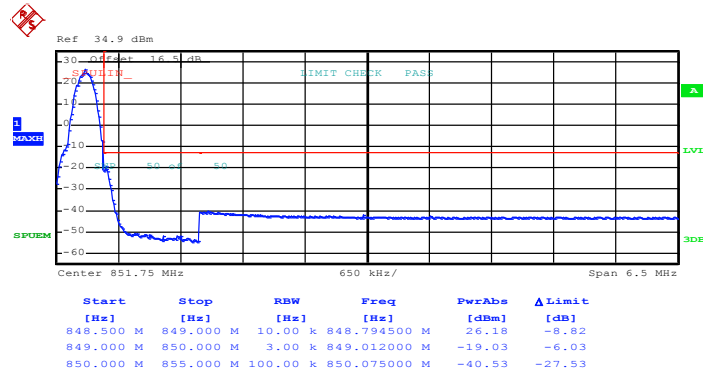

Date: 8.MAY.2015 09:37:01



Band :	GSM850	Test Mode :	EDGE class 8 Link (8PSK)
--------	--------	-------------	--------------------------

Lower Band Edge Plot on Channel 128 (824.2 MHz)

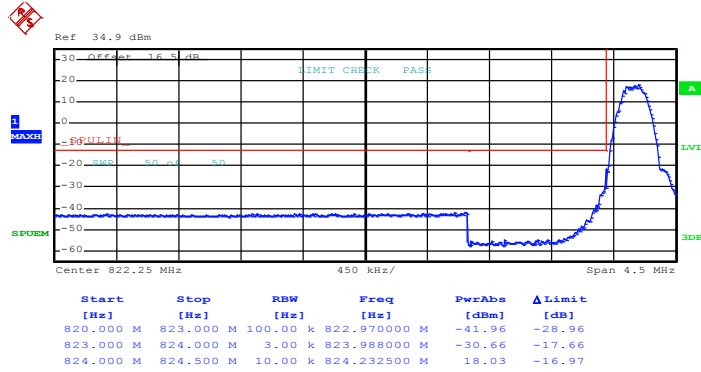

Date: 8.MAY.2015 09:46:50

Higher Band Edge Plot on Channel 251 (848.8 MHz)

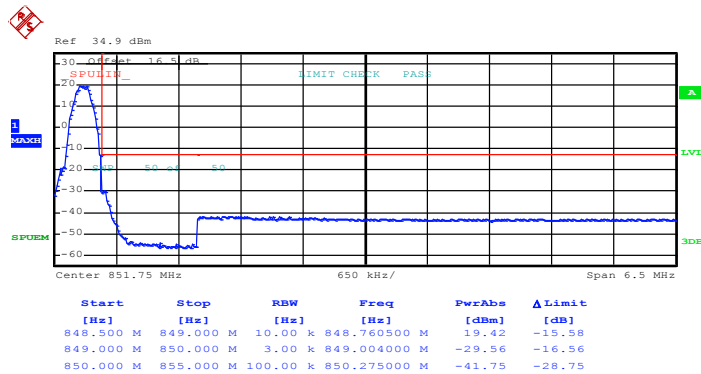

Date: 8.MAY.2015 09:48:15



Band :	GSM1900	Test Mode :	GPRS class 8 Link (GMSK)
---------------	---------	--------------------	--------------------------

Lower Band Edge Plot on Channel 512 (1850.2 MHz)

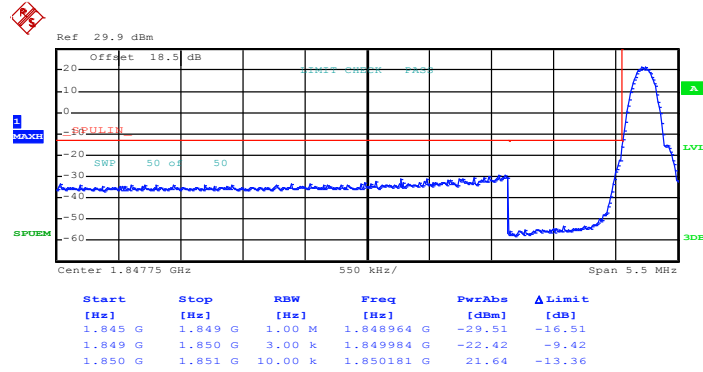

Date: 8.MAY.2015 09:59:33

Higher Band Edge Plot on Channel 810 (1909.8 MHz)

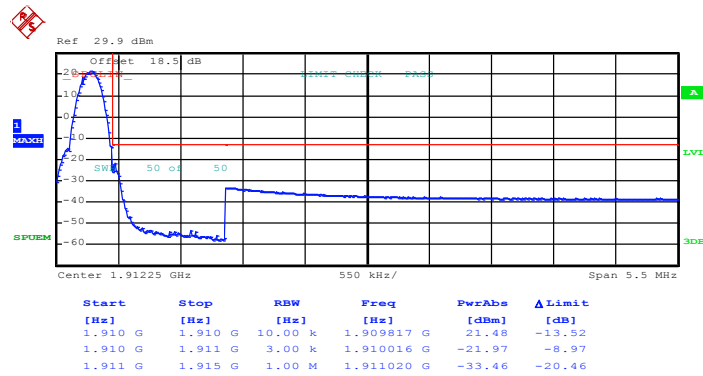

Date: 8.MAY.2015 10:00:55



Band :	GSM1900	Test Mode :	EDGE class 8 Link (8PSK)
--------	---------	-------------	--------------------------

Lower Band Edge Plot on Channel 512 (1850.2 MHz)

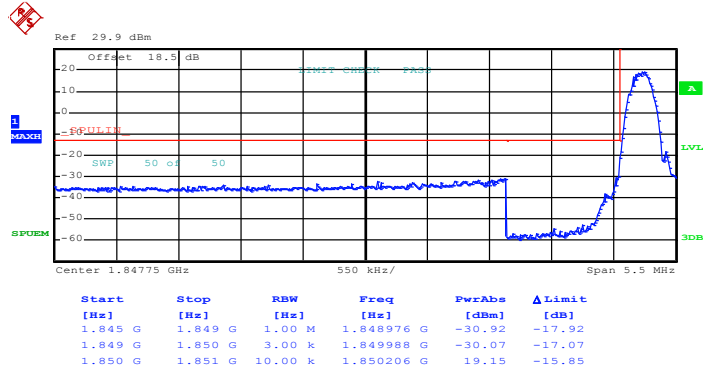

Date: 8.MAY.2015 10:17:01

Higher Band Edge Plot on Channel 810 (1909.8 MHz)

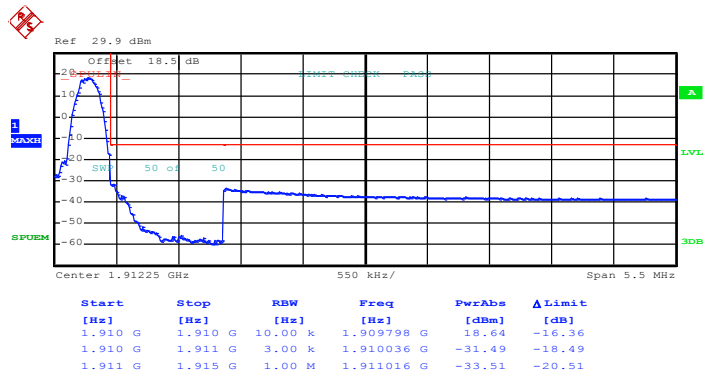

Date: 8.MAY.2015 10:19:11



Band :	WCDMA Band V	Test Mode :	RMC 12.2Kbps Link (QPSK)
--------	--------------	-------------	--------------------------

Lower Band Edge Plot on Channel 4132 (826.4 MHz)

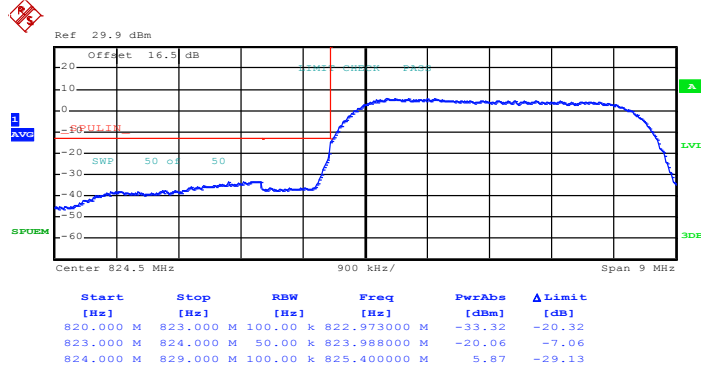

Date: 8.MAY.2015 10:36:51

Higher Band Edge Plot on Channel 4233 (846.6 MHz)

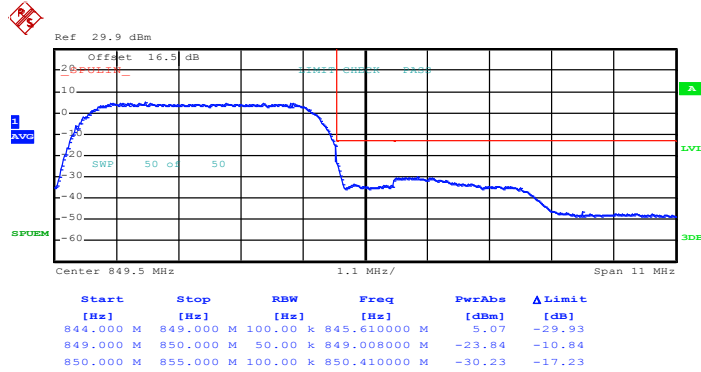

Date: 8.MAY.2015 10:38:13



Band :	WCDMA Band II	Test Mode :	RMC 12.2Kbps Link (QPSK)
--------	---------------	-------------	--------------------------

Lower Band Edge Plot on Channel 9262 (1852.4 MHz)

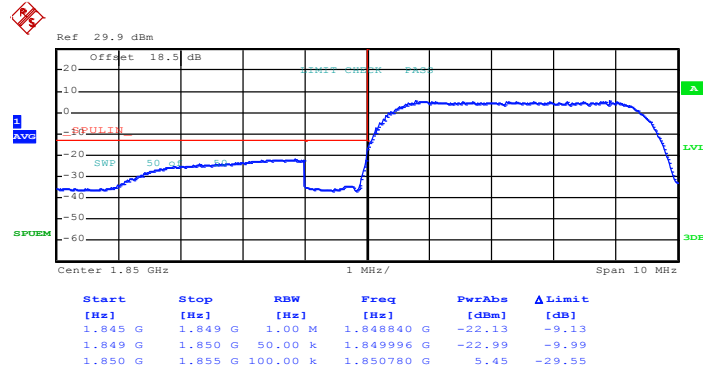

Date: 8.MAY.2015 10:28:03

Higher Band Edge Plot on Channel 9538 (1907.6 MHz)

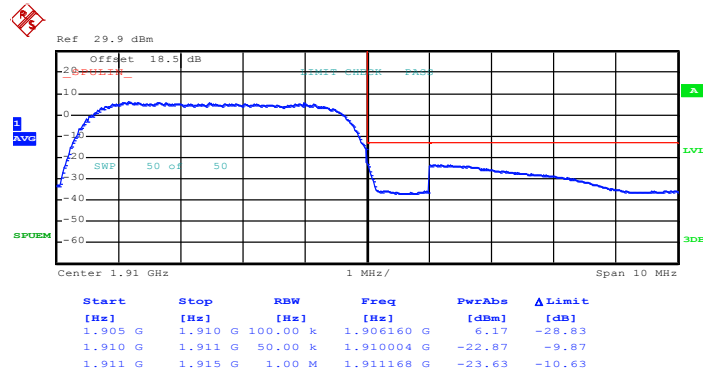

Date: 8.MAY.2015 10:29:25

3.6 Conducted Spurious Emission Measurement

3.6.1 Description of Conducted Spurious Emission Measurement

The power of any emission outside of the authorized operating frequency ranges must be lower than the transmitter power (P) by a factor of at least $43 + 10 \log (P)$ dB.

It is measured by means of a calibrated spectrum analyzer and scanned from 30 MHz up to a frequency including its 10th harmonic.

3.6.2 Measuring Instruments

The measuring equipment is listed in the section 4 of this test report.

3.6.3 Test Procedures

1. The testing follows FCC KDB 971168 v02r02 Section 6.0.
2. The EUT was connected to the spectrum analyzer and system simulator via a power divider.
3. The RF output of EUT was connected to the spectrum analyzer by an RF cable and attenuator. The path loss was compensated to the results for each measurement.
4. The middle channel for the highest RF power within the transmitting frequency was measured.
5. The conducted spurious emission for the whole frequency range was taken.
6. The RF fundamental frequency should be excluded against the limit line in the operating frequency band.
7. The limit line is derived from $43 + 10\log(P)$ dB below the transmitter power P(Watts)
 $= P(W) - [43 + 10\log(P)]$ (dB)
 $= [30 + 10\log(P)]$ (dBm) - $[43 + 10\log(P)]$ (dB)
 $= -13\text{dBm}$.

3.6.4 Test Setup

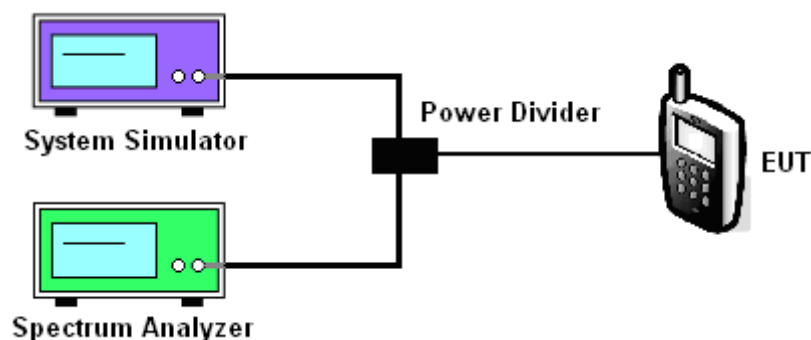



3.6.5 Test Result (Plots) of Conducted Spurious Emission

Band :	GSM850	Channel :	CH128
Test Mode :	GPRS class 8 Link (GMSK)	Frequency :	824.2 MHz

Conducted Spurious Emission Plot between 30MHz ~ 9GHz

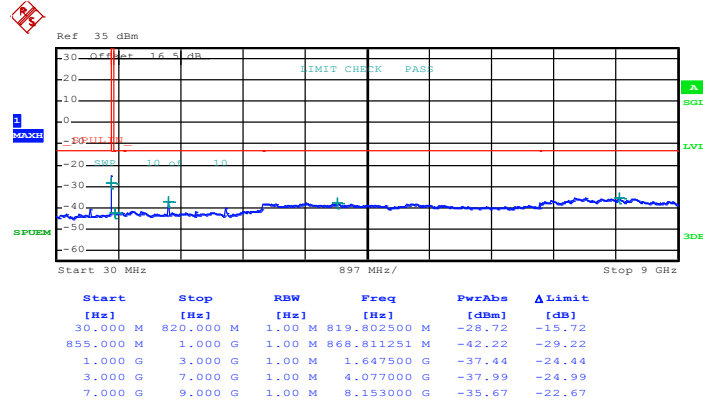

Date: 8.MAY.2015 09:37:29



Band :	GSM850	Channel :	CH189
Test Mode :	GPRS class 8 Link (GMSK)	Frequency :	836.4 MHz

Conducted Spurious Emission Plot between 30MHz ~ 9GHz

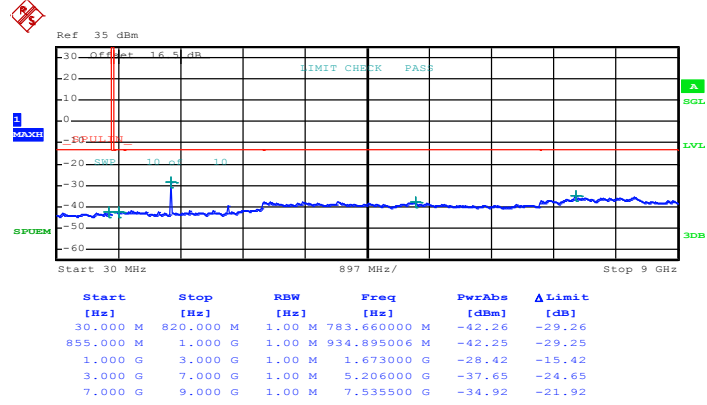

Date: 8.MAY.2015 09:37:55



Band :	GSM850	Channel :	CH251
Test Mode :	GPRS class 8 Link (GMSK)	Frequency :	848.8 MHz

Conducted Spurious Emission Plot between 30MHz ~ 9GHz

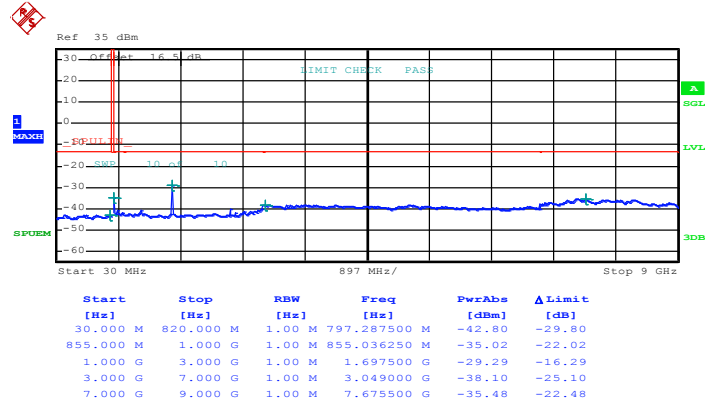

Date: 8.MAY.2015 09:38:20



Band :	GSM850	Channel :	CH128
Test Mode :	EDGE class 8 Link (8PSK)	Frequency :	824.2 MHz

Conducted Spurious Emission Plot between 30MHz ~ 9GHz

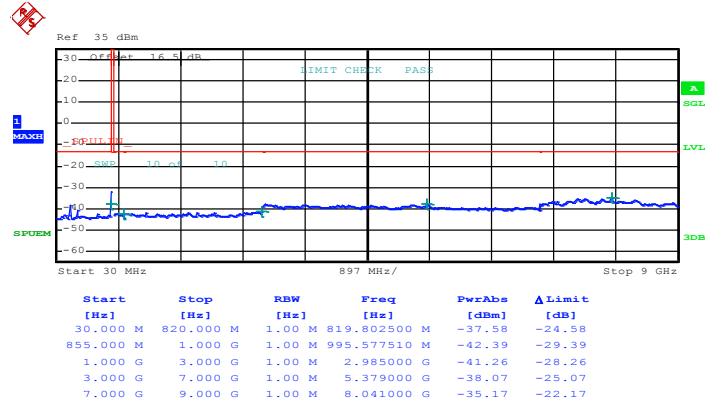

Date: 8.MAY.2015 09:48:50



Band :	GSM850	Channel :	CH189
Test Mode :	EDGE class 8 Link (8PSK)	Frequency :	836.4 MHz

Conducted Spurious Emission Plot between 30MHz ~ 9GHz

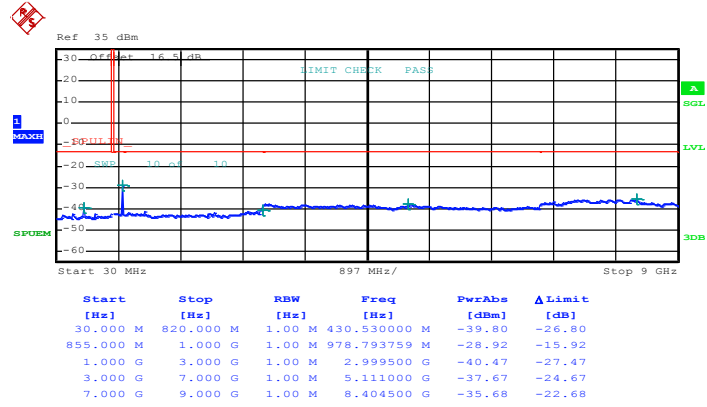

Date: 8.MAY.2015 09:49:16



Band :	GSM850	Channel :	CH251
Test Mode :	EDGE class 8 Link (8PSK)	Frequency :	848.8 MHz

Conducted Spurious Emission Plot between 30MHz ~ 9GHz

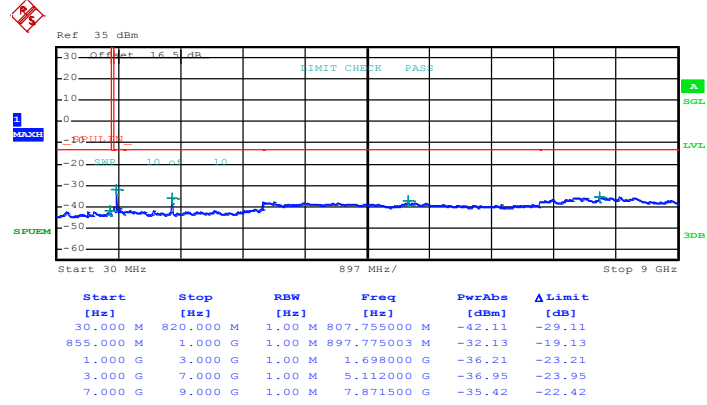

Date: 8.MAY.2015 09:49:41



Band :	GSM1900	Channel :	CH512
Test Mode :	GPRS class 8 Link (GMSK)	Frequency :	1850.2 MHz

Conducted Spurious Emission Plot between 30MHz ~ 19.1GHz

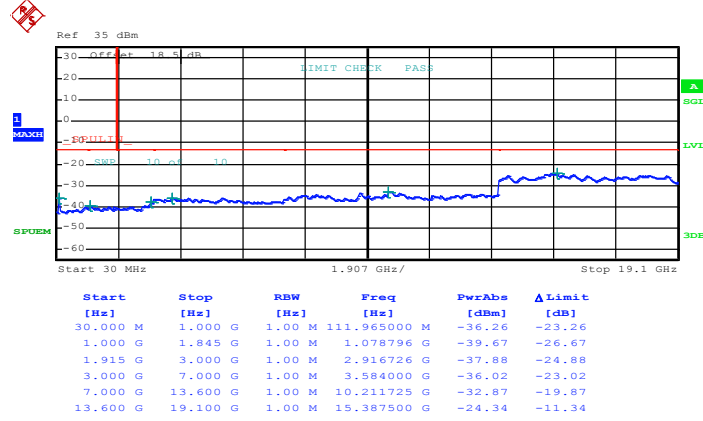

Date: 8.MAY.2015 10:01:27



Band :	GSM1900	Channel :	CH661
Test Mode :	GPRS class 8 Link (GMSK)	Frequency :	1880.0 MHz

Conducted Spurious Emission Plot between 30MHz ~ 19.1GHz

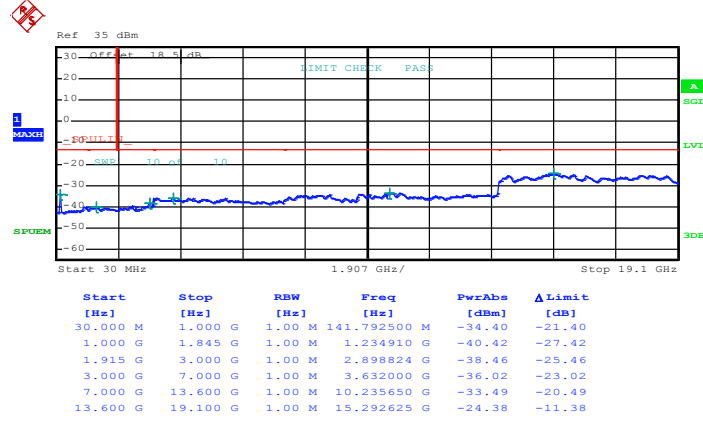

Date: 8.MAY.2015 10:01:55



Band :	GSM1900	Channel :	CH810
Test Mode :	GPRS class 8 Link (GMSK)	Frequency :	1909.8 MHz

Conducted Spurious Emission Plot between 30MHz ~ 19.1GHz

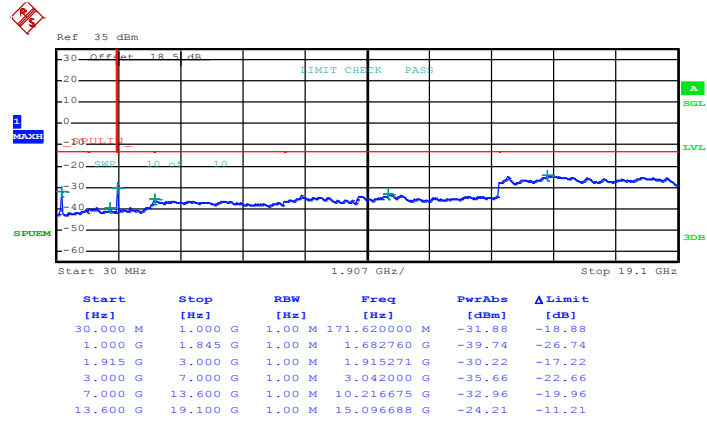

Date: 8.MAY.2015 10:02:26



Band :	GSM1900	Channel :	CH512
Test Mode :	EDGE class 8 Link (8PSK)	Frequency :	1850.2 MHz

Conducted Spurious Emission Plot between 30MHz ~ 19.1GHz

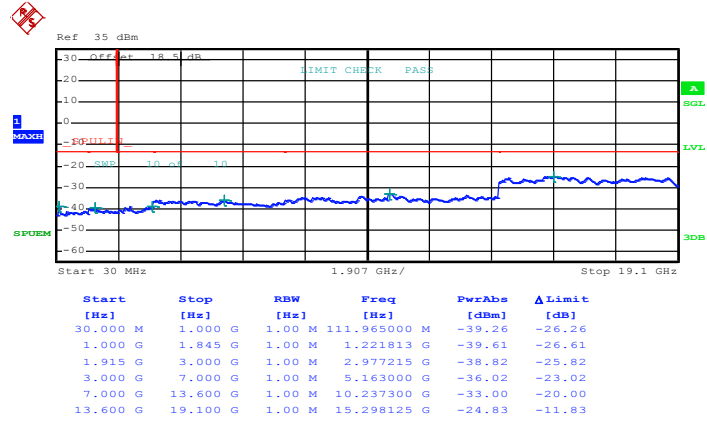

Date: 8.MAY.2015 10:19:41



Band :	GSM1900	Channel :	CH661
Test Mode :	EDGE class 8 Link (8PSK)	Frequency :	1880.0 MHz

Conducted Spurious Emission Plot between 30MHz ~ 19.1GHz

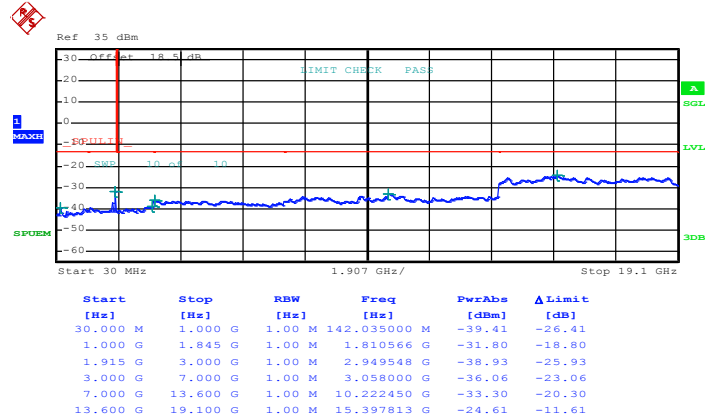

Date: 8.MAY.2015 10:20:07



Band :	GSM1900	Channel :	CH810
Test Mode :	EDGE class 8 Link (8PSK)	Frequency :	1909.8 MHz

Conducted Spurious Emission Plot between 30MHz ~ 19.1GHz

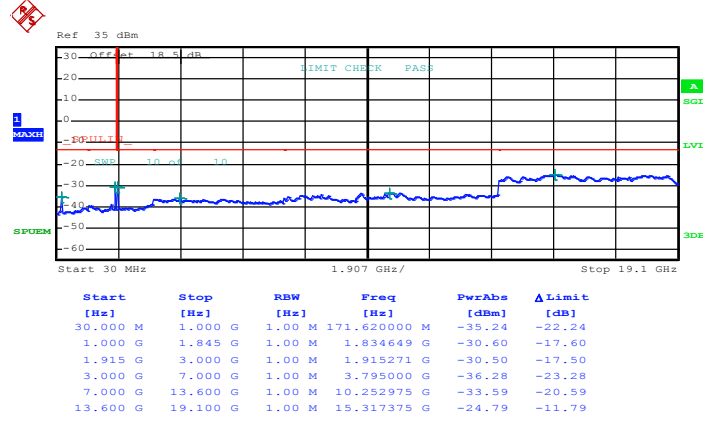

Date: 8.MAY.2015 10:20:33



Band :	WCDMA Band V	Channel :	CH4132
Test Mode :	RMC 12.2Kbps Link (QPSK)	Frequency :	826.4 MHz

Conducted Spurious Emission Plot between 30MHz ~ 9GHz

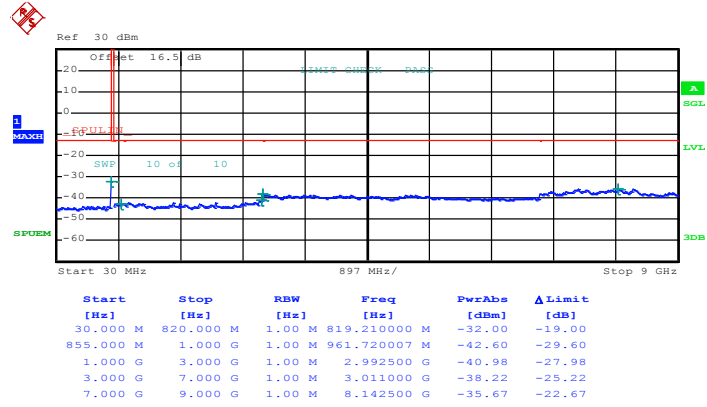

Date: 8.MAY.2015 10:39:05



Band :	WCDMA Band V	Channel :	CH4182
Test Mode :	RMC 12.2Kbps Link (QPSK)	Frequency :	836.4 MHz

Conducted Spurious Emission Plot between 30MHz ~ 9GHz

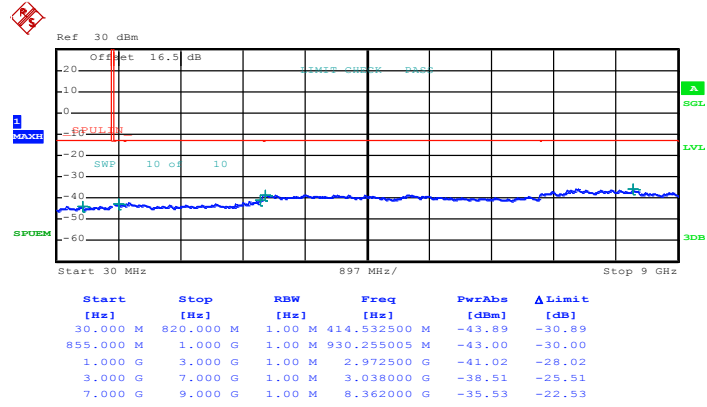

Date: 8.MAY.2015 10:39:30



Band :	WCDMA Band V	Channel :	CH4233
Test Mode :	RMC 12.2Kbps Link (QPSK)	Frequency :	846.6 MHz

Conducted Spurious Emission Plot between 30MHz ~ 9GHz

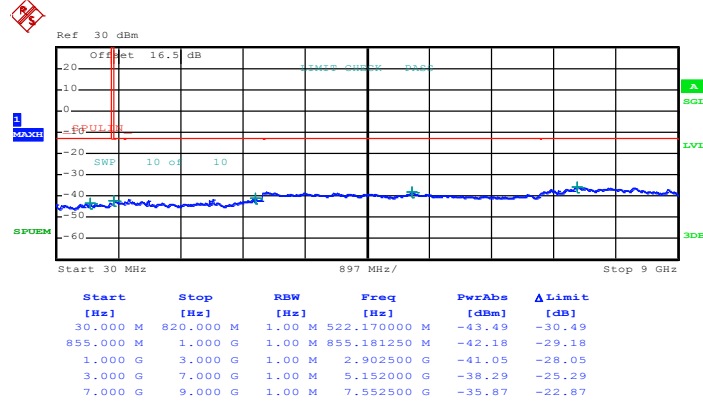

Date: 8.MAY.2015 10:39:55



Band :	WCDMA Band II	Channel :	CH9262
Test Mode :	RMC 12.2Kbps Link (QPSK)	Frequency :	1852.4 MHz

Conducted Spurious Emission Plot between 30MHz ~ 19.1GHz

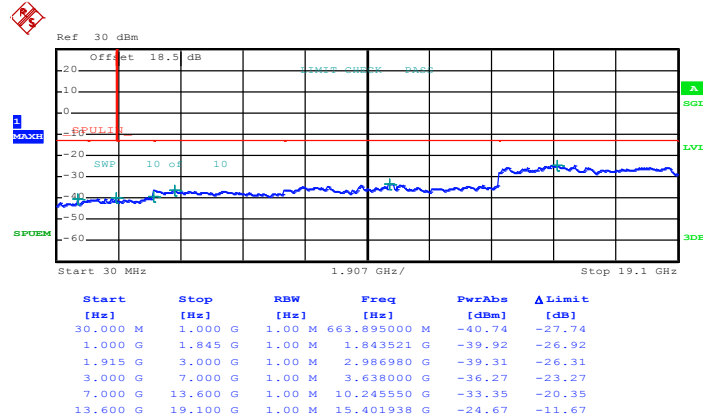

Date: 8.MAY.2015 10:29:59



Band :	WCDMA Band II	Channel :	CH9400
Test Mode :	RMC 12.2Kbps Link (QPSK)	Frequency :	1880.0 MHz

Conducted Spurious Emission Plot between 30MHz ~ 19.1GHz

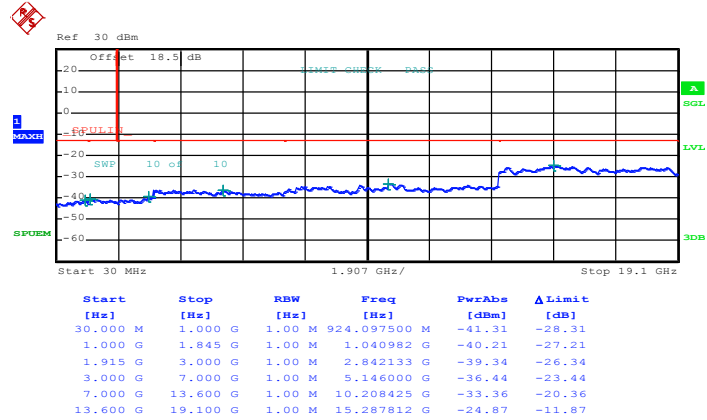

Date: 8.MAY.2015 10:30:24



Band :	WCDMA Band II	Channel :	CH9538
Test Mode :	RMC 12.2Kbps Link (QPSK)	Frequency :	1907.6 MHz

Conducted Spurious Emission Plot between 30MHz ~ 19.1GHz

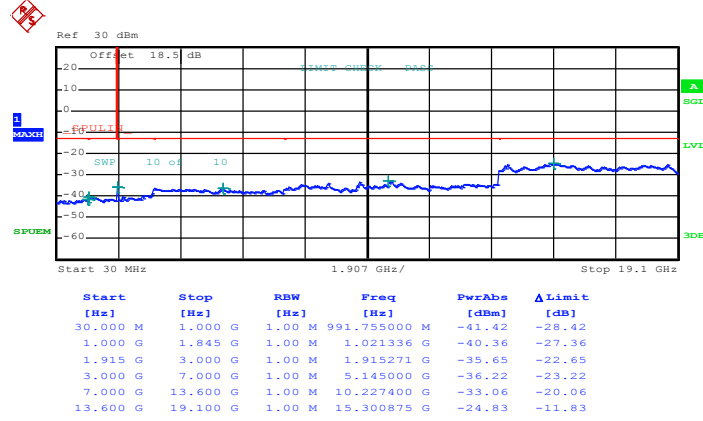

Date: 8.MAY.2015 10:30:49



3.7 Field Strength of Spurious Radiation Measurement

3.7.1 Description of Field Strength of Spurious Radiated Measurement

The power of any emission outside of the authorized operating frequency ranges must be attenuated below the transmitter power (P) by a factor of at least $43 + 10 \log (P)$ dB. The spectrum is scanned from 30 MHz up to a frequency including its 10th harmonic.

3.7.2 Measuring Instruments

The measuring equipment is listed in the section 4 of this test report.

3.7.3 Test Procedures

1. The testing follows FCC KDB 971168 v02r02 Section 5.8 and ANSI / TIA-603-C-2004 Section 2.2.12.
2. The EUT was placed on a rotatable wooden table 0.8 meters above the ground.
3. The EUT was set 3 meters from the receiving antenna, which was mounted on the antenna tower.
4. The table was rotated 360 degrees to determine the position of the highest spurious emission.
5. The height of the receiving antenna is varied between one meter and four meters to search for the maximum spurious emission for both horizontal and vertical polarizations.
6. Make the measurement with the spectrum analyzer's RBW = 1MHz, VBW = 3MHz, taking record of maximum spurious emission.
7. A horn antenna was substituted in place of the EUT and was driven by a signal generator.
8. Tune the output power of signal generator to the same emission level with EUT maximum spurious emission.
9. Taking the record of output power at antenna port.
10. Repeat step 7 to step 8 for another polarization.
11. $EIRP \text{ (dBm)} = S.G. \text{ Power} - Tx \text{ Cable Loss} + Tx \text{ Antenna Gain}$
12. $ERP \text{ (dBm)} = EIRP - 2.15$
13. The RF fundamental frequency should be excluded against the limit line in the operating frequency band.
14. The limit line is derived from $43 + 10\log(P)$ dB below the transmitter power P(Watts)
 $= P(W) - [43 + 10\log(P)] \text{ (dB)}$
 $= [30 + 10\log(P)] \text{ (dBm)} - [43 + 10\log(P)] \text{ (dB)}$
 $= -13dBm.$

3.7.4 Test Setup

For radiated emissions from 30MHz to 1GHz

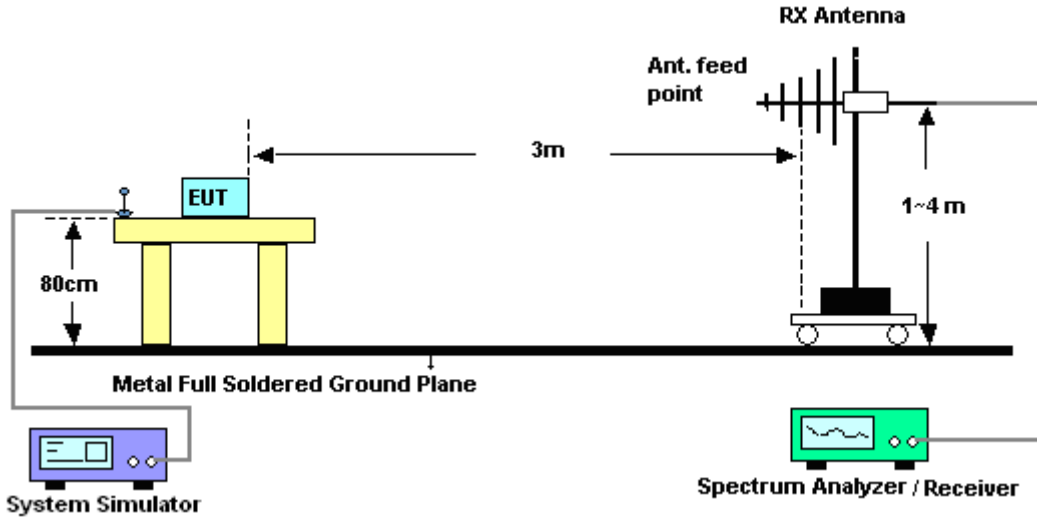

For radiated emissions above 1GHz

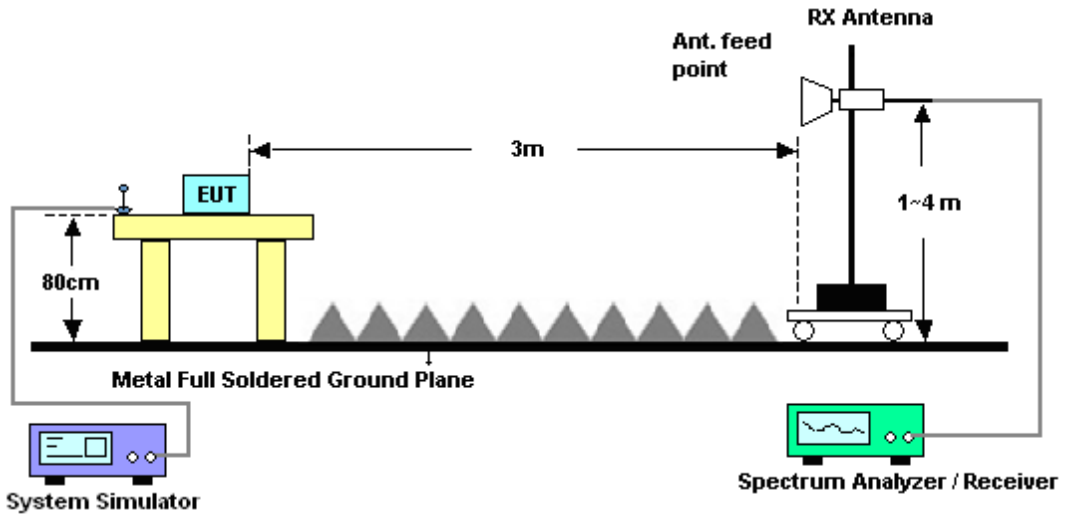



3.7.5 Test Result of Field Strength of Spurious Radiated

<Low Channel>

Band :	GSM850		Temperature :	23~25°C					
Test Mode :	GPRS class 8 Link (GMSK)		Relative Humidity :	45~47%					
Test Engineer :	Lewis He and Stan Hsieh		Polarization :	Horizontal					
Remark :	Spurious emissions within 30-1000MHz were found more than 20dB below limit line.								
Frequency (MHz)	ERP (dBm)	Limit (dBm)	Over Limit (dB)	SPA Reading (dBm)	S.G. Power (dBm)	TX Cable loss (dB)	TX Antenna Gain (dBi)	Polarization (H/V)	Result
1648	-37.44	-13	-24.44	-47.06	-39.2	0.98	4.89	H	Pass
2472	-42.68	-13	-29.68	-55.73	-44.56	1.28	5.32	H	Pass
3296	-54.08	-13	-41.08	-70.6	-57.49	1.54	7.10	H	Pass
4120	-52.57	-13	-39.57	-73.72	-57.21	1.83	8.62	H	Pass
4944	-39.50	-13	-26.50	-62.11	-44.63	2.30	9.59	H	Pass
5768	-48.24	-13	-35.24	-72.55	-53.12	2.78	9.81	H	Pass
6592	-47.12	-13	-34.12	-73.32	-52.56	2.72	10.31	H	Pass

Band :	GSM850		Temperature :	23~25°C					
Test Mode :	GPRS class 8 Link (GMSK)		Relative Humidity :	45~47%					
Test Engineer :	Lewis He and Stan Hsieh		Polarization :	Vertical					
Remark :	Spurious emissions within 30-1000MHz were found more than 20dB below limit line.								
Frequency (MHz)	ERP (dBm)	Limit (dBm)	Over Limit (dB)	SPA Reading (dBm)	S.G. Power (dBm)	TX Cable loss (dB)	TX Antenna Gain (dBi)	Polarization (H/V)	Result
1648	-40.50	-13	-27.50	-48.13	-42.26	0.98	4.89	V	Pass
2472	-39.75	-13	-26.75	-55.01	-41.63	1.28	5.32	V	Pass
3296	-58.46	-13	-45.46	-73.82	-61.87	1.54	7.10	V	Pass
4120	-55.66	-13	-42.66	-75.77	-60.3	1.83	8.62	V	Pass
4944	-50.61	-13	-37.61	-72.02	-55.74	2.30	9.59	V	Pass
5768	-50.97	-13	-37.97	-74.4	-55.85	2.78	9.81	V	Pass
6592	-49.58	-13	-36.58	-75.81	-55.02	2.72	10.31	V	Pass



<Middle Channel>

Band :	GSM850		Temperature :	23~25°C					
Test Mode :	GPRS class 8 Link (GMSK)		Relative Humidity :	45~47%					
Test Engineer :	Lewis He and Stan Hsieh		Polarization :	Horizontal					
Remark :	Spurious emissions within 30-1000MHz were found more than 20dB below limit line.								
Frequency (MHz)	ERP (dBm)	Limit (dBm)	Over Limit (dB)	SPA Reading (dBm)	S.G. Power (dBm)	TX Cable loss (dB)	TX Antenna Gain (dBi)	Polarization (H/V)	Result
1675	-39.54	-13	-26.54	-48.88	-41.21	0.99	4.81	H	Pass
2512	-32.26	-13	-19.26	-45.54	-34.23	1.29	5.41	H	Pass
3349	-54.74	-13	-41.74	-71.03	-58.37	1.56	7.34	H	Pass
5025	-46.00	-13	-33.00	-68.84	-51.2	2.35	9.70	H	Pass
5860	-51.28	-13	-38.28	-75.99	-56.14	2.83	9.84	H	Pass

Band :	GSM850		Temperature :	23~25°C					
Test Mode :	GPRS class 8 Link (GMSK)		Relative Humidity :	45~47%					
Test Engineer :	Lewis He and Stan Hsieh		Polarization :	Vertical					
Remark :	Spurious emissions within 30-1000MHz were found more than 20dB below limit line.								
Frequency (MHz)	ERP (dBm)	Limit (dBm)	Over Limit (dB)	SPA Reading (dBm)	S.G. Power (dBm)	TX Cable loss (dB)	TX Antenna Gain (dBi)	Polarization (H/V)	Result
1675	-39.85	-13	-26.85	-47.01	-41.52	0.99	4.81	V	Pass
2512	-34.28	-13	-21.28	-49.62	-36.25	1.29	5.41	V	Pass
3349	-60.65	-13	-47.65	-75.89	-64.28	1.56	7.34	V	Pass
5025	-54.79	-13	-41.79	-76.28	-59.99	2.35	9.70	V	Pass
5860	-52.25	-13	-39.25	-76.38	-57.11	2.83	9.84	V	Pass



<High Channel>

Band :	GSM850		Temperature :	23~25°C					
Test Mode :	GPRS class 8 Link (GMSK)		Relative Humidity :	45~47%					
Test Engineer :	Lewis He and Stan Hsieh		Polarization :	Horizontal					
Remark :	Spurious emissions within 30-1000MHz were found more than 20dB below limit line.								
Frequency (MHz)	ERP (dBm)	Limit (dBm)	Over Limit (dB)	SPA Reading (dBm)	S.G. Power (dBm)	TX Cable loss (dB)	TX Antenna Gain (dBi)	Polarization (H/V)	Result
1696	-39.62	-13	-26.62	-49.1	-41.22	1.00	4.75	H	Pass
2544	-41.56	-13	-28.56	-52.27	-43.54	1.30	5.44	H	Pass
3392	-54.80	-13	-41.80	-71.22	-58.6	1.57	7.52	H	Pass
4248	-50.71	-13	-37.71	-72.09	-55.31	1.90	8.65	H	Pass
5096	-49.90	-13	-36.90	-72.69	-55.06	2.39	9.70	H	Pass
5944	-49.30	-13	-36.30	-74.35	-54.15	2.88	9.88	H	Pass

Band :	GSM850		Temperature :	23~25°C					
Test Mode :	GPRS class 8 Link (GMSK)		Relative Humidity :	45~47%					
Test Engineer :	Lewis He and Stan Hsieh		Polarization :	Vertical					
Remark :	Spurious emissions within 30-1000MHz were found more than 20dB below limit line.								
Frequency (MHz)	ERP (dBm)	Limit (dBm)	Over Limit (dB)	SPA Reading (dBm)	S.G. Power (dBm)	TX Cable loss (dB)	TX Antenna Gain (dBi)	Polarization (H/V)	Result
1696	-43.26	-13	-30.26	-50.96	-44.86	1.00	4.75	V	Pass
2544	-39.94	-13	-26.94	-55.32	-41.92	1.30	5.44	V	Pass
3392	-60.20	-13	-47.20	-75.89	-64	1.57	7.52	V	Pass
4248	-53.15	-13	-40.15	-73.27	-57.75	1.90	8.65	V	Pass
5096	-53.47	-13	-40.47	-75.17	-58.63	2.39	9.70	V	Pass
5944	-51.53	-13	-38.53	-75.87	-56.38	2.88	9.88	V	Pass



<Low Channel>

Band :	GSM850	Temperature :	23~25°C						
Test Mode :	EDGE class 8 Link (8PSK)	Relative Humidity :	45~47%						
Test Engineer :	Lewis He and Stan Hsieh	Polarization :	Horizontal						
Remark :	Spurious emissions within 30-1000MHz were found more than 20dB below limit line.								
Frequency (MHz)	ERP (dBm)	Limit (dBm)	Over Limit (dB)	SPA Reading (dBm)	S.G. Power (dBm)	TX Cable loss (dB)	TX Antenna Gain (dBi)	Polarization (H/V)	Result
1648	-44.39	-13	-31.39	-54.01	-46.15	0.98	4.89	H	Pass
2472	-53.15	-13	-40.15	-66.21	-55.03	1.28	5.32	H	Pass
3296	-59.47	-13	-46.47	-75.94	-62.88	1.54	7.10	H	Pass

Band :	GSM850	Temperature :	23~25°C						
Test Mode :	EDGE class 8 Link (8PSK)	Relative Humidity :	45~47%						
Test Engineer :	Lewis He and Stan Hsieh	Polarization :	Vertical						
Remark :	Spurious emissions within 30-1000MHz were found more than 20dB below limit line.								
Frequency (MHz)	ERP (dBm)	Limit (dBm)	Over Limit (dB)	SPA Reading (dBm)	S.G. Power (dBm)	TX Cable loss (dB)	TX Antenna Gain (dBi)	Polarization (H/V)	Result
1648	-51.78	-13	-38.78	-59.41	-53.54	0.98	4.89	V	Pass
2472	-51.30	-13	-38.30	-66.54	-53.18	1.28	5.32	V	Pass
3296	-60.59	-13	-47.59	-76.05	-64	1.54	7.10	V	Pass



<Middle Channel>

Band :	GSM850	Temperature :	23~25°C						
Test Mode :	EDGE class 8 Link (8PSK)	Relative Humidity :	45~47%						
Test Engineer :	Lewis He and Stan Hsieh	Polarization :	Horizontal						
Remark :	Spurious emissions within 30-1000MHz were found more than 20dB below limit line.								
Frequency (MHz)	ERP (dBm)	Limit (dBm)	Over Limit (dB)	SPA Reading (dBm)	S.G. Power (dBm)	TX Cable loss (dB)	TX Antenna Gain (dBi)	Polarization (H/V)	Result
1672	-44.11	-13	-31.11	-53.43	-45.79	0.99	4.82	H	Pass
2512	-45.40	-13	-32.40	-58.6	-47.37	1.29	5.41	H	Pass
3344	-59.39	-13	-46.39	-75.62	-63	1.56	7.31	H	Pass

Band :	GSM850	Temperature :	23~25°C						
Test Mode :	EDGE class 8 Link (8PSK)	Relative Humidity :	45~47%						
Test Engineer :	Lewis He and Stan Hsieh	Polarization :	Vertical						
Remark :	Spurious emissions within 30-1000MHz were found more than 20dB below limit line.								
Frequency (MHz)	ERP (dBm)	Limit (dBm)	Over Limit (dB)	SPA Reading (dBm)	S.G. Power (dBm)	TX Cable loss (dB)	TX Antenna Gain (dBi)	Polarization (H/V)	Result
1672	-51.01	-13	-38.01	-58.14	-52.69	0.99	4.82	V	Pass
2512	-42.76	-13	-29.76	-58.1	-44.73	1.29	5.41	V	Pass
3344	-60.52	-13	-47.52	-75.75	-64.13	1.56	7.31	V	Pass



<High Channel>

Band :	GSM850				Temperature :	23~25°C			
Test Mode :	EDGE class 8 Link (8PSK)				Relative Humidity :	45~47%			
Test Engineer :	Lewis He and Stan Hsieh				Polarization :	Horizontal			
Remark :	Spurious emissions within 30-1000MHz were found more than 20dB below limit line.								
Frequency (MHz)	ERP (dBm)	Limit (dBm)	Over Limit (dB)	SPA Reading (dBm)	S.G. Power (dBm)	TX Cable loss (dB)	TX Antenna Gain (dBi)	Polarization (H/V)	Result
1696	-45.87	-13	-32.87	-55.35	-47.47	1.00	4.75	H	Pass
2544	-51.23	-13	-38.23	-65.01	-53.21	1.30	5.44	H	Pass
3392	-59.84	-13	-46.84	-76.22	-63.64	1.57	7.52	H	Pass

Band :	GSM850				Temperature :	23~25°C			
Test Mode :	EDGE class 8 Link (8PSK)				Relative Humidity :	45~47%			
Test Engineer :	Lewis He and Stan Hsieh				Polarization :	Vertical			
Remark :	Spurious emissions within 30-1000MHz were found more than 20dB below limit line.								
Frequency (MHz)	ERP (dBm)	Limit (dBm)	Over Limit (dB)	SPA Reading (dBm)	S.G. Power (dBm)	TX Cable loss (dB)	TX Antenna Gain (dBi)	Polarization (H/V)	Result
1696	-51.74	-13	-38.74	-59.48	-53.34	1.00	4.75	V	Pass
2544	-47.74	-13	-34.74	-62.93	-51.87	1.30	5.44	V	Pass
3392	-60.41	-13	-47.41	-76.22	-66.36	1.57	7.52	V	Pass



<Low Channel>

Band :	GSM1900					Temperature :	23~25°C		
Test Mode :	GPRS class 8 Link (GMSK)					Relative Humidity :	45~47%		
Test Engineer :	Lewis He and Stan Hsieh					Polarization :	Horizontal		
Remark :	Spurious emissions within 30-1000MHz were found more than 20dB below limit line.								
Frequency (MHz)	EIRP (dBm)	Limit (dBm)	Over Limit (dB)	SPA Reading (dBm)	S.G. Power (dBm)	TX Cable loss (dB)	TX Antenna Gain (dBi)	Polarization (H/V)	Result
3700	-46.67	-13	-33.67	-65.08	-53.24	1.67	8.24	H	Pass
5548	-39.21	-13	-26.21	-62.75	-46.28	2.65	9.72	H	Pass
7403	-44.34	-13	-31.34	-72.9	-53.49	2.46	11.61	H	Pass

Band :	GSM1900					Temperature :	23~25°C		
Test Mode :	GPRS class 8 Link (GMSK)					Relative Humidity :	45~47%		
Test Engineer :	Lewis He and Stan Hsieh					Polarization :	Vertical		
Remark :	Spurious emissions within 30-1000MHz were found more than 20dB below limit line.								
Frequency (MHz)	EIRP (dBm)	Limit (dBm)	Over Limit (dB)	SPA Reading (dBm)	S.G. Power (dBm)	TX Cable loss (dB)	TX Antenna Gain (dBi)	Polarization (H/V)	Result
3700	-45.61	-13	-32.61	-64.01	-52.18	1.67	8.24	V	Pass
5548	-43.54	-13	-30.54	-65.84	-50.61	2.65	9.72	V	Pass
7403	-42.54	-13	-29.54	-70.24	-51.69	2.46	11.61	V	Pass



<Middle Channel>

Band :	GSM1900	Temperature :	23~25°C						
Test Mode :	GPRS class 8 Link (GMSK)	Relative Humidity :	45~47%						
Test Engineer :	Lewis He and Stan Hsieh	Polarization :	Horizontal						
Remark :	Spurious emissions within 30-1000MHz were found more than 20dB below limit line.								
Frequency (MHz)	EIRP (dBm)	Limit (dBm)	Over Limit (dB)	SPA Reading (dBm)	S.G. Power (dBm)	TX Cable loss (dB)	TX Antenna Gain (dBi)	Polarization (H/V)	Result
3763	-42.61	-13	-29.61	-61.35	-49.24	1.69	8.32	H	Pass
5639	-35.56	-13	-22.56	-59.33	-42.61	2.71	9.76	H	Pass
7522	-44.50	-13	-31.50	-73.63	-53.89	2.42	11.81	H	Pass
9398	-43.05	-13	-30.05	-74.4	-53.02	2.57	12.54	H	Pass

Band :	GSM1900	Temperature :	23~25°C						
Test Mode :	GPRS class 8 Link (GMSK)	Relative Humidity :	45~47%						
Test Engineer :	Lewis He and Stan Hsieh	Polarization :	Vertical						
Remark :	Spurious emissions within 30-1000MHz were found more than 20dB below limit line.								
Frequency (MHz)	EIRP (dBm)	Limit (dBm)	Over Limit (dB)	SPA Reading (dBm)	S.G. Power (dBm)	TX Cable loss (dB)	TX Antenna Gain (dBi)	Polarization (H/V)	Result
3763	-43.55	-13	-30.55	-61.82	-50.18	1.69	8.32	V	Pass
5639	-39.53	-13	-26.53	-62.27	-46.58	2.71	9.76	V	Pass
7522	-41.75	-13	-28.75	-69.98	-51.14	2.42	11.81	V	Pass
9398	-47.72	-13	-34.72	-76.51	-57.69	2.57	12.54	V	Pass



<High Channel>

Band :	GSM1900		Temperature :	23~25°C					
Test Mode :	GPRS class 8 Link (GMSK)		Relative Humidity :	45~47%					
Test Engineer :	Lewis He and Stan Hsieh		Polarization :	Horizontal					
Remark :	Spurious emissions within 30-1000MHz were found more than 20dB below limit line.								
Frequency (MHz)	EIRP (dBm)	Limit (dBm)	Over Limit (dB)	SPA Reading (dBm)	S.G. Power (dBm)	TX Cable loss (dB)	TX Antenna Gain (dBi)	Polarization (H/V)	Result
3819	-44.74	-13	-31.74	-63.97	-51.42	1.70	8.38	H	Pass
5730	-33.25	-13	-20.25	-57.55	-40.28	2.76	9.79	H	Pass
7641	-41.37	-13	-28.37	-69.91	-50.87	2.38	11.88	H	Pass
9552	-40.81	-13	-27.81	-72.43	-50.68	2.60	12.47	H	Pass
11463	-36.23	-13	-23.23	-69.08	-45.86	2.68	12.31	H	Pass

Band :	GSM1900		Temperature :	23~25°C					
Test Mode :	GPRS class 8 Link (GMSK)		Relative Humidity :	45~47%					
Test Engineer :	Lewis He and Stan Hsieh		Polarization :	Vertical					
Remark :	Spurious emissions within 30-1000MHz were found more than 20dB below limit line.								
Frequency (MHz)	EIRP (dBm)	Limit (dBm)	Over Limit (dB)	SPA Reading (dBm)	S.G. Power (dBm)	TX Cable loss (dB)	TX Antenna Gain (dBi)	Polarization (H/V)	Result
3819	-43.51	-13	-30.51	-62	-50.19	1.70	8.38	V	Pass
5730	-40.60	-13	-27.60	-63.54	-47.63	2.76	9.79	V	Pass
7641	-40.08	-13	-27.08	-68.64	-49.58	2.38	11.88	V	Pass
9552	-44.39	-13	-31.39	-74.02	-54.26	2.60	12.47	V	Pass
11463	-41.58	-13	-28.58	-74.32	-51.21	2.68	12.31	V	Pass



<Low Channel>

Band :	GSM1900		Temperature :	23~25°C					
Test Mode :	EDGE class 8 Link (8PSK)		Relative Humidity :	45~47%					
Test Engineer :	Lewis He and Stan Hsieh		Polarization :	Horizontal					
Remark :	Spurious emissions within 30-1000MHz were found more than 20dB below limit line.								
Frequency (MHz)	EIRP (dBm)	Limit (dBm)	Over Limit (dB)	SPA Reading (dBm)	S.G. Power (dBm)	TX Cable loss (dB)	TX Antenna Gain (dBi)	Polarization (H/V)	Result
3700	-44.70	-13	-31.70	-63.19	-51.27	1.67	8.24	H	Pass
5548	-36.54	-13	-23.54	-59.86	-43.61	2.65	9.72	H	Pass
7403	-43.46	-13	-30.46	-72.08	-52.61	2.46	11.61	H	Pass
9251	-42.43	-13	-29.43	-73.45	-52.49	2.54	12.60	H	Pass

Band :	GSM1900		Temperature :	23~25°C					
Test Mode :	EDGE class 8 Link (8PSK)		Relative Humidity :	45~47%					
Test Engineer :	Lewis He and Stan Hsieh		Polarization :	Vertical					
Remark :	Spurious emissions within 30-1000MHz were found more than 20dB below limit line.								
Frequency (MHz)	EIRP (dBm)	Limit (dBm)	Over Limit (dB)	SPA Reading (dBm)	S.G. Power (dBm)	TX Cable loss (dB)	TX Antenna Gain (dBi)	Polarization (H/V)	Result
3700	-43.64	-13	-30.64	-62.5	-50.21	1.67	8.24	V	Pass
5548	-42.75	-13	-29.75	-64.41	-49.82	2.65	9.72	V	Pass
7403	-41.07	-13	-28.07	-69.61	-50.22	2.46	11.61	V	Pass
9251	-45.12	-13	-32.12	-75.88	-55.18	2.54	12.60	V	Pass



<Middle Channel>

Band :	GSM1900	Temperature :	23~25°C						
Test Mode :	EDGE class 8 Link (8PSK)	Relative Humidity :	45~47%						
Test Engineer :	Lewis He and Stan Hsieh	Polarization :	Horizontal						
Remark :	Spurious emissions within 30-1000MHz were found more than 20dB below limit line.								
Frequency (MHz)	EIRP (dBm)	Limit (dBm)	Over Limit (dB)	SPA Reading (dBm)	S.G. Power (dBm)	TX Cable loss (dB)	TX Antenna Gain (dBi)	Polarization (H/V)	Result
3763	-42.52	-13	-29.52	-61.57	-49.15	1.69	8.32	H	Pass
5639	-34.20	-13	-21.20	-57.76	-41.25	2.71	9.76	H	Pass
7522	-42.02	-13	-29.02	-70.76	-51.41	2.42	11.81	H	Pass
9398	-42.69	-13	-29.69	-73.68	-52.66	2.57	12.54	H	Pass
11282	-40.38	-13	-27.38	-72.98	-50.08	2.68	12.39	H	Pass

Band :	GSM1900	Temperature :	23~25°C						
Test Mode :	EDGE class 8 Link (8PSK)	Relative Humidity :	45~47%						
Test Engineer :	Lewis He and Stan Hsieh	Polarization :	Vertical						
Remark :	Spurious emissions within 30-1000MHz were found more than 20dB below limit line.								
Frequency (MHz)	EIRP (dBm)	Limit (dBm)	Over Limit (dB)	SPA Reading (dBm)	S.G. Power (dBm)	TX Cable loss (dB)	TX Antenna Gain (dBi)	Polarization (H/V)	Result
3763	-40.58	-13	-27.58	-59.15	-47.21	1.69	8.32	V	Pass
5639	-40.21	-13	-27.21	-62.36	-47.26	2.71	9.76	V	Pass
7522	-40.79	-13	-27.79	-69.12	-50.18	2.42	11.81	V	Pass
9398	-46.51	-13	-33.51	-75.59	-56.48	2.57	12.54	V	Pass
11282	-42.47	-13	-29.47	-74.82	-52.17	2.68	12.39	V	Pass



<High Channel>

Band :	GSM1900		Temperature :	23~25°C					
Test Mode :	EDGE class 8 Link (8PSK)		Relative Humidity :	45~47%					
Test Engineer :	Lewis He and Stan Hsieh		Polarization :	Horizontal					
Remark :	Spurious emissions within 30-1000MHz were found more than 20dB below limit line.								
Frequency (MHz)	EIRP (dBm)	Limit (dBm)	Over Limit (dB)	SPA Reading (dBm)	S.G. Power (dBm)	TX Cable loss (dB)	TX Antenna Gain (dBi)	Polarization (H/V)	Result
3819	-45.28	-13	-32.28	-65.27	-51.96	1.70	8.38	H	Pass
5730	-35.55	-13	-22.55	-59.25	-42.58	2.76	9.79	H	Pass
7641	-43.65	-13	-30.65	-71.77	-53.15	2.38	11.88	H	Pass
9552	-40.61	-13	-27.61	-72.24	-50.48	2.60	12.47	H	Pass
11463	-36.65	-13	-23.65	-69.3	-46.28	2.68	12.31	H	Pass

Band :	GSM1900		Temperature :	23~25°C					
Test Mode :	EDGE class 8 Link (8PSK)		Relative Humidity :	45~47%					
Test Engineer :	Lewis He and Stan Hsieh		Polarization :	Vertical					
Remark :	Spurious emissions within 30-1000MHz were found more than 20dB below limit line.								
Frequency (MHz)	EIRP (dBm)	Limit (dBm)	Over Limit (dB)	SPA Reading (dBm)	S.G. Power (dBm)	TX Cable loss (dB)	TX Antenna Gain (dBi)	Polarization (H/V)	Result
3819	-43.50	-13	-30.50	-62.31	-50.18	1.70	8.38	V	Pass
5730	-38.25	-13	-25.25	-61.26	-45.28	2.76	9.79	V	Pass
7641	-42.12	-13	-29.12	-70.72	-51.62	2.38	11.88	V	Pass
9552	-43.75	-13	-30.75	-73.49	-53.62	2.60	12.47	V	Pass
11463	-40.58	-13	-27.58	-73.77	-50.21	2.68	12.31	V	Pass



<Low Channel>

Band :	WCDMA Band V	Temperature :	23~25°C						
Test Mode :	RMC 12.2Kbps Link (QPSK)	Relative Humidity :	45~47%						
Test Engineer :	Lewis He and Stan Hsieh	Polarization :	Horizontal						
Remark :	Spurious emissions within 30-1000MHz were found more than 20dB below limit line.								
Frequency (MHz)	ERP (dBm)	Limit (dBm)	Over Limit (dB)	SPA Reading (dBm)	S.G. Power (dBm)	TX Cable loss (dB)	TX Antenna Gain (dBi)	Polarization (H/V)	Result
1656	-64.60	-13	-51.60	-74.09	-66.33	0.98	4.86	H	Pass
2480	-62.37	-13	-49.37	-75.43	-64.28	1.28	5.34	H	Pass
3304	-59.58	-13	-46.58	-76.1	-63.02	1.54	7.14	H	Pass

Band :	WCDMA Band V	Temperature :	23~25°C						
Test Mode :	RMC 12.2Kbps Link (QPSK)	Relative Humidity :	45~47%						
Test Engineer :	Lewis He and Stan Hsieh	Polarization :	Vertical						
Remark :	Spurious emissions within 30-1000MHz were found more than 20dB below limit line.								
Frequency (MHz)	ERP (dBm)	Limit (dBm)	Over Limit (dB)	SPA Reading (dBm)	S.G. Power (dBm)	TX Cable loss (dB)	TX Antenna Gain (dBi)	Polarization (H/V)	Result
1656	-66.79	-13	-53.79	-74.15	-68.52	0.98	4.86	V	Pass
2480	-60.09	-13	-47.09	-75.33	-62	1.28	5.34	V	Pass
3304	-60.99	-13	-47.99	-76.34	-64.43	1.54	7.14	V	Pass



<Middle Channel>

Band :	WCDMA Band V	Temperature :	23~25°C						
Test Mode :	RMC 12.2Kbps Link (QPSK)	Relative Humidity :	45~47%						
Test Engineer :	Lewis He and Stan Hsieh	Polarization :	Horizontal						
Remark :	Spurious emissions within 30-1000MHz were found more than 20dB below limit line.								
Frequency (MHz)	ERP (dBm)	Limit (dBm)	Over Limit (dB)	SPA Reading (dBm)	S.G. Power (dBm)	TX Cable loss (dB)	TX Antenna Gain (dBi)	Polarization (H/V)	Result
1672	-64.53	-13	-51.53	-73.91	-66.21	0.99	4.82	H	Pass
2504	-62.08	-13	-49.08	-75.17	-64.04	1.29	5.40	H	Pass
3344	-59.62	-13	-46.62	-75.83	-63.23	1.56	7.31	H	Pass

Band :	WCDMA Band V	Temperature :	23~25°C						
Test Mode :	RMC 12.2Kbps Link (QPSK)	Relative Humidity :	45~47%						
Test Engineer :	Lewis He and Stan Hsieh	Polarization :	Vertical						
Remark :	Spurious emissions within 30-1000MHz were found more than 20dB below limit line.								
Frequency (MHz)	ERP (dBm)	Limit (dBm)	Over Limit (dB)	SPA Reading (dBm)	S.G. Power (dBm)	TX Cable loss (dB)	TX Antenna Gain (dBi)	Polarization (H/V)	Result
1672	-66.78	-13	-53.78	-73.87	-68.46	0.99	4.82	V	Pass
2504	-60.06	-13	-47.06	-75.4	-62.02	1.29	5.40	V	Pass
3344	-60.37	-13	-47.37	-75.54	-63.98	1.56	7.31	V	Pass



<High Channel>

Band :	WCDMA Band V	Temperature :	23~25°C						
Test Mode :	RMC 12.2Kbps Link (QPSK)	Relative Humidity :	45~47%						
Test Engineer :	Lewis He and Stan Hsieh	Polarization :	Horizontal						
Remark :	Spurious emissions within 30-1000MHz were found more than 20dB below limit line.								
Frequency (MHz)	ERP (dBm)	Limit (dBm)	Over Limit (dB)	SPA Reading (dBm)	S.G. Power (dBm)	TX Cable loss (dB)	TX Antenna Gain (dBi)	Polarization (H/V)	Result
1696	-64.66	-13	-51.66	-74.16	-66.26	1.00	4.75	H	Pass
2536	-61.92	-13	-48.92	-75.42	-63.9	1.30	5.43	H	Pass
3384	-59.46	-13	-46.46	-75.86	-63.23	1.57	7.49	H	Pass

Band :	WCDMA Band V	Temperature :	23~25°C						
Test Mode :	RMC 12.2Kbps Link (QPSK)	Relative Humidity :	45~47%						
Test Engineer :	Lewis He and Stan Hsieh	Polarization :	Vertical						
Remark :	Spurious emissions within 30-1000MHz were found more than 20dB below limit line.								
Frequency (MHz)	ERP (dBm)	Limit (dBm)	Over Limit (dB)	SPA Reading (dBm)	S.G. Power (dBm)	TX Cable loss (dB)	TX Antenna Gain (dBi)	Polarization (H/V)	Result
1696	-66.47	-13	-53.47	-74.23	-68.07	1.00	4.75	V	Pass
2536	-60.26	-13	-47.26	-75.65	-62.24	1.30	5.43	V	Pass
3384	-60.28	-13	-47.28	-75.94	-64.05	1.57	7.49	V	Pass



<Low Channel>

Band :	WCDMA Band II	Temperature :	23~25°C						
Test Mode :	RMC 12.2Kbps Link (QPSK)	Relative Humidity :	45~47%						
Test Engineer :	Lewis He and Stan Hsieh	Polarization :	Horizontal						
Remark :	Spurious emissions within 30-1000MHz were found more than 20dB below limit line.								
Frequency (MHz)	EIRP (dBm)	Limit (dBm)	Over Limit (dB)	SPA Reading (dBm)	S.G. Power (dBm)	TX Cable loss (dB)	TX Antenna Gain (dBi)	Polarization (H/V)	Result
3707	-45.56	-13	-32.56	-64.51	-52.14	1.67	8.25	H	Pass
5555	-42.04	-13	-29.04	-65.76	-49.11	2.66	9.72	H	Pass
7410	-44.30	-13	-31.30	-73.15	-53.46	2.46	11.62	H	Pass

Band :	WCDMA Band II	Temperature :	23~25°C						
Test Mode :	RMC 12.2Kbps Link (QPSK)	Relative Humidity :	45~47%						
Test Engineer :	Lewis He and Stan Hsieh	Polarization :	Vertical						
Remark :	Spurious emissions within 30-1000MHz were found more than 20dB below limit line.								
Frequency (MHz)	EIRP (dBm)	Limit (dBm)	Over Limit (dB)	SPA Reading (dBm)	S.G. Power (dBm)	TX Cable loss (dB)	TX Antenna Gain (dBi)	Polarization (H/V)	Result
3707	-44.68	-13	-31.68	-63.07	-51.26	1.67	8.25	V	Pass
5555	-45.24	-13	-32.24	-67.13	-52.31	2.66	9.72	V	Pass
7410	-44.32	-13	-31.32	-72.45	-53.48	2.46	11.62	V	Pass



<Middle Channel>

Band :	WCDMA Band II	Temperature :	23~25°C						
Test Mode :	RMC 12.2Kbps Link (QPSK)	Relative Humidity :	45~47%						
Test Engineer :	Lewis He and Stan Hsieh	Polarization :	Horizontal						
Remark :	Spurious emissions within 30-1000MHz were found more than 20dB below limit line.								
Frequency (MHz)	EIRP (dBm)	Limit (dBm)	Over Limit (dB)	SPA Reading (dBm)	S.G. Power (dBm)	TX Cable loss (dB)	TX Antenna Gain (dBi)	Polarization (H/V)	Result
3763	-52.66	-13	-39.66	-71.91	-59.29	1.69	8.32	H	Pass
5639	-39.47	-13	-26.47	-63.2	-46.52	2.71	9.76	H	Pass
7522	-44.37	-13	-31.37	-72.66	-53.76	2.42	11.81	H	Pass

Band :	WCDMA Band II	Temperature :	23~25°C						
Test Mode :	RMC 12.2Kbps Link (QPSK)	Relative Humidity :	45~47%						
Test Engineer :	Lewis He and Stan Hsieh	Polarization :	Vertical						
Remark :	Spurious emissions within 30-1000MHz were found more than 20dB below limit line.								
Frequency (MHz)	EIRP (dBm)	Limit (dBm)	Over Limit (dB)	SPA Reading (dBm)	S.G. Power (dBm)	TX Cable loss (dB)	TX Antenna Gain (dBi)	Polarization (H/V)	Result
3763	-51.19	-13	-38.19	-69.9	-57.82	1.69	8.32	V	Pass
5639	-42.53	-13	-29.53	-65.01	-49.58	2.71	9.76	V	Pass
7522	-43.02	-13	-30.02	-71.43	-52.41	2.42	11.81	V	Pass



<High Channel>

Band :	WCDMA Band II	Temperature :	23~25°C						
Test Mode :	RMC 12.2Kbps Link (QPSK)	Relative Humidity :	45~47%						
Test Engineer :	Lewis He and Stan Hsieh	Polarization :	Horizontal						
Remark :	Spurious emissions within 30-1000MHz were found more than 20dB below limit line.								
Frequency (MHz)	EIRP (dBm)	Limit (dBm)	Over Limit (dB)	SPA Reading (dBm)	S.G. Power (dBm)	TX Cable loss (dB)	TX Antenna Gain (dBi)	Polarization (H/V)	Result
3812	-49.72	-13	-36.72	-69.02	-56.39	1.70	8.37	H	Pass
5723	-36.21	-13	-23.21	-60.48	-43.25	2.75	9.79	H	Pass
7634	-41.62	-13	-28.62	-70.37	-51.11	2.39	11.88	H	Pass

Band :	WCDMA Band II	Temperature :	23~25°C						
Test Mode :	RMC 12.2Kbps Link (QPSK)	Relative Humidity :	45~47%						
Test Engineer :	Lewis He and Stan Hsieh	Polarization :	Vertical						
Remark :	Spurious emissions within 30-1000MHz were found more than 20dB below limit line.								
Frequency (MHz)	EIRP (dBm)	Limit (dBm)	Over Limit (dB)	SPA Reading (dBm)	S.G. Power (dBm)	TX Cable loss (dB)	TX Antenna Gain (dBi)	Polarization (H/V)	Result
3812	-49.51	-13	-36.51	-68.09	-56.18	1.70	8.37	V	Pass
5723	-39.64	-13	-26.64	-63.13	-46.68	2.75	9.79	V	Pass
7634	-42.76	-13	-29.76	-70.65	-52.25	2.39	11.88	V	Pass



3.8 Frequency Stability Measurement

3.8.1 Description of Frequency Stability Measurement

The frequency stability shall be measured by variation of ambient temperature and variation of primary supply voltage to ensure that the fundamental emission stays within the authorized frequency block. The frequency stability of the transmitter shall be maintained within $\pm 0.00025\%$ ($\pm 2.5\text{ppm}$) of the center frequency.

3.8.2 Measuring Instruments

The measuring equipment is listed in the section 4 of this test report.

3.8.3 Test Procedures for Temperature Variation

1. The testing follows FCC KDB 971168 v02r02 Section 9.0.
2. The EUT was set up in the thermal chamber and connected with the system simulator.
3. With power OFF, the temperature was decreased to -30°C and the EUT was stabilized before testing. Power was applied and the maximum change in frequency was recorded within one minute.
4. With power OFF, the temperature was raised in 10°C steps up to 50°C . The EUT was stabilized at each step for at least half an hour. Power was applied and the maximum frequency change was recorded within one minute.

3.8.4 Test Procedures for Voltage Variation

1. The testing follows FCC KDB 971168 v02r02 Section 9.0.
2. The EUT was placed in a temperature chamber at $25\pm 5^{\circ}\text{C}$ and connected with the system simulator.
3. The power supply voltage to the EUT was varied from BEP to 115% of the nominal value measured at the input to the EUT.
4. The variation in frequency was measured for the worst case.

3.8.5 Test Setup

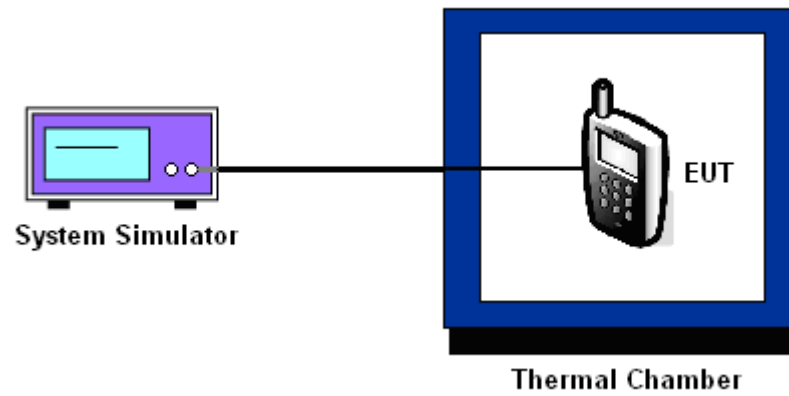



3.8.6 Test Result of Temperature Variation

Band :	GSM 850	Channel :	189
Limit (ppm) :	2.5	Frequency :	836.4 MHz

Temperature (°C)	GPRS class 8	EDGE class 8	Result
	Deviation (ppm)	Deviation (ppm)	
50	0.0048	0.0287	PASS
40	0.0060	0.0311	
30	0.0048	0.0024	
20(Ref.)	0.0000	0.0000	
10	0.0084	0.0012	
0	0.0072	0.0012	
-10	0.0096	0.0024	
-20	0.0060	0.0012	
-30	0.0024	0.0012	

Band :	GSM 1900	Channel :	661
Limit (ppm) :	within authorized band	Frequency :	1880.0 MHz

Temperature (°C)	GPRS class 8	EDGE class 8	Result
	Deviation (ppm)	Deviation (ppm)	
50	0.0170	0.0160	PASS
40	0.0181	0.0170	
30	0.0016	0.0021	
20(Ref.)	0.0000	0.0000	
10	0.0011	0.0005	
0	0.0016	0.0005	
-10	0.0048	0.0000	
-20	0.0016	0.0011	
-30	0.0027	0.0011	

Note: The frequency fundamental emissions stay within the authorized frequency block based on the frequency deviation measured is small.



Band :	WCDMA Band V	Channel :	4182
Limit (ppm) :	2.5	Frequency :	836.4 MHz

Temperature (°C)	RMC 12.2Kbps		Result
	Deviation (ppm)		
50	0.0000		PASS
40	0.0024		
30	0.0167		
20(Ref.)	0.0000		
10	0.0155		
0	0.0000		
-10	0.0012		
-20	0.0012		
-30	0.0024		

Band :	WCDMA Band II	Channel :	9400
Limit (ppm) :	within authorized band	Frequency :	1880.0 MHz

Temperature (°C)	RMC 12.2Kbps		Result
	Deviation (ppm)		
50	0.0005		PASS
40	0.0074		
30	0.0005		
20(Ref.)	0.0000		
10	0.0085		
0	0.0090		
-10	0.0000		
-20	0.0080		
-30	0.0011		

Note: The frequency fundamental emissions stay within the authorized frequency block based on the frequency deviation measured is small.



3.8.7 Test Result of Voltage Variation

Band & Channel	Mode	Voltage (Volt)	Deviation (ppm)	Limit (ppm)	Result
GSM 850 CH189	GPRS class 8	4.10	0.0060	2.5	PASS
		3.70	0.0060		
		BEP	0.0084		
	EDGE class 8	3.70	0.0012		
		BEP	0.0012		
		4.2	0.0024		
GSM 1900 CH661	GPRS class 8	3.70	0.0027	(Note 3.)	
		BEP	0.0016		
		4.2	0.0021		
	EDGE class 8	3.70	0.0165		
		BEP	0.0000		
		4.2	0.0021		
WCDMA Band V CH4182	RMC 12.2Kbps	3.70	0.0012	2.5	
		BEP	0.0024		
		4.2	0.0000		
WCDMA Band II CH9400	RMC 12.2Kbps	3.70	0.0085	(Note 3.)	
		BEP	0.0000		
		4.2	0.0096		

Note:

1. Normal Voltage = 3.70V.
2. Battery End Point (BEP) = 3.50 V.
3. The frequency fundamental emissions stay within the authorized frequency block based on the frequency deviation measured is small.



4 List of Measuring Equipment

Instrument	Manufacturer	Model No.	Serial No.	Characteristics	Calibration Date	Test Date	Due Date	Remark
Spectrum Analyzer	Rohde & Schwarz	FSP30	101329	9kHz~30GHz	Jun. 14, 2014	May 08, 2015	Jun. 13, 2015	Conducted (TH03-HY)
Temperature Chamber	ESPEC	SU-641	92013721	-30 ~70degree	Dec. 01, 2014	May 08, 2015	Nov. 30, 2015	Conducted (TH03-HY)
Base Station(Measu	Rohde & Schwarz	CMU200	117995	GSM / GPRS / WCDMA / CDMA	Jul. 29, 2014	May 08, 2015	Jul. 28, 2015	Conducted (TH03-HY)
Hygrometer	Testo	608-H1	34893241	N/A	May. 04, 2015	May 08, 2015	May. 03, 2016	Conducted (TH03-HY)
RF cable	WOKEN	S05	S05-130708-22	N/A	Jan. 21, 2015	May 08, 2015	Jan. 20, 2016	Conducted (TH03-HY)
Preamplifier	Keysight	83017A	MY53270078	1GHz~26.5GHz	Nov. 20, 2014	May 06, 2015~ May 07, 2015	Nov. 19, 2015	Radiation (03CH10-HY)
Amplifier	SONOMA	310N	187311	0.1MHz~1000MHz	Nov. 24, 2014	May 06, 2015~ May 07, 2015	Nov. 23, 2015	Radiation (03CH10-HY)
Preamplifier	MITEQ	JS44-180040 00-33-8P	1840917	18GHz ~ 40GHz	Jun. 09, 2014	May 06, 2015~ May 07, 2015	Jun. 08, 2015	Radiation (03CH10-HY)
Bilog Antenna	TESEQ	CBL 6111D	35413	30MHz~1GHz	Oct. 24, 2014	May 06, 2015~ May 07, 2015	Oct. 23, 2015	Radiation (03CH10-HY)
Double Ridged Guide Horn	SCHWARZBECK	BBHA 9120 D	9120D-1325	1GHz ~ 18GHz	Oct. 03, 2014	May 06, 2015~ May 07, 2015	Oct. 02, 2015	Radiation (03CH10-HY)
Horn Antenna	SCHWARZBECK	BBHA 9170	BBHA9170584	18GHz- 40GHz	Nov. 03, 2014	May 06, 2015~ May 07, 2015	Nov. 02, 2015	Radiation (03CH10-HY)
Spectrum Analyzer	Keysight	N9010A	MY54200485	10Hz ~ 44GHZ	Oct. 14, 2014	May 06, 2015~ May 07, 2015	Oct. 13, 2015	Radiation (03CH10-HY)
EMI Test Receiver	Keysight	N9038A	MY54130085	20Hz ~ 26.5GHz	Nov. 05, 2014	May 06, 2015~ May 07, 2015	Nov. 04, 2015	Radiation (03CH10-HY)
Controller	EMEC	EM 1000	N/A	Control Turn table & Ant Mast	N/A	May 06, 2015~ May 07, 2015	N/A	Radiation (03CH10-HY)
Turn Table	EMEC	TT 2200	N/A	0-360 degree	N/A	May 06, 2015~ May 07, 2015	N/A	Radiation (03CH10-HY)
Antenna Mast	EMEC	AM-BS-4500-B	N/A	1~4m	N/A	May 06, 2015~ May 07, 2015	N/A	Radiation (03CH10-HY)
Hygrometer	TECPEL	DTM-303B	TP140320	N/A	Nov. 17, 2014	May 06, 2015~ May 07, 2015	Nov. 16, 2015	Radiation (03CH10-HY)
RF Cable	HUBER + SUHNER	SUCOFLEX 104	MY24956/4 MY24952/4MY2	25GHz~40GHz	Nov. 06, 2014	May 06, 2015~ May 07, 2015	Nov. 05, 2015	Radiation (03CH10-HY)
RF Cable	HUBER + SUHNER	SUCOFLEX 104	MY24956/4 MY24952/4MY2	30MHz~1GHz	Nov. 06, 2014	May 06, 2015~ May 07, 2015	Nov. 05, 2015	Radiation (03CH10-HY)
RF Cable	HUBER + SUHNER	SUCOFLEX 104	MY249564 MY249524MY2	1GHz~25GHz	Nov. 06, 2014	May 06, 2015~ May 07, 2015	Nov. 05, 2015	Radiation (03CH10-HY)



5 Uncertainty of Evaluation

Uncertainty of Radiated Emission Measurement (30 MHz ~ 1000 MHz)

Measuring Uncertainty for a Level of Confidence of 95% ($U = 2Uc(y)$)	4.90
---	------