



FCC RF Test Report

APPLICANT : Sony Mobile Communications Inc.
EQUIPMENT : Smart phone
BRAND NAME : SONY
TYPE NAME : PM-0891-BV
FCC ID : PY7-PM0891
STANDARD : 47 CFR Part 2, 22(H), 27
CLASSIFICATION : PCS Licensed Transmitter Held to Ear (PCE)

The product was received on Apr. 29, 2015 and completely tested on May 08, 2015. We, SPORTON INTERNATIONAL INC., would like to declare that the tested sample has been evaluated in accordance with the test procedures given in ANSI / TIA / EIA-603-C-2004 and the testing has shown the tested sample to be in compliance with the applicable technical standards.

The test results in this report apply exclusively to the tested model / sample. Without written approval of SPORTON INTERNATIONAL INC., the test report shall not be reproduced except in full.

Reviewed by: Joseph Lin / Supervisor

Approved by: Jones Tsai / Manager



SPORTON INTERNATIONAL INC.

No. 52, Hwa Ya 1st Rd., Hwa Ya Technology Park, Kwei-Shan District, Tao Yuan City, Taiwan, R.O.C.



TABLE OF CONTENTS

REVISION HISTORY..... 3
SUMMARY OF TEST RESULT 4
1 GENERAL DESCRIPTION 5
1.1 Applicant 5
1.2 Manufacturer 5
1.3 Product Feature of Equipment Under Test..... 5
1.4 Product Specification subjective to this standard 7
1.5 Modification of EUT 7
1.6 Emission Designator 7
1.7 Testing Location 8
1.8 Applicable Standards 8
2 TEST CONFIGURATION OF EQUIPMENT UNDER TEST 9
2.1 Test Mode 9
2.2 Connection Diagram of Test System 10
2.3 Support Unit used in test configuration and system 10
2.4 Measurement Results Explanation Example 10
3 CONDUCTED TEST ITEMS 11
3.1 Measuring Instruments 11
3.2 Test Setup 11
3.3 Test Result of Conducted Test 11
3.4 Conducted Output Power 12
3.5 Peak-to-Average Ratio 13
3.6 Occupied Bandwidth 14
3.7 Conducted Band Edge 15
3.8 Conducted Spurious Emission 16
3.9 Frequency Stability 17
4 RADIATED TEST ITEMS 18
4.1 Measuring Instruments 18
4.2 Test Setup 18
4.3 Test Result of Radiated Test 18
4.4 Effective Radiated Power and Effective Isotropic Radiated Power 19
4.5 Radiated Spurious Emission 21
5 LIST OF MEASURING EQUIPMENT 22
6 UNCERTAINTY OF EVALUATION 23
APPENDIX A. TEST RESULTS OF CONDUCTED TEST
APPENDIX B. TEST RESULTS OF RADIATED TEST



REVISION HISTORY

REPORT NO.	VERSION	DESCRIPTION	ISSUED DATE
FG542942B	Rev. 01	Initial issue of report	Jul. 06, 2015



SUMMARY OF TEST RESULT

Report Section	FCC Rule	Description	Limit	Result	Remark
3.4	§2.1046	Conducted Output Power	Reporting Only	PASS	-
3.5	N/A	Peak-to-Average Ratio	<13 dB	PASS	-
3.6	§2.1049	Occupied Bandwidth	Reporting Only	PASS	-
3.7	§2.1051 §22.917(a) §27.53(m)(4)	Conducted Band Edge Measurement (Band 5) (Band 7)	< 43+10log ₁₀ (P[Watts])	PASS	-
3.8	§2.1051 §22.917(a)	Conducted Spurious Emission (Band 5)	< 43+10log ₁₀ (P[Watts])	PASS	-
	§2.1051 §27.53(m)(4)	Conducted Spurious Emission (Band 7)	< 55+10log ₁₀ (P[Watts])		
3.9	§2.1055 §22.355 §27.54	Frequency Stability Temperature & Voltage	< 2.5 ppm for Part 22 Within Authorized Band	PASS	-
4.4	§22.913(a)(2)	Effective Radiated Power (Band 5)	ERP < 7 Watt	PASS	-
	§24.232(c) §27.50(h)(2)	Equivalent Isotropic Radiated Power (Band 7)	EIRP < 2Watt		
4.5	§2.1053 §22.917(a)	Radiated Spurious Emission (Band 5)	< 43+10log ₁₀ (P[Watts])	PASS	Under limit 8.71 dB at 10224.000 MHz
	§2.1053 §27.53(m)(4)	Radiated Spurious Emission (Band 7)	< 55+10log ₁₀ (P[Watts])		



1 General Description

1.1 Applicant

Sony Mobile Communications Inc.
Nya Vattentorget, 22188 Lund, Sweden

1.2 Manufacturer

Arima Communications Corp.
6F,No.866,Jhongjheng Rd., Jhonghe Dist., New Taipei City 23586, Taiwan

1.3 Product Feature of Equipment Under Test

The Equipment Under Test (hereafter called: EUT) is smart phone supporting, GSM/WCDMA/LTE, Wi-Fi 2.4GHz 802.11b/g/n, Wi-Fi 5GHz 802.11a/n, Bluetooth with FM Receiver, GPS, and NFC features, and below is details of information.

Product Feature	
Equipment	Smart phone
Brand Name	SONY
Type Name	PM-0891-BV
FCC ID	PY7-PM0891
GSM Operating Band(s)	GSM 850/900/1800/1900MHz
GPRS / EGPRS Multi Slot Class	GPRS Class 12, EGPRS Class 12
WCDMA Operating Band(s)	FDD Band I / II / V / VIII
WCDMA Rel. Version	Rel. 8
LTE Operating Band(s)	FDD Band I / III / V / VII / VIII / XXVIII TDD Band XL
LTE Rel. Version	Rel. 8
Wi-Fi Specification	802.11a/b/g/n (HT20/HT40)
Bluetooth Version	v3.0+EDR / v4.0-LE
NFC Specification	ISO14443A / ISO14443B / Felica
Power Supply	Battery / AC Adapter/Car Charger

Remark: The above EUT's information was declared by manufacturer. Please refer to the specifications or user's manual for more detailed description.



Below EUT sample and accessory are used to test.

EUT Information List				
IMEI	HW Version	SW Version	S/N	Performed Test Item
IMEI 1: 004402454617261	A	29.0.B.0.76	WUJ01HWJMW	RF conducted measurement
IMEI 2: 004402454617279				Radiated Spurious Emission

Accessory List	
Adapter	Model No. : EP800
	Type No. : CAA-0002016-US B
	S/N : 3113W 45 108550
Battery	Model No. : LIS1579ERPC
Earphone 1	Model No. : MH410c
	Type No. : AG-1100
	S/N : 14341EB00068DB2
Earphone 2	Model No. : MH410c
	Type No. : AG-1103
	S/N : 142820450123D30
USB Cable	Model No. : EC450
	Type No. : AI-0700
	S/N : 134912D70008842

Note:

1. Above EUT list and accessory list used are electrically identical per declared by manufacturer.
2. Above the accessories list are used to exercise the EUT during test.
3. For other wireless features of this EUT, test report will be issued separately.



1.4 Product Specification subjective to this standard

Product Specification subjective to this standard	
Tx Frequency	LTE Band 5 : 824.7 MHz ~ 848.3 MHz LTE Band 7 : 2502.5 MHz ~ 2567.5 MHz
Rx Frequency	LTE Band 5 : 869.7 MHz ~ 893.3 MHz LTE Band 7 : 2622.5MHz ~ 2687.5 MHz
Bandwidth	LTE Band 5 : 1.4MHz / 3MHz / 5MHz / 10MHz LTE Band 7 : 5MHz/ 10MHz / 15MHz / 20MHz
Maximum Output Power to Antenna	LTE Band 5 : 22.97 dBm LTE Band 7 : 22.55 dBm
Type of Modulation	QPSK / 16QAM

1.5 Modification of EUT

No modifications are made to the EUT during all test items.

1.6 Emission Designator

LTE Band 5	QPSK			16QAM		
BW(MHz)	Emission Designator (99%OBW)	Frequency Tolerance (ppm)	Maximum ERP(W)	Emission Designator (99%OBW)	Frequency Tolerance (ppm)	Maximum ERP(W)
1.4	1M09G7D		0.0543	1M10W7D		0.0429
3	2M73G7D		0.0512	2M73W7D		0.0442
5	4M52G7D		0.0514	4M51W7D		0.0444
10	9M11G7D	0.0134	0.0519	9M05W7D		0.0440
LTE Band 7	QPSK			16QAM		
BW(MHz)	Emission Designator (99%OBW)	Frequency Tolerance (ppm)	Maximum EIRP(W)	Emission Designator (99%OBW)	Frequency Tolerance (ppm)	Maximum EIRP(W)
5	4M51G7D		0.1413	4M51W7D		0.1119
10	9M09G7D		0.1449	9M05W7D		0.1096
15	13M5G7D		0.1483	13M5W7D		0.1107
20	18M5G7D	0.0058	0.1493	18M6W7D		0.1122



1.7 Testing Location

Sporton Lab is accredited to ISO 17025 by Taiwan Accreditation Foundation (TAF code : 1190) and the FCC designation No. TW1022 under the FCC 2.948(e) by Mutual Recognition Agreement (MRA) in FCC Test.

Test Site	SPORTON INTERNATIONAL INC.
Test Site Location	No. 52, Hwa Ya 1 st Rd., Hwa Ya Technology Park, Kwei-Shan District, Tao Yuan City, Taiwan, R.O.C. TEL: +886-3-327-3456 FAX: +886-3-328-4978
Test Site No.	Sporton Site No. TH03-HY

Test Site	SPORTON INTERNATIONAL INC.
Test Site Location	No.58, Aly. 75, Ln. 564, Wenhua 3rd Rd. Kwei-Shan District, Tao Yuan City, Taiwan (R.O.C.) TEL: +886-3-327-0855
Test Site No.	Sporton Site No. 03CH10-HY

1.8 Applicable Standards

According to the specifications of the manufacturer, the EUT must comply with the requirements of the following standards:

- ♦ 47 CFR Part 2, 22(H), 27
- ♦ ANSI / TIA / EIA-603-C-2004
- ♦ FCC KDB 971168 D01 Power Meas. License Digital Systems v02r02

Remark:

1. All test items were verified and recorded according to the standards and without any deviation during the test.
2. This EUT has also been tested and complied with the requirements of FCC Part 15, Subpart B, recorded in a separate test report.



2 Test Configuration of Equipment Under Test

2.1 Test Mode

Antenna port conducted and radiated test items listed below are performed according to KDB 971168 D01 Power Meas. License Digital Systems v02r02 with maximum output power.

Radiated measurements are performed by rotating the EUT in three different orthogonal test planes to find the maximum emission.

Test Items	Band	Bandwidth (MHz)						Modulation		RB #			Test Channel		
		1.4	3	5	10	15	20	QPSK	16QAM	1	Half	Full	L	M	H
Max. Output Power	5	√	√	√	√	-	-	√	√	√	√	√	√	√	√
	7	-	-	√	√	√	√	√	√	√	√	√	√	√	√
Peak-to-Average Ratio	5				√	-	-	√	√	√		√	√	√	√
	7	-	-				√	√	√	√		√	√	√	√
26dB and 99% Bandwidth	5	√	√	√	√	-	-	√	√			√	√	√	√
	7	-	-	√	√	√	√	√	√			√	√	√	√
Conducted Band Edge	5	√	√	√	√	-	-	√	√	√		√	√		√
	7	-	-	√	√	√	√	√	√	√		√	√		√
Conducted Spurious Emission	5	√	√	√	√	-	-	√	√	√			√	√	√
	7	-	-	√	√	√	√	√	√	√			√	√	√
Frequency Stability	5				√	-	-	√				√		√	
	7	-	-		√			√				√		√	
E.R.P./ E.I.R.P.	5	√	√	√	√	-	-	√	√	√			√	√	√
	7	-	-	√	√	√	√	√	√	√			√	√	√
Radiated Spurious Emission	5	√	√	√	√	-	-	√		√			√	√	√
	7	-	-	√	√	√	√	√		√			√	√	√
Note	<ol style="list-style-type: none"> The mark "√" means that this configuration is chosen for testing The mark "-" means that this bandwidth is not supported. The device is investigated from 30MHz to 10 times of fundamental signal for radiated spurious emission test under different RB size/offset and modulations in exploratory test. Subsequently, only the worst case emissions are reported. For radiated spurious emission, the tests were performed with Adapter, Battery, Earphone 1, USB Cable, and SIM 1. 														

2.2 Connection Diagram of Test System

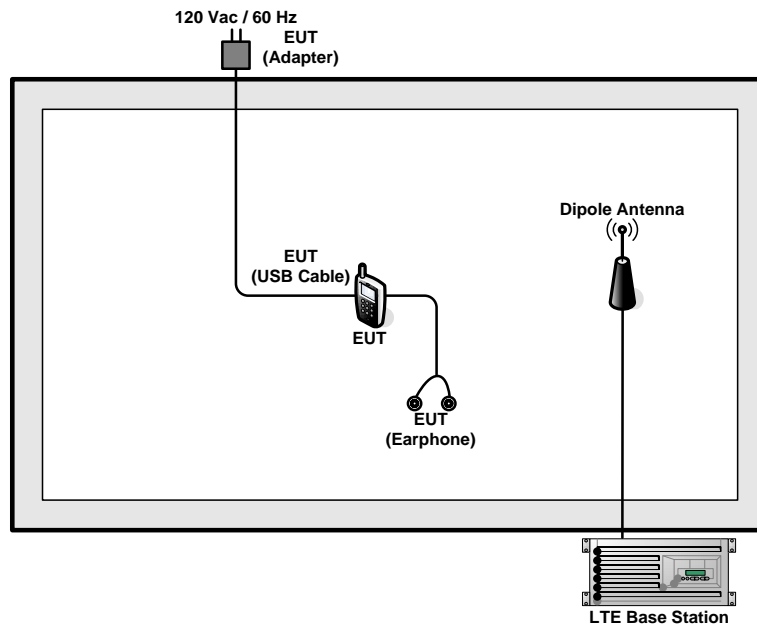

2.3 Support Unit used in test configuration and system

Item	Equipment	Trade Name	Model No.	FCC ID	Data Cable	Power Cord
1.	System Simulator	Anritsu	MT8820C	N/A	N/A	Unshielded, 1.8 m

2.4 Measurement Results Explanation Example

For all conducted test items:

The offset level is set in the spectrum analyzer to compensate the RF cable loss and attenuator factor between EUT conducted output port and spectrum analyzer. With the offset compensation, the spectrum analyzer reading level is exactly the EUT RF output level.

The spectrum analyzer offset is derived from RF cable loss and attenuator factor.

Offset = RF cable loss + attenuator factor.

Following shows an offset computation example with cable loss 4.2 dB and 10dB attenuator.

Example :

$$\begin{aligned} \text{Offset(dB)} &= \text{RF cable loss(dB)} + \text{attenuator factor(dB)} \\ &= 4.2 + 10 = 14.2 \text{ (dB)} \end{aligned}$$

3 Conducted Test Items

3.1 Measuring Instruments

See list of measuring instruments of this test report.

3.2 Test Setup

3.2.1 Conducted Output Power



3.2.2 Peak-to-Average Ratio, Occupied Bandwidth ,Conducted Band-Edge and Conducted Spurious Emission

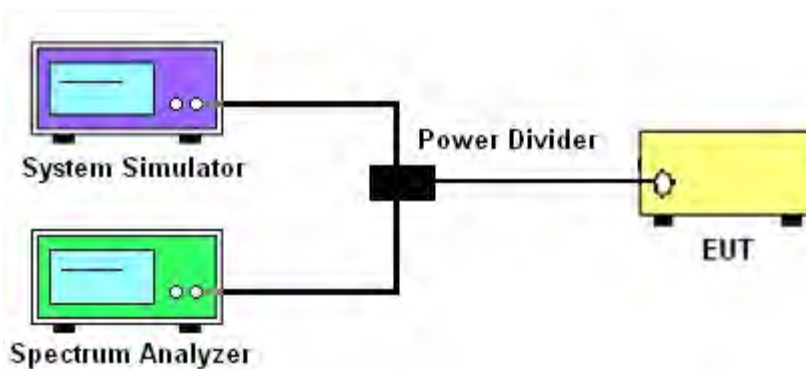

3.2.3 Frequency Stability

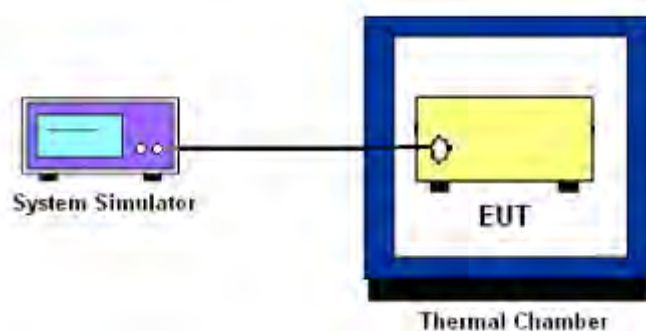

3.3 Test Result of Conducted Test

Please refer to Appendix A.



3.4 Conducted Output Power

3.4.1 Description of the Conducted Output Power Measurement

A system simulator was used to establish communication with the EUT. Its parameters were set to force the EUT transmitting at maximum output power. The measured power in the radio frequency on the transmitter output terminals shall be reported.

3.4.2 Test Procedures

1. The transmitter output port was connected to the system simulator.
2. Set EUT at maximum power through the system simulator.
3. Select lowest, middle, and highest channels for each band and different modulation.
4. Measure and record the power level from the system simulator.



3.5 Peak-to-Average Ratio

3.5.1 Description of the PAR Measurement

Power Complementary Cumulative Distribution Function (CCDF) curves provide a means for characterizing the power peaks of a digitally modulated signal on a statistical basis. A CCDF curve depicts the probability of the peak signal amplitude exceeding the average power level. Most contemporary measurement instrumentation include the capability to produce CCDF curves for an input signal provided that the instrument's resolution bandwidth can be set wide enough to accommodate the entire input signal bandwidth. In measuring transmissions in this band using an average power technique, the peak-to-average ratio (PAR) of the transmission may not exceed 13 dB.

3.5.2 Test Procedures

1. The testing follows FCC KDB 971168 v02r02 Section 5.7.1.
2. The EUT was connected to spectrum and system simulator via a power divider.
3. Set the CCDF (Complementary Cumulative Distribution Function) option in spectrum analyzer.
4. The highest RF powers were measured and recorded the maximum PAPR level associated with a probability of 0.1 %.
5. Record the deviation as Peak to Average Ratio.



3.6 Occupied Bandwidth

3.6.1 Description of Occupied Bandwidth Measurement

The occupied bandwidth is the width of a frequency band such that, below the lower and above the upper frequency limits, the mean powers emitted are each equal to a specified percentage 0.5% of the total mean transmitted power.

The 26 dB emission bandwidth is defined as the frequency range between two points, one above and one below the carrier frequency, at which the spectral density of the emission is attenuated 26 dB below the maximum in-band spectral density of the modulated signal. Spectral density (power per unit bandwidth) is to be measured with a detector of resolution bandwidth equal to approximately 1.0% of the emission bandwidth.

3.6.2 Test Procedures

1. The testing follows FCC KDB 971168 v02r02 Section 4.2.
2. The EUT was connected to spectrum analyzer and system simulator via a power divider.



3.7 Conducted Band Edge

3.7.1 Description of Conducted Band Edge Measurement

22.917(a)

For operations in the 824 – 849 MHz band, the FCC limit is $43 + 10\log_{10}(P[\text{Watts}])$ dB below the transmitter power P(Watts) in a 100kHz bandwidth. However, in the 1MHz bands immediately outside and adjacent to the licensee's frequency block, a resolution bandwidth of at least one percent of the emission bandwidth of the fundamental emission of the transmitter may be employed.

27.53(m)(4)

For mobile digital stations, the attenuation factor shall be not less than $40 + 10 \log (P)$ dB on all frequencies between the channel edge and 5 megahertz from the channel edge, $43 + 10 \log (P)$ dB on all frequencies between 5 megahertz and X megahertz from the channel edge, and $55 + 10 \log (P)$ dB on all frequencies more than X megahertz from the channel edge, where X is the greater of 6 megahertz or the actual emission bandwidth as defined in paragraph (m)(6) of this section. In addition, the attenuation factor shall not be less that $43 + 10 \log (P)$ dB on all frequencies between 2490.5 MHz and 2496 MHz and $55 + 10 \log (P)$ dB at or below 2490.5 MHz. Mobile Satellite Service licensees operating on frequencies below 2495 MHz may also submit a documented interference complaint against BRS licensees operating on channel BRS Channel 1 on the same terms and conditions as adjacent channel BRS or EBS licensees.

3.7.2 Test Procedures

1. The testing follows FCC KDB 971168 v02r02 Section 6.0.
2. The EUT was connected to spectrum analyzer and system simulator via a power divider.
3. The band edges of low and high channels for the highest RF powers were measured. Set RBW $\geq 1\%$ EBW in the 1MHz band immediately outside and adjacent to the band edge.
4. Set spectrum analyzer with RMS detector.
5. The RF fundamental frequency should be excluded against the limit line in the operating frequency band.
6. The limit line is derived from $43 + 10\log(P)$ dB below the transmitter power P(Watts)
 $= P(W) - [43 + 10\log(P)]$ (dB)
 $= [30 + 10\log(P)]$ (dBm) - $[43 + 10\log(P)]$ (dB)
 $= -13\text{dBm}$.



3.8 Conducted Spurious Emission

3.8.1 Description of Conducted Spurious Emission Measurement

For Band 5

The power of any emission outside of the authorized operating frequency ranges must be lower than the transmitter power (P) by a factor of at least $43 + 10 \log (P)$ dB.

For Band 7

The power of any emission outside of the authorized operating frequency ranges must be lower than the transmitter power (P) by a factor of at least $55 + 10 \log (P)$ dB.

It is measured by means of a calibrated spectrum analyzer and scanned from 30 MHz up to a frequency including its 10th harmonic.

3.8.2 Test Procedures

1. The testing follows FCC KDB 971168 v02r02 Section 6.0.
2. The EUT was connected to spectrum analyzer and system simulator via a power divider.
3. The RF output of EUT was connected to the spectrum analyzer by RF cable and attenuator. The path loss was compensated to the results for each measurement.
4. The middle channel for the highest RF power within the transmitting frequency was measured.
5. The conducted spurious emission for the whole frequency range was taken.
6. Make the measurement with the spectrum analyzer's RBW = 1MHz, VBW = 3MHz, taking the record of maximum spurious emission.
7. The RF fundamental frequency should be excluded against the limit line in the operating frequency band.
8. The limit line is derived from $43 + 10\log(P)$ dB below the transmitter power P(Watts)
 $= P(W) - [43 + 10\log(P)]$ (dB)
 $= [30 + 10\log(P)]$ (dBm) - $[43 + 10\log(P)]$ (dB)
 $= -13$ dBm.
For Band 7
9. The limit line is derived from $55 + 10\log(P)$ dB below the transmitter power P(Watts)



3.9 Frequency Stability

3.9.1 Description of Frequency Stability Measurement

The frequency stability shall be measured by variation of ambient temperature and variation of primary supply voltage to ensure that the fundamental emission stays within the authorized frequency block. The frequency stability of the transmitter shall be maintained within $\pm 0.00025\%$ ($\pm 2.5\text{ppm}$) of the center frequency.

3.9.2 Test Procedures for Temperature Variation

1. The EUT was set up in the thermal chamber and connected with the system simulator.
2. With power OFF, the temperature was decreased to -30°C and the EUT was stabilized before testing. Power was applied and the maximum change in frequency was recorded within one minute.
3. With power OFF, the temperature was raised in 10°C step up to 50°C . The EUT was stabilized at each step for at least half an hour. Power was applied and the maximum frequency change was recorded within one minute.

3.9.3 Test Procedures for Voltage Variation

1. The testing follows FCC KDB 971168 v02r02 Section 9.0.
2. The EUT was placed in a temperature chamber at $25\pm 5^{\circ}\text{C}$ and connected with the system simulator.
3. The power supply voltage to the EUT was varied from 85% to 115% of the nominal value measured at the input to the EUT.
4. The variation in frequency was measured for the worst case.

4 Radiated Test Items

4.1 Measuring Instruments

See list of measuring instruments of this test report.

4.2 Test Setup

4.2.1 For radiated test from 30MHz to 1GHz

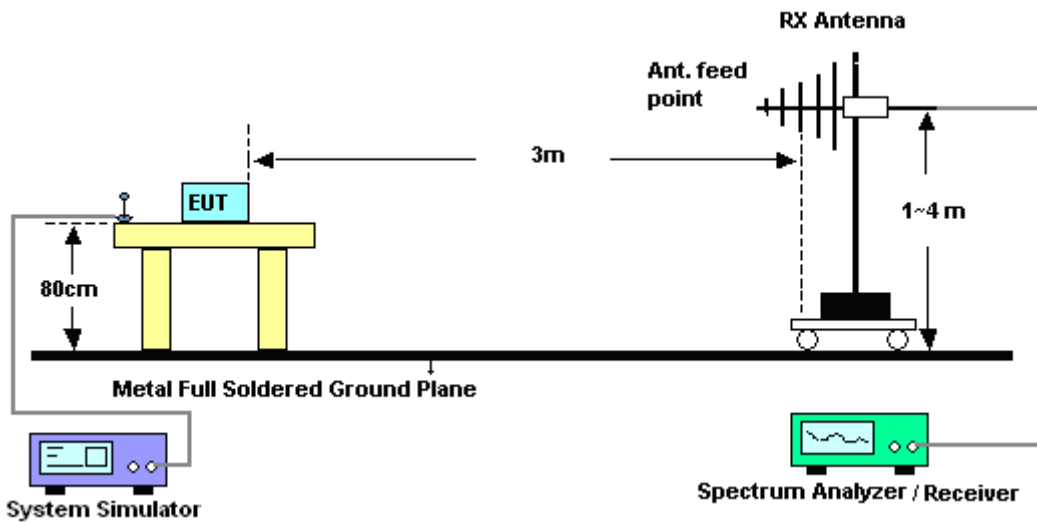

4.2.2 For radiated test above 1GHz

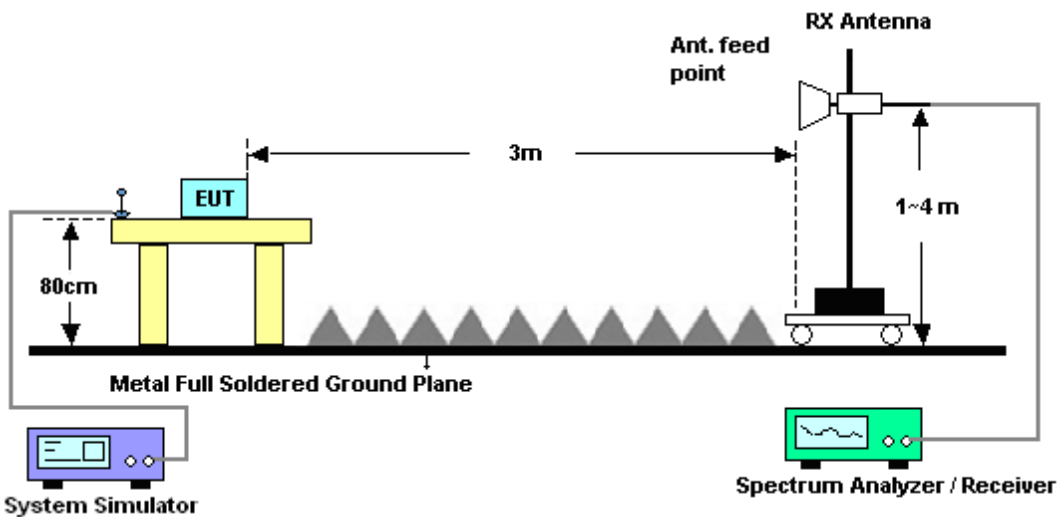

4.3 Test Result of Radiated Test

Please refer to Appendix B.



4.4 Effective Radiated Power and Effective Isotropic Radiated Power

4.4.1 Description of the ERP/EIRP Measurement

Effective radiated power output measurements by substitution method according to ANSI / TIA / EIA-603-C-2004, and the spectrum analyzer configuration follows KDB 971168 D01 Power Meas. License Digital Systems v02r02. Mobile and portable (hand-held) stations operating are limited to average ERP of 7 watts with LTE band 5.

Equivalent isotropic radiated power output measurements by substitution method according to ANSI / TIA / EIA-603-C-2004, and the spectrum analyzer configuration follows KDB 971168 D01 Power Meas. License Digital Systems v02r02. Mobile and portable (hand-held) stations operating are limited to average EIRP of 2 watts with LTE band 7.

4.4.2 Test Procedures

1. The EUT was placed on a non-conductive rotating platform 0.8 meters high in a semi-anechoic chamber. The radiated emission at the fundamental frequency was measured at 3 m with a test antenna and a spectrum analyzer with RMS detector per section 5. of KDB 971168 D01.
2. During the measurement, the system simulator parameters were set to force the EUT transmitting at maximum output power. The maximum emission was recorded from analyzer power level (LVL) from the 360 degrees rotation of the turntable and the test antenna raised and lowered over a range from 1 to 4 meters in both horizontally and vertically polarized orientations.
3. Effective Isotropic Radiated Power (EIRP) was measured by substitution method according to TIA/EIA-603-C. The EUT was replaced by the substitution antenna at same location, and then a known power from S.G. was applied into the dipole antenna through a Tx cable, and then recorded the maximum Analyzer reading through raised and lowered the test antenna. The correction factor (in dB) = S.G. - Tx Cable loss + Substitution antenna gain - Analyzer reading. Then the EUT's EIRP was calculated with the correction factor, $EIRP = LVL + \text{Correction factor}$ and $ERP = EIRP - 2.15$. Take the record of the output power at substitution antenna.



	LTE					
LTE BW	1.4M	3M	5M	10M	15M	20M
Span	3MHz	6MHz	10MHz	20MHz	30MHz	40MHz
RBW	30kHz	100kHz	100kHz	300kHz	300kHz	300kHz
VBW	100kHz	300kHz	300kHz	1MHz	1MHz	1MHz
Detector	RMS	RMS	RMS	RMS	RMS	RMS
Trace	Average	Average	Average	Average	Average	Average
Average Type	Power	Power	Power	Power	Power	Power
Sweep Count	100	100	100	100	100	100



4.5 Radiated Spurious Emission

4.5.1 Description of Radiated Spurious Emission

The radiated spurious emission was measured by substitution method according to ANSI / TIA / EIA-603-C-2004. The power of any emission outside of the authorized operating frequency ranges must be attenuated below the transmitter power (P) by a factor of at least $43 + 10 \log (P)$ dB.

For Band 7

The power of any emission outside of the authorized operating frequency ranges must be attenuated below the transmitter power (P) by a factor of at least $55 + 10 \log (P)$ dB.

The spectrum is scanned from 30 MHz up to a frequency including its 10th harmonic.

4.5.2 Test Procedures

1. The testing follows FCC KDB 971168 v02r02 Section 5.8 and ANSI / TIA-603-C-2004 Section 2.2.12.
2. The EUT was placed on a rotatable wooden table with 0.8 meter above ground.
3. The EUT was set 3 meters from the receiving antenna, which was mounted on the antenna tower.
4. The table was rotated 360 degrees to determine the position of the highest spurious emission.
5. The height of the receiving antenna is varied between one meter and four meters to search the maximum spurious emission for both horizontal and vertical polarizations.
6. Make the measurement with the spectrum analyzer's RBW = 1MHz, VBW = 3MHz, taking the record of maximum spurious emission.
7. A horn antenna was substituted in place of the EUT and was driven by a signal generator.
8. Tune the output power of signal generator to the same emission level with EUT maximum spurious emission.
9. Taking the record of output power at antenna port.
10. Repeat step 7 to step 8 for another polarization.
11. The RF fundamental frequency should be excluded against the limit line in the operating frequency band.

The limit line is derived from $43 + 10\log(P)$ dB below the transmitter power P(Watts)
= $P(W) - [43 + 10\log(P)]$ (dB)
= $[30 + 10\log(P)]$ (dBm) - $[43 + 10\log(P)]$ (dB)
= -13dBm.

The limit line is derived from $55 + 10\log(P)$ dB below the transmitter power P(Watts)

12. EIRP (dBm) = S.G. Power – Tx Cable Loss + Tx Antenna Gain
 13. ERP (dBm) = EIRP - 2.15
- For Band 7:

14. The limit line is derived from $55 + 10\log(P)$ dB below the transmitter power P(Watts)



5 List of Measuring Equipment

Instrument	Manufacturer	Model No.	Serial No.	Characteristics	Calibration Date	Test Date	Due Date	Remark
Spectrum Analyzer	Rohde & Schwarz	FSP30	101329	9kHz~30GHz	Jun. 14, 2014	May 03, 2015~ May 08, 2015	Jun. 13, 2015	Conducted (TH03-HY)
Temperature Chamber	ESPEC	SU-641	92013721	-30°~70°	Dec. 01, 2014	May 03, 2015~ May 08, 2015	Nov. 30, 2015	Conducted (TH03-HY)
Hygrometer	Testo	608-H1	34893241	N/A	May 04, 2015	May 03, 2015~ May 08, 2015	May 03, 2016	Conducted (TH03-HY)
RF cable	WOKEN	S05	S05-130708-2 2	N/A	Jan. 21, 2015	May 03, 2015~ May 08, 2015	Jan. 20, 2016	Conducted (TH03-HY)
Preamplifier	Keysight	83017A	MY53270078	1GHz~26.5GHz	Nov. 20, 2014	May 04, 2015~ May 07, 2015	Nov. 19, 2015	Radiation (03CH10-HY)
Amplifier	SONOMA	310N	187311	0.1MHz~1000MHz	Nov. 24, 2014	May 04, 2015~ May 07, 2015	Nov. 23, 2015	Radiation (03CH10-HY)
Preamplifier	MITEQ	JS44-18004 000-33-8P	1840917	18GHz ~ 40GHz	Jun. 09, 2014	May 04, 2015~ May 07, 2015	Jun. 08, 2015	Radiation (03CH10-HY)
Bilog Antenna	TESEQ	CBL 6111D	35413	30MHz~1GHz	Oct. 24, 2014	May 04, 2015~ May 07, 2015	Oct. 23, 2015	Radiation (03CH10-HY)
Double Ridged Guide Horn	SCHWARZBECK	BBHA 9120 D	9120D-1325	1GHz ~ 18GHz	Oct. 03, 2014	May 04, 2015~ May 07, 2015	Oct. 02, 2015	Radiation (03CH10-HY)
Horn Antenna	SCHWARZBECK	BBHA 9170	BBHA9170584	18GHz- 40GHz	Nov. 03, 2014	May 04, 2015~ May 07, 2015	Nov. 02, 2015	Radiation (03CH10-HY)
Spectrum Analyzer	Keysight	N9010A	MY54200485	10Hz ~ 44GHZ	Oct. 14, 2014	May 04, 2015~ May 07, 2015	Oct. 13, 2015	Radiation (03CH10-HY)
EMI Test Receiver	Keysight	N9038A	MY54130085	20Hz ~ 26.5GHz	Nov. 05, 2014	May 04, 2015~ May 07, 2015	Nov. 04, 2015	Radiation (03CH10-HY)
Turn Table	EMEC	TT 2200	N/A	0-360 degree	N/A	May 04, 2015~ May 07, 2015	N/A	Radiation (03CH10-HY)
Antenna Mast	EMEC	AM-BS-450 0-B	N/A	1~4m	N/A	May 04, 2015~ May 07, 2015	N/A	Radiation (03CH10-HY)
Hygrometer	TECPEL	DTM-303B	TP140320	N/A	Nov. 17, 2014	May 04, 2015~ May 07, 2015	Nov. 16, 2015	Radiation (03CH10-HY)
RF Cable	HUBER + SUHNER	SUCOFLEX 104	MY24956/4 MY24952/4MY 28386/4	25GHz~40GHz	Nov. 06, 2014	May 04, 2015~ May 07, 2015	Nov. 05, 2015	Radiation (03CH10-HY)
RF Cable	HUBER + SUHNER	SUCOFLEX 104	MY24956/4 MY24952/4MY 28386/4	30MHz~1GHz	Nov. 06, 2014	May 04, 2015~ May 07, 2015	Nov. 05, 2015	Radiation (03CH10-HY)
RF Cable	HUBER + SUHNER	SUCOFLEX 104	MY249564 MY249524MY 283864	1GHz~25GHz	Nov. 06, 2014	May 04, 2015~ May 07, 2015	Nov. 05, 2015	Radiation (03CH10-HY)
Test Software	Audix	E3	6.2009-8-24	N/A	N/A	May 04, 2015~ May 07, 2015	N/A	Radiation (03CH10-HY)



6 Uncertainty of Evaluation

Uncertainty of Radiated Emission Measurement (30 MHz ~ 1000 MHz)

Measuring Uncertainty for a Level of Confidence of 95% ($U = 2Uc(y)$)	2.54
---	------

Uncertainty of Radiated Emission Measurement (1 GHz ~ 40 GHz)

Measuring Uncertainty for a Level of Confidence of 95% ($U = 2Uc(y)$)	4.72
---	------



Appendix A. Test Results of Conducted Test

Conducted Output Power(Average power)

LTE Band 5 Maximum Average Power [dBm]						
BW [MHz]	RB Size	RB Offset	Mod	Lowest	Middle	Highest
1.4	1	0	QPSK	22.64	22.75	22.83
1.4	1	2		22.54	22.67	22.77
1.4	1	5		22.53	22.65	22.72
1.4	3	0		22.65	22.77	22.87
1.4	3	1		22.61	22.74	22.83
1.4	3	2		22.60	22.73	22.82
1.4	6	0		21.69	21.73	21.84
1.4	1	0	16-QAM	21.58	21.76	21.83
1.4	1	2		21.68	21.87	21.89
1.4	1	5		21.57	21.74	21.75
1.4	3	0		21.73	21.86	21.94
1.4	3	1		21.70	21.84	21.91
1.4	3	2		21.68	21.81	21.89
1.4	6	0		20.80	20.93	20.99
3	1	0	QPSK	22.62	22.75	22.84
3	1	7		22.55	22.66	22.77
3	1	14		22.49	22.63	22.69
3	8	0		21.72	21.81	21.91
3	8	4		21.72	21.76	21.91
3	8	7		21.69	21.74	21.89
3	15	0		21.68	21.75	21.87
3	1	0	16-QAM	21.57	21.74	21.83
3	1	7		21.63	21.80	21.91
3	1	14		21.57	21.72	21.76
3	8	0		20.80	20.92	20.99
3	8	4		20.79	20.93	20.98
3	8	7		20.78	20.91	20.97
3	15	0		20.71	20.81	20.96



LTE Band 5 Maximum Average Power [dBm]						
BW [MHz]	RB Size	RB Offset	Mod	Lowest	Middle	Highest
5	1	0	QPSK	22.63	22.79	22.91
5	1	12		22.62	22.78	22.79
5	1	24		22.61	22.64	22.72
5	12	0		21.74	21.76	21.93
5	12	6		21.73	21.81	21.93
5	12	11		21.71	21.80	21.94
5	25	0		21.69	21.71	21.85
5	1	0	16-QAM	21.66	21.85	21.96
5	1	12		21.70	21.88	21.85
5	1	24		21.68	21.72	21.77
5	12	0		20.77	20.90	20.99
5	12	6		20.77	20.92	20.97
5	12	11		20.79	20.92	20.97
5	25	0		20.71	20.82	20.97
10	1	0	QPSK	22.34	22.95	22.97
10	1	24		22.29	22.93	22.95
10	1	49		22.33	22.90	22.91
10	25	0		21.00	21.77	21.80
10	25	12		21.09	21.76	21.80
10	25	24		21.12	21.74	21.84
10	50	0		21.54	21.72	21.81
10	1	0	16-QAM	21.67	21.83	21.77
10	1	24		21.95	21.84	21.83
10	1	49		21.99	21.74	21.77
10	25	0		20.74	20.82	20.87
10	25	12		20.77	20.87	20.89
10	25	24		20.84	20.83	20.92
10	50	0		20.80	20.83	20.87



LTE Band 7 Maximum Average Power [dBm]						
BW [MHz]	RB Size	RB Offset	Mod	Lowest	Middle	Highest
5	1	0	QPSK	22.15	22.42	22.48
5	1	12		22.13	22.41	22.47
5	1	24		22.00	22.35	22.41
5	12	0		21.21	21.45	21.53
5	12	6		21.20	21.45	21.50
5	12	11		21.17	21.45	21.52
5	25	0		21.14	21.40	21.59
5	1	0	16-QAM	21.28	21.52	21.57
5	1	12		21.29	21.57	21.63
5	1	24		21.19	21.51	21.50
5	12	0		20.16	20.42	20.51
5	12	6		20.16	20.43	20.50
5	12	11		20.17	20.44	20.52
5	25	0		20.12	20.39	20.46
10	1	0	QPSK	22.14	22.45	22.52
10	1	24		22.12	22.36	22.41
10	1	49		22.04	22.37	22.37
10	25	0		21.15	21.41	21.46
10	25	12		21.11	21.44	21.50
10	25	24		21.12	21.48	21.51
10	50	0		21.16	21.45	21.52
10	1	0	16-QAM	21.28	21.51	21.59
10	1	24		21.27	21.59	21.63
10	1	49		21.26	21.56	21.57
10	25	0		20.13	20.39	20.49
10	25	12		20.09	20.41	20.47
10	25	24		20.10	20.45	20.49
10	50	0		20.14	20.42	20.50



LTE Band 7 Maximum Average Power [dBm]						
BW [MHz]	RB Size	RB Offset	Mod	Lowest	Middle	Highest
15	1	0	QPSK	22.47	22.46	22.53
15	1	37		22.36	22.37	22.52
15	1	74		22.30	22.26	22.47
15	36	0		21.63	21.44	21.57
15	36	18		21.49	21.51	21.61
15	36	37		21.40	21.54	21.60
15	75	0		21.26	21.49	21.58
15	1	0	16-QAM	21.48	21.48	21.67
15	1	37		21.39	21.62	21.73
15	1	74		21.40	21.65	21.65
15	36	0		20.26	20.41	20.55
15	36	18		20.25	20.49	20.59
15	36	37		20.26	20.51	20.59
15	75	0		20.23	20.44	20.56
20	1	0	QPSK	22.22	22.49	22.55
20	1	49		22.15	22.40	22.48
20	1	99		22.15	22.40	22.49
20	50	0		21.25	21.40	21.55
20	50	24		21.23	21.44	21.58
20	50	49		21.26	21.54	21.61
20	100	0		21.22	21.45	21.58
20	1	0	16-QAM	21.37	21.49	21.62
20	1	49		21.39	21.60	21.68
20	1	99		21.42	21.63	21.66
20	50	0		20.24	20.40	20.54
20	50	24		20.22	20.45	20.55
20	50	49		20.26	20.50	20.59
20	100	0		20.22	20.41	20.54



LTE Band 5

Peak-to-Average Ratio

Mode	LTE Band 5 / 10MHz				
Mod.	QPSK		16QAM		Limit: 13dB
RB Size	1RB	Full RB	1RB	Full RB	Result
Lowest CH	4.78	5.77	5.3	6.72	PASS
Middle CH	5.77	6.17	6.55	7.01	
Highest CH	5.45	5.88	6	6.84	



LTE Band 5 / 10MHz / QPSK

Lowest Channel / 1RB

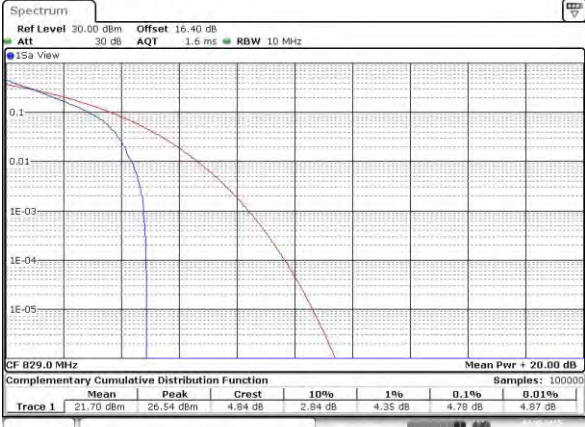

Date: 3,MAY,2015 11:02:31

Lowest Channel / Full RB



Date: 3,MAY,2015 11:02:53

Middle Channel / 1RB

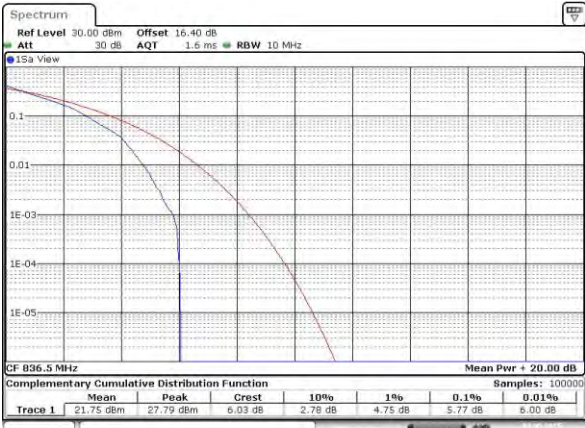

Date: 3,MAY,2015 11:02:52

Middle Channel / Full RB



Date: 3,MAY,2015 11:01:42

Highest Channel / 1RB

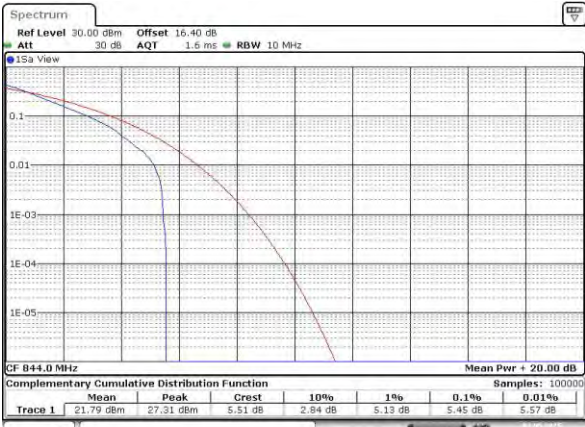

Date: 3,MAY,2015 11:00:30

Highest Channel / Full RB



Date: 3,MAY,2015 11:00:10



LTE Band 5 / 10MHz / 16QAM

Lowest Channel / 1RB

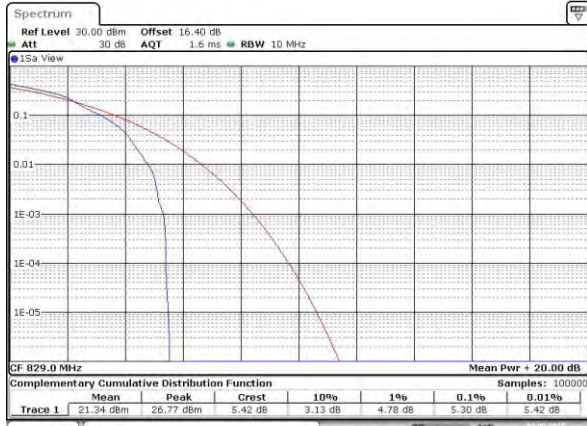

Date: 3,MAY,2015 10:56:57

Lowest Channel / Full RB

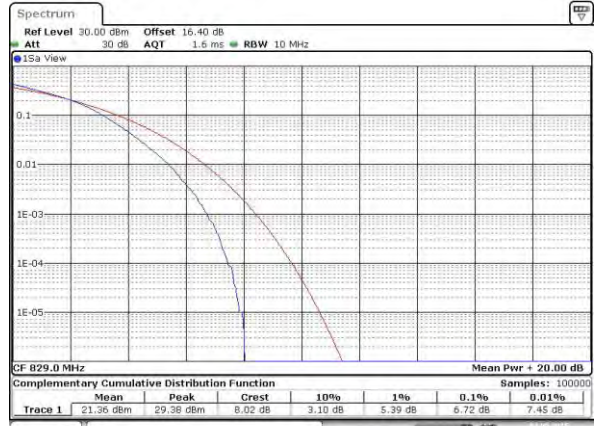

Date: 3,MAY,2015 10:57:12

Middle Channel / 1RB

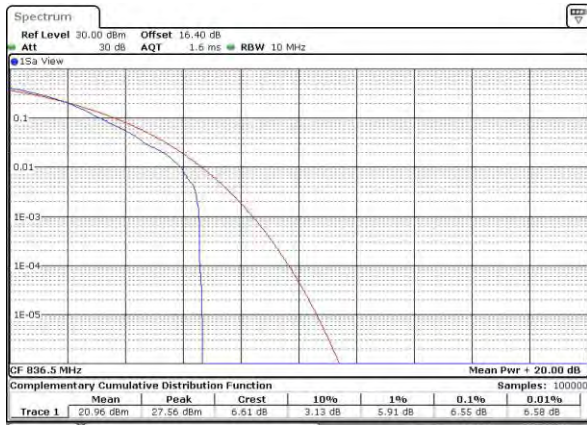

Date: 3,MAY,2015 11:01:17

Middle Channel / Full RB



Date: 3,MAY,2015 10:57:45

Highest Channel / 1RB



Date: 3,MAY,2015 10:58:01

Highest Channel / Full RB

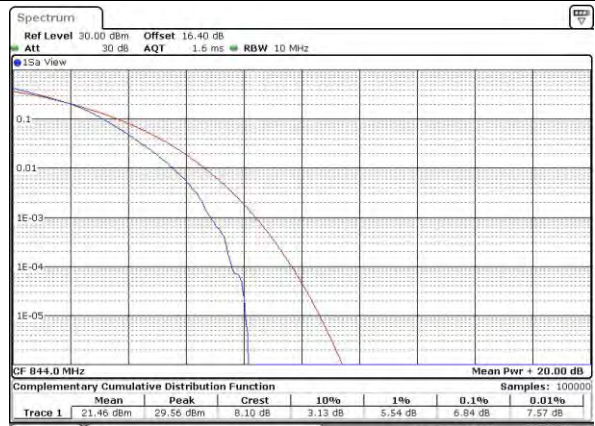

Date: 3,MAY,2015 10:58:13



26dB Bandwidth

Mode	LTE Band 5 : 26dB BW(MHz)											
	1.4MHz		3MHz		5MHz		10MHz		15MHz		20MHz	
BW												
Mod.	QPSK	16QAM	QPSK	16QAM	QPSK	16QAM	QPSK	16QAM	QPSK	16QAM	QPSK	16QAM
Lowest CH	1.26	1.28	3.03	3.03	5.09	5.04	10.03	9.99	-	-	-	-
Middle CH	1.27	1.27	3.04	3.03	5.10	5.06	9.99	10.01	-	-	-	-
Highest CH	1.27	1.27	3.02	3.05	5.11	5.12	10.13	10.03	-	-	-	-



LTE Band 5

Lowest Channel / 1.4MHz / QPSK

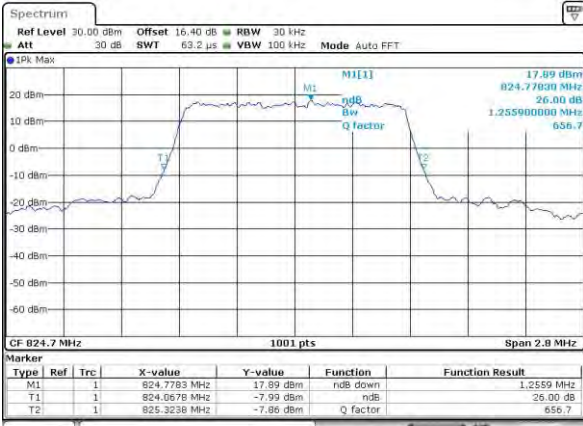

Date: 31MAY,2015 09:18:56

Lowest Channel / 1.4MHz / 16QAM

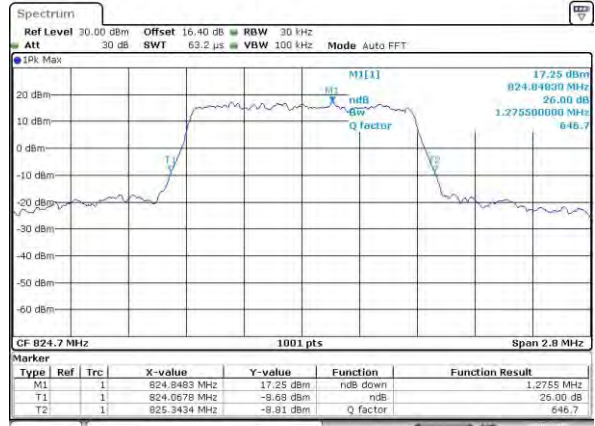

Date: 31MAY,2015 09:18:42

Middle Channel / 1.4MHz / QPSK

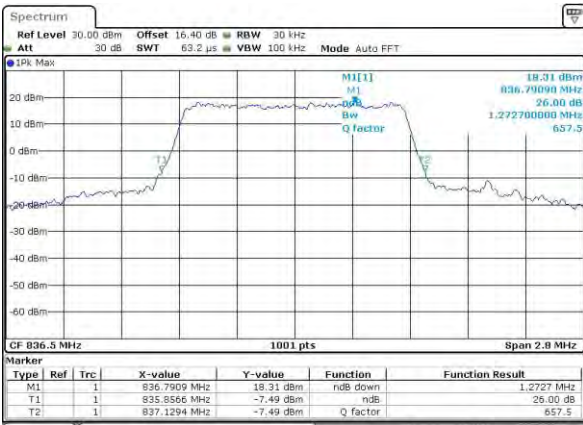

Date: 31MAY,2015 09:18:20

Middle Channel / 1.4MHz / 16QAM

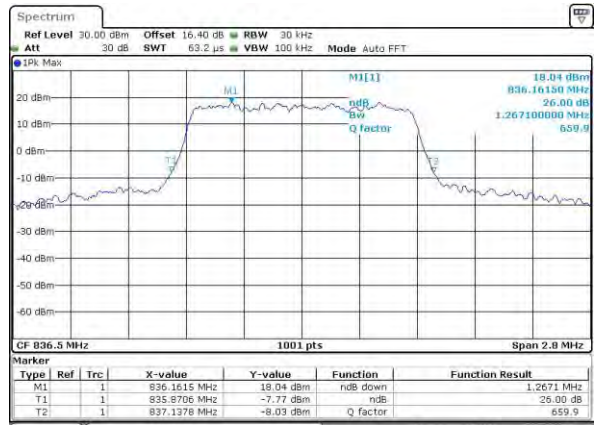

Date: 31MAY,2015 09:18:43

Highest Channel / 1.4MHz / QPSK

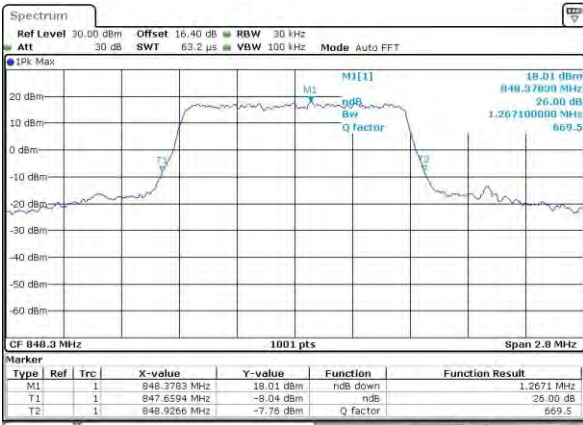

Date: 31MAY,2015 09:18:47

Highest Channel / 1.4MHz / 16QAM

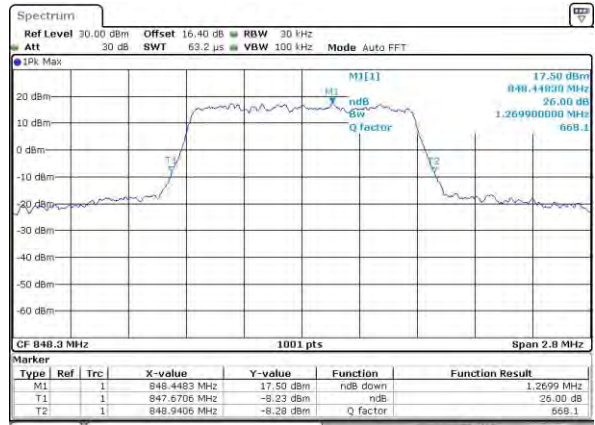

Date: 31MAY,2015 09:18:01



LTE Band 5

Lowest Channel / 3MHz / QPSK

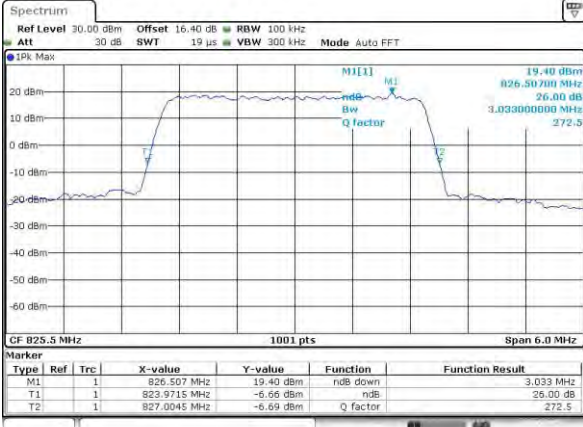

Date: 3,MAY,2015 09:58:19

Lowest Channel / 3MHz / 16QAM

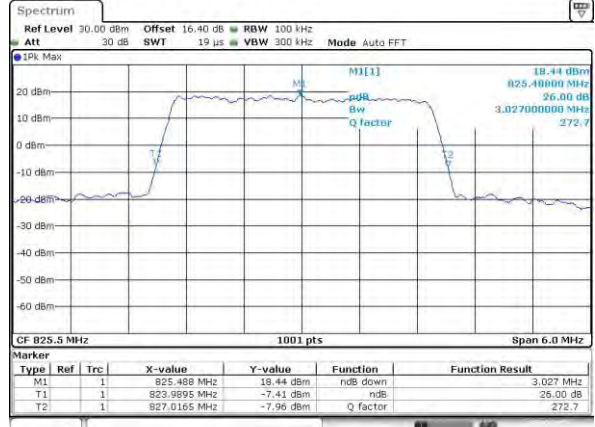

Date: 3,MAY,2015 09:58:33

Middle Channel / 3MHz / QPSK

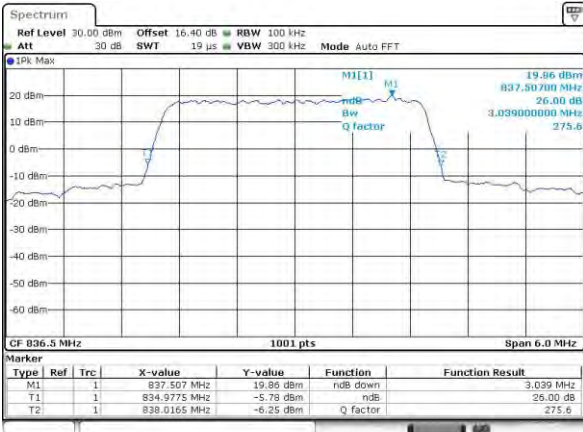

Date: 3,MAY,2015 10:06:17

Middle Channel / 3MHz / 16QAM

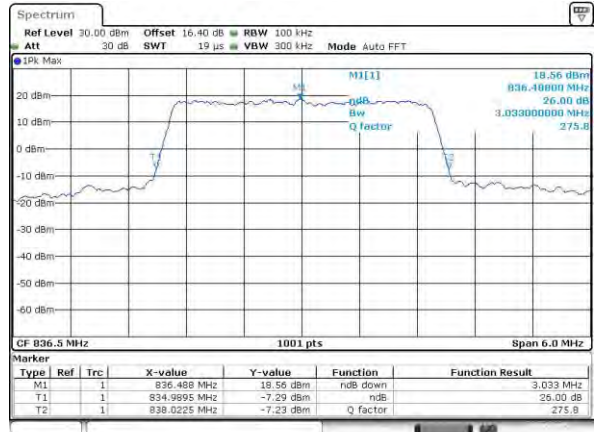

Date: 3,MAY,2015 10:06:31

Highest Channel / 3MHz / QPSK

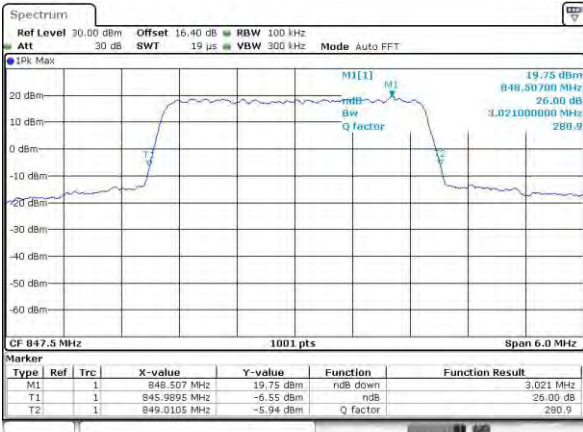

Date: 3,MAY,2015 10:08:35

Highest Channel / 3MHz / 16QAM

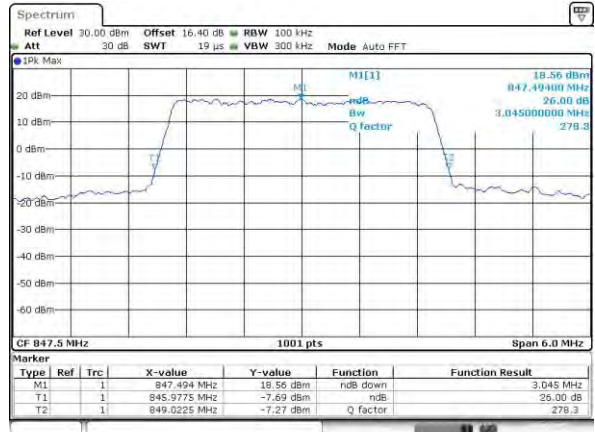

Date: 3,MAY,2015 10:08:49



LTE Band 5

Lowest Channel / 5MHz / QPSK

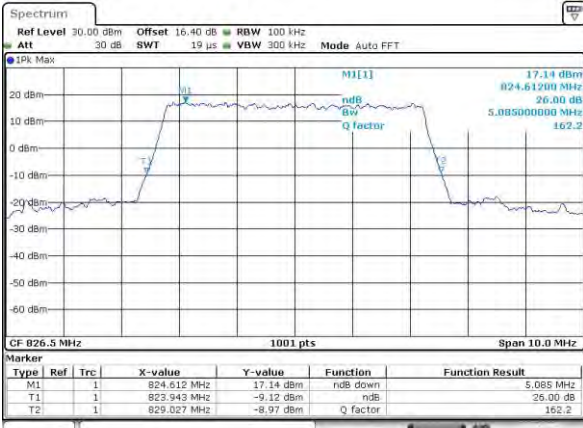

Date: 3,MAY,2015 10:17:34

Lowest Channel / 5MHz / 16QAM

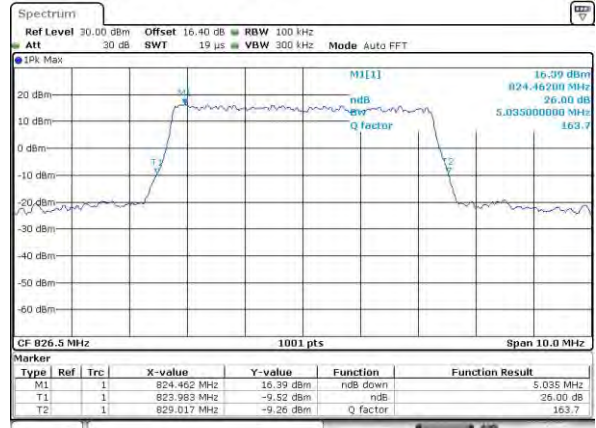

Date: 3,MAY,2015 10:17:47

Middle Channel / 5MHz / QPSK

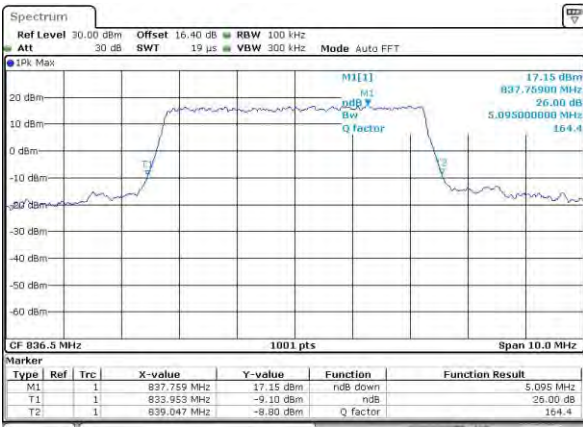

Date: 3,MAY,2015 10:23:31

Middle Channel / 5MHz / 16QAM

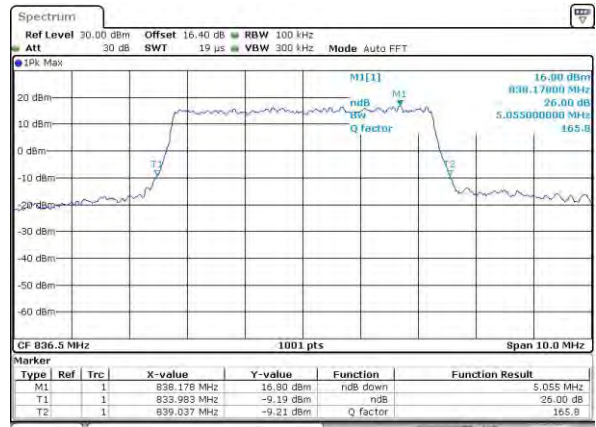

Date: 3,MAY,2015 10:23:45

Highest Channel / 5MHz / QPSK

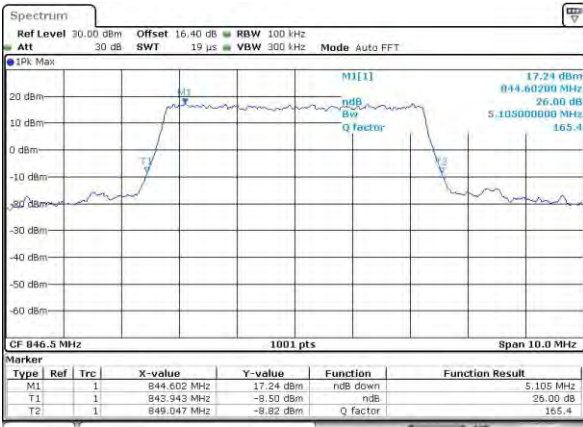

Date: 3,MAY,2015 10:28:49

Highest Channel / 5MHz / 16QAM

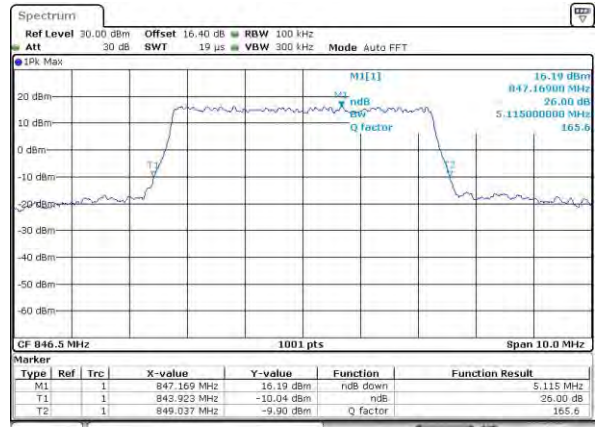

Date: 3,MAY,2015 10:28:03



LTE Band 5

Lowest Channel / 10MHz / QPSK

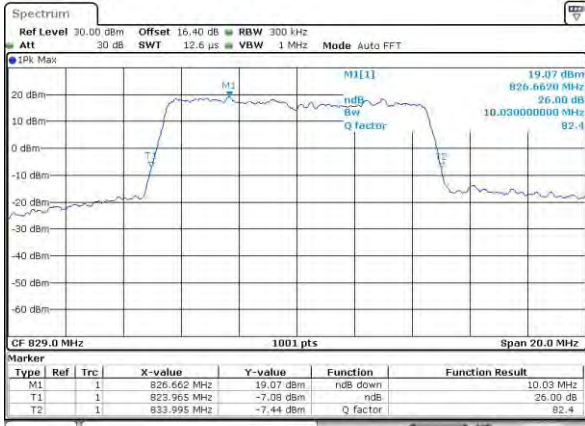

Date: 3,MAY,2015 10:36:47

Lowest Channel / 10MHz / 16QAM

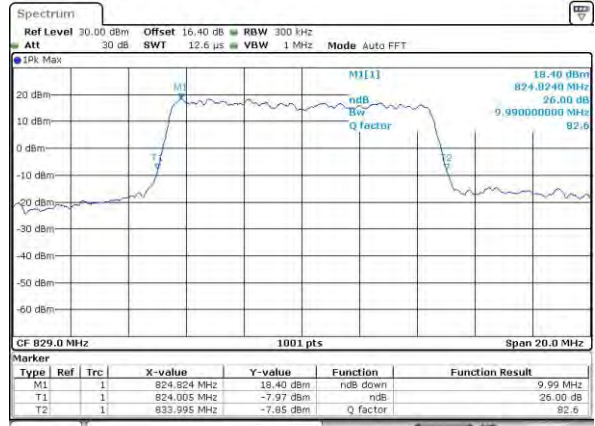

Date: 3,MAY,2015 10:37:01

Middle Channel / 10MHz / QPSK

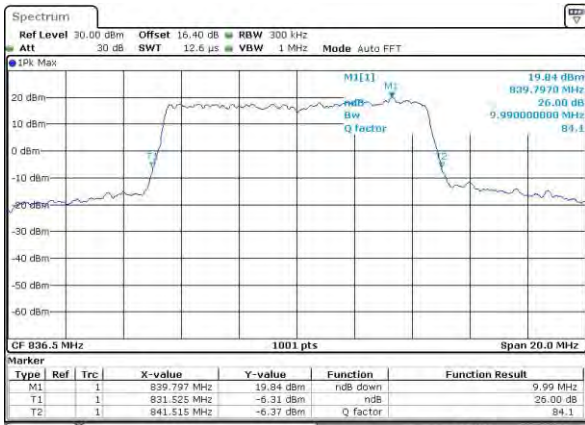

Date: 3,MAY,2015 10:44:45

Middle Channel / 10MHz / 16QAM

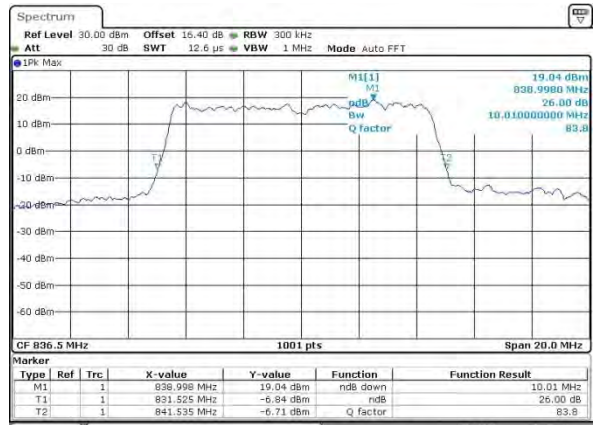

Date: 3,MAY,2015 10:44:58

Highest Channel / 10MHz / QPSK

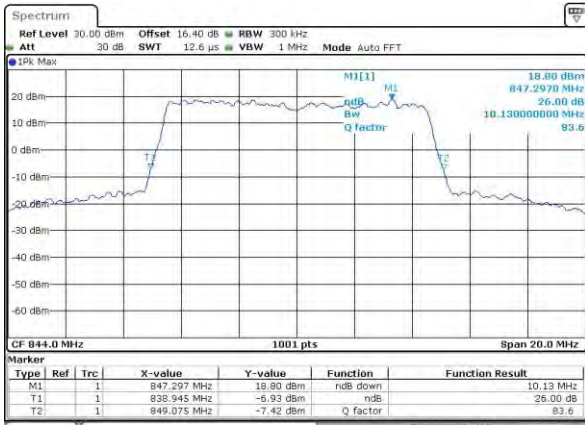

Date: 3,MAY,2015 10:48:02

Highest Channel / 10MHz / 16QAM

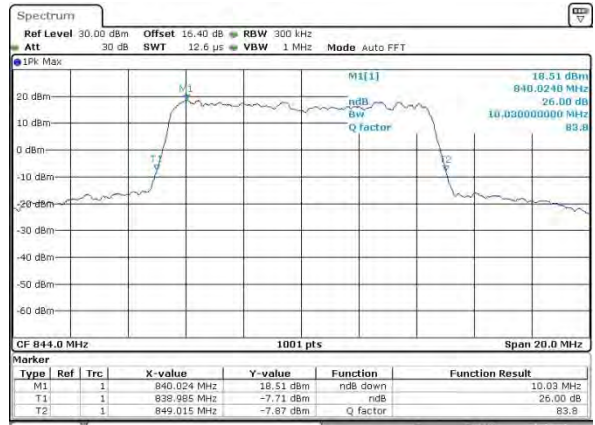

Date: 3,MAY,2015 10:48:16



Occupied Bandwidth

Mode	LTE Band 5 : 99%OBW(MHz)											
	1.4MHz		3MHz		5MHz		10MHz		15MHz		20MHz	
BW	QPSK	16QAM	QPSK	16QAM	QPSK	16QAM	QPSK	16QAM	QPSK	16QAM	QPSK	16QAM
Lowest CH	1.09	1.09	2.73	2.72	4.51	4.51	9.11	9.05	-	-	-	-
Middle CH	1.09	1.1	2.72	2.72	4.51	4.51	9.09	9.01	-	-	-	-
Highest CH	1.09	1.1	2.73	2.73	4.52	4.51	9.07	9.01	-	-	-	-



LTE Band 5

Lowest Channel / 1.4MHz / QPSK

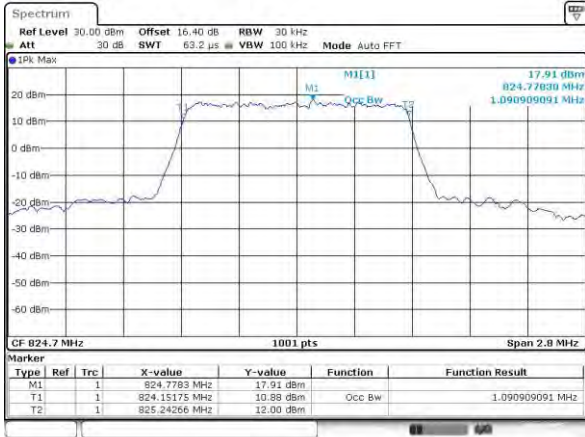

Date: 31MAY.2015 09:36:16

Lowest Channel / 1.4MHz / 16QAM

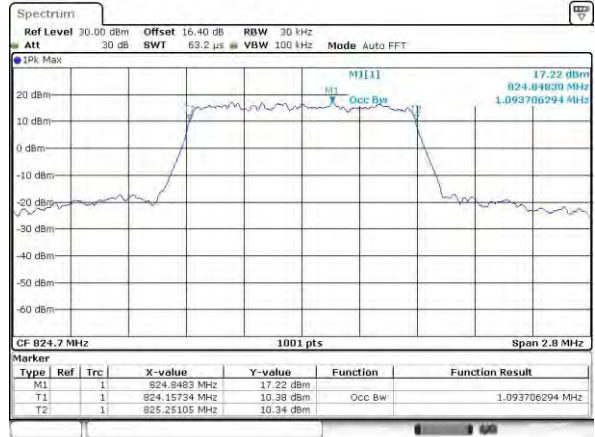

Date: 31MAY.2015 09:36:18

Middle Channel / 1.4MHz / QPSK

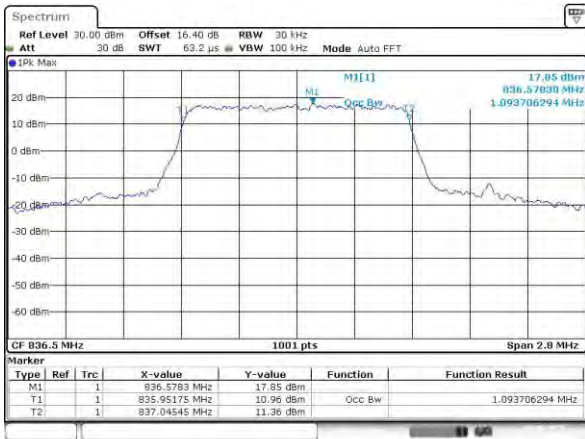

Date: 31MAY.2015 09:40:03

Middle Channel / 1.4MHz / 16QAM

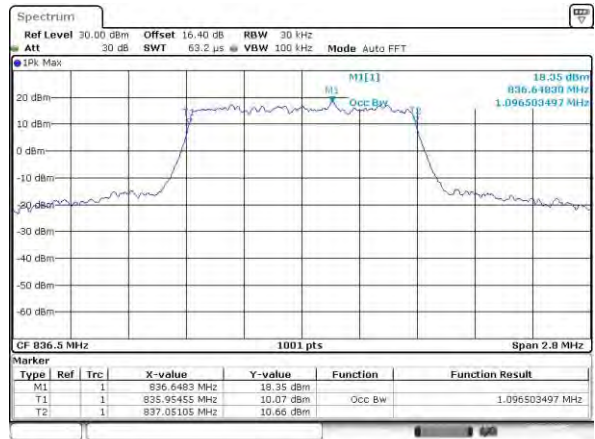

Date: 31MAY.2015 09:40:15

Highest Channel / 1.4MHz / QPSK

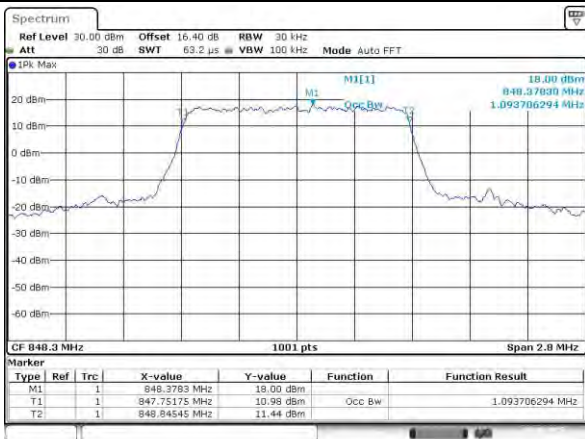

Date: 31MAY.2015 09:48:22

Highest Channel / 1.4MHz / 16QAM

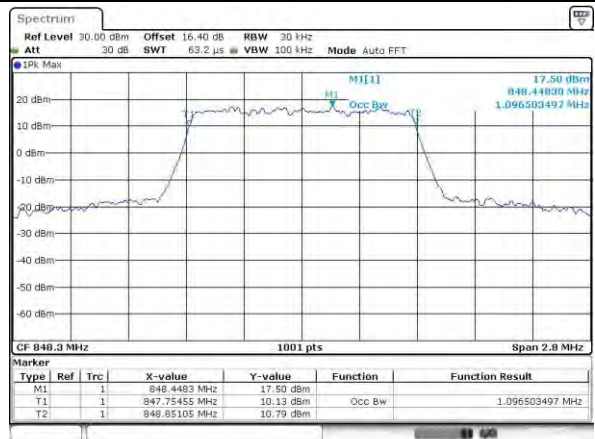

Date: 31MAY.2015 09:48:33



LTE Band 5

Lowest Channel / 3MHz / QPSK

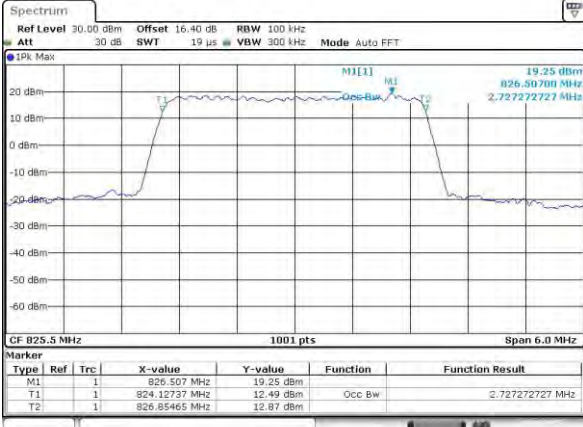

Date: 31 MAY, 2015 09:50:54

Lowest Channel / 3MHz / 16QAM

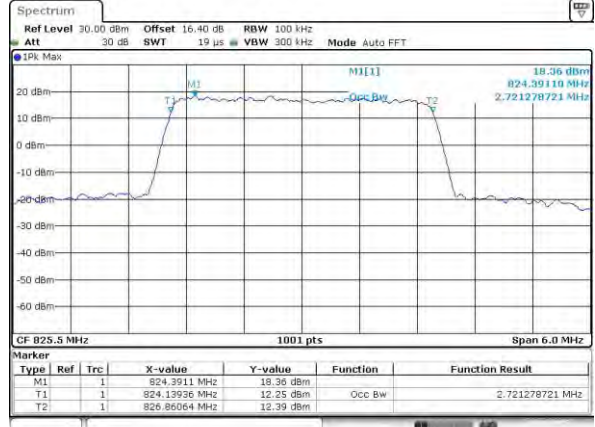

Date: 31 MAY, 2015 09:50:06

Middle Channel / 3MHz / QPSK

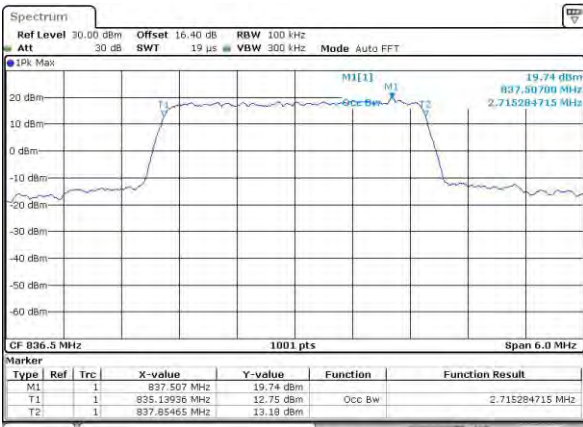

Date: 31 MAY, 2015 10:00:22

Middle Channel / 3MHz / 16QAM

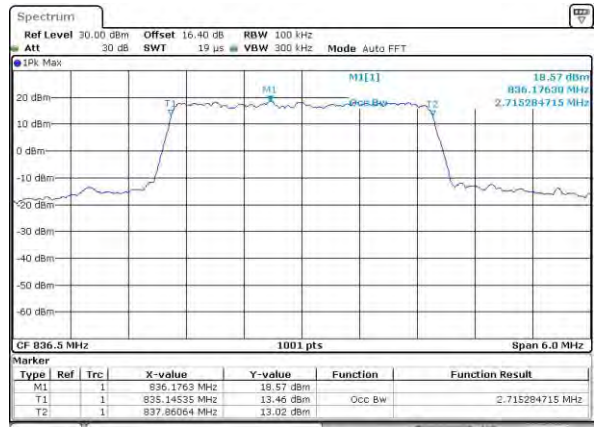

Date: 31 MAY, 2015 10:00:04

Highest Channel / 3MHz / QPSK

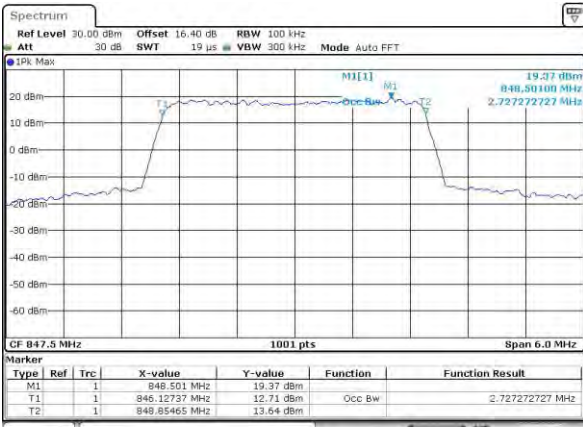

Date: 31 MAY, 2015 10:00:10

Highest Channel / 3MHz / 16QAM

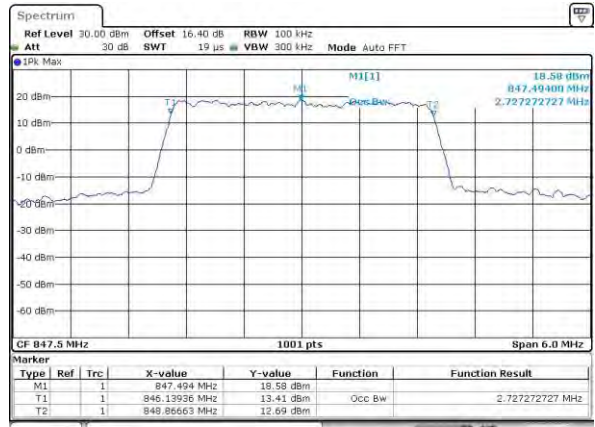

Date: 31 MAY, 2015 10:00:21



LTE Band 5

Lowest Channel / 5MHz / QPSK

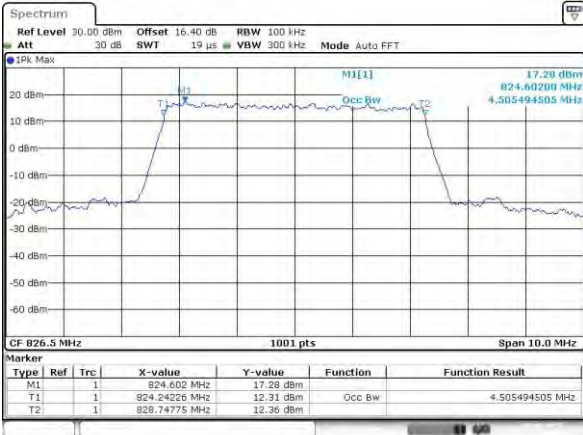

Date: 31MAY.2015 10:17:08

Lowest Channel / 5MHz / 16QAM

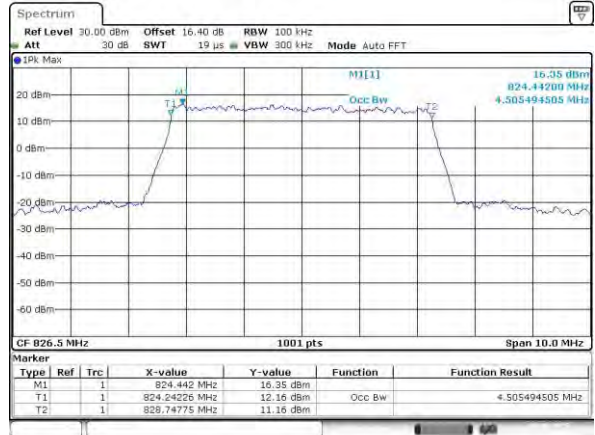

Date: 31MAY.2015 10:17:20

Middle Channel / 5MHz / QPSK

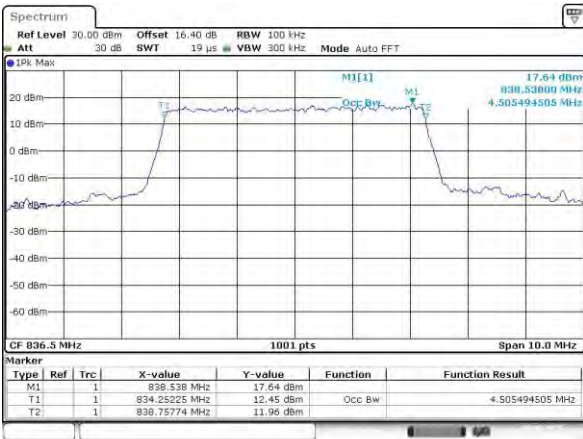

Date: 31MAY.2015 10:23:06

Middle Channel / 5MHz / 16QAM

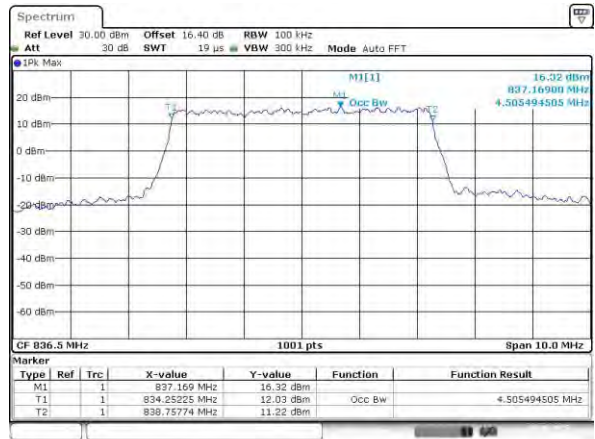

Date: 31MAY.2015 10:23:16

Highest Channel / 5MHz / QPSK

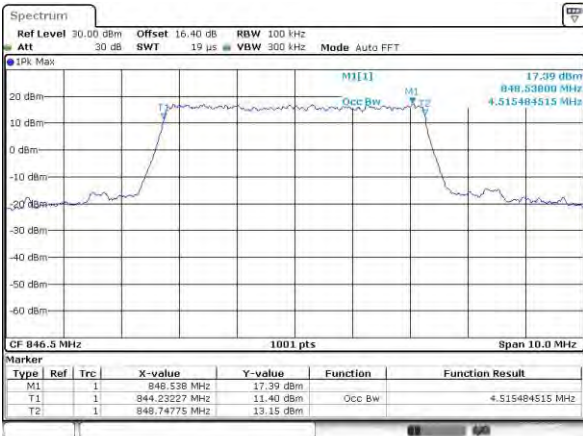

Date: 31MAY.2015 10:28:23

Highest Channel / 5MHz / 16QAM

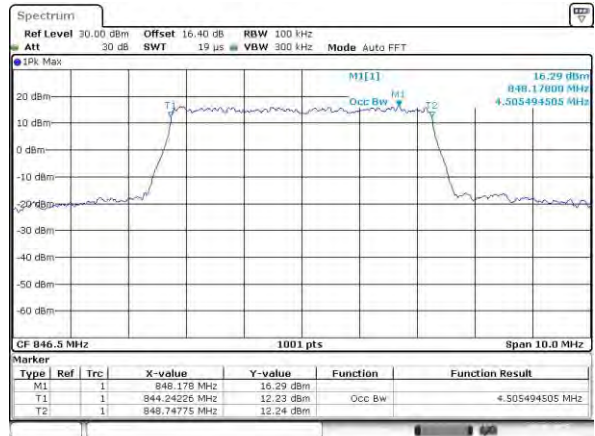

Date: 31MAY.2015 10:28:35



LTE Band 5

Lowest Channel / 10MHz / QPSK

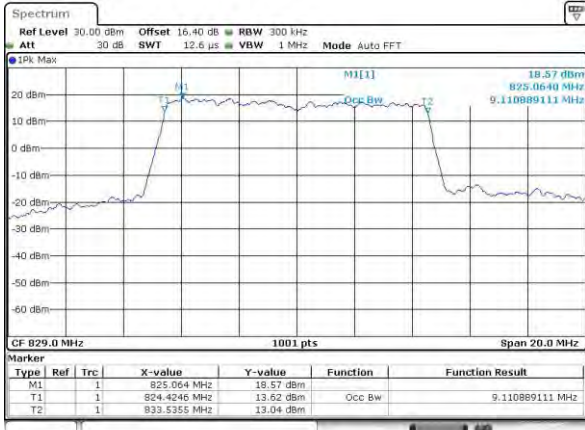

Date: 31MAY,2015 10:36:21

Lowest Channel / 10MHz / 16QAM

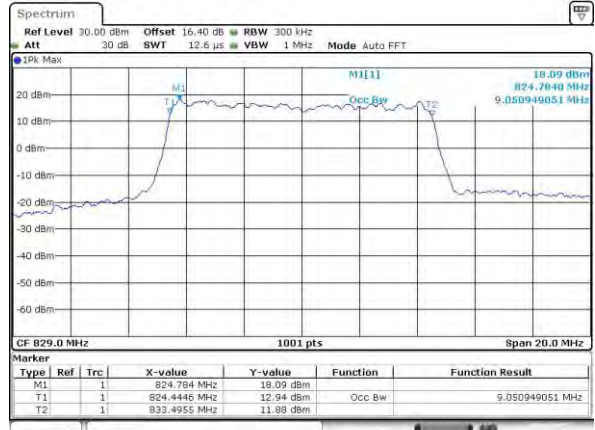

Date: 31MAY,2015 10:36:33

Middle Channel / 10MHz / QPSK

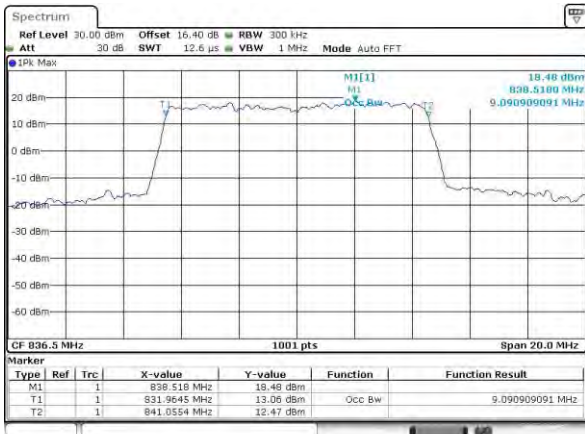

Date: 31MAY,2015 10:44:10

Middle Channel / 10MHz / 16QAM

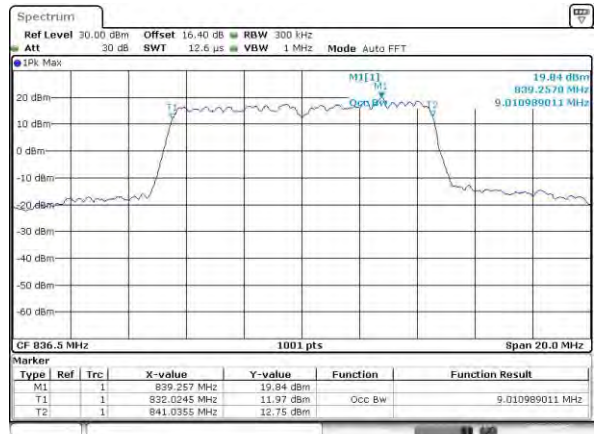

Date: 31MAY,2015 10:44:31

Highest Channel / 10MHz / QPSK

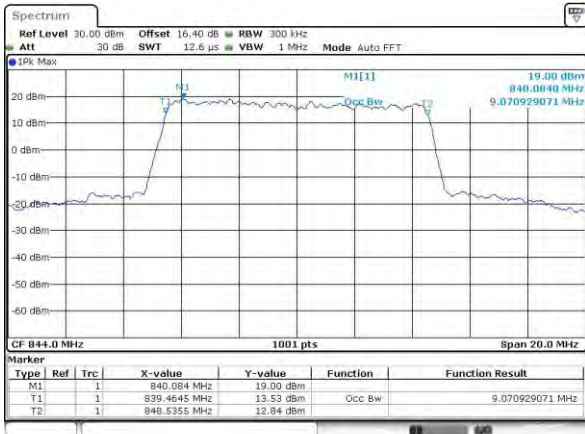

Date: 31MAY,2015 10:47:36

Highest Channel / 10MHz / 16QAM

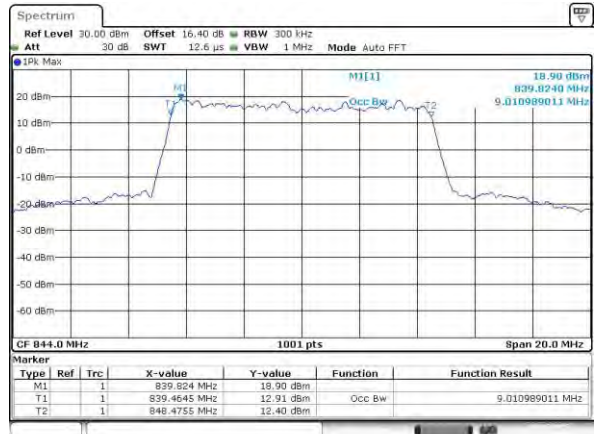

Date: 31MAY,2015 10:47:48



Conducted Band Edge



LTE Band 5 / 1.4MHz / QPSK

Lowest Band Edge / 1RB



Date: 5.MAY.2015 23:02:01

Highest Band Edge / 1RB



Date: 3.MAY.2015 11:18:16

Lowest Band Edge / Full RB



Date: 5.MAY.2015 23:07:57

Highest Band Edge / Full RB



Date: 3.MAY.2015 11:16:31



LTE Band 5 / 1.4MHz / 16QAM

Lowest Band Edge / 1 RB



Date: 5.MAY.2015 23:04:53

Highest Band Edge / 1 RB



Date: 3.MAY.2015 11:21:31

Lowest Band Edge / Full RB



Date: 3.MAY.2015 11:10:17

Highest Band Edge / Full RB



Date: 3.MAY.2015 11:12:23



LTE Band 5 / 3MHz / QPSK

Lowest Band Edge / 1RB

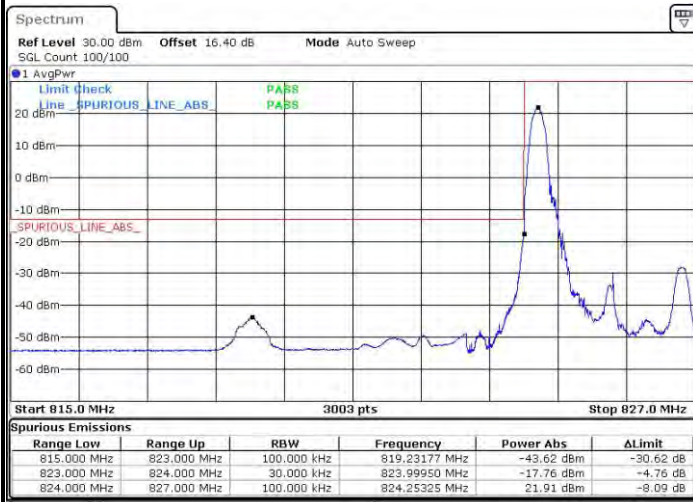

Date: 3.MAY.2015 09:59:43

Highest Band Edge / 1 RB

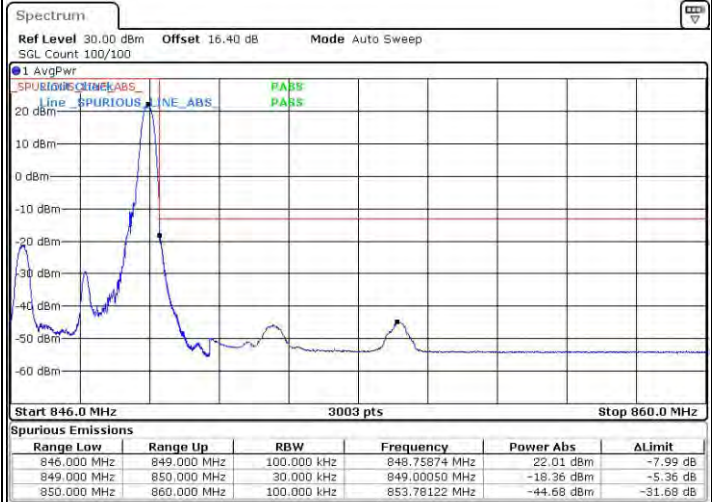

Date: 3.MAY.2015 10:10:59

Lowest Band Edge / Full RB



Date: 3.MAY.2015 10:02:03

Highest Band Edge / Full RB



Date: 3.MAY.2015 10:13:19



LTE Band 5 / 3MHz / 16QAM

Lowest Band Edge / 1 RB

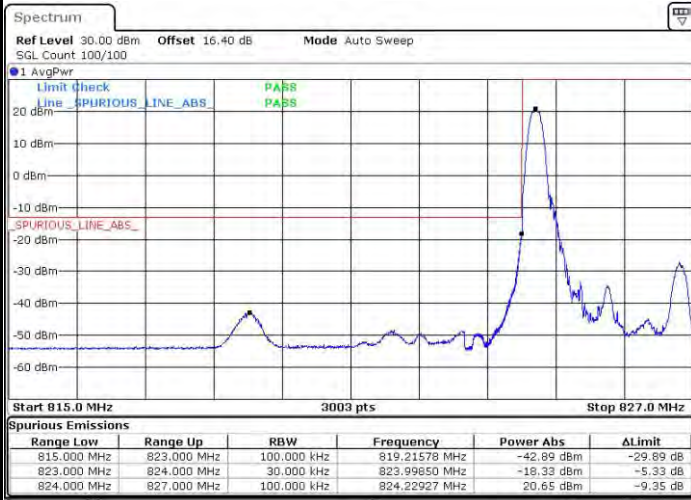

Date: 3.MAY.2015 10:00:53

Highest Band Edge / 1 RB



Date: 3.MAY.2015 10:12:09

Lowest Band Edge / Full RB



Date: 3.MAY.2015 10:03:13

Highest Band Edge / Full RB



Date: 3.MAY.2015 10:14:29



LTE Band 5 / 5MHz / QPSK

Lowest Band Edge / 1 RB

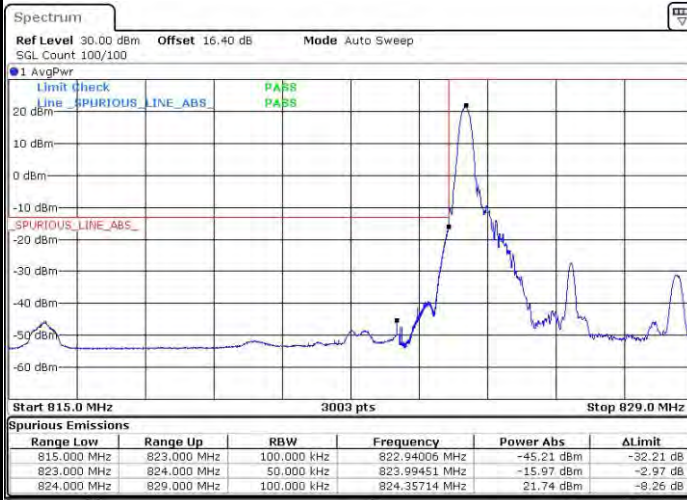

Date: 3.MAY.2015 10:18:57

Highest Band Edge / 1 RB



Date: 3.MAY.2015 10:30:13

Lowest Band Edge / Full RB



Date: 3.MAY.2015 10:21:17

Highest Band Edge / Full RB



Date: 3.MAY.2015 10:32:33



LTE Band 5 / 5MHz / 16QAM

Lowest Band Edge / 1RB

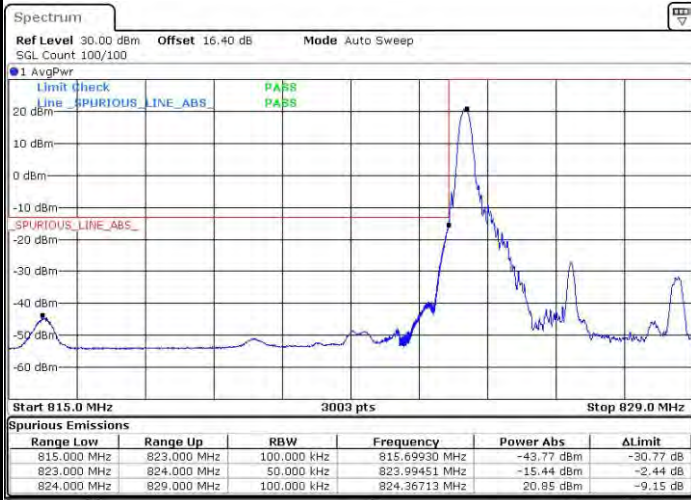

Highest Band Edge / 1 RB

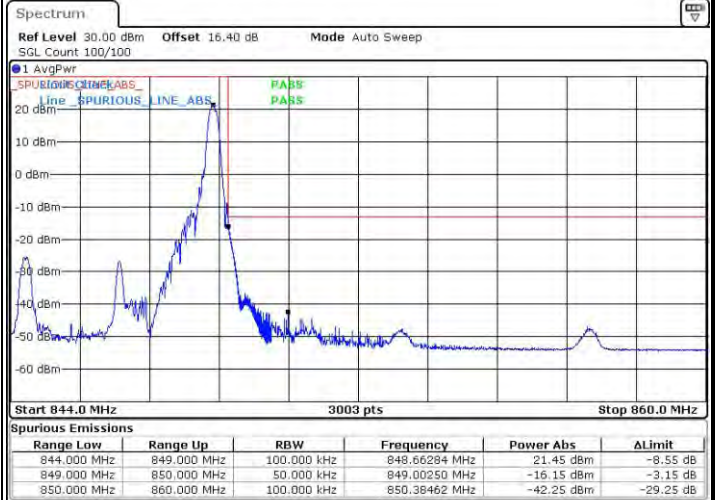

Lowest Band Edge / Full RB

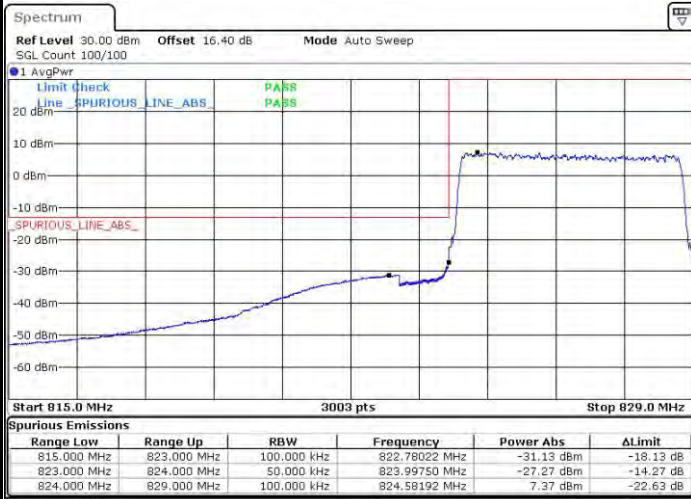

Highest Band Edge / Full RB





LTE Band 5 / 10MHz / QPSK

Lowest Band Edge / 1 RB

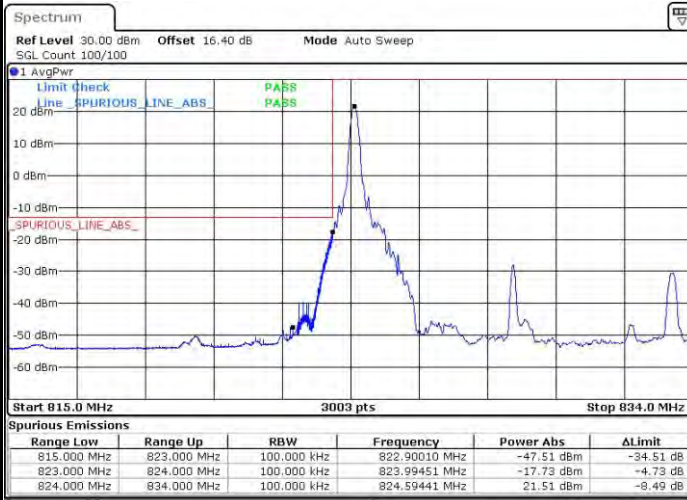

Date: 3.MAY.2015 10:38:10

Highest Band Edge / 1 RB

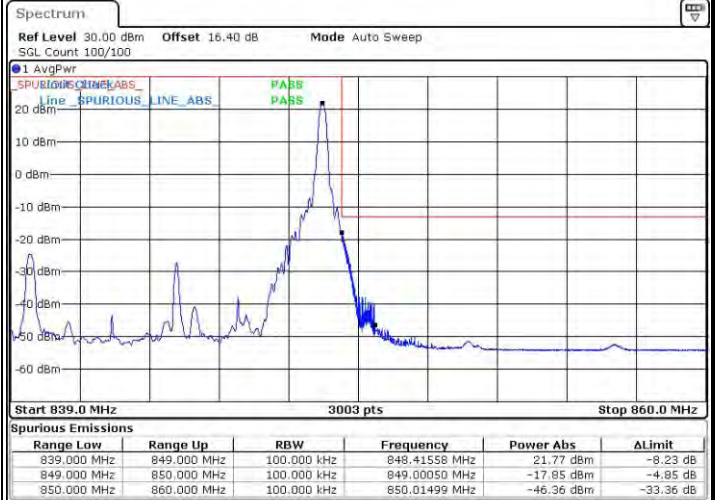

Date: 3.MAY.2015 10:49:25

Lowest Band Edge / Full RB

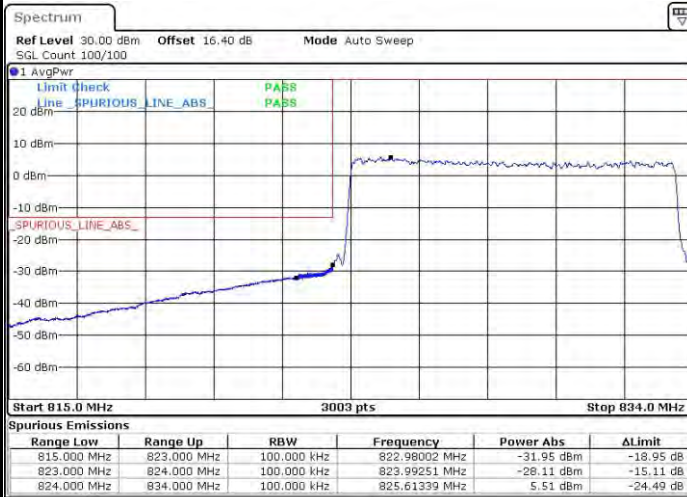

Date: 3.MAY.2015 10:40:30

Highest Band Edge / Full RB



Date: 3.MAY.2015 10:51:45



LTE Band 5 / 10MHz / 16QAM

Lowest Band Edge / 1 RB

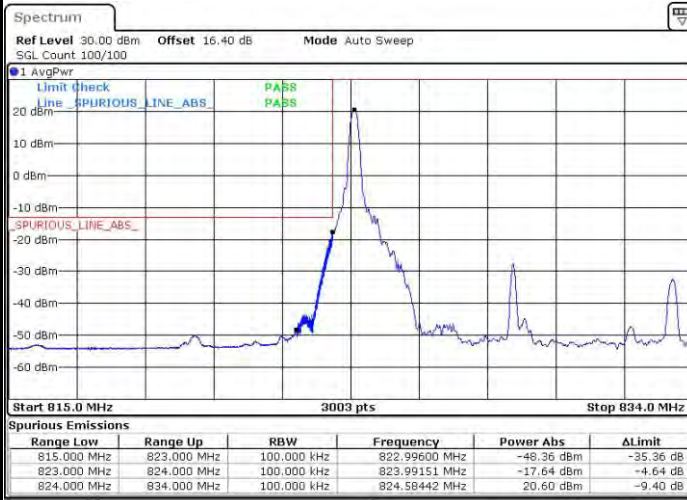

Date: 3.MAY.2015 10:39:20

Highest Band Edge / 1 RB

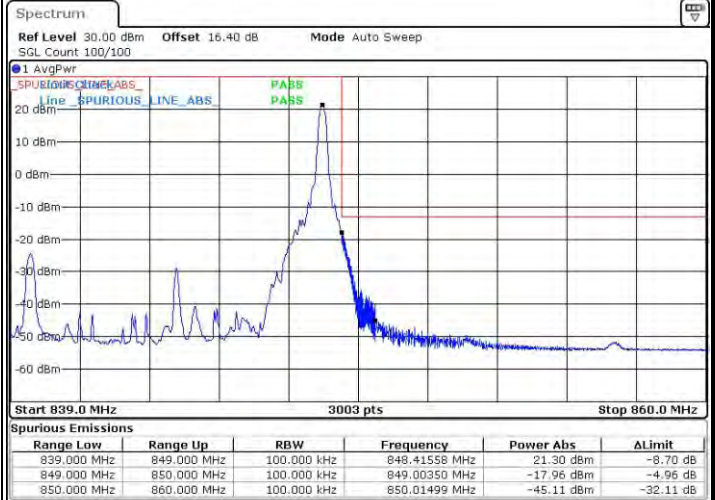

Date: 3.MAY.2015 10:50:35

Lowest Band Edge / Full RB

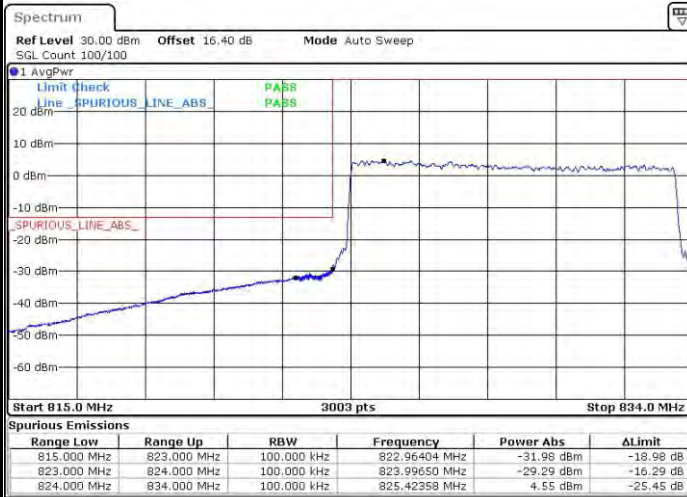

Date: 3.MAY.2015 10:41:40

Highest Band Edge / Full RB



Date: 3.MAY.2015 10:52:58



Conducted Spurious Emission