



FCC RF Test Report

APPLICANT : Sony Mobile Communications Inc.
EQUIPMENT : Smart phone
BRAND NAME : SONY
TYPE NAME : PM-0890-BV
FCC ID : PY7-PM0890
STANDARD : FCC Part 15 Subpart C §15.247
CLASSIFICATION : (DTS) Digital Transmission System

The product was received on Apr. 30, 2015 and testing was completed on May 20, 2015. We, SPORTON INTERNATIONAL INC., would like to declare that the tested sample has been evaluated in accordance with the test procedures and has been in compliance with the applicable technical standards.

The test results in this report apply exclusively to the tested model / sample. Without written approval of SPORTON INTERNATIONAL INC., the test report shall not be reproduced except in full.

Reviewed by: Joseph Lin / Supervisor

Approved by: Jones Tsai / Manager



SPORTON INTERNATIONAL INC.

No. 52, Hwa Ya 1st Rd., Hwa Ya Technology Park, Kwei-Shan District, Tao Yuan City, Taiwan, R.O.C.



TABLE OF CONTENTS

REVISION HISTORY..... 3

SUMMARY OF TEST RESULT 4

1 GENERAL DESCRIPTION 5

 1.1 Applicant 5

 1.2 Manufacturer..... 5

 1.3 Product Feature of Equipment Under Test..... 5

 1.4 Product Specification subjective to this standard 6

 1.5 Modification of EUT 7

 1.6 Testing Location 8

 1.7 Applicable Standards..... 8

2 TEST CONFIGURATION OF EQUIPMENT UNDER TEST 9

 2.1 Carrier Frequency Channel 9

 2.2 Pre-Scanned RF Power..... 10

 2.3 Test Mode..... 10

 2.4 Connection Diagram of Test System..... 11

 2.5 Support Unit used in test configuration and system 12

 2.6 EUT Operation Test Setup 12

 2.7 Measurement Results Explanation Example..... 12

3 TEST RESULT..... 13

 3.1 6dB and 99% Bandwidth Measurement 13

 3.2 Output Power Measurement..... 15

 3.3 Power Spectral Density Measurement 16

 3.4 Conducted Band Edges and Spurious Emission Measurement 18

 3.5 Radiated Band Edges and Spurious Emission Measurement 31

 3.6 AC Conducted Emission Measurement..... 35

 3.7 Antenna Requirements..... 40

4 LIST OF MEASURING EQUIPMENT 41

5 UNCERTAINTY OF EVALUATION 43

APPENDIX A. CONDUCTED TEST RESULTS

APPENDIX B. TEST RESULT OF RADIATED EMISSION

**SUMMARY OF TEST RESULT**

Report Section	FCC Rule	Description	Limit	Result	Remark
3.1	15.247(a)(2)	6dB Bandwidth	$\geq 0.5\text{MHz}$	Pass	-
3.1	-	99% Bandwidth	-	Pass	-
3.2	15.247(b)	Power Output Measurement	$\leq 30\text{dBm}$	Pass	-
3.3	15.247(e)	Power Spectral Density	$\leq 8\text{dBm}/3\text{kHz}$	Pass	-
3.4	15.247(d)	Conducted Band Edges	$\leq 20\text{dBc}$	Pass	-
		Conducted Spurious Emission		Pass	-
3.5	15.247(d)	Radiated Band Edges and Radiated Spurious Emission	15.209(a) & 15.247(d)	Pass	Under limit 7.04 dB at 2483.600 MHz
3.6	15.207	AC Conducted Emission	15.207(a)	Pass	Under limit 11.20 dB at 2.710. MHz
3.7	15.203 & 15.247(b)	Antenna Requirement	N/A	Pass	-



1 General Description

1.1 Applicant

Sony Mobile Communications Inc.
Nya Vattentorget, 22188 Lund, Sweden

1.2 Manufacturer

Arima Communications Corp.
6F, No. 866, Jhongjheng Rd., Jhonghe Dist., New Taipei City 23586, Taiwan

1.3 Product Feature of Equipment Under Test

The Equipment Under Test (hereafter called: EUT) is smart phone supporting, GSM/WCDMA/LTE, Wi-Fi 2.4GHz 802.11b/g/n, Wi-Fi 5GHz 802.11a/n, Bluetooth with FM Receiver, GPS, and NFC features, and below is details of information.

Product Feature	
Equipment	Smart phone
Brand Name	SONY
Type Name	PM-0890-BV
FCC ID	PY7-PM0890
GSM Operating Band(s)	GSM 850/900/1800/1900MHz
GPRS / EGPRS Multi Slot Class	GPRS Class 12, EGPRS Class 12
WCDMA Operating Band(s)	FDD Band I / II / IV / V / VIII
WCDMA Rel. Version	Rel. 8
LTE Operating Band(s)	FDD Band II / IV / V / VII / XII / XIII / XVII / XXVIII
LTE Rel. Version	Rel. 8
Wi-Fi Specification	802.11a/b/g/n (HT20/HT40)
Bluetooth Version	v3.0+EDR / v4.0-LE
NFC Specification	ISO14443A / ISO14443B / Felica
Power Supply	Battery / AC Adapter / Car Charger

Remark: The above EUT's information was declared by manufacturer. Please refer to the specifications or user's manual for more detailed description.



1.4 Product Specification subjective to this standard

Product Specification subjective to this standard	
Tx/Rx Channel Frequency Range	802.11b/g/n : 2412 MHz ~ 2462 MHz
Maximum (Peak) Output Power to Antenna	802.11b : 18.85 dBm (0.0767 W) 802.11g : 24.31 dBm (0.2698 W) 802.11n HT20 : 21.56 dBm (0.1432 W) 802.11n HT40 : 22.13 dBm (0.1633 W)
99% Occupied Bandwidth	802.11b : 12.65MHz 802.11g : 17.30MHz 802.11n HT20 : 18.50MHz 802.11n HT40 : 36.50MHz
Antenna Type	802.11b/g/n : PIFA Antenna type with gain -6.90 dBi
Type of Modulation	802.11b : DSSS (DBPSK / DQPSK / CCK) 802.11g/n : OFDM (BPSK / QPSK / 16QAM / 64QAM)

EUT Information List				
IMEI	HW Version	SW Version	S/N	Performed Test Item
IMEI : 004402454681739	A	29.0.A.0.76	WUJ01HYJ4Y	RF conducted measurement
IMEI : 004402454681804			WUJ01HYJD7	Radiated Spurious Emission
IMEI : 004402454681721			WUJ01HYJ4J	Conducted Emission



Accessory List	
AC Adapter	Model No. : EP800
	Type No. : CAA-0002016-US B
	S/N : 3113W 38 210631 (For Conducted Emission) 3113W 45 108545 (For Radiated Emission)
Battery	Model No. : LIS1579ERPC
Earphone 1	Model No. : MH410c
	Type No. : AG-1100
	S/N : 14371E6600174A0 (For Conducted Emission) 13511E63001BFF6 (For Radiated Emission)
Earphone 2	Model No. : MH410c
	Type No. : AG-1103
	S/N : 14292040011682C (For Conducted Emission) 1428204D011619A (For Radiated Emission)
USB Cable	Model No. : EC450
	Type No. : AI-0700
	S/N : 134912D1000585A (For Conducted Emission) 143412DE1065866 (For Radiated Emission)

Note:

1. Above EUT list and accessory list used are electrically identical per declared by manufacturer.
2. Above the accessories list are used to exercise the EUT during test.
3. For other wireless features of this EUT, test report will be issued separately.

1.5 Modification of EUT

No modifications are made to the EUT during all test items.



1.6 Testing Location

Sporton Lab is accredited to ISO 17025 by Taiwan Accreditation Foundation (TAF code : 1190) and the FCC designation No. TW1022 under the FCC 2.948(e) by Mutual Recognition Agreement (MRA) in FCC Test.

Test Site	SPORTON INTERNATIONAL INC.	
Test Site Location	No. 52, Hwa Ya 1 st Rd., Hwa Ya Technology Park, Kwei-Shan District, Tao Yuan City, Taiwan, R.O.C. TEL: +886-3-327-3456 FAX: +886-3-328-4978	
Test Site No.	Sporton Site No.	
	TH02-HY	CO05-HY

Note: The test site complies with ANSI C63.4 2009 requirement.

Test Site	SPORTON INTERNATIONAL INC.	
Test Site Location	No.58, Aly. 75, Ln. 564, Wenhua 3rd Rd. Guishan Township, Taoyuan County, Taiwan (R.O.C.) TEL: +886-3-327-0855	
Test Site No.	Sporton Site No.	
	03CH11-HY	

Note: The test site complies with ANSI C63.4 2009 requirement.

1.7 Applicable Standards

According to the specifications of the manufacturer, the EUT must comply with the requirements of the following standards:

- ♦ FCC Part 15 Subpart C §15.247
- ♦ FCC KDB Publication No. 558074 D01 DTS Meas. Guidance v03r03
- ♦ ANSI C63.10-2009

Remark:

1. All test items were verified and recorded according to the standards and without any deviation during the test.
2. FCC permits the use of the 1.5 meter table as an alternative in C63.10-2013 through inquiry tracking number 961829.
3. This EUT has also been tested and complied with the requirements of FCC Part 15, Subpart B, recorded in a separate test report.



2 Test Configuration of Equipment Under Test

The EUT has been associated with peripherals and configuration operated in a manner tended to maximize its emission characteristics in a typical application. Frequency range investigated: conducted emission (150 kHz to 30 MHz) and radiated emission (9 kHz to the 10th harmonic of the highest fundamental frequency or to 40 GHz, whichever is lower). For radiated measurement, pre-scanned in three orthogonal panels, X, Y, Z. The worst cases (X plane) were recorded in this report.

The final configuration from all the combinations and the worst-case data rates were investigated by measuring the maximum power across all the data rates and modulation modes under section 2.2.

Based on the worst configuration found above, the RF power setting is set individually to meet FCC compliance limit for the final conducted and radiated tests shown in section 2.3.

2.1 Carrier Frequency Channel

Frequency Band	Channel	Freq. (MHz)	Channel	Freq. (MHz)
2400-2483.5 MHz	1	2412	7	2442
	2	2417	8	2447
	3	2422	9	2452
	4	2427	10	2457
	5	2432	11	2462
	6	2437	-	-



2.2 Pre-Scanned RF Power

Preliminary tests were performed in different data rate and data rate associated with the highest power were chosen for full test shown in the following tables.

2.4GHz 802.11b mode				
Data Rate (MHz)	1M bps	2M bps	5.5M bps	11M bps
Peak Power (dBm)	18.85	18.61	18.60	18.65

2.4GHz 802.11g mode								
Data Rate (MHz)	6M bps	9M bps	12M bps	18M bps	24M bps	36M bps	48M bps	54M bps
Peak Power (dBm)	23.19	23.06	24.31	24.29	22.60	22.55	24.00	24.02

2.4GHz 802.11n HT20 mode								
Data Rate (MHz)	MCS0	MCS1	MCS2	MCS3	MCS4	MCS5	MCS6	MCS7
Peak Power (dBm)	21.56	20.73	20.78	20.85	20.71	21.55	21.48	21.42

2.4GHz 802.11n HT40 mode								
Data Rate (MHz)	MCS0	MCS1	MCS2	MCS3	MCS4	MCS5	MCS6	MCS7
Peak Power (dBm)	22.13	20.15	20.07	20.47	20.03	20.45	20.41	20.62

2.3 Test Mode

Final test mode of conducted test items and radiated spurious emissions are considering the modulation and worse data rates from the power table described in section 2.2.

Modulation	Data Rate
802.11b	1 Mbps
802.11g	12 Mbps
802.11n HT20	MCS0
802.11n HT40	MCS0

Test Cases	
AC Conducted Emission	Mode 1 : GSM1900 Idle + Bluetooth Link + WLAN (2.4GHz) Link + Earphone + Battery + USB Cable (Charging from Adapter) + MP3

2.4 Connection Diagram of Test System

<WLAN Tx Mode>

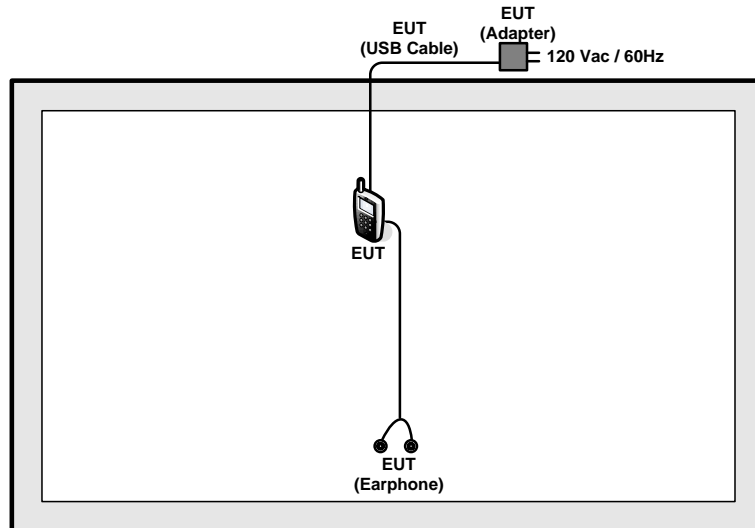

<AC Conducted Emission Mode>

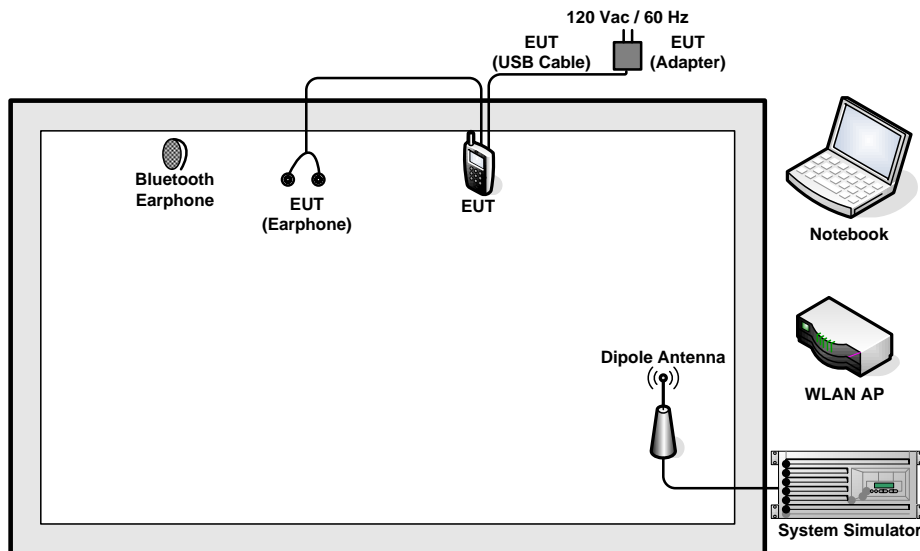



2.5 Support Unit used in test configuration and system

Item	Equipment	Trade Name	Model Name	FCC ID	Data Cable	Power Cord
1.	System Simulator	Anritsu	MT8820C	N/A	N/A	Unshielded, 1.8 m
2.	Bluetooth Earphone	Sony	SBH20	PY7-RD0010	Unshielded, 0.75m	N/A
3.	WLAN AP	D-Link	DIR-628	KA2DIR628A2	N/A	Unshielded, 1.8 m
4.	Notebook	DELL	Latitude E6320	FCC DoC/ Contains FCC ID: QDS-BRCM1054	N/A	AC I/P: Unshielded, 1.2 m DC O/P: Shielded, 1.8 m
5.	SD Card	SanDisk	MicroSD HC	FCC DoC	N/A	N/A

2.6 EUT Operation Test Setup

For WLAN RF test items, an engineering test program was provided and enabled to make EUT continuous transmit/receive.

2.7 Measurement Results Explanation Example

For all conducted test items:

The offset level is set in the spectrum analyzer to compensate the RF cable loss and attenuator factor between EUT conducted output port and spectrum analyzer. With the offset compensation, the spectrum analyzer reading level is exactly the EUT RF output level.

Example :

The spectrum analyzer offset is derived from RF cable loss and attenuator factor.

Offset = RF cable loss + attenuator factor.

Following shows an offset computation example with cable loss 4.2 dB and 10dB attenuator.

$$\begin{aligned} \text{Offset(dB)} &= \text{RF cable loss(dB)} + \text{attenuator factor(dB)}. \\ &= 4.2 + 10 = 14.2 \text{ (dB)} \end{aligned}$$

3 Test Result

3.1 6dB and 99% Bandwidth Measurement

3.1.1 Limit of 6dB and 99% Bandwidth

The minimum 6 dB bandwidth shall be at least 500 kHz.

3.1.2 Measuring Instruments

The measuring equipment is listed in the section 4 of this test report.

3.1.3 Test Procedures

1. The testing follows FCC KDB Publication No. 558074 DTS D01 Meas. Guidance v03r03.
2. The RF output of EUT was connected to the spectrum analyzer by RF cable and attenuator. The path loss was compensated to the results for each measurement.
3. Set to the maximum power setting and enable the EUT transmit continuously.
4. Make the measurement with the spectrum analyzer's resolution bandwidth (RBW) = 100 kHz. Set the Video bandwidth (VBW) = 300 kHz. In order to make an accurate measurement. The 6 dB bandwidth must be greater than 500 kHz.
5. For 99% Bandwidth Measurement, the spectrum analyzer's resolution bandwidth (RBW) = 1MHz and set the Video bandwidth (VBW) = 3MHz.
6. Measure and record the results in the test report.

3.1.4 Test Setup





3.1.5 Test Result of 6dB and 99% Occupied Bandwidth

Please refer to Appendix A of this test report.

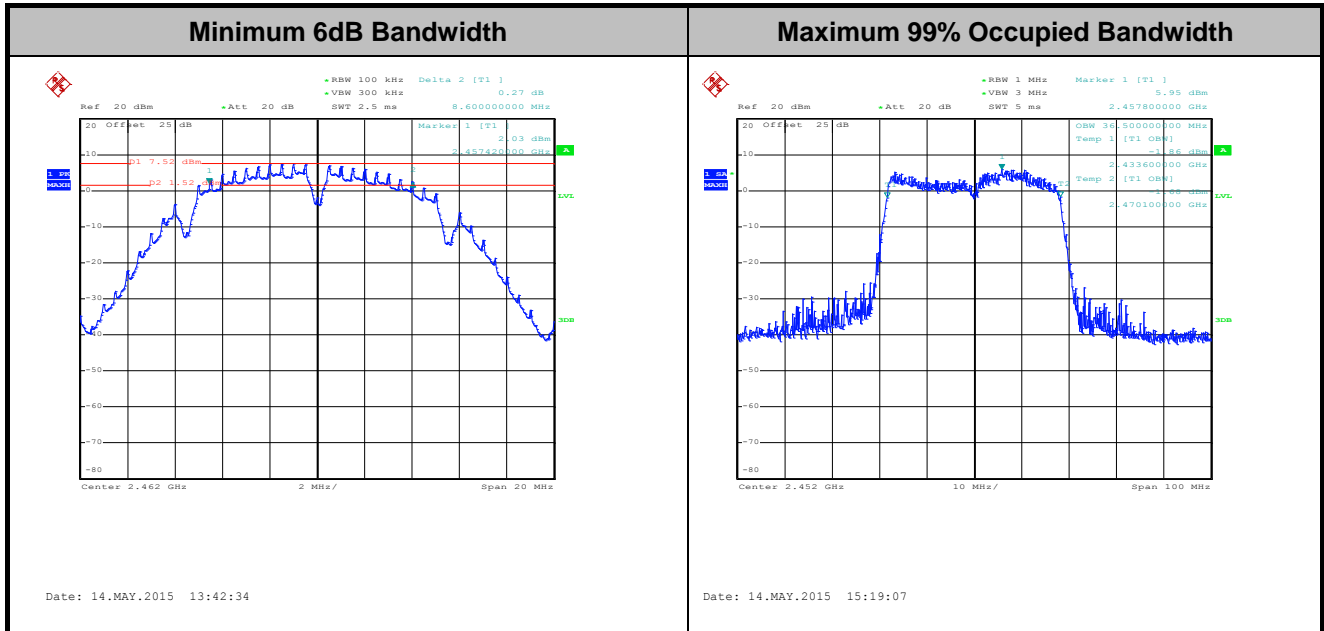

Note : The occupied channel bandwidth is maintained within the band of operation for all of the modulations.

3.2 Output Power Measurement

3.2.1 Limit of Output Power

For systems using digital modulation in the 2400-2483.5MHz, the limit for peak output power is 30dBm. If transmitting Antenna of directional gain greater than 6dBi are used the peak output power from the intentional radiator shall be reduced below the above stated value by the amount in dB that the directional gain of the Antenna exceeds 6 dBi. In case of point-to-point operation, the limit has to be reduced by 1dB for every 3dB that the directional gain of the Antenna exceeds 6dBi.

3.2.2 Measuring Instruments

The measuring equipment is listed in the section 4 of this test report.

3.2.3 Test Procedures

1. The testing follows the Measurement Procedure of FCC KDB No. 558074 DTS D01 Meas. Guidance v03r03.
2. The RF output of EUT was connected to the power meter by RF cable and attenuator. The path loss was compensated to the results for each measurement.
3. Set to the maximum power setting and enable the EUT transmit continuously.
4. Measure the conducted output power and record the results in the test report.

3.2.4 Test Setup

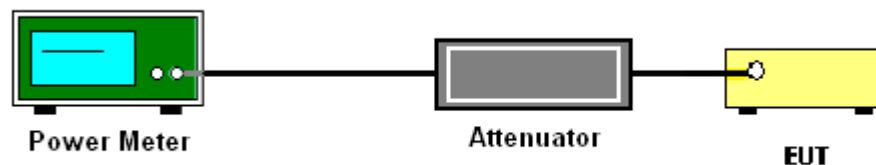

3.2.5 Test Result of Peak Output Power

Please refer to Appendix A of this test report.

3.2.6 Test Result of Average output Power (Reporting Only)

Please refer to Appendix A of this test report.

3.3 Power Spectral Density Measurement

3.3.1 Limit of Power Spectral Density

The peak power spectral density shall not be greater than 8dBm in any 3kHz band at any time interval of continuous transmission.

3.3.2 Measuring Instruments

The measuring equipment is listed in the section 4 of this test report.

3.3.3 Test Procedures

1. The testing follows Measurement Procedure 10.2 Method PKPSD of FCC KDB Publication No. 558074 D01 DTS Meas. Guidance v03r03
2. The RF output of EUT was connected to the spectrum analyzer by RF cable and attenuator. The path loss was compensated to the results for each measurement.
3. Set to the maximum power setting and enable the EUT transmit continuously.
4. Make the measurement with the spectrum analyzer's resolution bandwidth (RBW) = 3 kHz. Video bandwidth VBW = 10 kHz In order to make an accurate measurement, set the span to 1.5 times DTS Channel Bandwidth. (6dB BW)
5. Detector = peak, Sweep time = auto couple, Trace mode = max hold, Allow trace to fully stabilize. Use the peak marker function to determine the maximum power level.
6. Measure and record the results in the test report.

3.3.4 Test Setup





3.3.5 Test Result of Power Spectral Density

Please refer to Appendix A of this test report.

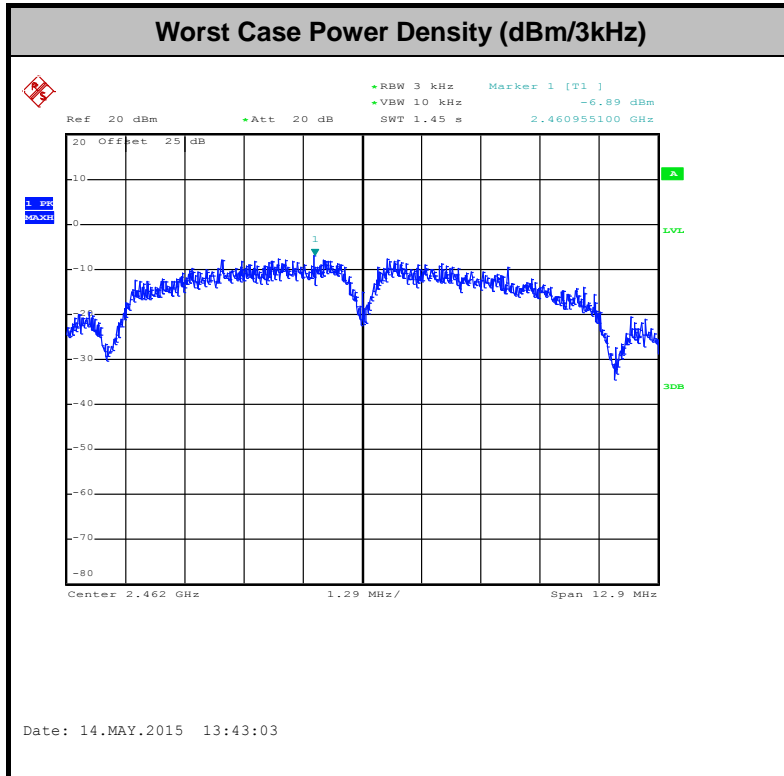

3.4 Conducted Band Edges and Spurious Emission Measurement

3.4.1 Limit of Conducted Band Edges and Spurious Emission Measurement

In any 100 kHz bandwidth outside of the authorized frequency band, the emissions which fall in the non-restricted bands shall be attenuated at least 20 dB / 30dB relative to the maximum PSD level in 100 kHz by RF conducted measurement and radiated emissions which fall in the restricted bands, as defined in Section 15.205(a), must also comply with the radiated emission limits specified in Section 15.209(a).

3.4.2 Measuring Instruments

The measuring equipment is listed in the section 4 of this test report.

3.4.3 Test Procedures

1. The testing follows FCC KDB Publication No. 558074 D01 DTS Meas. Guidance v03r03.
2. The RF output of EUT was connected to the spectrum analyzer by RF cable and attenuator. The path loss was compensated to the results for each measurement.
3. Set to the maximum power setting and enable the EUT transmit continuously.
4. Set RBW = 100 kHz, VBW=300 kHz, Peak Detector. Unwanted Emissions measured in any 100 kHz bandwidth outside of the authorized frequency band shall be attenuated by at least 20 dB relative to the maximum in-band peak PSD level in 100 kHz when maximum peak conducted output power procedure is used. If the transmitter complies with the conducted power limits based on the use of RMS averaging over a time interval, the attenuation required under this paragraph shall be 30 dB instead of 20 dB per 15.247(d).
5. Measure and record the results in the test report.
6. The RF fundamental frequency should be excluded against the limit line in the operating frequency band.

3.4.4 Test Setup

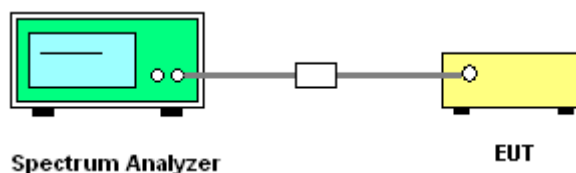



3.4.5 Test Result of Conducted Band Edges and Spurious Emission

Test Mode :	802.11b	Temperature :	21~25°C
Test Band :	2.4GHz Low	Relative Humidity :	51~54%
Test Channel :	01	Test Engineer :	William Liao

WLAN 802.11b Channel 01

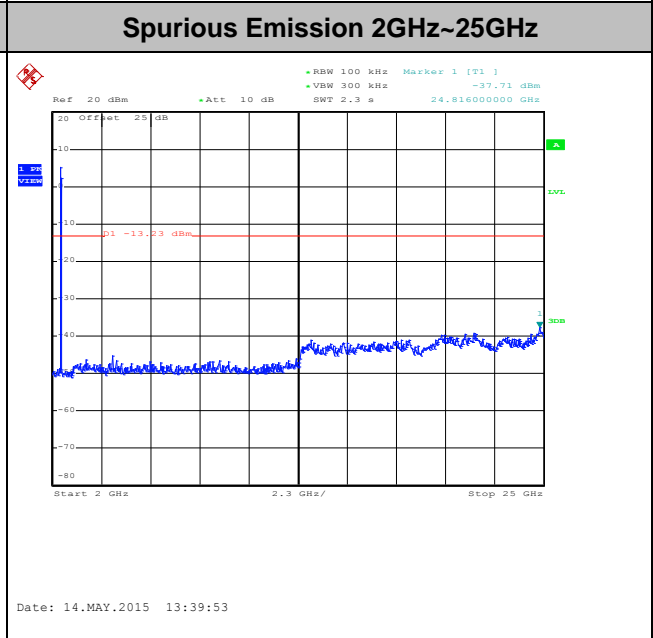
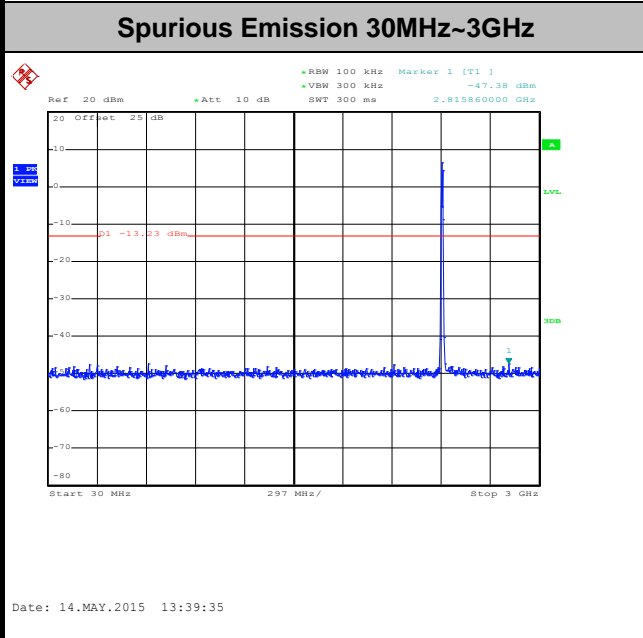
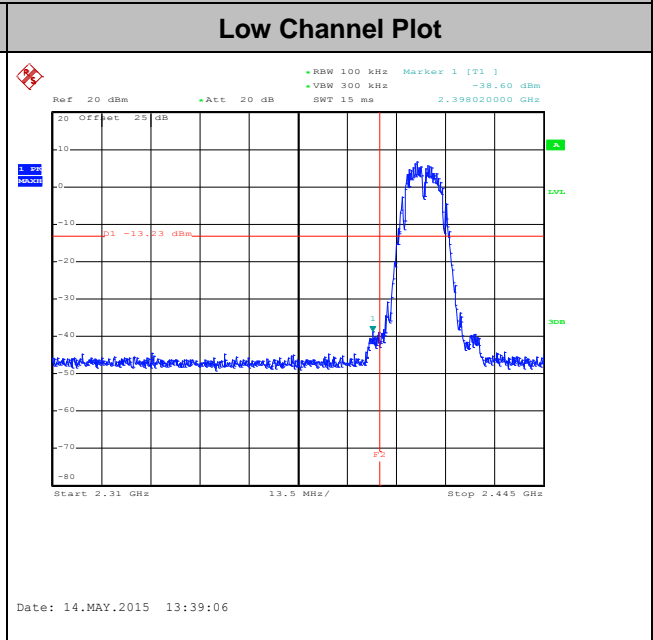
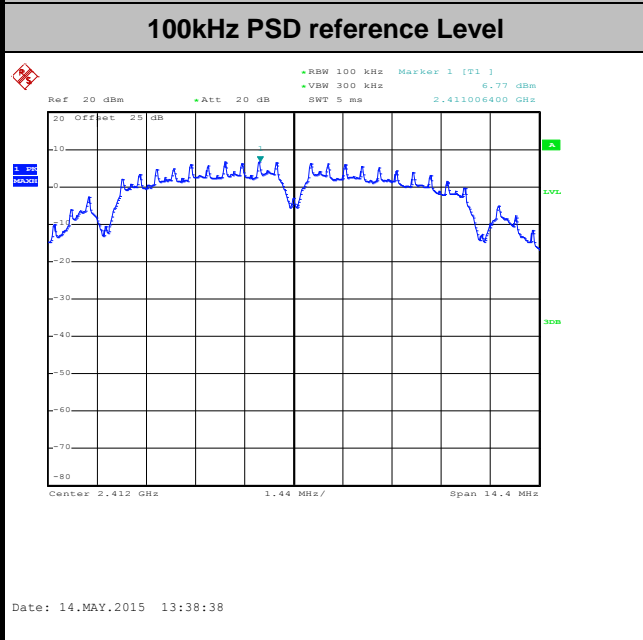



Test Mode :	802.11b	Temperature :	21~25°C
Test Band :	2.4GHz Mid	Relative Humidity :	51~54%
Test Channel :	06	Test Engineer :	William Liao

WLAN 802.11b Channel 06

100kHz PSD reference Level

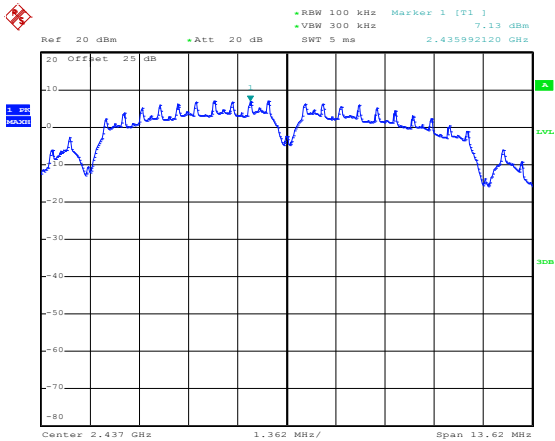

Date: 14.MAY.2015 12:01:57

Spurious Emission 30MHz~3GHz

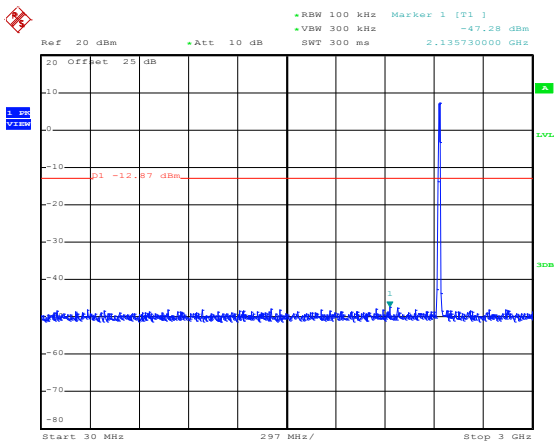

Date: 14.MAY.2015 12:02:22

Spurious Emission 2GHz~25GHz

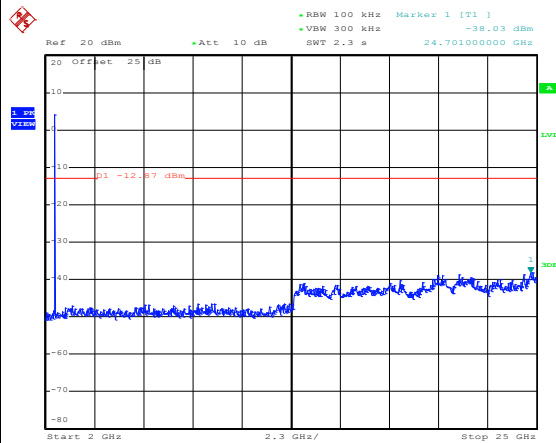

Date: 14.MAY.2015 12:02:40



Test Mode :	802.11b	Temperature :	21~25°C
Test Band :	2.4GHz High	Relative Humidity :	51~54%
Test Channel :	11	Test Engineer :	William Liao

WLAN 802.11b Channel 11

100kHz PSD reference Level

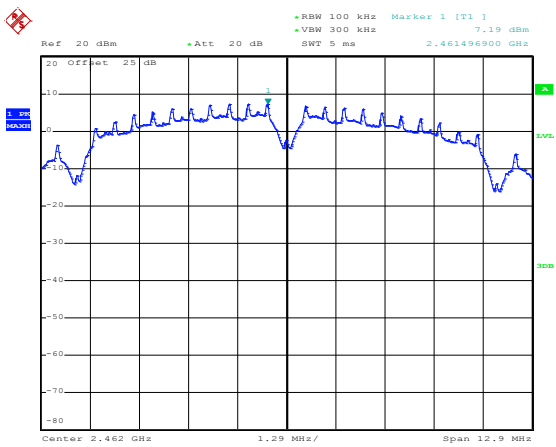

Date: 14.MAY.2015 13:43:32

High Channel Plot

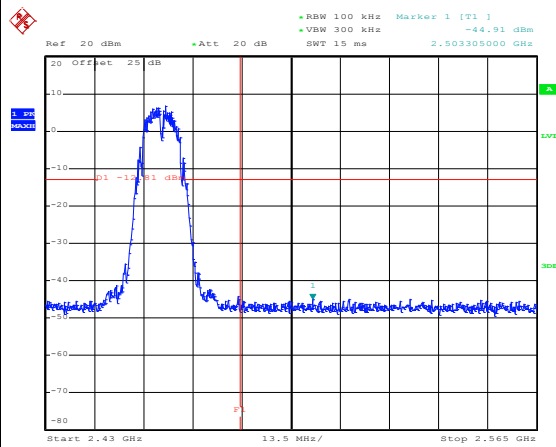

Date: 14.MAY.2015 13:44:16

Spurious Emission 30MHz~3GHz

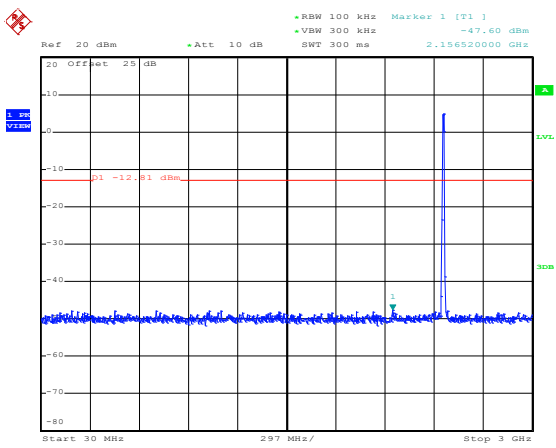

Date: 14.MAY.2015 13:44:46

Spurious Emission 2GHz~25GHz

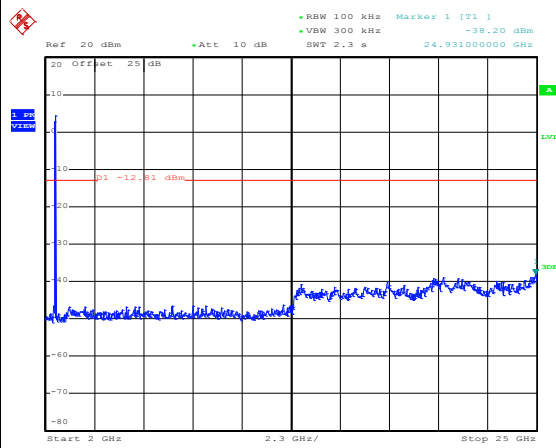

Date: 14.MAY.2015 13:45:04



Test Mode :	802.11g	Temperature :	21~25°C
Test Band :	2.4GHz Low	Relative Humidity :	51~54%
Test Channel :	01	Test Engineer :	William Liao

WLAN 802.11g Channel 01

100kHz PSD reference Level

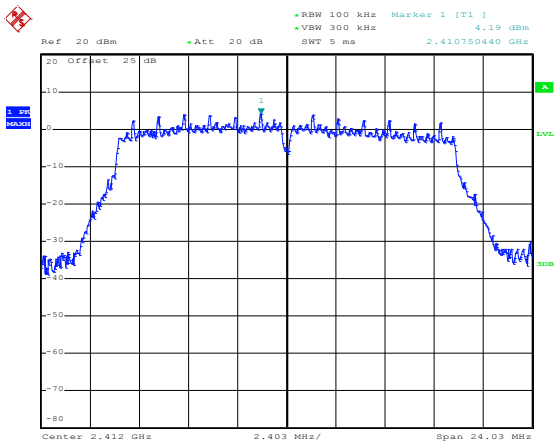

Date: 14.MAY.2015 14:17:30

Low Channel Plot

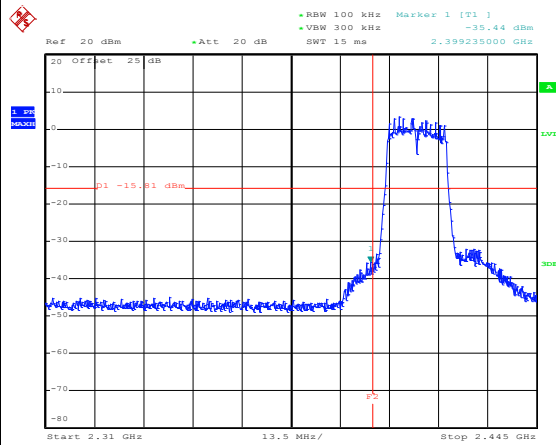

Date: 17.MAY.2015 15:31:42

Spurious Emission 30MHz~3GHz

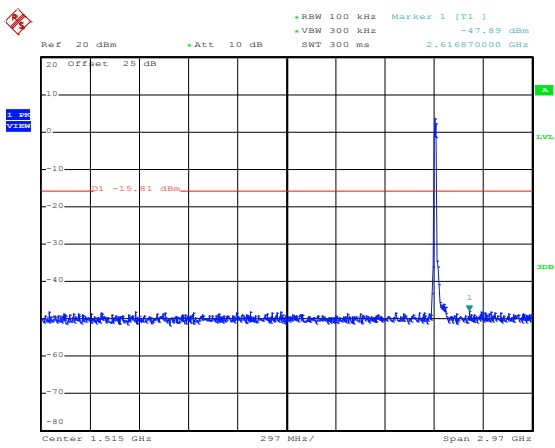

Date: 14.MAY.2015 14:18:34

Spurious Emission 2GHz~25GHz

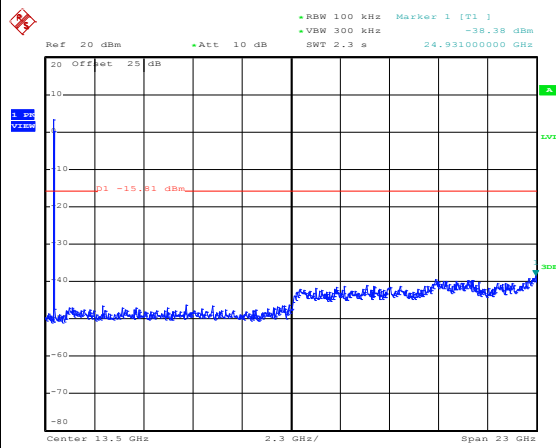

Date: 14.MAY.2015 14:18:53



Test Mode :	802.11g	Temperature :	21~25°C
Test Band :	2.4GHz Mid	Relative Humidity :	51~54%
Test Channel :	06	Test Engineer :	William Liao

WLAN 802.11g Channel 06

100kHz PSD reference Level

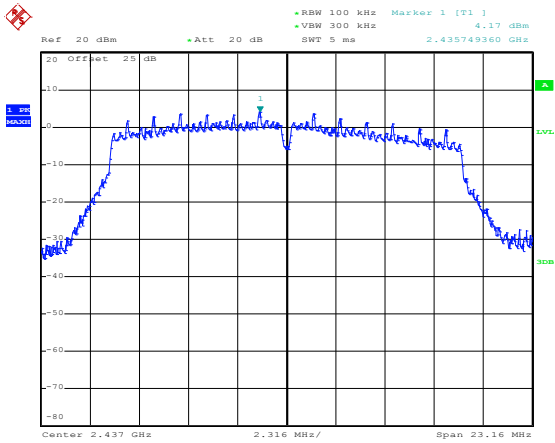

Date: 14.MAY.2015 14:12:38

Spurious Emission 30MHz~3GHz

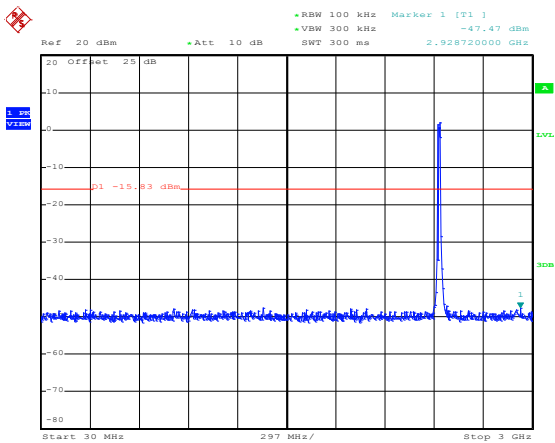

Date: 14.MAY.2015 14:13:04

Spurious Emission 2GHz~25GHz

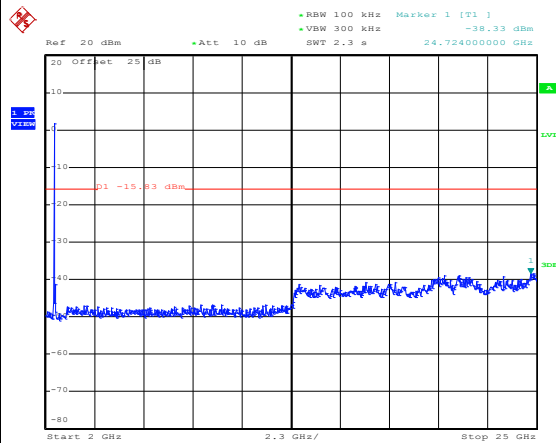

Date: 14.MAY.2015 14:13:22



Test Mode :	802.11g	Temperature :	21~25°C
Test Band :	2.4GHz High	Relative Humidity :	51~54%
Test Channel :	11	Test Engineer :	William Liao

WLAN 802.11g Channel 11

100kHz PSD reference Level

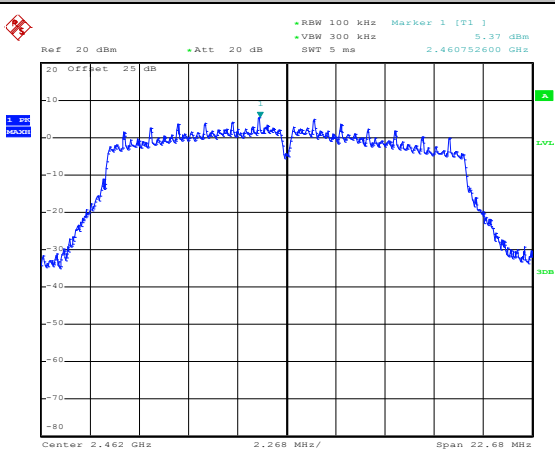

Date: 14.MAY.2015 14:23:34

High Channel Plot

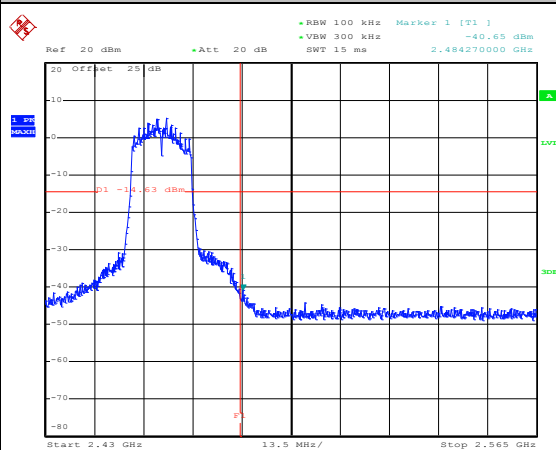

Date: 14.MAY.2015 14:23:52

Spurious Emission 30MHz~3GHz

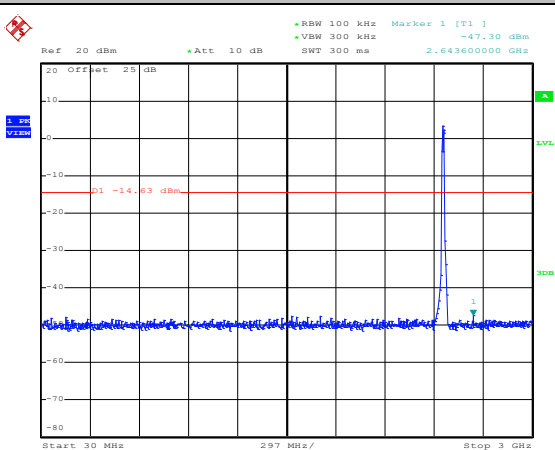

Date: 14.MAY.2015 14:24:27

Spurious Emission 2GHz~25GHz

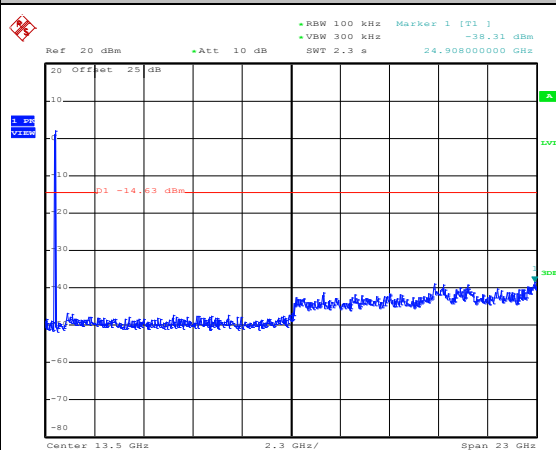

Date: 14.MAY.2015 14:24:45



Test Mode :	802.11n HT20	Temperature :	21~25°C
Test Band :	2.4GHz Low	Relative Humidity :	51~54%
Test Channel :	01	Test Engineer :	William Liao

WLAN 802.11n HT20 Channel 01

100kHz PSD reference Level

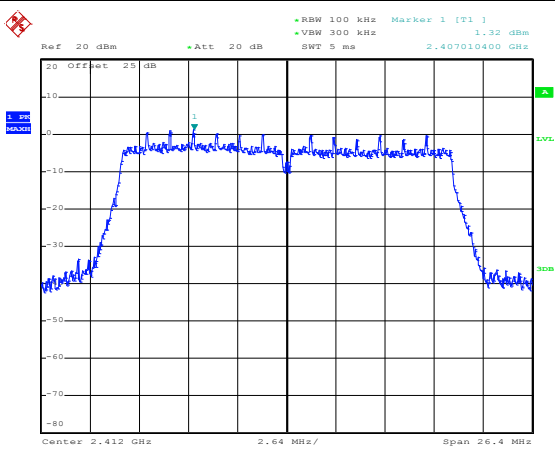

Date: 14.MAY.2015 14:31:41

Low Channel Plot

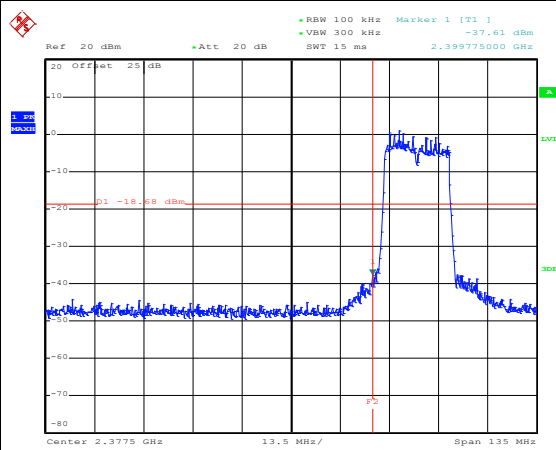

Date: 14.MAY.2015 14:32:05

Spurious Emission 30MHz~3GHz

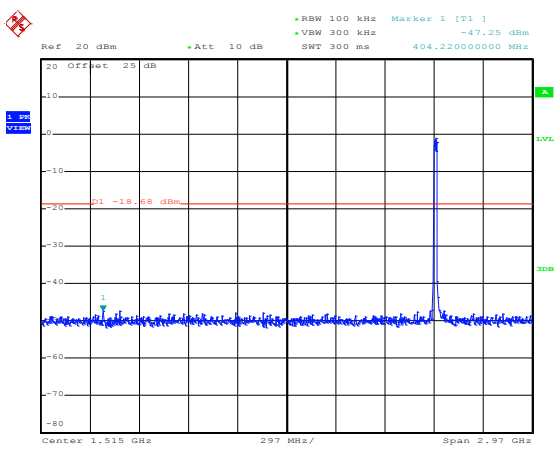

Date: 14.MAY.2015 14:32:30

Spurious Emission 2GHz~25GHz

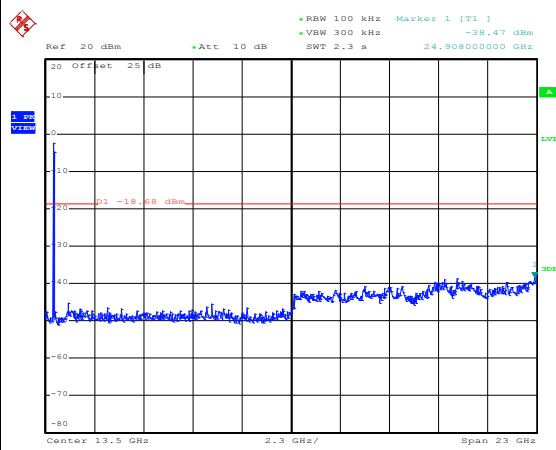

Date: 14.MAY.2015 14:32:49



Test Mode :	802.11n HT20	Temperature :	21~25°C
Test Band :	2.4GHz Mid	Relative Humidity :	51~54%
Test Channel :	06	Test Engineer :	William Liao

WLAN 802.11n HT20 Channel 06

100kHz PSD reference Level

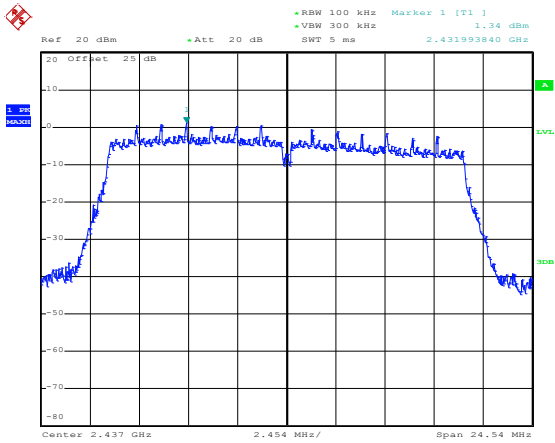

Date: 14.MAY.2015 14:38:10

Spurious Emission 30MHz~3GHz

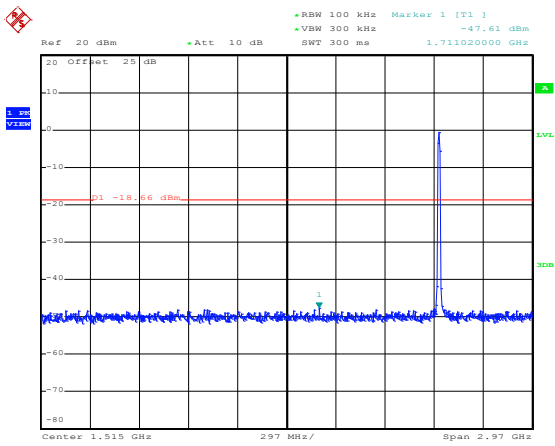

Date: 14.MAY.2015 14:38:34

Spurious Emission 2GHz~25GHz

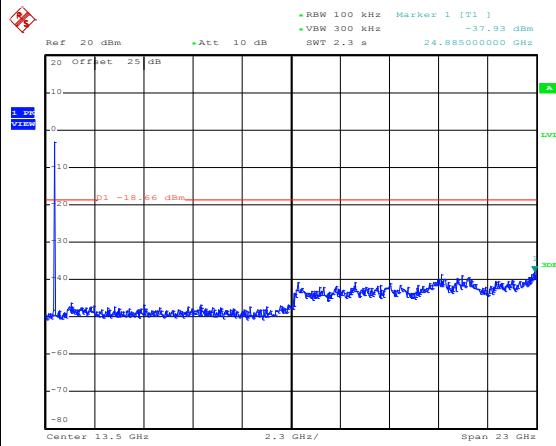

Date: 14.MAY.2015 14:38:52



Test Mode :	802.11n HT20	Temperature :	21~25°C
Test Band :	2.4GHz High	Relative Humidity :	51~54%
Test Channel :	11	Test Engineer :	William Liao

WLAN 802.11n HT20 Channel 11

100kHz PSD reference Level

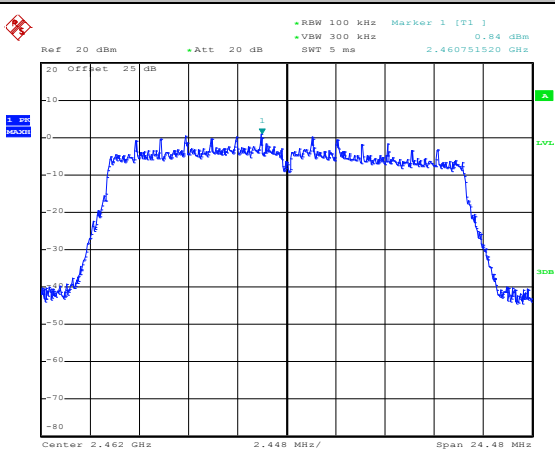

Date: 14.MAY.2015 14:42:00

High Channel Plot

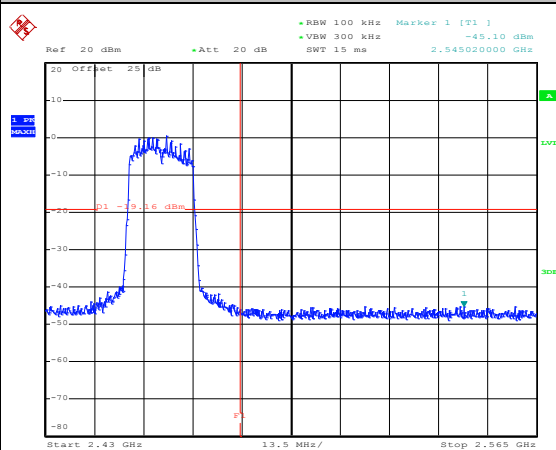

Date: 14.MAY.2015 14:42:20

Spurious Emission 30MHz~3GHz

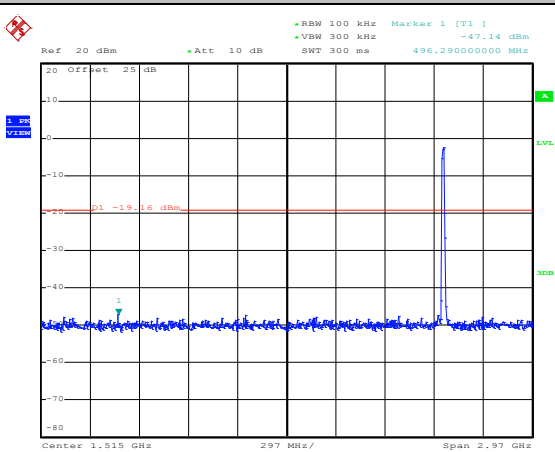

Date: 14.MAY.2015 14:42:43

Spurious Emission 2GHz~25GHz

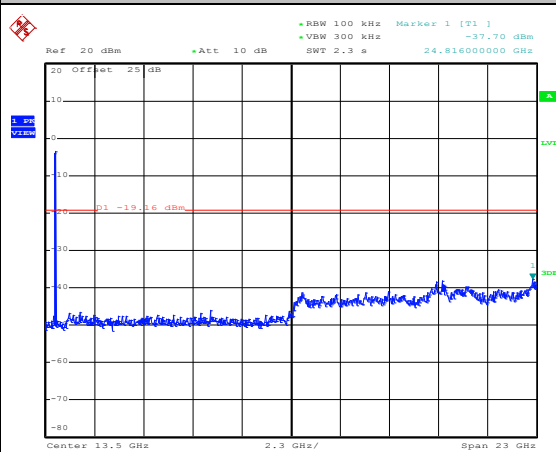

Date: 14.MAY.2015 14:43:01



Test Mode :	802.11n HT40	Temperature :	21~25°C
Test Band :	2.4GHz Low	Relative Humidity :	51~54%
Test Channel :	03	Test Engineer :	William Liao

WLAN 802.11n HT40 Channel 03

100kHz PSD reference Level

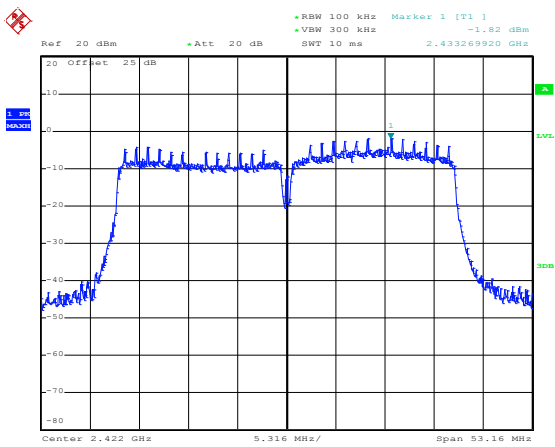

Date: 14.MAY.2015 14:52:47

Low Channel Plot

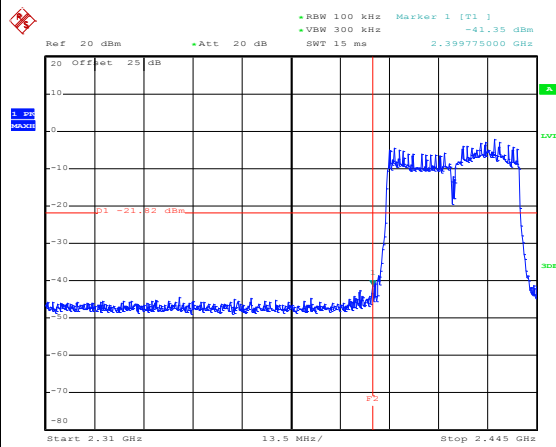

Date: 17.MAY.2015 15:36:22

Spurious Emission 30MHz~3GHz

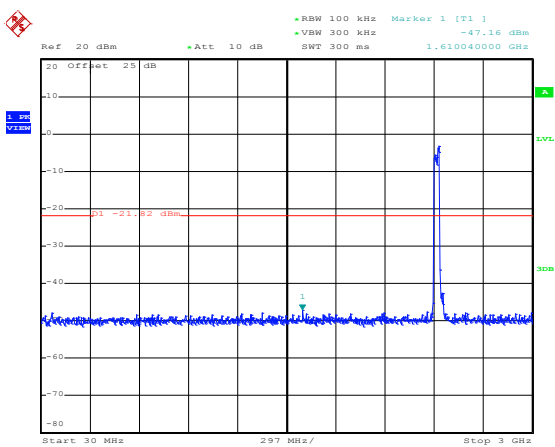

Date: 17.MAY.2015 15:47:00

Spurious Emission 2GHz~25GHz

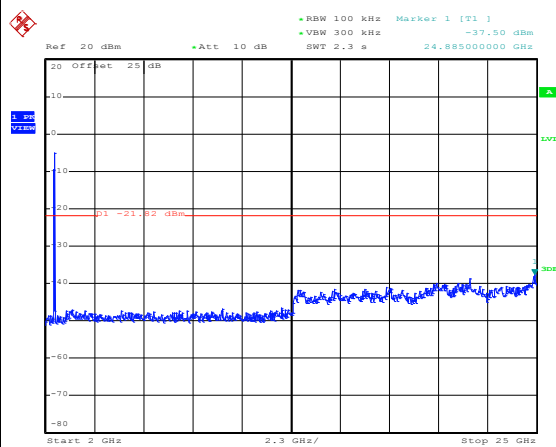

Date: 17.MAY.2015 15:46:26



Test Mode :	802.11n HT40	Temperature :	21~25°C
Test Band :	2.4GHz Mid	Relative Humidity :	51~54%
Test Channel :	06	Test Engineer :	William Liao

WLAN 802.11n HT40 Channel 06

100kHz PSD reference Level

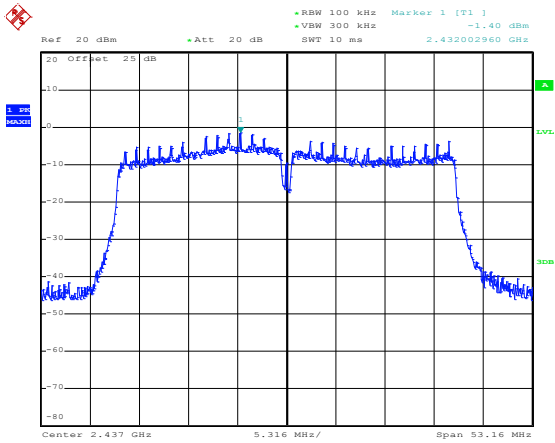

Date: 14.MAY.2015 15:00:48

Spurious Emission 30MHz~3GHz

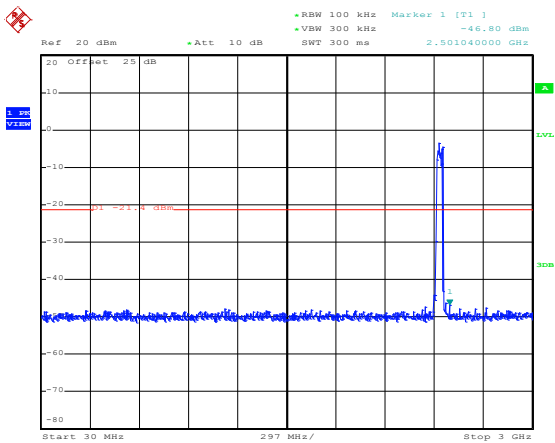

Date: 17.MAY.2015 15:44:51

Spurious Emission 2GHz~25GHz

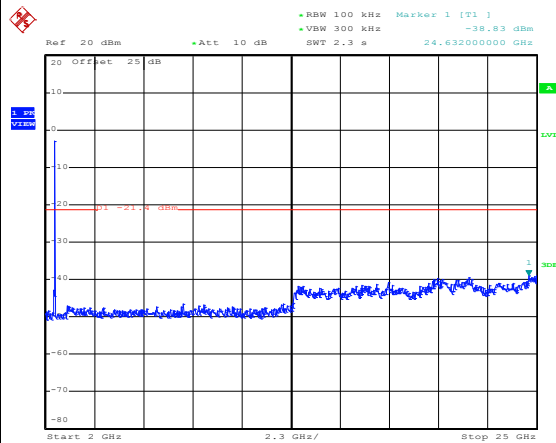

Date: 17.MAY.2015 15:44:15



Test Mode :	802.11n HT40	Temperature :	21~25°C
Test Band :	2.4GHz High	Relative Humidity :	51~54%
Test Channel :	09	Test Engineer :	William Liao

WLAN 802.11n HT40 Channel 09

100kHz PSD reference Level

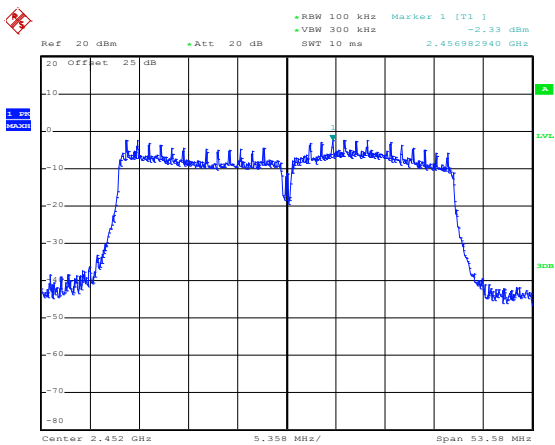

Date: 14.MAY.2015 15:12:34

High Channel Plot

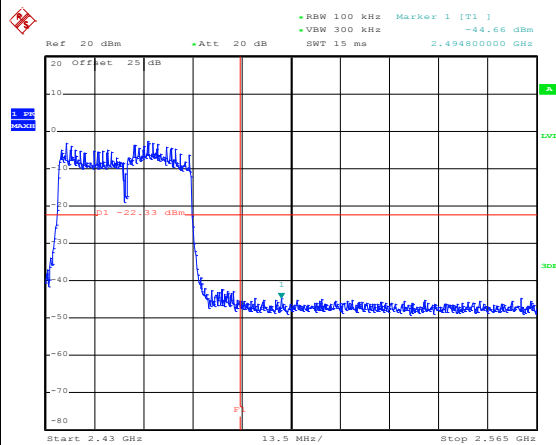

Date: 17.MAY.2015 15:37:47

Spurious Emission 30MHz~3GHz

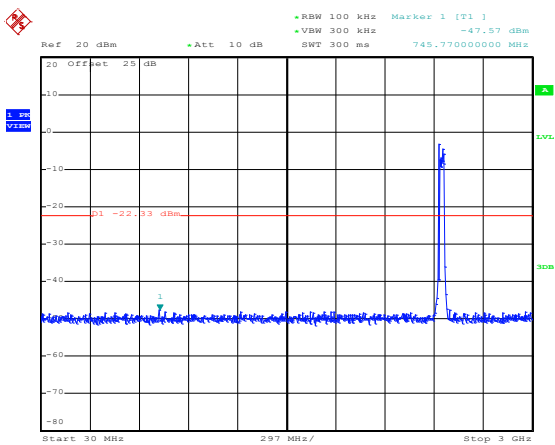

Date: 17.MAY.2015 15:42:59

Spurious Emission 2GHz~25GHz

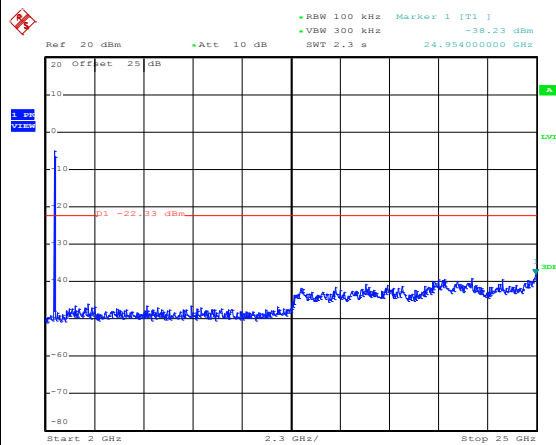

Date: 17.MAY.2015 15:42:03



3.5 Radiated Band Edges and Spurious Emission Measurement

3.5.1 Limit of Radiated band edge and Spurious Emission Measurement

In any 100 kHz bandwidth outside the intentional radiator frequency band, all harmonics/spurious must be at least 20 dB below the highest emission level within the authorized band. If the output power of this device was measured by spectrum analyzer, the attenuation under this paragraph shall be 30 dB instead of 20 dB. In addition, radiated emissions which fall in the restricted bands must also comply with the FCC section 15.209 limits as below.

Frequency (MHz)	Field Strength (microvolts/meter)	Measurement Distance (meters)
0.009 – 0.490	2400/F(kHz)	300
0.490 – 1.705	24000/F(kHz)	30
1.705 – 30.0	30	30
30 – 88	100	3
88 – 216	150	3
216 - 960	200	3
Above 960	500	3

3.5.2 Measuring Instruments

The measuring equipment is listed in the section 4 of this test report.



3.5.3 Test Procedures

1. The testing follows FCC KDB Publication No. 558074 D01 DTS Meas. Guidance v03r03.
2. The EUT was arranged to its worst case and then tune the antenna tower (from 1 m to 4 m) and turntable (from 0 degree to 360 degrees) to find the maximum reading. A pre-amp and a high pass filter are used for the test in order to get better signal level.
3. The EUT was placed on a turntable with 0.8 meter for frequency below 1GHz and 1.5 meter for frequency above 1GHz respectively above ground.
4. The EUT was set 3 meters from the interference receiving antenna, which was mounted on the top of a variable height antenna tower.
5. Corrected Reading: Antenna Factor + Cable Loss + Read Level - Preamp Factor = Level
6. For measurement below 1GHz, If the emission level of the EUT measured by the peak detector is 3 dB lower than the applicable limit, the peak emission level will be reported. Otherwise, the emission measurement will be repeated using the quasi-peak detector and reported.
7. Use the following spectrum analyzer settings:
 - (1) Span shall wide enough to fully capture the emission being measured;
 - (2) Set RBW=100 kHz for $f < 1$ GHz; $VBW \geq RBW$; Sweep = auto; Detector function = peak; Trace = max hold;
 - (3) Set RBW = 1 MHz, VBW= 3MHz for $f \geq 1$ GHz for peak measurement.

For average measurement:

 - $VBW = 10$ Hz, when duty cycle is no less than 98 percent.
 - $VBW \geq 1/T$, when duty cycle is less than 98 percent where T is the minimum transmission duration over which the transmitter is on and is transmitting at its maximum power control level for the tested mode of operation.

Band	Duty Cycle(%)	T(μs)	1/T(kHz)	VBW Setting
802.11b	97.9	8400	0.12	300Hz
802.11g	80.27	708	1.41	2kHz
2.4GHz 802.11n HT20	87.84	1300	0.77	1kHz
2.4GHz 802.11n HT40	79.27	650	1.54	2kHz

3.5.4 Test Setup

For radiated emissions below 30MHz

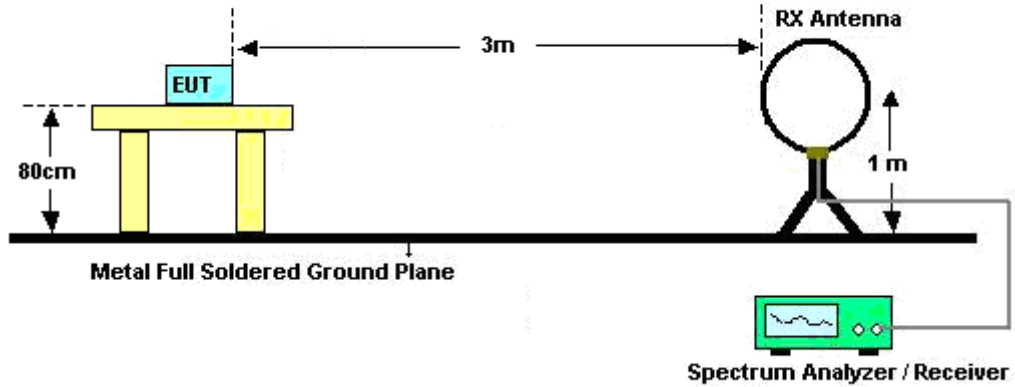

For radiated emissions from 30MHz to 1GHz

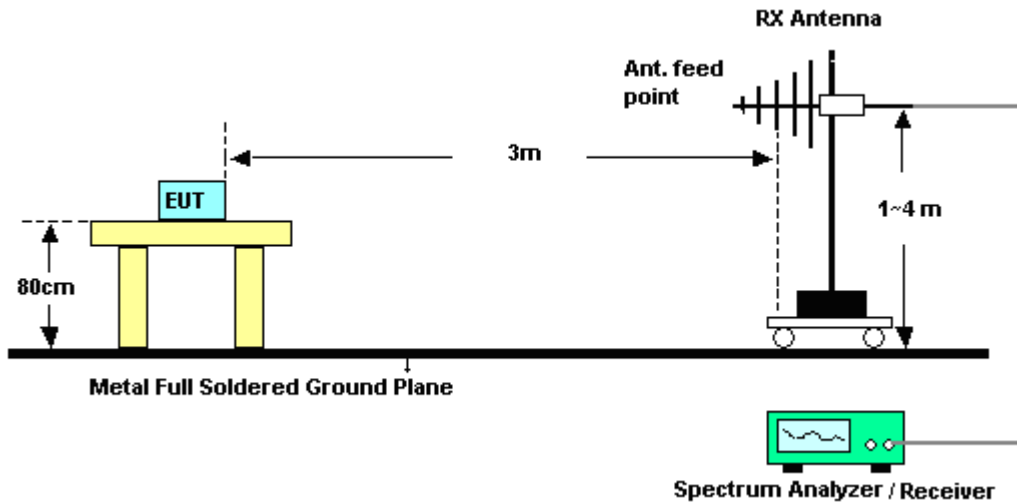

For radiated emissions above 1GHz

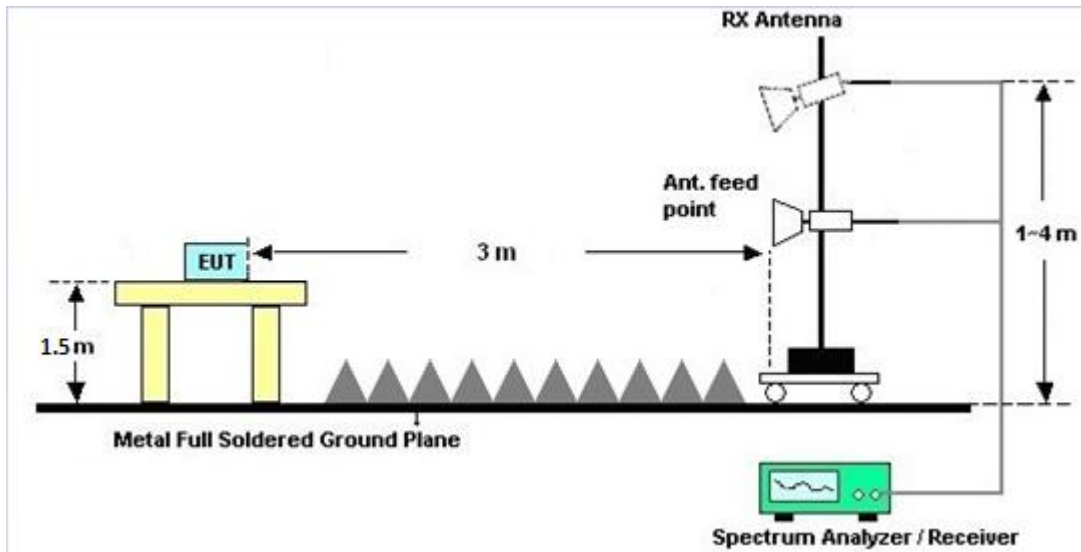

3.5.5 Test Results of Radiated Spurious Emissions (9kHz ~ 30MHz)

The low frequency, which started from 9 kHz to 30MHz, was pre-scanned and the result which was 20dB lower than the limit line per 15.31(o) was not reported.

3.5.6 Test Result of Radiated Spurious at Band Edges

Please refer to Appendix B.

3.5.7 Test Result of Radiated Spurious Emission (30MHz ~ 10th Harmonic)

Please refer to Appendix B.



3.6 AC Conducted Emission Measurement

3.6.1 Limit of AC Conducted Emission

For equipment that is designed to be connected to the public utility (AC) power line, the radio frequency voltage that is conducted back onto the AC power line on any frequency or frequencies within the band 150 kHz to 30 MHz shall not exceed the limits in the following table.

Frequency of Emission (MHz)	Conducted Limit (dBµV)	
	Quasi-Peak	Average
0.15-0.5	66 to 56*	56 to 46*
0.5-5	56	46
5-30	60	50

*Decreases with the logarithm of the frequency.

3.6.2 Measuring Instruments

The measuring equipment is listed in the section 4 of this test report.

3.6.3 Test Procedures

1. The EUT was placed 0.4 meter from the conducting wall of the shielding room, and it was kept at least 80 centimeters from any other grounded conducting surface.
2. Connect EUT to the power mains through a line impedance stabilization network (LISN).
3. All the support units are connecting to the other LISN.
4. The LISN provides 50 ohm coupling impedance for the measuring instrument.
5. The FCC states that a 50 ohm, 50 microhenry LISN should be used.
6. Both sides of AC line were checked for maximum conducted interference.
7. The frequency range from 150 kHz to 30 MHz was searched.
8. Set the test-receiver system to Peak Detect Function and specified bandwidth (IF bandwidth = 9kHz) with Maximum Hold Mode.

3.6.4 Test Setup

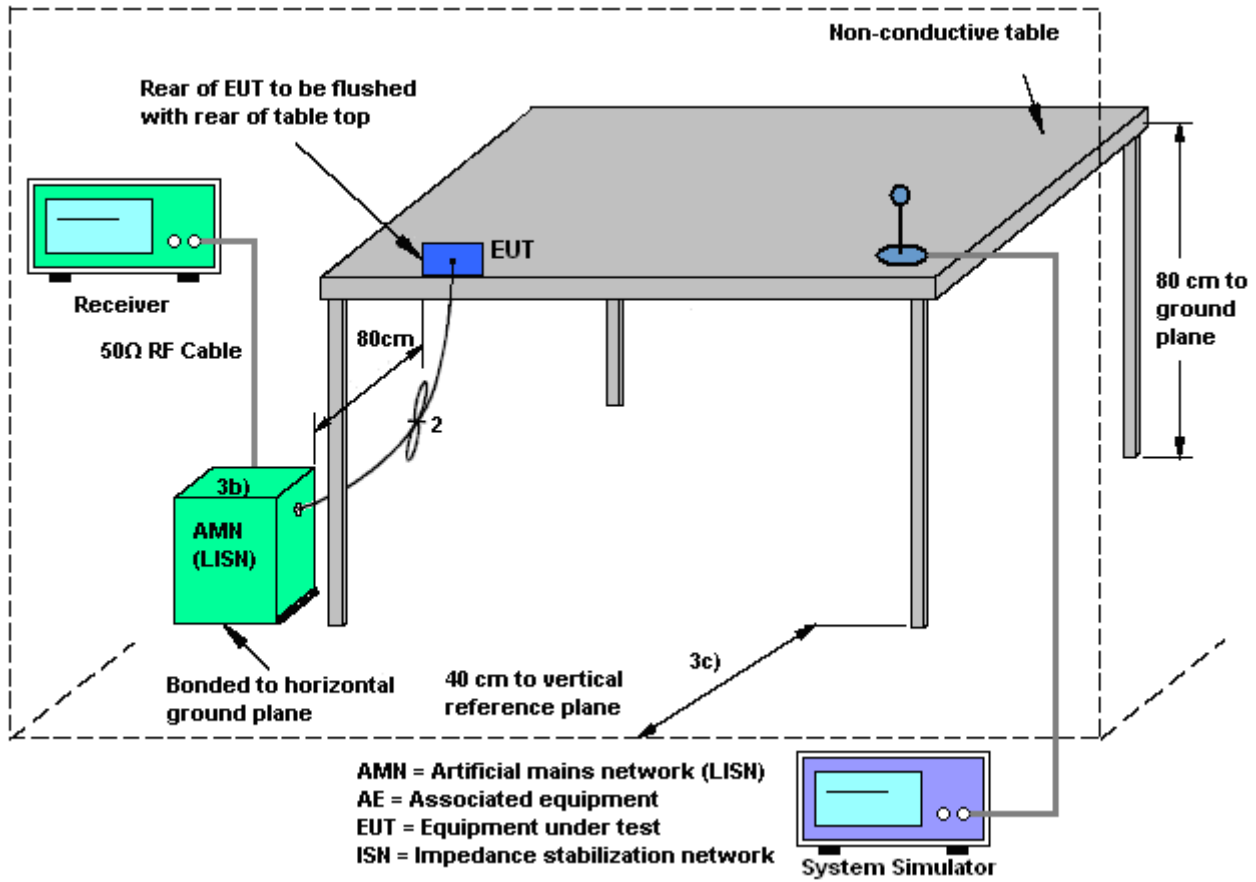



3.6.5 Test Result of AC Conducted Emission

Test Mode :	Mode 1	Temperature :	22~23°C
Test Engineer :	Kai-Chun Chu	Relative Humidity :	53~54%
Test Voltage :	120Vac / 60Hz	Phase :	Line
Function Type :	GSM1900 Idle + Bluetooth Link + WLAN (2.4GHz) Link + Earphone + Battery + USB Cable (Charging from Adapter) + MP3		

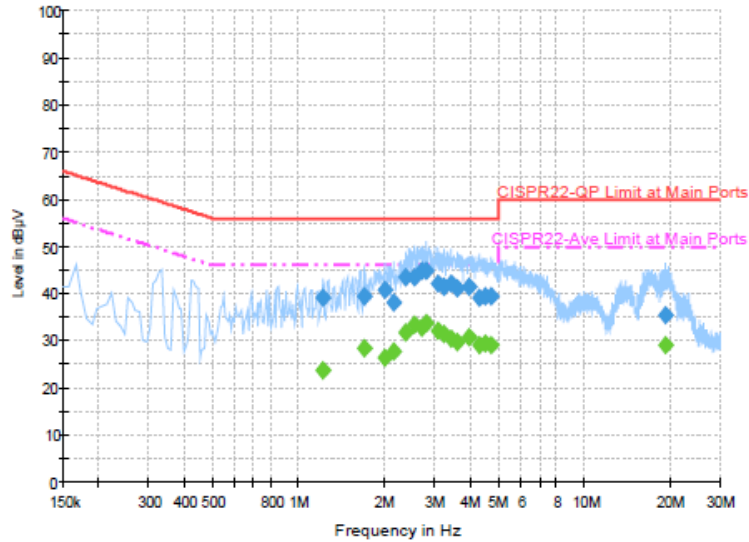

Final Result : Quasi-Peak

Frequency (MHz)	Quasi-Peak (dBµV)	Filter	Line	Corr. (dB)	Margin (dB)	Limit (dBµV)
1.222000	39.2	Off	L1	19.6	16.8	56.0
1.710000	39.5	Off	L1	19.6	16.5	56.0
2.014000	40.9	Off	L1	19.6	15.1	56.0
2.158000	38.1	Off	L1	19.7	17.9	56.0
2.374000	43.3	Off	L1	19.7	12.7	56.0
2.542000	43.5	Off	L1	19.7	12.5	56.0
2.710000	44.8	Off	L1	19.7	11.2	56.0
2.814000	44.7	Off	L1	19.7	11.3	56.0
3.086000	42.3	Off	L1	19.7	13.7	56.0
3.254000	41.3	Off	L1	19.7	14.7	56.0
3.446000	42.1	Off	L1	19.7	13.9	56.0
3.622000	41.0	Off	L1	19.7	15.0	56.0
3.966000	41.6	Off	L1	19.7	14.4	56.0
4.318000	39.0	Off	L1	19.7	17.0	56.0
4.534000	39.4	Off	L1	19.8	16.6	56.0
4.750000	39.5	Off	L1	19.8	16.5	56.0
19.230000	35.6	Off	L1	20.0	24.4	60.0



Test Mode :	Mode 1	Temperature :	22~23°C
Test Engineer :	Kai-Chun Chu	Relative Humidity :	53~54%
Test Voltage :	120Vac / 60Hz	Phase :	Line
Function Type :	GSM1900 Idle + Bluetooth Link + WLAN (2.4GHz) Link + Earphone + Battery + USB Cable (Charging from Adapter) + MP3		

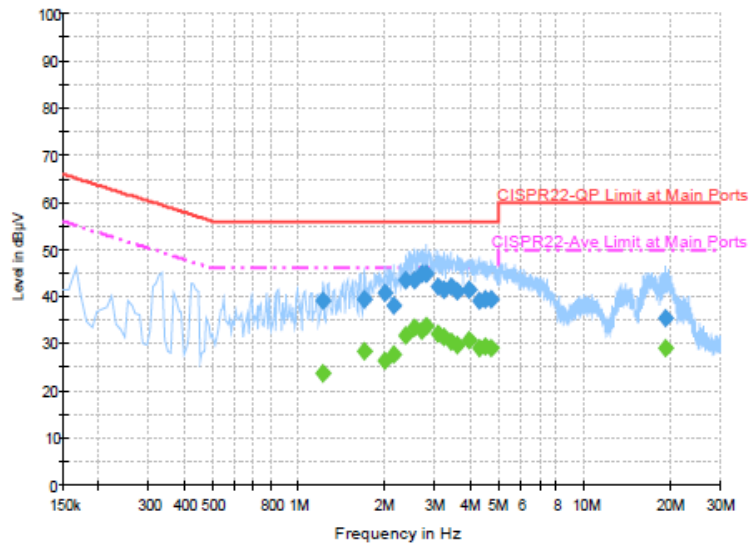

Final Result : Average

Frequency (MHz)	Average (dBµV)	Filter	Line	Corr. (dB)	Margin (dB)	Limit (dBµV)
1.222000	23.9	Off	L1	19.6	22.1	46.0
1.710000	28.4	Off	L1	19.6	17.6	46.0
2.014000	26.6	Off	L1	19.6	19.4	46.0
2.158000	27.8	Off	L1	19.7	18.2	46.0
2.374000	31.8	Off	L1	19.7	14.2	46.0
2.542000	33.6	Off	L1	19.7	12.4	46.0
2.710000	32.8	Off	L1	19.7	13.2	46.0
2.814000	33.8	Off	L1	19.7	12.2	46.0
3.086000	32.1	Off	L1	19.7	13.9	46.0
3.254000	31.4	Off	L1	19.7	14.6	46.0
3.446000	30.4	Off	L1	19.7	15.6	46.0
3.622000	29.9	Off	L1	19.7	16.1	46.0
3.966000	30.8	Off	L1	19.7	15.2	46.0
4.318000	29.1	Off	L1	19.7	16.9	46.0
4.534000	29.4	Off	L1	19.8	16.6	46.0
4.750000	29.1	Off	L1	19.8	16.9	46.0
19.230000	29.0	Off	L1	20.0	21.0	50.0



Test Mode :	Mode 1	Temperature :	22~23°C
Test Engineer :	Kai-Chun Chu	Relative Humidity :	53~54%
Test Voltage :	120Vac / 60Hz	Phase :	Neutral
Function Type :	GSM1900 Idle + Bluetooth Link + WLAN (2.4GHz) Link + Earphone + Battery + USB Cable (Charging from Adapter) + MP3		

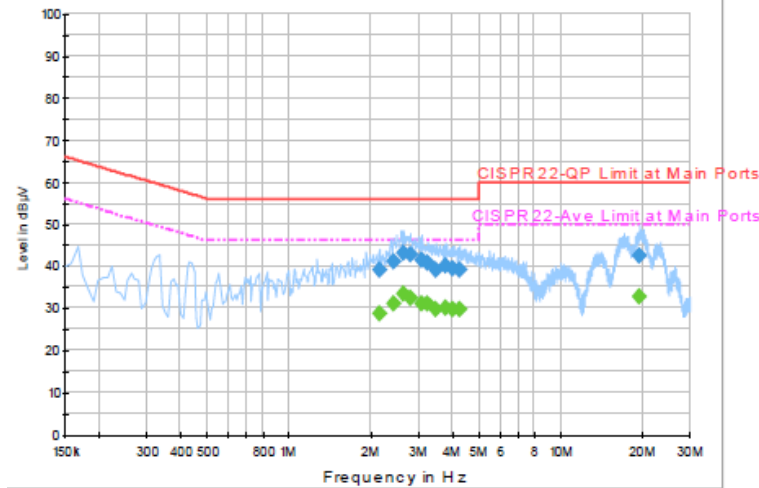

Final Result : Quasi-Peak

Frequency (MHz)	Quasi-Peak (dBµV)	Filter	Line	Corr. (dB)	Margin (dB)	Limit (dBµV)
2.150000	39.1	Off	N	19.7	16.9	56.0
2.422000	41.2	Off	N	19.7	14.8	56.0
2.646000	43.1	Off	N	19.6	12.9	56.0
2.814000	42.9	Off	N	19.7	13.1	56.0
3.094000	41.6	Off	N	19.7	14.4	56.0
3.254000	40.8	Off	N	19.7	15.2	56.0
3.462000	39.2	Off	N	19.7	16.8	56.0
3.758000	40.0	Off	N	19.7	16.0	56.0
4.030000	39.4	Off	N	19.7	16.6	56.0
4.254000	39.1	Off	N	19.7	16.9	56.0
19.646000	42.3	Off	N	20.1	17.7	60.0

Final Result : Average

Frequency (MHz)	Average (dBµV)	Filter	Line	Corr. (dB)	Margin (dB)	Limit (dBµV)
2.150000	28.7	Off	N	19.7	17.3	46.0
2.422000	31.0	Off	N	19.7	15.0	46.0
2.646000	33.3	Off	N	19.6	12.7	46.0
2.814000	32.4	Off	N	19.7	13.6	46.0
3.094000	31.1	Off	N	19.7	14.9	46.0
3.254000	31.1	Off	N	19.7	14.9	46.0
3.462000	29.8	Off	N	19.7	16.2	46.0
3.758000	30.1	Off	N	19.7	15.9	46.0
4.030000	29.8	Off	N	19.7	16.2	46.0
4.254000	29.6	Off	N	19.7	16.4	46.0
19.646000	32.8	Off	N	20.1	17.2	50.0



3.7 Antenna Requirements

3.7.1 Standard Applicable

If directional gain of transmitting antennas is greater than 6dBi, the power shall be reduced by the same level in dB comparing to gain minus 6dBi. For the fixed point-to-point operation, the power shall be reduced by one dB for every 3 dB that the directional gain of the antenna exceeds 6 dBi. The use of a permanently attached antenna or of an antenna that uses a unique coupling to the intentional radiator shall be considered sufficient to comply with the FCC rule.

3.7.2 Antenna Anti-Replacement Construction

An embedded-in antenna design is used.

3.7.3 Antenna Gain

The antenna peak gain of EUT is less than 6 dBi. Therefore, it is not necessary to reduce maximum peak output power limit.



4 List of Measuring Equipment

Instrument	Manufacturer	Model No.	Serial No.	Characteristics	Calibration Date	Test Date	Due Date	Remark
Power Meter	Anritsu	ML2495A	1036004	300MHz~40GHz	Aug. 09, 2014	May 12, 2015~ May 17, 2015	Aug. 08, 2015	Conducted (TH02-HY)
Power Sensor	Anritsu	MA2411B	1027253	300MHz~40GHz	Aug. 11, 2014	May 12, 2015~ May 17, 2015	Aug. 10, 2015	Conducted (TH02-HY)
Spectrum Analyzer	Rohde & Schwarz	FSP40	100055	9kHz~40GHz	Jun. 09, 2014	May 12, 2015~ May 17, 2015	Jun. 08, 2015	Conducted (TH02-HY)
Hygrometer	Testo	608-H2	41410069	N/A	Jul. 17, 2014	May 12, 2015~ May 17, 2015	Jul. 16, 2015	Conducted (TH02-HY)
RF Cable	HARBOUR INDUSTRIES	LL142	Infinet CA3601-360 1-DLL	0.1MHz~40GHz	Mar. 06, 2015	May 12, 2015~ May 17, 2015	Mar. 05, 2016	Conducted (TH02-HY)
Amplifier	SONOMA	310N	187312	9kHz~1GHz	Nov. 24, 2014	May 18, 2015~ May 20, 2015	Nov. 23, 2015	Radiation (03CH11-HY)
Bilog Antenna	TESEQ	CBL 6111D	35414	30MHz~1GHz	Oct. 24, 2014	May 18, 2015~ May 20, 2015	Oct. 23, 2015	Radiation (03CH11-HY)
Horn Antenna	SCHWARZBECK	BBHA 9120 D	9120D-1326	1GHz ~ 18GHz	Oct. 03, 2014	May 18, 2015~ May 20, 2015	Oct. 02, 2015	Radiation (03CH11-HY)
Hygrometer	TECPEL	DTN-303B	TP140325	N/A	Nov. 19, 2014	May 18, 2015~ May 20, 2015	Nov. 18, 2015	Radiation (03CH11-HY)
Preamplifier	Keysight	83017A	MY53270080	1GHz~26.5GHz	Nov. 20, 2014	May 18, 2015~ May 20, 2015	Nov. 19, 2015	Radiation (03CH11-HY)
Spectrum Analyzer	Keysight	N9010A	MY54200486	10Hz ~ 44GHZ	Sep. 24, 2014	May 18, 2015~ May 20, 2015	Sep. 23, 2015	Radiation (03CH11-HY)
RF Cable	HUBER + SUHNER	SUCOFLEX 104	MY24967/4 MY28419/4 MY28654/4	25GHz~40GHz	Nov. 06, 2014	May 18, 2015~ May 20, 2015	Nov. 05, 2015	Radiation (03CH11-HY)
RF Cable	HUBER + SUHNER	SUCOFLEX 104	MY24967/4 MY28419/4 MY28654/4	30MHz~1GHz	Nov. 06, 2014	May 18, 2015~ May 20, 2015	Nov. 05, 2015	Radiation (03CH11-HY)
RF Cable	HUBER + SUHNER	SUCOFLEX 104	MY24967/4 MY28419/4 MY28654/4	1GHz~25GHz	Nov. 06, 2014	May 18, 2015~ May 20, 2015	Nov. 05, 2015	Radiation (03CH11-HY)
Controller	EMEC	EM 1000	N/A	Control Turn table & Ant Mast	N/A	May 18, 2015~ May 20, 2015	N/A	Radiation (03CH11-HY)
Antenna Mast	EMEC	AM-BS-4500-B	N/A	1~4m	N/A	May 18, 2015~ May 20, 2015	N/A	Radiation (03CH11-HY)
Turn Table	EMEC	TT 2000	N/A	0-360 degree	N/A	May 18, 2015~ May 20, 2015	N/A	Radiation (03CH11-HY)



Instrument	Manufacturer	Model No.	Serial No.	Characteristics	Calibration Date	Test Date	Due Date	Remark
Preamplifier	MITEQ	JS44-180040 00-33-8P	1840917	18GHz ~ 40GHz	Jun. 09, 2014	May 18, 2015~ May 20, 2015	Jun. 08, 2015	Radiation (03CH11-HY)
Loop Antenna	Rohde & Schwarz	HFH2-Z2	100315	9 kHz~30 MHz	Jul. 28, 2014	May 18, 2015~ May 20, 2015	Jul. 27, 2015	Radiation (03CH11-HY)
Horn Antenna	SCHWARZBE CK	BBHA 9170	BBHA91705 84	18GHz- 40GHz	Nov. 03, 2014	May 18, 2015~ May 20, 2015	Nov. 02, 2015	Radiation (03CH11-HY)
EMI Test Receiver	Rohde & Schwarz	ESCS 30	100356	9kHz – 2.75GHz	Dec. 01, 2014	May 14, 2015	Nov. 30, 2015	Conduction (CO05-HY)
Hygrometer	Testo	608-H1	34913912	N/A	Apr. 20, 2015	May 14, 2015	Apr. 19, 2016	Conduction (CO05-HY)
LISN	Rohde & Schwarz	ENV216	100080	9kHz~30MHz	Dec. 02, 2014	May 14, 2015	Dec. 01, 2015	Conduction (CO05-HY)
LISN (for auxiliary equipment)	Rohde & Schwarz	ENV216	100081	9kHz ~ 30MHz	Dec. 08, 2014	May 14, 2015	Dec. 07, 2015	Conduction (CO05-HY)
AC Power Source	ChainTek	APC-1000W	N/A	N/A	N/A	May 14, 2015	N/A	Conduction (CO05-HY)
LF Cable	HUBER + SUHNER	RG-214/U	LF01	N/A	Jan. 02, 2015	May 14, 2015	Jan. 01, 2016	Conduction (CO05-HY)

Note: Test equipment calibration is traceable to the procedure of ISO17025.



5 Uncertainty of Evaluation

Uncertainty of Conducted Emission Measurement (150kHz ~ 30MHz)

Measuring Uncertainty for a Level of Confidence of 95% ($U = 2Uc(y)$)	2.26
---	------

Uncertainty of Radiated Emission Measurement (30 MHz ~ 1000 MHz)

Measuring Uncertainty for a Level of Confidence of 95% ($U = 2Uc(y)$)	4.90
---	------



Appendix A. Conducted Test Results

A1 - DTS Part

Test Engineer:	William Liao	Temperature:	21~25	°C
Test Date:	2015/05/12~2015/05/17	Relative Humidity:	51~54	%

TEST RESULTS DATA
6dB and 99% Occupied Bandwidth

2.4GHz Band								
Mod.	Data Rate	N _{TX}	CH.	Freq. (MHz)	99% Occupied BW (MHz)	6dB BW (MHz)	6dB BW Limit (MHz)	Pass/Fail
11b	1Mbps	1	1	2412	12.65	9.60	0.50	Pass
11b	1Mbps	1	6	2437	12.35	9.08	0.50	Pass
11b	1Mbps	1	11	2462	12.05	8.60	0.50	Pass
11g	12Mbps	1	1	2412	17.30	16.02	0.50	Pass
11g	12Mbps	1	6	2437	17.15	15.44	0.50	Pass
11g	12Mbps	1	11	2462	17.05	15.12	0.50	Pass
HT20	MCS0	1	1	2412	18.50	17.60	0.50	Pass
HT20	MCS0	1	6	2437	18.30	16.36	0.50	Pass
HT20	MCS0	1	11	2462	18.20	16.32	0.50	Pass
HT40	MCS0	1	3	2422	36.40	35.44	0.50	Pass
HT40	MCS0	1	6	2437	36.50	35.44	0.50	Pass
HT40	MCS0	1	9	2452	36.50	35.72	0.50	Pass

TEST RESULTS DATA
Peak Power Table

2.4GHz Band										
Mod.	Data Rate	N _{TX}	CH.	Freq. (MHz)	Peak Conducted Power (dBm)	Conducted Power Limit (dBm)	DG (dBi)	EIRP Power (dBm)	EIRP Power Limit (dBm)	Pass /Fail
11b	1Mbps	1	1	2412	18.64	30.00	-6.90	11.74	36.00	Pass
11b	1Mbps	1	6	2437	18.85	30.00	-6.90	11.95	36.00	Pass
11b	1Mbps	1	11	2462	18.61	30.00	-6.90	11.71	36.00	Pass
11g	12Mbps	1	1	2412	24.15	30.00	-6.90	17.25	36.00	Pass
11g	12Mbps	1	6	2437	24.00	30.00	-6.90	17.10	36.00	Pass
11g	12Mbps	1	11	2462	24.31	30.00	-6.90	17.41	36.00	Pass
HT20	MCS0	1	1	2412	21.56	30.00	-6.90	14.66	36.00	Pass
HT20	MCS0	1	6	2437	21.51	30.00	-6.90	14.61	36.00	Pass
HT20	MCS0	1	11	2462	21.25	30.00	-6.90	14.35	36.00	Pass
HT40	MCS0	1	3	2422	22.13	30.00	-6.90	15.23	36.00	Pass
HT40	MCS0	1	6	2437	21.63	30.00	-6.90	14.73	36.00	Pass
HT40	MCS0	1	9	2452	21.59	30.00	-6.90	14.69	36.00	Pass

TEST RESULTS DATA
Average Power Table
(Reporting Only)

2.4GHz Band						
Mod.	Data Rate	N _{TX}	CH.	Freq. (MHz)	Duty Factor (dB)	Average Conducted Power (dBm)
11b	1Mbps	1	1	2412	0.09	15.57
11b	1Mbps	1	6	2437	0.09	15.60
11b	1Mbps	1	11	2462	0.09	15.54
11g	12Mbps	1	1	2412	0.95	14.52
11g	12Mbps	1	6	2437	0.95	14.37
11g	12Mbps	1	11	2462	0.95	14.60
HT20	MCS0	1	1	2412	0.56	11.60
HT20	MCS0	1	6	2437	0.56	11.51
HT20	MCS0	1	11	2462	0.56	11.50
HT40	MCS0	1	3	2422	1.01	11.09
HT40	MCS0	1	6	2437	1.01	11.08
HT40	MCS0	1	9	2452	1.01	11.02

TEST RESULTS DATA
Peak Power Density

2.4GHz Band								
Mod.	Data Rate	N _{TX}	CH.	Freq. (MHz)	Peak PSD (dBm /3kHz)	DG (dBi)	Peak PSD Limit (dBm /3kHz)	Pass/Fail
11b	1Mbps	1	1	2412	-7.69	-6.90	8.00	Pass
11b	1Mbps	1	6	2437	-7.32	-6.90	8.00	Pass
11b	1Mbps	1	11	2462	-6.89	-6.90	8.00	Pass
11g	12Mbps	1	1	2412	-9.84	-6.90	8.00	Pass
11g	12Mbps	1	6	2437	-10.70	-6.90	8.00	Pass
11g	12Mbps	1	11	2462	-9.29	-6.90	8.00	Pass
HT20	MCS0	1	1	2412	-13.47	-6.90	8.00	Pass
HT20	MCS0	1	6	2437	-12.67	-6.90	8.00	Pass
HT20	MCS0	1	11	2462	-11.31	-6.90	8.00	Pass
HT40	MCS0	1	3	2422	-14.95	-6.90	8.00	Pass
HT40	MCS0	1	6	2437	-13.08	-6.90	8.00	Pass
HT40	MCS0	1	9	2452	-13.98	-6.90	8.00	Pass



Appendix B. Radiated Spurious Emission

Test Engineer :	Jesse Wang and Derreck Chen	Temperature :	22~24°C
		Relative Humidity :	45~48%

2.4GHz 2400~2483.5MHz

WIFI 802.11b (Band Edge @ 3m)

WIFI	Note	Frequency	Level	Over	Limit	Read	Antenna	Cable	Preamp	Ant	Table	Peak	Pol.	
Ant.				Limit	Line	Level	Factor	Loss	Factor	Pos	Pos	Avg.		
1		(MHz)	(dBμV/m)	(dB)	(dBμV/m)	(dBμV)	(dB/m)	(dB)	(dB)	(cm)	(deg)	(P/A)	(H/V)	
802.11b CH 01 2412MHz		2358.42	53.23	-20.77	74	54.19	27.14	5.95	34.05	145	4	P	H	
		2373.99	41.95	-12.05	54	42.79	27.19	6.01	34.04	145	4	A	H	
	*	2410.44	103.01	-	-	103.73	27.28	6.04	34.04	145	4	P	H	
	*	2410.19	100.53	-	-	101.25	27.28	6.04	34.04	145	4	A	H	
													H	
														H
			2317.29	52.49	-21.51	74	53.65	27.01	5.89	34.06	205	273	P	V
			2389.92	41.91	-12.09	54	42.71	27.23	6.01	34.04	205	273	A	V
	*		2410.35	97.42	-	-	98.14	27.28	6.04	34.04	205	273	P	V
	*		2409.94	94.96	-	-	95.68	27.28	6.04	34.04	205	273	A	V
														V
														V
802.11b CH 06 2437MHz		2351.94	52.71	-21.29	74	53.67	27.14	5.95	34.05	100	3	P	H	
		2375.34	42.4	-11.6	54	43.24	27.19	6.01	34.04	100	3	A	H	
	*	2437	106.49	-	-	107.11	27.37	6.04	34.03	100	3	P	H	
	*	2437	103.93	-	-	104.55	27.37	6.04	34.03	100	3	A	H	
			2497.08	53.18	-20.82	74	53.59	27.5	6.09	34	100	3	P	H
			2483.52	42.96	-11.04	54	43.42	27.46	6.09	34.01	100	3	A	H
			2380.2	52.62	-21.38	74	53.46	27.19	6.01	34.04	223	266	P	V
			2379.48	42.31	-11.69	54	43.15	27.19	6.01	34.04	223	266	A	V
	*		2437	101.38	-	-	102	27.37	6.04	34.03	223	266	P	V
	*		2437	99.02	-	-	99.64	27.37	6.04	34.03	223	266	A	V
			2493.32	53.84	-20.16	74	54.25	27.5	6.09	34	223	266	P	V
			2486.4	42.71	-11.29	54	43.17	27.46	6.09	34.01	223	266	A	V



802.11b CH 11 2462MHz	*	2463.54	105.33	-	-	105.87	27.41	6.07	34.02	118	3	P	H
	*	2463.63	102.83	-	-	103.37	27.41	6.07	34.02	118	3	A	H
		2484.4	53.42	-20.58	74	53.88	27.46	6.09	34.01	118	3	P	H
		2483.52	42.91	-11.09	54	43.37	27.46	6.09	34.01	118	3	A	H
													H
													H
	*	2463.54	100.41	-	-	100.95	27.41	6.07	34.02	225	264	P	V
	*	2463.63	97.88	-	-	98.42	27.41	6.07	34.02	225	264	A	V
		2499.84	52.85	-21.15	74	53.26	27.5	6.09	34	225	264	P	V
		2483.6	42.72	-11.28	54	43.18	27.46	6.09	34.01	225	264	A	V
													V
													V
Remark	1. No other spurious found. 2. All results are PASS against Peak and Average limit line.												



2.4GHz 2400~2483.5MHz

WIFI 802.11b (Harmonic @ 3m)

WIFI Ant. 1	Note	Frequency (MHz)	Level (dBμV/m)	Over Limit (dB)	Limit Line (dBμV/m)	Read Level (dBμV)	Antenna Factor (dB/m)	Cable Loss (dB)	Preamp Factor (dB)	Ant Pos (cm)	Table Pos (deg)	Peak Avg. (P/A)	Pol. (H/V)	
802.11b CH 01 2412MHz		4824	51.08	-22.92	74	44.66	31.32	8.65	33.55	110	305	P	H	
		4824	49.32	-4.68	54	42.9	31.32	8.65	33.55	110	305	A	H	
													H	
													H	
			4824	46.03	-27.97	74	39.61	31.32	8.65	33.55	100	0	P	V
													P	V
														V
802.11b CH 06 2437MHz		4874	45.66	-28.34	74	39.1	31.41	8.69	33.54	100	0	P	H	
		7311	48.81	-25.19	74	36.58	36.28	10.39	34.44	100	0	P	H	
													H	
													H	
			4874	45.09	-28.91	74	38.53	31.41	8.69	33.54	100	0	P	V
			7311	49.11	-24.89	74	36.88	36.28	10.39	34.44	100	0	P	V
														V
802.11b CH 11 2462MHz		4924	52.06	-21.94	74	45.32	31.49	8.79	33.54	104	303	P	H	
		4924	50.68	-3.32	54	43.94	31.49	8.79	33.54	104	303	A	H	
		7386	48.35	-25.65	74	35.88	36.47	10.48	34.48	100	0	P	H	
													H	
			4924	49.77	-24.23	74	43.03	31.49	8.79	33.54	100	0	P	V
			7386	49.22	-24.78	74	36.75	36.47	10.48	34.48	100	0	P	V
														V
Remark	1. No other spurious found.													
	2. All results are PASS against Peak and Average limit line.													



2.4GHz 2400~2483.5MHz

WIFI 802.11g (Band Edge @ 3m)

WIFI Ant. 1	Note	Frequency (MHz)	Level (dBμV/m)	Over Limit (dB)	Limit Line (dBμV/m)	Read Level (dBμV)	Antenna Factor (dB/m)	Cable Loss (dB)	Preamp Factor (dB)	Ant Pos (cm)	Table Pos (deg)	Peak Avg. (P/A)	Pol. (H/V)	
802.11g CH 01 2412MHz		2382.36	52.58	-21.42	74	53.42	27.19	6.01	34.04	155	4	P	H	
		2390	43.26	-10.74	54	44.06	27.23	6.01	34.04	155	4	A	H	
	*	2412	104.45	-	-	105.17	27.28	6.04	34.04	155	4	P	H	
	*	2412	97.24	-	-	97.96	27.28	6.04	34.04	155	4	A	H	
													H	
														H
			2366.16	52.85	-21.15	74	53.74	27.14	6.01	34.04	235	272	P	V
			2389.47	42.81	-11.19	54	43.61	27.23	6.01	34.04	235	272	A	V
	*		2412	101.12	-	-	101.84	27.28	6.04	34.04	235	272	P	V
	*		2412	94	-	-	94.72	27.28	6.04	34.04	235	272	A	V
														V
														V
802.11g CH 06 2437MHz		2376.69	52.73	-21.27	74	53.57	27.19	6.01	34.04	127	42	P	H	
		2387.13	42.83	-11.17	54	43.63	27.23	6.01	34.04	127	42	A	H	
	*	2437	107.07	-	-	107.69	27.37	6.04	34.03	127	42	P	H	
	*	2437	99.89	-	-	100.51	27.37	6.04	34.03	127	42	A	H	
			2485.52	53.42	-20.58	74	53.88	27.46	6.09	34.01	127	42	P	H
			2483.76	44.09	-9.91	54	44.55	27.46	6.09	34.01	127	42	A	H
			2314.14	53.21	-20.79	74	54.37	27.01	5.89	34.06	343	90	P	V
			2387.22	42.67	-11.33	54	43.47	27.23	6.01	34.04	343	90	A	V
	*		2437	102.33	-	-	102.95	27.37	6.04	34.03	343	90	P	V
	*		2437	95.24	-	-	95.86	27.37	6.04	34.03	343	90	A	V
			2495.92	53.59	-20.41	74	54	27.5	6.09	34	343	90	P	V
			2488.12	43.22	-10.78	54	43.64	27.5	6.09	34.01	343	90	A	V



802.11g CH 11 2462MHz	*	2462	108.02	-	-	108.56	27.41	6.07	34.02	121	43	P	H
	*	2462	101.02	-	-	101.56	27.41	6.07	34.02	121	43	A	H
		2483.52	59.24	-14.76	74	59.7	27.46	6.09	34.01	121	43	P	H
		2483.6	46.96	-7.04	54	47.42	27.46	6.09	34.01	121	43	A	H
													H
													H
	*	2462	106.38	-	-	106.92	27.41	6.07	34.02	376	110	P	V
	*	2462	99.59	-	-	100.13	27.41	6.07	34.02	376	110	A	V
		2483.56	58.25	-15.75	74	58.71	27.46	6.09	34.01	376	110	P	V
		2483.52	45.9	-8.1	54	46.36	27.46	6.09	34.01	376	110	A	V
													V
													V
Remark	1. No other spurious found. 2. All results are PASS against Peak and Average limit line.												



2.4GHz 2400~2483.5MHz

WIFI 802.11g (Harmonic @ 3m)

WIFI Ant. 1	Note	Frequency (MHz)	Level (dBμV/m)	Over Limit (dB)	Limit Line (dBμV/m)	Read Level (dBμV)	Antenna Factor (dB/m)	Cable Loss (dB)	Preamp Factor (dB)	Ant Pos (cm)	Table Pos (deg)	Peak Avg. (P/A)	Pol. (H/V)	
802.11g CH 01 2412MHz		4824	42.96	-31.04	74	36.54	31.32	8.65	33.55	100	0	P	H	
													H	
													H	
													H	
			4824	40.82	-33.18	74	34.4	31.32	8.65	33.55	100	0	P	V
														V
														V
802.11g CH 06 2437MHz		4872	46.27	-27.73	74	39.71	31.41	8.69	33.54	100	0	P	H	
		7310	49.71	-24.29	74	37.48	36.28	10.39	34.44	100	0	P	H	
													H	
													H	
			4872	45.98	-28.02	74	39.42	31.41	8.69	33.54	100	0	P	V
			7310	49.77	-24.23	74	37.54	36.28	10.39	34.44	100	0	P	V
														V
802.11g CH 11 2462MHz		4924	47.73	-26.27	74	40.99	31.49	8.79	33.54	100	0	P	H	
		7385	49.66	-24.34	74	37.19	36.47	10.48	34.48	100	0	P	H	
													H	
													H	
			4924	46.29	-27.71	74	39.55	31.49	8.79	33.54	100	0	P	V
			7385	50.47	-23.53	74	38	36.47	10.48	34.48	100	0	P	V
														V
Remark	1. No other spurious found.													
	2. All results are PASS against Peak and Average limit line.													



2.4GHz 2400~2483.5MHz

WIFI 802.11n HT20 (Band Edge @ 3m)

WIFI Ant. 1	Note	Frequency (MHz)	Level (dBμV/m)	Over Limit (dB)	Limit Line (dBμV/m)	Read Level (dBμV)	Antenna Factor (dB/m)	Cable Loss (dB)	Preamp Factor (dB)	Ant Pos (cm)	Table Pos (deg)	Peak Avg. (P/A)	Pol. (H/V)	
802.11n HT20 CH 01 2412MHz		2370.75	53.98	-20.02	74	54.82	27.19	6.01	34.04	100	3	P	H	
		2390	42.63	-11.37	54	43.43	27.23	6.01	34.04	100	3	A	H	
	*	2412	103.8	-	-	104.52	27.28	6.04	34.04	100	3	P	H	
	*	2412	96.41	-	-	97.13	27.28	6.04	34.04	100	3	A	H	
													H	
														H
			2372.73	53.38	-20.62	74	54.22	27.19	6.01	34.04	380	100	P	V
			2384.79	42.59	-11.41	54	43.43	27.19	6.01	34.04	380	100	A	V
		*	2412	100.28	-	-	101	27.28	6.04	34.04	380	100	P	V
		*	2412	93.2	-	-	93.92	27.28	6.04	34.04	380	100	A	V
													V	
													V	
802.11n HT20 CH 06 2437MHz		2351.85	52.96	-21.04	74	53.92	27.14	5.95	34.05	100	4	P	H	
		2384.16	42.59	-11.41	54	43.43	27.19	6.01	34.04	100	4	A	H	
	*	2437	104.21	-	-	104.83	27.37	6.04	34.03	100	4	P	H	
	*	2437	96.63	-	-	97.25	27.37	6.04	34.03	100	4	A	H	
			2484.12	52.87	-21.13	74	53.33	27.46	6.09	34.01	100	4	P	H
			2483.8	43.2	-10.8	54	43.66	27.46	6.09	34.01	100	4	A	H
			2360.94	52.48	-21.52	74	53.44	27.14	5.95	34.05	225	265	P	V
			2377.41	42.6	-11.4	54	43.44	27.19	6.01	34.04	225	265	A	V
		*	2434.15	99.8	-	-	100.47	27.32	6.04	34.03	225	265	P	V
		*	2434.07	91.63	-	-	92.3	27.32	6.04	34.03	225	265	A	V
		2488.6	52.79	-21.21	74	53.21	27.5	6.09	34.01	225	265	P	V	
		2494.48	42.94	-11.06	54	43.35	27.5	6.09	34	225	265	A	V	



802.11n HT20 CH 11 2462MHz	*	2462	104.44	-	-	104.98	27.41	6.07	34.02	141	41	P	H
	*	2462	95.75	-	-	96.29	27.41	6.07	34.02	141	41	A	H
		2484.08	54.23	-19.77	74	54.69	27.46	6.09	34.01	141	41	P	H
		2483.52	44.47	-9.53	54	44.93	27.46	6.09	34.01	141	41	A	H
													H
													H
	*	2462	94.14	-	-	94.68	27.41	6.07	34.02	100	188	P	V
	*	2462	86.96	-	-	87.5	27.41	6.07	34.02	100	188	A	V
		2492.8	53.27	-20.73	74	53.68	27.5	6.09	34	100	188	P	V
		2494.04	43.07	-10.93	54	43.48	27.5	6.09	34	100	188	A	V
													V
													V
Remark	1. No other spurious found. 2. All results are PASS against Peak and Average limit line.												



2.4GHz 2400~2483.5MHz

WIFI 802.11n HT20 (Harmonic @ 3m)

WIFI Ant. 1	Note	Frequency (MHz)	Level (dBμV/m)	Over Limit (dB)	Limit Line (dBμV/m)	Read Level (dBμV)	Antenna Factor (dB/m)	Cable Loss (dB)	Preamp Factor (dB)	Ant Pos (cm)	Table Pos (deg)	Peak Avg. (P/A)	Pol. (H/V)	
802.11n HT20 CH 01 2412MHz		4824	45.93	-28.07	74	39.51	31.32	8.65	33.55	100	0	P	H	
													H	
													H	
													H	
			4824	45.7	-28.3	74	39.28	31.32	8.65	33.55	100	0	P	V
														V
														V
802.11n HT20 CH 06 2437MHz		4872	44.94	-29.06	74	38.38	31.41	8.69	33.54	100	0	P	H	
		7310	50.78	-23.22	74	38.55	36.28	10.39	34.44	100	0	P	H	
													H	
													H	
			4872	47.03	-26.97	74	40.47	31.41	8.69	33.54	100	0	P	V
			7310	50.6	-23.4	74	38.37	36.28	10.39	34.44	100	0	P	V
														V
802.11n HT20 CH 11 2462MHz		4924	45.28	-28.72	74	38.54	31.49	8.79	33.54	100	0	P	H	
		7385	49.05	-24.95	74	36.58	36.47	10.48	34.48	100	0	P	H	
													H	
													H	
			4924	44.74	-29.26	74	38	31.49	8.79	33.54	100	0	P	V
			7385	50.77	-23.23	74	38.3	36.47	10.48	34.48	100	0	P	V
														V
Remark	1. No other spurious found.													
	2. All results are PASS against Peak and Average limit line.													



2.4GHz 2400~2483.5MHz

WIFI 802.11n HT40 (Band Edge @ 3m)

WIFI Ant. 1	Note	Frequency (MHz)	Level (dBμV/m)	Over Limit (dB)	Limit Line (dBμV/m)	Read Level (dBμV)	Antenna Factor (dB/m)	Cable Loss (dB)	Preamp Factor (dB)	Ant Pos (cm)	Table Pos (deg)	Peak Avg. (P/A)	Pol. (H/V)	
802.11n HT40 CH 03 2422MHz		2334.84	53.5	-20.5	74	54.51	27.1	5.95	34.06	260	34	P	H	
		2390	42.96	-11.04	54	43.76	27.23	6.01	34.04	260	34	A	H	
	*	2422	102.09	-	-	102.76	27.32	6.04	34.03	260	34	P	H	
	*	2422	94.21	-	-	94.88	27.32	6.04	34.03	260	34	A	H	
		2493.08	53.84	-20.16	74	54.25	27.5	6.09	34	260	34	P	H	
		2483.76	44.05	-9.95	54	44.51	27.46	6.09	34.01	260	34	A	H	
		2317.74	53.15	-20.85	74	54.27	27.05	5.89	34.06	100	217	P	V	
		2361.21	42.9	-11.1	54	43.86	27.14	5.95	34.05	100	217	A	V	
	*	2422	95.64	-	-	96.31	27.32	6.04	34.03	100	217	P	V	
	*	2422	88.23	-	-	88.9	27.32	6.04	34.03	100	217	A	V	
		2485.64	53.01	-20.99	74	53.47	27.46	6.09	34.01	100	217	P	V	
		2496.32	43.41	-10.59	54	43.82	27.5	6.09	34	100	217	A	V	
	802.11n HT40 CH 06 2437MHz		2380.11	53.15	-20.85	74	53.99	27.19	6.01	34.04	148	306	P	H
			2382.72	42.92	-11.08	54	43.76	27.19	6.01	34.04	148	306	A	H
*		2437	103.02	-	-	103.64	27.37	6.04	34.03	148	306	P	H	
*		2437	95.99	-	-	96.61	27.37	6.04	34.03	148	306	A	H	
		2485	53.3	-20.7	74	53.76	27.46	6.09	34.01	148	306	P	H	
		2483.84	44.22	-9.78	54	44.68	27.46	6.09	34.01	148	306	A	H	
		2349.78	53.62	-20.38	74	54.62	27.1	5.95	34.05	100	217	P	V	
		2389.92	43.07	-10.93	54	43.87	27.23	6.01	34.04	100	217	A	V	
*		2437	96.71	-	-	97.33	27.37	6.04	34.03	100	217	P	V	
*		2437	89.48	-	-	90.1	27.37	6.04	34.03	100	217	A	V	
		2488.28	53.99	-20.01	74	54.41	27.5	6.09	34.01	100	217	P	V	
	2487.76	43.41	-10.59	54	43.83	27.5	6.09	34.01	100	217	A	V		



802.11n HT40 CH 09 2452MHz		2382.18	53.14	-20.86	74	53.98	27.19	6.01	34.04	142	307	P	H
		2368.5	42.91	-11.09	54	43.8	27.14	6.01	34.04	142	307	A	H
	*	2452	101.18	-	-	101.76	27.37	6.07	34.02	142	307	P	H
	*	2452	94.07	-	-	94.65	27.37	6.07	34.02	142	307	A	H
		2483.72	60.55	-13.45	74	61.01	27.46	6.09	34.01	142	307	P	H
		2484.32	45.28	-8.72	54	45.74	27.46	6.09	34.01	142	307	A	H
		2359.77	53.3	-20.7	74	54.26	27.14	5.95	34.05	100	216	P	V
		2378.04	42.93	-11.07	54	43.77	27.19	6.01	34.04	100	216	A	V
	*	2452	94.7	-	-	95.28	27.37	6.07	34.02	100	216	P	V
	*	2452	87.68	-	-	88.26	27.37	6.07	34.02	100	216	A	V
		2483.72	54.89	-19.11	74	55.35	27.46	6.09	34.01	100	216	P	V
		2484.4	43.63	-10.37	54	44.09	27.46	6.09	34.01	100	216	A	V
Remark	1. No other spurious found. 2. All results are PASS against Peak and Average limit line.												



2.4GHz 2400~2483.5MHz

WIFI 802.11n HT40 (Harmonic @ 3m)

WIFI Ant. 1	Note	Frequency (MHz)	Level (dBμV/m)	Over Limit (dB)	Limit Line (dBμV/m)	Read Level (dBμV)	Antenna Factor (dB/m)	Cable Loss (dB)	Preamp Factor (dB)	Ant Pos (cm)	Table Pos (deg)	Peak Avg. (P/A)	Pol. (H/V)
802.11n HT40 CH 03 2422MHz		4844	44.8	-29.2	74	38.31	31.35	8.69	33.55	100	0	P	H
		7265	49.29	-24.71	74	37.17	36.21	10.34	34.43	100	0	P	H
													H
													H
		4844	44.91	-29.09	74	38.42	31.35	8.69	33.55	100	0	P	V
		7265	49.89	-24.11	74	37.77	36.21	10.34	34.43	100	0	P	V
													V
802.11n HT40 CH 06 2437MHz		4872	45.67	-28.33	74	39.11	31.41	8.69	33.54	100	0	P	H
		7310	49.55	-24.45	74	37.32	36.28	10.39	34.44	100	0	P	H
													H
													H
		4872	44.21	-29.79	74	37.65	31.41	8.69	33.54	100	0	P	V
		7310	49.79	-24.21	74	37.56	36.28	10.39	34.44	100	0	P	V
													V
802.11n HT40 CH 09 2452MHz		4904	44.14	-29.86	74	37.48	31.46	8.74	33.54	100	0	P	H
		7355	50.31	-23.69	74	37.94	36.4	10.44	34.47	100	0	P	H
													H
													H
		4904	45.1	-28.9	74	38.44	31.46	8.74	33.54	100	0	P	V
		7355	51.37	-22.63	74	39	36.4	10.44	34.47	100	0	P	V
													V
Remark	1. No other spurious found.												
	2. All results are PASS against Peak and Average limit line.												



Emission below 1GHz

2.4GHz WIFI 802.11b (LF)

WIFI	Note	Frequency	Level	Over	Limit	Read	Antenna	Cable	Preamp	Ant	Table	Peak	Pol.	
Ant.				Limit	Line	Level	Factor	Loss	Factor	Pos	Pos	Avg.		
1		(MHz)	(dBμV/m)	(dB)	(dBμV/m)	(dBμV)	(dB/m)	(dB)	(dB)	(cm)	(deg)	(P/A)	(H/V)	
2.4GHz 802.11b LF		86.16	8.57	-31.43	40	31.25	7.83	1.28	31.79	-	-	P	H	
		174.99	14.55	-28.95	43.5	36.19	8.5	1.64	31.78	-	-	P	H	
		257.07	12.31	-33.69	46	29.43	12.71	1.94	31.77	-	-	P	H	
		365.1	13.24	-32.76	46	27.96	14.75	2.32	31.79	-	-	P	H	
		631.8	18.32	-27.68	46	28.38	19.02	2.96	32.04	-	-	P	H	
		892.9	21.05	-24.95	46	28.86	20.1	3.55	31.46	100	66	P	H	
														H
														H
														H
														H
														H
														H
			32.7	26.12	-13.88	40	40.63	16.65	0.67	31.83	210	263	P	V
			81.3	18.57	-21.43	40	42.46	6.86	1.04	31.79	-	-	P	V
			246.27	10.24	-35.76	46	28.52	11.55	1.94	31.77	-	-	P	V
			356	13.69	-32.31	46	28.8	14.5	2.17	31.78	-	-	P	V
			731.2	20.58	-25.42	46	29.53	19.8	3.25	32	-	-	P	V
			913.9	21.36	-24.64	46	28.99	20.14	3.55	31.32	-	-	P	V
														V
														V
													V	
													V	
													V	
													V	
Remark	1. No other spurious found. 2. All results are PASS against limit line.													



Emission below 1GHz

2.4GHz WIFI 802.11g (LF)

WIFI	Note	Frequency	Level	Over	Limit	Read	Antenna	Cable	Preamp	Ant	Table	Peak	Pol.	
Ant.				Limit	Line	Level	Factor	Loss	Factor	Pos	Pos	Avg.		
1		(MHz)	(dBμV/m)	(dB)	(dBμV/m)	(dBμV)	(dB/m)	(dB)	(dB)	(cm)	(deg)	(P/A)	(H/V)	
2.4GHz 802.11g LF		81.57	18.31	-21.69	40	42.15	6.91	1.04	31.79	-	-	P	H	
		132.33	24.98	-18.52	43.5	43.89	11.41	1.46	31.78	179	301	P	H	
		231.42	13.05	-32.95	46	33.36	9.67	1.79	31.77	-	-	P	H	
		319.6	12.8	-33.2	46	28.96	13.5	2.11	31.77	-	-	P	H	
		636.7	18.84	-27.16	46	28.85	19.07	2.96	32.04	-	-	P	H	
		911.8	21.22	-24.78	46	28.89	20.12	3.55	31.34	-	-	P	H	
														H
														H
														H
														H
														H
														H
														H
			42.69	33.39	-6.61	40	53.41	11.12	0.67	31.81	100	252	P	V
			175.26	14.96	-28.54	43.5	36.61	8.49	1.64	31.78	-	-	P	V
			287.58	13.43	-32.57	46	30.43	12.65	2.11	31.76	-	-	P	V
			300	12.01	-33.99	46	28.66	13	2.11	31.76	-	-	P	V
			746.6	20.49	-25.51	46	29.42	19.8	3.25	31.98	-	-	P	V
			979.7	20.44	-33.56	54	27.15	20.31	3.78	30.8	-	-	P	V
														V
													V	
													V	
													V	
													V	
													V	
Remark	1. No other spurious found. 2. All results are PASS against limit line.													



Emission below 1GHz

2.4GHz WIFI 802.11n HT40 (LF)

WIFI	Note	Frequency	Level	Over	Limit	Read	Antenna	Cable	Preamp	Ant	Table	Peak	Pol.	
Ant.				Limit	Line	Level	Factor	Loss	Factor	Pos	Pos	Avg.		
1		(MHz)	(dBμV/m)	(dB)	(dBμV/m)	(dBμV)	(dB/m)	(dB)	(dB)	(cm)	(deg)	(P/A)	(H/V)	
2.4GHz 802.11n HT40 LF		64.56	7.59	-32.41	40	33.44	4.9	1.04	31.79	-	-	P	H	
		166.89	12.12	-31.38	43.5	33.27	8.99	1.64	31.78	-	-	P	H	
		251.13	13.51	-32.49	46	31.23	12.11	1.94	31.77	-	-	P	H	
		363.7	14.08	-31.92	46	28.96	14.74	2.17	31.79	-	-	P	H	
		715.8	20.13	-25.87	46	29.68	19.33	3.14	32.02	-	-	P	H	
		953.8	21.48	-24.52	46	28.28	20.52	3.68	31	118	29	P	H	
														H
														H
														H
														H
														H
														H
			41.07	31.4	-8.6	40	50.49	12.06	0.67	31.82	118	58	P	V
			162.3	7.66	-35.84	43.5	28.61	9.37	1.46	31.78	-	-	P	V
			271.11	12.63	-33.37	46	30.06	12.4	1.94	31.77	-	-	P	V
			339.9	12.54	-33.46	46	28.35	13.8	2.17	31.78	-	-	P	V
			761.3	19.9	-26.1	46	28.92	19.7	3.25	31.97	-	-	P	V
			968.5	21.65	-32.35	54	28.27	20.49	3.78	30.89	-	-	P	V
													V	
													V	
													V	
													V	
													V	
													V	
Remark	1. No other spurious found. 2. All results are PASS against limit line.													



Note symbol

*	Fundamental Frequency which can be ignored. However, the level of any unwanted emissions shall not exceed the level of the fundamental frequency.
!	Test result is over limit line.
P/A	Peak or Average
H/V	Horizontal or Vertical



A calculation example for radiated spurious emission is shown as below:

WIFI	Note	Frequency	Level	Over	Limit	Read	Antenna	Cable	Preamp	Ant	Table	Peak	Pol.
Ant.				Limit	Line	Level	Factor	Loss	Factor	Pos	Pos	Avg.	
1		(MHz)	(dBμV/m)	(dB)	(dBμV/m)	(dBμV)	(dB/m)	(dB)	(dB)	(cm)	(deg)	(P/A)	(H/V)
802.11b		2390	55.45	-18.55	74	54.51	32.22	4.58	35.86	103	308	P	H
CH 01													
2412MHz		2390	43.54	-10.46	54	42.6	32.22	4.58	35.86	103	308	A	H

- Level(dBμV/m) =
Antenna Factor(dB/m) + Cable Loss(dB) + Read Level(dBμV) - Preamp Factor(dB)
- Over Limit(dB) = Level(dBμV/m) – Limit Line(dBμV/m)

For Peak Limit @ 2390MHz:

- Level(dBμV/m)
= Antenna Factor(dB/m) + Cable Loss(dB) + Read Level(dBμV) - Preamp Factor(dB)
= 32.22(dB/m) + 4.58(dB) + 54.51(dBμV) – 35.86 (dB)
= 55.45 (dBμV/m)
- Over Limit(dB)
= Level(dBμV/m) – Limit Line(dBμV/m)
= 55.45(dBμV/m) – 74(dBμV/m)
= -18.55(dB)

For Average Limit @ 2390MHz:

- Level(dBμV/m)
= Antenna Factor(dB/m) + Cable Loss(dB) + Read Level(dBμV) - Preamp Factor(dB)
= 32.22(dB/m) + 4.58(dB) + 42.6(dBμV) – 35.86 (dB)
= 43.54 (dBμV/m)
- Over Limit(dB)
= Level(dBμV/m) – Limit Line(dBμV/m)
= 43.54(dBμV/m) – 54(dBμV/m)
= -10.46(dB)

Both peak and average measured complies with the limit line, so test result is “PASS”.