



FCC/IC RF Test Report

APPLICANT : Sony Mobile Communications Inc.
EQUIPMENT : Smart phone
BRAND NAME : SONY
TYPE NAME : PM-0890-BV
FCC ID : PY7-PM0890
IC : 4170B-PM0890
STANDARD : 47 CFR Part 2, 22(H), 24(E), 27
IC RSS-130 issue 1
IC RSS-132 issue 3
IC RSS-133 issue 6
IC RSS-139 issue 2
IC RSS-199 issue 2
CLASSIFICATION : PCS Licensed Transmitter Held to Ear (PCE)

The product was received on Apr. 30, 2015 and completely tested on May 18, 2015. We, SPORTON INTERNATIONAL INC., would like to declare that the tested sample has been evaluated in accordance with the test procedures given in ANSI / TIA / EIA-603-C-2004 and the testing has shown the tested sample to be in compliance with the applicable technical standards.

The test results in this report apply exclusively to the tested model / sample. Without written approval of SPORTON INTERNATIONAL INC., the test report shall not be reproduced except in full.



Reviewed by: Joseph Lin / Supervisor

Approved by: Jones Tsai / Manager



SPORTON INTERNATIONAL INC.

No. 52, Hwa Ya 1st Rd., Hwa Ya Technology Park, Kwei-Shan District, Tao Yuan City, Taiwan, R.O.C.



TABLE OF CONTENTS

REVISION HISTORY..... 5
SUMMARY OF TEST RESULT 6
1 GENERAL DESCRIPTION 9
1.1 Applicant 9
1.2 Manufacturer 9
1.3 Product Feature of Equipment Under Test..... 9
1.4 Details of Tested Sample (EUT) Information..... 10
1.5 Modification of EUT 11
1.6 Emission Designator 12
1.7 Testing Location 15
1.8 Applicable Standards 16
2 TEST CONFIGURATION OF EQUIPMENT UNDER TEST 17
2.1 Test Mode 17
2.2 Connection Diagram of Test System 21
2.3 Support Unit used in test configuration and system 21
2.4 Measurement Results Explanation Example 21
3 CONDUCTED TEST ITEMS 22
3.1 Measuring Instruments 22
3.2 Test Setup 22
3.3 Test Result of Conducted Test 23
3.4 Conducted Output Power 23
3.5 Peak-to-Average Ratio 24
3.6 Occupied Bandwidth 25
3.7 Conducted Band Edge 26
3.8 Conducted Spurious Emission 28
3.9 Frequency Stability 29
4 RADIATED TEST ITEMS 30
4.1 Measuring Instruments 30
4.2 Test Setup 30
4.3 Test Result of Radiated Test 31
4.4 Effective Radiated Power and Effective Isotropic Radiated Power 32
4.5 Radiated Spurious Emission 34
5 LIST OF MEASURING EQUIPMENT 36
6 UNCERTAINTY OF EVALUATION 38

APPENDIX A. TEST RESULTS OF CONDUCTED TEST



APPENDIX B. TEST RESULTS OF RADIATED TEST



SUMMARY OF TEST RESULT

Report Section	FCC Rule	IC Rule	Description	Limit	Result	Remark
3.4	§2.1046	RSS-Gen(6.12) RSS-130(6.12) RSS-132 (5.4) RSS-133 (6.4) RSS-139 (6.4) RSS-199 (4.4)	Conducted Output Power	Reporting Only	PASS	-
3.5	§24.232(d)	RSS-130(4.4) RSS-132 (5.4) RSS-133 (6.4) RSS-139 (6.4)	Peak-to-Average Ratio	<13 dB	PASS	-
3.6	§2.1049	RSS-GEN(6.6) RSS-132 (3.1) RSS-133 (3.1) RSS-130(3.1) RSS-139 (3.1) RSS-199 (4.2)	Occupied Bandwidth	Reporting Only	PASS	-
3.7	§2.1051 §22.917(a) §24.238(a) §27.53(c)(2) §27.53(c)(4) §27.53(f) §27.53(g) §27.53(m)(4)	RSS-132 (5.5) RSS-133 (6.5.1) RSS-130(4.6) RSS-139 (6.5) RSS-199 (4.5)	Conducted Band Edge Measurement (Band 2) (Band 4) (Band 5) (Band 12) (Band 13) (Band 17) (Band 7)	< 43+10log ₁₀ (P[Watts])	PASS	-



Report Section	FCC Rule	IC Rule	Description	Limit	Result	Remark
3.8	§2.1051 §22.917(a) §24.238(a) §27.53(c)(2) §27.53(f) §27.53(g)	RSS-132 (5.5) RSS-133 (6.5.1) RSS-130(4.6) RSS-139 (6.5)	Conducted Spurious Emission (Band 2) (Band 4) (Band 5) (Band 12) (Band 13) (Band 17)	< 43+10log ₁₀ (P[Watts])	PASS	-
	§2.1051 §27.53(m)(4)	RSS-199 (4.5)	Conducted Spurious Emission (Band 7)	< 55+10log ₁₀ (P[Watts])		
3.9	§2.1055 §22.355 §24.235 §27.54	RSS-GEN(6.11) RSS-132(5.3) RSS-133(6.3) RSS-130(4.3) RSS-139 (6.3) RSS-199 (4.3)	Frequency Stability Temperature & Voltage	< 2.5 ppm for Part 22 Within Authorized Band	PASS	-
4.4	§22.913(a)(2)	RSS-132(5.4) SRSP-503(5.1.3)	Effective Radiated Power (Band 5)	ERP < 7 Watt	PASS	-
	§27.50(b)(10) §27.50(c)(10)	N/A	Effective Radiated Power (Band 12) (Band 13) (Band 17)	ERP < 3 Watt		
	N/A	RSS-130(4.4)	Equivalent Isotropic Radiated Power (Band 12) (Band 13) (Band 17)	EIRP < 5 Watt		
	§24.232(c) §27.50(h)(2)	RSS-133 (6.4) SRSP-510(5.1.2) RSS-199 (4.4)	Equivalent Isotropic Radiated Power (Band 2) (Band 7)	EIRP < 2Watt		
	§27.50(d)(4)	RSS-139 (6.4) SRSP-513(5.1.2)	Equivalent Isotropic Radiated Power (Band 4)	EIRP < 1Watt		



Report Section	FCC Rule	IC Rule	Description	Limit	Result	Remark
4.5	§2.1053 §22.917(a) §24.238(a) §27.53(c)(2) §27.53(f) §27.53(g) §27.53(h)	RSS-132 (5.5) RSS-133 (6.5.1) RSS-130(4.6) RSS-139 (6.5)	Radiated Spurious Emission (Band 2) (Band 4) (Band 5) (Band 12) (Band 13) (Band 17)	< 43+10log ₁₀ (P[Watts])	PASS	Under limit 8.66 dB at 12780.000 MHz
	§2.1053 §27.53(m)(4)	RSS-199 (4.5)	Radiated Spurious Emission (Band 7)	< 55+10log ₁₀ (P[Watts])		



1 General Description

1.1 Applicant

Sony Mobile Communications Inc.
Nya Vattentorget 22188 Lund/Sweden

1.2 Manufacturer

Arima Communications Corp.
6F, No. 866, Jhongjheng Rd., Jhonghe Dist., New Taipei City 23586, Taiwan

1.3 Product Feature of Equipment Under Test

The Equipment Under Test (hereafter called: EUT) is smart phone supporting, GSM/WCDMA/LTE, Wi-Fi 2.4GHz 802.11b/g/n, Wi-Fi 5GHz 802.11a/n, Bluetooth with FM Receiver, NFC, and GPS features, and below is details of information.

Product Feature	
Equipment	Smart phone
Brand Name	SONY
Type Name	PM-0890-BV
FCC ID	PY7-PM0890
IC	4170B-PM0890
GSM Operating Band(s)	GSM 850/900/1800/1900MHz
GPRS / EGPRS Multi Slot Class	GPRS Class 12 , EGPRS Class 12
WCDMA Operating Band(s)	FDD Band I / II / IV / V / VIII
WCDMA Rel. Version	Rel. 8
LTE Operating Band(s)	FDD Band II / IV / V / VII / XII / XIII / XVII / XXVIII
LTE Rel. Version	Rel. 8
Wi-Fi Specification	802.11a/b/g/n (HT20/HT40)
Bluetooth Version	v3.0+EDR / v4.0-LE
NFC Specification	ISO14443A / ISO14443B / Felica
Power Supply	Battery / AC Adapter / Car Charger

Remark: The above EUT's information was declared by manufacturer. Please refer to the specifications or user's manual for more detailed description.



1.4 Details of Tested Sample (EUT) Information

Product Specification subjective to this standard	
Tx Frequency	LTE Band 2 : 1850.7 MHz ~ 1909.3 MHz LTE Band 4 : 1710.7 MHz ~ 1754.3 MHz LTE Band 5 : 824.7 MHz ~ 848.3 MHz LTE Band 7 : 2502.5 MHz ~ 2567.5 MHz LTE Band 12 : 698.7 MHz ~ 715.3 MHz LTE Band 13 : 779.5 MHz ~ 784.5 MHz LTE Band 17 : 706.5 MHz ~ 713.5 MHz
Rx Frequency	LTE Band 2 : 1930.7 MHz ~ 1989.3 MHz LTE Band 4 : 2110.7 MHz ~ 2154.3 MHz LTE Band 5 : 869.7 MHz ~ 893.3 MHz LTE Band 7 : 2622.5MHz ~ 2687.5 MHz LTE Band 12 : 729.7 MHz ~ 745.3 MHz LTE Band 13 : 748.5 MHz ~ 753.5 MHz LTE Band 17 : 736.5 MHz ~ 743.5 MHz
Bandwidth	LTE Band 2 : 1.4MHz / 3MHz / 5MHz / 10MHz / 15MHz / 20MHz LTE Band 4 : 1.4MHz / 3MHz / 5MHz / 10MHz / 15MHz / 20MHz LTE Band 5 : 1.4MHz / 3MHz / 5MHz / 10MHz LTE Band 7 : 5MHz / 10MHz / 15MHz / 20MHz LTE Band 12 : 1.4MHz / 3MHz / 5MHz / 10MHz LTE Band 13 : 5MHz / 10MHz LTE Band 17 : 5MHz / 10MHz
Maximum Output Power to Antenna	LTE Band 2 : 22.44 dBm LTE Band 4 : 22.35 dBm LTE Band 5 : 23.12 dBm LTE Band 7 : 21.97 dBm LTE Band 12 : 22.57 dBm LTE Band 13 : 23.00 dBm LTE Band 17 : 23.05 dBm
Type of Modulation	QPSK / 16QAM

EUT Information List				
IMEI	HW Version	SW Version	S/N	Performed Test Item
004402454681614	A	29.0.A.0.76	WUJ01HYHXN	Conducted Measurement Radiated Spurious Emission ERP /EIRP Test



Accessory List	
AC Adapter	Model No. : EP800
	Type No. : CAA-0002016-US B
	S/N : 3113W 45 108550
Battery	Model No. : LIS1579ERPC
Earphone 1	Model No. : MH410c
	Type No. : AG-1100
	S/N : 14341EB00068DB2
USB Cable	Model No. : EC450
	Type No. : AI-0700
	S/N : 134912D70008842

Note:

1. Above EUT list and accessory list used are electrically identical per declared by manufacturer.
2. Above the accessories list are used to exercise the EUT during test.
3. For other wireless features of this EUT, test report will be issued separately.

1.5 Modification of EUT

No modifications are made to the EUT during all test items.



1.6 Emission Designator

• Below table for FCC

LTE Band 2		QPSK			16QAM		
BW(MHz)	Emission Designator (99%OBW)	Frequency Tolerance (ppm)	Maximum EIRP(W)	Emission Designator (99%OBW)	Frequency Tolerance (ppm)	Maximum EIRP(W)	
1.4	1M10G7D	-	0.1393	1M10W7D	-	0.1130	
3	2M73G7D	-	0.1380	2M73W7D	-	0.1099	
5	4M51G7D	-	0.1403	4M51W7D	-	0.1109	
10	9M09G7D	0.0095	0.1361	9M05W7D	-	0.1091	
15	13M5G7D	-	0.1288	13M5W7D	-	0.1038	
20	18M4G7D	-	0.1288	18M5W7D	-	0.1028	
LTE Band 4		QPSK			16QAM		
BW(MHz)	Emission Designator (99%OBW)	Frequency Tolerance (ppm)	Maximum EIRP(W)	Emission Designator (99%OBW)	Frequency Tolerance (ppm)	Maximum EIRP(W)	
1.4	1M09G7D	-	0.1079	1M10W7D	-	0.0931	
3	2M73G7D	-	0.1069	2M73W7D	-	0.0916	
5	4M51G7D	-	0.1086	4M51W7D	-	0.0938	
10	9M07G7D	0.0103	0.1096	9M03W7D	-	0.0927	
15	13M5G7D	-	0.1086	13M5W7D	-	0.0906	
20	18M5G7D	-	0.1104	18M5W7D	-	0.0918	
LTE Band 5		QPSK			16QAM		
BW(MHz)	Emission Designator (99%OBW)	Frequency Tolerance (ppm)	Maximum ERP(W)	Emission Designator (99%OBW)	Frequency Tolerance (ppm)	Maximum ERP(W)	
1.4	1M09G7D	-	0.0561	1M10W7D	-	0.0447	
3	2M73G7D	-	0.0524	2M73W7D	-	0.0425	
5	4M52G7D	-	0.0543	4M51W7D	-	0.0435	
10	9M09G7D	0.0126	0.0541	9M07W7D	-	0.0422	



LTE Band 7		QPSK			16QAM		
BW(MHz)	Emission Designator (99%OBW)	Frequency Tolerance (ppm)	Maximum EIRP(W)	Emission Designator (99%OBW)	Frequency Tolerance (ppm)	Maximum EIRP(W)	
5	4M53G7D	-	0.1629	4M51W7D	-	0.1396	
10	9M11G7D	0.0088	0.1603	9M05W7D	-	0.1393	
15	13M5G7D	-	0.1778	13M5W7D	-	0.1479	
20	18M5G7D	-	0.1782	18M5W7D	-	0.1545	
LTE Band 12		QPSK			16QAM		
BW(MHz)	Emission Designator (99%OBW)	Frequency Tolerance (ppm)	Maximum ERP(W)	Emission Designator (99%OBW)	Frequency Tolerance (ppm)	Maximum ERP(W)	
1.4	1M09G7D	-	0.0463	1M10W7D	-	0.0353	
3	2M72G7D	-	0.0425	2M73W7D	-	0.0368	
5	4M52G7D	-	0.0431	4M51W7D	-	0.0371	
10	9M07G7D	0.0146	0.0762	9M03W7D	-	0.0373	
LTE Band 13		QPSK			16QAM		
BW(MHz)	Emission Designator (99%OBW)	Frequency Tolerance (ppm)	Maximum ERP(W)	Emission Designator (99%OBW)	Frequency Tolerance (ppm)	Maximum ERP(W)	
5	4M52G7D	-	0.0465	4M52W7D	-	0.0444	
10	9M05G7D	0.0026	0.0453	9M03W7D	-	0.0416	
LTE Band 17		QPSK			16QAM		
BW(MHz)	Emission Designator (99%OBW)	Frequency Tolerance (ppm)	Maximum ERP(W)	Emission Designator (99%OBW)	Frequency Tolerance (ppm)	Maximum ERP(W)	
5	4M52G7D	-	0.0432	4M51W7D	-	0.0372	
10	9M11G7D	0.0135	0.0411	9M05W7D	-	0.0366	



• Below table for IC

LTE Band 7		QPSK			16QAM		
BW(MHz)	Emission Designator (99%OBW)	Frequency Tolerance (ppm)	Maximum EIRP(W)	Emission Designator (99%OBW)	Frequency Tolerance (ppm)	Maximum EIRP(W)	
5	4M53G7D	-	0.3532	4M51W7D	-	0.2897	
10	9M11G7D	0.0088	0.3475	9M05W7D	-	0.2897	
15	13M5G7D	-	0.3639	13M5W7D	-	0.2972	
20	18M5G7D	-	0.3639	18M5W7D	-	0.2951	
LTE Band 12		QPSK			16QAM		
BW(MHz)	Emission Designator (99%OBW)	Frequency Tolerance (ppm)	Maximum EIRP(W)	Emission Designator (99%OBW)	Frequency Tolerance (ppm)	Maximum EIRP(W)	
1.4	1M09G7D	-	0.0760	1M10W7D	-	0.0579	
3	2M72G7D	-	0.0697	2M73W7D	-	0.0604	
5	4M52G7D	-	0.0706	4M51W7D	-	0.0608	
10	9M07G7D	0.0146	0.1250	9M03W7D	-	0.0612	
LTE Band 13		QPSK			16QAM		
BW(MHz)	Emission Designator (99%OBW)	Frequency Tolerance (ppm)	Maximum EIRP(W)	Emission Designator (99%OBW)	Frequency Tolerance (ppm)	Maximum EIRP(W)	
5	4M52G7D	-	0.0762	4M52W7D	-	0.0728	
10	9M05G7D	0.0026	0.0743	9M03W7D	-	0.0682	
LTE Band 17		QPSK			16QAM		
BW(MHz)	Emission Designator (99%OBW)	Frequency Tolerance (ppm)	Maximum EIRP(W)	Emission Designator (99%OBW)	Frequency Tolerance (ppm)	Maximum EIRP(W)	
5	4M52G7D	-	0.0708	4M51W7D	-	0.0611	
10	9M11G7D	0.0135	0.0675	9M05W7D	-	0.0600	



1.7 Testing Location

Sporton Lab is accredited to ISO 17025 by Taiwan Accreditation Foundation (TAF code : 1190) and the FCC designation No. TW1022 under the FCC 2.948(e) by Mutual Recognition Agreement (MRA) in FCC Test.

Test Site	SPORTON INTERNATIONAL INC.	
Test Site Location	No. 52, Hwa Ya 1 st Rd., Hwa Ya Technology Park, Kwei-Shan District, Tao Yuan City, Taiwan, R.O.C. TEL: +886-3-327-3456 FAX: +886-3-328-4978	
Test Site No.	Sporton Site No.	
	TH05-HY	

Test Site	SPORTON INTERNATIONAL INC.	
Test Site Location	No.58, Aly. 75, Ln. 564, Wenhua 3rd Rd. Kwei-Shan District, Tao Yuan City, Taiwan, R.O.C. TEL: +886-3-327-0855	
Test Site No.	Sporton Site No.	IC Registration No.
	03CH10-HY	4086H-1



1.8 Applicable Standards

According to the specifications of the manufacturer, the EUT must comply with the requirements of the following standards:

- ♦ 47 CFR Part 2, 22(H), 24(E), 27
- ♦ ANSI / TIA / EIA-603-C-2004
- ♦ FCC KDB 971168 D01 Power Meas. License Digital Systems v02r02
- ♦ IC RSS-130 Issue1
- ♦ IC RSS-132 Issue 3
- ♦ IC RSS-133 Issue 6
- ♦ IC RSS-139 Issue 2
- ♦ IC RSS-199 Issue 2
- ♦ IC RSS-Gen Issue 4

Remark:

1. All test items were verified and recorded according to the standards and without any deviation during the test.
2. This EUT has also been tested and complied with the requirements of FCC Part 15, Subpart B, recorded in a separate test report.



2 Test Configuration of Equipment Under Test

2.1 Test Mode

Antenna port conducted and radiated test items listed below are performed according to KDB 971168 D01 Power Meas. License Digital Systems v02r02 with maximum output power.

Radiated measurements are performed by rotating the EUT in three different orthogonal test planes to find the maximum emission.

Test Items	Band	Bandwidth (MHz)						Modulation		RB #			Test Channel		
		1.4	3	5	10	15	20	QPSK	16QAM	1	Half	Full	L	M	H
Max. Output Power	2	✓	✓	✓	✓	✓	✓	✓	✓	✓	✓	✓	✓	✓	✓
	4	✓	✓	✓	✓	✓	✓	✓	✓	✓	✓	✓	✓	✓	✓
	5	✓	✓	✓	✓	-	-	✓	✓	✓	✓	✓	✓	✓	✓
	7	-	-	✓	✓	✓	✓	✓	✓	✓	✓	✓	✓	✓	✓
	12	✓	✓	✓	✓	-	-	✓	✓	✓	✓	✓	✓	✓	✓
	13	-	-	✓	✓	-	-	✓	✓	✓	✓	✓	✓	✓	✓
	17	-	-	✓	✓	-	-	✓	✓	✓	✓	✓	✓	✓	✓
Peak-to-Average Ratio	2						✓	✓	✓	✓		✓	✓	✓	✓
	4						✓	✓	✓	✓		✓	✓	✓	✓
	5				✓	-	-	✓	✓	✓		✓	✓	✓	✓
	7	-	-				✓	✓	✓	✓		✓	✓	✓	✓
	12				✓	-	-	✓	✓	✓		✓	✓	✓	✓
	13	-	-		✓	-	-	✓	✓	✓		✓	✓	✓	✓
	17	-	-		✓	-	-	✓	✓	✓		✓	✓	✓	✓
26dB and 99% Bandwidth	2	✓	✓	✓	✓	✓	✓	✓	✓			✓	✓	✓	✓
	4	✓	✓	✓	✓	✓	✓	✓	✓			✓	✓	✓	✓
	5	✓	✓	✓	✓	-	-	✓	✓			✓	✓	✓	✓
	7	-	-	✓	✓	✓	✓	✓	✓			✓	✓	✓	✓
	12	✓	✓	✓	✓	-	-	✓	✓			✓	✓	✓	✓
	13	-	-	✓	✓	-	-	✓	✓			✓	✓	✓	✓
	17	-	-	✓	✓	-	-	✓	✓			✓	✓	✓	✓



Test Items	Band	Bandwidth (MHz)						Modulation		RB #			Test Channel		
		1.4	3	5	10	15	20	QPSK	16QAM	1	Half	Full	L	M	H
Conducted Band Edge	2	v	v	v	v	v	v	v	v	v		v	v		v
	4	v	v	v	v	v	v	v	v	v		v	v		v
	5	v	v	v	v	-	-	v	v	v		v	v		v
	7	-	-	v	v	v	v	v	v	v		v	v		v
	12	v	v	v	v	-	-	v	v	v		v	v		v
	13	-	-	v	v	-	-	v	v	v		v	v		v
	17	-	-	v	v	-	-	v	v	v		v	v		v



Test Items	Band	Bandwidth (MHz)						Modulation		RB #			Test Channel		
		1.4	3	5	10	15	20	QPSK	16QAM	1	Half	Full	L	M	H
Conducted Spurious Emission	2	✓	✓	✓	✓	✓	✓	✓	✓	✓			✓	✓	✓
	4	✓	✓	✓	✓	✓	✓	✓	✓	✓			✓	✓	✓
	5	✓	✓	✓	✓	-	-	✓	✓	✓			✓	✓	✓
	7	-	-	✓	✓	✓	✓	✓	✓	✓			✓	✓	✓
	12	✓	✓	✓	✓	-	-	✓	✓	✓			✓	✓	✓
	13	-	-	✓	✓	-	-	✓	✓	✓			✓	✓	✓
	17	-	-	✓	✓	-	-	✓	✓	✓			✓	✓	✓
Frequency Stability	2				✓			✓				✓		✓	
	4				✓			✓				✓		✓	
	5				✓	-	-	✓				✓		✓	
	7	-	-		✓			✓				✓		✓	
	12				✓	-	-	✓				✓		✓	
	13	-	-		✓	-	-	✓				✓		✓	
	17	-	-		✓	-	-	✓				✓		✓	
E.R.P./E.I.R.P.	2	✓	✓	✓	✓	✓	✓	✓	✓	✓			✓	✓	✓
	4	✓	✓	✓	✓	✓	✓	✓	✓	✓			✓	✓	✓
	5	✓	✓	✓	✓	-	-	✓	✓	✓			✓	✓	✓
	7	-	-	✓	✓	✓	✓	✓	✓	✓			✓	✓	✓
	12	✓	✓	✓	✓	✓	✓	✓	✓	✓			✓	✓	✓
	13	-	-	✓	✓	✓	✓	✓	✓	✓			✓	✓	✓
	17	-	-	✓	✓	-	-	✓	✓	✓			✓	✓	✓
Radiated Spurious Emission	2	✓	✓	✓	✓	✓	✓	✓		✓			✓	✓	✓
	4	✓	✓	✓	✓	✓	✓	✓		✓			✓	✓	✓
	5	✓	✓	✓	✓	-	-	✓		✓			✓	✓	✓
	7	-	-	✓	✓	✓	✓	✓		✓			✓	✓	✓
	12	✓	✓	✓	✓	-	-	✓		✓			✓	✓	✓
	13	-	-	✓	✓	-	-	✓		✓			✓	✓	✓
	17	-	-	✓	✓	-	-	✓		✓			✓	✓	✓



<p>Note</p>	<ol style="list-style-type: none">1. The mark “v” means that this configuration is chosen for testing2. The mark “-” means that this bandwidth is not supported.3. The device is investigated from 30MHz to 10 times of fundamental signal for radiated spurious emission test under different RB size/offset and modulations in exploratory test. Subsequently, only the worst case emissions are reported.
--------------------	--

2.2 Connection Diagram of Test System

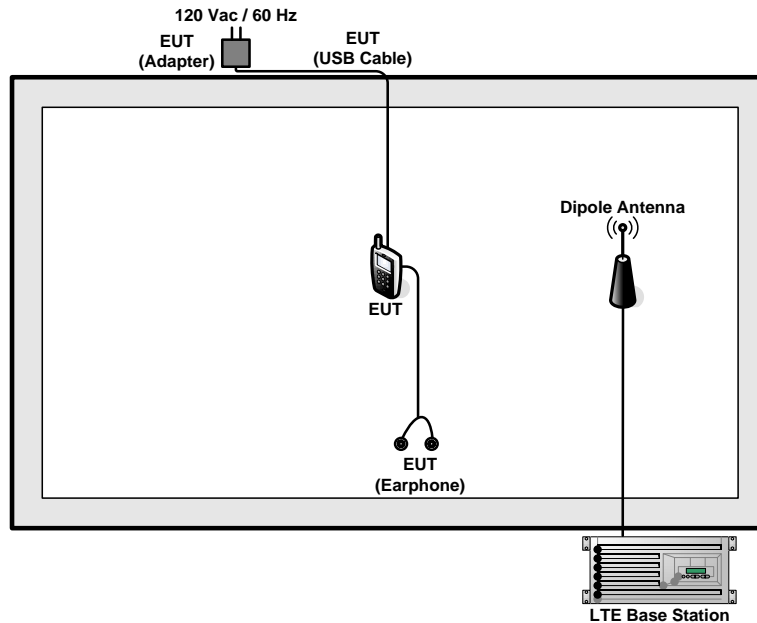

2.3 Support Unit used in test configuration and system

Item	Equipment	Trade Name	Model No.	FCC ID	Data Cable	Power Cord
1.	LTE Base Station	Anritsu	MT8820C	N/A	N/A	Unshielded, 1.8 m

2.4 Measurement Results Explanation Example

For all conducted test items:

The offset level is set in the spectrum analyzer to compensate the RF cable loss and attenuator factor between EUT conducted output port and spectrum analyzer. With the offset compensation, the spectrum analyzer reading level is exactly the EUT RF output level.

The spectrum analyzer offset is derived from RF cable loss and attenuator factor.

Offset = RF cable loss + attenuator factor.

Following shows an offset computation example with cable loss 4.2 dB and 10dB attenuator.

Example :

$$\begin{aligned} \text{Offset}(dB) &= \text{RF cable loss}(dB) + \text{attenuator factor}(dB). \\ &= 4.2 + 10 = 14.2 \text{ (dB)} \end{aligned}$$

3 Conducted Test Items

3.1 Measuring Instruments

See list of measuring instruments of this test report.

3.2 Test Setup

3.2.1 Conducted Output Power



3.2.2 Peak-to-Average Ratio, Occupied Bandwidth ,Conducted Band-Edge and Conducted Spurious Emission

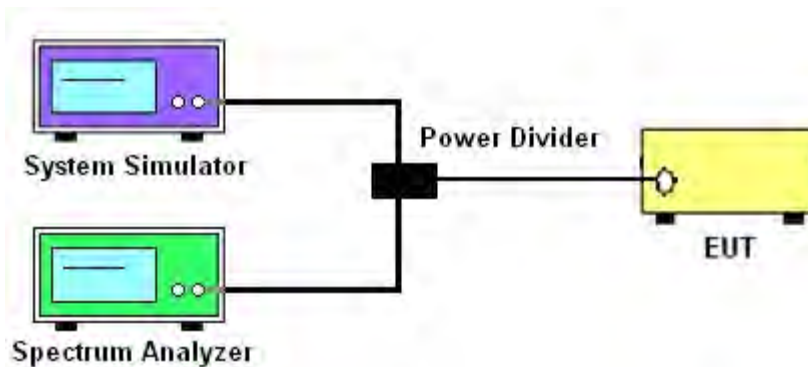

3.2.3 Frequency Stability

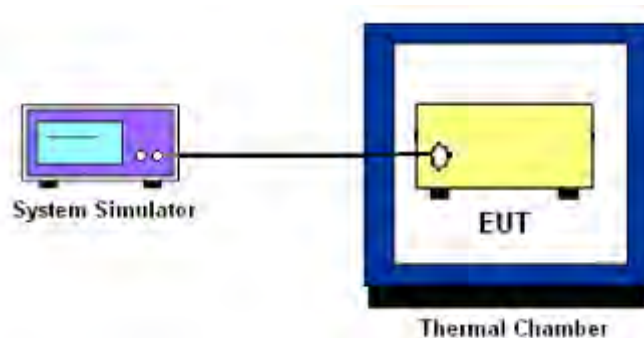



3.3 Test Result of Conducted Test

Please refer to Appendix A.

3.4 Conducted Output Power

3.4.1 Description of the Conducted Output Power Measurement

A system simulator was used to establish communication with the EUT. Its parameters were set to force the EUT transmitting at maximum output power. The measured power in the radio frequency on the transmitter output terminals shall be reported.

3.4.2 Test Procedures

1. The transmitter output port was connected to the system simulator.
2. Set EUT at maximum power through the system simulator.
3. Select lowest, middle, and highest channels for each band and different modulation.
4. Measure and record the power level from the system simulator.



3.5 Peak-to-Average Ratio

3.5.1 Description of the PAR Measurement

Power Complementary Cumulative Distribution Function (CCDF) curves provide a means for characterizing the power peaks of a digitally modulated signal on a statistical basis. A CCDF curve depicts the probability of the peak signal amplitude exceeding the average power level. Most contemporary measurement instrumentation include the capability to produce CCDF curves for an input signal provided that the instrument's resolution bandwidth can be set wide enough to accommodate the entire input signal bandwidth. In measuring transmissions in this band using an average power technique, the peak-to-average ratio (PAR) of the transmission may not exceed 13 dB.

3.5.2 Test Procedures

1. The testing follows FCC KDB 971168 v02r02 Section 5.7.1.
2. The EUT was connected to spectrum and system simulator via a power divider.
3. Set the CCDF (Complementary Cumulative Distribution Function) option in spectrum analyzer.
4. The highest RF powers were measured and recorded the maximum PAPR level associated with a probability of 0.1 %.
5. Record the deviation as Peak to Average Ratio.



3.6 Occupied Bandwidth

3.6.1 Description of Occupied Bandwidth Measurement

The occupied bandwidth is the width of a frequency band such that, below the lower and above the upper frequency limits, the mean powers emitted are each equal to a specified percentage 0.5% of the total mean transmitted power.

The 26 dB emission bandwidth is defined as the frequency range between two points, one above and one below the carrier frequency, at which the spectral density of the emission is attenuated 26 dB below the maximum in-band spectral density of the modulated signal. Spectral density (power per unit bandwidth) is to be measured with a detector of resolution bandwidth equal to approximately 1.0% of the emission bandwidth.

3.6.2 Test Procedures

1. The testing follows FCC KDB 971168 v02r02 Section 4.2.
2. The EUT was connected to spectrum analyzer and system simulator via a power divider.



3.7 Conducted Band Edge

3.7.1 Description of Conducted Band Edge Measurement

22.917(a) and RSS – 132 for Band 5

For operations in the 824 – 849 MHz band, the FCC limit is $43 + 10\log_{10}(P[\text{Watts}])$ dB below the transmitter power P(Watts) in a 100kHz bandwidth. However, in the 1MHz bands immediately outside and adjacent to the licensee's frequency block, a resolution bandwidth of at least one percent of the emission bandwidth of the fundamental emission of the transmitter may be employed.

24.238 (a) and RSS – 133 for Band 2

For operations in the 1850-1910 and 1930-1990 MHz band, the FCC limit is $43 + 10\log_{10}(P[\text{Watts}])$ dB below the transmitter power P(Watts) in a 1MHz bandwidth. However, in the 1 MHz bands immediately outside and adjacent to the frequency block a resolution bandwidth of at least one percent of the emission bandwidth of the fundamental emission of the transmitter may be employed.

27.53 (c) and RSS – 130 for Band 13

For operations in the 776-788 MHz band, the FCC limit is $43 + 10\log_{10}(P[\text{Watts}])$ dB below the transmitter power P(Watts) in a 100 kHz bandwidth. However, in the 100 kHz bands immediately outside and adjacent to the frequency block, a resolution bandwidth of at least 30 kHz may be employed. In addition, the power of any unwanted emissions in any 6.25 kHz bandwidth for all frequencies between 763-775 MHz and 793-806 MHz shall be attenuated below the transmitter power, P (dBW), by at least $65 + 10 \log_{10} p(\text{watts})$, dB, for mobile and portable equipment.

27.53 (g) and RSS – 130 for Band 12,17

For operations in the 698 -746 MHz band, the FCC limit is $43 + 10\log_{10}(P[\text{Watts}])$ dB below the transmitter power P(Watts) in a 100 kHz bandwidth. However, in the 100 kilohertz bands immediately outside and adjacent to a licensee's frequency block, a resolution bandwidth of at least 30 kHz may be employed.

27.53 (h) and RSS – 139 for Band 4

For operations in the 1710 – 1755 MHz band, the FCC limit is $43 + 10\log_{10}(P[\text{Watts}])$ dB below the transmitter power P(Watts) in a 1 MHz bandwidth. However, in the 1MHz bands immediately outside and adjacent to the licensee's frequency block, a resolution bandwidth of at least one percent of the emission bandwidth of the fundamental emission of the transmitter may be employed.



27.53(m)(4) and RSS-199 for Band 7

For mobile digital stations, the attenuation factor shall be not less than $40 + 10 \log (P)$ dB on all frequencies between the channel edge and 5 megahertz from the channel edge, $43 + 10 \log (P)$ dB on all frequencies between 5 megahertz and X megahertz from the channel edge, and $55 + 10 \log (P)$ dB on all frequencies more than X megahertz from the channel edge, where X is the greater of 6 megahertz or the actual emission bandwidth as defined in paragraph (m)(6) of this section. In addition, the attenuation factor shall not be less that $43 + 10 \log (P)$ dB on all frequencies between 2490.5 MHz and 2496 MHz and $55 + 10 \log (P)$ dB at or below 2490.5 MHz. Mobile Satellite Service licensees operating on frequencies below 2495 MHz may also submit a documented interference complaint against BRS licensees operating on channel BRS Channel 1 on the same terms and conditions as adjacent channel BRS or EBS licensees.

3.7.2 Test Procedures

1. The testing follows FCC KDB 971168 v02r02 Section 6.0.
2. The EUT was connected to spectrum analyzer and system simulator via a power divider.
3. The band edges of low and high channels for the highest RF powers were measured. Set RBW $\geq 1\%$ EBW in the 1MHz band immediately outside and adjacent to the band edge.
4. Set spectrum analyzer with RMS detector.
5. The RF fundamental frequency should be excluded against the limit line in the operating frequency band.
6. The limit line is derived from $43 + 10\log(P)$ dB below the transmitter power P(Watts)
 $= P(W) - [43 + 10\log(P)]$ (dB)
 $= [30 + 10\log(P)]$ (dBm) - $[43 + 10\log(P)]$ (dB)
 $= -13$ dBm.



3.8 Conducted Spurious Emission

3.8.1 Description of Conducted Spurious Emission Measurement

The power of any emission outside of the authorized operating frequency ranges must be lower than the transmitter power (P) by a factor of at least $43 + 10 \log (P)$ dB.

For Band 7:

The power of any emission outside of the authorized operating frequency ranges must be lower than the transmitter power (P) by a factor of at least $55 + 10 \log (P)$ dB.

It is measured by means of a calibrated spectrum analyzer and scanned from 30 MHz up to a frequency including its 10th harmonic.

3.8.2 Test Procedures

1. The testing follows FCC KDB 971168 v02r02 Section 6.0.
2. The EUT was connected to spectrum analyzer and system simulator via a power divider.
3. The RF output of EUT was connected to the spectrum analyzer by RF cable and attenuator. The path loss was compensated to the results for each measurement.
4. The middle channel for the highest RF power within the transmitting frequency was measured.
5. The conducted spurious emission for the whole frequency range was taken.
6. Make the measurement with the spectrum analyzer's RBW = 1MHz, VBW = 3MHz, taking the record of maximum spurious emission.
7. The RF fundamental frequency should be excluded against the limit line in the operating frequency band.
8. The limit line is derived from $43 + 10\log(P)$ dB below the transmitter power P(Watts)
 $= P(W) - [43 + 10\log(P)]$ (dB)
 $= [30 + 10\log(P)]$ (dBm) - $[43 + 10\log(P)]$ (dB)
 $= -13$ dBm.
9. For Band 7
The limit line is derived from $55 + 10\log(P)$ dB below the transmitter power P(Watts)



3.9 Frequency Stability

3.9.1 Description of Frequency Stability Measurement

The frequency stability shall be measured by variation of ambient temperature and variation of primary supply voltage to ensure that the fundamental emission stays within the authorized frequency block. The frequency stability of the transmitter shall be maintained within $\pm 0.00025\%$ ($\pm 2.5\text{ppm}$) of the center frequency.

3.9.2 Test Procedures for Temperature Variation

1. The EUT was set up in the thermal chamber and connected with the system simulator.
2. With power OFF, the temperature was decreased to -30°C and the EUT was stabilized before testing. Power was applied and the maximum change in frequency was recorded within one minute.
3. With power OFF, the temperature was raised in 10°C step up to 50°C . The EUT was stabilized at each step for at least half an hour. Power was applied and the maximum frequency change was recorded within one minute.

3.9.3 Test Procedures for Voltage Variation

1. The testing follows FCC KDB 971168 v02r02 Section 9.0.
2. The EUT was placed in a temperature chamber at $25\pm 5^{\circ}\text{C}$ and connected with the system simulator.
3. The power supply voltage to the EUT was varied from 85% to 115% of the nominal value measured at the input to the EUT.
4. The variation in frequency was measured for the worst case.

3.9.4 Test Procedures for Frequency Stability (IC)

1. The testing follows FCC KDB 971168 v02r02 Section 9.0.
2. The EUT was connected to spectrum analyzer and system simulator via a power divider.
3. The EUT was operated at the lowest and highest channel
4. Using $\text{RBW} = 1\%$ OBW and displaying line = -13dBm .
5. The frequency at these points shall be recorded as f_L and f_H respectively.
6. Calculate frequency stability within the 698.7 ~ 715.3 MHz, 779.5 ~ 784.5 MHz, and 706.5 ~ 713.5 MHz

4 Radiated Test Items

4.1 Measuring Instruments

See list of measuring instruments of this test report.

4.2 Test Setup

4.2.1 For radiated test from 30MHz to 1GHz

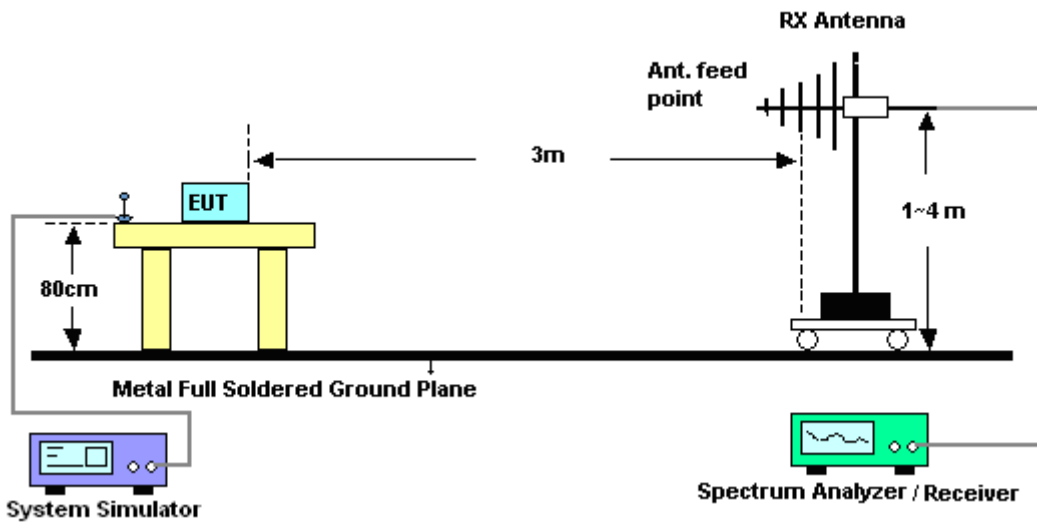

4.2.2 For radiated test above 1GHz

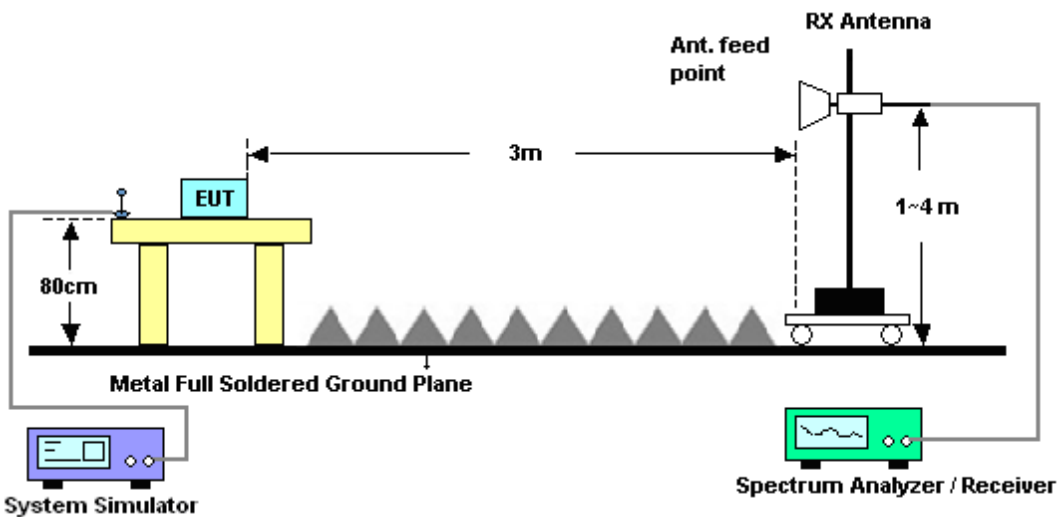



4.3 Test Result of Radiated Test

Please refer to Appendix B.



4.4 Effective Radiated Power and Effective Isotropic Radiated Power

4.4.1 Description of the ERP/EIRP Measurement

Effective radiated power output measurements by substitution method according to ANSI / TIA / EIA-603-C-2004, and the spectrum analyzer configuration follows KDB 971168 D01 Power Meas. License Digital Systems v02r02. Mobile and portable (hand-held) stations operating are limited to average ERP of 7 watts with LTE band 5 and 3 watts with LTE band 12 / 13 / 17.

Equivalent isotropic radiated power output measurements by substitution method according to ANSI / TIA / EIA-603-C-2004, and the spectrum analyzer configuration follows KDB 971168 D01 Power Meas. License Digital Systems v02r02. Mobile and portable (hand-held) stations operating are limited to average EIRP of 2 watts with LTE band 2 / 7 and 1 watt with LTE band 4.

4.4.2 Test Procedures

1. The EUT was placed on a non-conductive rotating platform 0.8 meters high in a semi-anechoic chamber. The radiated emission at the fundamental frequency was measured at 3 m with a test antenna and a spectrum analyzer with RMS detector per section 5. of KDB 971168 D01.
Note: For IC RSS-199, set PEAK detector instead of RMS detector.
2. During the measurement, the system simulator parameters were set to force the EUT transmitting at maximum output power. The maximum emission was recorded from analyzer power level (LVL) from the 360 degrees rotation of the turntable and the test antenna raised and lowered over a range from 1 to 4 meters in both horizontally and vertically polarized orientations.
3. Effective Isotropic Radiated Power (EIRP) was measured by substitution method according to TIA/EIA-603-C. The EUT was replaced by the substitution antenna at same location, and then a known power from S.G. was applied into the dipole antenna through a Tx cable, and then recorded the maximum Analyzer reading through raised and lowered the test antenna. The correction factor (in dB) = S.G. - Tx Cable loss + Substitution antenna gain - Analyzer reading. Then the EUT's EIRP was calculated with the correction factor, $EIRP = LVL + \text{Correction factor}$ and $ERP = EIRP - 2.15$. Take the record of the output power at substitution antenna.



	LTE Average					
LTE BW	1.4M	3M	5M	10M	15M	20M
Span	3MHz	6MHz	10MHz	20MHz	30MHz	40MHz
RBW	30kHz	100kHz	100kHz	300kHz	300kHz	300kHz
VBW	100kHz	300kHz	300kHz	1MHz	1MHz	1MHz
Detector	RMS	RMS	RMS	RMS	RMS	RMS
Trace	Average	Average	Average	Average	Average	Average
Average Type	Power	Power	Power	Power	Power	Power
Sweep Count	100	100	100	100	100	100

	LTE Peak					
LTE BW	1.4M	3M	5M	10M	15M	20M
Span	3MHz	6MHz	10MHz	20MHz	30MHz	40MHz
RBW	30kHz	100kHz	100kHz	300kHz	300kHz	300kHz
VBW	100kHz	300kHz	300kHz	1MHz	1MHz	1MHz
Detector	Peak	Peak	Peak	Peak	Peak	Peak
Trace	Max Hold	Max Hold	Max Hold	Max Hold	Max Hold	Max Hold
Power	Channel	Channel	Channel	Channel	Channel	Channel



4.5 Radiated Spurious Emission

4.5.1 Description of Radiated Spurious Emission

The radiated spurious emission was measured by substitution method according to ANSI / TIA / EIA-603-C-2004. The power of any emission outside of the authorized operating frequency ranges must be attenuated below the transmitter power (P) by a factor of at least $43 + 10 \log (P)$ dB.

For Band 7

The power of any emission outside of the authorized operating frequency ranges must be attenuated below the transmitter power (P) by a factor of at least $55 + 10 \log (P)$ dB.

For LTE Band 12,13,17

For operations in the 746-758 MHz, 775-788 MHz, and 805-806 MHz bands, emissions in the band 1559-1610 MHz shall be limited to -70 dBW/MHz equivalent isotropically radiated power (EIRP) for wideband signals, and -80 dBW EIRP for discrete emissions of less than 700 Hz bandwidth.

The spectrum is scanned from 30 MHz up to a frequency including its 10th harmonic.

4.5.2 Test Procedures

1. The testing follows FCC KDB 971168 v02r02 Section 5.8 and ANSI / TIA-603-C-2004 Section 2.2.12.
2. The EUT was placed on a rotatable wooden table with 0.8 meter above ground.
3. The EUT was set 3 meters from the receiving antenna, which was mounted on the antenna tower.
4. The table was rotated 360 degrees to determine the position of the highest spurious emission.
5. The height of the receiving antenna is varied between one meter and four meters to search the maximum spurious emission for both horizontal and vertical polarizations.
6. Make the measurement with the spectrum analyzer's RBW = 1MHz, VBW = 3MHz, taking the record of maximum spurious emission.
7. A horn antenna was substituted in place of the EUT and was driven by a signal generator.
8. Tune the output power of signal generator to the same emission level with EUT maximum spurious emission.
9. Taking the record of output power at antenna port.
10. Repeat step 7 to step 8 for another polarization.
11. The RF fundamental frequency should be excluded against the limit line in the operating frequency band.

The limit line is derived from $43 + 10\log(P)$ dB below the transmitter power P(Watts)
= $P(W) - [43 + 10\log(P)]$ (dB)
= $[30 + 10\log(P)]$ (dBm) - $[43 + 10\log(P)]$ (dB)
= -13 dBm.

For Band 7:

The limit line is derived from $55 + 10\log(P)$ dB below the transmitter power P(Watts)



12. $EIRP \text{ (dBm)} = S.G. \text{ Power} - Tx \text{ Cable Loss} + Tx \text{ Antenna Gain}$
13. $ERP \text{ (dBm)} = EIRP - 2.15$



5 List of Measuring Equipment

Instrument	Manufacturer	Model No.	Serial No.	Characteristics	Calibration Date	Test Date	Due Date	Remark
LTE Base Station	Anritsu	MT8820C	6201432821	GSM/GPRS /WCDMA/LTE	Oct. 27, 2014	May 16, 2015~ May 18, 2015	Oct. 26, 2015	Conducted (TH05-HY)
Spectrum Analyzer	Rohde & Schwarz	FSV40	101397	10Hz~40GHz	Sep. 17, 2014	May 16, 2015~ May 18, 2015	Sep. 16, 2015	Conducted (TH05-HY)
Temperature Chamber	ESPEC	SH-641	92013720	-30~70°	Dec. 04, 2014	May 16, 2015~ May 18, 2015	Dec. 03, 2015	Conducted (TH05-HY)
Hygrometer	Testo	608-H2	41410069	N/A	Jul. 17, 2014	May 16, 2015~ May 18, 2015	Jul. 16, 2015	Conducted (TH05-HY)
RF cable	WOKEN	S05	S05-130708-038	N/A	Jan. 21, 2015	May 16, 2015~ May 18, 2015	Jan. 20, 2016	Conducted (TH05-HY)
Preamplifier	Keysight	83017A	MY53270078	1GHz~26.5GHz	Nov. 20, 2014	May 09, 2015~ May 13, 2015	Nov. 19, 2015	Radiation (03CH10-HY)
Amplifier	SONOMA	310N	187311	0.1MHz~1000MHz	Nov. 24, 2014	May 09, 2015~ May 13, 2015	Nov. 23, 2015	Radiation (03CH10-HY)
Preamplifier	MITEQ	JS44-18004000-33-8P	1840917	18GHz ~ 40GHz	Jun. 09, 2014	May 09, 2015~ May 13, 2015	Jun. 08, 2015	Radiation (03CH10-HY)
Bilog Antenna	TESEQ	CBL 6111D	35413	30MHz~1GHz	Oct. 24, 2014	May 09, 2015~ May 13, 2015	Oct. 23, 2015	Radiation (03CH10-HY)
Double Ridged Guide Horn	SCHWARZBECK	BBHA 9120D	9120D-1325	1GHz ~ 18GHz	Oct. 03, 2014	May 09, 2015~ May 13, 2015	Oct. 02, 2015	Radiation (03CH10-HY)
Horn Antenna	SCHWARZBECK	BBHA 9170	BBHA9170584	18GHz- 40GHz	Nov. 03, 2014	May 09, 2015~ May 13, 2015	Nov. 02, 2015	Radiation (03CH10-HY)
Spectrum Analyzer	Keysight	N9010A	MY54200485	10Hz ~ 44GHZ	Oct. 14, 2014	May 09, 2015~ May 13, 2015	Oct. 13, 2015	Radiation (03CH10-HY)
EMI Test Receiver	Keysight	N9038A	MY54130085	20Hz ~ 26.5GHz	Nov. 05, 2014	May 09, 2015~ May 13, 2015	Nov. 04, 2015	Radiation (03CH10-HY)
Controller	EMEC	EM 1000	N/A	Control Turn table & Ant Mast	N/A	May 09, 2015~ May 13, 2015	N/A	Radiation (03CH10-HY)
Turn Table	EMEC	TT 2200	N/A	0-360 degree	N/A	May 09, 2015~ May 13, 2015	N/A	Radiation (03CH10-HY)
Antenna Mast	EMEC	AM-BS-4500-B	N/A	1~4m	N/A	May 09, 2015~ May 13, 2015	N/A	Radiation (03CH10-HY)
Hygrometer	TECPEL	DTM-303B	TP140320	N/A	Nov. 17, 2014	May 09, 2015~ May 13, 2015	Nov. 16, 2015	Radiation (03CH10-HY)
RF Cable	HUBER + SUHNER	SUCOFLEX 104	MY24956/4 MY24952/4MY	25GHz~40GHz	Nov. 06, 2014	May 09, 2015~ May 13, 2015	Nov. 05, 2015	Radiation (03CH10-HY)
RF Cable	HUBER + SUHNER	SUCOFLEX 104	MY24956/4 MY24952/4MY 28386/4	30MHz~1GHz	Nov. 06, 2014	May 09, 2015~ May 13, 2015	Nov. 05, 2015	Radiation (03CH10-HY)
RF Cable	HUBER + SUHNER	SUCOFLEX 104	MY249564 MY249524MY 283864	1GHz~25GHz	Nov. 06, 2014	May 09, 2015~ May 13, 2015	Nov. 05, 2015	Radiation (03CH10-HY)



Instrument	Manufacturer	Model No.	Serial No.	Characteristics	Calibration Date	Test Date	Due Date	Remark
Filter	Wainwright	WLKS1200-	SN3	1.2G Low Pass	Oct. 01, 2014	May 09, 2015~ May 13, 2015	Sep. 30, 2015	Radiation (03CH10-HY)
Filter	Wainwright	WHK1.5/15	SN32	1.5G High Pass	Oct. 01, 2014	May 09, 2015~ May 13, 2015	Sep. 30, 2015	Radiation (03CH10-HY)
Filter	Microwave	H3G018G1	SN477220	3.0G High Pass	Oct. 01, 2014	May 09, 2015~ May 13, 2015	Sep. 30, 2015	Radiation (03CH10-HY)
Notch Filter	Wainwright	WRCG824/8	SN35	CDMA 850	Oct. 01, 2014	May 09, 2015~ May 13, 2015	Sep. 30, 2015	Radiation (03CH10-HY)
Notch Filter	Wainwright	WRCG1710/	SN2	AWS Band	Oct. 01, 2014	May 09, 2015~ May 13, 2015	Sep. 30, 2015	Radiation (03CH10-HY)
Notch Filter	Wainwright	WRCT1850/	SN21	1900	Oct. 01, 2014	May 09, 2015~ May 13, 2015	Sep. 30, 2015	Radiation (03CH10-HY)
Notch Filter	Wainwright	WRCT2500/	SN1 R	LTE Band7	Oct. 01, 2014	May 09, 2015~ May 13, 2015	Sep. 30, 2015	Radiation (03CH10-HY)
Notch Filter	Wainwright	WRCT698/7	SN1	700	Oct. 01, 2014	May 09, 2015~ May 13, 2015	Sep. 30, 2015	Radiation (03CH10-HY)



6 Uncertainty of Evaluation

Uncertainty of Radiated Emission Measurement (30 MHz ~ 1000 MHz)

Measuring Uncertainty for a Level of Confidence of 95% ($U = 2Uc(y)$)	2.54
---	------

Uncertainty of Radiated Emission Measurement (1 GHz ~ 40 GHz)

Measuring Uncertainty for a Level of Confidence of 95% ($U = 2Uc(y)$)	5.50
---	------



Appendix A. Test Results of Conducted Test

Conducted Output Power(Average power)

LTE Band 2 Maximum Average Power [dBm]						
BW [MHz]	RB Size	RB Offset	Mod	Lowest	Middle	Highest
1.4	1	0	QPSK	21.93	22.26	22.02
1.4	1	2		22.05	22.36	22.12
1.4	1	5		22.01	22.25	22.01
1.4	3	0		22.07	22.36	22.13
1.4	3	1		22.05	22.30	22.08
1.4	3	2		22.04	22.32	22.07
1.4	6	0		21.06	21.30	21.12
1.4	1	0	16-QAM	21.22	21.56	21.29
1.4	1	2		21.34	21.66	21.36
1.4	1	5		21.29	21.55	21.24
1.4	3	0		21.09	21.39	21.12
1.4	3	1		21.07	21.33	21.06
1.4	3	2		21.05	21.33	21.06
1.4	6	0		20.18	20.42	20.22
3	1	0	QPSK	21.92	22.23	22.03
3	1	7		22.10	22.31	22.11
3	1	14		22.07	22.19	21.97
3	8	0		21.10	21.35	21.14
3	8	4		21.16	21.32	21.14
3	8	7		21.18	21.33	21.12
3	15	0		21.16	21.33	21.15
3	1	0	16-QAM	21.20	21.53	21.32
3	1	7		21.36	21.61	21.34
3	1	14		21.35	21.46	21.21
3	8	0		20.20	20.46	20.23
3	8	4		20.25	20.42	20.22
3	8	7		20.26	20.44	20.21
3	15	0		20.19	20.39	20.19



LTE Band 2 Maximum Average Power [dBm]						
BW [MHz]	RB Size	RB Offset	Mod	Lowest	Middle	Highest
5	1	0	QPSK	22.07	22.34	22.16
5	1	12		22.24	22.37	22.16
5	1	24		22.31	22.25	22.02
5	12	0		21.22	21.42	21.24
5	12	6		21.29	21.38	21.20
5	12	11		21.34	21.39	21.20
5	25	0		21.27	21.36	21.18
5	1	0	16-QAM	21.33	21.65	21.46
5	1	12		21.51	21.68	21.42
5	1	24		21.58	21.55	21.25
5	12	0		20.25	20.46	20.29
5	12	6		20.33	20.43	20.25
5	12	11		20.39	20.43	20.24
5	25	0		20.28	20.37	20.20
10	1	0	QPSK	22.10	22.37	22.23
10	1	24		22.30	22.34	22.17
10	1	49		22.06	22.07	22.03
10	25	0		21.31	21.39	21.22
10	25	12		21.38	21.36	21.21
10	25	24		21.33	21.34	21.17
10	50	0		21.39	21.39	21.25
10	1	0	16-QAM	21.38	21.69	21.57
10	1	24		21.65	21.65	21.49
10	1	49		21.39	21.42	21.29
10	25	0		20.34	20.42	20.27
10	25	12		20.45	20.38	20.26
10	25	24		20.41	20.37	20.21
10	50	0		20.44	20.42	20.29



LTE Band 2 Maximum Average Power [dBm]						
BW [MHz]	RB Size	RB Offset	Mod	Lowest	Middle	Highest
15	1	0	QPSK	22.14	22.44	22.26
15	1	37		22.16	22.33	22.24
15	1	74		22.25	21.95	22.05
15	36	0		21.30	21.50	21.33
15	36	18		21.23	21.42	21.29
15	36	37		21.24	21.26	21.24
15	75	0		21.26	21.42	21.27
15	1	0	16-QAM	21.42	21.74	21.61
15	1	37		21.50	21.66	21.56
15	1	74		21.58	21.29	21.28
15	36	0		20.35	20.52	20.37
15	36	18		20.27	20.45	20.34
15	36	37		20.29	20.33	20.29
15	75	0		20.32	20.44	20.32
20	1	0	QPSK	22.18	22.44	22.26
20	1	49		22.19	22.30	22.25
20	1	99		22.12	21.90	22.02
20	50	0		21.28	21.49	21.28
20	50	24		21.26	21.40	21.29
20	50	49		21.27	21.11	21.24
20	100	0		21.29	21.39	21.30
20	1	0	16-QAM	21.45	21.76	21.55
20	1	49		21.53	21.62	21.57
20	1	99		21.47	21.26	21.30
20	50	0		20.35	20.51	20.37
20	50	24		20.31	20.44	20.34
20	50	49		20.31	20.22	20.28
20	100	0		20.34	20.43	20.33



LTE Band 4 Maximum Average Power [dBm]						
BW [MHz]	RB Size	RB Offset	Mod	Lowest	Middle	Highest
1.4	1	0	QPSK	22.04	22.09	22.34
1.4	1	2		22.13	22.26	22.11
1.4	1	5		22.05	22.00	22.14
1.4	3	0		22.12	22.16	22.23
1.4	3	1		22.12	22.05	22.19
1.4	3	2		22.10	22.03	22.18
1.4	6	0		21.04	21.38	21.10
1.4	1	0	16-QAM	21.24	21.82	21.48
1.4	1	2		21.29	22.02	21.63
1.4	1	5		21.22	21.75	21.56
1.4	3	0		21.19	21.75	21.33
1.4	3	1		21.09	21.87	21.55
1.4	3	2		21.09	21.82	21.46
1.4	6	0		20.61	20.91	21.07
3	1	0	QPSK	22.02	22.07	22.05
3	1	7		22.10	22.14	22.16
3	1	14		22.01	22.06	22.10
3	8	0		21.17	21.21	21.22
3	8	4		21.16	21.20	21.23
3	8	7		21.14	21.19	21.21
3	15	0		21.12	21.18	21.20
3	1	0	16-QAM	21.35	21.38	21.47
3	1	7		21.42	21.38	21.41
3	1	14		21.33	21.33	21.34
3	8	0		20.28	20.22	20.10
3	8	4		20.28	20.16	20.08
3	8	7		20.26	20.24	20.26
3	15	0		20.19	20.34	20.32



LTE Band 4 Maximum Average Power [dBm]						
BW [MHz]	RB Size	RB Offset	Mod	Lowest	Middle	Highest
5	1	0	QPSK	22.10	22.17	22.18
5	1	12		22.14	22.19	22.20
5	1	24		22.04	22.07	22.10
5	12	0		21.19	21.24	21.26
5	12	6		21.18	21.23	21.25
5	12	11		21.18	21.23	21.17
5	25	0		21.14	21.19	21.21
5	1	0	16-QAM	21.45	21.48	21.53
5	1	12		21.47	21.51	21.53
5	1	24		21.38	21.39	21.43
5	12	0		20.24	20.27	20.30
5	12	6		20.23	20.26	20.30
5	12	11		20.23	20.17	20.30
5	25	0		20.19	20.09	20.24
10	1	0	QPSK	22.18	22.17	22.16
10	1	24		22.20	22.16	22.16
10	1	49		22.09	22.07	22.09
10	25	0		21.25	21.21	21.20
10	25	12		21.23	21.19	21.18
10	25	24		21.19	21.17	21.17
10	50	0		21.22	21.19	21.21
10	1	0	16-QAM	21.53	21.49	21.52
10	1	24		21.56	21.50	21.50
10	1	49		21.45	21.42	21.42
10	25	0		20.26	20.22	20.22
10	25	12		20.24	20.21	20.20
10	25	24		20.21	20.20	20.19
10	50	0		20.23	20.20	20.22



LTE Band 4 Maximum Average Power [dBm]						
BW [MHz]	RB Size	RB Offset	Mod	Lowest	Middle	Highest
15	1	0	QPSK	22.21	22.19	22.18
15	1	37		22.22	22.17	22.17
15	1	74		22.09	22.05	22.06
15	36	0		21.30	21.25	21.24
15	36	18		21.27	21.24	21.24
15	36	37		21.20	21.19	21.19
15	75	0		21.23	21.23	21.18
15	1	0	16-QAM	21.53	21.49	21.52
15	1	37		21.55	21.49	21.51
15	1	74		21.41	21.41	21.42
15	36	0		20.30	20.26	20.25
15	36	18		20.27	20.25	20.24
15	36	37		20.22	20.22	20.20
15	75	0		20.24	20.24	20.24
20	1	0	QPSK	22.18	22.19	22.35
20	1	49		22.19	22.16	22.18
20	1	99		22.05	22.04	22.04
20	50	0		21.24	21.23	21.23
20	50	24		21.21	21.22	21.20
20	50	49		21.16	21.18	21.16
20	100	0		21.19	21.19	21.17
20	1	0	16-QAM	21.52	21.52	21.51
20	1	49		21.50	21.48	21.50
20	1	99		21.36	21.39	21.38
20	50	0		20.26	20.24	20.25
20	50	24		20.23	20.23	20.20
20	50	49		20.17	20.19	20.17
20	100	0		20.20	20.20	20.18



LTE Band 5 Maximum Average Power [dBm]						
BW [MHz]	RB Size	RB Offset	Mod	Lowest	Middle	Highest
1.4	1	0	QPSK	22.70	22.77	22.69
1.4	1	2		22.79	22.89	22.74
1.4	1	5		22.69	22.91	22.16
1.4	3	0		22.84	22.96	22.34
1.4	3	1		22.79	22.84	22.33
1.4	3	2		22.81	22.63	22.42
1.4	6	0		21.85	22.02	21.92
1.4	1	0	16-QAM	22.01	22.34	22.19
1.4	1	2		22.09	22.46	22.29
1.4	1	5		21.99	22.43	22.14
1.4	3	0		21.86	22.15	22.08
1.4	3	1		21.81	22.07	22.14
1.4	3	2		21.81	22.09	22.11
1.4	6	0		20.92	21.03	20.99
3	1	0	QPSK	22.92	22.74	22.72
3	1	7		22.78	22.81	22.87
3	1	14		22.72	22.70	22.96
3	8	0		21.84	21.90	22.01
3	8	4		21.86	21.90	22.12
3	8	7		21.84	21.89	21.99
3	15	0		21.84	21.82	22.03
3	1	0	16-QAM	21.96	22.17	22.40
3	1	7		22.01	22.22	22.39
3	1	14		21.98	22.11	22.15
3	8	0		20.89	21.03	21.20
3	8	4		20.87	21.03	21.12
3	8	7		20.87	21.01	21.17
3	15	0		20.83	20.93	21.04



LTE Band 5 Maximum Average Power [dBm]						
BW [MHz]	RB Size	RB Offset	Mod	Lowest	Middle	Highest
5	1	0	QPSK	22.97	22.80	23.02
5	1	12		22.67	22.85	23.11
5	1	24		22.33	22.85	22.47
5	12	0		22.04	21.99	22.18
5	12	6		22.02	22.12	21.91
5	12	11		22.14	22.10	22.05
5	25	0		21.91	22.01	22.07
5	1	0	16-QAM	22.07	22.46	22.27
5	1	12		22.15	22.46	22.43
5	1	24		22.09	22.25	22.06
5	12	0		20.85	21.27	21.03
5	12	6		20.85	21.13	21.11
5	12	11		20.85	20.95	21.15
5	25	0		20.80	20.91	21.07
10	1	0	QPSK	23.12	22.86	22.77
10	1	24		22.70	22.99	22.79
10	1	49		22.46	22.88	22.87
10	25	0		21.92	22.05	21.94
10	25	12		21.68	22.08	21.90
10	25	24		21.72	22.06	21.88
10	50	0		21.74	22.09	21.88
10	1	0	16-QAM	22.05	22.27	22.15
10	1	24		22.30	22.42	22.11
10	1	49		22.21	22.22	22.07
10	25	0		20.82	21.08	20.85
10	25	12		20.92	21.01	20.86
10	25	24		20.95	20.89	20.86
10	50	0		20.85	20.90	20.86



LTE Band 7 Maximum Average Power [dBm]						
BW [MHz]	RB Size	RB Offset	Mod	Lowest	Middle	Highest
5	1	0	QPSK	21.31	21.81	21.87
5	1	12		21.36	21.88	21.88
5	1	24		21.31	21.85	21.77
5	12	0		20.42	20.92	20.98
5	12	6		20.42	20.93	20.96
5	12	11		20.44	20.95	20.95
5	25	0		20.39	20.89	20.94
5	1	0	16-QAM	20.57	21.06	21.13
5	1	12		20.62	21.12	21.12
5	1	24		20.59	21.11	21.03
5	12	0		19.44	19.95	20.00
5	12	6		19.46	19.94	19.99
5	12	11		19.48	19.97	19.98
5	25	0		19.40	19.91	19.95
10	1	0	QPSK	21.29	21.75	21.89
10	1	24		21.36	21.87	21.91
10	1	49		21.35	21.88	21.79
10	25	0		20.37	20.86	20.98
10	25	12		20.40	20.87	20.97
10	25	24		20.44	20.95	20.95
10	50	0		20.44	20.91	21.00
10	1	0	16-QAM	20.56	21.00	21.19
10	1	24		20.64	21.13	21.17
10	1	49		20.67	21.17	21.10
10	25	0		19.40	19.87	20.00
10	25	12		19.44	19.90	19.98
10	25	24		19.47	19.97	19.95
10	50	0		19.47	19.93	20.02



LTE Band 7 Maximum Average Power [dBm]						
BW [MHz]	RB Size	RB Offset	Mod	Lowest	Middle	Highest
15	1	0	QPSK	21.40	21.68	21.91
15	1	37		21.55	21.86	21.96
15	1	74		21.51	21.95	21.85
15	36	0		20.58	20.85	21.04
15	36	18		20.61	20.92	21.06
15	36	37		20.62	21.00	21.04
15	75	0		20.58	20.92	21.02
15	1	0	16-QAM	20.66	20.97	21.18
15	1	37		20.83	21.12	21.22
15	1	74		20.82	21.21	21.11
15	36	0		19.61	19.87	20.05
15	36	18		19.65	19.97	20.08
15	36	37		19.65	20.01	20.06
15	75	0		19.61	19.94	20.04
20	1	0	QPSK	21.70	21.59	21.97
20	1	49		21.38	21.83	21.82
20	1	99		21.37	21.92	21.84
20	50	0		20.40	20.81	20.98
20	50	24		20.40	20.90	21.03
20	50	49		20.31	20.98	21.02
20	100	0		20.24	20.87	20.99
20	1	0	16-QAM	20.64	20.92	21.15
20	1	49		20.82	21.11	21.25
20	1	99		20.81	21.22	21.11
20	50	0		19.44	19.84	20.00
20	50	24		19.45	19.93	20.04
20	50	49		19.52	20.01	20.04
20	100	0		19.50	19.89	20.01



LTE Band 12 Maximum Average Power [dBm]						
BW [MHz]	RB Size	RB Offset	Mod	Lowest	Middle	Highest
1.4	1	0	QPSK	22.38	22.33	22.46
1.4	1	2		22.48	22.44	22.52
1.4	1	5		22.39	22.33	22.42
1.4	3	0		22.48	22.43	22.56
1.4	3	1		22.43	22.38	22.50
1.4	3	2		22.43	22.38	22.49
1.4	6	0		21.46	21.42	21.52
1.4	1	0	16-QAM	21.70	21.68	21.82
1.4	1	2		21.82	21.76	21.87
1.4	1	5		21.73	21.66	21.77
1.4	3	0		21.53	21.47	21.61
1.4	3	1		21.48	21.44	21.56
1.4	3	2		21.48	21.42	21.54
1.4	6	0		20.59	20.56	20.63
3	1	0	QPSK	22.31	22.29	22.37
3	1	7		22.38	22.34	22.46
3	1	14		22.34	22.25	22.33
3	8	0		21.45	21.41	21.51
3	8	4		21.45	21.41	21.52
3	8	7		21.45	21.41	21.50
3	15	0		21.45	21.40	21.49
3	1	0	16-QAM	21.66	21.64	21.75
3	1	7		21.72	21.68	21.81
3	1	14		21.73	21.58	21.66
3	8	0		20.56	20.54	20.64
3	8	4		20.57	20.54	20.65
3	8	7		20.57	20.54	20.63
3	15	0		20.52	20.47	20.57



LTE Band 12 Maximum Average Power [dBm]						
BW [MHz]	RB Size	RB Offset	Mod	Lowest	Middle	Highest
5	1	0	QPSK	22.35	22.35	22.33
5	1	12		22.42	22.36	22.45
5	1	24		22.35	22.30	22.36
5	12	0		21.48	21.46	21.48
5	12	6		21.47	21.44	21.50
5	12	11		21.49	21.42	21.50
5	25	0		21.42	21.39	21.43
5	1	0	16-QAM	21.69	21.70	21.69
5	1	12		21.79	21.69	21.82
5	1	24		21.72	21.64	21.70
5	12	0		20.55	20.54	20.55
5	12	6		20.54	20.52	20.58
5	12	11		20.55	20.49	20.59
5	25	0		20.48	20.46	20.50
10	1	0	QPSK	22.33	22.57	22.27
10	1	24		22.41	22.36	22.34
10	1	49		22.35	22.37	22.37
10	25	0		21.39	21.37	21.22
10	25	12		21.40	21.38	21.21
10	25	24		21.42	21.40	21.41
10	50	0		21.40	21.41	21.26
10	1	0	16-QAM	21.69	21.72	21.55
10	1	24		21.77	21.67	21.58
10	1	49		21.69	21.73	21.69
10	25	0		20.45	20.43	20.88
10	25	12		20.47	20.35	21.28
10	25	24		20.48	20.34	21.06
10	50	0		20.46	20.53	21.25



LTE Band 13 Maximum Average Power [dBm]						
BW [MHz]	RB Size	RB Offset	Mod	Lowest	Middle	Highest
5	1	0	QPSK	22.68	22.61	22.61
5	1	12		22.64	22.65	22.67
5	1	24		22.58	22.59	22.58
5	12	0		22.76	22.70	22.70
5	12	6		22.76	22.68	22.72
5	12	11		22.71	22.69	22.73
5	25	0		22.66	22.63	22.65
5	1	0	16-QAM	23.00	22.96	22.94
5	1	12		22.98	22.95	22.98
5	1	24		22.90	22.92	22.92
5	12	0		22.81	22.75	22.73
5	12	6		22.81	22.72	22.76
5	12	11		22.77	22.73	22.77
5	25	0		22.72	22.67	22.68
10	1	0	QPSK	-	22.66	-
10	1	24		22.64	-	-
10	1	49		22.63	-	-
10	25	0		22.69	-	-
10	25	12		22.63	-	-
10	25	24		22.67	-	-
10	50	0		22.68	-	-
10	1	0	16-QAM	-	22.99	-
10	1	24		22.97	-	-
10	1	49		22.98	-	-
10	25	0		22.75	-	-
10	25	12		22.67	-	-
10	25	24		22.71	-	-
10	50	0		22.71	-	-



LTE Band 17 Maximum Average Power [dBm]						
BW [MHz]	RB Size	RB Offset	Mod	Lowest	Middle	Highest
5	1	0	QPSK	22.83	22.82	22.79
5	1	12		22.84	22.84	22.87
5	1	24		22.86	22.89	22.88
5	12	0		21.86	21.85	21.86
5	12	6		21.89	21.89	21.87
5	12	11		21.94	21.92	21.93
5	25	0		21.92	21.91	21.93
5	1	0	16-QAM	22.17	22.11	22.10
5	1	12		22.13	22.14	22.18
5	1	24		22.23	22.25	22.20
5	12	0		20.91	20.89	20.89
5	12	6		20.91	20.91	20.90
5	12	11		20.95	20.95	20.96
5	25	0		20.94	20.94	20.95
10	1	0	QPSK	23.05	22.80	22.84
10	1	24		23.00	22.85	22.90
10	1	49		22.83	22.83	22.85
10	25	0		21.94	21.91	21.93
10	25	12		21.95	21.93	21.96
10	25	24		21.95	21.94	21.98
10	50	0		21.92	21.88	21.91
10	1	0	16-QAM	22.21	22.08	22.16
10	1	24		22.19	22.14	22.25
10	1	49		22.09	22.17	22.17
10	25	0		20.98	20.94	20.97
10	25	12		21.00	20.96	20.99
10	25	24		21.00	20.98	21.03
10	50	0		20.93	20.90	20.93



LTE Band 2

Peak-to-Average Ratio

Mode	LTE Band 2 / 20MHz				
Mod.	QPSK		16QAM		Limit: 13dB
RB Size	1RB	Full RB	1RB	Full RB	Result
Lowest CH	4.7	5.3	5.86	6.26	PASS
Middle CH	4.96	5.48	6.03	6.43	
Highest CH	4.7	5.54	6.32	6.43	



LTE Band 2 / 20MHz / QPSK

Lowest Channel / 1RB



Date: 16.MAY.2015 10:07:25

Lowest Channel / Full RB



Date: 16.MAY.2015 10:07:37

Middle Channel / 1RB



Date: 16.MAY.2015 10:07:49

Middle Channel / Full RB



Date: 16.MAY.2015 10:08:02

Highest Channel / 1RB

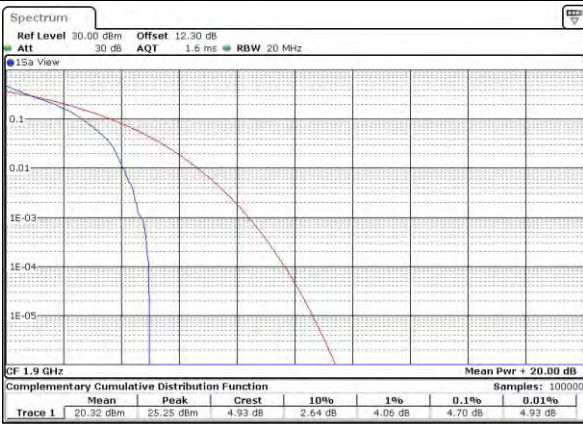

Date: 16.MAY.2015 10:08:15

Highest Channel / Full RB

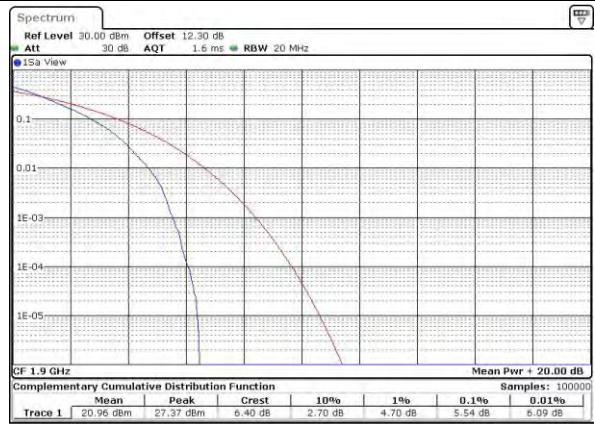

Date: 16.MAY.2015 10:08:28



LTE Band 2 / 20MHz / 16QAM

Lowest Channel / 1RB

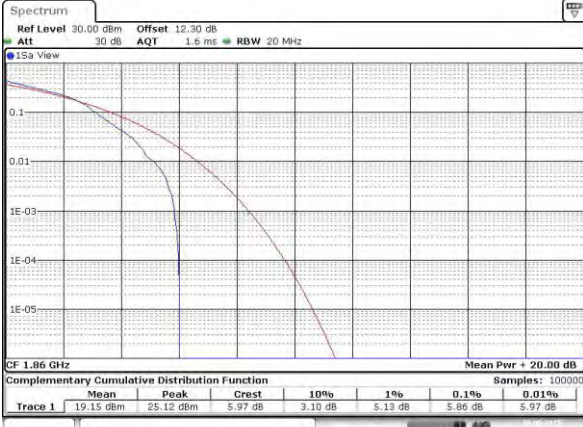

Date: 16.MAY.2015 10:05:16

Lowest Channel / Full RB

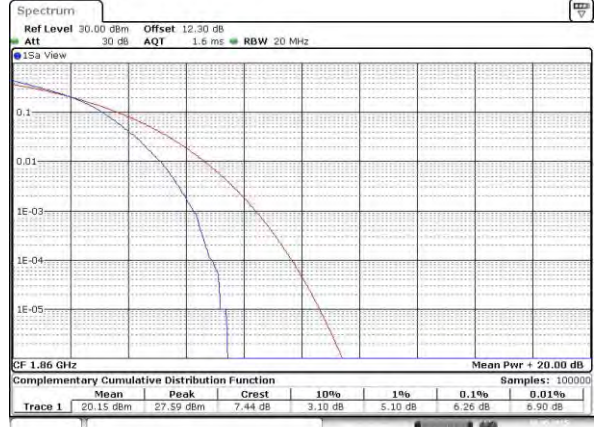

Date: 16.MAY.2015 10:05:31

Middle Channel / 1RB

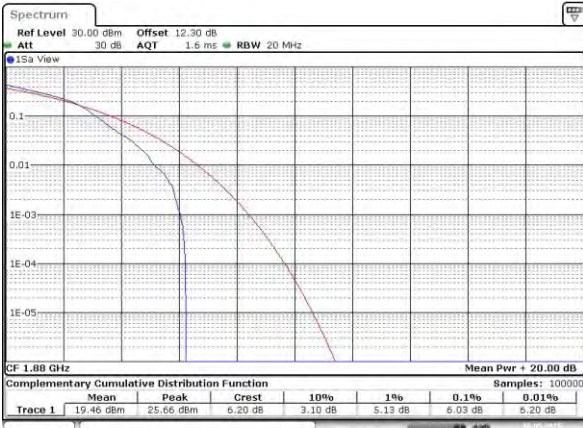

Date: 16.MAY.2015 10:05:43

Middle Channel / Full RB



Date: 16.MAY.2015 10:05:56

Highest Channel / 1RB

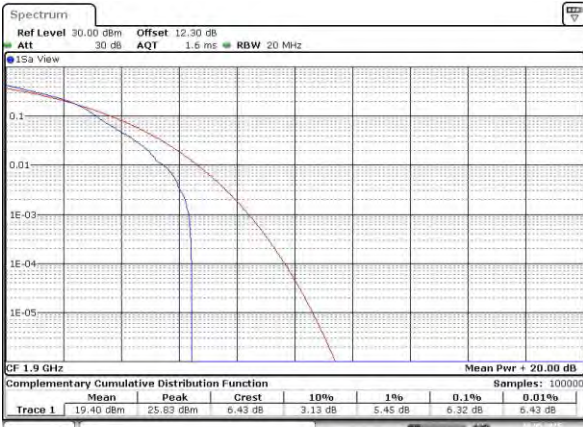

Date: 16.MAY.2015 10:06:09

Highest Channel / Full RB

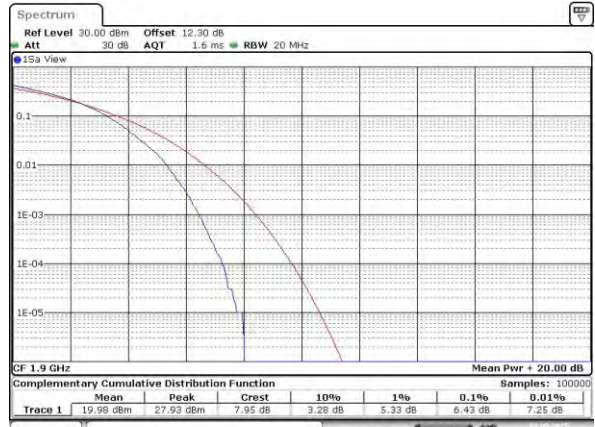

Date: 16.MAY.2015 10:06:21



26dB Bandwidth

Mode	LTE Band 2 : 26dB BW(MHz)											
	1.4MHz		3MHz		5MHz		10MHz		15MHz		20MHz	
BW												
Mod.	QPSK	16QAM	QPSK	16QAM	QPSK	16QAM	QPSK	16QAM	QPSK	16QAM	QPSK	16QAM
Lowest CH	1.26	1.28	3.02	3.03	5.06	5.09	9.97	10.01	14.78	14.81	20.34	20.46
Middle CH	1.26	1.28	3.02	3.03	5.07	5.11	10.09	9.95	14.81	14.84	20.66	20.50
Highest CH	1.26	1.27	3.02	3.03	5.08	5.10	9.95	10.05	14.84	14.90	20.26	20.34



LTE Band 2

Lowest Channel / 1.4MHz / QPSK

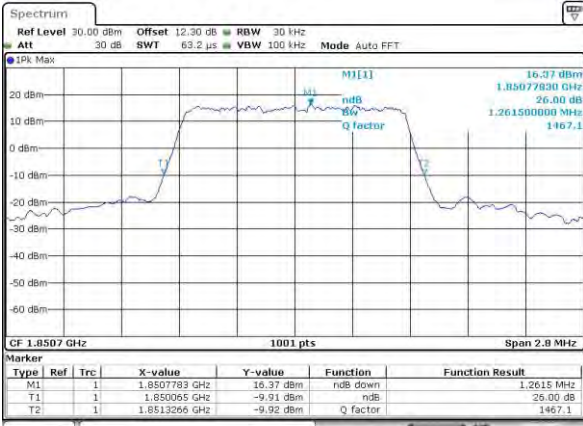

Date: 16.MAY.2015 09:45:15

Lowest Channel / 1.4MHz / 16QAM

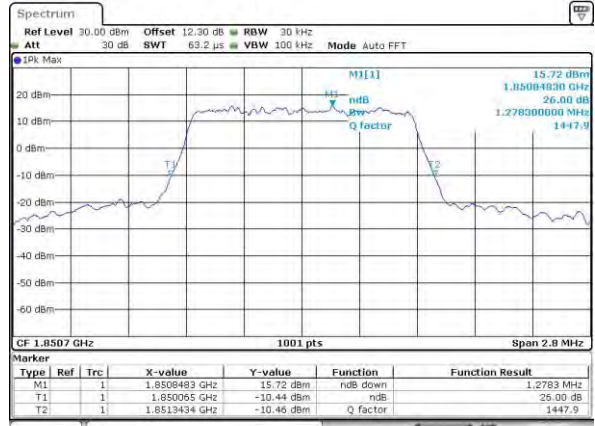

Date: 16.MAY.2015 09:46:05

Middle Channel / 1.4MHz / QPSK

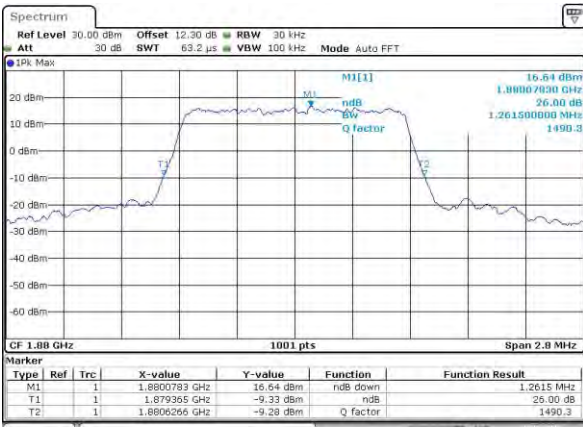

Date: 16.MAY.2015 09:53:49

Middle Channel / 1.4MHz / 16QAM

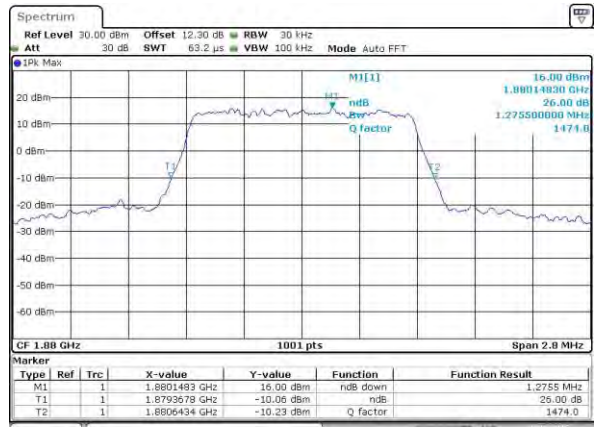

Date: 16.MAY.2015 09:54:03

Highest Channel / 1.4MHz / QPSK

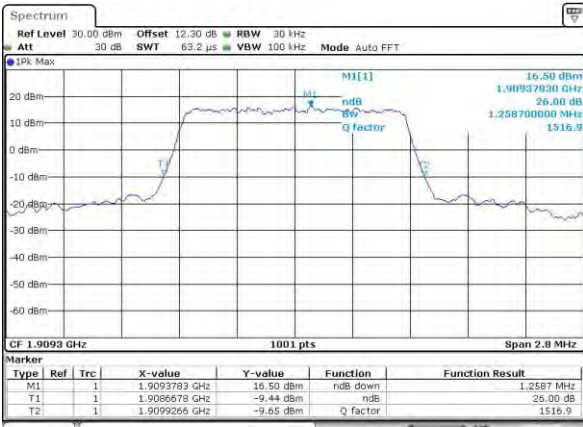

Date: 16.MAY.2015 09:57:08

Highest Channel / 1.4MHz / 16QAM

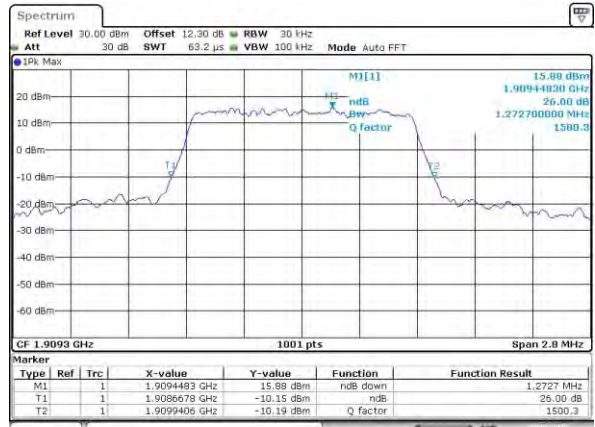

Date: 16.MAY.2015 09:57:22



LTE Band 2

Lowest Channel / 3MHz / QPSK

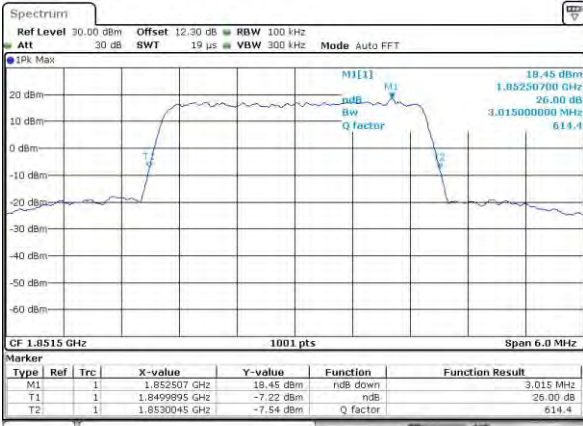

Date: 16.MAY.2015 09:09:18

Lowest Channel / 3MHz / 16QAM

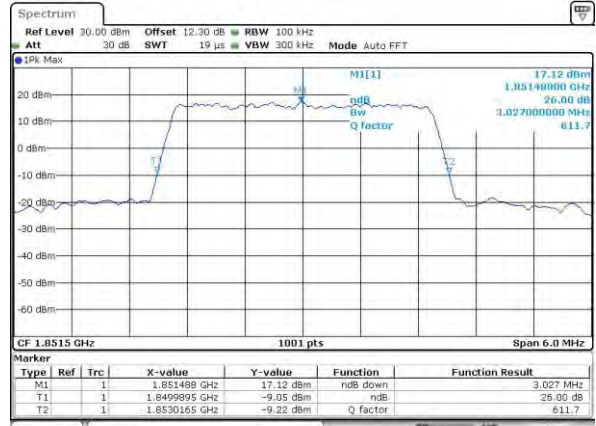

Date: 16.MAY.2015 09:09:33

Middle Channel / 3MHz / QPSK

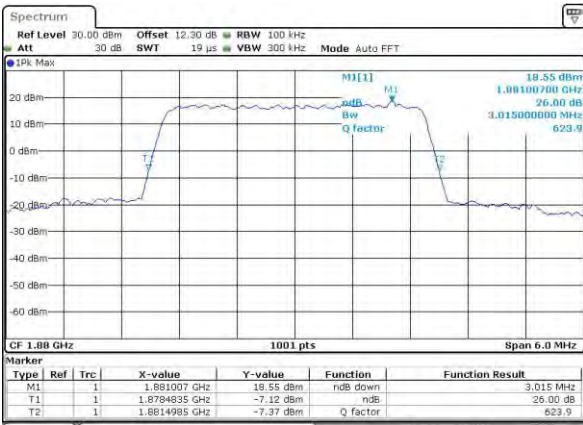

Date: 16.MAY.2015 09:17:21

Middle Channel / 3MHz / 16QAM

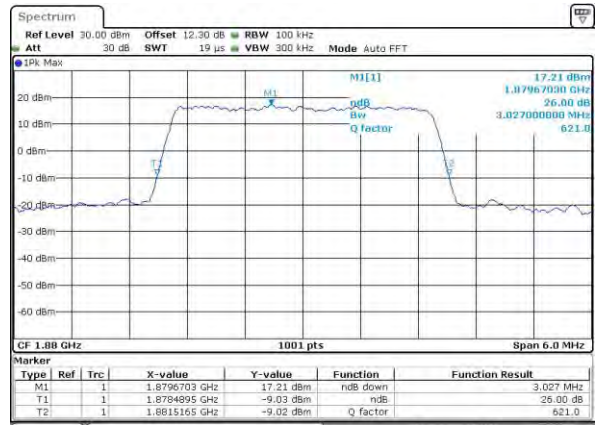

Date: 16.MAY.2015 09:17:33

Highest Channel / 3MHz / QPSK

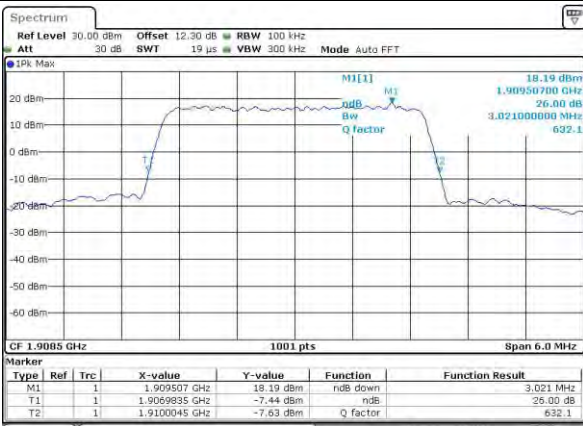

Date: 16.MAY.2015 09:20:41

Highest Channel / 3MHz / 16QAM

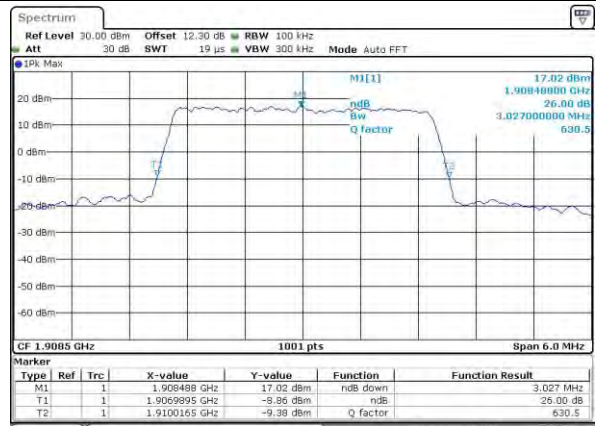

Date: 16.MAY.2015 09:20:55



LTE Band 2

Lowest Channel / 5MHz / QPSK

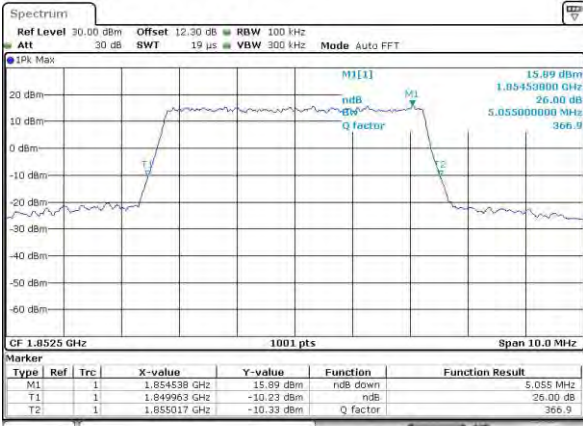

Date: 16.MAY.2015 09:28:42

Lowest Channel / 5MHz / 16QAM

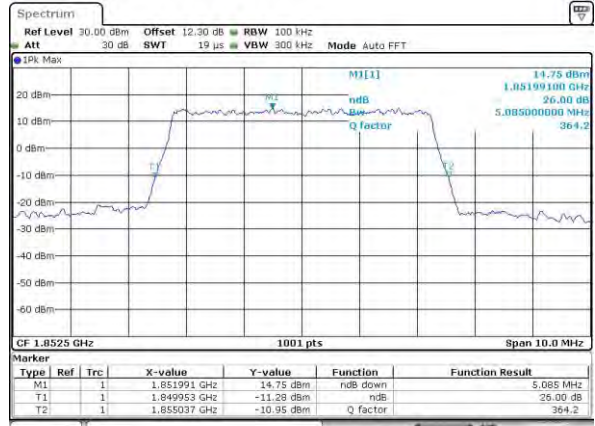

Date: 16.MAY.2015 09:28:56

Middle Channel / 5MHz / QPSK

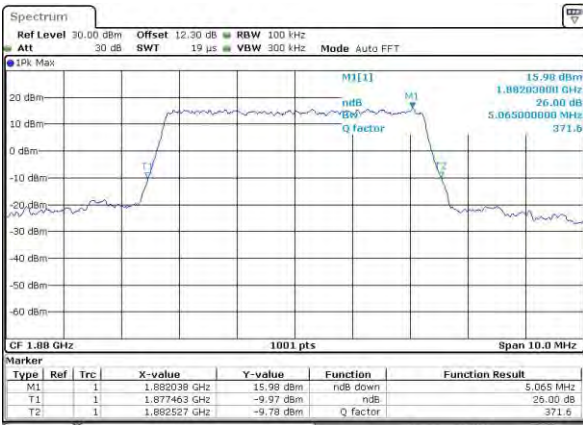

Date: 16.MAY.2015 09:28:42

Middle Channel / 5MHz / 16QAM

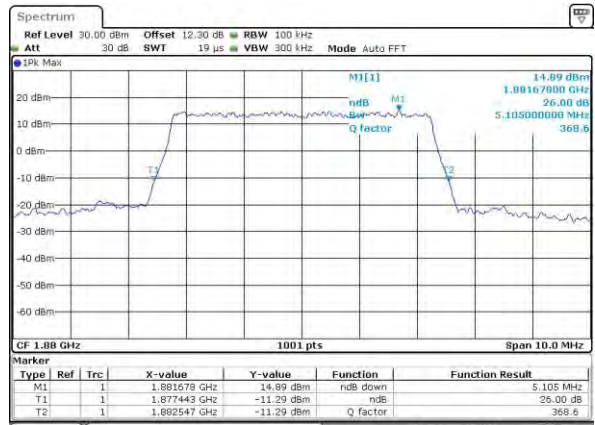

Date: 16.MAY.2015 09:28:56

Highest Channel / 5MHz / QPSK

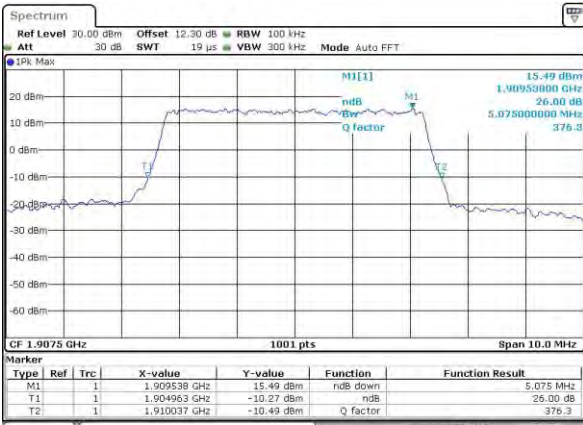

Date: 16.MAY.2015 09:40:02

Highest Channel / 5MHz / 16QAM

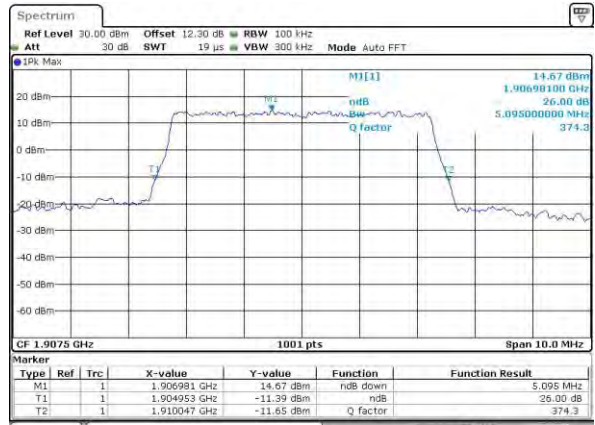

Date: 16.MAY.2015 09:40:16



LTE Band 2

Lowest Channel / 10MHz / QPSK

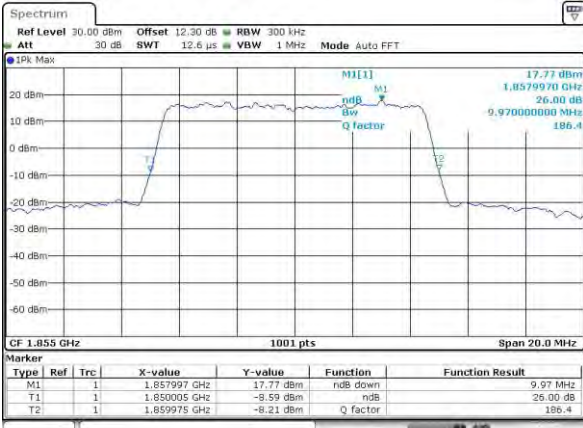

Date: 16.MAY.2015 09:48:02

Lowest Channel / 10MHz / 16QAM

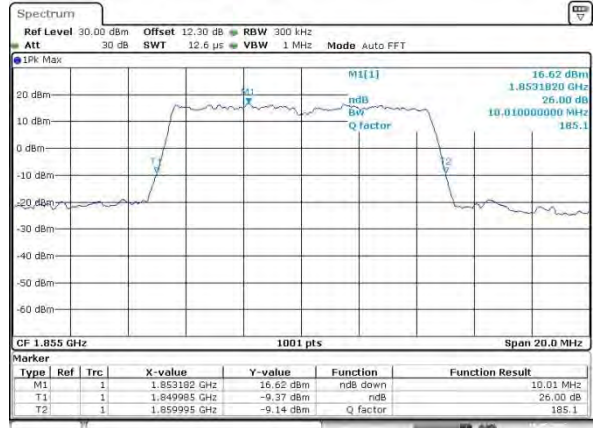

Date: 16.MAY.2015 08:48:16

Middle Channel / 10MHz / QPSK

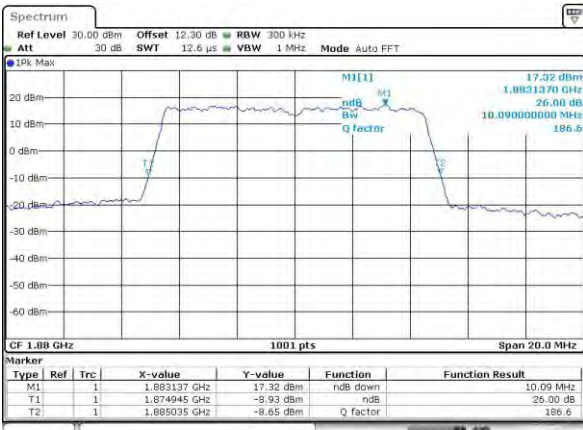

Date: 16.MAY.2015 09:56:00

Middle Channel / 10MHz / 16QAM

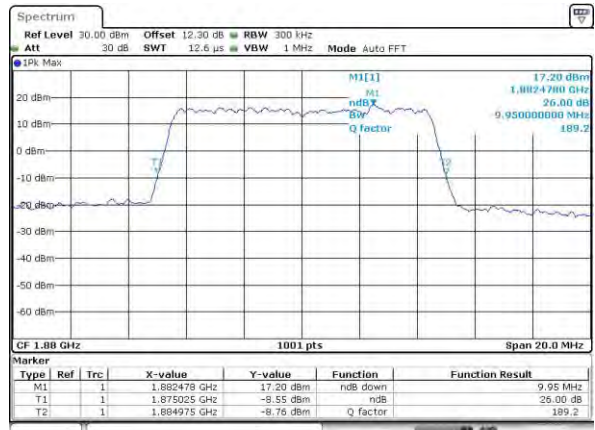

Date: 16.MAY.2015 08:56:14

Highest Channel / 10MHz / QPSK

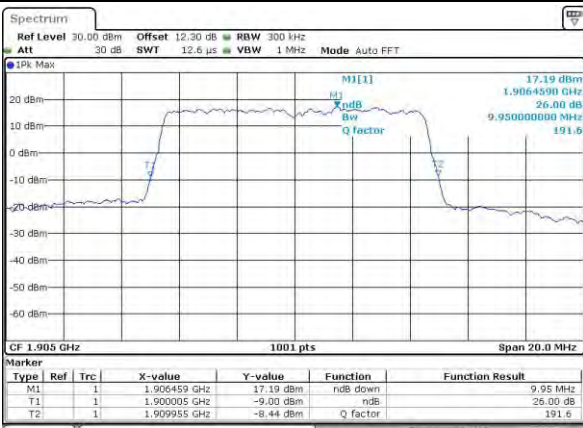

Date: 16.MAY.2015 09:59:19

Highest Channel / 10MHz / 16QAM

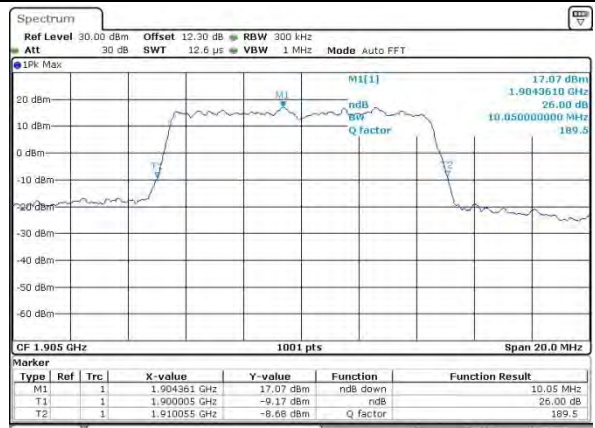

Date: 16.MAY.2015 08:59:33



LTE Band 2

Lowest Channel / 15MHz / QPSK

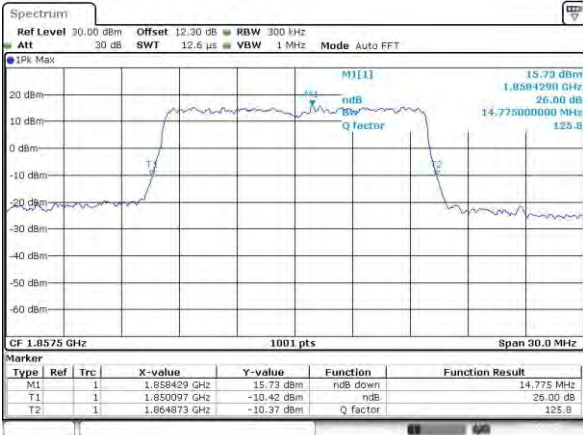

Date: 16.MAY.2015 09:07:18

Lowest Channel / 15MHz / 16QAM

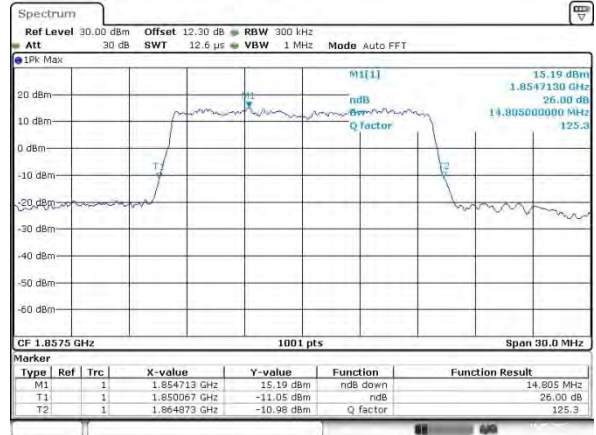

Date: 16.MAY.2015 09:07:32

Middle Channel / 15MHz / QPSK

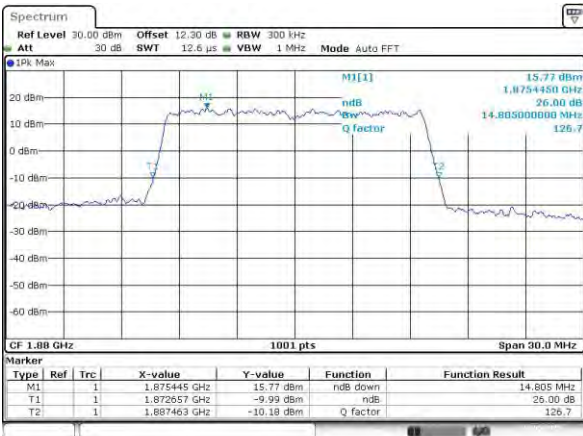

Date: 16.MAY.2015 09:15:17

Middle Channel / 15MHz / 16QAM

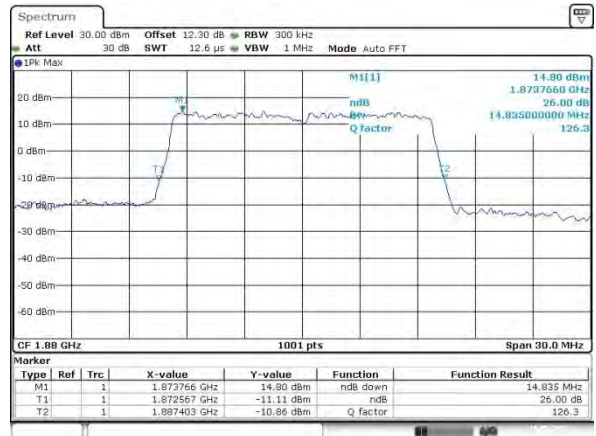

Date: 16.MAY.2015 09:15:33

Highest Channel / 15MHz / QPSK

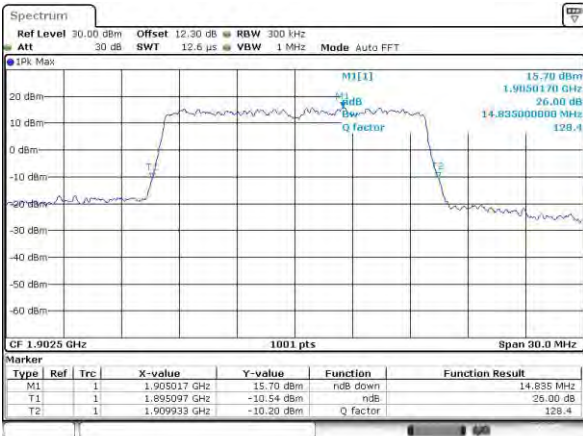

Date: 16.MAY.2015 09:18:36

Highest Channel / 15MHz / 16QAM

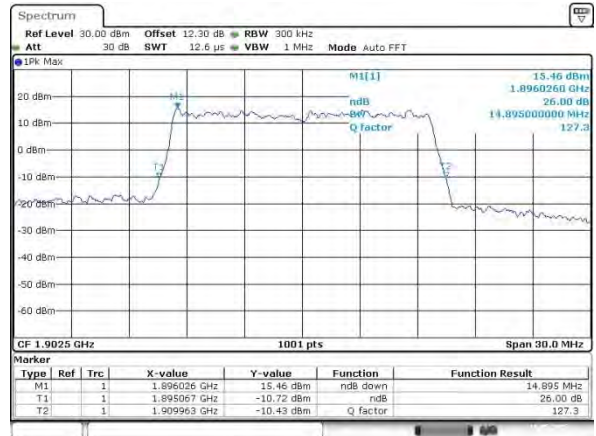

Date: 16.MAY.2015 09:18:50



LTE Band 2

Lowest Channel / 20MHz / QPSK

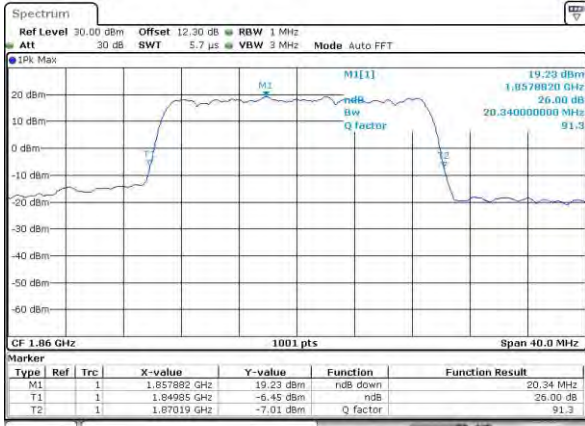

Date: 16.MAY.2015 09:28:34

Lowest Channel / 20MHz / 16QAM

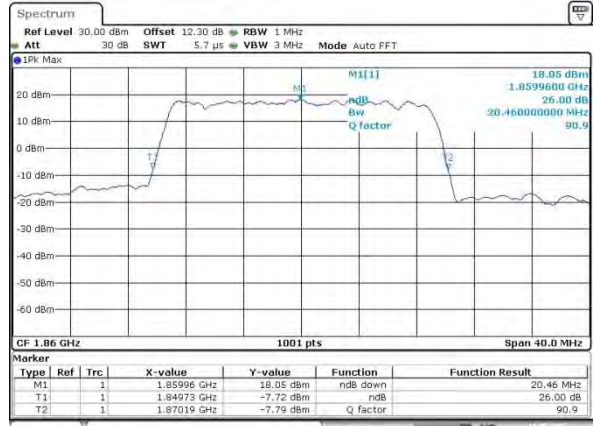

Date: 16.MAY.2015 09:28:48

Middle Channel / 20MHz / QPSK

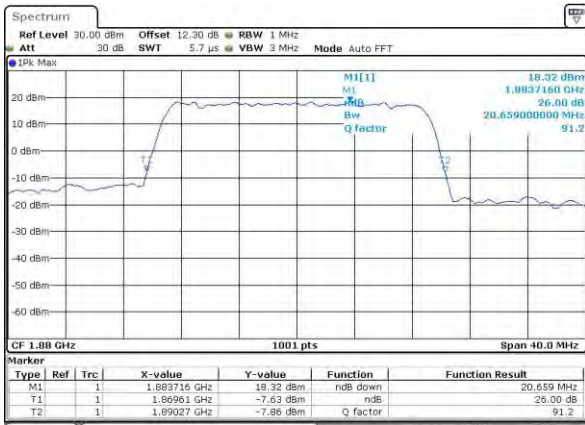

Date: 16.MAY.2015 09:34:03

Middle Channel / 20MHz / 16QAM

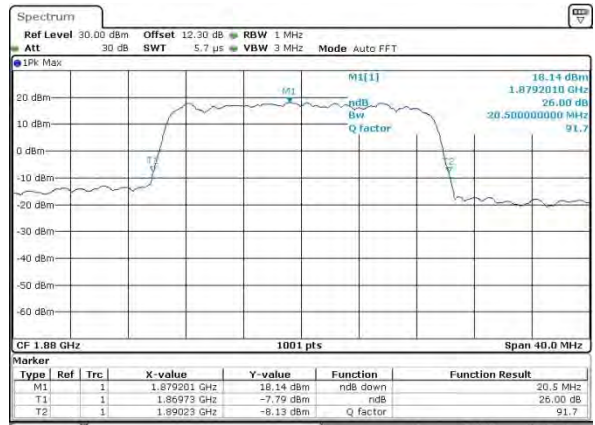

Date: 16.MAY.2015 09:34:47

Highest Channel / 20MHz / QPSK

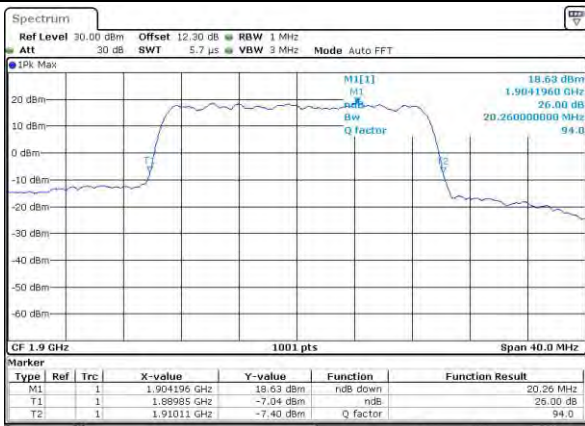

Date: 16.MAY.2015 09:37:53

Highest Channel / 20MHz / 16QAM

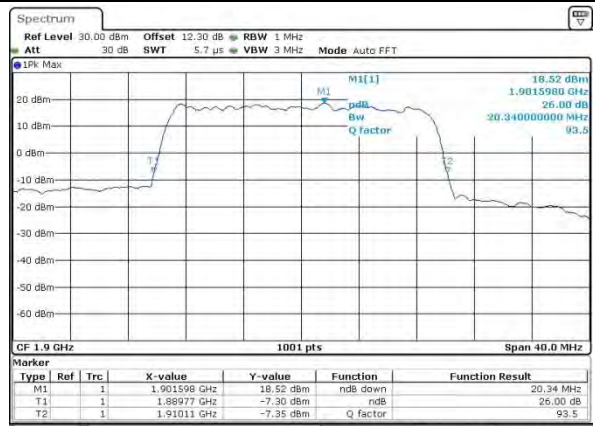

Date: 16.MAY.2015 09:38:06



Occupied Bandwidth

Mode	LTE Band 2 : 99%OBW(MHz)											
	1.4MHz		3MHz		5MHz		10MHz		15MHz		20MHz	
BW	QPSK	16QAM	QPSK	16QAM	QPSK	16QAM	QPSK	16QAM	QPSK	16QAM	QPSK	16QAM
Lowest CH	1.09	1.09	2.73	2.71	4.51	4.5	9.07	9.03	13.49	13.49	18.42	18.46
Middle CH	1.09	1.09	2.72	2.73	4.51	4.5	9.09	9.05	13.52	13.46	18.34	18.34
Highest CH	1.1	1.1	2.72	2.72	4.51	4.51	9.09	9.03	13.49	13.43	18.38	18.38



LTE Band 2

Lowest Channel / 1.4MHz / QPSK

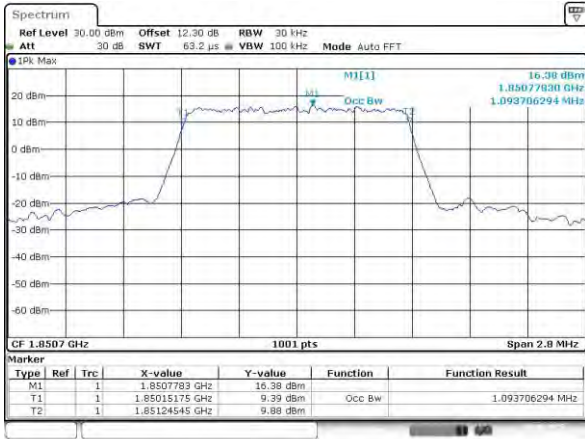

Lowest Channel / 1.4MHz / 16QAM

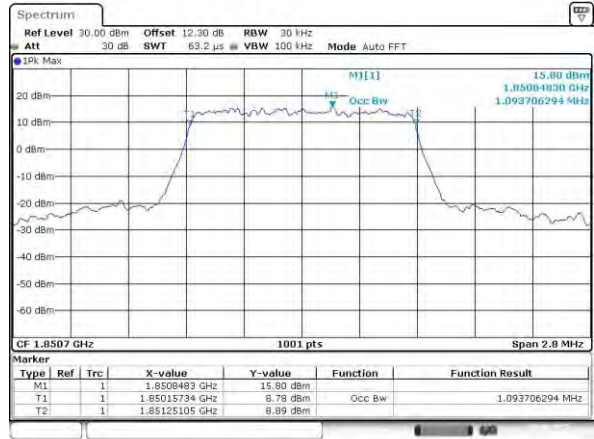

Middle Channel / 1.4MHz / QPSK

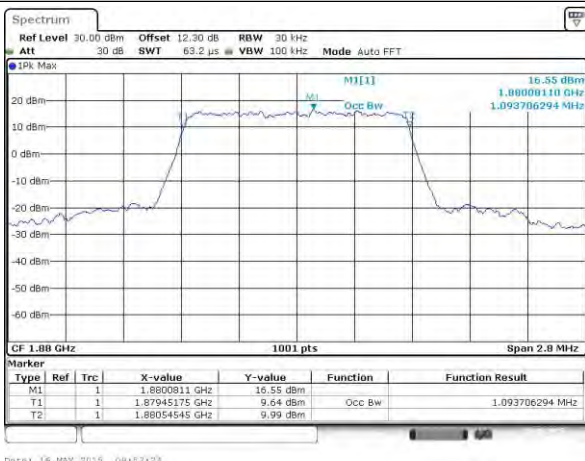

Middle Channel / 1.4MHz / 16QAM

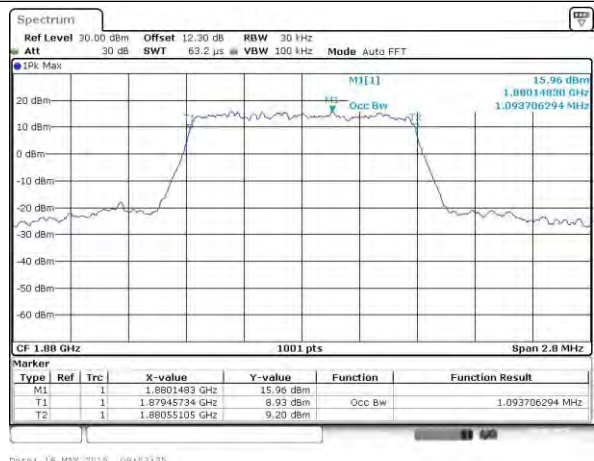

Highest Channel / 1.4MHz / QPSK

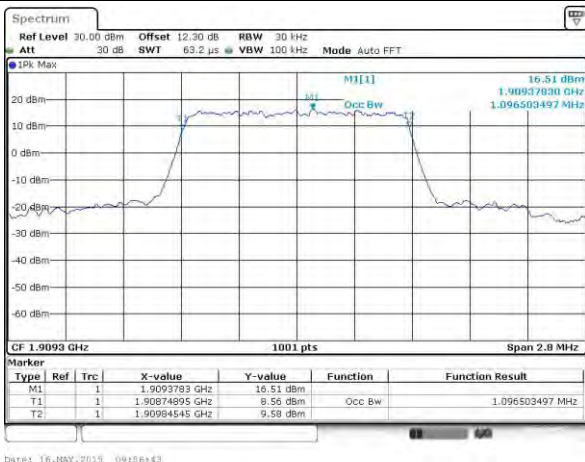

Highest Channel / 1.4MHz / 16QAM

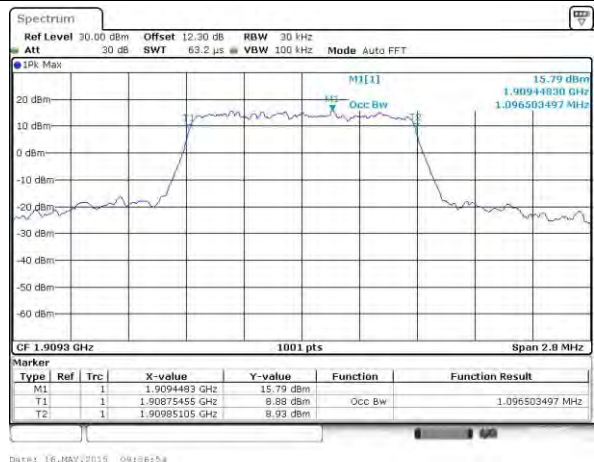



LTE Band 2

Lowest Channel / 3MHz / QPSK

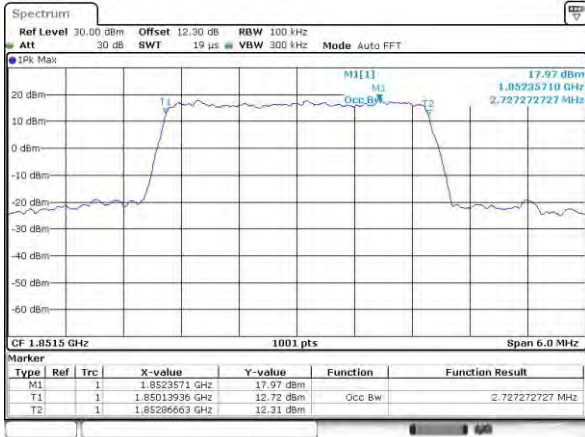

Date: 16.MAY.2015 09:10:53

Lowest Channel / 3MHz / 16QAM

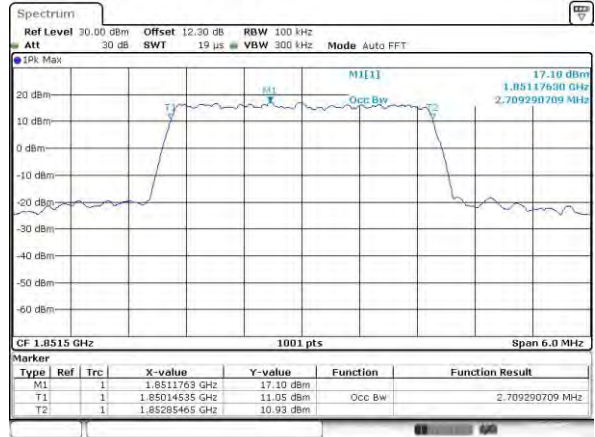

Date: 16.MAY.2015 09:10:04

Middle Channel / 3MHz / QPSK

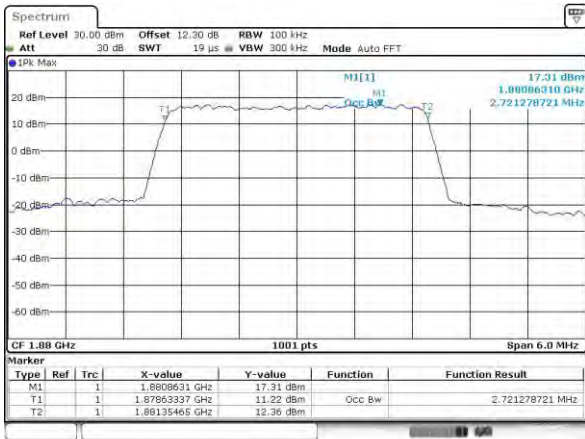

Date: 16.MAY.2015 09:14:56

Middle Channel / 3MHz / 16QAM

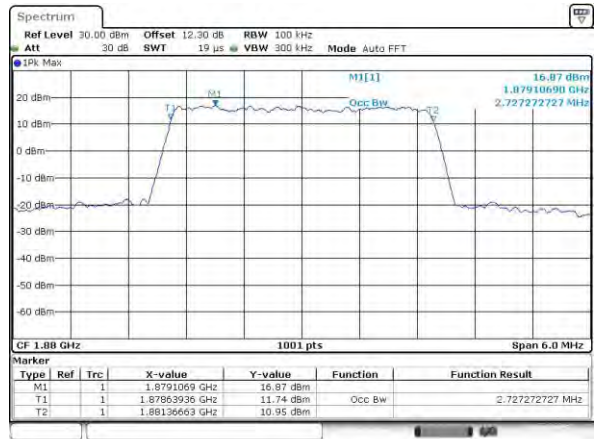

Date: 16.MAY.2015 09:17:07

Highest Channel / 3MHz / QPSK

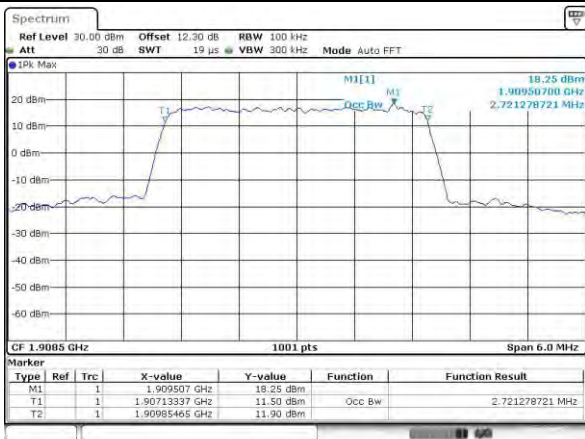

Date: 16.MAY.2015 09:20:15

Highest Channel / 3MHz / 16QAM

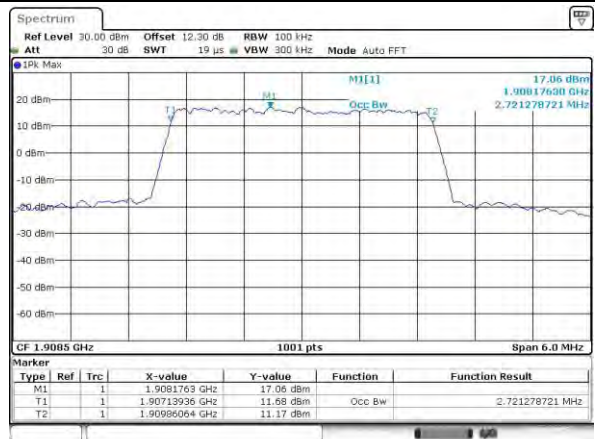

Date: 16.MAY.2015 09:20:27



LTE Band 2

Lowest Channel / 5MHz / QPSK

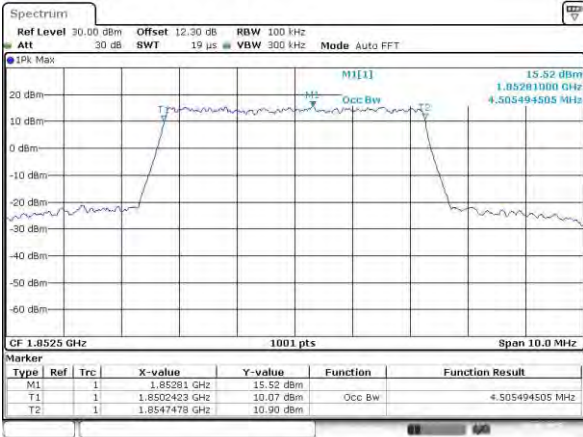

Date: 16.MAY.2015 09:28:16

Lowest Channel / 5MHz / 16QAM

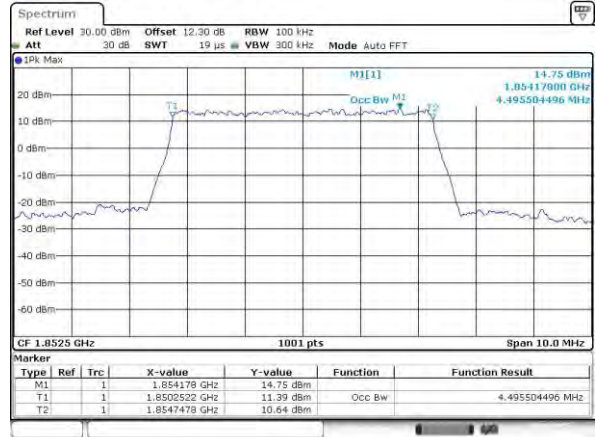

Date: 16.MAY.2015 09:28:29

Middle Channel / 5MHz / QPSK

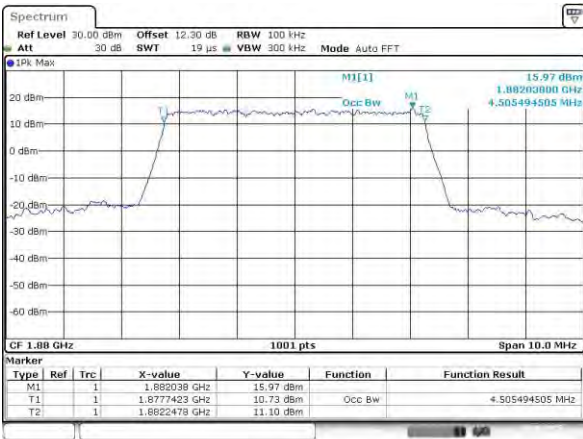

Date: 16.MAY.2015 09:28:17

Middle Channel / 5MHz / 16QAM

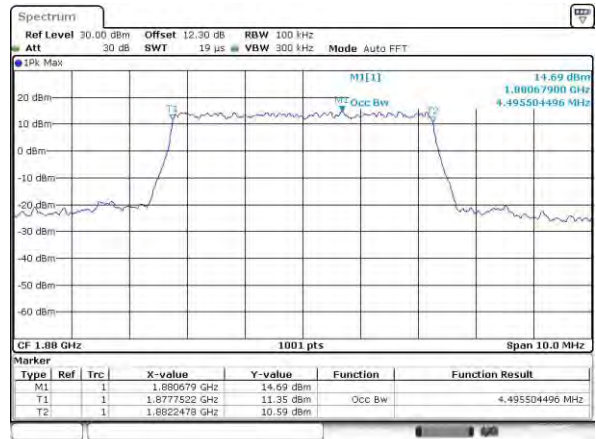

Date: 16.MAY.2015 09:28:29

Highest Channel / 5MHz / QPSK

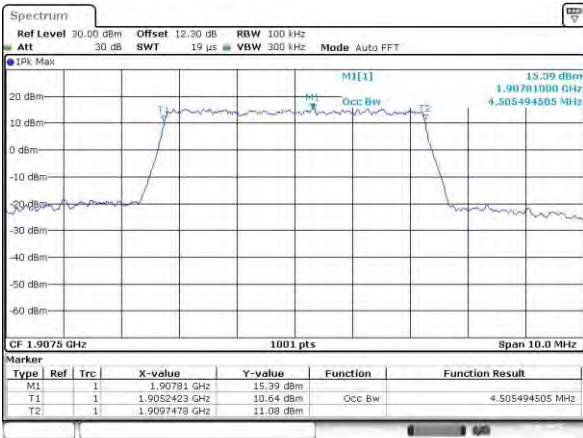

Date: 16.MAY.2015 09:29:36

Highest Channel / 5MHz / 16QAM

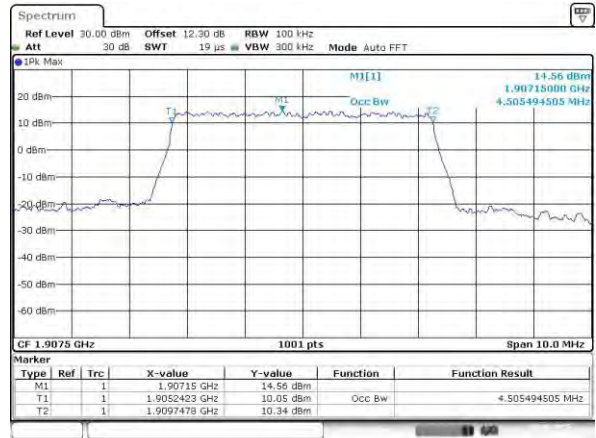

Date: 16.MAY.2015 09:29:48



LTE Band 2

Lowest Channel / 10MHz / QPSK

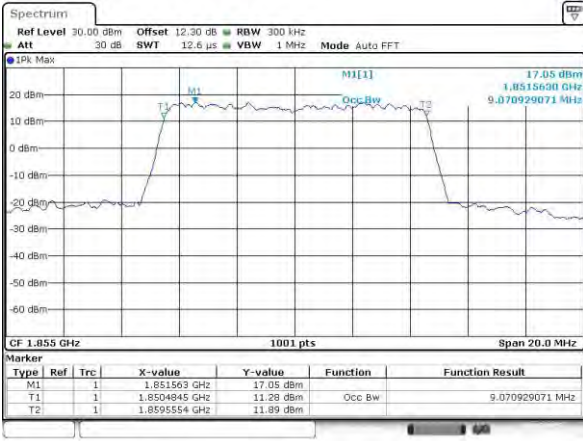

Date: 16.MAY.2015 09:47:36

Lowest Channel / 10MHz / 16QAM

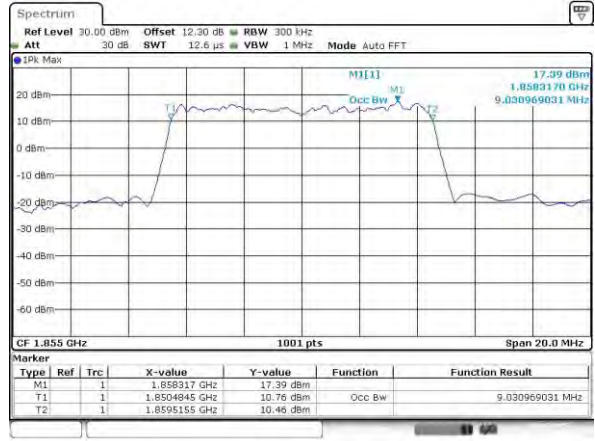

Date: 16.MAY.2015 09:47:48

Middle Channel / 10MHz / QPSK

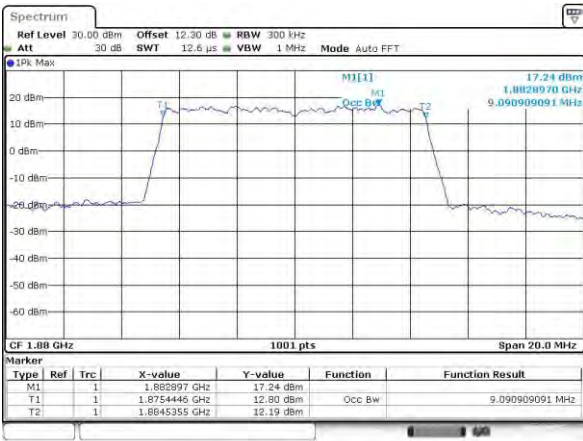

Date: 16.MAY.2015 09:55:34

Middle Channel / 10MHz / 16QAM

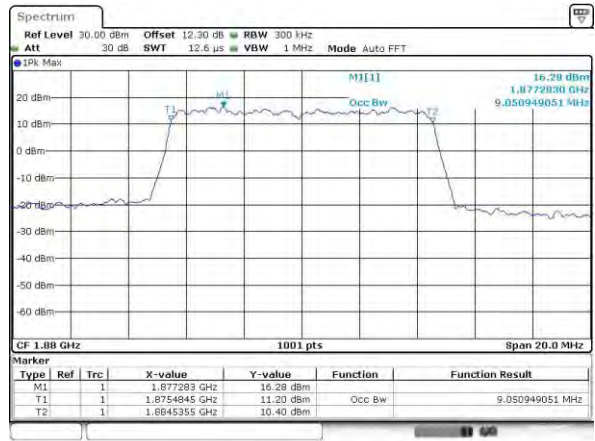

Date: 16.MAY.2015 09:55:48

Highest Channel / 10MHz / QPSK

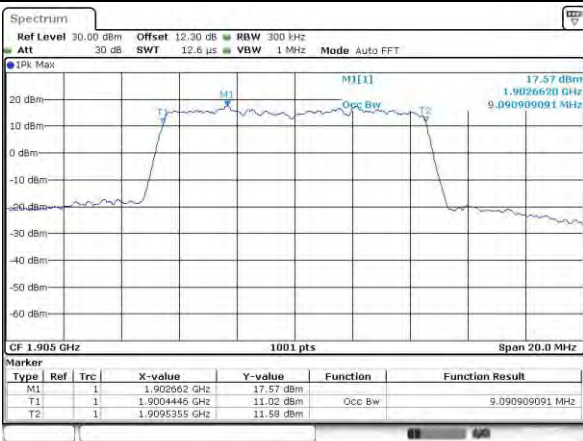

Date: 16.MAY.2015 09:58:54

Highest Channel / 10MHz / 16QAM

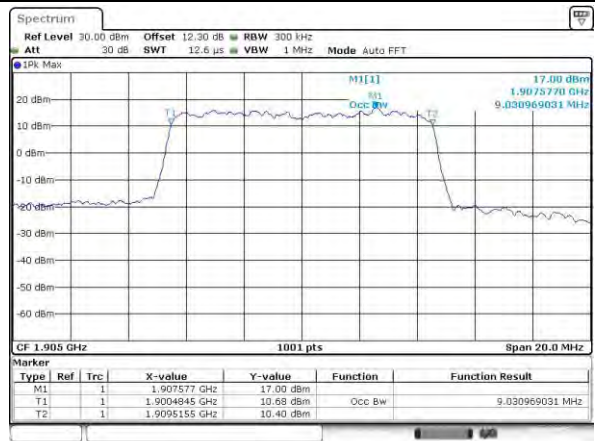

Date: 16.MAY.2015 09:59:05



LTE Band 2

Lowest Channel / 15MHz / QPSK

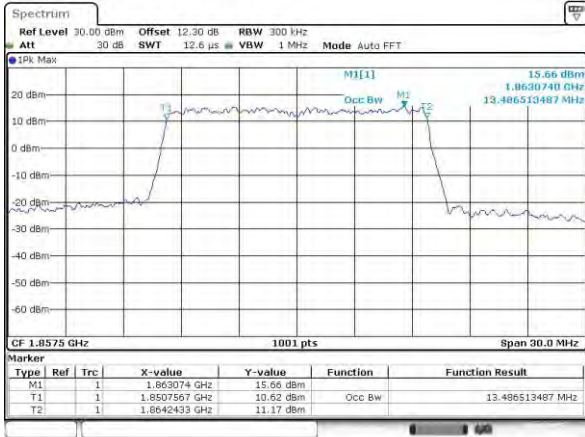

Lowest Channel / 15MHz / 16QAM

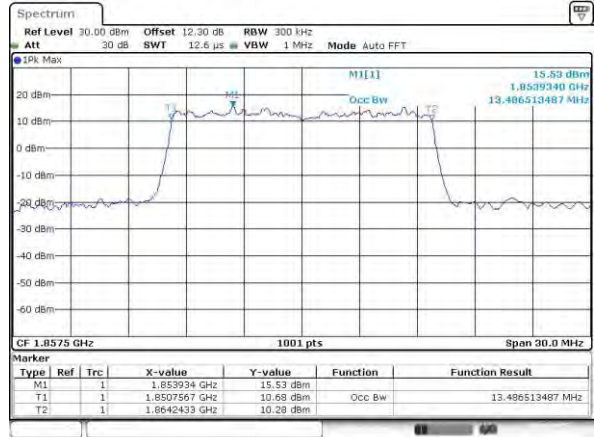

Middle Channel / 15MHz / QPSK

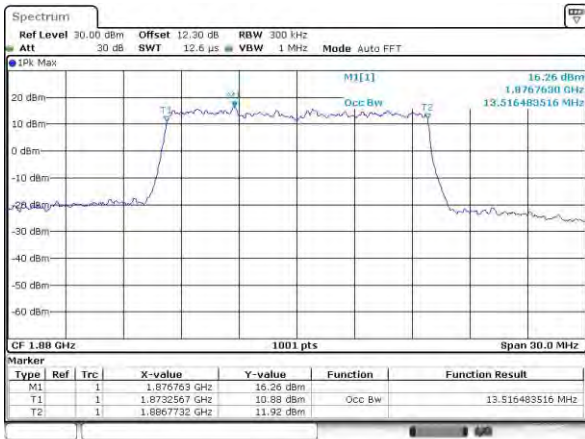

Middle Channel / 15MHz / 16QAM

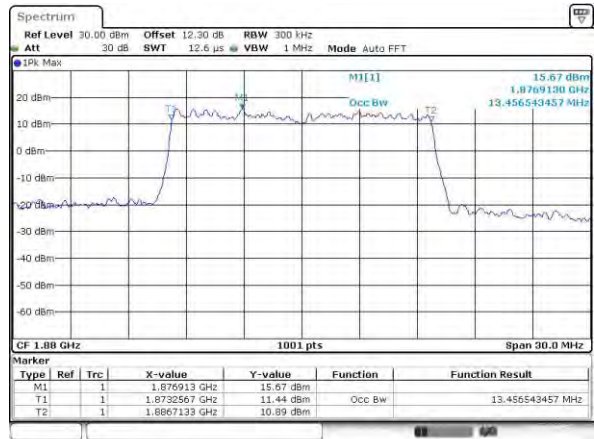

Highest Channel / 15MHz / QPSK

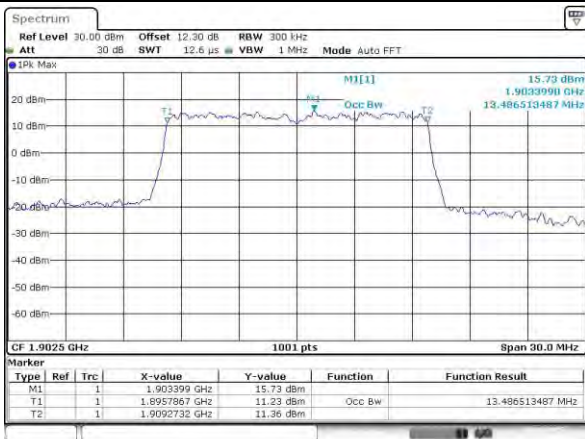

Highest Channel / 15MHz / 16QAM

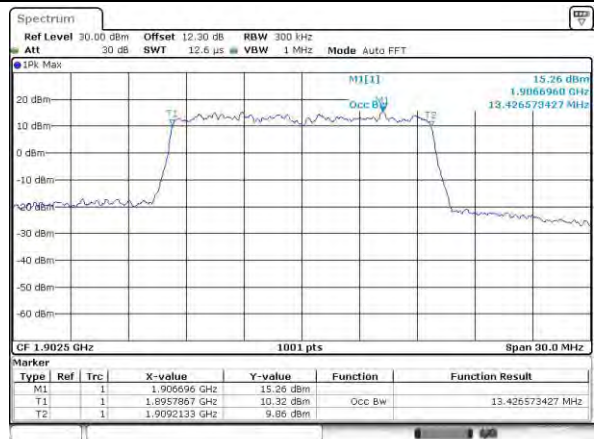



LTE Band 2

Lowest Channel / 20MHz / QPSK

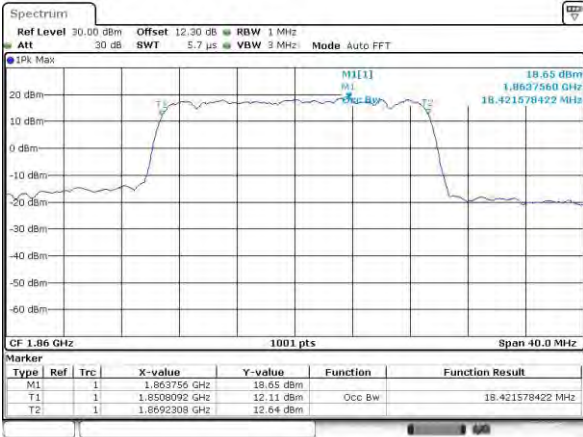

Date: 16.MAY.2015 09:26:09

Lowest Channel / 20MHz / 16QAM

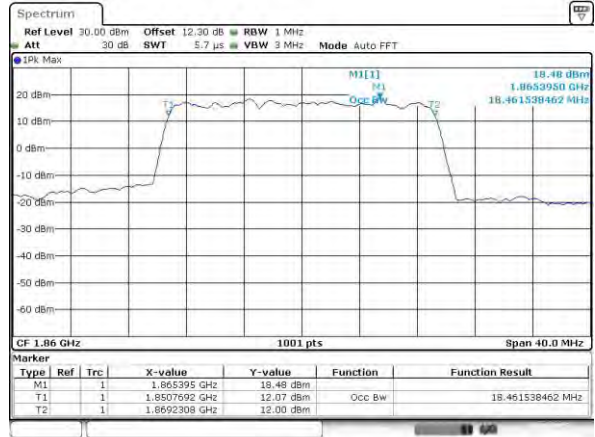

Date: 16.MAY.2015 09:26:20

Middle Channel / 20MHz / QPSK

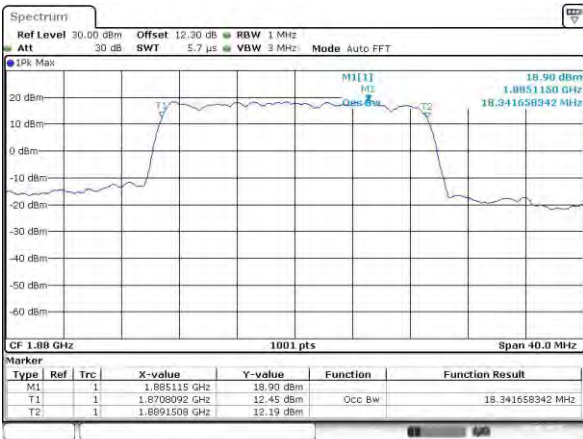

Date: 16.MAY.2015 09:34:07

Middle Channel / 20MHz / 16QAM

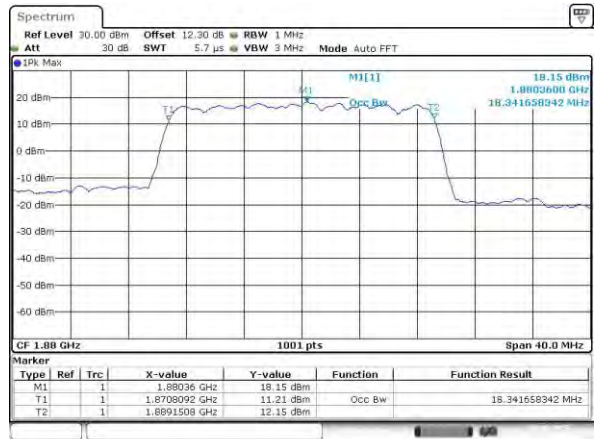

Date: 16.MAY.2015 09:34:19

Highest Channel / 20MHz / QPSK

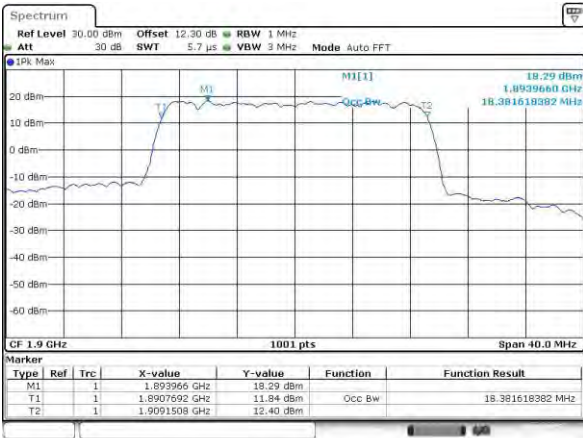

Date: 16.MAY.2015 09:37:26

Highest Channel / 20MHz / 16QAM

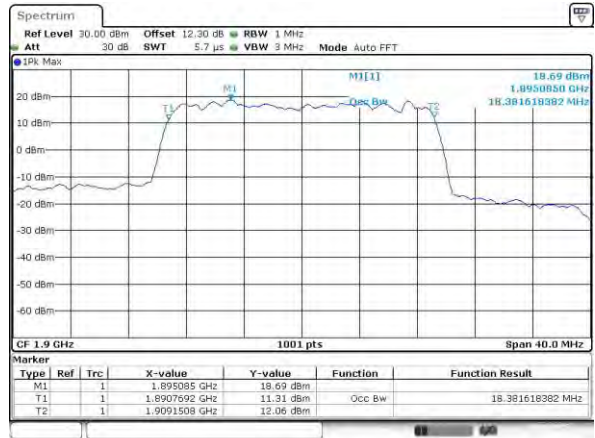

Date: 16.MAY.2015 09:37:39



Conducted Band Edge



LTE Band 2 / 1.4MHz / QPSK

Lowest Band Edge / 1RB

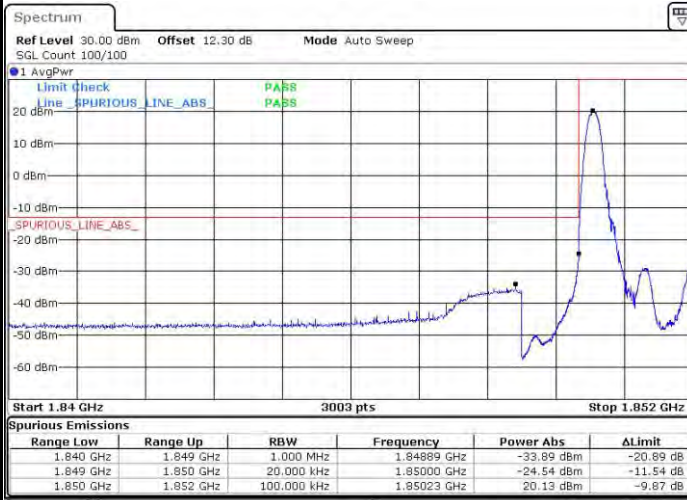

Date: 16.MAY.2015 09:47:14

Highest Band Edge / 1RB

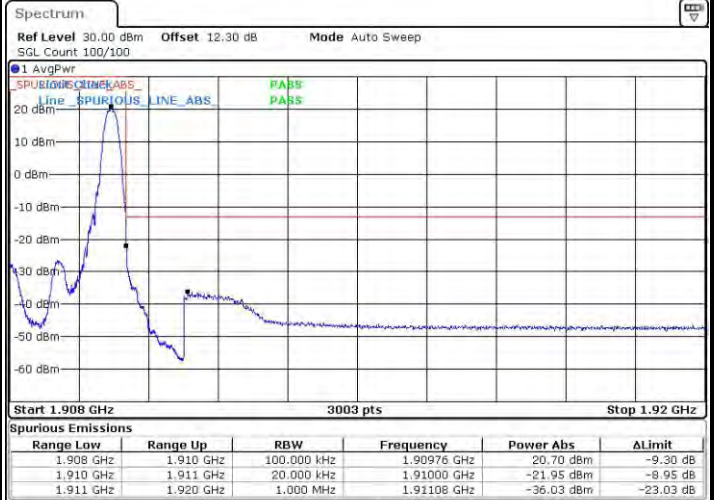

Date: 16.MAY.2015 09:58:32

Lowest Band Edge / Full RB

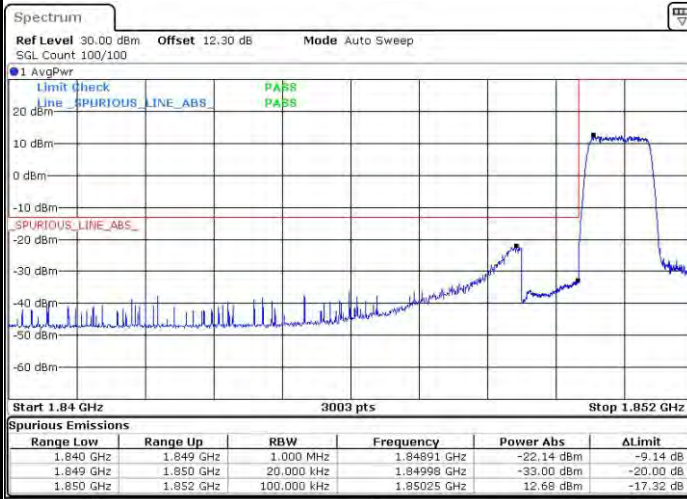

Date: 16.MAY.2015 10:10:24

Highest Band Edge / Full RB



Date: 16.MAY.2015 10:00:52



LTE Band 2 / 1.4MHz / 16QAM

Lowest Band Edge / 1 RB



Date: 16.MAY.2015 09:48:24

Highest Band Edge / 1 RB



Date: 16.MAY.2015 09:59:41

Lowest Band Edge / Full RB

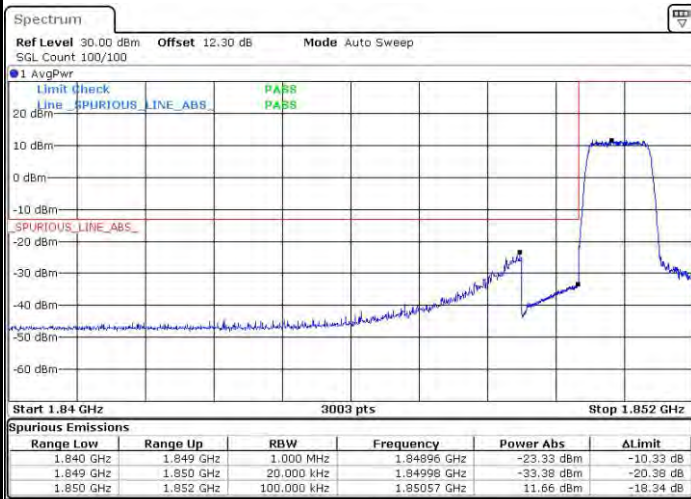

Date: 16.MAY.2015 09:50:44

Highest Band Edge / Full RB

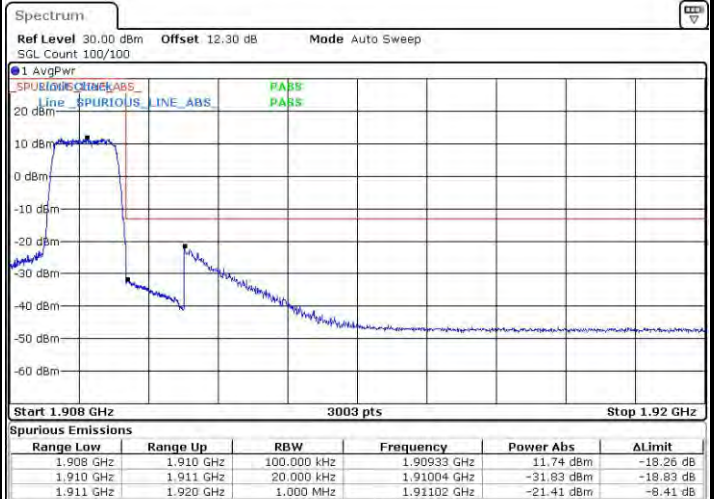

Date: 16.MAY.2015 10:02:02



LTE Band 2 / 3MHz / QPSK

Lowest Band Edge / 1RB

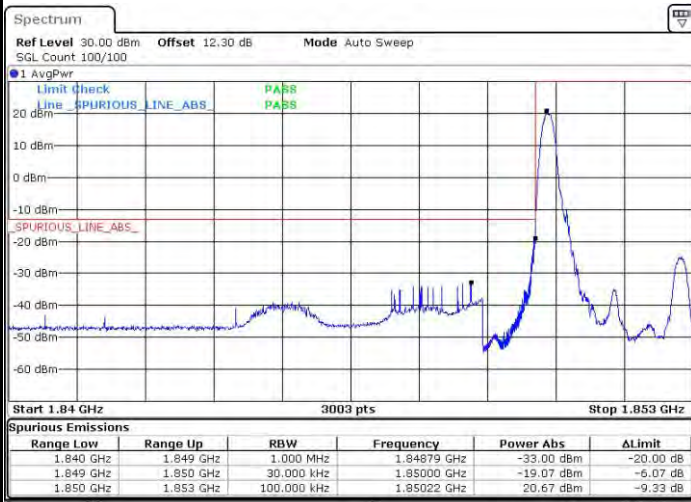

Date: 16.MAY.2015 08:10:43

Highest Band Edge / 1 RB

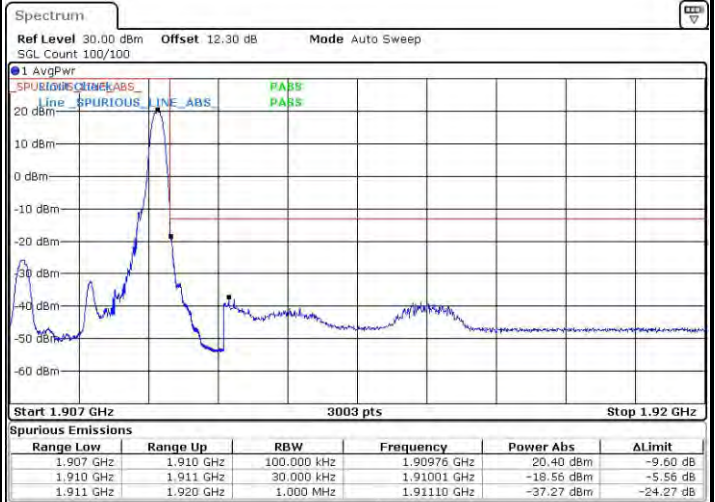

Date: 16.MAY.2015 08:22:05

Lowest Band Edge / Full RB

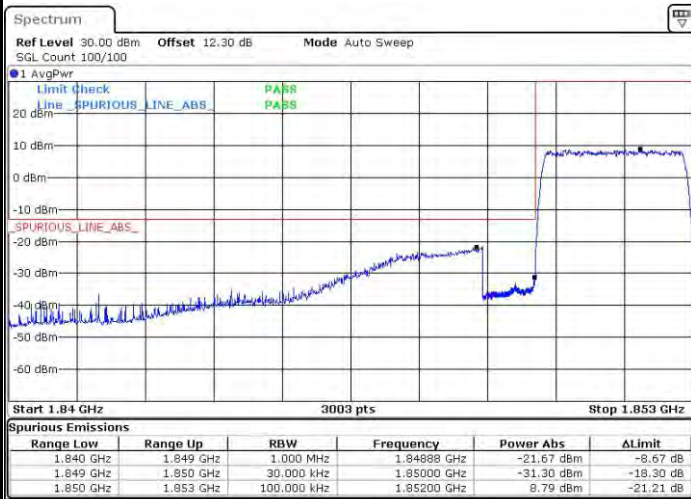

Date: 16.MAY.2015 08:13:04

Highest Band Edge / Full RB



Date: 16.MAY.2015 08:24:25



LTE Band 2 / 3MHz / 16QAM

Lowest Band Edge / 1 RB

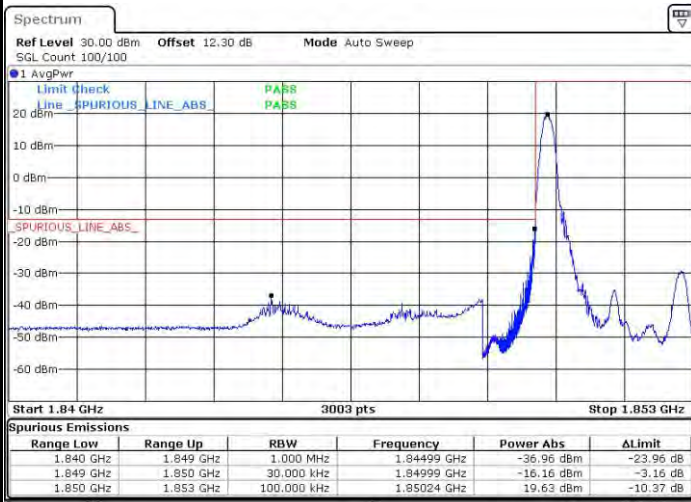

Date: 16.MAY.2015 08:11:53

Highest Band Edge / 1 RB

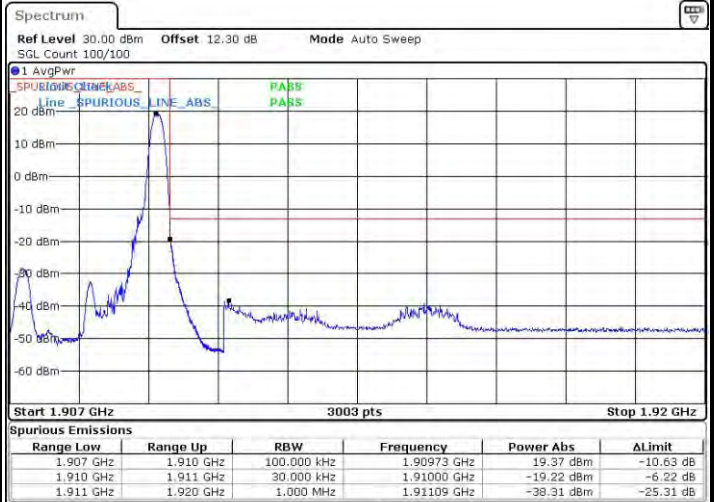

Date: 16.MAY.2015 08:23:15

Lowest Band Edge / Full RB

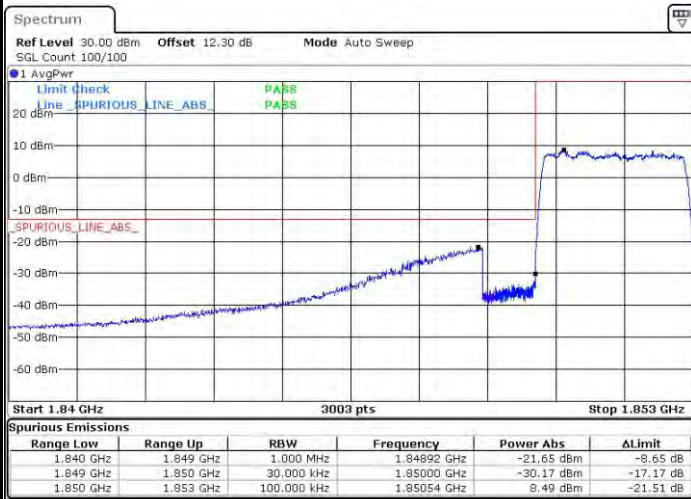

Date: 16.MAY.2015 08:14:15

Highest Band Edge / Full RB



Date: 16.MAY.2015 08:25:35



LTE Band 2 / 5MHz / QPSK

Lowest Band Edge / 1 RB

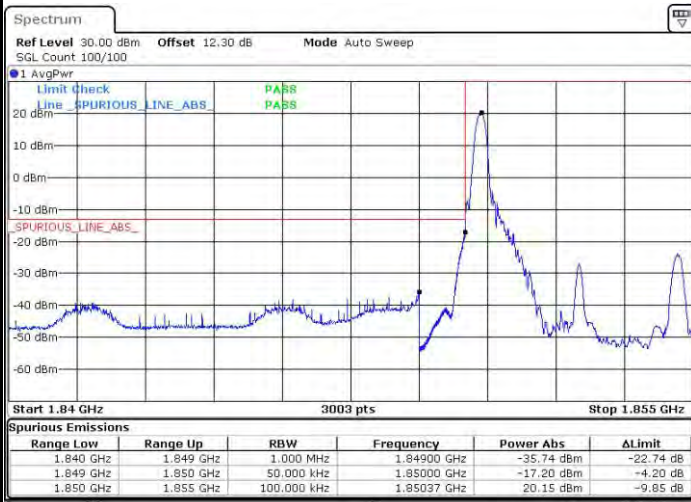

Date: 16.MAY.2015 08:30:05

Highest Band Edge / 1 RB

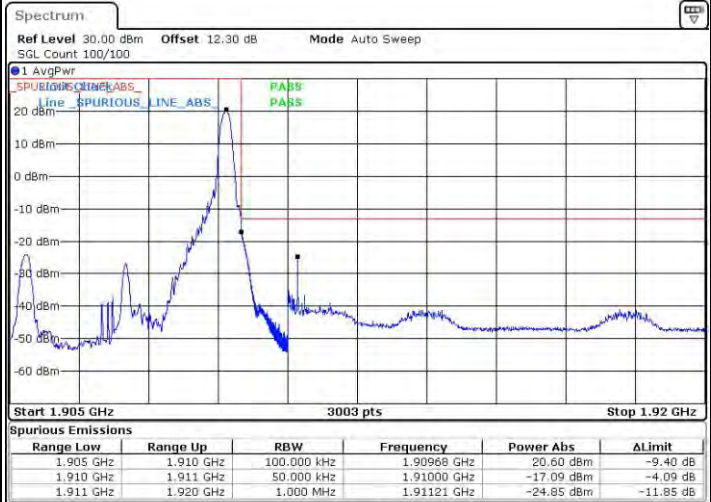

Date: 16.MAY.2015 08:41:26

Lowest Band Edge / Full RB



Date: 16.MAY.2015 08:32:26

Highest Band Edge / Full RB



Date: 16.MAY.2015 08:43:46



LTE Band 2 / 5MHz / 16QAM

Lowest Band Edge / 1RB

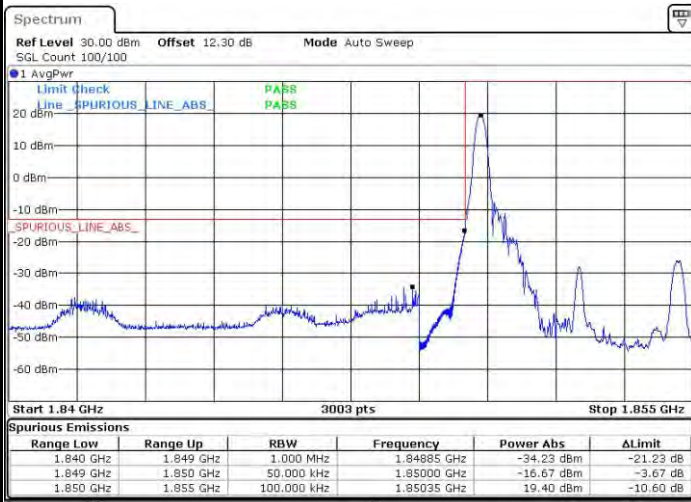

Date: 16.MAY.2015 08:31:16

Highest Band Edge / 1 RB



Date: 16.MAY.2015 08:42:36

Lowest Band Edge / Full RB

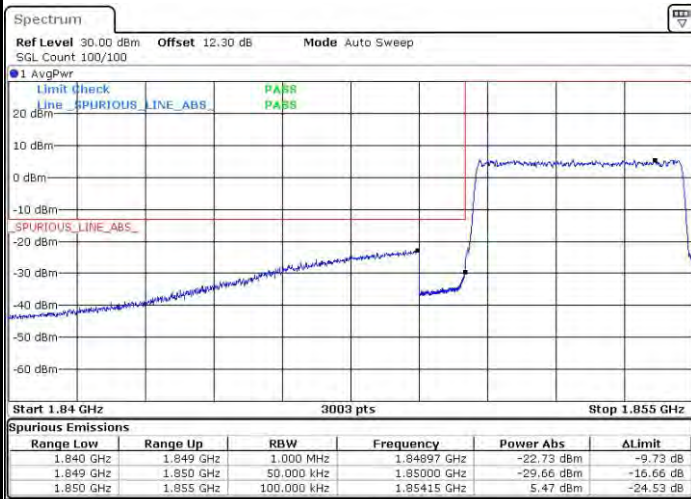

Date: 16.MAY.2015 08:33:36

Highest Band Edge / Full RB



Date: 16.MAY.2015 08:44:56



LTE Band 2 / 10MHz / QPSK

Lowest Band Edge / 1 RB

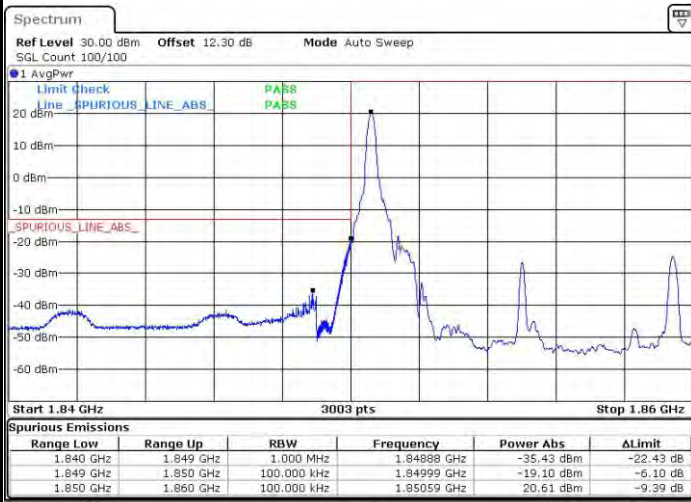

Date: 16.MAY.2015 08:49:25

Highest Band Edge / 1 RB

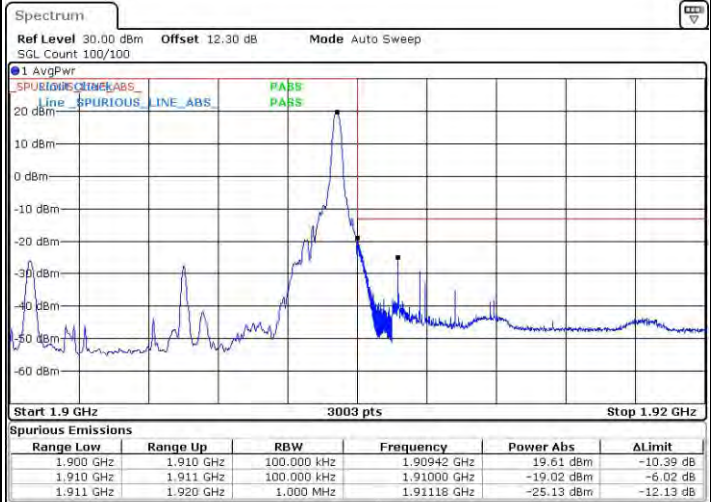

Date: 16.MAY.2015 09:00:42

Lowest Band Edge / Full RB

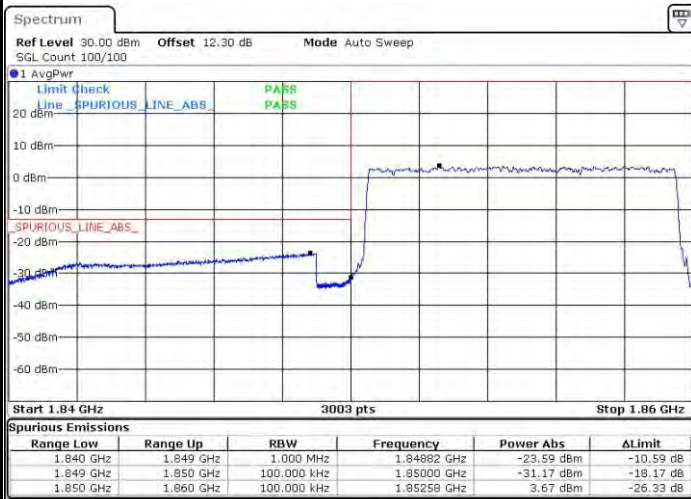

Date: 16.MAY.2015 08:51:45

Highest Band Edge / Full RB

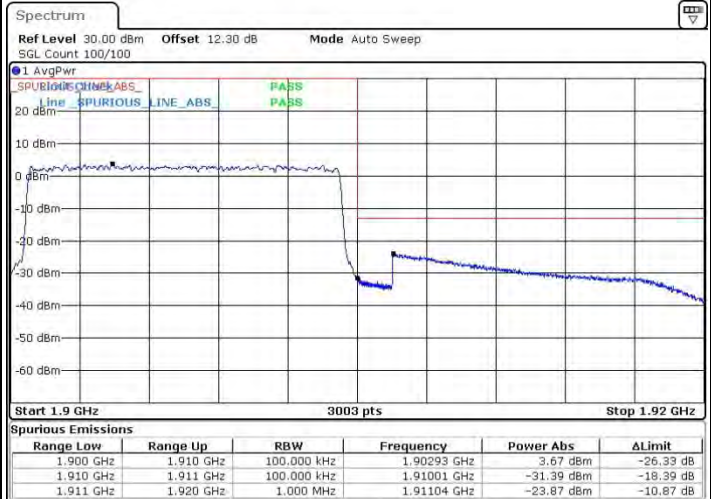

Date: 16.MAY.2015 09:03:02



LTE Band 2 / 10MHz / 16QAM

Lowest Band Edge / 1 RB

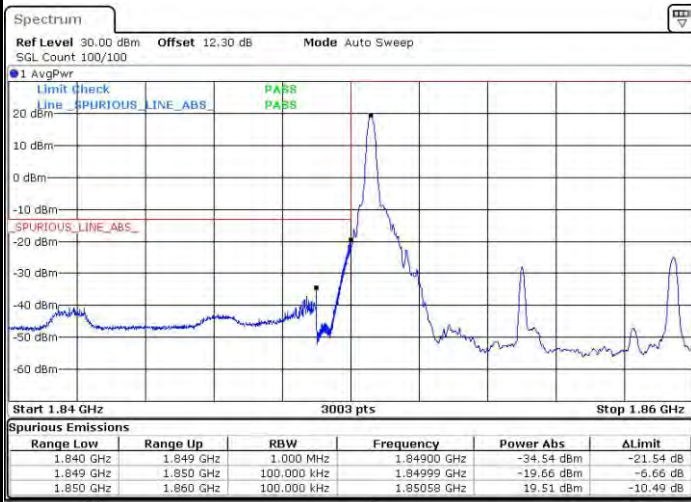

Date: 16.MAY.2015 08:50:35

Highest Band Edge / 1 RB

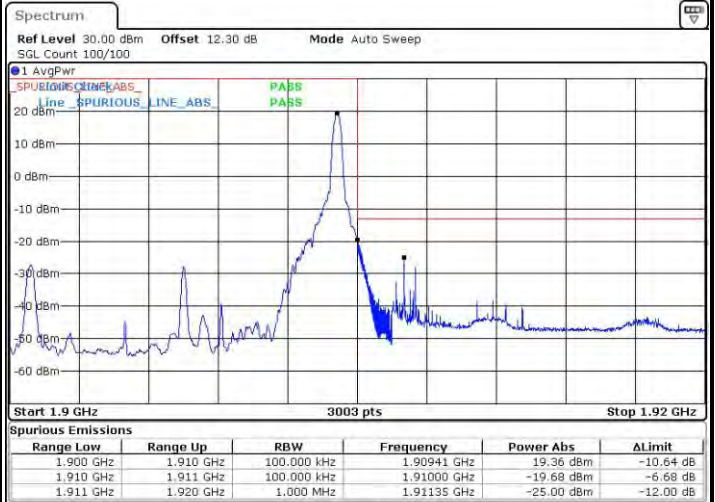

Date: 16.MAY.2015 09:01:52

Lowest Band Edge / Full RB

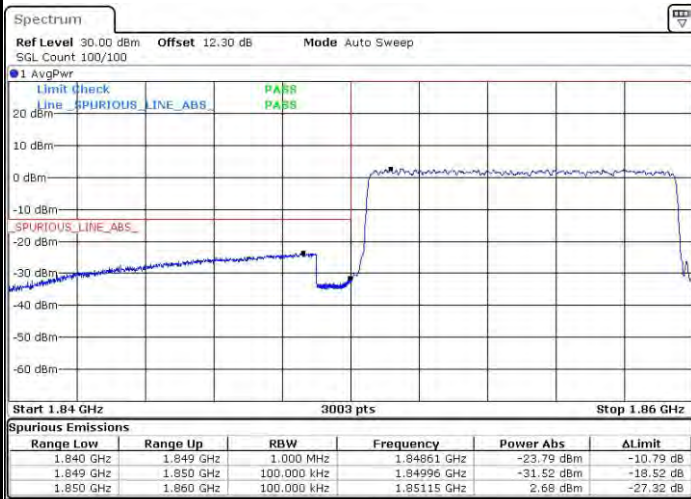

Date: 16.MAY.2015 08:52:55

Highest Band Edge / Full RB



Date: 16.MAY.2015 09:04:12



LTE Band 2 / 15MHz / QPSK

Lowest Band Edge / 1 RB

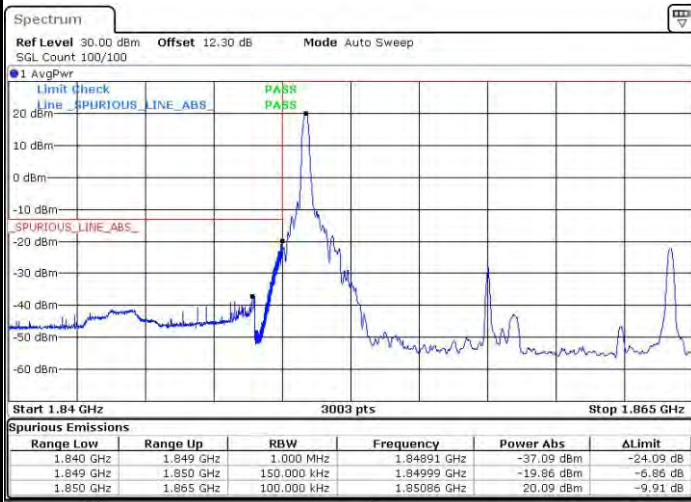

Date: 16.MAY.2015 09:08:41

Highest Band Edge / 1 RB

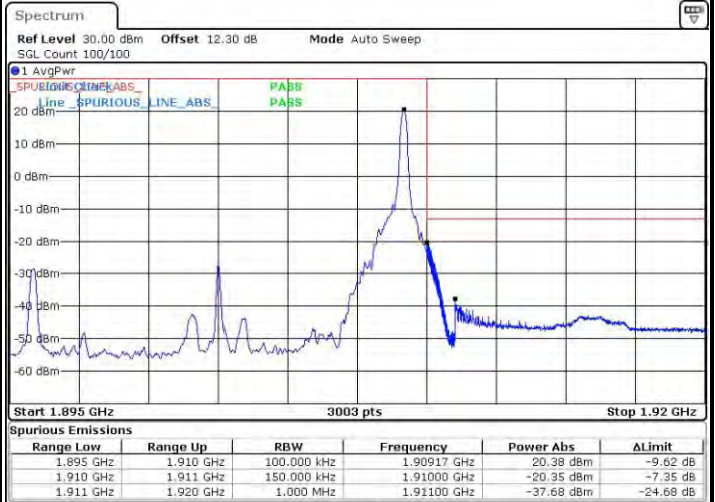

Date: 16.MAY.2015 09:19:59

Lowest Band Edge / Full RB

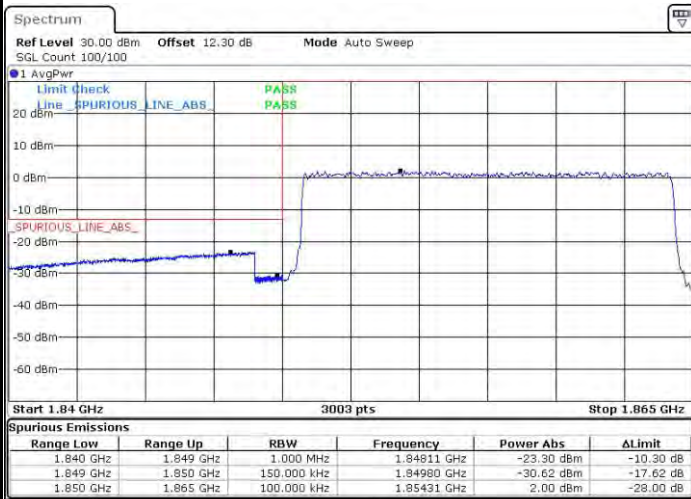

Date: 16.MAY.2015 09:11:01

Highest Band Edge / Full RB



Date: 16.MAY.2015 09:22:19



LTE Band 2 / 15MHz / 16QAM

Lowest Band Edge / 1 RB

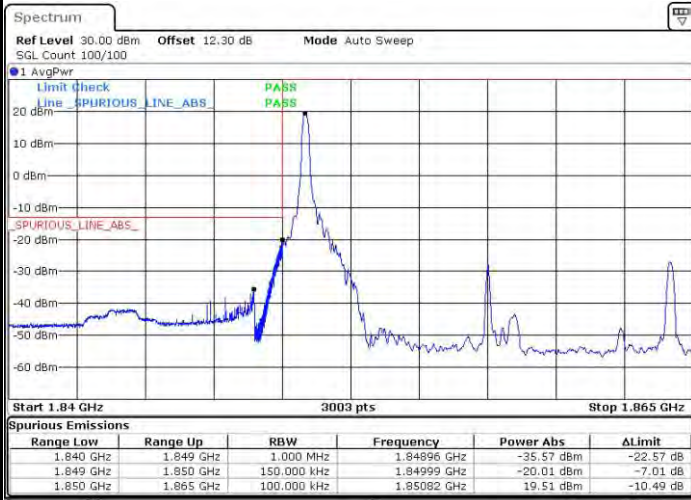

Date: 16.MAY.2015 09:09:51

Highest Band Edge / 1 RB

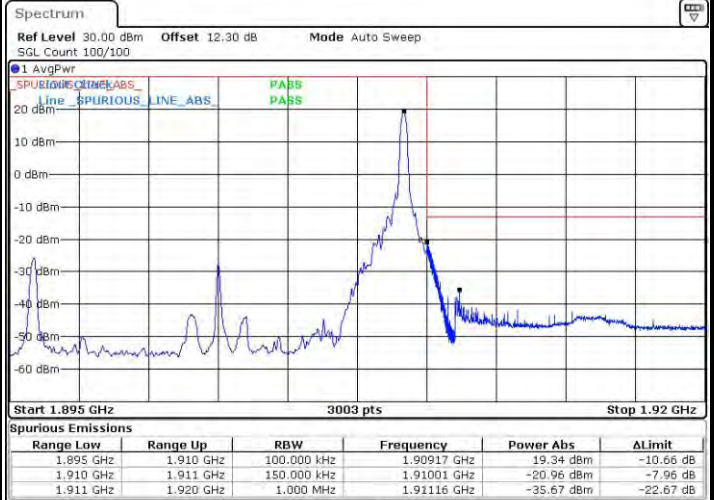

Date: 16.MAY.2015 09:21:09

Lowest Band Edge / Full RB

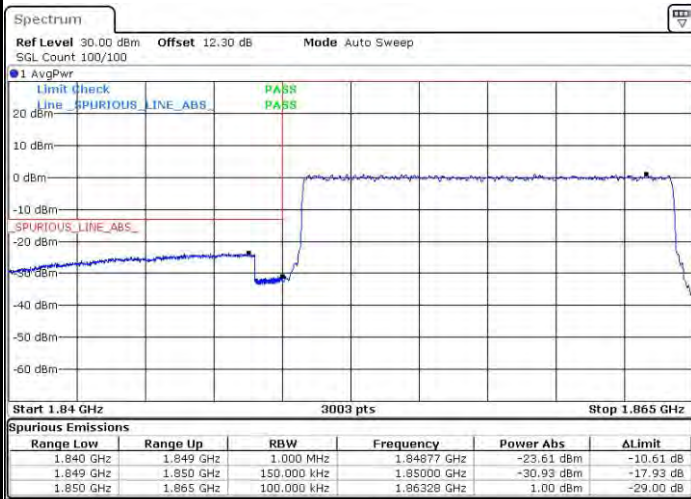

Date: 16.MAY.2015 09:12:11

Highest Band Edge / Full RB



Date: 16.MAY.2015 09:23:29



LTE Band 2 / 20MHz / QPSK

Lowest Band Edge / 1 RB

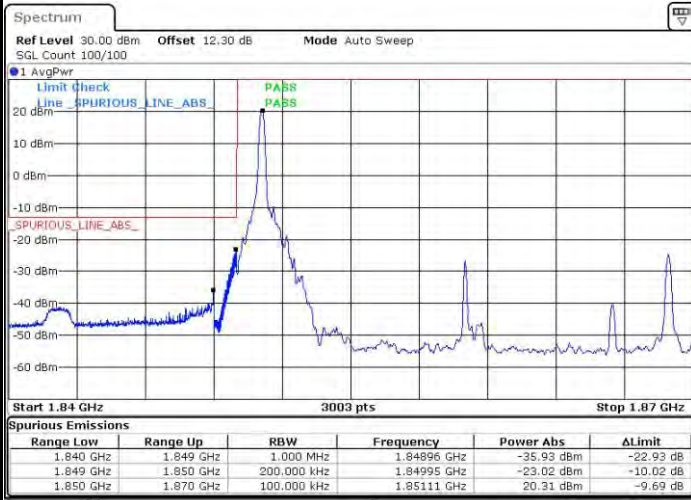

Date: 16.MAY.2015 09:27:58

Highest Band Edge / 1 RB

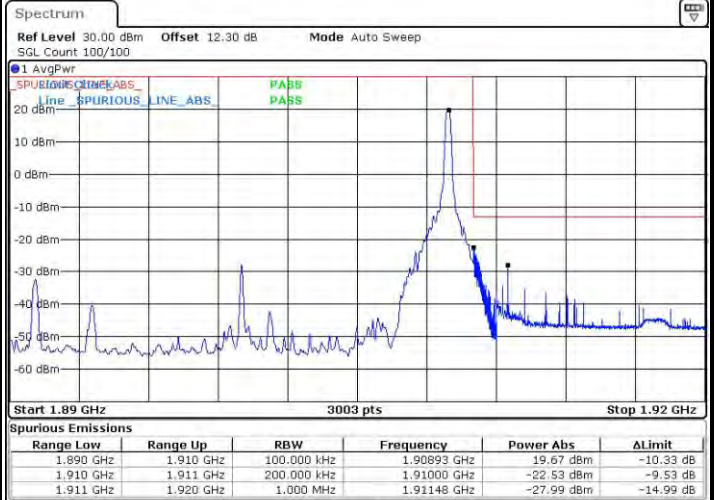

Date: 16.MAY.2015 09:39:15

Lowest Band Edge / Full RB

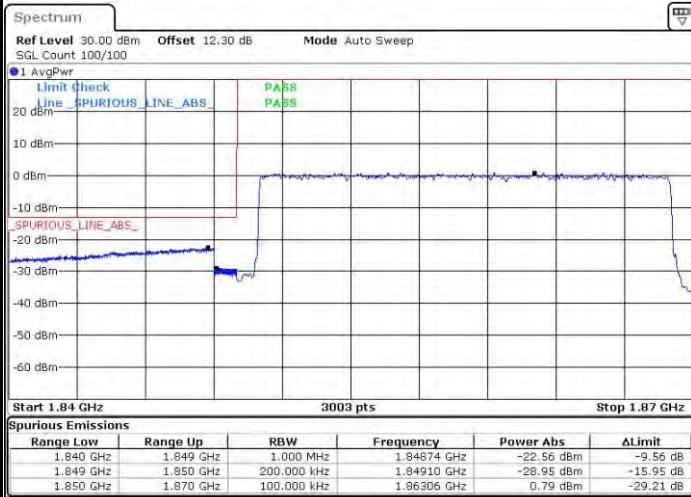

Date: 16.MAY.2015 09:30:18

Highest Band Edge / Full RB



Date: 16.MAY.2015 09:41:35



LTE Band 2 / 20MHz / 16QAM

Lowest Band Edge / 1 RB

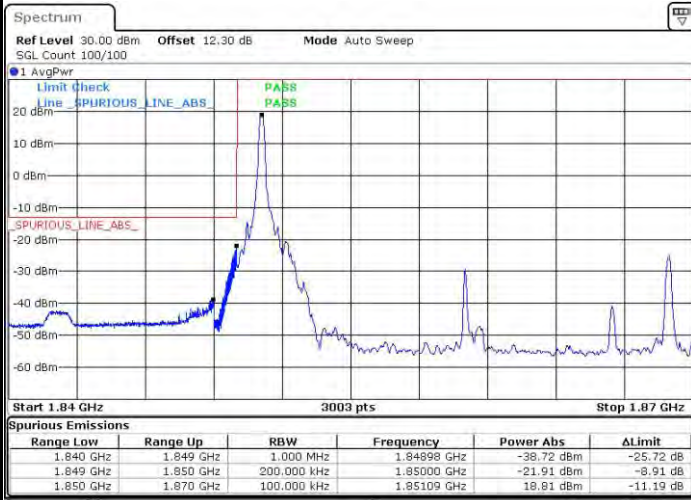

Date: 16.MAY.2015 09:29:08

Highest Band Edge / 1 RB

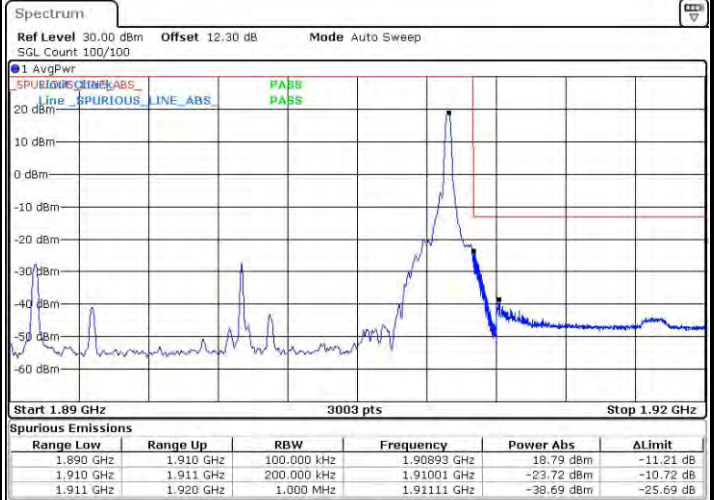

Date: 16.MAY.2015 09:40:25

Lowest Band Edge / Full RB

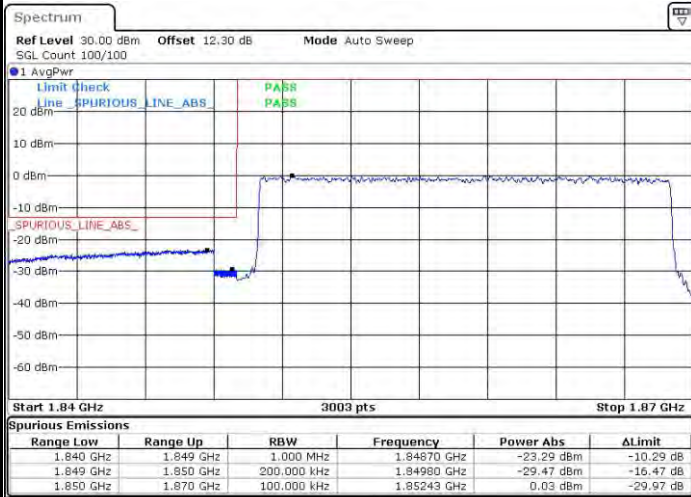

Date: 16.MAY.2015 09:31:27

Highest Band Edge / Full RB

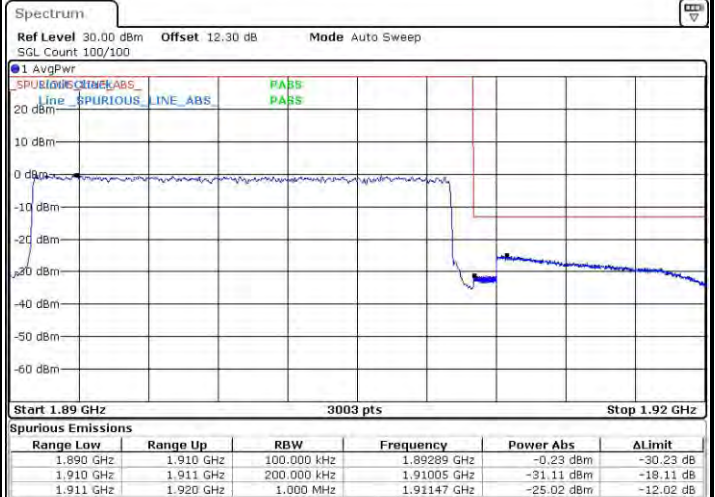

Date: 16.MAY.2015 09:42:45



Conducted Spurious Emission



LTE Band 2 / 1.4MHz

Lowest Channel / QPSK

Lowest Channel / 16QAM

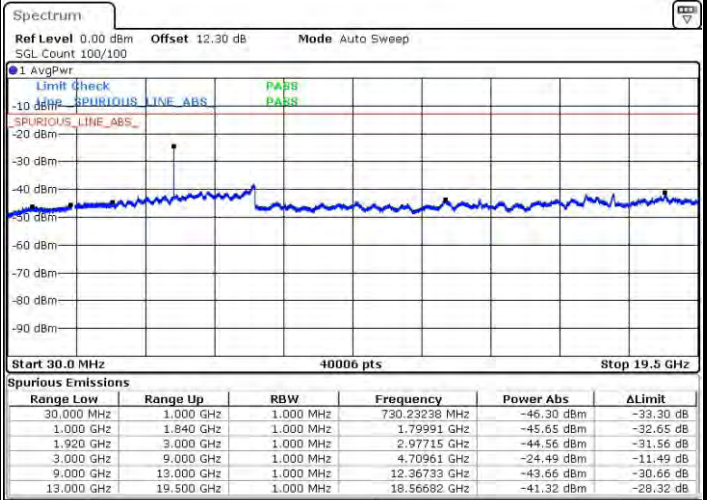
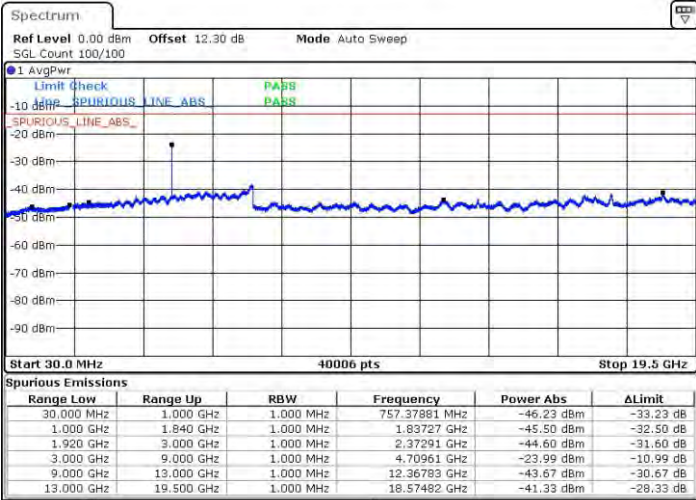

Date: 16.MAY.2015 09:51:57

Date: 16.MAY.2015 09:53:10

Middle Channel / QPSK

Middle Channel / 16QAM

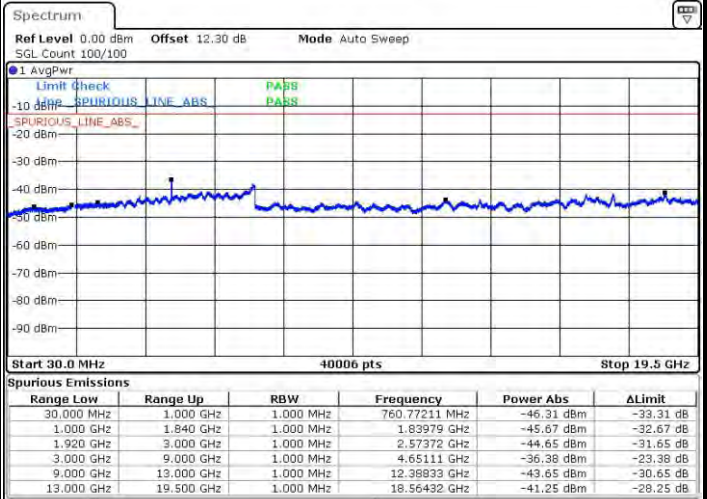
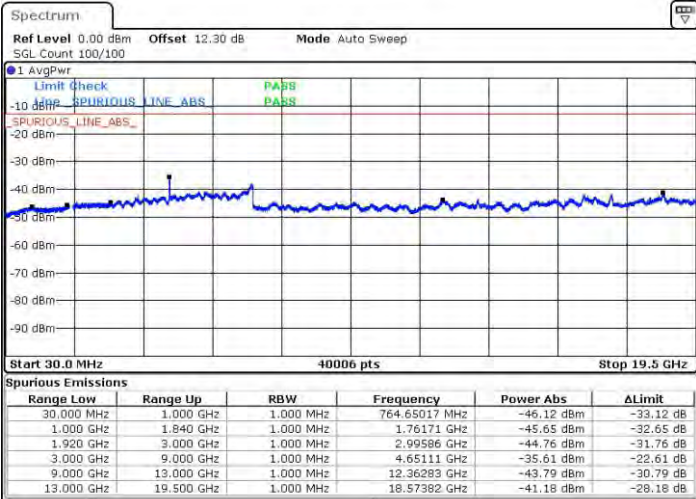

Date: 16.MAY.2015 09:55:16

Date: 16.MAY.2015 09:56:29



LTE Band 2 / 1.4MHz

Highest Channel / QPSK

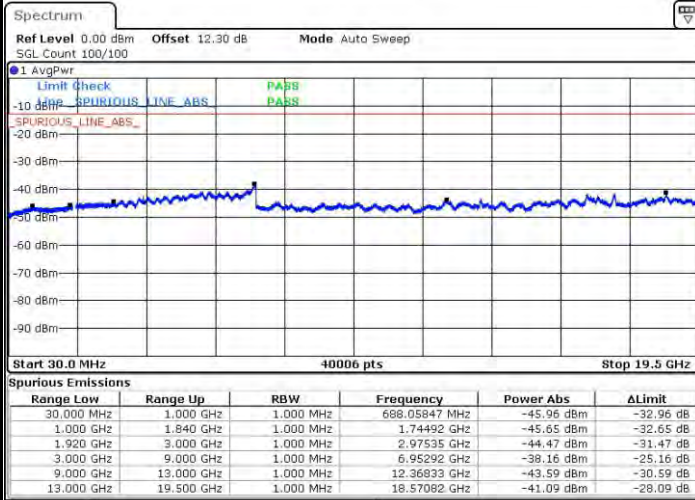

Date: 16.MAY.2015 10:03:15

Highest Channel / 16QAM

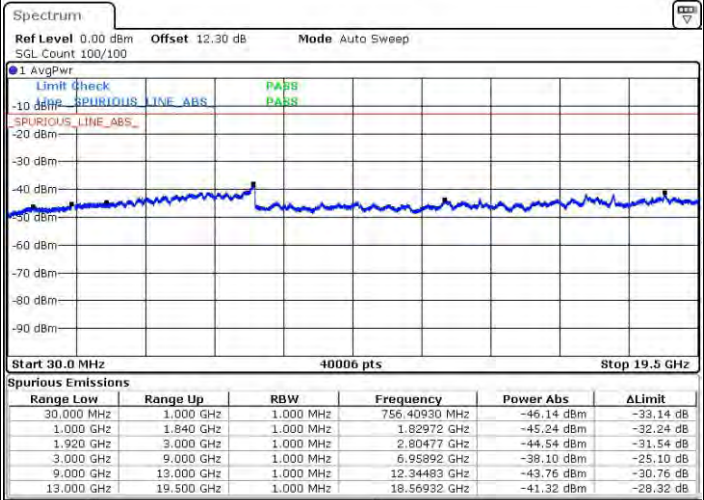

Date: 16.MAY.2015 10:04:28

LTE Band 2 / 3MHz

Lowest Channel / QPSK

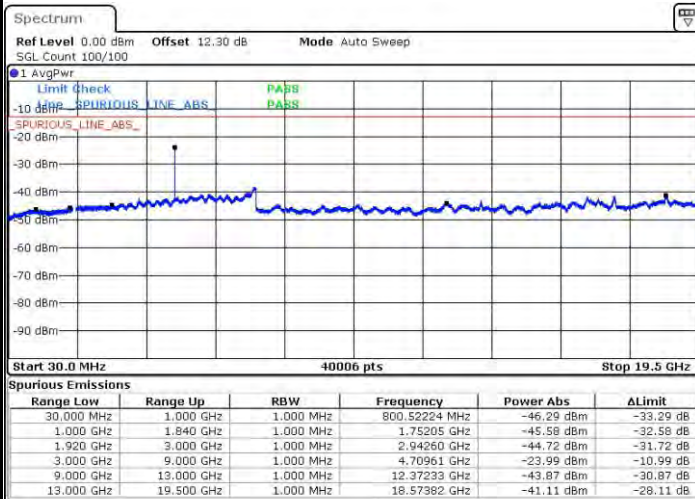

Date: 16.MAY.2015 08:15:28

Lowest Channel / 16QAM

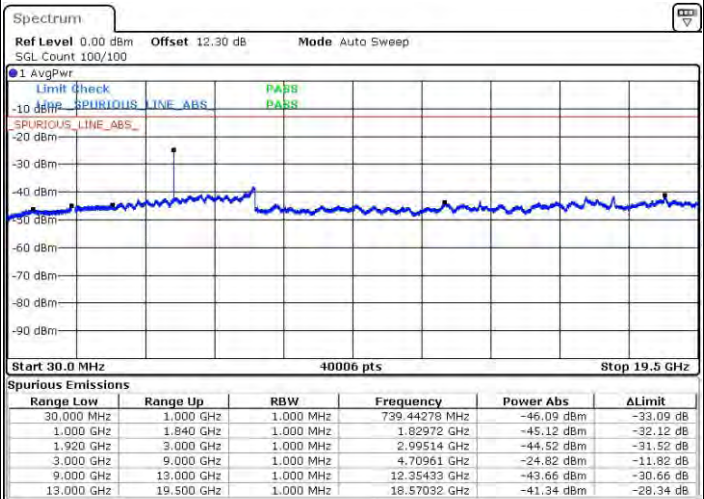

Date: 16.MAY.2015 08:16:42



LTE Band 2 / 3MHz

Middle Channel / QPSK

Middle Channel / 16QAM

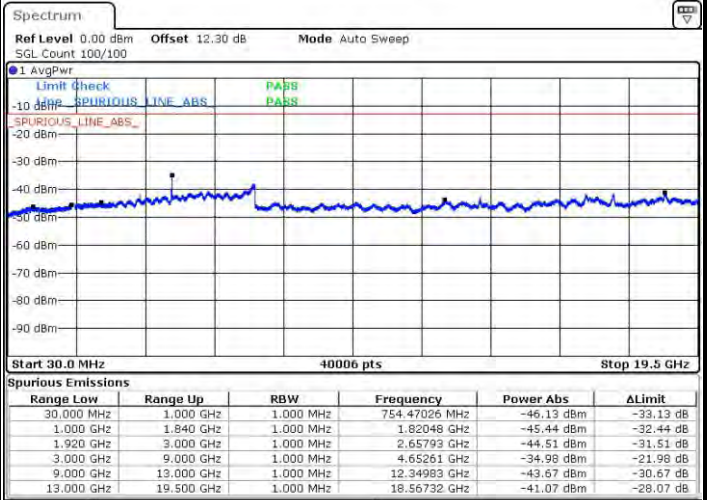
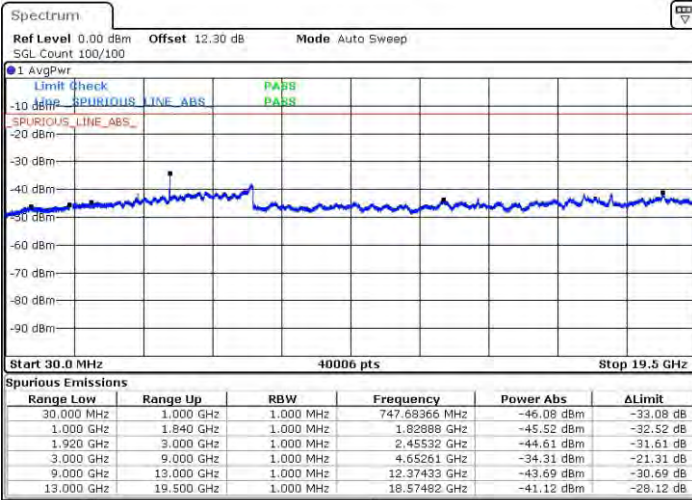

Date: 16.MAY.2015 08:18:48

Date: 16.MAY.2015 08:20:02

Highest Channel / QPSK

Highest Channel / 16QAM

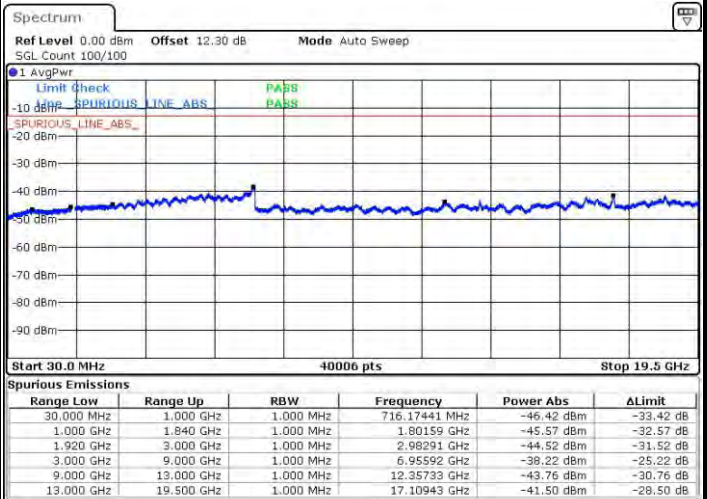
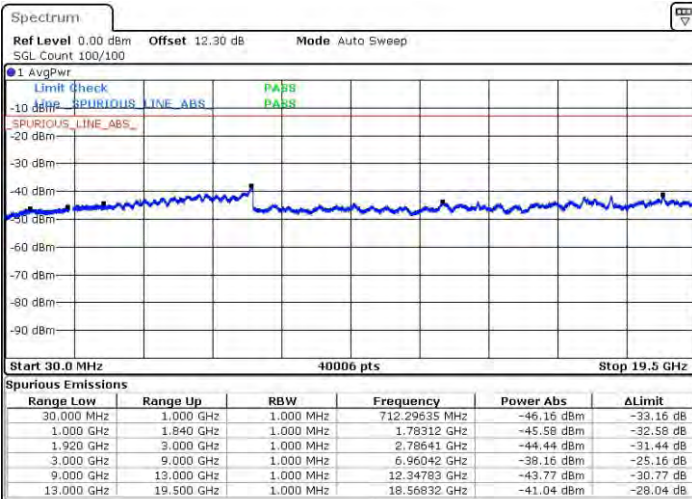

Date: 16.MAY.2015 08:26:49

Date: 16.MAY.2015 08:28:03



LTE Band 2 / 5MHz

Lowest Channel / QPSK

Lowest Channel / 16QAM

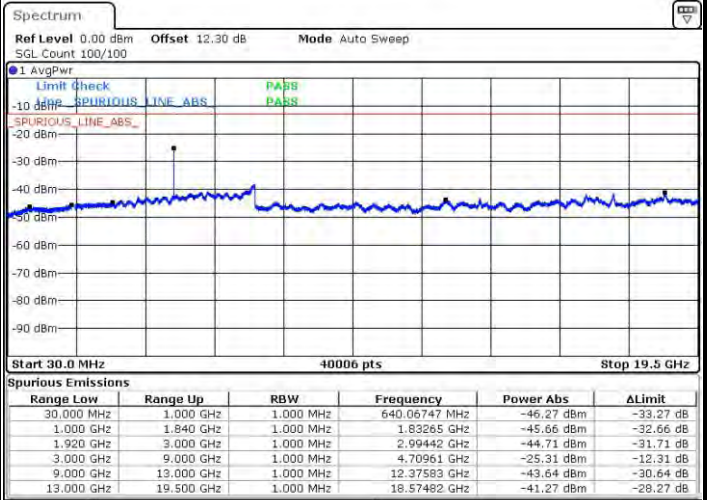
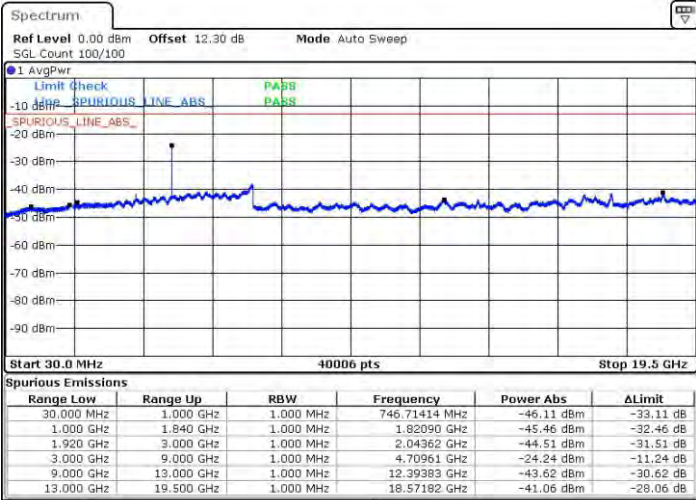

Date: 16.MAY.2015 08:34:49

Date: 16.MAY.2015 08:36:03

Middle Channel / QPSK

Middle Channel / 16QAM

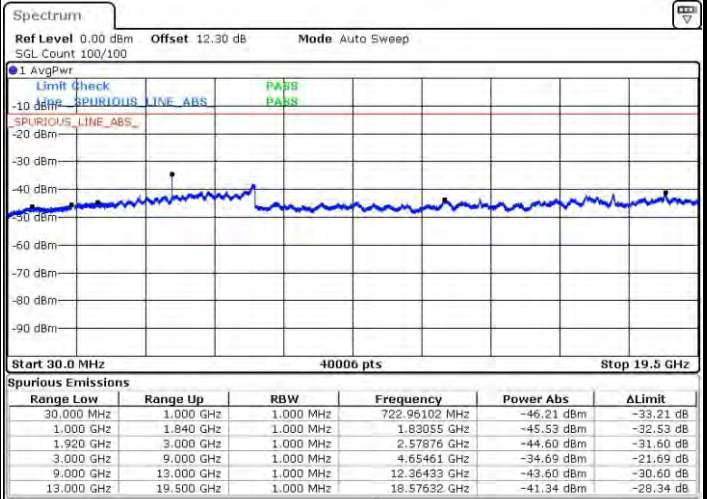
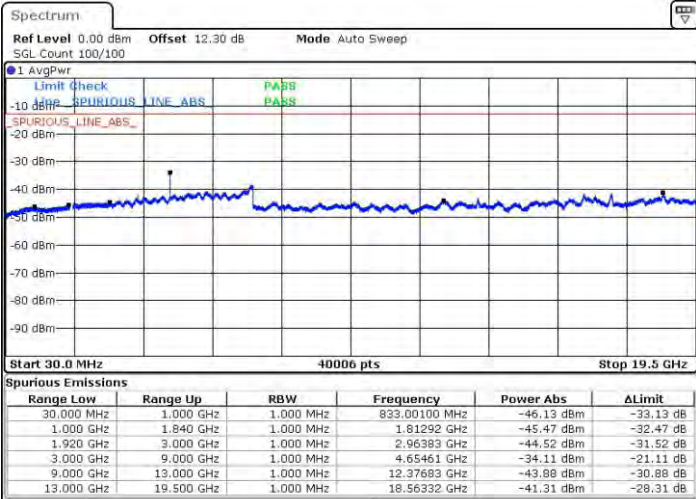

Date: 16.MAY.2015 08:38:09

Date: 16.MAY.2015 08:39:23



LTE Band 2 / 5MHz

Highest Channel / QPSK

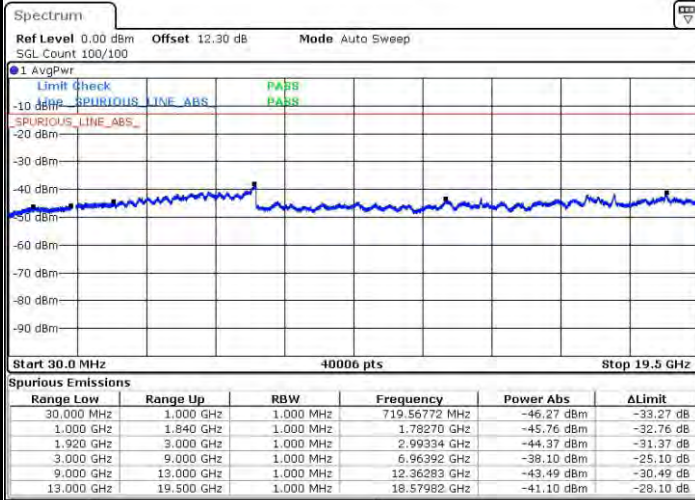

Date: 16.MAY.2015 08:46:09

Highest Channel / 16QAM

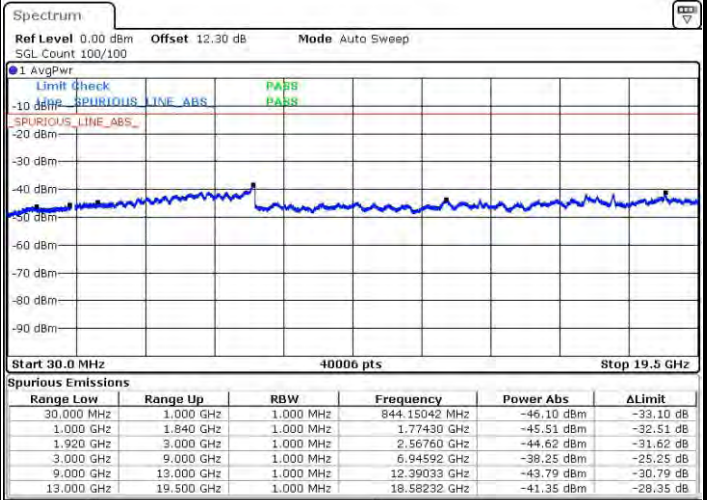

Date: 16.MAY.2015 08:47:23

LTE Band 2 / 10MHz

Lowest Channel / QPSK

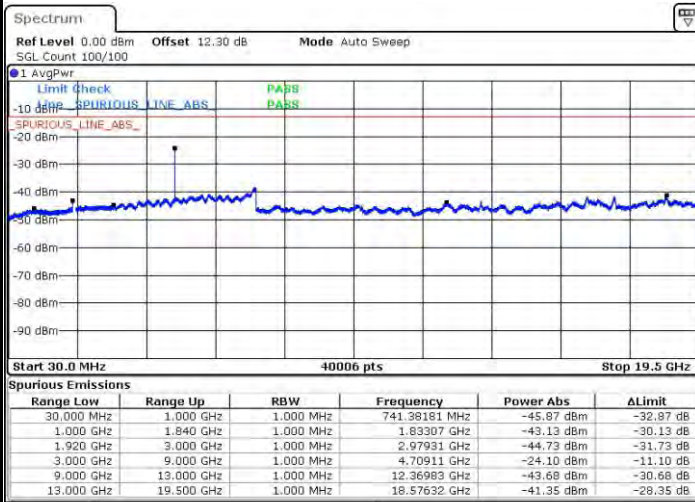

Date: 16.MAY.2015 08:54:08

Lowest Channel / 16QAM

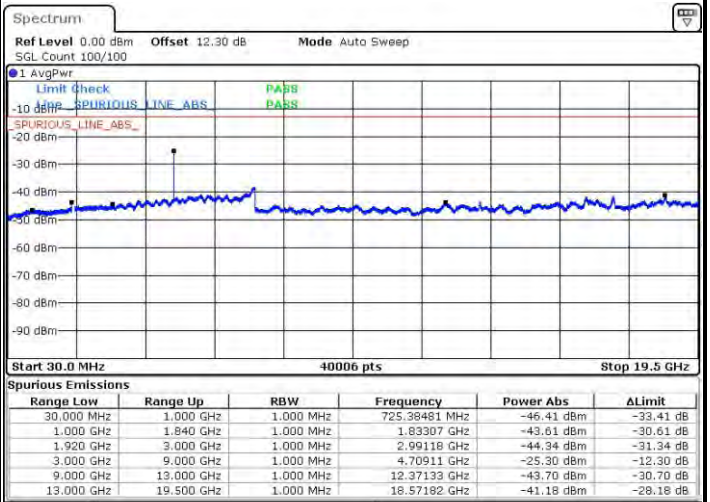

Date: 16.MAY.2015 08:55:22



LTE Band 2 / 10MHz

Middle Channel / QPSK

Middle Channel / 16QAM

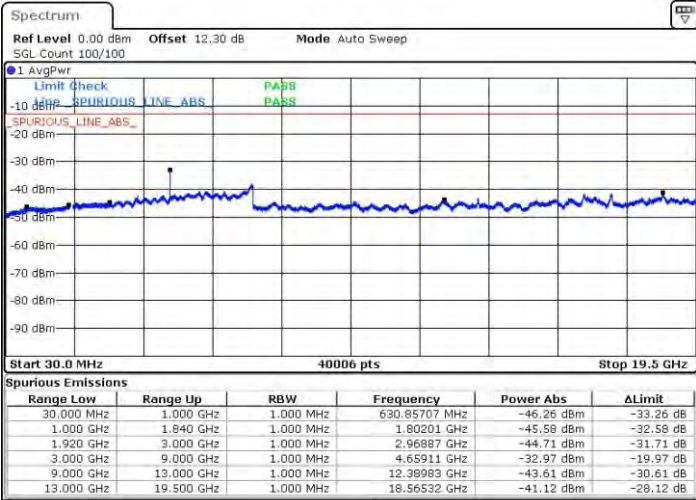

Date: 16.MAY.2015 08:57:26

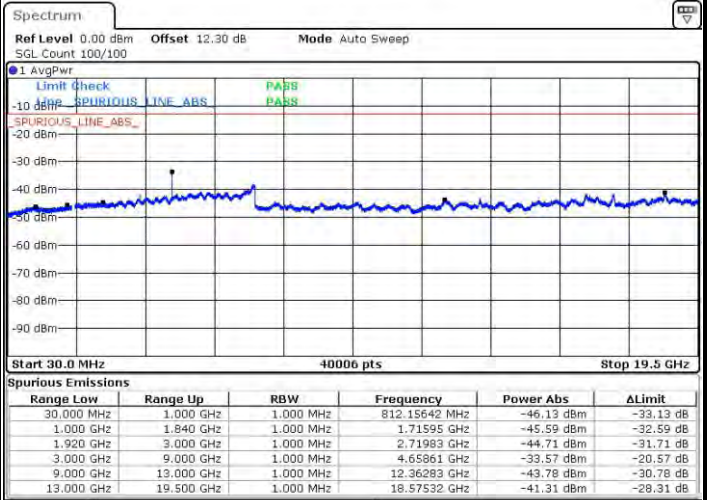

Date: 16.MAY.2015 08:58:40

Highest Channel / QPSK

Highest Channel / 16QAM

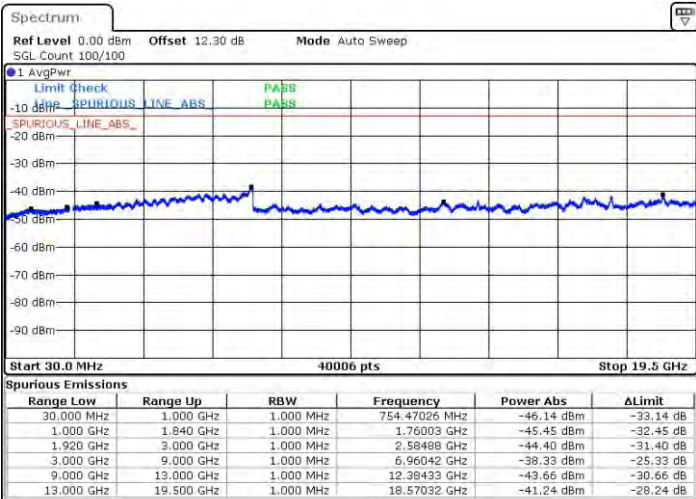

Date: 16.MAY.2015 09:05:25

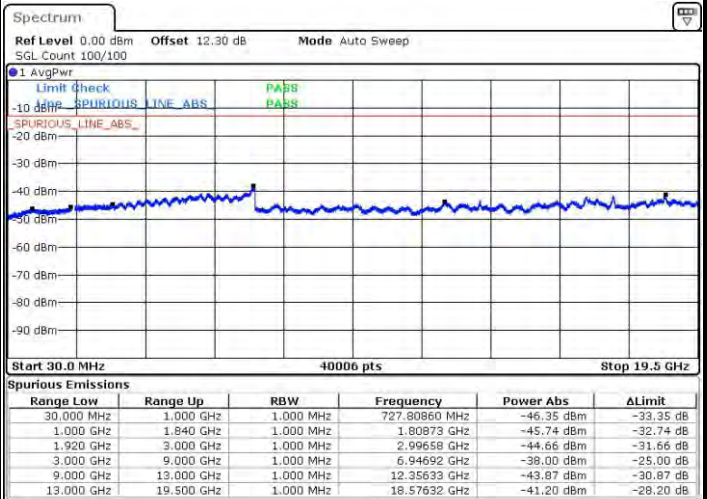

Date: 16.MAY.2015 09:06:39



LTE Band 2 / 15MHz

Lowest Channel / QPSK

Lowest Channel / 16QAM

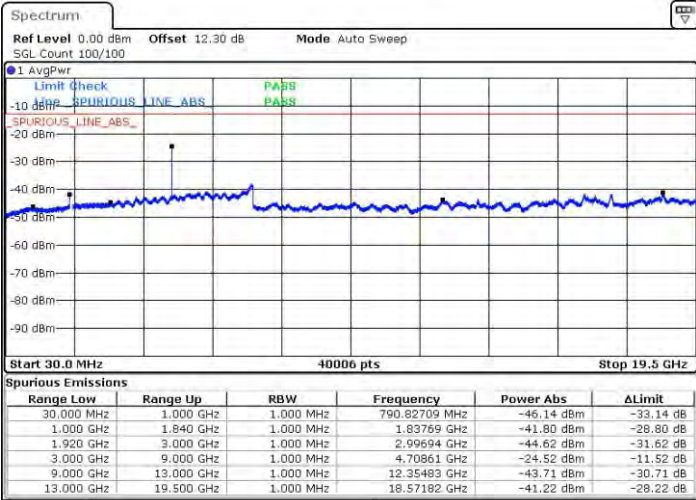

Date: 16.MAY.2015 09:13:24

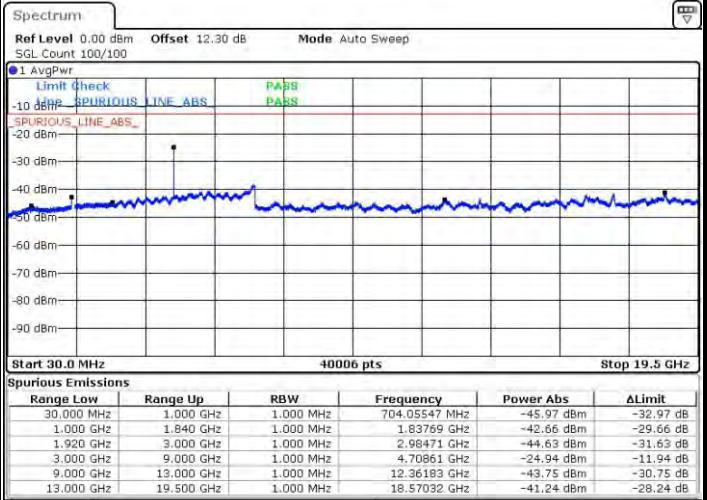

Date: 16.MAY.2015 09:14:38

Middle Channel / QPSK

Middle Channel / 16QAM

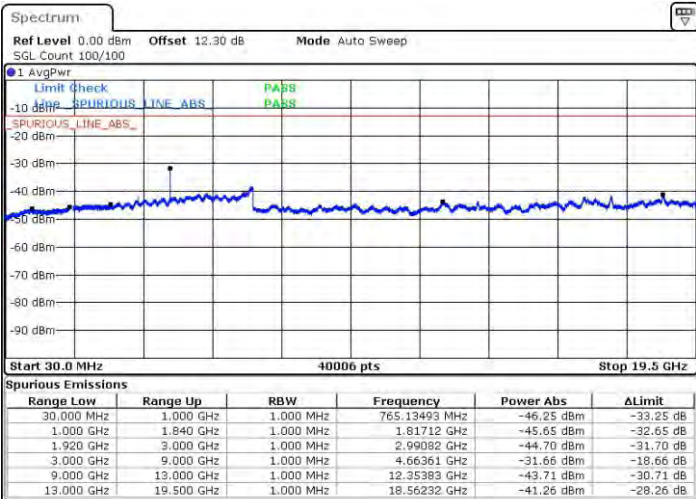

Date: 16.MAY.2015 09:16:43

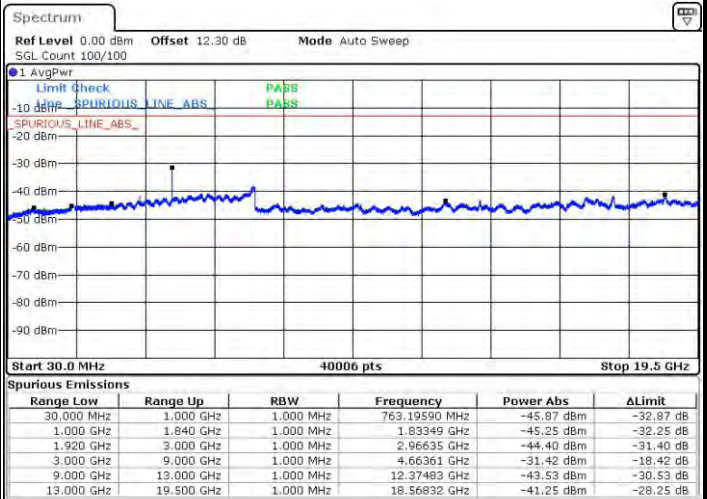

Date: 16.MAY.2015 09:17:57



LTE Band 2 / 15MHz

Highest Channel / QPSK

Highest Channel / 16QAM

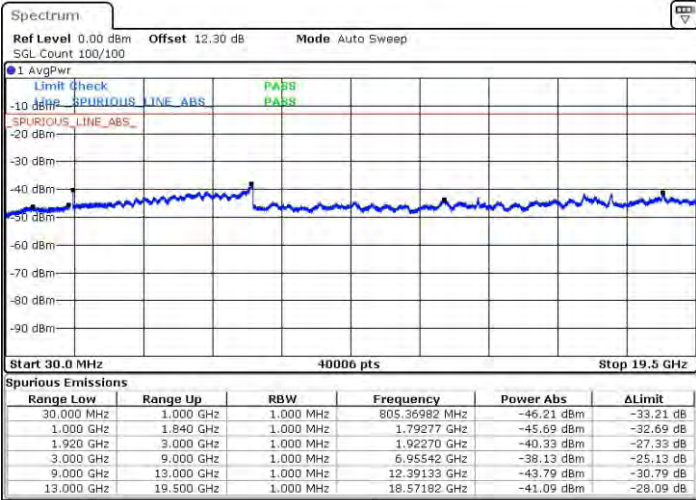

Date: 16.MAY.2015 09:24:42

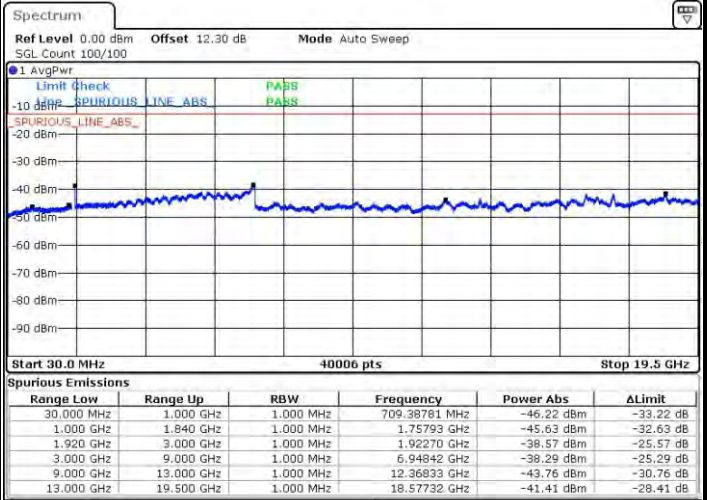

Date: 16.MAY.2015 09:25:36

LTE Band 2 / 20MHz

Lowest Channel / QPSK

Lowest Channel / 16QAM

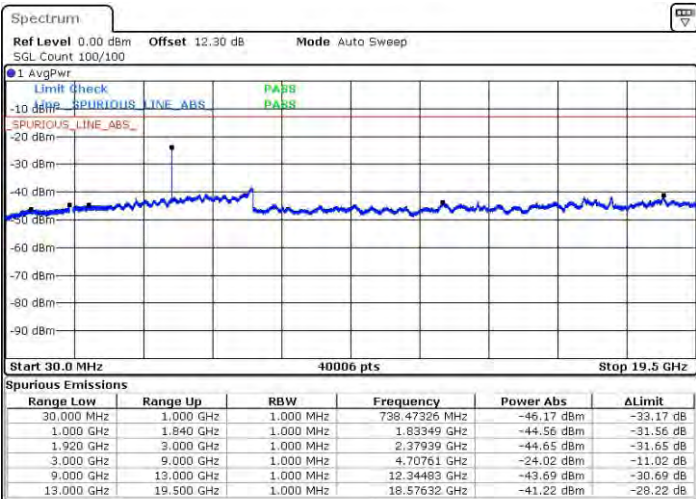

Date: 16.MAY.2015 09:32:40

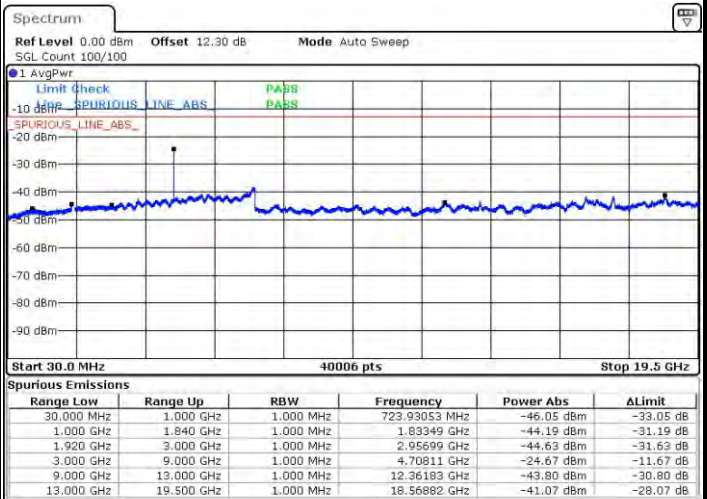

Date: 16.MAY.2015 09:33:34



LTE Band 2 / 20MHz

Middle Channel / QPSK

Middle Channel / 16QAM

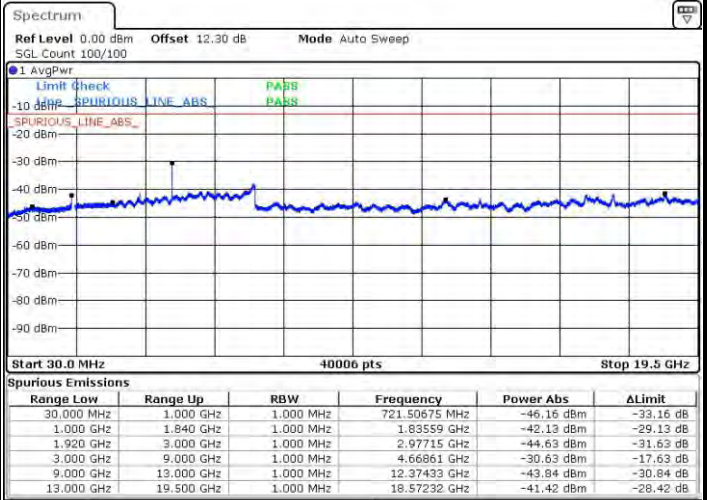
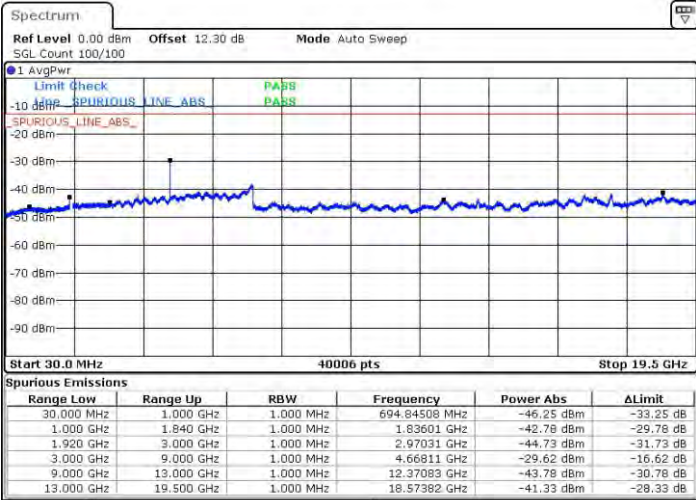

Date: 16.MAY.2015 09:36:00

Date: 16.MAY.2015 09:37:13

Highest Channel / QPSK

Highest Channel / 16QAM

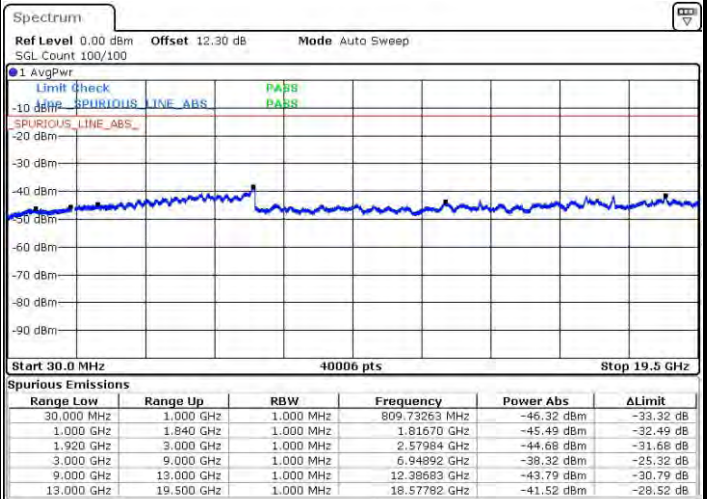
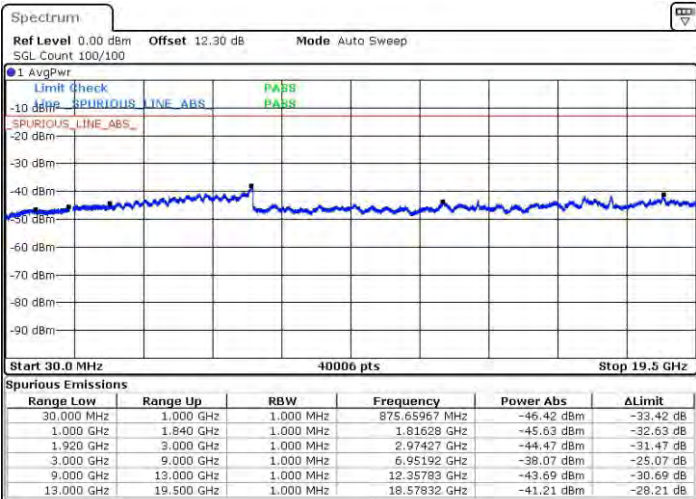

Date: 16.MAY.2015 09:43:59

Date: 16.MAY.2015 09:45:12



Frequency Stability

Test Conditions		LTE Band 2 (QPSK) / Middle Channel	Limit
Temperature (°C)	Voltage (Volt)	BW 10MHz	Note 2.
		Deviation (ppm)	Result
50	Normal Voltage	0.0095	PASS
40	Normal Voltage	0.0088	
30	Normal Voltage	0.0008	
20(Ref.)	Normal Voltage	0.0000	
10	Normal Voltage	0.0090	
0	Normal Voltage	0.0004	
-10	Normal Voltage	0.0094	
-20	Normal Voltage	0.0005	
-30	Normal Voltage	0.0092	
20	Maximum Voltage	0.0003	
20	Normal Voltage	0.0000	
20	Battery End Point	0.0089	

Note:

1. Normal Voltage = 3.7V. ; Battery End Point (BEP) = 3.5 V. ; Maximum Voltage =4.1 V
2. Note: The frequency fundamental emissions stay within the authorized frequency block based on the frequency deviation measured is small.