



# FCC RF Test Report

**APPLICANT** : Sony Mobile Communications Inc.  
**EQUIPMENT** : GSM/WCDMA/LTE Phone + Bluetooth, DTS/UNII  
a/b/g/n/ac, ANT+, and NFC  
**BRAND NAME** : Sony  
**FCC ID** : PY7-PM0882  
**STANDARD** : FCC Part 15 Subpart E §15.407  
**CLASSIFICATION** : (NII) Unlicensed National Information Infrastructure

The product was received on Jul. 16, 2015 and testing was completed on Aug. 26, 2015. We, SPORTON INTERNATIONAL INC., would like to declare that the tested sample has been evaluated in accordance with the test procedures and has been in compliance with the applicable technical standards.

The test results in this report apply exclusively to the tested model / sample. Without written approval of SPORTON INTERNATIONAL INC., the test report shall not be reproduced except in full.

Reviewed by: Joseph Lin / Supervisor

Approved by: Jones Tsai / Manager



## SPORTON INTERNATIONAL INC.

No. 52, Hwa Ya 1<sup>st</sup> Rd., Hwa Ya Technology Park, Kwei-Shan District, Tao Yuan City, Taiwan, R.O.C.

SPORTON INTERNATIONAL INC.

TEL : 886-3-327-3456

FAX : 886-3-328-4978

FCC ID : PY7-PM0882

Page Number : 1 of 34

Report Issued Date : Sep. 03, 2015

Report Version : Rev. 01

Report Template No.: BU5-FR15EWL AC Version 1.0



# TABLE OF CONTENTS

**REVISION HISTORY ..... 3**

**SUMMARY OF TEST RESULT ..... 4**

**1 GENERAL DESCRIPTION ..... 5**

    1.1 Applicant ..... 5

    1.2 Manufacturer ..... 5

    1.3 Feature of Equipment Under Test ..... 5

    1.4 Modification of EUT ..... 6

    1.5 Testing Location ..... 6

    1.6 Applicable Standards ..... 6

**2 TEST CONFIGURATION OF EQUIPMENT UNDER TEST ..... 7**

    2.1 Carrier Frequency and Channel ..... 8

    2.2 Pre-Scanned RF Power ..... 9

    2.3 Test Mode ..... 10

    2.4 Connection Diagram of Test System ..... 12

    2.5 Support Unit used in test configuration and system ..... 13

    2.6 EUT Operation Test Setup ..... 13

    2.7 Measurement Results Explanation Example ..... 13

**3 TEST RESULT ..... 14**

    3.1 26dB & 99% Occupied Bandwidth Measurement ..... 14

    3.2 Maximum Conducted Output Power Measurement ..... 16

    3.3 Power Spectral Density Measurement ..... 18

    3.4 Unwanted Emissions Measurement ..... 20

    3.5 AC Conducted Emission Measurement ..... 25

    3.6 Frequency Stability Measurement ..... 29

    3.7 Automatically Discontinue Transmission ..... 30

    3.8 Antenna Requirements ..... 31

**4 LIST OF MEASURING EQUIPMENT ..... 32**

**5 UNCERTAINTY OF EVALUATION ..... 34**

**APPENDIX A. CONDUCTED TEST RESULTS**

**APPENDIX B. RADIATED TEST RESULTS**

**APPENDIX C. RADIATED SPURIOUS EMISSION PLOTS**





### SUMMARY OF TEST RESULT

Report Section	FCC Rule	Description	Limit	Result	Remark
3.1	2.1049 15.403(i)	26dB & 99% Bandwidth	-	Pass	-
3.2	15.407(a)	Maximum Conducted Output Power	≤ 24 dBm (depend on band)	Pass	-
3.3	15.407(a)	Power Spectral Density	≤ 11 dBm (depend on band)	Pass	-
3.4	15.407(b)	Unwanted Emissions	≤ -17, -27 dBm (depend on band)&15.209(a)	Pass	Under limit 1.26 dB at 5150.000 MHz
3.5	15.207	AC Conducted Emission	15.207(a)	Pass	Under limit 19.30 dB at 0.614 MHz
3.6	15.407(g)	Frequency Stability	Within Operation Band	Pass	-
3.7	15.407(c)	Automatically Discontinue Transmission	Discontinue Transmission	Pass	-
3.8	15.203 & 15.407(a)	Antenna Requirement	N/A	Pass	-

**Remark:** The FR571619F report reuses test data from the FR571617F report.



# 1 General Description

## 1.1 Applicant

Sony Mobile Communications Inc.  
Nya Vattentorget, 22188 Lund, Sweden

## 1.2 Manufacturer

Sony Mobile Communications Inc.  
1-8-15 Konan, Minato-ku, Tokyo, 108-0075, Japan

## 1.3 Feature of Equipment Under Test

GSM/WCDMA/LTE, Bluetooth, DTS/UNII a/b/g/n/ac, ANT+, NFC and GPS

Product Specification subjective to this standard	
Antenna Type	Monopole Antenna
Antenna Gain	<5150 MHz ~ 5250 MHz>: -3.22dBi <5250 MHz ~ 5350 MHz>: -3.22dBi <5470 MHz ~ 5725 MHz>: -2.85dBi

EUT Information List				
IMEI	HW Version	SW Version	S/N	Performed Test Item
004402455123152	A	32.0.A.0.287	CB5A273TKQ	RF conducted measurement
004402455122295			CB5A273TGC	Radiated Spurious Emission
004402455122410			CB5A273THY	Conducted Emission

Accessory List	
AC Adapter	Model No. : UCH20
	Type No. : AC-0061-US
	S/N : 2115W15500021 (for Radiation Spurious Emission) 5815W22500112 (for Conducted Emission)
Earphone	Model No. : MDR-NC31E
	Type No. : AG-1110
USB Cable	Model No. : UCB11
	Type No. : AI-0120
	S/N : 1522A731000010A (for Radiated Spurious Emission) 1512A73E0001BD0 (for Conducted Emission)

**Note:**

1. Above EUT list and accessory list used are electrically identical per declared by manufacturer.
2. Above the accessories list are used to exercise the EUT during test.
3. For other wireless features of this EUT, test report will be issued separately.



### 1.4 Modification of EUT

No modifications are made to the EUT during all test items.

### 1.5 Testing Location

Sporton Lab is accredited to ISO 17025 by Taiwan Accreditation Foundation (TAF code : 1190) and the FCC designation No. TW1022 under the FCC 2.948(e) by Mutual Recognition Agreement (MRA) in FCC Test.

<b>Test Site</b>	SPORTON INTERNATIONAL INC.		
<b>Test Site Location</b>	No. 52, Hwa Ya 1 <sup>st</sup> Rd., Hwa Ya Technology Park, Kwei-Shan District, Tao Yuan City, Taiwan, R.O.C. TEL: +886-3-327-3456 FAX: +886-3-328-4978		
<b>Test Site No.</b>	<b>Sporton Site No.</b>		
	TH05-HY	CO05-HY	03CH07-HY

**Note:** The test site complies with ANSI C63.4 2009 requirement.

### 1.6 Applicable Standards

According to the specifications of the manufacturer, the EUT must comply with the requirements of the following standards:

- FCC Part 15 Subpart E
- FCC KDB 789033 D02 General UNII Test Procedures New Rules v01
- FCC KDB 644545 D03 Guidance for IEEE 802 11ac New Rules v01
- ANSI C63.10-2009

**Remark:**

1. All test items were verified and recorded according to the standards and without any deviation during the test.
2. FCC permits the use of the 1.5 meter table as an alternative in C63.10-2013 through inquiry tracking number 961829.



## **2 Test Configuration of Equipment Under Test**

The EUT has been associated with peripherals and configuration operated in a manner tended to maximize its emission characteristics in a typical application. Frequency range investigated: conducted emission (150 kHz to 30 MHz) and radiated emission (9 kHz to the 10th harmonic of the highest fundamental frequency or to 40 GHz, whichever is lower). For radiated measurement, pre-scanned in three orthogonal panels, X, Y, Z. The worst cases (Z plane) were recorded in this report.

The final configuration from all the combinations and the worst-case data rates were investigated by measuring the maximum power across all the data rates and modulation modes under section 2.2.

Based on the worst configuration found above, the RF power setting is set individually to meet FCC compliance limit for the final conducted and radiated tests shown in section 2.3.



### 2.1 Carrier Frequency and Channel

Frequency Band	Channel	Freq. (MHz)	Channel	Freq. (MHz)
5150-5250 MHz Band 1 (U-NII-1)	36	5180	44	5220
	<b>38</b>	<b>5190</b>	<b>46</b>	<b>5230</b>
	40	5200	48	5240
	42	5210		

Frequency Band	Channel	Freq. (MHz)	Channel	Freq. (MHz)
5250-5350 MHz Band 2 (U-NII-2A)	52	5260	60	5300
	<b>54</b>	<b>5270</b>	<b>62</b>	<b>5310</b>
	56	5280	64	5320
	58	5290		

Frequency Band	Channel	Freq. (MHz)	Channel	Freq. (MHz)
5470-5725 MHz Band 3 (U-NII-2C)	100	5500	120	5600
	<b>102</b>	<b>5510</b>	122	5610
	104	5520	124	5620
	106	5530	126	5630
	108	5540	128	5640
	<b>110</b>	<b>5550</b>	132	5660
	112	5560	<b>134</b>	<b>5670</b>
	116	5580	136	5680
	118	5590	140	5700

Frequency Band	Channel	Freq. (MHz)	Channel	Freq. (MHz)
Straddle Channel	144	5720	<b>142</b>	<b>5710</b>
	138	5690		

Note: The above Frequency and Channel in boldface were 802.11n HT40.





## 2.2 Pre-Scanned RF Power

Preliminary tests were performed in different data rate and data rate associated with the highest power were chosen for full test in the following tables. Final Output Power equals to Measured Output Power adds the duty factor.

5GHz 802.11a mode								
Data Rate (MHz)	6M bps	9M bps	12M bps	18M bps	24M bps	36M bps	48M bps	54M bps
Avg. Power (dBm)	12.66	12.60	12.62	12.65	12.51	12.62	12.61	12.59

5GHz 802.11n HT20 mode								
Data Rate (MHz)	MCS0	MCS1	MCS2	MCS3	MCS4	MCS5	MCS6	MCS7
Avg. Power (dBm)	12.67	12.66	12.66	12.66	12.65	12.65	12.63	12.64

5GHz 802.11n HT40mode								
Data Rate (MHz)	MCS0	MCS1	MCS2	MCS3	MCS4	MCS5	MCS6	MCS7
Avg. Power (dBm)	12.90	12.89	12.88	12.89	12.62	12.54	12.59	12.60

5GHz 802.11ac VHT20 mode									
Data Rate (MHz)	MCS 0	MCS 1	MCS 2	MCS 3	MCS 4	MCS 5	MCS 6	MCS 7	MCS 8
Avg. Power (dBm)	12.76	12.74	12.75	12.75	12.72	12.75	12.74	12.74	12.75

5GHz 802.11ac VHT40 mode										
Data Rate (MHz)	MCS 0	MCS 1	MCS 2	MCS 3	MCS 4	MCS 5	MCS 6	MCS 7	MCS 8	MCS 9
Avg. Power (dBm)	12.85	12.79	12.81	12.84	12.82	12.84	12.84	12.83	12.83	12.83

5GHz 802.11ac VHT80 mode										
Data Rate (MHz)	MCS 0	MCS 1	MCS 2	MCS 3	MCS 4	MCS 5	MCS 6	MCS 7	MCS 8	MCS 9
Avg. Power (dBm)	12.89	12.87	12.86	12.86	12.88	12.76	12.85	12.85	12.83	12.83



## 2.3 Test Mode

Final test mode of conducted test items and radiated spurious emissions are considering the modulation and worse data rates from the power table described in section 2.2.

The radiated spurious emissions testing were performed in n-mode only for HT20/40, which covers ac-mode testing.

Modulation	Data Rate
802.11a	6 Mbps
802.11n HT20	MCS0
802.11n HT40	MCS0
802.11ac VHT20	MCS0
802.11ac VHT40	MCS0
802.11ac VHT80	MCS0

Test Cases	
AC Conducted Emission	Mode 1 : WLAN (5GHz) Link + Earphone + USB Cable (Charging from Adapter)

Ch. #		Band I : 5150-5250 MHz	Band II : 5250-5350 MHz	Band III : 5470-5725MHz
		802.11a	802.11a	802.11a
L	Low	36	52	100
M	Middle	44	60	116
H	High	48	64	140
Straddle Band		-	-	144

Ch. #		Band I : 5150-5250 MHz	Band II : 5250-5350 MHz	Band III : 5470-5725MHz
		802.11n HT20	802.11n HT20	802.11n HT20
L	Low	36	52	100
M	Middle	44	60	116
H	High	48	64	140
Straddle Band		-	-	144



Ch. #		Band I : 5150-5250 MHz	Band II : 5250-5350 MHz	Band III : 5470-5725MHz
		802.11n HT40	802.11n HT40	802.11n HT40
L	Low	38	54	102
M	Middle	-	-	110
H	High	46	62	134
Straddle Band		-	-	142

Ch. #		Band I : 5150-5250 MHz	Band II : 5250-5350 MHz	Band III : 5470-5725MHz
		802.11ac VHT20	802.11ac VHT20	802.11ac VHT20
L	Low	36	52	100
M	Middle	44	60	116
H	High	48	64	140

Ch. #		Band I : 5150-5250 MHz	Band II : 5250-5350 MHz	Band III : 5470-5725MHz
		802.11ac VHT40	802.11ac VHT40	802.11ac VHT40
L	Low	38	54	102
M	Middle	-	-	110
H	High	46	62	134

Ch. #		Band I : 5150-5250 MHz	Band II : 5250-5350 MHz	Band III : 5470-5725MHz
		802.11ac VHT80	802.11ac VHT80	802.11ac VHT80
L	Low	-	-	-
M	Middle	42	58	106
H	High	-	-	-
Straddle Band		-	-	138

## 2.4 Connection Diagram of Test System

<WLAN Tx Mode>

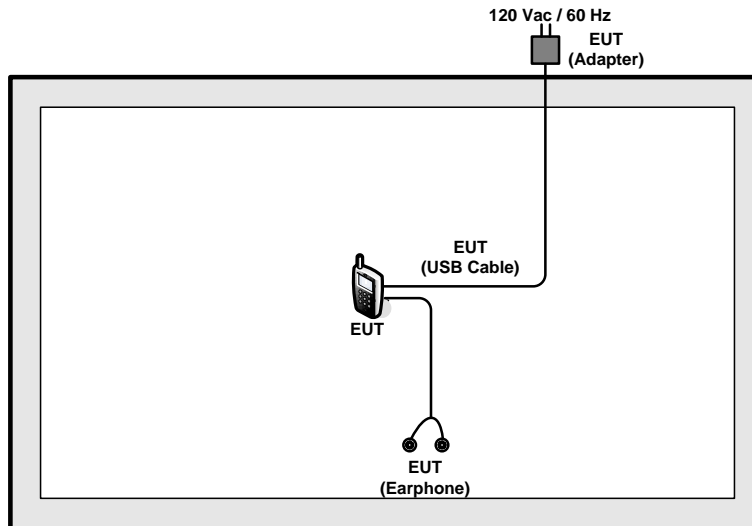

<AC Conducted Emission Mode>

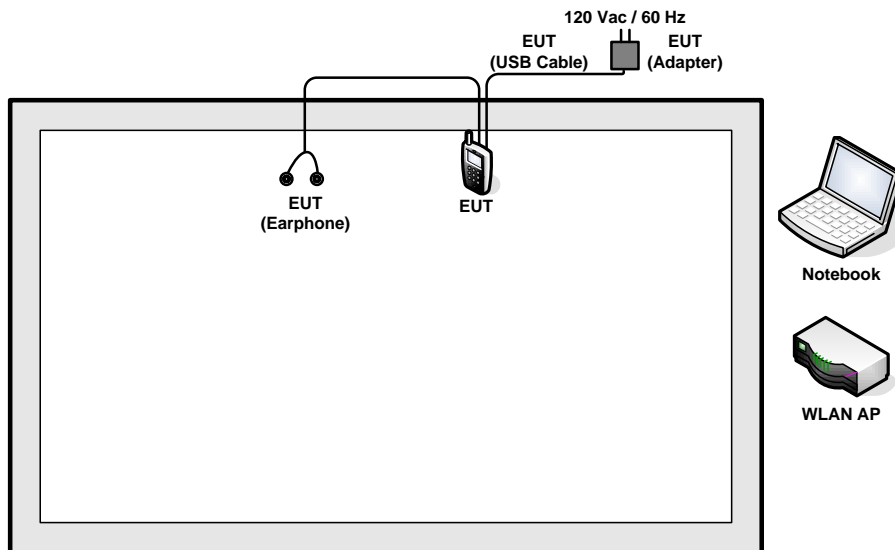



## 2.5 Support Unit used in test configuration and system

Item	Equipment	Trade Name	Model Name	FCC ID	Data Cable	Power Cord
1.	WLAN AP	D-Link	DIR-865L	KA2IR865LA1	N/A	Unshielded, 1.8 m
2.	Notebook	DELL	Latitude E6320	FCC DoC/ Contains FCC ID: QDS-BRCM1054	N/A	AC I/P: Unshielded, 1.2 m DC O/P: Shielded, 1.8 m
3.	SD Card	SanDisk	MicroSD HC	FCC DoC	N/A	N/A

## 2.6 EUT Operation Test Setup

For WLAN RF test items, an engineering test program was provided and enabled to make EUT continuous transmit/receive.

## 2.7 Measurement Results Explanation Example

For all conducted test items:

The offset level is set in the spectrum analyzer to compensate the RF cable loss and attenuator factor between EUT conducted output port and spectrum analyzer. With the offset compensation, the spectrum analyzer reading level is exactly the EUT RF output level.

Example :

The spectrum analyzer offset is derived from RF cable loss and attenuator factor.

*Offset = RF cable loss + attenuator factor.*

Following shows an offset computation example with cable loss 4.2 dB and 10dB attenuator.

$$\begin{aligned}
 \text{Offset(dB)} &= \text{RF cable loss(dB)} + \text{attenuator factor(dB)}. \\
 &= 4.2 + 10 = 14.2 \text{ (dB)}
 \end{aligned}$$

### 3 Test Result

#### 3.1 26dB & 99% Occupied Bandwidth Measurement

##### 3.1.1 Description of 26dB & 99% Occupied Bandwidth

This section is for reporting purpose only.

There is no restriction limits for bandwidth.

For Straddle Channel, U-NII procedures were applied for operations in the frequency band in accordance with FCC KDB 644545 D03.

##### 3.1.2 Measuring Instruments

The measuring equipment is listed in the section 4 of this test report.

##### 3.1.3 Test Procedures

1. The testing follows FCC KDB 789033 D02 General UNII Test Procedures New Rules v01.  
Section C) Emission bandwidth
2. Set RBW = approximately 1% of the emission bandwidth.
3. Set the VBW > RBW.
4. Detector = Peak.
5. Trace mode = max hold
6. Measure the maximum width of the emission that is 26 dB down from the peak of the emission.  
Compare this with the RBW setting of the analyzer. Readjust RBW and repeat measurement as needed until the RBW/EBW ratio is approximately 1%.
7. For 99% Bandwidth Measurement, the spectrum analyzer's resolution bandwidth (RBW) is set 1MHz and set the Video bandwidth (VBW)  $\geq 3 * RBW$ .
8. Measure and record the results in the test report.

##### 3.1.4 Test Setup

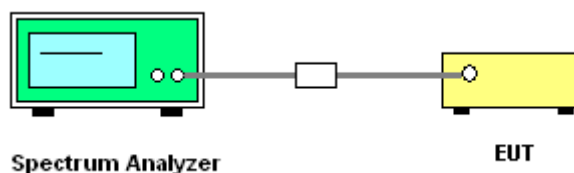



### 3.1.5 Test Result of 26dB & 99% Occupied Bandwidth

Please refer to Appendix A.

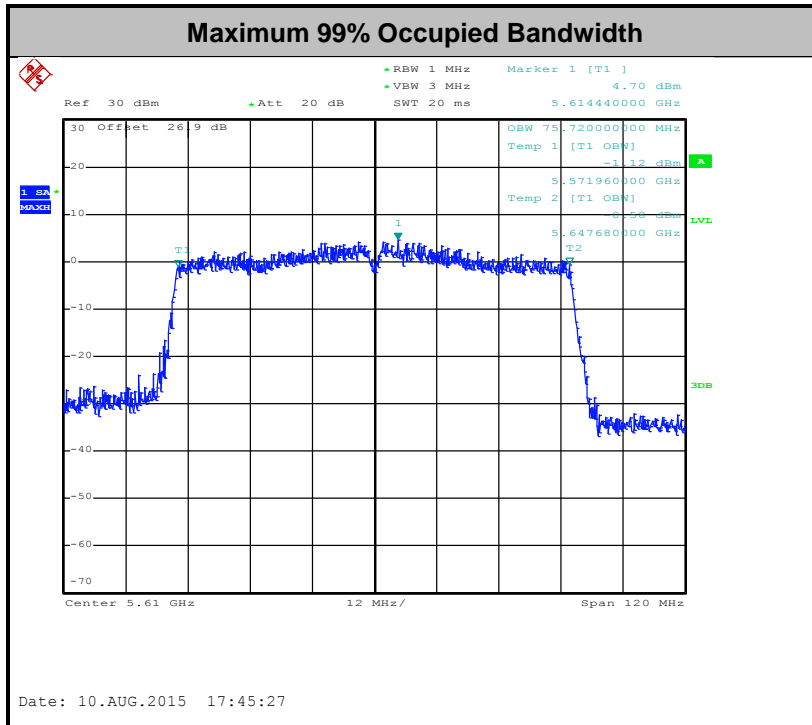
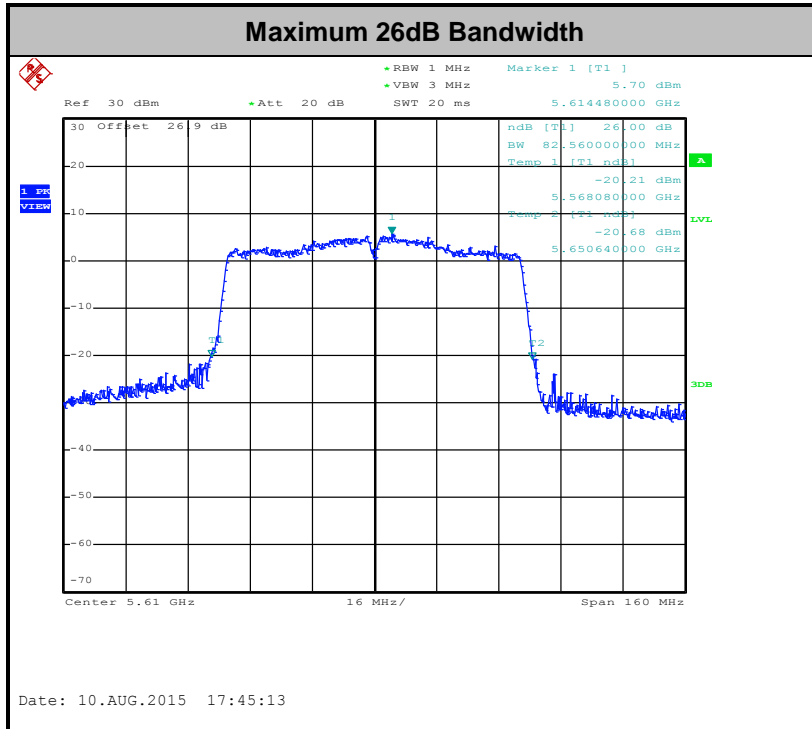

**Note:** The occupied channel bandwidth is maintained within the band of operation for all of the modulations.



## **3.2 Maximum Conducted Output Power Measurement**

### **3.2.1 Limit of Maximum Conducted Output Power**

For mobile and portable client devices in the 5.15–5.25 GHz band, the maximum conducted output power over the frequency band of operation shall not exceed 250 mW.

For the 5.25–5.35 GHz and 5.47–5.725 GHz bands, the maximum conducted output power over the frequency bands of operation shall not exceed the lesser of 250 mW or 11 dBm 10 log B, where B is the 26 dB emission bandwidth in megahertz.

For Straddle Channel, U-NII procedures and limits were applied for operations in the frequency band in accordance with FCC KDB 644545 D03.

If transmitting antennas of directional gain greater than 6 dBi are used, the peak output power shall be reduced by the amount in dB that the directional gain of the antenna exceeds 6 dBi.

Note that U-NII-2 band, devices with a maximum e.i.r.p. greater than 500 mW shall implement TPC in order to have the capability to operate at least 6 dB below the maximum permitted e.i.r.p. of 1 W.

### **3.2.2 Measuring Instruments**

The measuring equipment is listed in the section 4 of this test report.

### **3.2.3 Test Procedures**

The testing follows Method PM of FCC KDB 789033 D02 General UNII Test Procedures New Rules v01.

Method PM (Measurement using an RF average power meter):

1. Measurement is performed using a wideband RF power meter.
2. The EUT is configured to transmit continuously with a consistent duty cycle at its maximum power control level.
3. Measure the average power of the transmitter, and the average power is corrected with duty factor,  $10 \log(1/x)$ , where x is the duty cycle.

For straddle channel, the testing follows Method SA-3 (RMS detection with max hold) of FCC KDB 789033 D02 General UNII Test Procedures New Rules v01.

Compute power by integrating the spectrum across the 99% occupied bandwidth of the signal using the instrument's band power measurement function.



### 3.2.4 Test Setup

For normal channel:

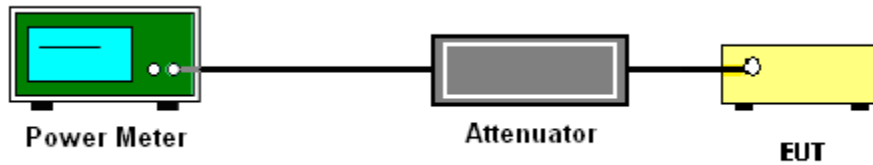

For straddle channel:

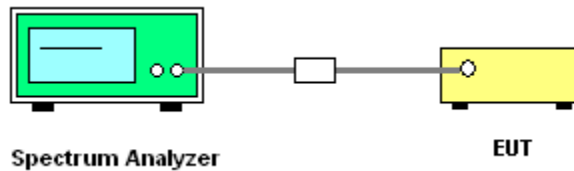

### 3.2.5 Test Result of Maximum Conducted Output Power

Please refer to Appendix A.

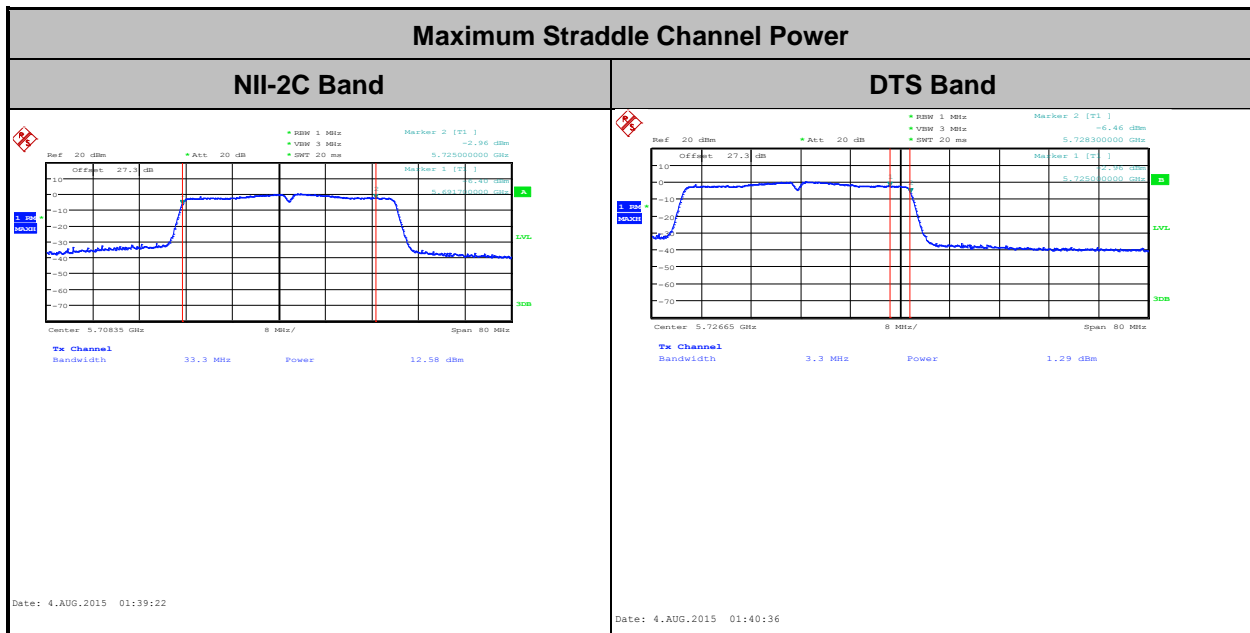



### 3.3 Power Spectral Density Measurement

#### 3.3.1 Limit of Power Spectral Density

For mobile and portable client devices in the 5.15–5.25 GHz band, the maximum power spectral density shall not exceed 11dBm in any 1 megahertz band.

For the 5.25–5.35 GHz and 5.47–5.725 GHz bands, the maximum power spectral density shall not exceed 11 dBm in any 1 megahertz band.

For Straddle Channel, U-NII procedures and limits were applied for operations in the frequency band in accordance with FCC KDB 644545 D03.

If transmitting antennas of directional gain greater than 6 dBi are used, the peak output power shall be reduced by the amount in dB that the directional gain of the antenna exceeds 6 dBi.

#### 3.3.2 Measuring Instruments

The measuring equipment is listed in the section 4 of this test report.

#### 3.3.3 Test Procedures

The testing follows FCC KDB 789033 D02 General UNII Test Procedures New Rules v01. Section F) Maximum power spectral density.

##### # Method SA-2 #

(trace averaging across on and off times of the EUT transmissions, followed by duty cycle correction).

1. The testing follows Method SA-2 of FCC KDB 789033 D02 General UNII Test Procedures New Rules v01.
  - Measure the duty cycle.
  - Set span to encompass the entire emission bandwidth (EBW) of the signal.
  - Set RBW = 1 MHz.
  - Set VBW  $\geq$  3 MHz.
  - Number of points in sweep  $\geq$  2 Span / RBW.
  - Sweep time = auto.
  - Detector = RMS
  - Trace average at least 100 traces in power averaging mode.
  - Add  $10 \log(1/x)$ , where x is the duty cycle, to the measured power in order to compute the average power during the actual transmission times. For example, add  $10 \log(1/0.25) = 6$  dB if the duty cycle is 25 percent.





### 3.4 Unwanted Emissions Measurement

This section as specified in FCC Part 15.407(b) is to measure unwanted emissions through radiated measurement for band edge spurious emissions and out of band emissions measurement. The unwanted emissions shall comply with 15.407(b)(1) to (6), and restricted bands per FCC Part15.205.

#### 3.4.1 Limit of Unwanted Emissions

(1) For transmitters operating in the 5150-5250 MHz band: all emissions outside of the 5150-5350 MHz band shall not exceed an EIRP of -27dBm/MHz.

For transmitters operating in the 5250-5350 MHz band: all emissions outside of the 5150-5350 MHz band shall not exceed an EIRP of -27 dBm/MHz. Devices operating in the 5250-5350 MHz band that generate emissions in the 5150-5250 MHz band must meet all applicable technical requirements for operation in the 5150-5250 MHz band (including indoor use) or alternatively meet an out-of-band emission EIRP limit of -27 dBm/MHz in the 5150-5250 MHz band.

For transmitters operating in the 5470-5600 MHz and 5650-5725MHz band: all emissions outside of the 5470-5600 MHz and 5650-5725MHz band shall not exceed an EIRP of -27 dBm/MHz.

(2) Unwanted spurious emissions fallen in restricted bands per FCC Part15.205 shall comply with the general field strength limits set forth in § 15.209 as below table,

Frequency (MHz)	Field Strength (microvolts/meter)	Measurement Distance (meters)
0.009 – 0.490	2400/F(kHz)	300
0.490 – 1.705	24000/F(kHz)	30
1.705 – 30.0	30	30
30 – 88	100	3
88 – 216	150	3
216 - 960	200	3
Above 960	500	3

**Note:** The following formula is used to convert the EIRP to field strength.



$$E = \frac{1000000\sqrt{30P}}{3} \mu\text{V/m, where P is the eirp (Watts)}$$

EIRP (dBm)	Field Strength at 3m (dBμV/m)
-17	78.3
- 27	68.3

(3) KDB789033 v01 G)2)c) As specified in 15.407(b), emissions above 1000 MHz that are outside of the restricted bands are subject to a peak emission limit of -27 dBm/MHz (or -17 dBm/MHz as specified in 15.407(b)(4)). However, an out-of-band emission that complies with both the average and peak limits of 15.209 is not required to satisfy the -27 dBm/MHz or -17 dBm/MHz peak emission limit.

### 3.4.2 Measuring Instruments

The measuring equipment is listed in the section 4 of this test report.

### 3.4.3 Test Procedures

1. The testing follows FCC KDB 789033 D02 General UNII Test Procedures New Rules v01. Section G) Unwanted emissions measurement.

(1) Procedure for Unwanted Emissions Measurements Below 1000MHz

- RBW = 120 kHz
- VBW = 300 kHz
- Detector = Peak
- Trace mode = max hold

(2) Procedure for Peak Unwanted Emissions Measurements Above 1000 MHz

- RBW = 1 MHz
- VBW ≥ 3 MHz
- Detector = Peak
- Sweep time = auto
- Trace mode = max hold



(3) Procedures for Average Unwanted Emissions Measurements Above 1000MHz

- RBW = 1 MHz
- VBW = 10 Hz, when duty cycle is no less than 98 percent.
- $VBW \geq 1/T$ , when duty cycle is less than 98 percent where T is the minimum transmission duration over which the transmitter is on and is transmitting at its maximum power control level for the tested mode of operation.

Band	Duty Cycle(%)	T(us)	1/T(kHz)	VBW Setting
802.11a	98.00	-	-	10Hz
5GHz 802.11n HT20	98.75	-	-	10Hz
5GHz 802.11n HT40	95.46	1416.67	0.71	1kHz
5GHz 802.11ac VHT80	90.41	679.49	1.47	2kHz

2. The EUT was placed on a turntable with 0.8 meter for frequency below 1GHz and 1.5 meter for frequency above 1GHz respectively above ground.
3. The EUT was set 3 meters from the interference receiving antenna which was mounted on the top of a variable height antenna tower.
4. The antenna is a broadband antenna and its height is adjusted between one meter and four meters above ground to find the maximum value of the field strength for both horizontal polarization and vertical polarization of the antenna.
5. For each suspected emission, the EUT was arranged to its worst case and then adjust the antenna tower (from 1 m to 4 m) and turntable (from 0 degree to 360 degrees) to find the maximum reading.
6. For testing below 1GHz, if the emission level of the EUT in peak mode was 3 dB lower than the limit specified, then peak values of EUT will be reported, otherwise, the emissions will be repeated one by one using the CISPR quasi-peak method and reported.
7. For testing above 1GHz, the emission level of the EUT in peak mode was 20dB lower than average limit (that means the emission level in average mode also complies with the limit in average mode), then peak values of EUT will be reported, otherwise, the emissions will be measured in average mode again and reported.

### 3.4.4 Test Setup

For radiated emissions below 30MHz

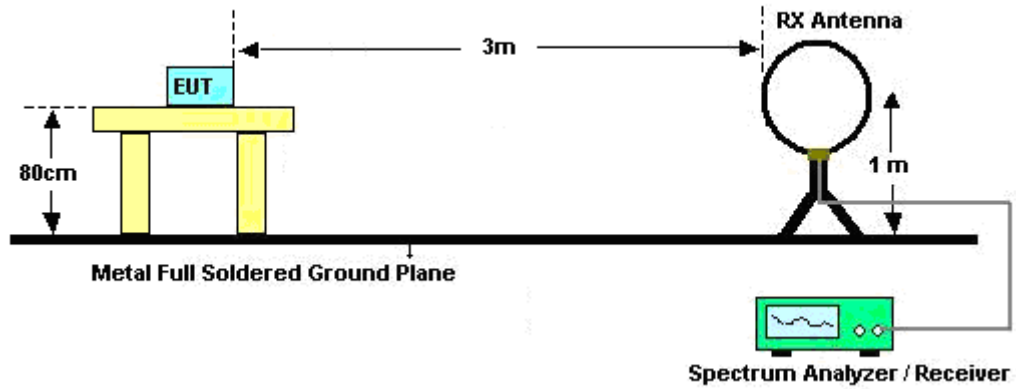

For radiated emissions from 30MHz to 1GHz

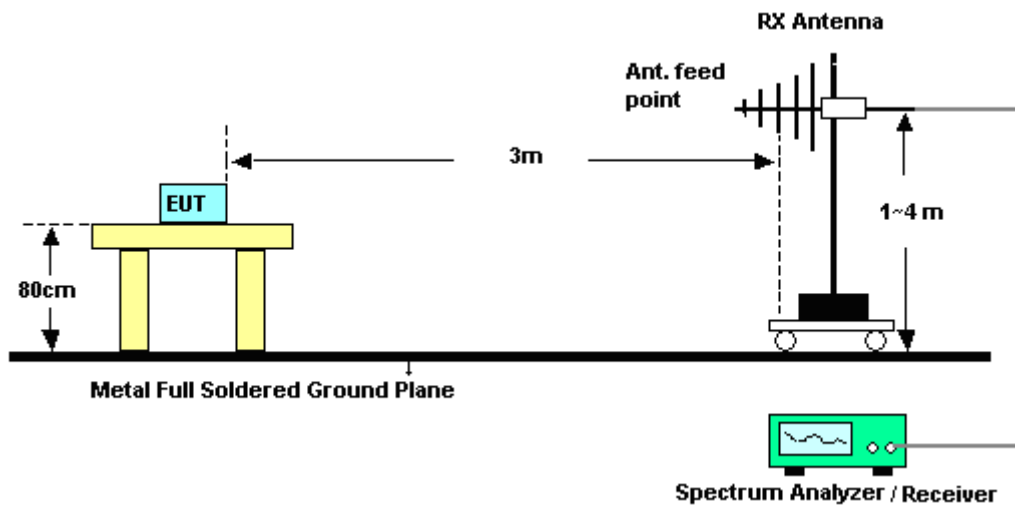

For radiated emissions above 1GHz

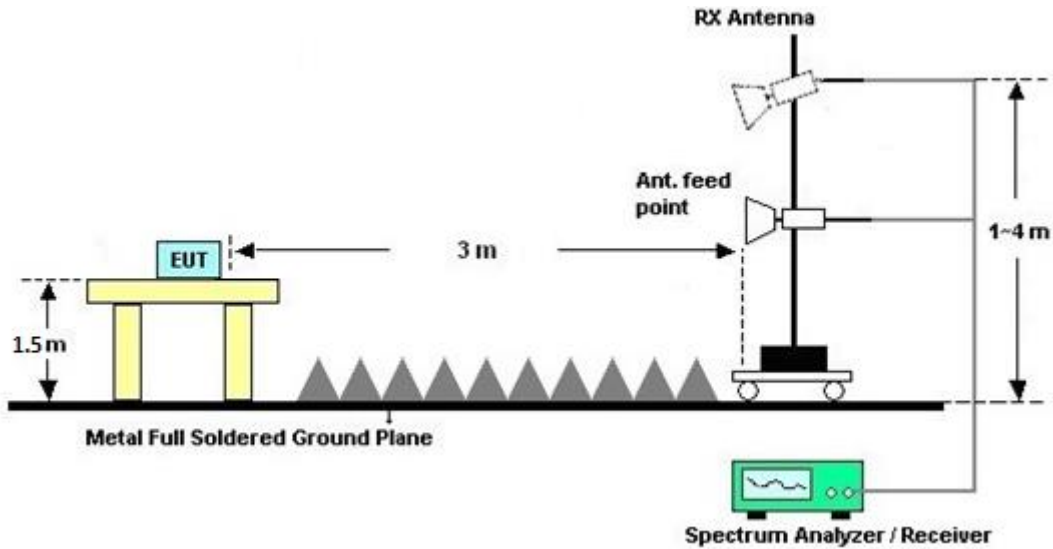

### 3.4.5 Test Results of Radiated Emissions (9 kHz ~ 30 MHz)

The low frequency, which started from 9 kHz to 30MHz, was pre-scanned and the result which was 20dB lower than the limit line per 15.31(o) was not reported.

### 3.4.6 Test Result of Radiated Band Edges

Please refer to Appendix A.

### 3.4.7 Test Result of Unwanted Radiated Emission (30MHz ~ 10th Harmonic)

Please refer to Appendix A.





### 3.5 AC Conducted Emission Measurement

#### 3.5.1 Limit of AC Conducted Emission

For equipment that is designed to be connected to the public utility (AC) power line, the radio frequency voltage that is conducted back onto the AC power line on any frequency or frequencies within the band 150 kHz to 30 MHz shall not exceed the limits in the following table.

Frequency of emission (MHz)	Conducted limit (dB $\mu$ V)	
	Quasi-peak	Average
0.15-0.5	66 to 56*	56 to 46*
0.5-5	56	46
5-30	60	50

\*Decreases with the logarithm of the frequency.

#### 3.5.2 Measuring Instruments

The measuring equipment is listed in the section 4 of this test report.

#### 3.5.3 Test Procedures

1. The EUT was placed 0.4 meter from the conducting wall of the shielding room was kept at least 80 centimeters from any other grounded conducting surface.
2. Connect EUT to the power mains through a line impedance stabilization network (LISN).
3. All the support units are connecting to the other LISN.
4. The LISN provides 50 ohm coupling impedance for the measuring instrument.
5. The FCC states that a 50 ohm, 50 microhenry LISN should be used.
6. Both sides of AC line were checked for maximum conducted interference.
7. The frequency range from 150 kHz to 30 MHz was searched.
8. Set the test-receiver system to Peak Detect Function and specified bandwidth with Maximum Hold Mode.

### 3.5.4 Test Setup

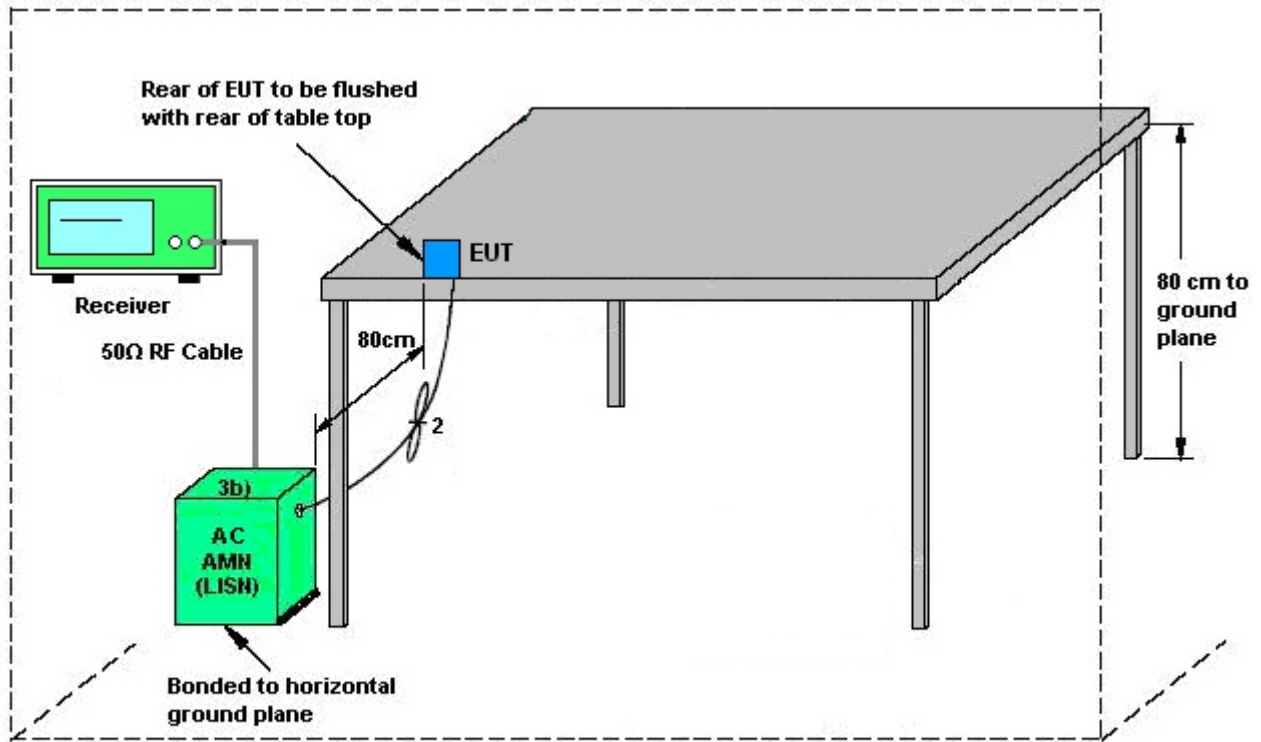

AMN = Artificial mains network (LISH)  
AE = Associated equipment  
EUT = Equipment under test  
ISN = Impedance stabilization network



### 3.5.5 Test Result of AC Conducted Emission

Test Mode :	Mode 1	Temperature :	23~25°C
Test Engineer :	Eric Jeng	Relative Humidity :	58~61%
Test Voltage :	120Vac / 60Hz	Phase :	Line
Function Type :	WLAN (5GHz) Link + Earphone + USB Cable (Charging from Adapter)		

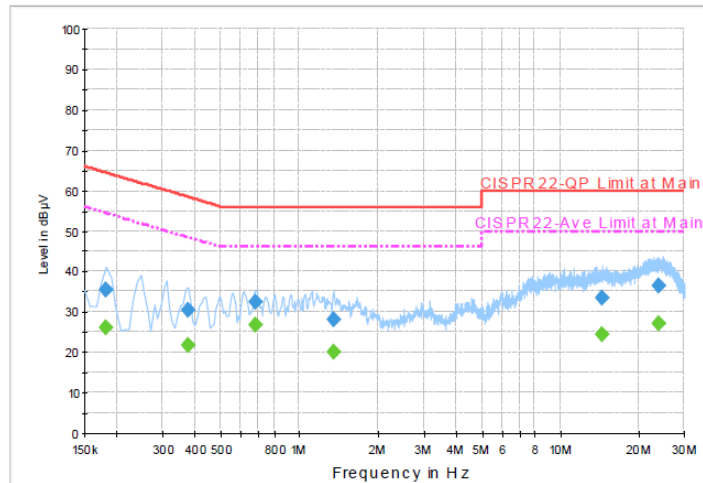

#### Final Result : QuasiPeak

Frequency (MHz)	QuasiPeak (dBµV)	Filter	Line	Corr. (dB)	Margin (dB)	Limit (dBµV)
0.182000	35.6	Off	L1	19.5	28.8	64.4
0.374000	30.5	Off	L1	19.5	27.9	58.4
0.678000	32.5	Off	L1	19.6	23.5	56.0
1.350000	28.2	Off	L1	19.6	27.8	56.0
14.438000	33.4	Off	L1	20.0	26.6	60.0
24.046000	36.5	Off	L1	20.0	23.5	60.0

#### Final Result : Average

Frequency (MHz)	Average (dBµV)	Filter	Line	Corr. (dB)	Margin (dB)	Limit (dBµV)
0.182000	26.2	Off	L1	19.5	28.2	54.4
0.374000	21.9	Off	L1	19.5	26.5	48.4
0.678000	26.6	Off	L1	19.6	19.4	46.0
1.350000	20.1	Off	L1	19.6	25.9	46.0
14.438000	24.3	Off	L1	20.0	25.7	50.0
24.046000	27.0	Off	L1	20.0	23.0	50.0



Test Mode :	Mode 1	Temperature :	23~25°C
Test Engineer :	Eric Jeng	Relative Humidity :	58~61%
Test Voltage :	120Vac / 60Hz	Phase :	Neutral
Function Type :	WLAN (5GHz) Link + Earphone + USB Cable (Charging from Adapter)		

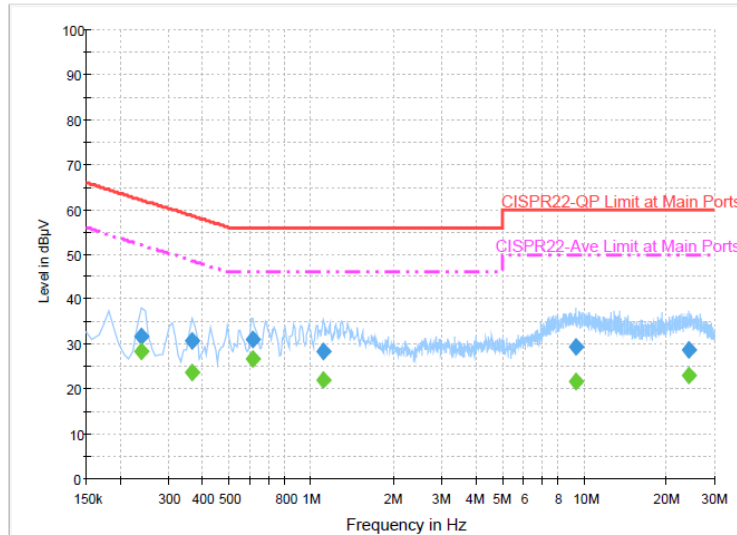

**Final Result : QuasiPeak**

Frequency (MHz)	QuasiPeak (dBµV)	Filter	Line	Corr. (dB)	Margin (dB)	Limit (dBµV)
0.238000	31.9	Off	N	19.5	30.3	62.2
0.366000	30.8	Off	N	19.5	27.8	58.6
0.614000	31.1	Off	N	19.5	24.9	56.0
1.110000	28.5	Off	N	19.5	27.5	56.0
9.374000	29.6	Off	N	19.8	30.4	60.0
24.078000	28.6	Off	N	20.1	31.4	60.0

**Final Result : Average**

Frequency (MHz)	Average (dBµV)	Filter	Line	Corr. (dB)	Margin (dB)	Limit (dBµV)
0.238000	28.5	Off	N	19.5	23.7	52.2
0.366000	23.8	Off	N	19.5	24.8	48.6
0.614000	26.7	Off	N	19.5	19.3	46.0
1.110000	21.9	Off	N	19.5	24.1	46.0
9.374000	21.8	Off	N	19.8	28.2	50.0
24.078000	23.1	Off	N	20.1	26.9	50.0

## 3.6 Frequency Stability Measurement

### 3.6.1 Limit of Frequency Stability

Manufacturers of U-NII devices are responsible for ensuring frequency stability such that an emission is maintained within the band of operation under all conditions of normal operation as specified in the user's manual.

### 3.6.2 Measuring Instruments

The measuring equipment is listed in the section 4 of this test report.

### 3.6.3 Test Procedures

1. To ensure emission at the band edge is maintained within the authorized band, those values shall be measured by radiation emissions at upper and lower frequency points, and finally compensated by frequency deviation as procedures below.
2. The EUT was operated at the maximum output power, and connected to the spectrum analyzer, which is set to maximum hold function and peak detector. The peak value of the power envelope was measured and noted. The upper and lower frequency points were respectively measured relatively 10dB lower than the measured peak value.
3. The frequency deviation was calculated by adding the upper frequency point and the lower frequency point divided by two. Those detailed values of frequency deviation are provided in table below.

### 3.6.4 Test Setup

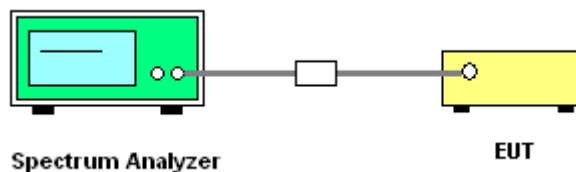

### 3.6.5 Test Result of Frequency Stability

Please refer to Appendix A.



## **3.7 Automatically Discontinue Transmission**

### **3.7.1 Limit of Automatically Discontinue Transmission**

The device shall automatically discontinue transmission in case of either absence of information to transmit or operational failure. These provisions are not intended to preclude the transmission of control or signaling information or the use of repetitive codes used by certain digital technologies to complete frame or burst intervals. Applicants shall include in their application for equipment authorization to describe how this requirement is met.

### **3.7.2 Measuring Instruments**

The measuring equipment is listed in the section 4 of this test report.

### **3.7.3 Test Result of Automatically Discontinue Transmission**

While the EUT is not transmitting any information, the EUT can automatically discontinue transmission and become standby mode for power saving. The EUT can detect the controlling signal of ACK message transmitting from remote device and verify whether it shall resend or discontinue transmission.



## **3.8 Antenna Requirements**

### **3.8.1 Standard Applicable**

According to FCC 47 CFR Section 15.407(a)(1)(2), if transmitting antenna directional gain is greater than 6 dBi, both the peak transmit power and the peak power spectral density shall be reduced by the amount in dB that the directional gain of the antenna exceeds 6 dBi.

### **3.8.2 Antenna Anti-Replacement Construction**

An embedded-in antenna design is used.

### **3.8.3 Antenna Gain**

The antenna peak gain of EUT is less than 6 dBi. Therefore, it is not necessary to reduce maximum peak output power limit.



## 4 List of Measuring Equipment

Instrument	Manufacturer	Model No.	Serial No.	Characteristics	Calibration Date	Test Date	Due Date	Remark
Power Meter	Anritsu	ML2495A	1218006	300MHz~40GHz	Oct. 18, 2014	Aug. 03, 2015~ Aug. 12, 2015	Oct. 17, 2015	Conducted (TH05-HY)
Power Sensor	Anritsu	MA2411B	1207363	300MHz~40GHz	Oct. 18, 2014	Aug. 03, 2015~ Aug. 12, 2015	Oct. 17, 2015	Conducted (TH05-HY)
Spectrum Analyzer	Rohde & Schwarz	FSP40	100057	9kHz-40GHz	Oct. 17, 2014	Aug. 03, 2015~ Aug. 12, 2015	Oct. 16, 2015	Conducted (TH05-HY)
Temperature Chamber	ESPEC	SU-241	92003713	-30° ~ 95°	Jun. 15, 2015	Aug. 03, 2015~ Aug. 12, 2015	Jun. 14, 2016	Conducted (TH05-HY)
Hygrometer	Testo	608-H1	34897199	N/A	May 04, 2015	Aug. 03, 2015~ Aug. 12, 2015	May 03, 2016	Conducted (TH05-HY)
RF Cable	HARBOUR INDUSTRIES	LL142	Infinet CA3601-3601- DLL	0.1MHz~40GHz	Mar. 06, 2015	Aug. 03, 2015~ Aug. 12, 2015	Mar. 05, 2016	Conducted (TH05-HY)
Bilog Antenna	Schaffner	CBL6111C	2726	30MHz ~ 1GHz	Sep. 27, 2014	Aug. 05, 2015 ~ Aug. 26, 2015	Sep. 26, 2015	Radiation (03CH07-HY)
Double Ridge Horn Antenna	EMCO	3117	00066583	1GHz~18GHz	Jul. 20, 2015	Aug. 05, 2015 ~ Aug. 26, 2015	Jul. 19, 2016	Radiation (03CH07-HY)
Loop Antenna	TESEQ	HLA 6120	31244	9kHz~30MHz	Feb. 02, 2015	Aug. 05, 2015 ~ Aug. 26, 2015	Feb. 01, 2016	Radiation (03CH07-HY)
EMI Test Receiver	Rohde & Schwarz	ESCI 7	100724	9kHz~7GHz	Aug. 30, 2014	Aug. 05, 2015 ~ Aug. 26, 2015	Aug. 29, 2015	Radiation (03CH07-HY)
Horn Antenna	SCHWARZBECK	BBHA 9170	BBHA9170584	18GHz- 40GHz	Nov. 03, 2014	Aug. 05, 2015 ~ Aug. 26, 2015	Nov. 02, 2015	Radiation (03CH07-HY)
Hygrometer	Testo	608-H1	34897197	N/A	May 04, 2015	Aug. 05, 2015 ~ Aug. 26, 2015	May 03, 2016	Radiation (03CH07-HY)
Preamplifier	MITEQ	AMF-7D-0010 1800-30-10P	1590075	1GHz ~ 18GHz	Apr. 20, 2015	Aug. 05, 2015 ~ Aug. 26, 2015	Apr. 19, 2016	Radiation (03CH07-HY)
Preamplifier	COM-POWER	PA-103A	161241	10MHz-1000MHz	Mar. 12, 2015	Aug. 05, 2015 ~ Aug. 26, 2015	Mar. 11, 2016	Radiation (03CH07-HY)
Preamplifier	Agilent	8449B	3008A02362	1GHz~ 26.5GHz	Oct. 21, 2014	Aug. 05, 2015 ~ Aug. 26, 2015	Oct. 20, 2015	Radiation (03CH07-HY)
Signal Analyzer	Rohde & Schwarz	FSV 30	101749	10Hz~30GHz	Mar. 10, 2015	Aug. 05, 2015 ~ Aug. 26, 2015	Mar. 09, 2016	Radiation (03CH07-HY)
RF Cable	HUBER + SUHNER	SUCOFLEX 104	MY84209521	1GHz~40GHz	Dec. 04, 2014	Aug. 05, 2015 ~ Aug. 26, 2015	Dec. 03, 2015	Radiation (03CH07-HY)
RF Cable	HUBER + SUHNER	SUCOFLEX 104	MY84209521	9kHz~1GHz	Dec. 04, 2014	Aug. 05, 2015 ~ Aug. 26, 2015	Dec. 03, 2015	Radiation (03CH07-HY)
Controller	ChainTek	Chaintek 3000	N/A	Control Turn table	N/A	Aug. 05, 2015 ~ Aug. 26, 2015	N/A	Radiation (03CH07-HY)
Controller	Max-Full	MF7802	MF780208368	Control Ant Mast	N/A	Aug. 05, 2015 ~ Aug. 26, 2015	N/A	Radiation (03CH07-HY)
Antenna Mast	Max-Full	MFA520BS	N/A	1m~4m	N/A	Aug. 05, 2015 ~ Aug. 26, 2015	N/A	Radiation (03CH07-HY)
Turn Table	ChainTek	Chaintek 3000	N/A	0~360 degree	N/A	Aug. 05, 2015 ~ Aug. 26, 2015	N/A	Radiation (03CH07-HY)





Instrument	Manufacturer	Model No.	Serial No.	Characteristics	Calibration Date	Test Date	Due Date	Remark
Preamplifier	MITEQ	JS44-18004000 -33-8P	1840917	18GHz ~ 40GHz	Jun. 02, 2015	Aug. 05, 2015 ~ Aug. 26, 2015	Jun. 01, 2016	Radiation (03CH07-HY)
Test Software	Audix	E3	6.2009-8-24	N/A	N/A	Aug. 05, 2015 ~ Aug. 26, 2015	N/A	Radiation (03CH07-HY)
Filter	Wainwright	WLKS4500-8SS	SN19	4.5G Low Pass	Oct. 01, 2014	Aug. 05, 2015 ~ Aug. 26, 2015	Sep. 30, 2015	Radiation (03CH07-HY)
Filter	Microwave Circuits	H07G18G3	SN8009-01	7GHz HPF	Oct. 01, 2014	Aug. 05, 2015 ~ Aug. 26, 2015	Sep. 30, 2015	Radiation (03CH07-HY)
EMI Test Receiver	Rohde & Schwarz	ESCS 30	100356	9kHz – 2.75GHz	Dec. 01, 2014	Aug. 15, 2015	Nov. 30, 2015	Conduction (CO05-HY)
Hygrometer	Testo	608-H1	34913912	N/A	Apr. 20, 2015	Aug. 15, 2015	Apr. 19, 2016	Conduction (CO05-HY)
LISN	Rohde & Schwarz	ENV216	100080	9kHz~30MHz	Dec. 02, 2014	Aug. 15, 2015	Dec. 01, 2015	Conduction (CO05-HY)
AC Power Source	ChainTek	APC-1000W	N/A	N/A	N/A	Aug. 15, 2015	N/A	Conduction (CO05-HY)
LF Cable	HUBER + SUHNER	RG-214/U	LF01	N/A	Jan. 07, 2015	Aug. 15, 2015	Jan. 06, 2016	Conduction (CO05-HY)
Test Software	N/A	EMC32	8.40.0	N/A	N/A	Aug. 15, 2015	N/A	Conduction (CO05-HY)



## 5 Uncertainty of Evaluation

### Uncertainty of Conducted Emission Measurement (150kHz ~ 30MHz)

Measuring Uncertainty for a Level of Confidence of 95% ( $U = 2Uc(y)$ )	2.26
---	------

### Uncertainty of Radiated Emission Measurement (30 MHz ~ 1000 MHz)

Measuring Uncertainty for a Level of Confidence of 95% ( $U = 2Uc(y)$ )	4.8
---	-----



## **Appendix A. Conducted Test Results**

Test Engineer:	Tommy Lee	Temperature:	21~25	°C
Test Date:	2015/08/03 ~ 2015/08/12	Relative Humidity:	51~54	%

**TEST RESULTS DATA**  
**26dB and 99% OBW**

Band I										
Mod.	Data Rate	NTX	CH.	Freq. (MHz)	99% Bandwidth (MHz)	26 dB Bandwidth (MHz)	IC 99% Bandwidth Power Limit (dBm)	IC 99% Bandwidth EIRP Limit (dBm)		
11a	6Mbps	1	36	5180	17.70	22.75	-	22.48		
11a	6Mbps	1	44	5220	17.95	22.65	-	22.54		
11a	6Mbps	1	48	5240	17.85	22.85	-	22.52		
HT20	MCS0	1	36	5180	18.75	23.00	-	22.73		
HT20	MCS0	1	44	5220	18.65	22.95	-	22.71		
HT20	MCS0	1	48	5240	18.70	23.00	-	22.72		
HT40	MCS0	1	38	5190	36.50	40.95	-	23.01		
HT40	MCS0	1	46	5230	36.50	41.31	-	23.01		
VHT20	MCS0	1	36	5180	18.70	23.05	-	22.72		
VHT20	MCS0	1	44	5220	18.80	23.00	-	22.74		
VHT20	MCS0	1	48	5240	18.65	23.00	-	22.71		
VHT40	MCS0	1	38	5190	36.40	41.40	-	23.01		
VHT40	MCS0	1	46	5230	36.60	41.31	-	23.01		
VHT80	MCS0	1	42	5210	75.60	81.76	-	23.01		

**TEST RESULTS DATA**  
**Average Power Table**

FCC Band I										
Mod.	Data Rate	NTX	CH.	Freq. (MHz)	Duty Factor (dB)	Average Conducted Power (dBm)	FCC Conducted Power Limit (dBm)	DG (dBi)		Pass/Fail
11a	6Mbps	1	36	5180	0.09	12.52	24.00	-3.22		Pass
11a	6Mbps	1	44	5220	0.09	12.54	24.00	-3.22		Pass
11a	6Mbps	1	48	5240	0.09	12.51	24.00	-3.22		Pass
HT20	MCS0	1	36	5180	0.05	12.51	24.00	-3.22		Pass
HT20	MCS0	1	44	5220	0.05	12.54	24.00	-3.22		Pass
HT20	MCS0	1	48	5240	0.05	12.50	24.00	-3.22		Pass
HT40	MCS0	1	38	5190	0.20	12.36	24.00	-3.22		Pass
HT40	MCS0	1	46	5230	0.20	12.90	24.00	-3.22		Pass
VHT20	MCS0	1	36	5180	0.05	12.15	24.00	-3.22		Pass
VHT20	MCS0	1	44	5220	0.05	12.13	24.00	-3.22		Pass
VHT20	MCS0	1	48	5240	0.05	12.41	24.00	-3.22		Pass
VHT40	MCS0	1	38	5190	0.25	12.65	24.00	-3.22		Pass
VHT40	MCS0	1	46	5230	0.25	12.51	24.00	-3.22		Pass
VHT80	MCS0	1	42	5210	0.44	12.88	24.00	-3.22		Pass

**TEST RESULTS DATA**  
**Power Spectral Density**

FCC Band I										
Mod.	Data Rate	NTX	CH.	Freq. (MHz)	Duty Factor (dB)	Average Power Density (dBm/MHz)	Average PSD Limit (dBm/MHz)	DG (dBi)	-	Pass/Fail
11a	6Mbps	1	36	5180	0.09	0.62	11.00	-3.22		Pass
11a	6Mbps	1	44	5220	0.09	0.72	11.00	-3.22		Pass
11a	6Mbps	1	48	5240	0.09	0.86	11.00	-3.22		Pass
HT20	MCS0	1	36	5180	0.05	0.33	11.00	-3.22		Pass
HT20	MCS0	1	44	5220	0.05	0.82	11.00	-3.22		Pass
HT20	MCS0	1	48	5240	0.05	0.73	11.00	-3.22		Pass
HT40	MCS0	1	38	5190	0.20	-2.26	11.00	-3.22		Pass
HT40	MCS0	1	46	5230	0.20	-1.85	11.00	-3.22		Pass
VHT20	MCS0	1	36	5180	0.05	0.88	11.00	-3.22		Pass
VHT20	MCS0	1	44	5220	0.05	1.12	11.00	-3.22		Pass
VHT20	MCS0	1	48	5240	0.05	1.30	11.00	-3.22		Pass
VHT40	MCS0	1	38	5190	0.25	-1.55	11.00	-3.22		Pass
VHT40	MCS0	1	46	5230	0.25	-1.27	11.00	-3.22		Pass
VHT80	MCS0	1	42	5210	0.44	-4.10	11.00	-3.22		Pass

**TEST RESULTS DATA**  
**26dB and 99% OBW**

Band II										
Mod.	Data Rate	NTX	CH.	Freq. (MHz)	99% Bandwidth (MHz)	26 dB Bandwidth (MHz)	IC 99% Bandwidth Power Limit (dBm)	IC 99% Bandwidth EIRP Limit (dBm)	FCC 26dB Bandwidth Power Limit (dBm)	Note
11a	6M bps	1	52	5260	17.9	22.75	23.53	29.53	23.98	
11a	6M bps	1	60	5300	17.8	22.8	23.50	29.50	23.98	
11a	6M bps	1	64	5320	17.85	22.85	23.52	29.52	23.98	
HT20	MCS 0	1	52	5260	18.75	23.1	23.73	29.73	23.98	
HT20	MCS 0	1	60	5300	18.75	22.9	23.73	29.73	23.98	
HT20	MCS 0	1	64	5320	18.75	22.9	23.73	29.73	23.98	
HT40	MCS 0	1	54	5270	36.5	41.31	23.98	30.00	23.98	
HT40	MCS 0	1	62	5310	36.6	41.4	23.98	30.00	23.98	
VHT20	MCS 0	1	52	5260	18.65	23	23.71	29.71	23.98	
VHT20	MCS 0	1	60	5300	18.7	23	23.72	29.72	23.98	
VHT20	MCS 0	1	64	5320	18.85	23	23.75	29.75	23.98	
VHT40	MCS 0	1	54	5270	36.5	41.31	23.98	30.00	23.98	
VHT40	MCS 0	1	62	5310	36.6	41.13	23.98	30.00	23.98	
VHT80	MCS 0	1	58	5290	75.6	82.08	23.98	30.00	23.98	



**TEST RESULTS DATA**  
**Average Power Table**

FCC Band II										
Mod.	Data Rate	NTX	CH.	Freq. (MHz)	Duty Factor (dB)	Average Conducted Power (dBm)	FCC Conducted Power Limit (dBm)	DG (dBi)		Pass/Fail
11a	6M bps	1	52	5260	0.09	12.51	23.98	-3.22		Pass
11a	6M bps	1	60	5300	0.09	12.50	23.98	-3.22		Pass
11a	6M bps	1	64	5320	0.09	12.52	23.98	-3.22		Pass
HT20	MCS 0	1	52	5260	0.05	12.52	23.98	-3.22		Pass
HT20	MCS 0	1	60	5300	0.05	12.50	23.98	-3.22		Pass
HT20	MCS 0	1	64	5320	0.05	12.53	23.98	-3.22		Pass
HT40	MCS 0	1	54	5270	0.20	12.47	23.98	-3.22		Pass
HT40	MCS 0	1	62	5310	0.20	12.20	23.98	-3.22		Pass
VHT20	MCS 0	1	52	5260	0.05	12.19	23.98	-3.22		Pass
VHT20	MCS 0	1	60	5300	0.05	12.09	23.98	-3.22		Pass
VHT20	MCS 0	1	64	5320	0.05	12.12	23.98	-3.22		Pass
VHT40	MCS 0	1	54	5270	0.25	12.66	23.98	-3.22		Pass
VHT40	MCS 0	1	62	5310	0.25	12.40	23.98	-3.22		Pass
VHT80	MCS 0	1	58	5290	0.44	12.60	23.98	-3.22		Pass

**TEST RESULTS DATA**  
**Power Spectral Density**

Band II										
Mod.	Data Rate	NTX	CH.	Freq. (MHz)	Duty Factor (dB)	Average Power Density (dBm/MHz)	Average PSD Limit (dBm/MHz)	DG (dBi)		Pass/Fail
11a	6M bps	1	52	5260	0.09	1.13	11.00	-3.22		Pass
11a	6M bps	1	60	5300	0.09	1.10	11.00	-3.22		Pass
11a	6M bps	1	64	5320	0.09	1.06	11.00	-3.22		Pass
HT20	MCS 0	1	52	5260	0.05	0.91	11.00	-3.22		Pass
HT20	MCS 0	1	60	5300	0.05	0.68	11.00	-3.22		Pass
HT20	MCS 0	1	64	5320	0.05	0.86	11.00	-3.22		Pass
HT40	MCS 0	1	54	5270	0.20	-2.14	11.00	-3.22		Pass
HT40	MCS 0	1	62	5310	0.20	-1.93	11.00	-3.22		Pass
VHT20	MCS 0	1	52	5260	0.05	1.39	11.00	-3.22		Pass
VHT20	MCS 0	1	60	5300	0.05	1.04	11.00	-3.22		Pass
VHT20	MCS 0	1	64	5320	0.05	1.39	11.00	-3.22		Pass
VHT40	MCS 0	1	54	5270	0.25	-1.24	11.00	-3.22		Pass
VHT40	MCS 0	1	62	5310	0.25	-1.37	11.00	-3.22		Pass
VHT80	MCS 0	1	58	5290	0.44	-4.02	11.00	-3.22		Pass

**TEST RESULTS DATA**  
**26dB and 99% OBW**

Band III										
Mod.	Data Rate	NTX	CH.	Freq. (MHz)	99% Bandwidth (MHz)	26 dB Bandwidth (MHz)	IC 99% Bandwidth Power Limit (dBm)	IC 99% Bandwidth EIRP Limit (dBm)	FCC 26dB Bandwidth Power Limit (dBm)	Note
11a	6M bps	1	100	5500	17.95	22.9	23.54	29.54	23.98	
11a	6M bps	1	116	5580	18	22.75	23.55	29.55	23.98	
11a	6M bps	1	140	5700	17.8	22.9	23.50	29.50	23.98	
HT20	MCS 0	1	100	5500	18.7	23.1	23.72	29.72	23.98	
HT20	MCS 0	1	116	5580	18.65	23.25	23.71	29.71	23.98	
HT20	MCS 0	1	140	5700	18.8	23.4	23.74	29.74	23.98	
HT40	MCS 0	1	102	5510	36.5	41.31	23.98	30.00	23.98	
HT40	MCS 0	1	110	5550	36.5	41.49	23.98	30.00	23.98	
HT40	MCS 0	1	134	5670	36.5	41.4	23.98	30.00	23.98	
VHT20	MCS 0	1	100	5500	18.85	23.25	23.75	29.75	23.98	
VHT20	MCS 0	1	116	5580	18.8	23.15	23.74	29.74	23.98	
VHT20	MCS 0	1	140	5700	18.95	23	23.78	29.78	23.98	
VHT40	MCS 0	1	102	5510	36.5	41.31	23.98	30.00	23.98	
VHT40	MCS 0	1	110	5550	36.6	41.31	23.98	30.00	23.98	
VHT40	MCS 0	1	134	5670	36.6	41.13	23.98	30.00	23.98	
VHT80	MCS 0	1	106	5530	75.72	82.08	23.98	30.00	23.98	
VHT80	MCS 0	1	122	5610	75.72	82.56	23.98	30.00	23.98	

**TEST RESULTS DATA**  
**Average Power Table**

FCC Band III										
Mod.	Data Rate	NTX	CH.	Freq. (MHz)	Duty Factor (dB)	Average Conducted Power (dBm)	FCC Conducted Power Limit (dBm)	DG (dBi)		Pass/Fail
11a	6M bps	1	100	5500	0.09	12.55	23.98	-2.85		Pass
11a	6M bps	1	116	5580	0.09	12.54	23.98	-2.85		Pass
11a	6M bps	1	140	5700	0.09	12.66	23.98	-2.85		Pass
HT20	MCS 0	1	100	5500	0.05	12.60	23.98	-2.85		Pass
HT20	MCS 0	1	116	5580	0.05	12.51	23.98	-2.85		Pass
HT20	MCS 0	1	140	5700	0.05	12.67	23.98	-2.85		Pass
HT40	MCS 0	1	102	5510	0.20	12.66	23.98	-2.85		Pass
HT40	MCS 0	1	110	5550	0.20	12.30	23.98	-2.85		Pass
HT40	MCS 0	1	134	5670	0.20	12.90	23.98	-2.85		Pass
VHT20	MCS 0	1	100	5500	0.05	12.34	23.98	-2.85		Pass
VHT20	MCS 0	1	116	5580	0.05	12.30	23.98	-2.85		Pass
VHT20	MCS 0	1	140	5700	0.05	12.76	23.98	-2.85		Pass
VHT40	MCS 0	1	102	5510	0.25	12.68	23.98	-2.85		Pass
VHT40	MCS 0	1	110	5550	0.25	12.33	23.98	-2.85		Pass
VHT40	MCS 0	1	134	5670	0.25	12.85	23.98	-2.85		Pass
VHT80	MCS 0	1	106	5530	0.44	12.89	23.98	-2.85		Pass
VHT80	MCS 0	1	122	5610	0.44	12.69	23.98	-2.85		Pass

**TEST RESULTS DATA**  
**Power Spectral Density**

Band III										
Mod.	Data Rate	NTX	CH.	Freq. (MHz)	Duty Factor (dB)	Average Power Density (dBm/MHz)	Average PSD Limit (dBm/MHz)	DG (dBi)		Pass/Fail
11a	6M bps	1	100	5500	0.09	2.12	11.00	-2.85		Pass
11a	6M bps	1	116	5580	0.09	2.07	11.00	-2.85		Pass
11a	6M bps	1	140	5700	0.09	0.59	11.00	-2.85		Pass
HT20	MCS 0	1	100	5500	0.05	1.93	11.00	-2.85		Pass
HT20	MCS 0	1	116	5580	0.05	1.89	11.00	-2.85		Pass
HT20	MCS 0	1	140	5700	0.05	0.21	11.00	-2.85		Pass
HT40	MCS 0	1	102	5510	0.20	-1.08	11.00	-2.85		Pass
HT40	MCS 0	1	110	5550	0.20	-1.04	11.00	-2.85		Pass
HT40	MCS 0	1	134	5670	0.20	-2.55	11.00	-2.85		Pass
VHT20	MCS 0	1	100	5500	0.05	2.31	11.00	-2.85		Pass
VHT20	MCS 0	1	116	5580	0.05	2.57	11.00	-2.85		Pass
VHT20	MCS 0	1	140	5700	0.05	0.89	11.00	-2.85		Pass
VHT40	MCS 0	1	102	5510	0.25	-0.18	11.00	-2.85		Pass
VHT40	MCS 0	1	110	5550	0.25	-0.24	11.00	-2.85		Pass
VHT40	MCS 0	1	134	5670	0.25	-1.70	11.00	-2.85		Pass
VHT80	MCS 0	1	106	5530	0.44	-2.81	11.00	-2.85		Pass
VHT80	MCS 0	1	122	5610	0.44	-3.39	11.00	-2.85		Pass

**TEST RESULTS DATA**  
**26dB and 99% OBW**

Straddle Channel										
Mod.	Data Rate	NTX	CH.	Freq. (MHz)	99% Bandwidth (MHz)	26 dB Bandwidth (MHz)	IC 99% Bandwidth Power Limit (dBm)	IC 99% Bandwidth EIRP Limit (dBm)	FCC 26dB Bandwidth Power Limit (dBm)	Note
11a	6Mbps	1	144	5720	17.85	22.95	-	-	-	
				NII-2C	14	16.5	22.46	28.46	23.17	
				NII-3	3.85	6.45	30.00	36.00	30.00	
HT20	MCS0	1	144	5720	18.85	23.20	-	-	-	
				NII-2C	14.45	16.7	22.60	28.60	23.23	
				NII-3	4.4	6.5	30.00	36.00	30.00	
HT40	MCS0	1	142	5710	36.50	41.04	-	-	-	
				NII-2C	33.3	35.61	23.98	30.00	23.98	
				NII-3	3.2	5.43	30.00	36.00	30.00	
VHT20	MCS0	1	144	5720	18.80	23.20	-	-	-	
				NII-2C	14.45	16.65	22.60	28.60	23.21	
				NII-3	4.35	6.55	30.00	36.00	30.00	
VHT40	MCS0	1	142	5710	36.60	41.31	-	-	-	
				NII-2C	33.3	35.7	23.98	30.00	23.98	
				NII-3	3.3	5.61	30.00	36.00	30.00	
VHT80	MCS0	1	138	5690	75.84	82.08	-	-	-	
				NII-2C	72.92	75.96	23.98	30.00	23.98	
				NII-3	2.92	6.12	30.00	36.00	30.00	

**TEST RESULTS DATA**  
**Average Power Table**

FCC Straddle Channel										
Mod.	Data Rate	NTX	CH.	Freq. (MHz)	Duty Factor (dB)	Average Conducted Power (dBm)	FCC Conducted Power Limit (dBm)	DG (dBi)		Pass/Fail
11a	6Mbps	1	144	5720	0.09	12.65	-	-2.85		Pass
				NII-2C	0.09	11.90	23.17	-2.85	Pass	
				NII-3	0.09	4.63	30.00	-2.85	Pass	
HT20	MCS0	1	144	5720	0.05	12.66	-	-2.85		Pass
				NII-2C	0.05	11.82	23.23	-2.85	Pass	
				NII-3	0.05	5.10	30.00	-2.85	Pass	
HT40	MCS0	1	142	5710	0.20	12.89	-	-2.85		Pass
				NII-2C	0.20	12.58	23.98	-2.85	Pass	
				NII-3	0.20	1.29	30.00	-2.85	Pass	
VHT20	MCS0	1	144	5720	0.05	12.72	-	-2.85		Pass
				NII-2C	0.05	11.89	23.21	-2.85	Pass	
				NII-3	0.05	5.12	30.00	-2.85	Pass	
VHT40	MCS0	1	142	5710	0.25	12.83	-	-2.85		Pass
				NII-2C	0.25	12.52	23.98	-2.85	Pass	
				NII-3	0.25	1.26	30.00	-2.85	Pass	
VHT80	MCS0	1	138	5690	0.44	12.66	-	-2.85		Pass
				NII-2C	0.44	12.55	23.98	-2.85	Pass	
				NII-3	0.44	-3.34	30.00	-2.85	Pass	

**TEST RESULTS DATA**  
**Power Spectral Density**

Straddle Channel										
Mod.	Data Rate	N <sub>TX</sub>	CH.	Freq. (MHz)	Duty Factor (dB)	Average Power Density (dBm/MHz)	Average PSD Limit (dBm/MHz)	DG (dBi)		Pass/Fail
11a	6Mbps	1	144	NII-2C	0.09	1.45	11.00	-2.85		Pass
				NII-3	0.09	1.45	30.00	-2.85		Pass
HT20	MCS0	1	144	NII-2C	0.05	1.15	11.00	-2.85		Pass
				NII-3	0.05	1.15	30.00	-2.85		Pass
HT40	MCS0	1	142	NII-2C	0.20	-1.50	11.00	-2.85		Pass
				NII-3	0.20	-1.50	30.00	-2.85		Pass
VHT20	MCS0	1	144	NII-2C	0.05	1.21	11.00	-2.85		Pass
				NII-3	0.05	1.21	30.00	-2.85		Pass
VHT40	MCS0	1	142	NII-2C	0.25	-1.69	11.00	-2.85		Pass
				NII-3	0.25	-1.69	30.00	-2.85		Pass
VHT80	MCS0	1	138	NII-2C	0.44	-4.64	11.00	-2.85		Pass
				NII-3	0.44	-4.64	30.00	-2.85		Pass



**TEST RESULTS DATA**  
**Frequency Stability**

Band I										
Mod.	Data Rate	NTX	CH.	Freq. (MHz)	Center Frequency (MHz)	Frequency Deviation (MHz)	Frequency Stability (ppm)	Temperature (°C)	Voltage (V)	Note
11a	6Mbps	1	36	5180	5180.000	0.000	0.00	20	3.6	
11a	6Mbps	1	36	5180	5180.000	0.000	0.00	20	4.2	
11a	6Mbps	1	36	5180	5180.000	0.000	0.00	20	3.8	
11a	6Mbps	1	36	5180	5180.000	0.000	0.00	-10	3.8	
11a	6Mbps	1	36	5180	5180.000	0.000	0.00	55	3.8	

Band II										
Mod.	Data Rate	NTX	CH.	Freq. (MHz)	Center Frequency (MHz)	Frequency Deviation (MHz)	Frequency Stability (ppm)	Temperature (°C)	Voltage (V)	Note
11a	6Mbps	1	64	5320	5320.000	0.000	0.00	20	3.6	
11a	6Mbps	1	64	5320	5320.000	0.000	0.00	20	4.2	
11a	6Mbps	1	64	5320	5320.000	0.000	0.00	20	3.8	
11a	6Mbps	1	64	5320	5320.100	0.100	18.80	-10	3.8	
11a	6Mbps	1	64	5320	5320.000	0.000	0.00	55	3.8	

Band III										
Mod.	Data Rate	NTX	CH.	Freq. (MHz)	Center Frequency (MHz)	Frequency Deviation (MHz)	Frequency Stability (ppm)	Temperature (°C)	Voltage (V)	Note
11a	6Mbps	1	100	5500	5500.000	0.000	0.00	20	3.6	
11a	6Mbps	1	100	5500	5500.000	0.000	0.00	20	4.2	
11a	6Mbps	1	100	5500	5500.000	0.000	0.00	20	3.8	
11a	6Mbps	1	100	5500	5500.050	0.050	9.09	-10	3.8	
11a	6Mbps	1	100	5500	5500.000	0.000	0.00	55	3.8	



## Appendix B. Radiated Spurious Emission

Test Engineer :	Wei Chen, Ken Wu and James Chiu	Temperature :	21~23°C
		Relative Humidity :	60~63%

15E Band 1 5150~5250MHz

WIFI 802.11a (Band Edge @ 3m)

WIFI	Note	Frequency	Level	Over	Limit	Read	Antenna	Cable	Preamp	Ant	Table	Peak	Pol.	
Ant.				Limit	Line	Level	Factor	Loss	Factor	Pos	Pos	Avg.		
1		( MHz )	( dBµV/m )	( dB )	( dBµV/m )	( dBµV )	( dB/m )	( dB )	( dB )	( cm )	( deg )	( P/A )	( H/V )	
802.11a CH 36 5180MHz		5149.55	65.45	-8.55	74	51.78	34.61	11.55	32.49	249	353	P	H	
		5150	45.3	-8.7	54	31.63	34.61	11.55	32.49	249	353	A	H	
	*	5180	107.53	-	-	93.84	34.66	11.55	32.52	249	353	P	H	
	*	5180	96.9	-	-	83.21	34.66	11.55	32.52	249	353	A	H	
													H	
													H	
			5145.65	58.09	-15.91	74	44.42	34.61	11.55	32.49	108	114	P	V
			5149.4	43.4	-10.6	54	29.73	34.61	11.55	32.49	108	114	A	V
	*		5180	101.01	-	-	87.32	34.66	11.55	32.52	108	114	P	V
	*		5180	90.38	-	-	76.69	34.66	11.55	32.52	108	114	A	V
														V
														V
802.11a CH 44 5220MHz		5113.85	57.49	-16.51	74	43.85	34.56	11.5	32.42	233	354	P	H	
		5150	43.31	-10.69	54	29.64	34.61	11.55	32.49	233	354	A	H	
	*	5220	108.25	-	-	94.51	34.7	11.59	32.55	233	354	P	H	
	*	5220	97.63	-	-	83.89	34.7	11.59	32.55	233	354	A	H	
			5424.47	57.08	-16.92	74	43.78	34.98	11.8	33.48	233	354	P	H
			5405.99	43.3	-10.7	54	29.99	34.96	11.74	33.39	233	354	A	H
			5082.05	57.23	-16.77	74	43.64	34.52	11.46	32.39	379	44	P	V
			5149.25	42.92	-11.08	54	29.25	34.61	11.55	32.49	379	44	A	V
	*		5220	102.96	-	-	89.22	34.7	11.59	32.55	379	44	P	V
	*		5220	92.57	-	-	78.83	34.7	11.59	32.55	379	44	A	V
			5351.32	56.72	-17.28	74	43.3	34.89	11.71	33.18	379	44	P	V
			5390.15	43.16	-10.84	54	29.76	34.94	11.74	33.28	379	44	A	V



<b>802.11a</b> <b>CH 48</b> <b>5240MHz</b>	*	5240	108.23	-	-	94.53	34.73	11.62	32.65	206	354	P	H
	*	5240	97.46	-	-	83.76	34.73	11.62	32.65	206	354	A	H
		5390.81	56.83	-17.17	74	43.43	34.94	11.74	33.28	206	354	P	H
		5397.3	43.19	-10.81	54	29.77	34.96	11.74	33.28	206	354	A	H
													H
													H
	*	5240	102.25	-	-	88.55	34.73	11.62	32.65	376	43	P	V
	*	5240	91.75	-	-	78.05	34.73	11.62	32.65	376	43	A	V
		5405.99	57.44	-16.56	74	44.13	34.96	11.74	33.39	376	43	P	V
		5395.1	43.17	-10.83	54	29.75	34.96	11.74	33.28	376	43	A	V
													V
													V
<b>Remark</b>	1. No other spurious found. 2. All results are PASS against Peak and Average limit line.												



15E Band 1 5150~5250MHz  
WIFI 802.11a (Harmonic @ 3m)

WIFI	Note	Frequency	Level	Over	Limit	Read	Antenna	Cable	Preamp	Ant	Table	Peak	Pol.
Ant.				Limit	Line	Level	Factor	Loss	Factor	Pos	Pos	Avg.	
1		( MHz )	( dBµV/m )	( dB )	( dBµV/m )	(dBµV)	( dB/m )	( dB )	( dB )	( cm )	( deg )	(P/A)	(H/V)
802.11a CH 36 5180MHz		10360	42.06	-31.94	74	48.41	37.22	16.34	59.91	100	0	P	H
		15540	47.16	-26.84	74	44.34	40.34	20.36	57.88	100	0	P	H
													H
													H
		10360	41.37	-32.63	74	47.72	37.22	16.34	59.91	100	0	P	V
		15540	47.74	-26.26	74	44.92	40.34	20.36	57.88	100	0	P	V
													V
													V
802.11a CH 44 5220MHz		10440	41.82	-32.18	74	48	37.26	16.41	59.85	100	0	P	H
		15660	46.66	-27.34	74	43.57	40.49	20.41	57.81	100	0	P	H
													H
													H
		10440	41.26	-32.74	74	47.44	37.26	16.41	59.85	100	0	P	V
		15660	46.42	-27.58	74	43.33	40.49	20.41	57.81	100	0	P	V
													V
													V
802.11a CH 48 5240MHz		10480	42.72	-31.28	74	48.79	37.29	16.45	59.81	100	0	P	H
		15720	48.21	-25.79	74	44.96	40.57	20.45	57.77	100	0	P	H
													H
													H
		10480	42	-32	74	48.07	37.29	16.45	59.81	100	0	P	V
		15720	48.04	-25.96	74	44.79	40.57	20.45	57.77	100	0	P	V
													V
													V
Remark	1. No other spurious found. 2. All results are PASS against Peak and Average limit line.												



**15E Band 1 5150~5250MHz  
WIFI 802.11n HT20 (Band Edge @ 3m)**

WIFI	Note	Frequency	Level	Over	Limit	Read	Antenna	Cable	Preamp	Ant	Table	Peak	Pol.	
Ant.				Limit	Line	Level	Factor	Loss	Factor	Pos	Pos	Avg.		
1		( MHz )	( dBμV/m )	( dB )	( dBμV/m )	( dBμV )	( dB/m )	( dB )	( dB )	( cm )	( deg )	(P/A)	(H/V)	
802.11n HT20 CH 36 5180MHz		5150	65.04	-8.96	74	51.37	34.61	11.55	32.49	222	352	P	H	
		5150	46	-8	54	32.33	34.61	11.55	32.49	222	352	A	H	
	*	5180	109.58	-	-	95.89	34.66	11.55	32.52	222	352	P	H	
	*	5180	97.59	-	-	83.9	34.66	11.55	32.52	222	352	A	H	
													H	
													H	
			5145.35	61.46	-12.54	74	47.79	34.61	11.55	32.49	102	100	P	V
			5149.85	43.97	-10.03	54	30.3	34.61	11.55	32.49	102	100	A	V
	*		5180	103.62	-	-	89.93	34.66	11.55	32.52	102	100	P	V
	*		5180	91.72	-	-	78.03	34.66	11.55	32.52	102	100	A	V
													V	
													V	
802.11n HT20 CH 44 5220MHz		5143.1	57.29	-16.71	74	43.58	34.61	11.55	32.45	205	352	P	H	
		5149.55	43.37	-10.63	54	29.7	34.61	11.55	32.49	205	352	A	H	
	*	5220	109.86	-	-	96.12	34.7	11.59	32.55	205	352	P	H	
	*	5220	97.05	-	-	83.31	34.7	11.59	32.55	205	352	A	H	
			5353.74	57.41	-16.59	74	43.99	34.89	11.71	33.18	205	352	P	H
			5405.55	43.31	-10.69	54	30	34.96	11.74	33.39	205	352	A	H
			5001.2	56.76	-17.24	74	43.28	34.4	11.37	32.29	122	100	P	V
			5149.1	42.95	-11.05	54	29.28	34.61	11.55	32.49	122	100	A	V
	*		5220	103.12	-	-	89.38	34.7	11.59	32.55	122	100	P	V
	*		5220	90.43	-	-	76.69	34.7	11.59	32.55	122	100	A	V
		5409.84	56.75	-17.25	74	43.44	34.96	11.74	33.39	122	100	P	V	
		5383	43.11	-10.89	54	29.71	34.94	11.74	33.28	122	100	A	V	



<b>802.11n</b> <b>HT20</b> <b>CH 48</b> <b>5240MHz</b>		5110.85	56.77	-17.23	74	43.13	34.56	11.5	32.42	226	356	P	H
		5149.4	42.97	-11.03	54	29.3	34.61	11.55	32.49	226	356	A	H
	*	5240	110.46	-	-	96.76	34.73	11.62	32.65	226	356	P	H
	*	5240	97.27	-	-	83.57	34.73	11.62	32.65	226	356	A	H
		5381.24	56.99	-17.01	74	43.59	34.94	11.74	33.28	226	356	P	H
		5382.78	43.03	-10.97	54	29.63	34.94	11.74	33.28	226	356	A	H
		5148.35	56.83	-17.17	74	43.16	34.61	11.55	32.49	233	7	P	V
		5150	42.75	-11.25	54	29.08	34.61	11.55	32.49	233	7	A	V
	*	5240	104.3	-	-	90.6	34.73	11.62	32.65	233	7	P	V
	*	5240	92.26	-	-	78.56	34.73	11.62	32.65	233	7	A	V
		5406.21	56.56	-17.44	74	43.25	34.96	11.74	33.39	233	7	P	V
	5394.22	43.01	-10.99	54	29.61	34.94	11.74	33.28	233	7	A	V	
<b>Remark</b>	1. No other spurious found. 2. All results are PASS against Peak and Average limit line.												



15E Band 1 5150~5250MHz

WIFI 802.11n HT20 (Harmonic @ 3m)

WIFI	Note	Frequency	Level	Over	Limit	Read	Antenna	Cable	Preamp	Ant	Table	Peak	Pol.
Ant.				Limit	Line	Level	Factor	Loss	Factor	Pos	Pos	Avg.	
1		( MHz )	( dBμV/m )	( dB )	( dBμV/m )	( dBμV )	( dB/m )	( dB )	( dB )	( cm )	( deg )	( P/A )	( H/V )
802.11n HT20 CH 36 5180MHz		10360	42.25	-31.75	74	48.6	37.22	16.34	59.91	100	0	P	H
		15540	48.14	-25.86	74	45.32	40.34	20.36	57.88	100	0	P	H
													H
													H
		10360	41.1	-32.9	74	47.45	37.22	16.34	59.91	100	0	P	V
		15540	48.1	-25.9	74	45.28	40.34	20.36	57.88	100	0	P	V
													V
802.11n HT20 CH 44 5220MHz		10440	42.15	-31.85	74	48.33	37.26	16.41	59.85	100	0	P	H
		15660	46.84	-27.16	74	43.75	40.49	20.41	57.81	100	0	P	H
													H
													H
		10440	41.31	-32.69	74	47.49	37.26	16.41	59.85	100	0	P	V
		15660	47.76	-26.24	74	44.67	40.49	20.41	57.81	100	0	P	V
													V
802.11n HT20 CH 48 5240MHz		10480	42.45	-31.55	74	48.52	37.29	16.45	59.81	100	0	P	H
		15720	48.84	-25.16	74	45.59	40.57	20.45	57.77	100	0	P	H
													H
													H
		10480	41.39	-32.61	74	47.46	37.29	16.45	59.81	100	0	P	V
		15720	48.48	-25.52	74	45.23	40.57	20.45	57.77	100	0	P	V
													V
Remark	1. No other spurious found.												
	2. All results are PASS against Peak and Average limit line.												



**15E Band 1 5150~5250MHz  
WIFI 802.11n HT40 (Band Edge @ 3m)**

WIFI	Note	Frequency	Level	Over	Limit	Read	Antenna	Cable	Preamp	Ant	Table	Peak	Pol.
Ant.				Limit	Line	Level	Factor	Loss	Factor	Pos	Pos	Avg.	
1		( MHz )	( dBμV/m )	( dB )	( dBμV/m )	( dBμV )	( dB/m )	( dB )	( dB )	( cm )	( deg )	( P/A )	( H/V )
802.11n HT40 CH 38 5190MHz		5149.7	69.51	-4.49	74	55.84	34.61	11.55	32.49	225	355	P	H
		5149.55	52.49	-1.51	54	38.82	34.61	11.55	32.49	225	355	A	H
	*	5190	106.35	-	-	92.62	34.66	11.59	32.52	225	355	P	H
	*	5190	95.63	-	-	81.9	34.66	11.59	32.52	225	355	A	H
		5365.95	56.46	-17.54	74	43.02	34.91	11.71	33.18	225	355	P	H
		5383.22	43.24	-10.76	54	29.84	34.94	11.74	33.28	225	355	A	H
		5150	63.83	-10.17	74	50.16	34.61	11.55	32.49	127	111	P	V
		5150	47.45	-6.55	54	33.78	34.61	11.55	32.49	127	111	A	V
	*	5190	98.52	-	-	84.79	34.66	11.59	32.52	127	111	P	V
	*	5190	88.23	-	-	74.5	34.66	11.59	32.52	127	111	A	V
		5386.85	56	-18	74	42.6	34.94	11.74	33.28	127	111	P	V
		5374.64	43.11	-10.89	54	29.77	34.91	11.71	33.28	127	111	A	V
802.11n HT40 CH 46 5230MHz		5149.1	57.78	-16.22	74	44.11	34.61	11.55	32.49	219	354	P	H
		5149.85	44.62	-9.38	54	30.95	34.61	11.55	32.49	219	354	A	H
	*	5230	106.24	-	-	92.54	34.73	11.62	32.65	219	354	P	H
	*	5230	95.45	-	-	81.75	34.73	11.62	32.65	219	354	A	H
		5358.8	57.17	-16.83	74	43.75	34.89	11.71	33.18	219	354	P	H
		5351.54	44.1	-9.9	54	30.68	34.89	11.71	33.18	219	354	A	H
		5139.8	57.1	-16.9	74	43.44	34.61	11.5	32.45	115	96	P	V
		5148.65	43.94	-10.06	54	30.27	34.61	11.55	32.49	115	96	A	V
	*	5230	100.23	-	-	86.53	34.73	11.62	32.65	115	96	P	V
	*	5230	89.44	-	-	75.74	34.73	11.62	32.65	115	96	A	V
		5399.39	57.46	-16.54	74	44.15	34.96	11.74	33.39	115	96	P	V
		5396.97	43.91	-10.09	54	30.49	34.96	11.74	33.28	115	96	A	V
Remark	1. No other spurious found. 2. All results are PASS against Peak and Average limit line.												





15E Band 1 5150~5250MHz

WIFI 802.11n HT40 (Harmonic @ 3m)

WIFI	Note	Frequency	Level	Over	Limit	Read	Antenna	Cable	Preamp	Ant	Table	Peak	Pol.
Ant.				Limit	Line	Level	Factor	Loss	Factor	Pos	Pos	Avg.	
1		( MHz )	( dBμV/m )	( dB )	( dBμV/m )	( dBμV )	( dB/m )	( dB )	( dB )	( cm )	( deg )	(P/A)	(H/V)
802.11n HT40 CH 38 5190MHz		10380	42.23	-31.77	74	48.55	37.23	16.34	59.89	100	0	P	H
		15570	48.68	-25.32	74	45.78	40.38	20.38	57.86	100	0	P	H
													H
													H
		10380	41.88	-32.12	74	48.2	37.23	16.34	59.89	100	0	P	V
		15570	48.49	-25.51	74	45.59	40.38	20.38	57.86	100	0	P	V
													V
802.11n HT40 CH 46 5230MHz		10460	42.66	-31.34	74	48.82	37.27	16.41	59.84	100	0	P	H
		15690	48.17	-25.83	74	45	40.53	20.43	57.79	100	0	P	H
													H
													H
		10460	41.96	-32.04	74	48.12	37.27	16.41	59.84	100	0	P	V
		15690	48.9	-25.1	74	45.73	40.53	20.43	57.79	100	0	P	V
													V
Remark	1. No other spurious found.												
	2. All results are PASS against Peak and Average limit line.												



15E Band 1 5150~5250MHz

WIFI 802.11ac VHT80 (Band Edge @ 3m)

WIFI	Note	Frequency	Level	Over	Limit	Read	Antenna	Cable	Preamp	Ant	Table	Peak	Pol.
Ant.				Limit	Line	Level	Factor	Loss	Factor	Pos	Pos	Avg.	
1		( MHz )	( dBμV/m )	( dB )	( dBμV/m )	( dBμV )	( dB/m )	( dB )	( dB )	( cm )	( deg )	( P/A )	( H/V )
802.11ac VHT80 CH 42 5210MHz		5148.8	67.37	-6.63	74	53.7	34.61	11.55	32.49	234	354	P	H
		5150	52.74	-1.26	54	39.07	34.61	11.55	32.49	234	354	A	H
	*	5210	101.95	-	-	88.21	34.7	11.59	32.55	234	354	P	H
	*	5210	91.95	-	-	78.21	34.7	11.59	32.55	234	354	A	H
		5372.66	56.85	-17.15	74	43.41	34.91	11.71	33.18	234	354	P	H
		5354.95	44.08	-9.92	54	30.66	34.89	11.71	33.18	234	354	A	H
		5147.75	61.78	-12.22	74	48.11	34.61	11.55	32.49	220	308	P	V
		5146.1	47.91	-6.09	54	34.24	34.61	11.55	32.49	220	308	A	V
	*	5210	96.29	-	-	82.55	34.7	11.59	32.55	220	308	P	V
	*	5210	86.13	-	-	72.39	34.7	11.59	32.55	220	308	A	V
		5408.3	56.98	-17.02	74	43.67	34.96	11.74	33.39	220	308	P	V
	5389.82	43.21	-10.79	54	29.81	34.94	11.74	33.28	220	308	A	V	
Remark	1. No other spurious found. 2. All results are PASS against Peak and Average limit line.												

15E Band 1 5150~5250MHz

WIFI 802.11ac VHT80 (Harmonic @ 3m)

WIFI	Note	Frequency	Level	Over	Limit	Read	Antenna	Cable	Preamp	Ant	Table	Peak	Pol.
Ant.				Limit	Line	Level	Factor	Loss	Factor	Pos	Pos	Avg.	
1		( MHz )	( dBμV/m )	( dB )	( dBμV/m )	( dBμV )	( dB/m )	( dB )	( dB )	( cm )	( deg )	( P/A )	( H/V )
802.11ac VHT80 CH 42 5210MHz		10420	41.96	-32.04	74	48.21	37.25	16.37	59.87	100	0	P	H
		15630	46.32	-27.68	74	43.26	40.47	20.41	57.82	100	0	P	H
													H
													H
		10420	42.17	-31.83	74	48.42	37.25	16.37	59.87	100	0	P	V
		15630	47.37	-26.63	74	44.31	40.47	20.41	57.82	100	0	P	V
													V
													V
Remark	1. No other spurious found. 2. All results are PASS against Peak and Average limit line.												



15E Band 2 5250~5350MHz  
WIFI 802.11a (Band Edge @ 3m)

WIFI	Note	Frequency	Level	Over	Limit	Read	Antenna	Cable	Preamp	Ant	Table	Peak	Pol.	
Ant.				Limit	Line	Level	Factor	Loss	Factor	Pos	Pos	Avg.		
1		( MHz )	( dBµV/m )	( dB )	( dBµV/m )	( dBµV )	( dB/m )	( dB )	( dB )	( cm )	( deg )	( P/A )	( H/V )	
802.11a CH 52 5260MHz		5141.75	57.05	-16.95	74	43.34	34.61	11.55	32.45	241	355	P	H	
		5149.7	43.03	-10.97	54	29.36	34.61	11.55	32.49	241	355	A	H	
	*	5260	108.27	-	-	94.64	34.77	11.62	32.76	241	355	P	H	
	*	5260	97.54	-	-	83.91	34.77	11.62	32.76	241	355	A	H	
													A	H
														H
			5031.95	57.08	-16.92	74	43.54	34.45	11.41	32.32	370	45	P	V
			5146.7	42.94	-11.06	54	29.27	34.61	11.55	32.49	370	45	A	V
	*		5260	103	-	-	89.37	34.77	11.62	32.76	370	45	P	V
	*		5260	92.33	-	-	78.7	34.77	11.62	32.76	370	45	A	V
														V
														V
802.11a CH 60 5300MHz		5132.15	57.54	-16.46	74	43.9	34.59	11.5	32.45	249	350	P	H	
		5150	43.02	-10.98	54	29.35	34.61	11.55	32.49	249	350	A	H	
	*	5300	106.47	-	-	92.97	34.82	11.65	32.97	249	350	P	H	
	*	5300	96.17	-	-	82.67	34.82	11.65	32.97	249	350	A	H	
			5431.07	57.74	-16.26	74	44.41	35.01	11.8	33.48	249	350	P	H
			5350.44	43.64	-10.36	54	30.22	34.89	11.71	33.18	249	350	A	H
			5136.5	57.64	-16.36	74	44	34.59	11.5	32.45	231	13	P	V
			5148.5	42.91	-11.09	54	29.24	34.61	11.55	32.49	231	13	A	V
	*		5300	102.63	-	-	89.13	34.82	11.65	32.97	231	13	P	V
	*		5300	91.78	-	-	78.28	34.82	11.65	32.97	231	13	A	V
			5392.9	57.37	-16.63	74	43.97	34.94	11.74	33.28	231	13	P	V
			5351.21	43.37	-10.63	54	29.95	34.89	11.71	33.18	231	13	A	V



<b>802.11a</b> <b>CH 64</b> <b>5320MHz</b>	*	5320	107.53	-	-	93.98	34.84	11.68	32.97	239	354	P	H
	*	5320	96.69	-	-	83.14	34.84	11.68	32.97	239	354	A	H
		5351.1	61.57	-12.43	74	48.15	34.89	11.71	33.18	239	354	P	H
		5350.11	45.36	-8.64	54	31.94	34.89	11.71	33.18	239	354	A	H
													H
													H
	*	5320	102.48	-	-	88.93	34.84	11.68	32.97	103	13	P	V
	*	5320	90.93	-	-	77.38	34.84	11.68	32.97	103	13	A	V
		5350.33	58.64	-15.36	74	45.22	34.89	11.71	33.18	103	13	P	V
		5350.33	43.88	-10.12	54	30.46	34.89	11.71	33.18	103	13	A	V
													V
													V
<b>Remark</b>	1. No other spurious found. 2. All results are PASS against Peak and Average limit line.												



15E Band 2 5250~5350MHz  
WIFI 802.11a (Harmonic @ 3m)

WIFI	Note	Frequency	Level	Over	Limit	Read	Antenna	Cable	Preamp	Ant	Table	Peak	Pol.
Ant.				Limit	Line	Level	Factor	Loss	Factor	Pos	Pos	Avg.	
1		( MHz )	( dBµV/m )	( dB )	( dBµV/m )	( dBµV )	( dB/m )	( dB )	( dB )	( cm )	( deg )	( P/A )	( H/V )
802.11a CH 52 5260MHz		10520	42.91	-31.09	74	48.88	37.32	16.49	59.78	100	0	P	H
		15780	48.31	-25.69	74	44.95	40.63	20.46	57.73	100	0	P	H
													H
													H
		10520	42.12	-31.88	74	48.09	37.32	16.49	59.78	100	0	P	V
		15780	48.29	-25.71	74	44.93	40.63	20.46	57.73	100	0	P	V
													V
													V
802.11a CH 60 5300MHz		10600	41.8	-32.2	74	47.48	37.42	16.56	59.66	100	0	P	H
		15900	48.26	-25.74	74	44.62	40.78	20.52	57.66	100	0	P	H
													H
													H
		10600	41.68	-32.32	74	47.36	37.42	16.56	59.66	100	0	P	V
		15900	48.7	-25.3	74	45.06	40.78	20.52	57.66	100	0	P	V
													V
													V
802.11a CH 64 5320MHz		10640	42.21	-31.79	74	47.75	37.47	16.6	59.61	100	0	P	H
		15960	48.34	-25.66	74	44.55	40.86	20.55	57.62	100	0	P	H
													H
													H
		10640	41.85	-32.15	74	47.39	37.47	16.6	59.61	100	0	P	V
		15960	47.92	-26.08	74	44.13	40.86	20.55	57.62	100	0	P	V
													V
													V
Remark	1. No other spurious found. 2. All results are PASS against Peak and Average limit line.												



**15E Band 2 5250~5350MHz  
WIFI 802.11n HT20 (Band Edge @ 3m)**

WIFI	Note	Frequency	Level	Over	Limit	Read	Antenna	Cable	Preamp	Ant	Table	Peak	Pol.
Ant.				Limit	Line	Level	Factor	Loss	Factor	Pos	Pos	Avg.	
1		( MHz )	( dBμV/m )	( dB )	( dBμV/m )	( dBμV )	( dB/m )	( dB )	( dB )	( cm )	( deg )	(P/A)	(H/V)
802.11n HT20 CH 52 5260MHz		5149.7	57.67	-16.33	74	44	34.61	11.55	32.49	214	355	P	H
		5150	42.85	-11.15	54	29.18	34.61	11.55	32.49	214	355	A	H
	*	5260	110.7	-	-	97.07	34.77	11.62	32.76	214	355	P	H
	*	5260	97.34	-	-	83.71	34.77	11.62	32.76	214	355	A	H
		5439.54	56.78	-17.22	74	43.45	35.01	11.8	33.48	214	355	P	H
		5383.88	43.05	-10.95	54	29.65	34.94	11.74	33.28	214	355	A	H
		5012.45	57.15	-16.85	74	43.65	34.42	11.37	32.29	102	17	P	V
		5149.7	42.66	-11.34	54	28.99	34.61	11.55	32.49	102	17	A	V
	*	5260	102.46	-	-	88.83	34.77	11.62	32.76	102	17	P	V
	*	5260	90.23	-	-	76.6	34.77	11.62	32.76	102	17	A	V
		5426.67	57.08	-16.92	74	43.78	34.98	11.8	33.48	102	17	P	V
		5388.17	42.99	-11.01	54	29.59	34.94	11.74	33.28	102	17	A	V
802.11n HT20 CH 60 5300MHz		5042.9	56.77	-17.23	74	43.24	34.47	11.41	32.35	214	357	P	H
		5148.35	42.74	-11.26	54	29.07	34.61	11.55	32.49	214	357	A	H
	*	5300	108.46	-	-	94.96	34.82	11.65	32.97	214	357	P	H
	*	5300	96.2	-	-	82.7	34.82	11.65	32.97	214	357	A	H
		5354.73	56.92	-17.08	74	43.5	34.89	11.71	33.18	214	357	P	H
		5350.44	43.58	-10.42	54	30.16	34.89	11.71	33.18	214	357	A	H
		5087	56.67	-17.33	74	43.08	34.52	11.46	32.39	232	11	P	V
		5149.1	42.65	-11.35	54	28.98	34.61	11.55	32.49	232	11	A	V
	*	5300	104.38	-	-	90.88	34.82	11.65	32.97	232	11	P	V
	*	5300	92.01	-	-	78.51	34.82	11.65	32.97	232	11	A	V
		5381.79	56.85	-17.15	74	43.45	34.94	11.74	33.28	232	11	P	V
		5350.66	43.18	-10.82	54	29.76	34.89	11.71	33.18	232	11	A	V



<b>802.11n HT20 CH 64 5320MHz</b>	*	5320	108.18	-	-	94.63	34.84	11.68	32.97	224	356	P	H
	*	5320	96.02	-	-	82.47	34.84	11.68	32.97	224	356	A	H
		5350.44	60.81	-13.19	74	47.39	34.89	11.71	33.18	224	356	P	H
		5350	44.7	-9.3	54	31.28	34.89	11.71	33.18	224	356	A	H
													H
													H
	*	5320	103.83	-	-	90.28	34.84	11.68	32.97	220	11	P	V
	*	5320	91.34	-	-	77.79	34.84	11.68	32.97	220	11	A	V
		5355.83	59.23	-14.77	74	45.81	34.89	11.71	33.18	220	11	P	V
		5350.88	43.61	-10.39	54	30.19	34.89	11.71	33.18	220	11	A	V
												V	
												V	
<b>Remark</b>	1. No other spurious found. 2. All results are PASS against Peak and Average limit line.												



15E Band 2 5250~5350MHz

WIFI 802.11n HT20 (Harmonic @ 3m)

WIFI	Note	Frequency	Level	Over	Limit	Read	Antenna	Cable	Preamp	Ant	Table	Peak	Pol.
Ant.				Limit	Line	Level	Factor	Loss	Factor	Pos	Pos	Avg.	
1		( MHz )	( dBµV/m )	( dB )	( dBµV/m )	(dBµV)	( dB/m )	( dB )	( dB )	( cm )	( deg )	(P/A)	(H/V)
802.11n HT20 CH 52 5260MHz		10520	42.75	-31.25	74	48.72	37.32	16.49	59.78	100	0	P	H
		15780	48.83	-25.17	74	45.47	40.63	20.46	57.73	100	0	P	H
													H
													H
		10520	41.88	-32.12	74	47.85	37.32	16.49	59.78	100	0	P	V
		15780	48.97	-25.03	74	45.61	40.63	20.46	57.73	100	0	P	V
													V
802.11n HT20 CH 60 5300MHz		10600	42.09	-31.91	74	47.77	37.42	16.56	59.66	100	0	P	H
		15900	48.27	-25.73	74	44.63	40.78	20.52	57.66	100	0	P	H
													H
													H
		10600	41.56	-32.44	74	47.24	37.42	16.56	59.66	100	0	P	V
		15900	48.94	-25.06	74	45.3	40.78	20.52	57.66	100	0	P	V
													V
802.11n HT20 CH 64 5320MHz		10640	42.17	-31.83	74	47.71	37.47	16.6	59.61	100	0	P	H
		15960	47.47	-26.53	74	43.68	40.86	20.55	57.62	100	0	P	H
													H
													H
		10640	41.57	-32.43	74	47.11	37.47	16.6	59.61	100	0	P	V
		15960	47.3	-26.7	74	43.51	40.86	20.55	57.62	100	0	P	V
													V
Remark	1. No other spurious found.												
	2. All results are PASS against Peak and Average limit line.												





**15E Band 2 5250~5350MHz**  
**WIFI 802.11n HT40 (Band Edge @ 3m)**

WIFI	Note	Frequency	Level	Over	Limit	Read	Antenna	Cable	Preamp	Ant	Table	Peak	Pol.
Ant.				Limit	Line	Level	Factor	Loss	Factor	Pos	Pos	Avg.	
1		( MHz )	( dBμV/m )	( dB )	( dBμV/m )	( dBμV )	( dB/m )	( dB )	( dB )	( cm )	( deg )	( P/A )	( H/V )
802.11n HT40 CH 54 5270MHz		5138.75	57.08	-16.92	74	43.44	34.59	11.5	32.45	229	354	P	H
		5140.25	43.89	-10.11	54	30.18	34.61	11.55	32.45	229	354	A	H
	*	5270	105.91	-	-	92.25	34.77	11.65	32.76	229	354	P	H
	*	5270	95.07	-	-	81.41	34.77	11.65	32.76	229	354	A	H
		5383.66	58.03	-15.97	74	44.63	34.94	11.74	33.28	229	354	P	H
		5360.67	44.41	-9.59	54	30.97	34.91	11.71	33.18	229	354	A	H
		5010.2	56.42	-17.58	74	42.92	34.42	11.37	32.29	103	17	P	V
		5142.5	43.56	-10.44	54	29.85	34.61	11.55	32.45	103	17	A	V
	*	5270	99.58	-	-	85.92	34.77	11.65	32.76	103	17	P	V
	*	5270	88.81	-	-	75.15	34.77	11.65	32.76	103	17	A	V
		5372.77	56.57	-17.43	74	43.13	34.91	11.71	33.18	103	17	P	V
		5366.06	44.01	-9.99	54	30.57	34.91	11.71	33.18	103	17	A	V
802.11n HT40 CH 62 5310MHz		5136.35	56.7	-17.3	74	43.06	34.59	11.5	32.45	235	353	P	H
		5139.8	43.53	-10.47	54	29.87	34.61	11.5	32.45	235	353	A	H
	*	5310	105.37	-	-	91.82	34.84	11.68	32.97	235	353	P	H
	*	5310	94.07	-	-	80.52	34.84	11.68	32.97	235	353	A	H
		5352.2	67.02	-6.98	74	53.6	34.89	11.71	33.18	235	353	P	H
		5350.22	47.7	-6.3	54	34.28	34.89	11.71	33.18	235	353	A	H
		5018	57.24	-16.76	74	43.77	34.42	11.37	32.32	124	17	P	V
		5136.65	43.53	-10.47	54	29.89	34.59	11.5	32.45	124	17	A	V
	*	5313	99.81	-	-	86.26	34.84	11.68	32.97	124	17	P	V
	*	5313	88.78	-	-	75.23	34.84	11.68	32.97	124	17	A	V
		5351.87	64.63	-9.37	74	51.21	34.89	11.71	33.18	124	17	P	V
		5350	45.89	-8.11	54	32.47	34.89	11.71	33.18	124	17	A	V
Remark	1. No other spurious found. 2. All results are PASS against Peak and Average limit line.												



15E Band 2 5250~5350MHz

WIFI 802.11n HT40 (Harmonic @ 3m)

WIFI	Note	Frequency	Level	Over	Limit	Read	Antenna	Cable	Preamp	Ant	Table	Peak	Pol.
Ant.				Limit	Line	Level	Factor	Loss	Factor	Pos	Pos	Avg.	
1		( MHz )	( dBμV/m )	( dB )	( dBμV/m )	(dBμV)	( dB/m )	( dB )	( dB )	( cm )	( deg )	(P/A)	(H/V)
802.11n HT40 CH 54 5270MHz		10540	42.42	-31.58	74	48.34	37.34	16.49	59.75	100	0	P	H
		15810	48.55	-25.45	74	45.11	40.67	20.48	57.71	100	0	P	H
													H
													H
		10540	41.51	-32.49	74	47.43	37.34	16.49	59.75	100	0	P	V
		15810	48.61	-25.39	74	45.17	40.67	20.48	57.71	100	0	P	V
													V
802.11n HT40 CH 62 5310MHz		10620	41.98	-32.02	74	47.61	37.44	16.56	59.63	100	0	P	H
		15930	46.99	-27.01	74	43.28	40.82	20.53	57.64	100	0	P	H
													H
													H
		10620	41.4	-32.6	74	47.03	37.44	16.56	59.63	100	0	P	V
		15930	48.21	-25.79	74	44.5	40.82	20.53	57.64	100	0	P	V
													V
Remark	1. No other spurious found.												
	2. All results are PASS against Peak and Average limit line.												



15E Band 2 5250~5350MHz

WIFI 802.11ac VHT80 (Band Edge @ 3m)

WIFI	Note	Frequency	Level	Over	Limit	Read	Antenna	Cable	Preamp	Ant	Table	Peak	Pol.
Ant.				Limit	Line	Level	Factor	Loss	Factor	Pos	Pos	Avg.	
1		( MHz )	( dBμV/m )	( dB )	( dBμV/m )	( dBμV )	( dB/m )	( dB )	( dB )	( cm )	( deg )	( P/A )	( H/V )
802.11ac VHT80 CH 58 5290MHz		5145.95	58.23	-15.77	74	44.56	34.61	11.55	32.49	252	9	P	H
		5144.45	45.52	-8.48	54	31.85	34.61	11.55	32.49	252	9	A	H
	*	5290	102.58	-	-	88.99	34.8	11.65	32.86	252	9	P	H
	*	5290	92.88	-	-	79.29	34.8	11.65	32.86	252	9	A	H
		5353.52	67.69	-6.31	74	54.27	34.89	11.71	33.18	252	9	P	H
		5351.1	50.61	-3.39	54	37.19	34.89	11.71	33.18	252	9	A	H
		5142.35	57.47	-16.53	74	43.76	34.61	11.55	32.45	247	22	P	V
		5134.25	44.59	-9.41	54	30.95	34.59	11.5	32.45	247	22	A	V
	*	5290	97.77	-	-	84.18	34.8	11.65	32.86	247	22	P	V
	*	5290	87.87	-	-	74.28	34.8	11.65	32.86	247	22	A	V
		5355.94	62.26	-11.74	74	48.84	34.89	11.71	33.18	247	22	P	V
	5350.11	48.58	-5.42	54	35.16	34.89	11.71	33.18	247	22	A	V	
Remark	1. No other spurious found. 2. All results are PASS against Peak and Average limit line.												

15E Band 2 5250~5350MHz

WIFI 802.11ac VHT80 (Harmonic @ 3m)

WIFI	Note	Frequency	Level	Over	Limit	Read	Antenna	Cable	Preamp	Ant	Table	Peak	Pol.
Ant.				Limit	Line	Level	Factor	Loss	Factor	Pos	Pos	Avg.	
1		( MHz )	( dBμV/m )	( dB )	( dBμV/m )	( dBμV )	( dB/m )	( dB )	( dB )	( cm )	( deg )	( P/A )	( H/V )
802.11ac VHT80 CH 58 5290MHz		10580	41.81	-32.19	74	47.57	37.4	16.52	59.68	100	0	P	H
		15870	48.25	-25.75	74	44.64	40.76	20.52	57.67	100	0	P	H
													H
													H
		10580	42.26	-31.74	74	48.02	37.4	16.52	59.68	100	0	P	V
		15870	49.15	-24.85	74	45.54	40.76	20.52	57.67	100	0	P	V
													V
													V
Remark	1. No other spurious found. 2. All results are PASS against Peak and Average limit line.												



15E Band 3 5470~5725MHz  
WIFI 802.11a (Band Edge @ 3m)

WIFI	Note	Frequency	Level	Over	Limit	Read	Antenna	Cable	Preamp	Ant	Table	Peak	Pol.	
Ant.				Limit	Line	Level	Factor	Loss	Factor	Pos	Pos	Avg.		
1		( MHz )	( dBµV/m )	( dB )	( dBµV/m )	( dBµV )	( dB/m )	( dB )	( dB )	( cm )	( deg )	( P/A )	( H/V )	
802.11a CH 100 5500MHz		5468.56	61.61	-12.39	74	48.27	35.05	11.86	33.57	224	1	P	H	
		5469.84	43.7	-10.3	54	30.36	35.05	11.86	33.57	224	1	A	H	
	*	5500	104.91	-	-	91.61	35.1	11.86	33.66	224	1	P	H	
	*	5500	94.54	-	-	81.24	35.1	11.86	33.66	224	1	A	H	
													H	
													H	
			5465.52	59.35	-14.65	74	46.01	35.05	11.86	33.57	107	17	P	V
			5469.68	43.63	-10.37	54	30.29	35.05	11.86	33.57	107	17	A	V
	*		5499	102.66	-	-	89.36	35.1	11.86	33.66	107	17	P	V
	*		5499	93.06	-	-	79.76	35.1	11.86	33.66	107	17	A	V
													V	
													V	
802.11a CH 116 5580MHz		5407.44	57.29	-16.71	74	43.98	34.96	11.74	33.39	219	2	P	H	
		5391.6	43.17	-10.83	54	29.77	34.94	11.74	33.28	219	2	A	H	
	*	5580	103.99	-	-	90.88	35.14	11.98	34.01	219	2	P	H	
	*	5580	92.65	-	-	79.54	35.14	11.98	34.01	219	2	A	H	
			5743.56	57.18	-16.82	74	43.78	35.24	12.33	34.17	219	2	P	H
			5758.52	42.91	-11.09	54	29.52	35.26	12.33	34.2	219	2	A	H
			5362.32	57.54	-16.46	74	44.1	34.91	11.71	33.18	112	21	P	V
			5387.28	43.17	-10.83	54	29.77	34.94	11.74	33.28	112	21	A	V
	*		5580	102.57	-	-	89.46	35.14	11.98	34.01	112	21	P	V
	*		5580	91.79	-	-	78.68	35.14	11.98	34.01	112	21	A	V
			5740.92	57.58	-16.42	74	44.18	35.24	12.33	34.17	112	21	P	V
			5763.64	42.89	-11.11	54	29.5	35.26	12.33	34.2	112	21	A	V



<b>802.11a</b> <b>CH 140</b> <b>5700MHz</b>	*	5700	98.66	-	-	85.39	35.21	12.18	34.12	243	6	P	H
	*	5700	87.74	-	-	74.47	35.21	12.18	34.12	243	6	A	H
		5735.16	57.25	-16.75	74	43.92	35.24	12.26	34.17	243	6	P	H
		5725.56	43.26	-10.74	54	29.92	35.23	12.26	34.15	243	6	A	H
													H
													H
	*	5700	101.81	-	-	88.54	35.21	12.18	34.12	136	19	P	V
	*	5700	90.6	-	-	77.33	35.21	12.18	34.12	136	19	A	V
		5744.2	58.57	-15.43	74	45.17	35.24	12.33	34.17	136	19	P	V
		5725.8	43.55	-10.45	54	30.21	35.23	12.26	34.15	136	19	A	V
													V
													V
<b>Remark</b>	1. No other spurious found. 2. All results are PASS against Peak and Average limit line.												



15E Band 3 5470~5725MHz  
WIFI 802.11a (Harmonic @ 3m)

WIFI	Note	Frequency	Level	Over	Limit	Read	Antenna	Cable	Preamp	Ant	Table	Peak	Pol.
Ant.				Limit	Line	Level	Factor	Loss	Factor	Pos	Pos	Avg.	
1		( MHz )	( dBμV/m )	( dB )	( dBμV/m )	( dBμV )	( dB/m )	( dB )	( dB )	( cm )	( deg )	( P/A )	( H/V )
802.11a CH 100 5500MHz		11000	44.24	-29.76	74	48.5	37.9	16.94	59.1	100	0	P	H
		16500	49.34	-24.66	74	43.86	41.4	20.88	56.8	100	0	P	H
													H
													H
		11000	44.37	-29.63	74	48.63	37.9	16.94	59.1	100	0	P	V
		16500	50.48	-23.52	74	45	41.4	20.88	56.8	100	0	P	V
													V
													V
802.11a CH 116 5580MHz		11160	44.12	-29.88	74	47.71	38	17.08	58.67	100	0	P	H
		16740	49.23	-24.77	74	42.92	41.88	21.04	56.61	100	0	P	H
													H
													H
		11160	44.08	-29.92	74	47.67	38	17.08	58.67	100	0	P	V
		16740	49.29	-24.71	74	42.98	41.88	21.04	56.61	100	0	P	V
													V
													V
802.11a CH 140 5700MHz		11400	43.82	-30.18	74	46.43	38.14	17.31	58.06	100	0	P	H
		17100	49.7	-24.3	74	42.57	42.32	21.27	56.46	100	0	P	H
													H
													H
		11400	43.65	-30.35	74	46.26	38.14	17.31	58.06	100	0	P	V
		17100	49.94	-24.06	74	42.81	42.32	21.27	56.46	100	0	P	V
													V
													V
Remark	1. No other spurious found. 2. All results are PASS against Peak and Average limit line.												



**15E Band 3 5470~5725MHz**  
**WIFI 802.11n HT20 (Band Edge @ 3m)**

WIFI	Note	Frequency	Level	Over	Limit	Read	Antenna	Cable	Preamp	Ant	Table	Peak	Pol.
Ant.				Limit	Line	Level	Factor	Loss	Factor	Pos	Pos	Avg.	
1		( MHz )	( dBμV/m )	( dB )	( dBμV/m )	( dBμV )	( dB/m )	( dB )	( dB )	( cm )	( deg )	(P/A)	(H/V)
802.11n HT20 CH 100 5500MHz		5469.68	61.41	-12.59	74	48.07	35.05	11.86	33.57	209	353	P	H
		5468.56	43.52	-10.48	54	30.18	35.05	11.86	33.57	209	353	A	H
	*	5500	104.24	-	-	90.94	35.1	11.86	33.66	209	353	P	H
	*	5500	91.87	-	-	78.57	35.1	11.86	33.66	209	353	A	H
													H
													H
802.11n HT20 CH 116 5580MHz		5402.48	57.01	-16.99	74	43.7	34.96	11.74	33.39	222	360	P	H
		5381.52	42.97	-11.03	54	29.57	34.94	11.74	33.28	222	360	A	H
	*	5580	103.18	-	-	90.07	35.14	11.98	34.01	222	360	P	H
	*	5580	90.76	-	-	77.65	35.14	11.98	34.01	222	360	A	H



802.11n HT20 CH 140 5700MHz	*	5700	101.02	-	-	87.75	35.21	12.18	34.12	245	359	P	H
	*	5700	88.08	-	-	74.81	35.21	12.18	34.12	245	359	A	H
		5728.12	57.64	-16.36	74	44.3	35.23	12.26	34.15	245	359	P	H
		5725.08	43.22	-10.78	54	29.88	35.23	12.26	34.15	245	359	A	H
													H
													H
	*	5700	101.85	-	-	88.58	35.21	12.18	34.12	135	19	P	V
	*	5700	89.88	-	-	76.61	35.21	12.18	34.12	135	19	A	V
		5725.56	59	-15	74	45.66	35.23	12.26	34.15	135	19	P	V
		5725	43.42	-10.58	54	30.08	35.23	12.26	34.15	135	19	A	V
												V	
												V	
<b>Remark</b>	1. No other spurious found. 2. All results are PASS against Peak and Average limit line.												





15E Band 3 5470~5725MHz

WIFI 802.11n HT20 (Harmonic @ 3m)

WIFI	Note	Frequency	Level	Over	Limit	Read	Antenna	Cable	Preamp	Ant	Table	Peak	Pol.
Ant.				Limit	Line	Level	Factor	Loss	Factor	Pos	Pos	Avg.	
1		( MHz )	( dBµV/m )	( dB )	( dBµV/m )	(dBµV)	( dB/m )	( dB )	( dB )	( cm )	( deg )	(P/A)	(H/V)
802.11n HT20 CH 100 5500MHz		11000	43.79	-30.21	74	48.05	37.9	16.94	59.1	100	0	P	H
		16500	49.64	-24.36	74	44.16	41.4	20.88	56.8	100	0	P	H
													H
													H
		11000	45.18	-28.82	74	49.44	37.9	16.94	59.1	100	0	P	V
		16500	49.42	-24.58	74	43.94	41.4	20.88	56.8	100	0	P	V
													V
802.11n HT20 CH 116 5580MHz		11160	43.51	-30.49	74	47.1	38	17.08	58.67	100	0	P	H
		16740	48.92	-25.08	74	42.61	41.88	21.04	56.61	100	0	P	H
													H
													H
		11160	43.31	-30.69	74	46.9	38	17.08	58.67	100	0	P	V
		16740	49.22	-24.78	74	42.91	41.88	21.04	56.61	100	0	P	V
													V
802.11n HT20 CH 140 5700MHz		11400	43.32	-30.68	74	45.93	38.14	17.31	58.06	100	0	P	H
		17100	50.03	-23.97	74	42.9	42.32	21.27	56.46	100	0	P	H
													H
													H
		11400	43.15	-30.85	74	45.76	38.14	17.31	58.06	100	0	P	V
		17100	50.15	-23.85	74	43.02	42.32	21.27	56.46	100	0	P	V
													V
Remark	1. No other spurious found.												
	2. All results are PASS against Peak and Average limit line.												



**15E Band 3 5470~5725MHz**  
**WIFI 802.11n HT40 (Band Edge @ 3m)**

WIFI	Note	Frequency	Level	Over	Limit	Read	Antenna	Cable	Preamp	Ant	Table	Peak	Pol.
Ant.				Limit	Line	Level	Factor	Loss	Factor	Pos	Pos	Avg.	
1		( MHz )	( dBµV/m )	( dB )	( dBµV/m )	( dBµV )	( dB/m )	( dB )	( dB )	( cm )	( deg )	(P/A)	(H/V)
802.11n HT40 CH 102 5510MHz		5467.28	64.97	-9.03	74	51.63	35.05	11.86	33.57	233	355	P	H
		5469.68	46.88	-7.12	54	33.54	35.05	11.86	33.57	233	355	A	H
	*	5510	102.18	-	-	88.9	35.1	11.92	33.74	233	355	P	H
	*	5510	90.63	-	-	77.35	35.1	11.92	33.74	233	355	A	H
		5753.4	56.82	-17.18	74	43.4	35.26	12.33	34.17	233	355	P	H
		5758.44	43.48	-10.52	54	30.09	35.26	12.33	34.2	233	355	A	H
		5461.04	62.26	-11.74	74	48.94	35.03	11.86	33.57	144	18	P	V
		5469.2	46.34	-7.66	54	33	35.05	11.86	33.57	144	18	A	V
	*	5510	100.45	-	-	87.17	35.1	11.92	33.74	144	18	P	V
	*	5510	89.23	-	-	75.95	35.1	11.92	33.74	144	18	A	V
		5732.28	56.52	-17.48	74	43.2	35.23	12.26	34.17	144	18	P	V
		5747	43.42	-10.58	54	30.02	35.24	12.33	34.17	144	18	A	V
802.11n HT40 CH 110 5550MHz		5392.4	56.62	-17.38	74	43.22	34.94	11.74	33.28	280	359	P	H
		5404.56	43.83	-10.17	54	30.52	34.96	11.74	33.39	280	359	A	H
	*	5550	100.51	-	-	87.23	35.13	11.98	33.83	280	359	P	H
	*	5550	89.05	-	-	75.77	35.13	11.98	33.83	280	359	A	H
		5733.4	56.9	-17.1	74	43.58	35.23	12.26	34.17	280	359	P	H
		5760.76	43.56	-10.44	54	30.17	35.26	12.33	34.2	280	359	A	H
		5443.44	57.22	-16.78	74	43.89	35.01	11.8	33.48	154	19	P	V
		5397.52	43.77	-10.23	54	30.35	34.96	11.74	33.28	154	19	A	V
	*	5550	99.51	-	-	86.23	35.13	11.98	33.83	154	19	P	V
	*	5550	88.77	-	-	75.49	35.13	11.98	33.83	154	19	A	V
		5739.4	56.95	-17.05	74	43.62	35.24	12.26	34.17	154	19	P	V
		5764.44	43.56	-10.44	54	30.17	35.26	12.33	34.2	154	19	A	V



<b>802.11n</b> <b>HT40</b> <b>CH 134</b> <b>5670MHz</b>		5389.36	57.76	-16.24	74	44.36	34.94	11.74	33.28	109	349	P	H
		5397.84	44.28	-9.72	54	30.86	34.96	11.74	33.28	109	349	A	H
	*	5670	96.23	-	-	82.94	35.2	12.18	34.09	109	349	P	H
	*	5670	87.04	-	-	73.75	35.2	12.18	34.09	109	349	A	H
		5725.88	57.23	-16.77	74	43.89	35.23	12.26	34.15	109	349	P	H
		5745.56	44.06	-9.94	54	30.66	35.24	12.33	34.17	109	349	A	H
		5410	57.28	-16.72	74	43.97	34.96	11.74	33.39	235	13	P	V
		5379.76	44.35	-9.65	54	30.98	34.94	11.71	33.28	235	13	A	V
	*	5670	98.61	-	-	85.32	35.2	12.18	34.09	235	13	P	V
	*	5670	89.3	-	-	76.01	35.2	12.18	34.09	235	13	A	V
		5726.84	57.52	-16.48	74	44.18	35.23	12.26	34.15	235	13	P	V
	5756.92	44.33	-9.67	54	30.94	35.26	12.33	34.2	235	13	A	V	
<b>Remark</b>	1. No other spurious found. 2. All results are PASS against Peak and Average limit line.												



15E Band 3 5470~5725MHz

WIFI 802.11n HT40 (Harmonic @ 3m)

WIFI	Note	Frequency	Level	Over	Limit	Read	Antenna	Cable	Preamp	Ant	Table	Peak	Pol.
Ant.				Limit	Line	Level	Factor	Loss	Factor	Pos	Pos	Avg.	
1		( MHz )	( dBμV/m )	( dB )	( dBμV/m )	( dBμV )	( dB/m )	( dB )	( dB )	( cm )	( deg )	(P/A)	(H/V)
802.11n HT40 CH 102 5510MHz		11020	43.62	-30.38	74	47.83	37.91	16.94	59.06	100	0	P	H
		16530	48.5	-25.5	74	42.89	41.47	20.91	56.77	100	0	P	H
													H
													H
		11020	43.68	-30.32	74	47.89	37.91	16.94	59.06	100	0	P	V
		16530	48.52	-25.48	74	42.91	41.47	20.91	56.77	100	0	P	V
													V
802.11n HT40 CH 110 5550MHz		11100	43.73	-30.27	74	47.6	37.96	17.01	58.84	100	0	P	H
		16650	49.57	-24.43	74	43.55	41.71	20.99	56.68	100	0	P	H
													H
													H
		11100	43.22	-30.78	74	47.09	37.96	17.01	58.84	100	0	P	V
		16650	49.89	-24.11	74	43.87	41.71	20.99	56.68	100	0	P	V
													V
802.11n HT40 CH 134 5670MHz		11340	44.62	-29.38	74	47.52	38.1	17.23	58.23	100	0	P	H
		17010	50.07	-23.93	74	42.87	42.39	21.22	56.41	100	0	P	H
													H
													H
		11340	44.38	-29.62	74	47.28	38.1	17.23	58.23	100	0	P	V
		17010	50.3	-23.7	74	43.1	42.39	21.22	56.41	100	0	P	V
													V
Remark	1. No other spurious found.												
	2. All results are PASS against Peak and Average limit line.												



**15E Band 3 5470~5725MHz**  
**WIFI 802.11ac VHT80 (Band Edge @ 3m)**

WIFI	Note	Frequency	Level	Over	Limit	Read	Antenna	Cable	Preamp	Ant	Table	Peak	Pol.
Ant.				Limit	Line	Level	Factor	Loss	Factor	Pos	Pos	Avg.	
1		( MHz )	( dBμV/m )	( dB )	( dBμV/m )	( dBμV )	( dB/m )	( dB )	( dB )	( cm )	( deg )	( P/A )	( H/V )
802.11ac VHT80 CH 106 5530MHz		5469.84	60.33	-13.67	74	46.99	35.05	11.86	33.57	204	339	P	H
		5469.36	48.23	-5.77	54	34.89	35.05	11.86	33.57	204	339	A	H
	*	5530	96.1	-	-	82.9	35.11	11.92	33.83	204	339	P	H
	*	5530	86.66	-	-	73.46	35.11	11.92	33.83	204	339	A	H
		5754.44	57.68	-16.32	74	44.26	35.26	12.33	34.17	204	339	P	H
		5758.6	44.62	-9.38	54	31.23	35.26	12.33	34.2	204	339	A	H
		5458.96	61.58	-12.42	74	48.32	35.03	11.8	33.57	209	14	P	V
		5469.04	49.02	-4.98	54	35.68	35.05	11.86	33.57	209	14	A	V
	*	5530	97.67	-	-	84.47	35.11	11.92	33.83	209	14	P	V
	*	5530	88.27	-	-	75.07	35.11	11.92	33.83	209	14	A	V
		5754.28	57.05	-16.95	74	43.63	35.26	12.33	34.17	209	14	P	V
		5755.16	44.57	-9.43	54	31.15	35.26	12.33	34.17	209	14	A	V
802.11ac VHT80 CH 122 5610MHz		5452.24	57.57	-16.43	74	44.31	35.03	11.8	33.57	101	341	P	H
		5400.08	44.93	-9.07	54	31.62	34.96	11.74	33.39	101	341	A	H
	*	5610	94.9	-	-	81.74	35.16	12.04	34.04	101	341	P	H
	*	5610	84.9	-	-	71.74	35.16	12.04	34.04	101	341	A	H
		5759.72	57.95	-16.05	74	44.56	35.26	12.33	34.2	101	341	P	H
		5758.92	44.68	-9.32	54	31.29	35.26	12.33	34.2	101	341	A	H
		5405.04	58.75	-15.25	74	45.44	34.96	11.74	33.39	233	8	P	V
		5377.04	44.99	-9.01	54	31.65	34.91	11.71	33.28	233	8	A	V
	*	5610	96.32	-	-	83.16	35.16	12.04	34.04	233	8	P	V
	*	5610	86.11	-	-	72.95	35.16	12.04	34.04	233	8	A	V
		5737.72	58.08	-15.92	74	44.75	35.24	12.26	34.17	233	8	P	V
		5761.48	44.79	-9.21	54	31.4	35.26	12.33	34.2	233	8	A	V
Remark	1. No other spurious found. 2. All results are PASS against Peak and Average limit line.												



15E Band 3 5470~5725MHz

WIFI 802.11ac VHT80 (Harmonic @ 3m)

WIFI	Note	Frequency	Level	Over	Limit	Read	Antenna	Cable	Preamp	Ant	Table	Peak	Pol.
Ant.				Limit	Line	Level	Factor	Loss	Factor	Pos	Pos	Avg.	
1		( MHz )	( dBμV/m )	( dB )	( dBμV/m )	( dBμV )	( dB/m )	( dB )	( dB )	( cm )	( deg )	(P/A)	(H/V)
802.11ac VHT80 CH 106 5530MHz		11060	44.18	-29.82	74	48.2	37.94	16.97	58.93	100	0	P	H
		16590	48.52	-25.48	74	42.72	41.57	20.96	56.73	100	0	P	H
													H
													H
		11060	43.02	-30.98	74	47.04	37.94	16.97	58.93	100	0	P	V
		16590	48.45	-25.55	74	42.65	41.57	20.96	56.73	100	0	P	V
													V
802.11ac VHT80 CH 122 5610MHz		11220	44.45	-29.55	74	47.84	38.03	17.12	58.54	100	0	P	H
		16830	50.19	-23.81	74	43.55	42.06	21.12	56.54	100	0	P	H
													H
													H
		11220	43.6	-30.4	74	46.99	38.03	17.12	58.54	100	0	P	V
		16830	50.84	-23.16	74	44.2	42.06	21.12	56.54	100	0	P	V
													V
Remark	1. No other spurious found.												
	2. All results are PASS against Peak and Average limit line.												



**15E Band 3 Straddle Channel  
WIFI 802.11a (Band Edge @ 3m)**

WIFI	Note	Frequency	Level	Over	Limit	Read	Antenna	Cable	Preamp	Ant	Table	Peak	Pol.
Ant.				Limit	Line	Level	Factor	Loss	Factor	Pos	Pos	Avg.	
1		( MHz )	( dBμV/m )	( dB )	( dBμV/m )	( dBμV )	( dB/m )	( dB )	( dB )	( cm )	( deg )	( P/A )	( H/V )
802.11a CH 144 5720MHz	*	5720	98.25	-	-	84.91	35.23	12.26	34.15	385	22	P	H
	*	5720	87.4	-	-	74.06	35.23	12.26	34.15	385	22	A	H
													H
													H
													H
													H
	*	5720	98.65	-	-	85.31	35.23	12.26	34.15	101	299	P	V
	*	5720	87.5	-	-	74.16	35.23	12.26	34.15	101	299	A	V
													V
													V
													V
<b>Remark</b>	1. No other spurious found. 2. All results are PASS against Peak and Average limit line.												

**15E Band 3 Straddle Channel  
WIFI 802.11a (Harmonic @ 3m)**

WIFI	Note	Frequency	Level	Over	Limit	Read	Antenna	Cable	Preamp	Ant	Table	Peak	Pol.
Ant.				Limit	Line	Level	Factor	Loss	Factor	Pos	Pos	Avg.	
1		( MHz )	( dBμV/m )	( dB )	( dBμV/m )	( dBμV )	( dB/m )	( dB )	( dB )	( cm )	( deg )	( P/A )	( H/V )
802.11a CH 144 5720MHz		11440	44.52	-29.48	74	46.98	38.16	17.35	57.97	100	0	P	H
		17160	50.51	-23.49	74	43.42	42.27	21.32	56.5	100	0	P	H
													H
													H
		11440	44.64	-29.36	74	47.1	38.16	17.35	57.97	100	0	P	V
		17160	50.79	-23.21	74	43.7	42.27	21.32	56.5	100	0	P	V
													V
													V
<b>Remark</b>	1. No other spurious found. 2. All results are PASS against Peak and Average limit line.												



**15E Band 3 Straddle Channel  
WIFI 802.11n HT20 (Band Edge @ 3m)**

WIFI	Note	Frequency	Level	Over	Limit	Read	Antenna	Cable	Preamp	Ant	Table	Peak	Pol.
Ant.				Limit	Line	Level	Factor	Loss	Factor	Pos	Pos	Avg.	
1		( MHz )	( dBμV/m )	( dB )	( dBμV/m )	( dBμV )	( dB/m )	( dB )	( dB )	( cm )	( deg )	( P/A )	( H/V )
802.11n HT20 CH 144 5720MHz	*	5720	96.29	-	-	82.95	35.23	12.26	34.15	102	353	P	H
	*	5720	85.96	-	-	72.62	35.23	12.26	34.15	102	353	A	H
													H
													H
													H
													H
	*	5720	99.98	-	-	86.64	35.23	12.26	34.15	239	24	P	V
	*	5720	89.34	-	-	76	35.23	12.26	34.15	239	24	A	V
													V
													V
												V	
												V	
<b>Remark</b>	1. No other spurious found. 2. All results are PASS against Peak and Average limit line.												

**15E Band 3 Straddle Channel  
WIFI 802.11n HT20 (Harmonic @ 3m)**

WIFI	Note	Frequency	Level	Over	Limit	Read	Antenna	Cable	Preamp	Ant	Table	Peak	Pol.
Ant.				Limit	Line	Level	Factor	Loss	Factor	Pos	Pos	Avg.	
1		( MHz )	( dBμV/m )	( dB )	( dBμV/m )	( dBμV )	( dB/m )	( dB )	( dB )	( cm )	( deg )	( P/A )	( H/V )
802.11n HT20 CH 144 5720MHz		11440	45.67	-28.33	74	48.13	38.16	17.35	57.97	100	0	P	H
		17160	50.14	-23.86	74	43.05	42.27	21.32	56.5	100	0	P	H
													H
													H
		11440	44.18	-29.82	74	46.64	38.16	17.35	57.97	100	0	P	V
		17160	50.42	-23.58	74	43.33	42.27	21.32	56.5	100	0	P	V
													V
													V
<b>Remark</b>	1. No other spurious found. 2. All results are PASS against Peak and Average limit line.												





**15E Band 3 Straddle Channel  
WIFI 802.11n HT40 (Band Edge @ 3m)**

WIFI	Note	Frequency	Level	Over	Limit	Read	Antenna	Cable	Preamp	Ant	Table	Peak	Pol.
Ant.				Limit	Line	Level	Factor	Loss	Factor	Pos	Pos	Avg.	
1		( MHz )	( dBµV/m )	( dB )	( dBµV/m )	( dBµV )	( dB/m )	( dB )	( dB )	( cm )	( deg )	(P/A)	(H/V)
802.11n HT40 CH 142 5710MHz	*	5710	95.49	-	-	82.16	35.22	12.26	34.15	101	349	P	H
	*	5710	85.59	-	-	72.26	35.22	12.26	34.15	101	349	A	H
													H
													H
													H
													H
	*	5710	95.08	-	-	81.75	35.22	12.26	34.15	101	58	P	V
	*	5710	86.21	-	-	72.88	35.22	12.26	34.15	101	58	A	V
													V
													V
<b>Remark</b>	1. No other spurious found. 2. All results are PASS against Peak and Average limit line.												

**15E Band 3 Straddle Channel  
WIFI 802.11n HT40 (Harmonic @ 3m)**

WIFI	Note	Frequency	Level	Over	Limit	Read	Antenna	Cable	Preamp	Ant	Table	Peak	Pol.
Ant.				Limit	Line	Level	Factor	Loss	Factor	Pos	Pos	Avg.	
1		( MHz )	( dBµV/m )	( dB )	( dBµV/m )	( dBµV )	( dB/m )	( dB )	( dB )	( cm )	( deg )	(P/A)	(H/V)
802.11n HT40 CH 142 5710MHz		11420	43.85	-30.15	74	46.41	38.15	17.31	58.02	100	0	P	H
		17130	50.43	-23.57	74	43.32	42.29	21.3	56.48	100	0	P	H
													H
													H
		11420	44.63	-29.37	74	47.19	38.15	17.31	58.02	100	0	P	V
		17130	50.29	-23.71	74	43.18	42.29	21.3	56.48	100	0	P	V
													V
<b>Remark</b>	1. No other spurious found. 2. All results are PASS against Peak and Average limit line.												



**15E Band 3 Straddle Channel  
WIFI 802.11ac VHT80 (Band Edge @ 3m)**

WIFI	Note	Frequency	Level	Over	Limit	Read	Antenna	Cable	Preamp	Ant	Table	Peak	Pol.
Ant.				Limit	Line	Level	Factor	Loss	Factor	Pos	Pos	Avg.	
1		( MHz )	( dBμV/m )	( dB )	( dBμV/m )	( dBμV )	( dB/m )	( dB )	( dB )	( cm )	( deg )	( P/A )	( H/V )
802.11ac VHT80 CH 138 5690MHz	*	5690	91.54	-	-	78.27	35.21	12.18	34.12	216	339	P	H
	*	5690	82.32	-	-	69.05	35.21	12.18	34.12	216	339	A	H
													H
													H
													H
													H
	*	5690	91.75	-	-	78.48	35.21	12.18	34.12	297	290	P	V
	*	5690	82.31	-	-	69.04	35.21	12.18	34.12	297	290	A	V
													V
													V
<b>Remark</b>	1. No other spurious found. 2. All results are PASS against Peak and Average limit line.												

**15E Band 3 Straddle Channel  
WIFI 802.11ac VHT80 (Harmonic @ 3m)**

WIFI	Note	Frequency	Level	Over	Limit	Read	Antenna	Cable	Preamp	Ant	Table	Peak	Pol.
Ant.				Limit	Line	Level	Factor	Loss	Factor	Pos	Pos	Avg.	
1		( MHz )	( dBμV/m )	( dB )	( dBμV/m )	( dBμV )	( dB/m )	( dB )	( dB )	( cm )	( deg )	( P/A )	( H/V )
802.11ac VHT80 CH 138 5690MHz		11380	44.74	-29.26	74	47.44	38.13	17.27	58.1	100	0	P	H
		17070	50.43	-23.57	74	43.25	42.35	21.27	56.44	100	0	P	H
													H
													H
		11380	44.36	-29.64	74	47.06	38.13	17.27	58.1	100	0	P	V
		17070	50.4	-23.6	74	43.22	42.35	21.27	56.44	100	0	P	V
													V
<b>Remark</b>	1. No other spurious found. 2. All results are PASS against Peak and Average limit line.												



15E Emission below 1GHz

WIFI 802.11a (LF @ 3m)

WIFI	Note	Frequency	Level	Over	Limit	Read	Antenna	Cable	Preamp	Ant	Table	Peak	Pol.	
Ant.				Limit	Line	Level	Factor	Loss	Factor	Pos	Pos	Avg.		
1		( MHz )	( dBμV/m )	( dB )	( dBμV/m )	( dBμV )	( dB/m )	( dB )	( dB )	( cm )	( deg )	( P/A )	( H/V )	
802.11a LF		59.43	30.47	-9.53	40	53.9	6.08	1.77	31.28	100	0	P	H	
		140.43	18.93	-24.57	43.5	35.92	11.5	2.61	31.1	-	-	P	H	
		231.15	23.74	-22.26	46	41.56	10.22	2.96	31	-	-	P	H	
		547.1	21.91	-24.09	46	29.25	19.44	4.01	30.79	-	-	P	H	
		713.7	28.48	-17.52	46	33.31	21.16	4.41	30.4	-	-	P	H	
		981.8	32.45	-21.55	54	32.73	24.96	5.03	30.27	-	-	P	H	
														H
														H
														H
														H
														H
														H
			45.93	30.57	-9.43	40	49.85	10.15	1.77	31.2	100	0	P	V
			159.6	17.85	-25.65	43.5	35.94	10.5	2.61	31.2	-	-	P	V
			250.86	19.57	-26.43	46	35.05	12.56	2.96	31	-	-	P	V
			449.1	21.12	-24.88	46	30.97	17.27	3.63	30.75	-	-	P	V
			660.5	24.56	-21.44	46	30.38	20.31	4.35	30.48	-	-	P	V
			850.2	27.73	-18.27	46	30.14	23.29	4.7	30.4	-	-	P	V
													V	
													V	
													V	
													V	
													V	
													V	
Remark	1. No other spurious found. 2. All results are PASS against limit line.													



**15E Emission below 1GHz  
WIFI 802.11n HT20 (LF @ 3m)**

WIFI	Note	Frequency	Level	Over	Limit	Read	Antenna	Cable	Preamp	Ant	Table	Peak	Pol.	
Ant.				Limit	Line	Level	Factor	Loss	Factor	Pos	Pos	Avg.		
1		( MHz )	( dBμV/m )	( dB )	( dBμV/m )	( dBμV )	( dB/m )	( dB )	( dB )	( cm )	( deg )	( P/A )	( H/V )	
802.11n HT20 LF		38.37	30.6	-9.4	40	45.61	14.44	1.77	31.22	100	0	P	H	
		130.71	20.83	-22.67	43.5	37.65	11.9	2.38	31.1	-	-	P	H	
		260.04	25.5	-20.5	46	39.34	14	3.16	31	-	-	P	H	
		355.3	21.82	-24.18	46	34.96	14.55	3.39	31.08	-	-	P	H	
		575.8	28.11	-17.89	46	35.16	19.64	4.01	30.7	-	-	P	H	
		896.4	32.45	-13.55	46	35.02	23.08	4.66	30.31	-	-	P	H	
														H
														H
														H
														H
														H
														H
			44.58	31.93	-8.07	40	50.86	10.5	1.77	31.2	100	0	P	V
			146.64	19.75	-23.75	43.5	36.88	11.36	2.61	31.1	-	-	P	V
			269.49	21.52	-24.48	46	36.46	12.9	3.16	31	-	-	P	V
			397.3	22.84	-23.16	46	34.41	15.82	3.52	30.91	-	-	P	V
			642.3	28.84	-17.16	46	34.74	20.4	4.22	30.52	-	-	P	V
			974.8	32.79	-21.21	54	33.25	24.9	4.94	30.3	-	-	P	V
														V
														V
													V	
													V	
													V	
													V	
<b>Remark</b>	1. No other spurious found. 2. All results are PASS against limit line.													



**15E Emission below 1GHz  
WIFI 802.11n HT40 (LF @ 3m)**

WIFI	Note	Frequency	Level	Over	Limit	Read	Antenna	Cable	Preamp	Ant	Table	Peak	Pol.	
Ant.				Limit	Line	Level	Factor	Loss	Factor	Pos	Pos	Avg.		
1		( MHz )	( dBµV/m )	( dB )	( dBµV/m )	( dBµV )	( dB/m )	( dB )	( dB )	( cm )	( deg )	( P/A )	( H/V )	
802.11n HT40 LF		60.78	30.58	-9.42	40	53.8	6	2.06	31.28	100	0	P	H	
		137.73	21.35	-22.15	43.5	38.57	11.5	2.38	31.1	-	-	P	H	
		238.44	22.23	-23.77	46	39.09	11.18	2.96	31	-	-	P	H	
		405	25.02	-20.98	46	36.32	16.06	3.52	30.88	-	-	P	H	
		629.7	28.7	-17.3	46	34.64	20.38	4.22	30.54	-	-	P	H	
		925.1	33.5	-12.5	46	34.9	24.15	4.8	30.35	-	-	P	H	
														H
														H
														H
														H
														H
														H
			42.69	32.63	-7.37	40	50.16	11.9	1.77	31.2	100	0	P	V
			134.49	18.47	-25.03	43.5	35.69	11.5	2.38	31.1	-	-	P	V
			258.96	22.47	-23.53	46	36.67	13.84	2.96	31	-	-	P	V
			393.1	23.33	-22.67	46	35.12	15.62	3.52	30.93	-	-	P	V
			685.7	28.25	-17.75	46	33.83	20.5	4.35	30.43	-	-	P	V
			962.9	33.59	-20.41	54	34.27	24.73	4.94	30.35	-	-	P	V
														V
														V
													V	
													V	
													V	
													V	
<b>Remark</b>	1. No other spurious found. 2. All results are PASS against limit line.													



15E Emission below 1GHz  
WIFI 802.11ac VHT80 (LF @ 3m)

WIFI	Note	Frequency	Level	Over	Limit	Read	Antenna	Cable	Preamp	Ant	Table	Peak	Pol.	
Ant.				Limit	Line	Level	Factor	Loss	Factor	Pos	Pos	Avg.		
1		( MHz )	( dBμV/m )	( dB )	( dBμV/m )	( dBμV )	( dB/m )	( dB )	( dB )	( cm )	( deg )	( P/A )	( H/V )	
802.11ac VHT80 LF		35.13	32.13	-7.87	40	45.46	16.2	1.77	31.3	100	0	P	H	
		127.74	22.31	-21.19	43.5	39.19	11.84	2.38	31.1	-	-	P	H	
		253.83	24.35	-21.65	46	39.35	13.04	2.96	31	-	-	P	H	
		378.4	23.19	-22.81	46	35.75	15.06	3.39	31.01	-	-	P	H	
		668.9	27.72	-18.28	46	33.44	20.39	4.35	30.46	-	-	P	H	
		910.4	31.45	-14.55	46	33.42	23.55	4.8	30.32	-	-	P	H	
														H
														H
														H
														H
														H
														H
														H
			36.48	31.46	-8.54	40	45.63	15.32	1.77	31.26	100	0	P	V
			176.61	19.1	-24.4	43.5	38.3	9.17	2.61	30.98	-	-	P	V
			244.65	20.22	-25.78	46	36.46	11.8	2.96	31	-	-	P	V
			356.7	21.27	-24.73	46	34.35	14.61	3.39	31.08	-	-	P	V
			715.8	29.6	-16.4	46	34.35	21.24	4.41	30.4	-	-	P	V
			974.8	32.79	-21.21	54	33.25	24.9	4.94	30.3	-	-	P	V
														V
													V	
													V	
													V	
													V	
													V	
Remark	1. No other spurious found. 2. All results are PASS against limit line.													



**Note symbol**

*	<b>Fundamental Frequency</b> which can be ignored. However, the level of any unwanted emissions shall not exceed the level of the fundamental frequency per 15.209(c).
!	Test result is <b>over limit</b> line.
P/A	<b>Peak</b> or <b>Average</b>
H/V	<b>Horizontal</b> or <b>Vertical</b>



A calculation example for radiated spurious emission is shown as below:

WIFI	Note	Frequency	Level	Over	Limit	Read	Antenna	Cable	Preamp	Ant	Table	Peak	Pol.
Ant.				Limit	Line	Level	Factor	Loss	Factor	Pos	Pos	Avg.	
1		( MHz )	( dBμV/m )	( dB )	( dBμV/m )	( dBμV )	( dB/m )	( dB )	( dB )	( cm )	( deg )	(P/A)	(H/V)
802.11b		2390	55.45	-18.55	74	54.51	32.22	4.58	35.86	103	308	P	H
CH 01													
2412MHz		2390	43.54	-10.46	54	42.6	32.22	4.58	35.86	103	308	A	H

- Level(dBμV/m) =  
Antenna Factor(dB/m) + Cable Loss(dB) + Read Level(dBμV) - Preamp Factor(dB)
- Over Limit(dB) = Level(dBμV/m) – Limit Line(dBμV/m)

**For Peak Limit @ 2390MHz:**

- Level(dBμV/m)  
= Antenna Factor(dB/m) + Cable Loss(dB) + Read Level(dBμV) - Preamp Factor(dB)  
= 32.22(dB/m) + 4.58(dB) + 54.51(dBμV) – 35.86 (dB)  
= 55.45 (dBμV/m)
- Over Limit(dB)  
= Level(dBμV/m) – Limit Line(dBμV/m)  
= 55.45(dBμV/m) – 74(dBμV/m)  
= -18.55(dB)

**For Average Limit @ 2390MHz:**

- Level(dBμV/m)  
= Antenna Factor(dB/m) + Cable Loss(dB) + Read Level(dBμV) - Preamp Factor(dB)  
= 32.22(dB/m) + 4.58(dB) + 42.6(dBμV) – 35.86 (dB)  
= 43.54 (dBμV/m)
- Over Limit(dB)  
= Level(dBμV/m) – Limit Line(dBμV/m)  
= 43.54(dBμV/m) – 54(dBμV/m)  
= -10.46(dB)

Both peak and average measured complies with the limit line, so test result is “PASS”.





## Appendix C. Radiated Spurious Emission Plots

Test Engineer :	Wei Chen, Ken Wu and James Chiu	Temperature :	21~23°C
		Relative Humidity :	60~63%

**Band 1 - 5150~5250MHz**  
**WIFI 802.11a (Band Edge @ 3m)**

WIFI	Band 1 5150~5250MHz Band Edge @ 3m	
ANT	802.11a CH36 5180MHz	
1	Horizontal	Vertical
<b>Peak</b>	<p>Site : 03CH07-HY Condition : FCC CLASS-B 3m HF-ANT_130829 HORIZONTAL RBW:1000.000kHz VBW:3000.000kHz SWT:Auto Detector : Peak</p>	<p>Site : 03CH07-HY Condition : FCC CLASS-B 3m HF-ANT_130829 VERTICAL RBW:1000.000kHz VBW:3000.000kHz SWT:Auto Detector : Peak</p>
<b>Avg.</b>	<p>Site : 03CH07-HY Condition : FCC CLASS-B (AVG) 3m HF-ANT_130829 HORIZONTAL RBW:1000.000kHz VBW:0.010kHz SWT:Auto Detector : Peak</p>	<p>Site : 03CH07-HY Condition : FCC CLASS-B (AVG) 3m HF-ANT_130829 VERTICAL RBW:1000.000kHz VBW:0.010kHz SWT:Auto Detector : Peak</p>

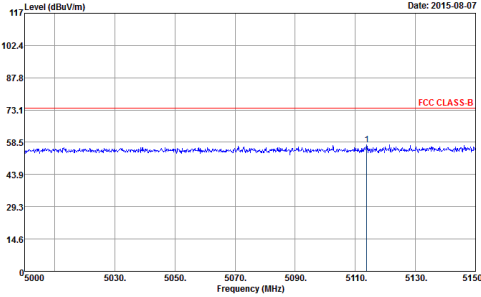
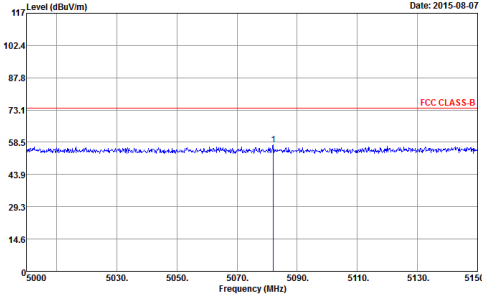
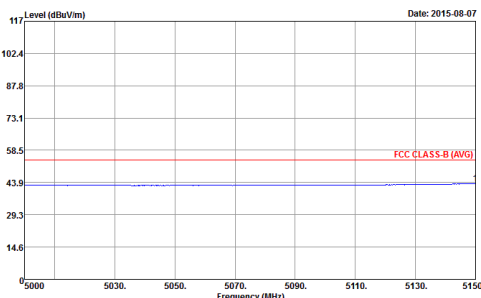
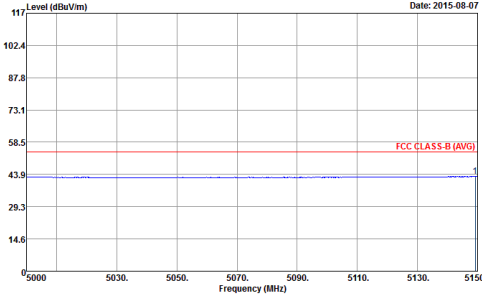

WIFI	Band 1 5150~5250MHz Band Edge @ 3m	
ANT	802.11a CH44 5220MHz – Low channel location	
1	Horizontal	Vertical
Peak	 <p>Site : 03CH07-HY Condition : FCC CLASS-B 3m HF-ANT_130829 HORIZONTAL RBW:1000.000KHz VBW:3000.000KHz SWT:Auto Detector : Peak</p>	 <p>Site : 03CH07-HY Condition : FCC CLASS-B 3m HF-ANT_130829 VERTICAL RBW:1000.000KHz VBW:3000.000KHz SWT:Auto Detector : Peak</p>
Avg.	 <p>Site : 03CH07-HY Condition : FCC CLASS-B (AVG) 3m HF-ANT_130829 HORIZONTAL RBW:1000.000KHz VBW:0.010KHz SWT:Auto Detector : Peak</p>	 <p>Site : 03CH07-HY Condition : FCC CLASS-B (AVG) 3m HF-ANT_130829 VERTICAL RBW:1000.000KHz VBW:0.010KHz SWT:Auto Detector : Peak</p>

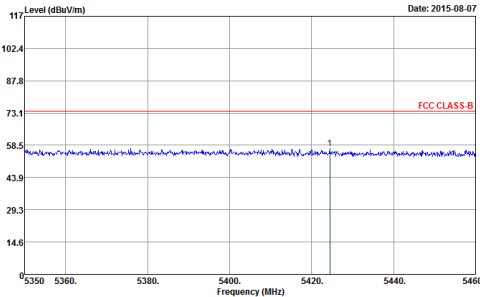
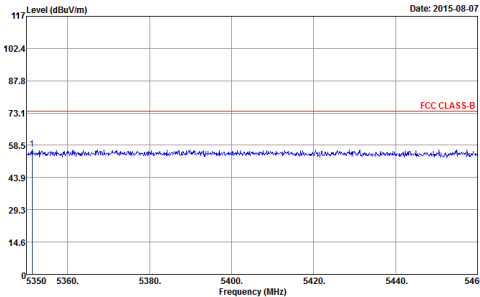
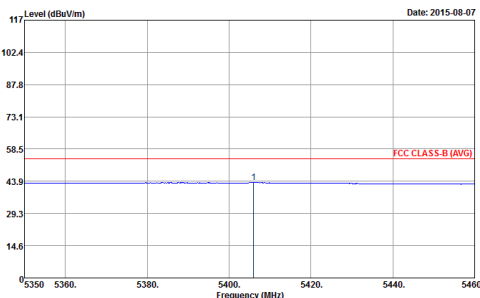
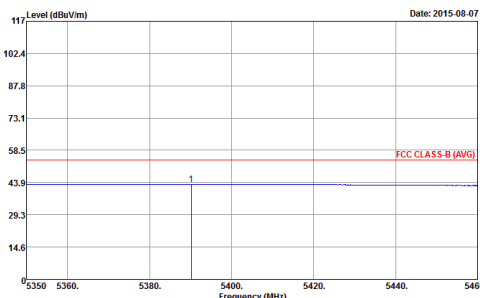

WIFI	Band 1 5150~5250MHz Band Edge @ 3m	
ANT	802.11a CH44 5220MHz - High channel location	
1+2	Horizontal	Vertical
Peak	 <p>Level (dBuV/m) vs Frequency (MHz) plot for Horizontal orientation. The y-axis ranges from 14.6 to 117 dBuV/m, and the x-axis ranges from 5350 to 5460 MHz. A red horizontal line indicates the FCC CLASS-B limit at 73.1 dBuV/m. The blue signal line is consistently below this limit, with a peak at approximately 5420 MHz.</p> <p>Site : 03CH07-HY            Condition : FCC CLASS-B 3m HF-ANT_130829 HORIZONTAL            RBW:1000.000kHz VBW:3000.000kHz SWT:Auto            Detector : Peak</p>	 <p>Level (dBuV/m) vs Frequency (MHz) plot for Vertical orientation. The y-axis ranges from 14.6 to 117 dBuV/m, and the x-axis ranges from 5350 to 5460 MHz. A red horizontal line indicates the FCC CLASS-B limit at 73.1 dBuV/m. The blue signal line is consistently below this limit, with a peak at approximately 5420 MHz.</p> <p>Site : 03CH07-HY            Condition : FCC CLASS-B 3m HF-ANT_130829 VERTICAL            RBW:1000.000kHz VBW:3000.000kHz SWT:Auto            Detector : Peak</p>
Avg.	 <p>Level (dBuV/m) vs Frequency (MHz) plot for Horizontal orientation showing average values. The y-axis ranges from 14.6 to 117 dBuV/m, and the x-axis ranges from 5350 to 5460 MHz. A red horizontal line indicates the FCC CLASS-B (AVG) limit at 58.5 dBuV/m. The blue signal line is consistently below this limit, with a peak at approximately 5420 MHz.</p> <p>Site : 03CH07-HY            Condition : FCC CLASS-B (AVG) 3m HF-ANT_130829 HORIZONTAL            RBW:1000.000kHz VBW:0.010kHz SWT:Auto            Detector : Peak</p>	 <p>Level (dBuV/m) vs Frequency (MHz) plot for Vertical orientation showing average values. The y-axis ranges from 14.6 to 117 dBuV/m, and the x-axis ranges from 5350 to 5460 MHz. A red horizontal line indicates the FCC CLASS-B (AVG) limit at 58.5 dBuV/m. The blue signal line is consistently below this limit, with a peak at approximately 5420 MHz.</p> <p>Site : 03CH07-HY            Condition : FCC CLASS-B (AVG) 3m HF-ANT_130829 VERTICAL            RBW:1000.000kHz VBW:0.010kHz SWT:Auto            Detector : Peak</p>

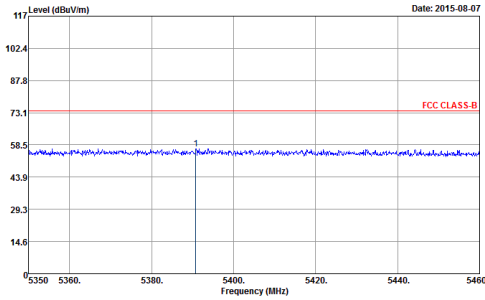
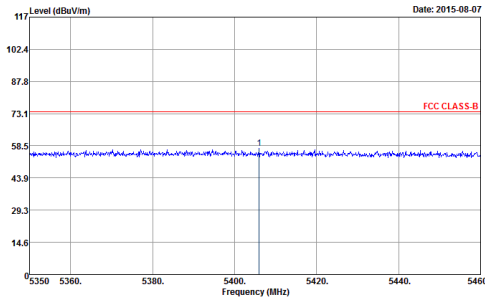
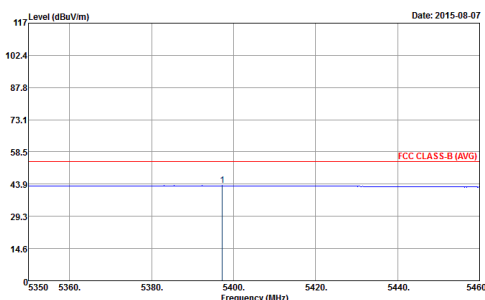
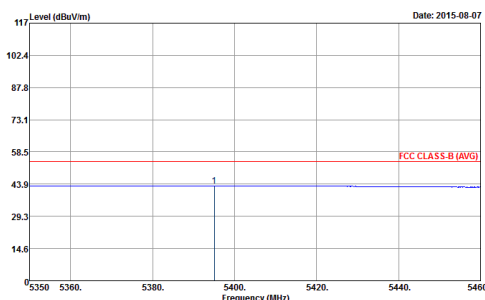

WIFI	Band 1 5150~5250MHz Band Edge @ 3m	
ANT	802.11a CH48 5240MHz	
1	Horizontal	Vertical
Peak	 <p>Date: 2015-08-07</p> <p>Site : 03CH07-HY Condition : FCC CLASS-B 3m HF-ANT_130829 HORIZONTAL RBW: 1000.000kHz VBW: 3000.000kHz SWT: Auto Detector : Peak</p>	 <p>Date: 2015-08-07</p> <p>Site : 03CH07-HY Condition : FCC CLASS-B 3m HF-ANT_130829 VERTICAL RBW: 1000.000kHz VBW: 3000.000kHz SWT: Auto Detector : Peak</p>
Avg.	 <p>Date: 2015-08-07</p> <p>Site : 03CH07-HY Condition : FCC CLASS-B (AVG) 3m HF-ANT_130829 HORIZONTAL RBW: 1000.000kHz VBW: 0.010kHz SWT: Auto Detector : Peak</p>	 <p>Date: 2015-08-07</p> <p>Site : 03CH07-HY Condition : FCC CLASS-B (AVG) 3m HF-ANT_130829 VERTICAL RBW: 1000.000kHz VBW: 0.010kHz SWT: Auto Detector : Peak</p>



**Band 1 5150~5250MHz  
WIFI 802.11n HT20 (Band Edge @ 3m)**

WIFI	Band 1 5150~5250MHz Band Edge @ 3m	
ANT	802.11n HT20 CH36 5180MHz	
1	Horizontal	Vertical
<b>Peak</b>	<p>Site : 03CH07-HY Condition : FCC CLASS-B 3m HF-ANT_130829 HORIZONTAL RBW:1000.000kHz VBW:3000.000kHz SWT:Auto Detector : Peak</p>	<p>Site : 03CH07-HY Condition : FCC CLASS-B 3m HF-ANT_130829 VERTICAL RBW:1000.000kHz VBW:3000.000kHz SWT:Auto Detector : Peak</p>
<b>Avg.</b>	<p>Site : 03CH07-HY Condition : FCC CLASS-B (AVG) 3m HF-ANT_130829 HORIZONTAL RBW:1000.000kHz VBW:0.010kHz SWT:Auto Detector : Peak</p>	<p>Site : 03CH07-HY Condition : FCC CLASS-B (AVG) 3m HF-ANT_130829 VERTICAL RBW:1000.000kHz VBW:0.010kHz SWT:Auto Detector : Peak</p>

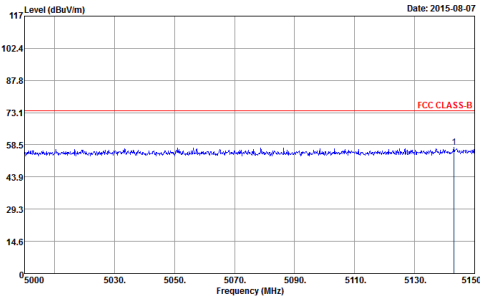
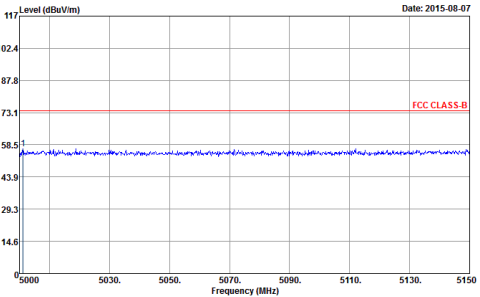
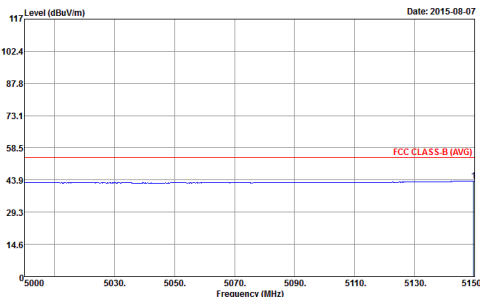
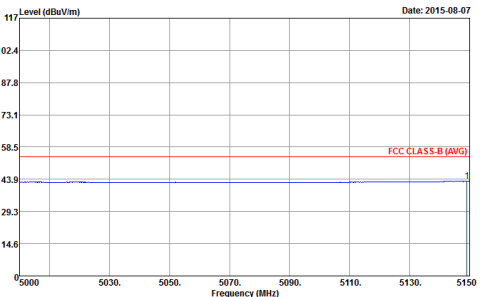

WIFI	Band 1 5150~5250MHz Band Edge @ 3m	
ANT	802.11n HT20 CH44 5220MHz - Low channel location	
1	Horizontal	Vertical
Peak	 <p>Site : 03CH07-HY Condition : FCC CLASS-B 3m HF-ANT_130829 HORIZONTAL RBW: 1000.000kHz VBW: 3000.000kHz SWT: Auto Detector : Peak</p>	 <p>Site : 03CH07-HY Condition : FCC CLASS-B 3m HF-ANT_130829 VERTICAL RBW: 1000.000kHz VBW: 3000.000kHz SWT: Auto Detector : Peak</p>
Avg.	 <p>Site : 03CH07-HY Condition : FCC CLASS-B (AVG) 3m HF-ANT_130829 HORIZONTAL RBW: 1000.000kHz VBW: 0.010kHz SWT: Auto Detector : Peak</p>	 <p>Site : 03CH07-HY Condition : FCC CLASS-B (AVG) 3m HF-ANT_130829 VERTICAL RBW: 1000.000kHz VBW: 0.010kHz SWT: Auto Detector : Peak</p>



WIFI	Band 1 5150~5250MHz Band Edge @ 3m	
ANT	802.11n HT20 CH44 5220MHz - High channel location	
1	Horizontal	Vertical
Peak	<p>Site : 03CH07-HY Condition : FCC CLASS-B 3m HF-ANT_130829 HORIZONTAL RBW:1000.000KHz VBW:3000.000KHz SWT:Auto Detector : Peak</p>	<p>Site : 03CH07-HY Condition : FCC CLASS-B 3m HF-ANT_130829 VERTICAL RBW:1000.000KHz VBW:3000.000KHz SWT:Auto Detector : Peak</p>
Avg.	<p>Site : 03CH07-HY Condition : FCC CLASS-B (AVG) 3m HF-ANT_130829 HORIZONTAL RBW:1000.000KHz VBW:0.010KHz SWT:Auto Detector : Peak</p>	<p>Site : 03CH07-HY Condition : FCC CLASS-B (AVG) 3m HF-ANT_130829 VERTICAL RBW:1000.000KHz VBW:0.010KHz SWT:Auto Detector : Peak</p>

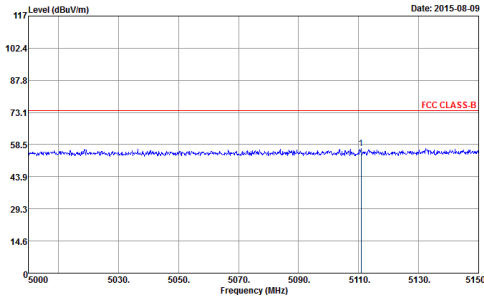
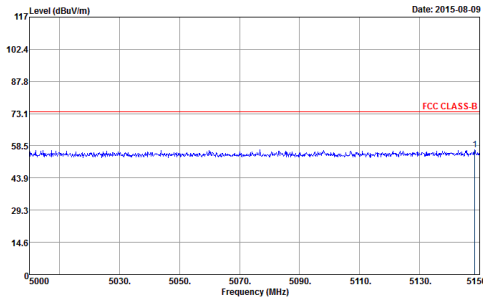
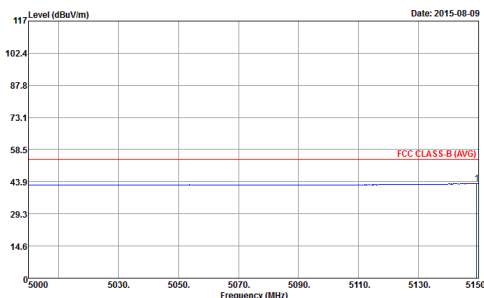
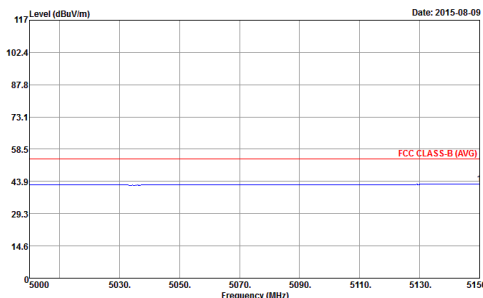

WIFI	Band 1 5150~5250MHz Band Edge @ 3m	
ANT	802.11n HT20 CH48 5240MHz - Low channel location	
1	Horizontal	Vertical
Peak	 <p>Site : 03CH07-HY Condition : FCC CLASS-B 3m HF-ANT_130829 HORIZONTAL Detector : Peak</p>	 <p>Site : 03CH07-HY Condition : FCC CLASS-B 3m HF-ANT_130829 VERTICAL Detector : Peak</p>
Avg.	 <p>Site : 03CH07-HY Condition : FCC CLASS-B (AVG) 3m HF-ANT_130829 HORIZONTAL Detector : Peak</p>	 <p>Site : 03CH07-HY Condition : FCC CLASS-B (AVG) 3m HF-ANT_130829 VERTICAL Detector : Peak</p>



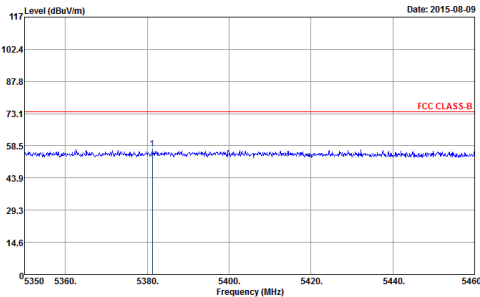
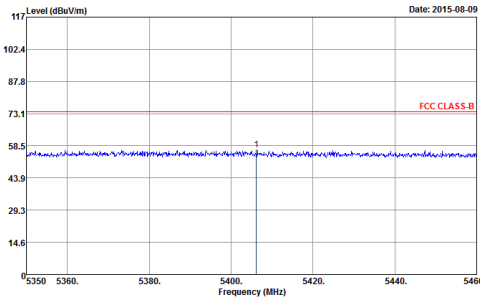
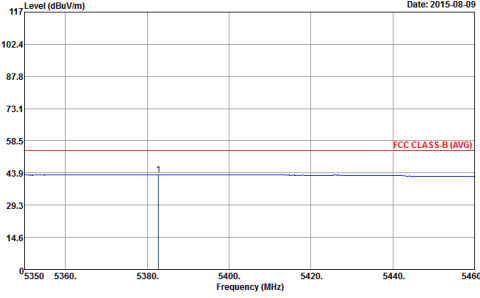
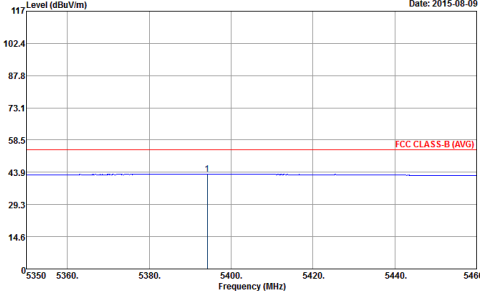

WIFI	Band 1 5150~5250MHz Band Edge @ 3m	
ANT	802.11n HT20 CH48 5240MHz - High channel location	
1	Horizontal	Vertical
Peak	 <p>Site : 03CH07-HY Condition : FCC CLASS-B 3m HF-ANT_130829 HORIZONTAL Detector : Peak</p>	 <p>Site : 03CH07-HY Condition : FCC CLASS-B 3m HF-ANT_130829 VERTICAL Detector : Peak</p>
Avg.	 <p>Site : 03CH07-HY Condition : FCC CLASS-B (AVG) 3m HF-ANT_130829 HORIZONTAL Detector : Peak</p>	 <p>Site : 03CH07-HY Condition : FCC CLASS-B (AVG) 3m HF-ANT_130829 VERTICAL Detector : Peak</p>



**Band 1 5150~5250MHz**  
**WIFI 802.11n HT40 (Band Edge @ 3m)**

WIFI	Band 1 5150~5250MHz Band Edge @ 3m	
ANT	802.11n HT40 CH38 5190MHz - Low channel location	
1	Horizontal	Vertical
<b>Peak</b>	<p>Site : 03CH07-HY            Condition : FCC CLASS-B 3m HF-ANT_130829 HORIZONTAL            RBW:1000.000KHz VBW:3000.000KHz SWT:Auto            Detector : Peak            : RBW (6dB)</p>	<p>Site : 03CH07-HY            Condition : FCC CLASS-B 3m HF-ANT_130829 VERTICAL            RBW:1000.000KHz VBW:3000.000KHz SWT:Auto            Detector : Peak            : RBW (6dB)</p>
<b>Avg.</b>	<p>Site : 03CH07-HY            Condition : FCC CLASS-B (AVG) 3m HF-ANT_130829 HORIZONTAL            RBW:1000.000KHz VBW:1.000KHz SWT:Auto            Detector : Peak            : RBW (6dB)</p>	<p>Site : 03CH07-HY            Condition : FCC CLASS-B (AVG) 3m HF-ANT_130829 VERTICAL            RBW:1000.000KHz VBW:1.000KHz SWT:Auto            Detector : Peak            : RBW (6dB)</p>



WIFI	Band 1 5150~5250MHz Band Edge @ 3m	
ANT	802.11n HT40 CH38 5190MHz - High channel location	
1+2	Horizontal	Vertical
<p><b>Peak</b></p>	<p>Date: 2015-08-25</p> <p>Site : 03CH07-HY            Condition : FCC CLASS-B 3m HF-ANT_130829 HORIZONTAL            RBW:1000.000KHz VBW:3000.000KHz SWT:Auto            Detector : Peak            ----- : RBW (6dB)</p>	<p>Date: 2015-08-25</p> <p>Site : 03CH07-HY            Condition : FCC CLASS-B 3m HF-ANT_130829 VERTICAL            RBW:1000.000KHz VBW:3000.000KHz SWT:Auto            Detector : Peak            ----- : RBW (6dB)</p>
<p><b>Avg.</b></p>	<p>Date: 2015-08-25</p> <p>Site : 03CH07-HY            Condition : FCC CLASS-B (AVG) 3m HF-ANT_130829 HORIZONTAL            RBW:1000.000KHz VBW:1.000KHz SWT:Auto            Detector : Peak            ----- : RBW (6dB)</p>	<p>Date: 2015-08-25</p> <p>Site : 03CH07-HY            Condition : FCC CLASS-B (AVG) 3m HF-ANT_130829 VERTICAL            RBW:1000.000KHz VBW:1.000KHz SWT:Auto            Detector : Peak            ----- : RBW (6dB)</p>

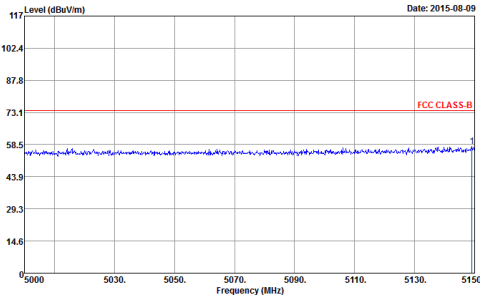
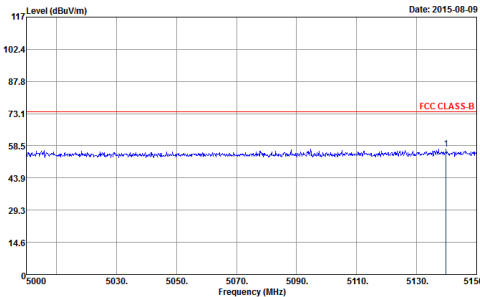
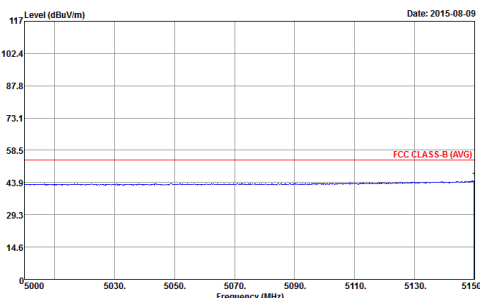
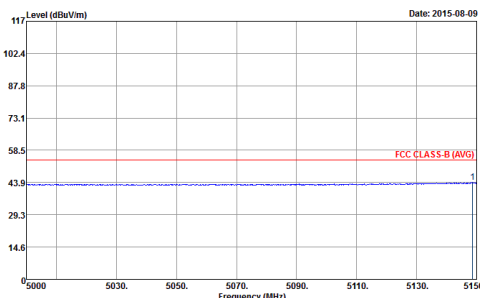

WIFI	Band 1 5150~5250MHz Band Edge @ 3m	
ANT	802.11n HT40 CH46 5230MHz - Low channel location	
1	Horizontal	Vertical
Peak	 <p>Level (dBuV/m) vs Frequency (MHz) plot for Horizontal orientation. The plot shows a blue signal line fluctuating around a mean level of approximately 58.5 dBuV/m, with a red horizontal line indicating the FCC CLASS-B limit at 73.1 dBuV/m. The x-axis ranges from 5000 to 5150 MHz, and the y-axis ranges from 0 to 117 dBuV/m.</p> <p>Site : 03CH07-HY            Condition : FCC CLASS-B 3m HF-ANT_130829 HORIZONTAL            RBW:1000.000kHz VBW:3000.000kHz SWT:Auto            Detector : Peak</p>	 <p>Level (dBuV/m) vs Frequency (MHz) plot for Vertical orientation. The plot shows a blue signal line fluctuating around a mean level of approximately 58.5 dBuV/m, with a red horizontal line indicating the FCC CLASS-B limit at 73.1 dBuV/m. The x-axis ranges from 5000 to 5150 MHz, and the y-axis ranges from 0 to 117 dBuV/m.</p> <p>Site : 03CH07-HY            Condition : FCC CLASS-B 3m HF-ANT_130829 VERTICAL            RBW:1000.000kHz VBW:3000.000kHz SWT:Auto            Detector : Peak</p>
Avg.	 <p>Level (dBuV/m) vs Frequency (MHz) plot for Horizontal orientation showing average levels. The blue signal line is a flat line at approximately 43.9 dBuV/m, with a red horizontal line indicating the FCC CLASS-B (AVG) limit at 58.5 dBuV/m. The x-axis ranges from 5000 to 5150 MHz, and the y-axis ranges from 0 to 117 dBuV/m.</p> <p>Site : 03CH07-HY            Condition : FCC CLASS-B (AVG) 3m HF-ANT_130829 HORIZONTAL            RBW:1000.000kHz VBW:1.000kHz SWT:Auto            Detector : Peak</p>	 <p>Level (dBuV/m) vs Frequency (MHz) plot for Vertical orientation showing average levels. The blue signal line is a flat line at approximately 43.9 dBuV/m, with a red horizontal line indicating the FCC CLASS-B (AVG) limit at 58.5 dBuV/m. The x-axis ranges from 5000 to 5150 MHz, and the y-axis ranges from 0 to 117 dBuV/m.</p> <p>Site : 03CH07-HY            Condition : FCC CLASS-B (AVG) 3m HF-ANT_130829 VERTICAL            RBW:1000.000kHz VBW:1.000kHz SWT:Auto            Detector : Peak</p>



WIFI	Band 1 5150~5250MHz Band Edge @ 3m	
ANT	802.11n HT40 CH46 5230MHz - High channel location	
1+2	Horizontal	Vertical
Peak	<p>Site : 03CH07-HY            Condition : FCC CLASS-B 3m HF-ANT_130829 HORIZONTAL            RBW:1000.000KHz VBW:3000.000KHz SWT:Auto            Detector : Peak</p>	<p>Site : 03CH07-HY            Condition : FCC CLASS-B 3m HF-ANT_130829 VERTICAL            RBW:1000.000KHz VBW:3000.000KHz SWT:Auto            Detector : Peak</p>
Avg.	<p>Site : 03CH07-HY            Condition : FCC CLASS-B (AVG) 3m HF-ANT_130829 HORIZONTAL            RBW:1000.000KHz VBW:1.000KHz SWT:Auto            Detector : Peak</p>	<p>Site : 03CH07-HY            Condition : FCC CLASS-B (AVG) 3m HF-ANT_130829 VERTICAL            RBW:1000.000KHz VBW:1.000KHz SWT:Auto            Detector : Peak</p>



**Band 1 5150~5250MHz**  
**WIFI 802.11ac VHT80 (Band Edge @ 3m)**

WIFI	Band 1 5150~5250MHz Band Edge @ 3m	
ANT	802.11ac VHT80 CH42 5210MHz - Low channel location	
1	Horizontal	Vertical
<b>Peak</b>	<p>Site : 03CH07-HY            Condition : FCC CLASS-B 3m HF-ANT_130829 HORIZONTAL            RBW:1000.000kHz VBW:3000.000kHz SWT:Auto            Detector : Peak            : RBW (6dB)</p>	<p>Site : 03CH07-HY            Condition : FCC CLASS-B 3m HF-ANT_130829 VERTICAL            RBW:1000.000kHz VBW:3000.000kHz SWT:Auto            Detector : Peak            : RBW (6dB)</p>
<b>Avg.</b>	<p>Site : 03CH07-HY            Condition : FCC CLASS-B (AVG) 3m HF-ANT_130829 HORIZONTAL            RBW:1000.000kHz VBW:2.000kHz SWT:Auto            Detector : Peak            : RBW (6dB)</p>	<p>Site : 03CH07-HY            Condition : FCC CLASS-B (AVG) 3m HF-ANT_130829 VERTICAL            RBW:1000.000kHz VBW:2.000kHz SWT:Auto            Detector : Peak            : RBW (6dB)</p>

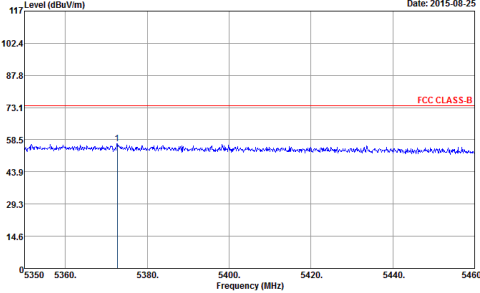
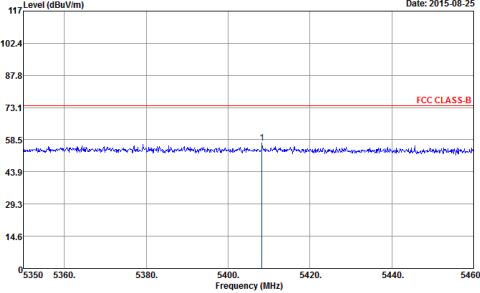
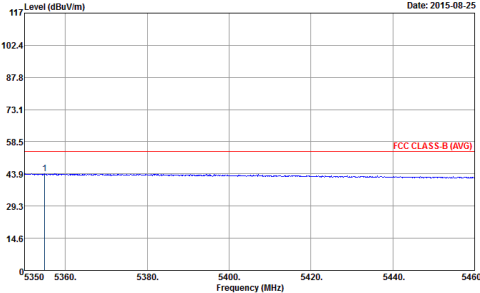
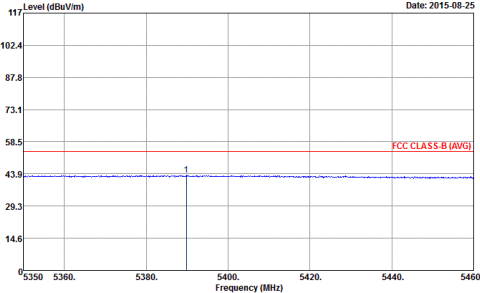

WIFI	Band 1 5150~5250MHz Band Edge @ 3m	
ANT	802.11ac VHT80 CH42 5210MHz - High channel location	
1	Horizontal	Vertical
Peak	 <p>Site : 03CH07-HY Condition : FCC CLASS-B 3m HF-ANT_130829 HORIZONTAL Detector : Peak RBW (6dB)</p>	 <p>Site : 03CH07-HY Condition : FCC CLASS-B 3m HF-ANT_130829 VERTICAL Detector : Peak RBW (6dB)</p>
Avg.	 <p>Site : 03CH07-HY Condition : FCC CLASS-B (AVG) 3m HF-ANT_130829 HORIZONTAL Detector : Peak RBW (6dB)</p>	 <p>Site : 03CH07-HY Condition : FCC CLASS-B (AVG) 3m HF-ANT_130829 VERTICAL Detector : Peak RBW (6dB)</p>



**Band 1 - 5150~5250MHz**

**WIFI 802.11a (Harmonic @ 3m)**

WIFI	Band 1 5150~5250MHz Harmonic @ 3m	
ANT	802.11a CH36 5180MHz	
1	Horizontal	Vertical
Peak Avg.	<p>Site : 03CH07-HY Condition : FCC CLASS-B 3m SHF-EHF_131029 HORIZONTAL Detector : Peak</p>	<p>Site : 03CH07-HY Condition : FCC CLASS-B 3m SHF-EHF_131029 VERTICAL Detector : Peak</p>

WIFI	Band 1 5150~5250MHz Harmonic @ 3m	
ANT	802.11a CH44 5220MHz	
1	Horizontal	Vertical
Peak Avg.	<p>Site : 03CH07-HY Condition : FCC CLASS-B 3m SHF-EHF_131029 HORIZONTAL Detector : Peak</p>	<p>Site : 03CH07-HY Condition : FCC CLASS-B 3m SHF-EHF_131029 VERTICAL Detector : Peak</p>



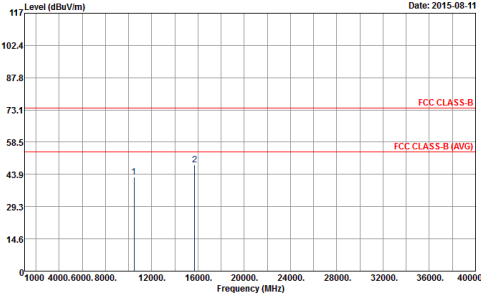
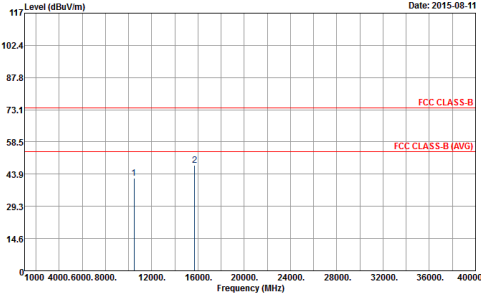

WIFI	Band 1 5150~5250MHz Harmonic @ 3m	
ANT	802.11a CH48 5240MHz	
1	Horizontal	Vertical
Peak Avg.	 <p>Site : 03CH07-HY Condition : FCC CLASS-B 3m SHF-EHF_131029 HORIZONTAL Detector : Peak</p>	 <p>Site : 03CH07-HY Condition : FCC CLASS-B 3m SHF-EHF_131029 VERTICAL Detector : Peak</p>



**Band 1 5150~5250MHz**  
**WIFI 802.11n HT20 (Harmonic @ 3m)**

<b>WIFI</b>	<b>Band 1 5150~5250MHz Harmonic @ 3m</b>	
<b>ANT</b>	<b>802.11n HT20 CH36 5180MHz</b>	
<b>1</b>	<b>Horizontal</b>	<b>Vertical</b>
<b>Peak</b> <b>Avg.</b>	<p>Site : 03CH07-HY Condition : FCC CLASS-B 3m SHF-EHF_131029 HORIZONTAL Detector : Peak</p>	<p>Site : 03CH07-HY Condition : FCC CLASS-B 3m SHF-EHF_131029 VERTICAL Detector : Peak</p>

<b>WIFI</b>	<b>Band 1 5150~5250MHz Harmonic @ 3m</b>	
<b>ANT</b>	<b>802.11n HT20 CH44 5220MHz</b>	
<b>1</b>	<b>Horizontal</b>	<b>Vertical</b>
<b>Peak</b> <b>Avg.</b>	<p>Site : 03CH07-HY Condition : FCC CLASS-B 3m SHF-EHF_131029 HORIZONTAL Detector : Peak</p>	<p>Site : 03CH07-HY Condition : FCC CLASS-B 3m SHF-EHF_131029 VERTICAL Detector : Peak</p>



WIFI	Band 1 5150~5250MHz Harmonic @ 3m	
ANT	802.11n HT20 CH48 5240MHz	
1	Horizontal	Vertical
Peak Avg.	<p>Site : 03CH07-HY Condition : FCC CLASS-B 3m SHF-EHF_131029 HORIZONTAL Detector : Peak</p>	<p>Site : 03CH07-HY Condition : FCC CLASS-B 3m SHF-EHF_131029 VERTICAL Detector : Peak</p>



**Band 1 5150~5250MHz**  
**WIFI 802.11n HT40 (Harmonic @ 3m)**

<b>WIFI</b>	<b>Band 1 5150~5250MHz Harmonic @ 3m</b>	
<b>ANT</b>	<b>802.11n HT40 CH38 5190MHz</b>	
<b>1</b>	<b>Horizontal</b>	<b>Vertical</b>
<b>Peak</b> <b>Avg.</b>	<p>Site : 03CH07-HY Condition : FCC CLASS-B 3m SHF-EHF_131029 HORIZONTAL Detector : Peak</p>	<p>Site : 03CH07-HY Condition : FCC CLASS-B 3m SHF-EHF_131029 VERTICAL Detector : Peak</p>

<b>WIFI</b>	<b>Band 1 5150~5250MHz Harmonic @ 3m</b>	
<b>ANT</b>	<b>802.11n HT40 CH46 5230MHz</b>	
<b>1</b>	<b>Horizontal</b>	<b>Vertical</b>
<b>Peak</b> <b>Avg.</b>	<p>Site : 03CH07-HY Condition : FCC CLASS-B 3m SHF-EHF_131029 HORIZONTAL Detector : Peak</p>	<p>Site : 03CH07-HY Condition : FCC CLASS-B 3m SHF-EHF_131029 VERTICAL Detector : Peak</p>



**Band 1 5150~5250MHz  
WIFI 802.11ac VHT80 (Harmonic @ 3m)**

WIFI	Band 1 5150~5250MHz Harmonic @ 3m	
ANT	802.11ac VHT80 CH42 5210MHz	
1	Horizontal	Vertical
<p><b>Peak</b> <b>Avg.</b></p>	<p>Date: 2015-08-12</p> <p>Site : 03CH07-HY Condition : FCC CLASS-B 3m SHF-EHF_131029 HORIZONTAL Detector : Peak</p>	<p>Date: 2015-08-12</p> <p>Site : 03CH07-HY Condition : FCC CLASS-B 3m SHF-EHF_131029 VERTICAL Detector : Peak</p>



**Band 2 - 5250~5350MHz**  
**WIFI 802.11a (Band Edge @ 3m)**

WIFI	Band 2 5250~5350MHz Band Edge @ 3m	
ANT	802.11a CH52 5260MHz	
1	Horizontal	Vertical
<b>Peak</b>	<p>Site : 03CH07-HY            Condition : FCC CLASS-B 3m HF-ANT_130829 HORIZONTAL            RBW:1000.000KHz VBW:3000.000KHz SWT:Auto            Detector : Peak</p>	<p>Site : 03CH07-HY            Condition : FCC CLASS-B 3m HF-ANT_130829 VERTICAL            RBW:1000.000KHz VBW:3000.000KHz SWT:Auto            Detector : Peak</p>
<b>Avg.</b>	<p>Site : 03CH07-HY            Condition : FCC CLASS-B (AVG) 3m HF-ANT_130829 HORIZONTAL            RBW:1000.000KHz VBW:0.010KHz SWT:Auto            Detector : Peak</p>	<p>Site : 03CH07-HY            Condition : FCC CLASS-B (AVG) 3m HF-ANT_130829 VERTICAL            RBW:1000.000KHz VBW:0.010KHz SWT:Auto            Detector : Peak</p>

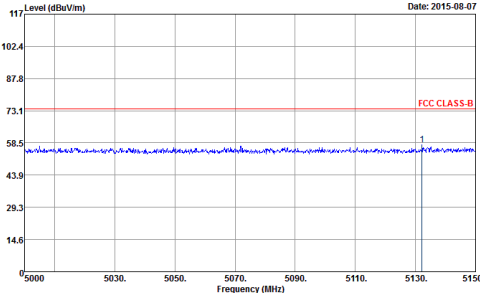
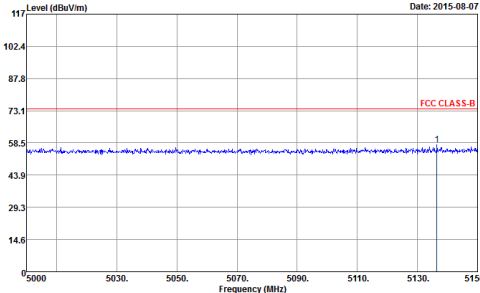
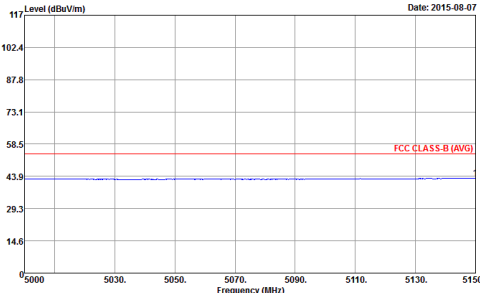
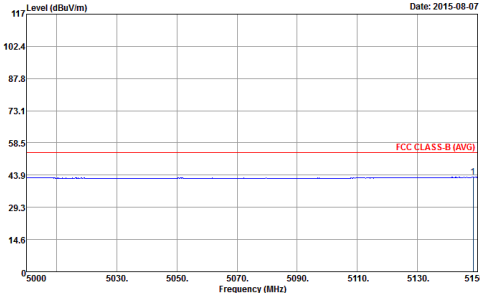

WIFI	Band 2 5250~5350MHz Band Edge @ 3m	
ANT	802.11a CH60 5300MHz - Low channel location	
1	Horizontal	Vertical
Peak	 <p>Site : 03CH07-HY            Condition : FCC CLASS-B 3m HF-ANT_130829 HORIZONTAL            RBW:1000.000KHz VBW:3000.000KHz SWT:Auto            Detector : Peak</p>	 <p>Site : 03CH07-HY            Condition : FCC CLASS-B 3m HF-ANT_130829 VERTICAL            RBW:1000.000KHz VBW:3000.000KHz SWT:Auto            Detector : Peak</p>
Avg.	 <p>Site : 03CH07-HY            Condition : FCC CLASS-B (AVG) 3m HF-ANT_130829 HORIZONTAL            RBW:1000.000KHz VBW:0.010KHz SWT:Auto            Detector : Peak</p>	 <p>Site : 03CH07-HY            Condition : FCC CLASS-B (AVG) 3m HF-ANT_130829 VERTICAL            RBW:1000.000KHz VBW:0.010KHz SWT:Auto            Detector : Peak</p>

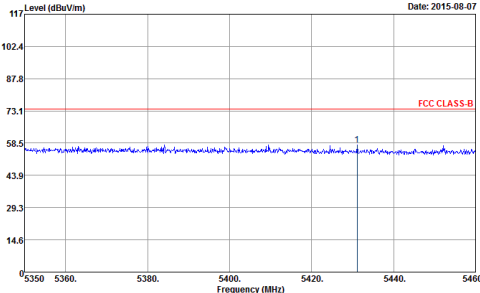
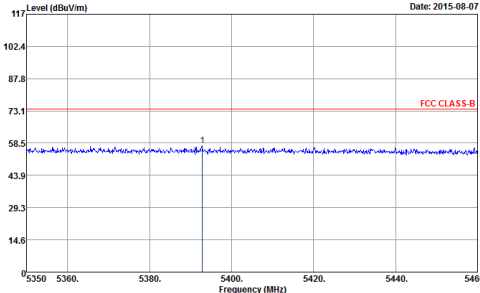
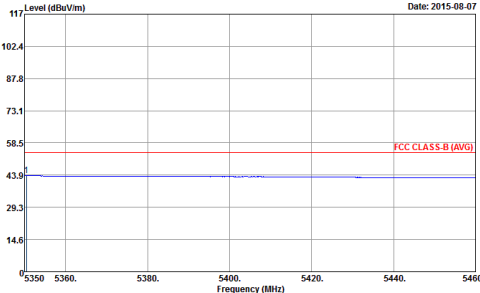
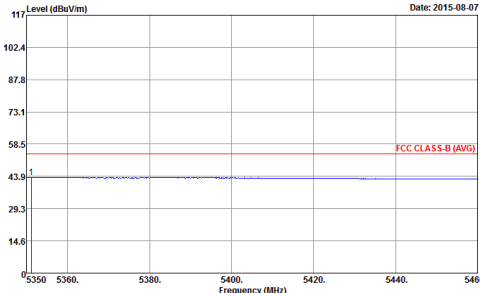

WIFI	Band 2 5250~5350MHz Band Edge @ 3m	
ANT	802.11a CH60 5300MHz - High channel location	
1	Horizontal	Vertical
Peak	 <p>Level (dBuV/m) vs Frequency (MHz) plot for Horizontal orientation. The y-axis ranges from 14.6 to 117 dBuV/m, and the x-axis ranges from 5350 to 5460 MHz. A red horizontal line at 73.1 dBuV/m is labeled 'FCC CLASS-B'. A blue signal line fluctuates around 58.5 dBuV/m. A peak is marked with a vertical line at approximately 5430 MHz.</p> <p>Site : 03CH07-HY            Condition : FCC CLASS-B 3m HF-ANT_130829 HORIZONTAL            RBW:1000.000kHz VBW:3000.000kHz SWT:Auto            Detector : Peak</p>	 <p>Level (dBuV/m) vs Frequency (MHz) plot for Vertical orientation. The y-axis ranges from 14.6 to 117 dBuV/m, and the x-axis ranges from 5350 to 5460 MHz. A red horizontal line at 73.1 dBuV/m is labeled 'FCC CLASS-B'. A blue signal line fluctuates around 58.5 dBuV/m. A peak is marked with a vertical line at approximately 5430 MHz.</p> <p>Site : 03CH07-HY            Condition : FCC CLASS-B 3m HF-ANT_130829 VERTICAL            RBW:1000.000kHz VBW:3000.000kHz SWT:Auto            Detector : Peak</p>
Avg.	 <p>Level (dBuV/m) vs Frequency (MHz) plot for Horizontal orientation. The y-axis ranges from 14.6 to 117 dBuV/m, and the x-axis ranges from 5350 to 5460 MHz. A red horizontal line at 58.5 dBuV/m is labeled 'FCC CLASS-B (AVG)'. A blue signal line fluctuates around 43.9 dBuV/m.</p> <p>Site : 03CH07-HY            Condition : FCC CLASS-B (AVG) 3m HF-ANT_130829 HORIZONTAL            RBW:1000.000kHz VBW:0.010kHz SWT:Auto            Detector : Peak</p>	 <p>Level (dBuV/m) vs Frequency (MHz) plot for Vertical orientation. The y-axis ranges from 14.6 to 117 dBuV/m, and the x-axis ranges from 5350 to 5460 MHz. A red horizontal line at 58.5 dBuV/m is labeled 'FCC CLASS-B (AVG)'. A blue signal line fluctuates around 43.9 dBuV/m.</p> <p>Site : 03CH07-HY            Condition : FCC CLASS-B (AVG) 3m HF-ANT_130829 VERTICAL            RBW:1000.000kHz VBW:0.010kHz SWT:Auto            Detector : Peak</p>



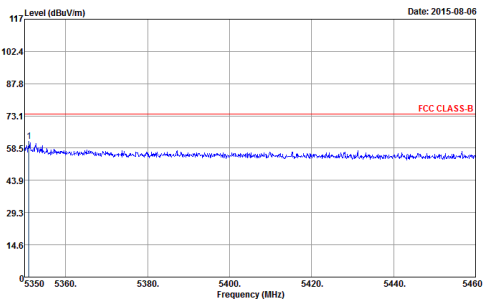
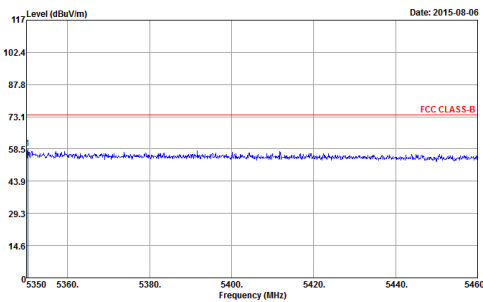
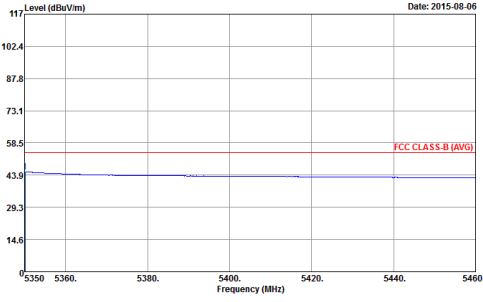
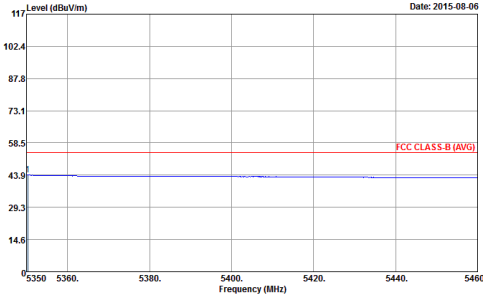

WIFI	Band 2 5250~5350MHz Band Edge @ 3m	
ANT	802.11a CH64 5320MHz	
1	Horizontal	Vertical
Peak	 <p>Level (dBuV/m) vs Frequency (MHz) for Horizontal orientation. The plot shows a blue signal line fluctuating around 58.5 dBuV/m, with a red horizontal line at 73.1 dBuV/m labeled 'FCC CLASS-B'. The x-axis ranges from 5350 to 5460 MHz, and the y-axis ranges from 14.6 to 117 dBuV/m.</p> <p>Site : 03CH07-HY            Condition : FCC CLASS-B 3m HF-ANT_130829 HORIZONTAL            RBW:1000.000KHz VBW:3000.000KHz SWT:Auto            Detector : Peak</p>	 <p>Level (dBuV/m) vs Frequency (MHz) for Vertical orientation. The plot shows a blue signal line fluctuating around 58.5 dBuV/m, with a red horizontal line at 73.1 dBuV/m labeled 'FCC CLASS-B'. The x-axis ranges from 5350 to 5460 MHz, and the y-axis ranges from 14.6 to 117 dBuV/m.</p> <p>Site : 03CH07-HY            Condition : FCC CLASS-B 3m HF-ANT_130829 VERTICAL            RBW:1000.000KHz VBW:3000.000KHz SWT:Auto            Detector : Peak</p>
Avg.	 <p>Level (dBuV/m) vs Frequency (MHz) for Horizontal orientation. The plot shows a blue signal line fluctuating around 43.9 dBuV/m, with a red horizontal line at 58.5 dBuV/m labeled 'FCC CLASS-B (AVG)'. The x-axis ranges from 5350 to 5460 MHz, and the y-axis ranges from 14.6 to 117 dBuV/m.</p> <p>Site : 03CH07-HY            Condition : FCC CLASS-B (AVG) 3m HF-ANT_130829 HORIZONTAL            RBW:1000.000KHz VBW:0.010KHz SWT:Auto            Detector : Peak</p>	 <p>Level (dBuV/m) vs Frequency (MHz) for Vertical orientation. The plot shows a blue signal line fluctuating around 43.9 dBuV/m, with a red horizontal line at 58.5 dBuV/m labeled 'FCC CLASS-B (AVG)'. The x-axis ranges from 5350 to 5460 MHz, and the y-axis ranges from 14.6 to 117 dBuV/m.</p> <p>Site : 03CH07-HY            Condition : FCC CLASS-B (AVG) 3m HF-ANT_130829 VERTICAL            RBW:1000.000KHz VBW:0.010KHz SWT:Auto            Detector : Peak</p>

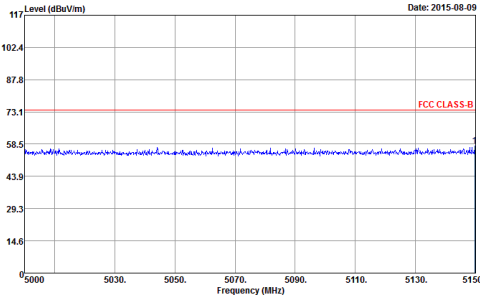
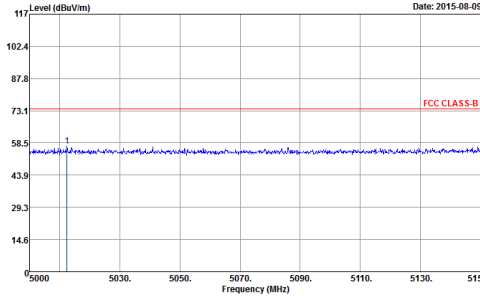
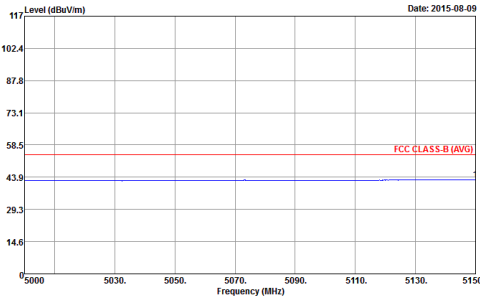
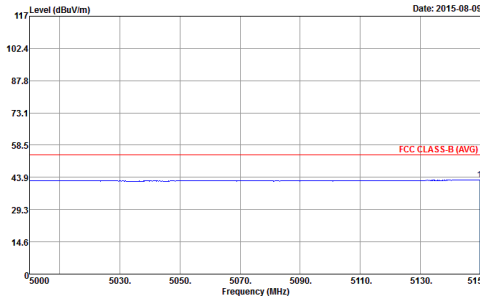

**Band 2 5250~5350MHz  
WIFI 802.11n HT20 (Band Edge @ 3m)**

WIFI	Band 2 5250~5350MHz Band Edge @ 3m	
ANT	802.11n HT20 CH52 5260MHz - Low channel location	
1	Horizontal	Vertical
<b>Peak</b>	 <p>Level (dBuV/m) vs Frequency (MHz) for Horizontal orientation. The plot shows a blue signal line fluctuating around a mean level of approximately 58.5 dBuV/m, with a red horizontal line indicating the FCC CLASS-B limit at 73.1 dBuV/m. The x-axis ranges from 5000 to 5150 MHz, and the y-axis ranges from 14.6 to 117 dBuV/m.</p> <p>Site : 03CH07-HY Condition : FCC CLASS-B 3m HF-ANT_130829 HORIZONTAL RBW:1000.000kHz VBW:3000.000kHz SWT:Auto Detector : Peak</p>	 <p>Level (dBuV/m) vs Frequency (MHz) for Vertical orientation. The plot shows a blue signal line fluctuating around a mean level of approximately 58.5 dBuV/m, with a red horizontal line indicating the FCC CLASS-B limit at 73.1 dBuV/m. The x-axis ranges from 5000 to 5150 MHz, and the y-axis ranges from 14.6 to 117 dBuV/m.</p> <p>Site : 03CH07-HY Condition : FCC CLASS-B 3m HF-ANT_130829 VERTICAL RBW:1000.000kHz VBW:3000.000kHz SWT:Auto Detector : Peak</p>
<b>Avg.</b>	 <p>Level (dBuV/m) vs Frequency (MHz) for Horizontal orientation (Average). The plot shows a blue signal line fluctuating around a mean level of approximately 43.9 dBuV/m, with a red horizontal line indicating the FCC CLASS-B (AVG) limit at 58.5 dBuV/m. The x-axis ranges from 5000 to 5150 MHz, and the y-axis ranges from 14.6 to 117 dBuV/m.</p> <p>Site : 03CH07-HY Condition : FCC CLASS-B (AVG) 3m HF-ANT_130829 HORIZONTAL RBW:1000.000kHz VBW:0.010kHz SWT:Auto Detector : Peak</p>	 <p>Level (dBuV/m) vs Frequency (MHz) for Vertical orientation (Average). The plot shows a blue signal line fluctuating around a mean level of approximately 43.9 dBuV/m, with a red horizontal line indicating the FCC CLASS-B (AVG) limit at 58.5 dBuV/m. The x-axis ranges from 5000 to 5150 MHz, and the y-axis ranges from 14.6 to 117 dBuV/m.</p> <p>Site : 03CH07-HY Condition : FCC CLASS-B (AVG) 3m HF-ANT_130829 VERTICAL RBW:1000.000kHz VBW:0.010kHz SWT:Auto Detector : Peak</p>



WIFI	Band 2 5250~5350MHz Band Edge @ 3m	
ANT	802.11n HT20 CH52 5260MHz - High channel location	
1	Horizontal	Vertical
Peak	<p>Site : 03CH07-HY            Condition : FCC CLASS-B 3m HF-ANT_130829 HORIZONTAL            RBW:1000.000KHz VBW:3000.000KHz SWT:Auto            Detector : Peak</p>	<p>Site : 03CH07-HY            Condition : FCC CLASS-B 3m HF-ANT_130829 VERTICAL            RBW:1000.000KHz VBW:3000.000KHz SWT:Auto            Detector : Peak</p>
Avg.	<p>Site : 03CH07-HY            Condition : FCC CLASS-B (AVG) 3m HF-ANT_130829 HORIZONTAL            RBW:1000.000KHz VBW:0.010KHz SWT:Auto            Detector : Peak</p>	<p>Site : 03CH07-HY            Condition : FCC CLASS-B (AVG) 3m HF-ANT_130829 VERTICAL            RBW:1000.000KHz VBW:0.010KHz SWT:Auto            Detector : Peak</p>



WIFI	Band 2 5250~5350MHz Band Edge @ 3m	
ANT	802.11n HT20 CH60 5300MHz - Low channel location	
1	Horizontal	Vertical
Peak	<p>Site : 03CH07-HY            Condition : FCC CLASS-B 3m HF-ANT_130829 HORIZONTAL            RBW:1000.000kHz VBW:3000.000kHz SWT:Auto            Detector : Peak</p>	<p>Site : 03CH07-HY            Condition : FCC CLASS-B 3m HF-ANT_130829 VERTICAL            RBW:1000.000kHz VBW:3000.000kHz SWT:Auto            Detector : Peak</p>
Avg.	<p>Site : 03CH07-HY            Condition : FCC CLASS-B (AVG) 3m HF-ANT_130829 HORIZONTAL            RBW:1000.000kHz VBW:0.010kHz SWT:Auto            Detector : Peak</p>	<p>Site : 03CH07-HY            Condition : FCC CLASS-B (AVG) 3m HF-ANT_130829 VERTICAL            RBW:1000.000kHz VBW:0.010kHz SWT:Auto            Detector : Peak</p>



WIFI	Band 2 5250~5350MHz Band Edge @ 3m	
ANT	802.11n HT20 CH60 5300MHz - High channel location	
1	Horizontal	Vertical
Peak	<p>Date: 2015-08-09</p> <p>Site : 03CH07-HY Condition : FCC CLASS-B 3m HF-ANT_130829 HORIZONTAL Detector : Peak</p>	<p>Date: 2015-08-09</p> <p>Site : 03CH07-HY Condition : FCC CLASS-B 3m HF-ANT_130829 VERTICAL Detector : Peak</p>
Avg.	<p>Date: 2015-08-09</p> <p>Site : 03CH07-HY Condition : FCC CLASS-B (AVG) 3m HF-ANT_130829 HORIZONTAL Detector : Peak</p>	<p>Date: 2015-08-09</p> <p>Site : 03CH07-HY Condition : FCC CLASS-B (AVG) 3m HF-ANT_130829 VERTICAL Detector : Peak</p>



WIFI	Band 2 5250~5350MHz Band Edge @ 3m	
ANT	802.11n HT20 CH64 5320MHz	
1	Horizontal	Vertical
Peak	<p>Site : 03CH07-HY            Condition : FCC CLASS-B 3m HF-ANT_130829 HORIZONTAL            RBW:1000.000KHz VBW:3000.000KHz SWT:Auto            Detector : Peak</p>	<p>Site : 03CH07-HY            Condition : FCC CLASS-B 3m HF-ANT_130829 VERTICAL            RBW:1000.000KHz VBW:3000.000KHz SWT:Auto            Detector : Peak</p>
Avg.	<p>Site : 03CH07-HY            Condition : FCC CLASS-B (AVG) 3m HF-ANT_130829 HORIZONTAL            RBW:1000.000KHz VBW:0.010KHz SWT:Auto            Detector : Peak</p>	<p>Site : 03CH07-HY            Condition : FCC CLASS-B (AVG) 3m HF-ANT_130829 VERTICAL            RBW:1000.000KHz VBW:0.010KHz SWT:Auto            Detector : Peak</p>



Band 2 5250~5350MHz
WIFI 802.11n HT40 (Band Edge @ 3m)

Table with 4 quadrants: Peak Horizontal, Peak Vertical, Avg. Horizontal, Avg. Vertical. Each quadrant contains a graph of Level (dBuV/m) vs Frequency (MHz) with FCC CLASS-B limits and test parameters.

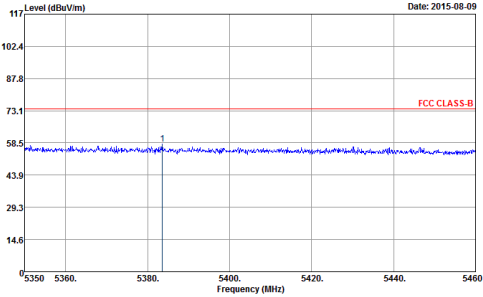
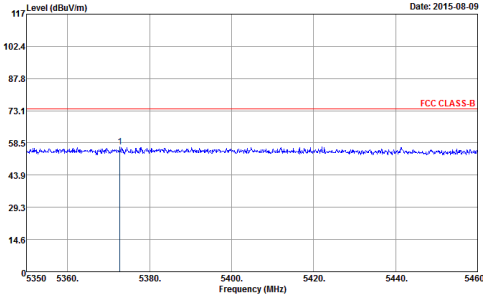
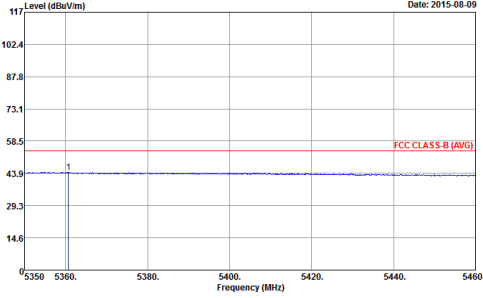
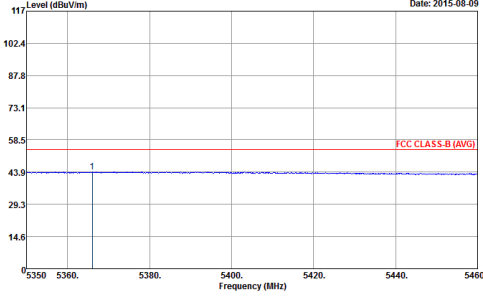

WIFI	Band 2 5250~5350MHz Band Edge @ 3m	
ANT	802.11n HT40 CH54 5270 MHz - High channel location	
1	Horizontal	Vertical
Peak	 <p>Site : 03CH07-HY Condition : FCC CLASS-B 3m HF-ANT_130829 HORIZONTAL RBW:1000.000KHz VBW:3000.000KHz SWT:Auto Detector : Peak</p>	 <p>Site : 03CH07-HY Condition : FCC CLASS-B 3m HF-ANT_130829 VERTICAL RBW:1000.000KHz VBW:3000.000KHz SWT:Auto Detector : Peak</p>
Avg.	 <p>Site : 03CH07-HY Condition : FCC CLASS-B (AVG) 3m HF-ANT_130829 HORIZONTAL RBW:1000.000KHz VBW:1.000KHz SWT:Auto Detector : Peak</p>	 <p>Site : 03CH07-HY Condition : FCC CLASS-B (AVG) 3m HF-ANT_130829 VERTICAL RBW:1000.000KHz VBW:1.000KHz SWT:Auto Detector : Peak</p>





WIFI	Band 2 5250~5350MHz Band Edge @ 3m	
ANT	802.11n HT40 CH62 5310 MHz - Low channel location	
1	Horizontal	Vertical
Peak	<p>Site : 03CH07-HY            Condition : FCC CLASS-B 3m HF-ANT_130829 HORIZONTAL            RBW:1000.000KHz VBW:3000.000KHz SWT:Auto            Detector : Peak</p>	<p>Site : 03CH07-HY            Condition : FCC CLASS-B 3m HF-ANT_130829 VERTICAL            RBW:1000.000KHz VBW:3000.000KHz SWT:Auto            Detector : Peak</p>
Avg.	<p>Site : 03CH07-HY            Condition : FCC CLASS-B (AVG) 3m HF-ANT_130829 HORIZONTAL            RBW:1000.000KHz VBW:1.000KHz SWT:Auto            Detector : Peak</p>	<p>Site : 03CH07-HY            Condition : FCC CLASS-B (AVG) 3m HF-ANT_130829 VERTICAL            RBW:1000.000KHz VBW:1.000KHz SWT:Auto            Detector : Peak</p>

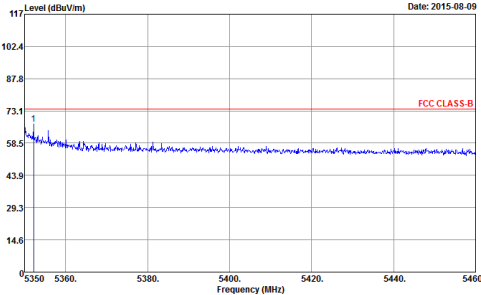
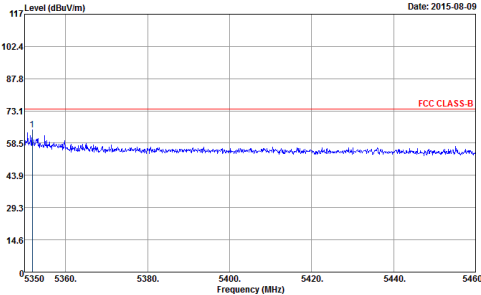
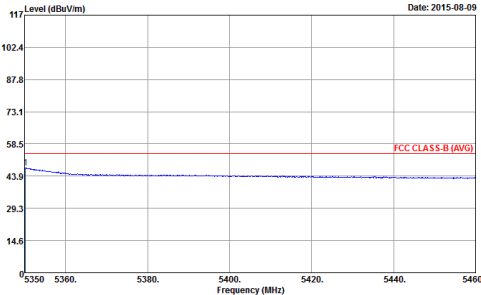
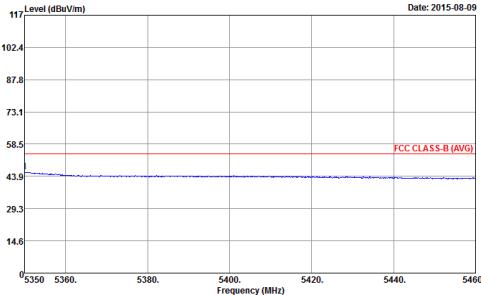

WIFI	Band 2 5250~5350MHz Band Edge @ 3m	
ANT	802.11n HT40 CH62 5310 MHz - High channel location	
1	Horizontal	Vertical
Peak	 <p>Level (dBuV/m) vs Frequency (MHz) plot for Horizontal orientation. The y-axis ranges from 0 to 117 dBuV/m, and the x-axis ranges from 5350 to 5460 MHz. A red horizontal line indicates the FCC CLASS-B limit at 73.1 dBuV/m. The measured signal (blue line) fluctuates around 58.5 dBuV/m, well below the limit.</p> <p>Site : 03CH07-HY            Condition : FCC CLASS-B 3m HF-ANT_130829 HORIZONTAL            RBW:1000.000KHz VBW:3000.000KHz SWT:Auto            Detector : Peak</p>	 <p>Level (dBuV/m) vs Frequency (MHz) plot for Vertical orientation. The y-axis ranges from 0 to 117 dBuV/m, and the x-axis ranges from 5350 to 5460 MHz. A red horizontal line indicates the FCC CLASS-B limit at 73.1 dBuV/m. The measured signal (blue line) fluctuates around 58.5 dBuV/m, well below the limit.</p> <p>Site : 03CH07-HY            Condition : FCC CLASS-B 3m HF-ANT_130829 VERTICAL            RBW:1000.000KHz VBW:3000.000KHz SWT:Auto            Detector : Peak</p>
Avg.	 <p>Level (dBuV/m) vs Frequency (MHz) plot for Horizontal orientation showing the average signal. The y-axis ranges from 0 to 117 dBuV/m, and the x-axis ranges from 5350 to 5460 MHz. A red horizontal line indicates the FCC CLASS-B (AVG) limit at 58.5 dBuV/m. The measured average signal (blue line) is consistently around 43.0 dBuV/m.</p> <p>Site : 03CH07-HY            Condition : FCC CLASS-B (AVG) 3m HF-ANT_130829 HORIZONTAL            RBW:1000.000KHz VBW:1.000KHz SWT:Auto            Detector : Peak</p>	 <p>Level (dBuV/m) vs Frequency (MHz) plot for Vertical orientation showing the average signal. The y-axis ranges from 0 to 117 dBuV/m, and the x-axis ranges from 5350 to 5460 MHz. A red horizontal line indicates the FCC CLASS-B (AVG) limit at 58.5 dBuV/m. The measured average signal (blue line) is consistently around 43.0 dBuV/m.</p> <p>Site : 03CH07-HY            Condition : FCC CLASS-B (AVG) 3m HF-ANT_130829 VERTICAL            RBW:1000.000KHz VBW:1.000KHz SWT:Auto            Detector : Peak</p>



Band 2 5250~5350MHz
WIFI 802.11ac VHT80 (Band Edge @ 3m)

Table with 4 quadrants: Peak Horizontal, Peak Vertical, Avg. Horizontal, Avg. Vertical. Each quadrant contains a graph of Level (dBuV/m) vs Frequency (MHz) with FCC CLASS-B limits and test parameters.

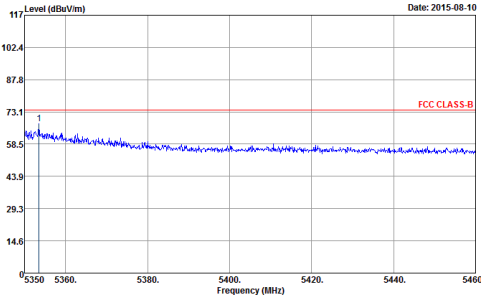
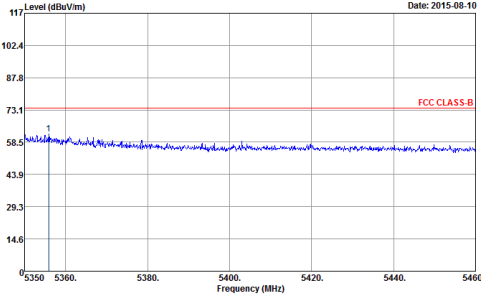
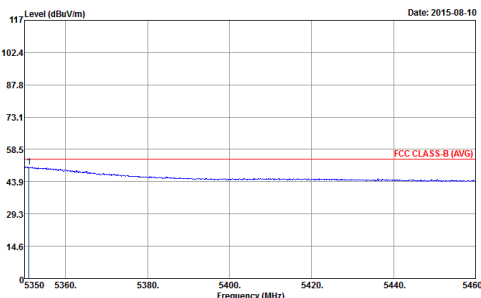
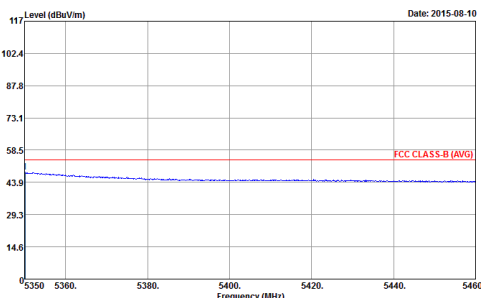

WIFI	Band 2 5250~5350MHz Band Edge @ 3m	
ANT	802.11ac VHT80 CH58 5290MHz - High channel location	
1	Horizontal	Vertical
Peak	 <p>Site : 03CH07-HY Condition : FCC CLASS-B 3m HF-ANT_130829 HORIZONTAL RBW:1000.000KHz VBW:3000.000KHz SWT:Auto Detector : Peak</p>	 <p>Site : 03CH07-HY Condition : FCC CLASS-B 3m HF-ANT_130829 VERTICAL RBW:1000.000KHz VBW:3000.000KHz SWT:Auto Detector : Peak</p>
Avg.	 <p>Site : 03CH07-HY Condition : FCC CLASS-B (AVG) 3m HF-ANT_130829 HORIZONTAL RBW:1000.000KHz VBW:2.000KHz SWT:Auto Detector : Peak</p>	 <p>Site : 03CH07-HY Condition : FCC CLASS-B (AVG) 3m HF-ANT_130829 VERTICAL RBW:1000.000KHz VBW:2.000KHz SWT:Auto Detector : Peak</p>



**Band 2 - 5250~5350MHz**

**WIFI 802.11a (Harmonic @ 3m)**

<b>WIFI</b>	<b>Band 2 5250~5350MHz Harmonic @ 3m</b>	
<b>ANT</b>	<b>802.11a CH52 5260MHz</b>	
<b>1</b>	<b>Horizontal</b>	<b>Vertical</b>
<b>Peak Avg.</b>	<p>Site : 03CH07-HY Condition : FCC CLASS-B 3m SHF-EHF_131029 HORIZONTAL Detector : Peak</p>	<p>Site : 03CH07-HY Condition : FCC CLASS-B 3m SHF-EHF_131029 VERTICAL Detector : Peak</p>

<b>WIFI</b>	<b>Band 2 5250~5350MHz Harmonic @ 3m</b>	
<b>ANT</b>	<b>802.11a CH60 5300MHz</b>	
<b>1</b>	<b>Horizontal</b>	<b>Vertical</b>
<b>Peak Avg.</b>	<p>Site : 03CH07-HY Condition : FCC CLASS-B 3m SHF-EHF_131029 HORIZONTAL Detector : Peak</p>	<p>Site : 03CH07-HY Condition : FCC CLASS-B 3m SHF-EHF_131029 VERTICAL Detector : Peak</p>



WIFI	Band 2 5250~5350MHz Harmonic @ 3m	
ANT	802.11a CH64 5320MHz	
1	Horizontal	Vertical
Peak Avg.	<p>Site : 03CH07-HY Condition : FCC CLASS-B 3m SHF-EHF_131029 HORIZONTAL Detector : Peak</p>	<p>Site : 03CH07-HY Condition : FCC CLASS-B 3m SHF-EHF_131029 VERTICAL Detector : Peak</p>



**Band 2 5250~5350MHz**  
**WIFI 802.11n HT20 (Harmonic @ 3m)**

<b>WIFI</b>	<b>Band 2 5250~5350MHz Harmonic @ 3m</b>	
<b>ANT</b>	<b>802.11n HT20 CH52 5260MHz</b>	
<b>1</b>	<b>Horizontal</b>	<b>Vertical</b>
<b>Peak Avg.</b>		

<b>WIFI</b>	<b>Band 2 5250~5350MHz Harmonic @ 3m</b>	
<b>ANT</b>	<b>802.11n HT20 CH60 5300MHz</b>	
<b>1</b>	<b>Horizontal</b>	<b>Vertical</b>
<b>Peak Avg.</b>		



WIFI	Band 2 5250~5350MHz Harmonic @ 3m	
ANT	802.11n HT20 CH64 5320MHz	
1	Horizontal	Vertical
Peak Avg.	<p>Site : 03CH07-HY Condition : FCC CLASS-B 3m SHF-EHF_131029 HORIZONTAL Detector : Peak</p>	<p>Site : 03CH07-HY Condition : FCC CLASS-B 3m SHF-EHF_131029 VERTICAL Detector : Peak</p>





**Band 2 5250~5350MHz**  
**WIFI 802.11n HT40 (Harmonic @ 3m)**

<b>WIFI</b>	<b>Band 2 5250~5350MHz Harmonic @ 3m</b>	
<b>ANT</b>	<b>802.11n HT40 CH54 5270 MHz</b>	
<b>1</b>	<b>Horizontal</b>	<b>Vertical</b>
<b>Peak</b> <b>Avg.</b>	<p>Site : 03CH07-HY Condition : FCC CLASS-B 3m SHF-EHF_131029 HORIZONTAL Detector : Peak</p>	<p>Site : 03CH07-HY Condition : FCC CLASS-B 3m SHF-EHF_131029 VERTICAL Detector : Peak</p>

<b>WIFI</b>	<b>Band 2 5250~5350MHz Harmonic @ 3m</b>	
<b>ANT</b>	<b>802.11n HT40 CH62 5310 MHz</b>	
<b>1</b>	<b>Horizontal</b>	<b>Vertical</b>
<b>Peak</b> <b>Avg.</b>	<p>Site : 03CH07-HY Condition : FCC CLASS-B 3m SHF-EHF_131029 HORIZONTAL Detector : Peak</p>	<p>Site : 03CH07-HY Condition : FCC CLASS-B 3m SHF-EHF_131029 VERTICAL Detector : Peak</p>



Band 2 5250~5350MHz
WIFI 802.11ac VHT80 (Harmonic @ 3m)

Table with 2 columns: Horizontal and Vertical. Each column contains a graph showing Level (dBuV/m) vs Frequency (MHz) with FCC CLASS-B and FCC CLASS-B (AVG) limits. Includes site information: 03CH07-HY, FCC CLASS-B 3m SHF-EHF\_131029.

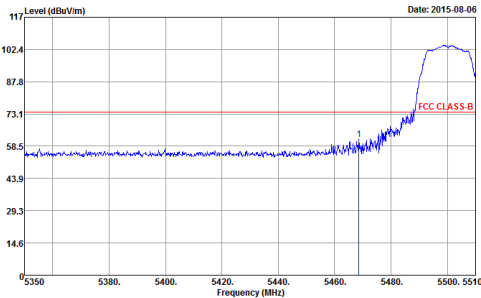
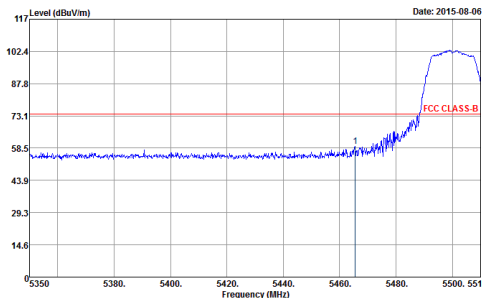
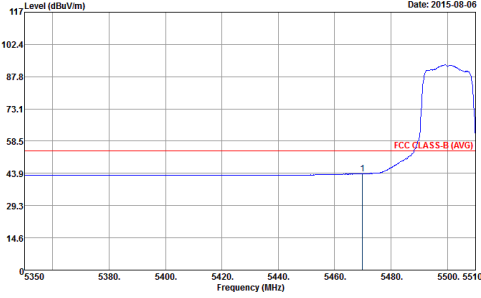
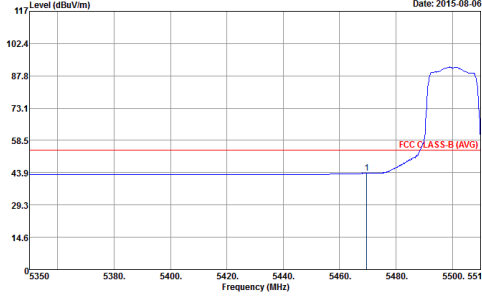

**Band 3 - 5470~5725MHz**  
**WIFI 802.11a (Band Edge @ 3m)**

WIFI	Band 3 5470~5725MHz Band Edge @ 3m	
ANT	802.11a CH100 5500MHz	
1	Horizontal	Vertical
<b>Peak</b>	 <p>Site : 03CH07-HY            Condition : FCC CLASS-B 3m HF-ANT_130829 HORIZONTAL            RBW:1000.000kHz VBW:3000.000kHz SWT:Auto            Detector : Peak</p>	 <p>Site : 03CH07-HY            Condition : FCC CLASS-B 3m HF-ANT_130829 VERTICAL            RBW:1000.000kHz VBW:3000.000kHz SWT:Auto            Detector : Peak</p>
<b>Avg.</b>	 <p>Site : 03CH07-HY            Condition : FCC CLASS-B (AVG) 3m HF-ANT_130829 HORIZONTAL            RBW:1000.000kHz VBW:0.010kHz SWT:Auto            Detector : Peak</p>	 <p>Site : 03CH07-HY            Condition : FCC CLASS-B (AVG) 3m HF-ANT_130829 VERTICAL            RBW:1000.000kHz VBW:0.010kHz SWT:Auto            Detector : Peak</p>



WIFI	Band 3 5470~5725MHz Band Edge @ 3m	
ANT	802.11a CH116 5580MHz - Low channel location	
1	Horizontal	Vertical
Peak	<p>Site : 03CH07-HY Condition : FCC CLASS-B 3m HF-ANT_130829 HORIZONTAL RBW:1000.000kHz VBW:3000.000kHz SWT:Auto Detector : Peak</p>	<p>Site : 03CH07-HY Condition : FCC CLASS-B 3m HF-ANT_130829 VERTICAL RBW:1000.000kHz VBW:3000.000kHz SWT:Auto Detector : Peak</p>
Avg.	<p>Site : 03CH07-HY Condition : FCC CLASS-B (AVG) 3m HF-ANT_130829 HORIZONTAL RBW:1000.000kHz VBW:0.010kHz SWT:Auto Detector : Peak</p>	<p>Site : 03CH07-HY Condition : FCC CLASS-B (AVG) 3m HF-ANT_130829 VERTICAL RBW:1000.000kHz VBW:0.010kHz SWT:Auto Detector : Peak</p>

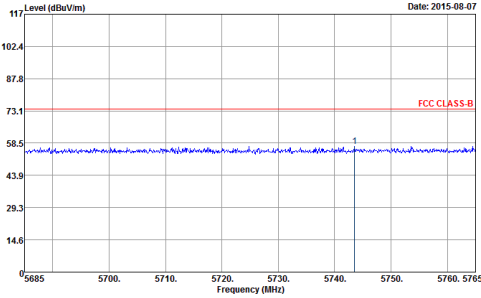
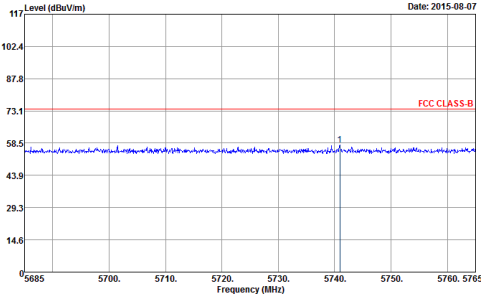
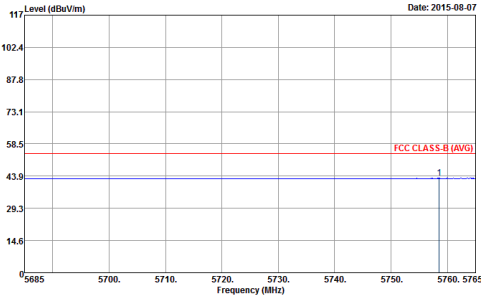
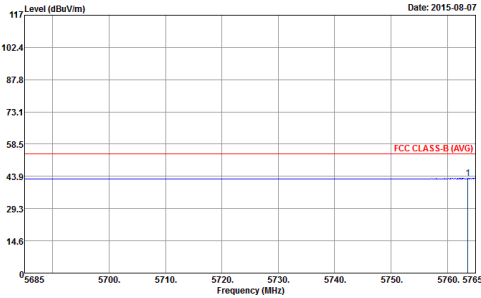

WIFI	Band 3 5470~5725MHz Band Edge @ 3m	
ANT	802.11a CH116 5580MHz - High channel location	
1	Horizontal	Vertical
Peak	 <p>Date: 2015-08-07</p> <p>Site : 03CH07-HY Condition : FCC CLASS-B 3m HF-ANT_130829 HORIZONTAL RBW:1000.000KHz VBW:3000.000KHz SWT:Auto Detector : Peak</p>	 <p>Date: 2015-08-07</p> <p>Site : 03CH07-HY Condition : FCC CLASS-B 3m HF-ANT_130829 VERTICAL RBW:1000.000KHz VBW:3000.000KHz SWT:Auto Detector : Peak</p>
Avg.	 <p>Date: 2015-08-07</p> <p>Site : 03CH07-HY Condition : FCC CLASS-B (AVG) 3m HF-ANT_130829 HORIZONTAL RBW:1000.000KHz VBW:0.010KHz SWT:Auto Detector : Peak</p>	 <p>Date: 2015-08-07</p> <p>Site : 03CH07-HY Condition : FCC CLASS-B (AVG) 3m HF-ANT_130829 VERTICAL RBW:1000.000KHz VBW:0.010KHz SWT:Auto Detector : Peak</p>

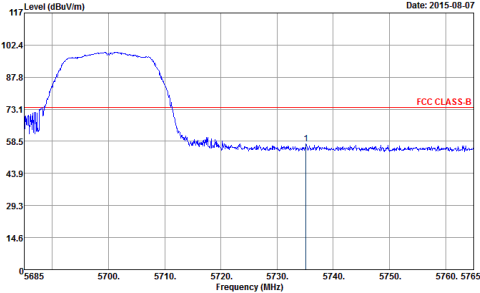
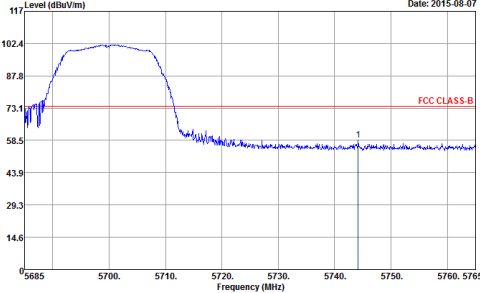
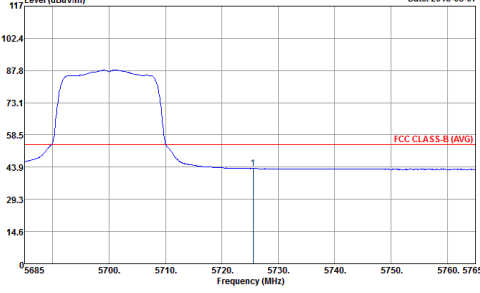
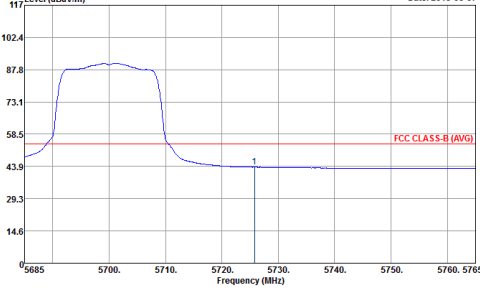

WIFI	Band 3 5470~5725MHz Band Edge @ 3m	
ANT	802.11a CH140 5700MHz	
1	Horizontal	Vertical
Peak	 <p>Site : 03CH07-HY Condition : FCC CLASS-B 3m HF-ANT_130829 HORIZONTAL RBW:1000.000kHz VBW:5000.000kHz SWT:Auto Detector : Peak</p>	 <p>Site : 03CH07-HY Condition : FCC CLASS-B 3m HF-ANT_130829 VERTICAL RBW:1000.000kHz VBW:5000.000kHz SWT:Auto Detector : Peak</p>
Avg.	 <p>Site : 03CH07-HY Condition : FCC CLASS-B (AVG) 3m HF-ANT_130829 HORIZONTAL RBW:1000.000kHz VBW:0.010kHz SWT:Auto Detector : Peak</p>	 <p>Site : 03CH07-HY Condition : FCC CLASS-B (AVG) 3m HF-ANT_130829 VERTICAL RBW:1000.000kHz VBW:0.010kHz SWT:Auto Detector : Peak</p>



**Band 3 5470~5725MHz  
WIFI 802.11n HT20 (Band Edge @ 3m)**

WIFI	Band 3 5470~5725MHz Band Edge @ 3m	
ANT	802.11n HT20 CH100 5500MHz	
1	Horizontal	Vertical
<b>Peak</b>	<p>Site : 03CH07-HY Condition : FCC CLASS-B 3m HF-ANT 130829 HORIZONTAL RBW:1000.000kHz VBW:3000.000kHz SWT:Auto Detector : Peak</p>	<p>Site : 03CH07-HY Condition : FCC CLASS-B 3m HF-ANT 130829 VERTICAL RBW:1000.000kHz VBW:3000.000kHz SWT:Auto Detector : Peak</p>
<b>Avg.</b>	<p>Site : 03CH07-HY Condition : FCC CLASS-B (AVG) 3m HF-ANT 130829 HORIZONTAL RBW:1000.000kHz VBW:0.010kHz SWT:Auto Detector : Peak</p>	<p>Site : 03CH07-HY Condition : FCC CLASS-B (AVG) 3m HF-ANT 130829 VERTICAL RBW:1000.000kHz VBW:0.010kHz SWT:Auto Detector : Peak</p>



WIFI	Band 3 5470~5725MHz Band Edge @ 3m	
ANT	802.11n HT20 CH116 5580MHz - Low channel location	
1	Horizontal	Vertical
Peak	<p>Site : 03CH07-HY            Condition : FCC CLASS-B 3m HF-ANT_130829 HORIZONTAL            RBW:1000.000KHz VBW:3000.000KHz SWT:Auto            Detector : Peak</p>	<p>Site : 03CH07-HY            Condition : FCC CLASS-B 3m HF-ANT_130829 VERTICAL            RBW:1000.000KHz VBW:3000.000KHz SWT:Auto            Detector : Peak</p>
Avg.	<p>Site : 03CH07-HY            Condition : FCC CLASS-B (AVG) 3m HF-ANT_130829 HORIZONTAL            RBW:1000.000KHz VBW:0.010KHz SWT:Auto            Detector : Peak</p>	<p>Site : 03CH07-HY            Condition : FCC CLASS-B (AVG) 3m HF-ANT_130829 VERTICAL            RBW:1000.000KHz VBW:0.010KHz SWT:Auto            Detector : Peak</p>





WIFI	Band 3 5470~5725MHz Band Edge @ 3m	
ANT	802.11n HT20 CH116 5580MHz - High channel location	
1	Horizontal	Vertical
Peak	<p>Date: 2015-08-09</p> <p>Site : 03CH07-HY Condition : FCC CLASS-B 3m HF-ANT_130829 HORIZONTAL RBW:1000.000KHz VBW:3000.000KHz SWT:Auto Detector : Peak</p>	<p>Date: 2015-08-09</p> <p>Site : 03CH07-HY Condition : FCC CLASS-B 3m HF-ANT_130829 VERTICAL RBW:1000.000KHz VBW:3000.000KHz SWT:Auto Detector : Peak</p>
Avg.	<p>Date: 2015-08-09</p> <p>Site : 03CH07-HY Condition : FCC CLASS-B (AVG) 3m HF-ANT_130829 HORIZONTAL RBW:1000.000KHz VBW:0.010KHz SWT:Auto Detector : Peak</p>	<p>Date: 2015-08-09</p> <p>Site : 03CH07-HY Condition : FCC CLASS-B (AVG) 3m HF-ANT_130829 VERTICAL RBW:1000.000KHz VBW:0.010KHz SWT:Auto Detector : Peak</p>



WIFI	Band 3 5470~5725MHz Band Edge @ 3m	
ANT	802.11n HT20 CH140 5700MHz	
1	Horizontal	Vertical
Peak	<p>Date: 2015-08-09</p> <p>Site : 03CH07-HY Condition : FCC CLASS-B 3m HF-ANT_130829 HORIZONTAL RBW: 1000.000KHz VBW: 5000.000KHz SWT: Auto Detector : Peak</p>	<p>Date: 2015-08-09</p> <p>Site : 03CH07-HY Condition : FCC CLASS-B 3m HF-ANT_130829 VERTICAL RBW: 1000.000KHz VBW: 5000.000KHz SWT: Auto Detector : Peak</p>
Avg.	<p>Date: 2015-08-09</p> <p>Site : 03CH07-HY Condition : FCC CLASS-B (AVG) 3m HF-ANT_130829 HORIZONTAL RBW: 1000.000KHz VBW: 0.010KHz SWT: Auto Detector : Peak</p>	<p>Date: 2015-08-09</p> <p>Site : 03CH07-HY Condition : FCC CLASS-B (AVG) 3m HF-ANT_130829 VERTICAL RBW: 1000.000KHz VBW: 0.010KHz SWT: Auto Detector : Peak</p>



Band 3 5470~5725MHz
WIFI 802.11n HT40 (Band Edge @ 3m)

Table with 4 quadrants: Peak Horizontal, Peak Vertical, Avg. Horizontal, Avg. Vertical. Each quadrant contains a spectral plot of Level (dBuV/m) vs Frequency (MHz) with FCC CLASS-B limits and test parameters.

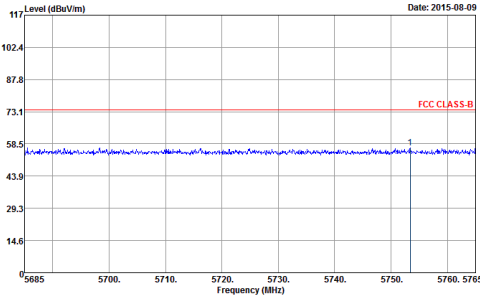
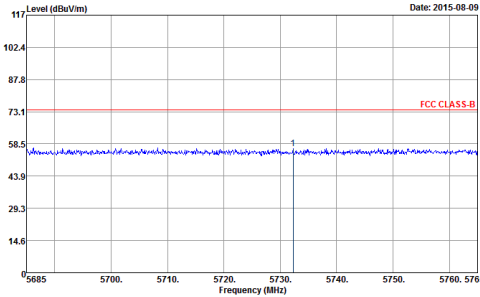
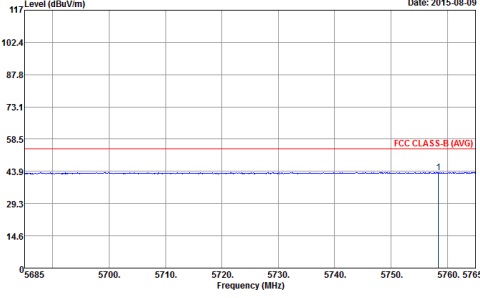
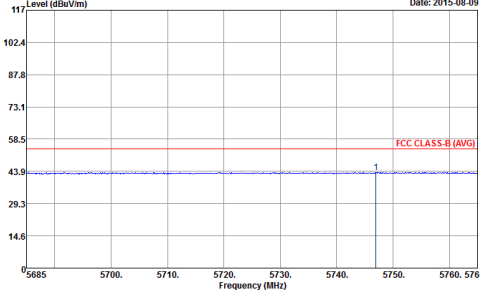

WIFI	Band 3 5470~5725MHz Band Edge @ 3m	
ANT	802.11n HT40 CH102 5510MHz - High channel location	
1	Horizontal	Vertical
Peak	 <p>Level (dBuV/m) vs Frequency (MHz) plot for Horizontal orientation. The y-axis ranges from 14.6 to 117 dBuV/m, and the x-axis ranges from 5685 to 5765 MHz. A red horizontal line indicates the FCC CLASS-B limit at 73.1 dBuV/m. The measured signal (blue line) is significantly below this limit, with a peak at approximately 5750 MHz.</p> <p>Site : 03CH07-HY            Condition : FCC CLASS-B 3m HF-ANT_130829 HORIZONTAL            Detector : Peak : RBW:1000.000kHz VBW:3000.000kHz SWT:Auto</p>	 <p>Level (dBuV/m) vs Frequency (MHz) plot for Vertical orientation. The y-axis ranges from 14.6 to 117 dBuV/m, and the x-axis ranges from 5685 to 5765 MHz. A red horizontal line indicates the FCC CLASS-B limit at 73.1 dBuV/m. The measured signal (blue line) is significantly below this limit, with a peak at approximately 5750 MHz.</p> <p>Site : 03CH07-HY            Condition : FCC CLASS-B 3m HF-ANT_130829 VERTICAL            Detector : Peak : RBW:1000.000kHz VBW:3000.000kHz SWT:Auto</p>
Avg.	 <p>Level (dBuV/m) vs Frequency (MHz) plot for Horizontal orientation (Average). The y-axis ranges from 14.6 to 117 dBuV/m, and the x-axis ranges from 5685 to 5765 MHz. A red horizontal line indicates the FCC CLASS-B (AVG) limit at 58.5 dBuV/m. The measured signal (blue line) is consistently below this limit.</p> <p>Site : 03CH07-HY            Condition : FCC CLASS-B (AVG) 3m HF-ANT_130829 HORIZONTAL            Detector : Peak : RBW:1000.000kHz VBW:1.000kHz SWT:Auto</p>	 <p>Level (dBuV/m) vs Frequency (MHz) plot for Vertical orientation (Average). The y-axis ranges from 14.6 to 117 dBuV/m, and the x-axis ranges from 5685 to 5765 MHz. A red horizontal line indicates the FCC CLASS-B (AVG) limit at 58.5 dBuV/m. The measured signal (blue line) is consistently below this limit.</p> <p>Site : 03CH07-HY            Condition : FCC CLASS-B (AVG) 3m HF-ANT_130829 VERTICAL            Detector : Peak : RBW:1000.000kHz VBW:1.000kHz SWT:Auto</p>

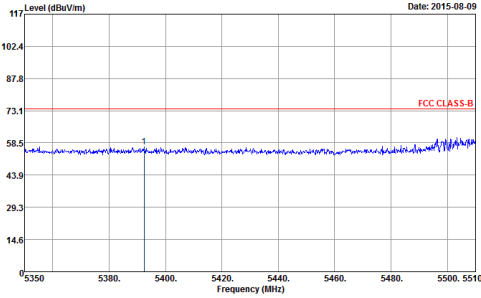
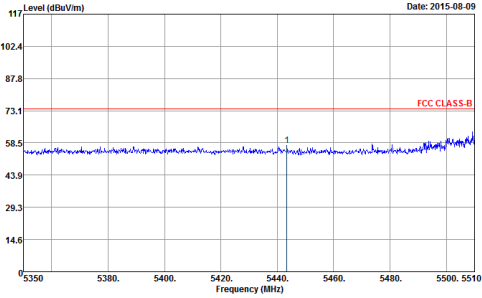
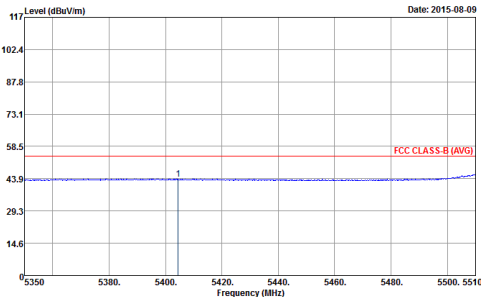
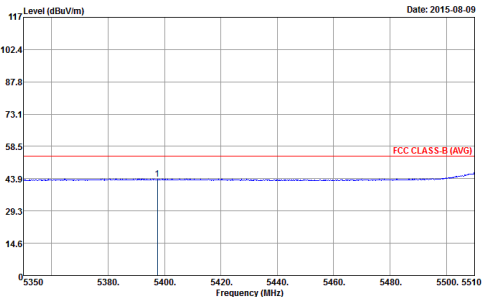

WIFI	Band 3 5470~5725MHz Band Edge @ 3m	
ANT	802.11n HT40 CH110 5550MHz - Low channel location	
1	Horizontal	Vertical
Peak	 <p>Site : 03CH07-HY Condition : FCC CLASS-B 3m HF-ANT_130829 HORIZONTAL RBW:1000.000kHz VBW:3000.000kHz SWT:Auto Detector : Peak</p>	 <p>Site : 03CH07-HY Condition : FCC CLASS-B 3m HF-ANT_130829 VERTICAL RBW:1000.000kHz VBW:3000.000kHz SWT:Auto Detector : Peak</p>
Avg.	 <p>Site : 03CH07-HY Condition : FCC CLASS-B (AVG) 3m HF-ANT_130829 HORIZONTAL RBW:1000.000kHz VBW:1.000kHz SWT:Auto Detector : Peak</p>	 <p>Site : 03CH07-HY Condition : FCC CLASS-B (AVG) 3m HF-ANT_130829 VERTICAL RBW:1000.000kHz VBW:1.000kHz SWT:Auto Detector : Peak</p>



WIFI	Band 3 5470~5725MHz Band Edge @ 3m	
ANT	802.11n HT40 CH110 5550MHz - High channel location	
1	Horizontal	Vertical
Peak	<p>Date: 2015-08-09</p> <p>Site : 03CH07-HY Condition : FCC CLASS-B 3m HF-ANT_130829 HORIZONTAL RBW:1000.000KHz VBW:3000.000KHz SWT:Auto Detector : Peak</p>	<p>Date: 2015-08-09</p> <p>Site : 03CH07-HY Condition : FCC CLASS-B 3m HF-ANT_130829 VERTICAL RBW:1000.000KHz VBW:3000.000KHz SWT:Auto Detector : Peak</p>
Avg.	<p>Date: 2015-08-09</p> <p>Site : 03CH07-HY Condition : FCC CLASS-B (AVG) 3m HF-ANT_130829 HORIZONTAL RBW:1000.000KHz VBW:1.000KHz SWT:Auto Detector : Peak</p>	<p>Date: 2015-08-09</p> <p>Site : 03CH07-HY Condition : FCC CLASS-B (AVG) 3m HF-ANT_130829 VERTICAL RBW:1000.000KHz VBW:1.000KHz SWT:Auto Detector : Peak</p>

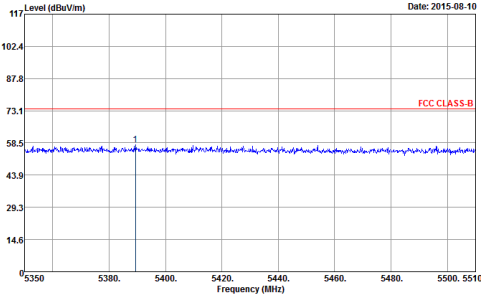
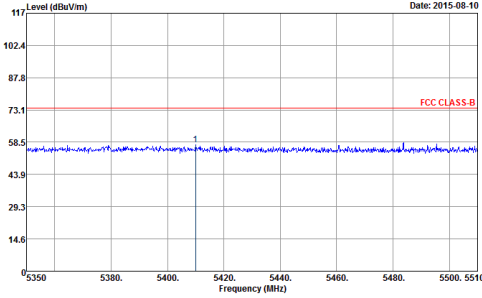
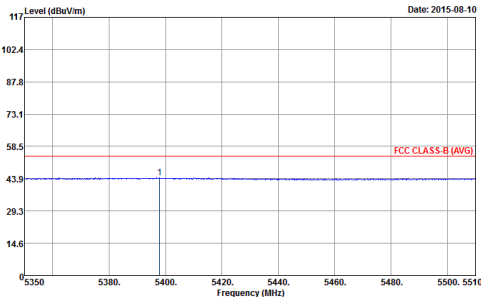
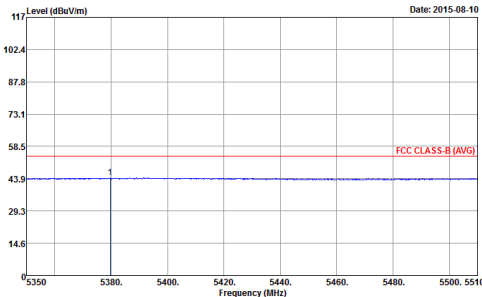

WIFI	Band 3 5470~5725MHz Band Edge @ 3m	
ANT	802.11n HT40 CH134 5670MHz - Low channel location	
1	Horizontal	Vertical
Peak	 <p>Date: 2015-08-10</p> <p>Site : 03CH07-HY Condition : FCC CLASS-B 3m HF-ANT_130829 HORIZONTAL RBW:1000.000kHz VBW:3000.000kHz SWT:Auto Detector : Peak</p>	 <p>Date: 2015-08-10</p> <p>Site : 03CH07-HY Condition : FCC CLASS-B 3m HF-ANT_130829 VERTICAL RBW:1000.000kHz VBW:3000.000kHz SWT:Auto Detector : Peak</p>
Avg.	 <p>Date: 2015-08-10</p> <p>Site : 03CH07-HY Condition : FCC CLASS-B (AVG) 3m HF-ANT_130829 HORIZONTAL RBW:1000.000kHz VBW:1.000kHz SWT:Auto Detector : Peak</p>	 <p>Date: 2015-08-10</p> <p>Site : 03CH07-HY Condition : FCC CLASS-B (AVG) 3m HF-ANT_130829 VERTICAL RBW:1000.000kHz VBW:1.000kHz SWT:Auto Detector : Peak</p>

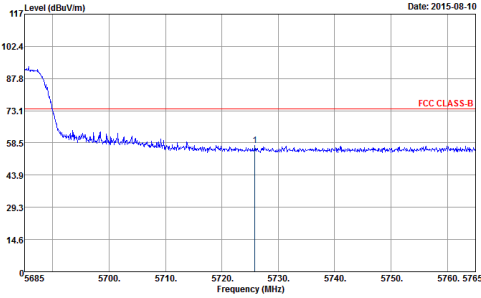
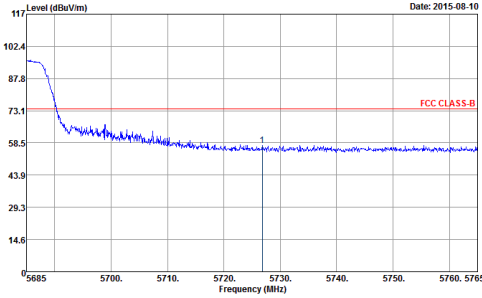
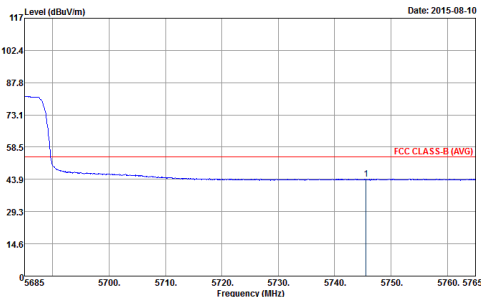
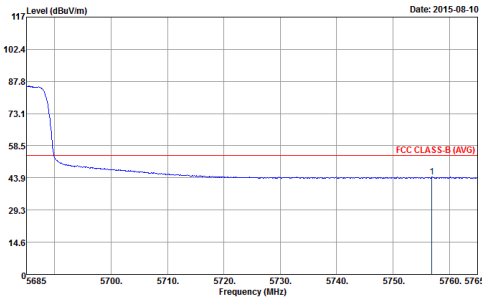

WIFI	Band 3 5470~5725MHz Band Edge @ 3m	
ANT	802.11n HT40 CH134 5670MHz - High channel location	
1	Horizontal	Vertical
Peak	 <p>Level (dBuV/m) vs Frequency (MHz) plot for Horizontal orientation. The y-axis ranges from 0 to 117 dBuV/m, and the x-axis ranges from 5685 to 5765 MHz. A red horizontal line indicates the FCC CLASS-B limit at 73.1 dBuV/m. The blue signal line shows a peak at approximately 5685 MHz and then drops below the limit.</p> <p>Site : 03CH07-HY            Condition : FCC CLASS-B 3m HF-ANT_130829 HORIZONTAL            RBW:1000.000KHz VBW:3000.000KHz SWT:Auto            Detector : Peak</p>	 <p>Level (dBuV/m) vs Frequency (MHz) plot for Vertical orientation. The y-axis ranges from 0 to 117 dBuV/m, and the x-axis ranges from 5685 to 5765 MHz. A red horizontal line indicates the FCC CLASS-B limit at 73.1 dBuV/m. The blue signal line shows a peak at approximately 5685 MHz and then drops below the limit.</p> <p>Site : 03CH07-HY            Condition : FCC CLASS-B 3m HF-ANT_130829 VERTICAL            RBW:1000.000KHz VBW:3000.000KHz SWT:Auto            Detector : Peak</p>
Avg.	 <p>Level (dBuV/m) vs Frequency (MHz) plot for Horizontal orientation (Average). The y-axis ranges from 0 to 117 dBuV/m, and the x-axis ranges from 5685 to 5765 MHz. A red horizontal line indicates the FCC CLASS-B (AVG) limit at 58.5 dBuV/m. The blue signal line shows a peak at approximately 5685 MHz and then drops below the limit.</p> <p>Site : 03CH07-HY            Condition : FCC CLASS-B (AVG) 3m HF-ANT_130829 HORIZONTAL            RBW:1000.000KHz VBW:1.000KHz SWT:Auto            Detector : Peak</p>	 <p>Level (dBuV/m) vs Frequency (MHz) plot for Vertical orientation (Average). The y-axis ranges from 0 to 117 dBuV/m, and the x-axis ranges from 5685 to 5765 MHz. A red horizontal line indicates the FCC CLASS-B (AVG) limit at 58.5 dBuV/m. The blue signal line shows a peak at approximately 5685 MHz and then drops below the limit.</p> <p>Site : 03CH07-HY            Condition : FCC CLASS-B (AVG) 3m HF-ANT_130829 VERTICAL            RBW:1000.000KHz VBW:1.000KHz SWT:Auto            Detector : Peak</p>





**Band 3 5470~5725MHz**  
**WIFI 802.11ac VHT80 (Band Edge @ 3m)**

WIFI	Band 3 5470~5725MHz Band Edge @ 3m	
ANT	802.11ac VHT80 CH106 5530MHz - Low channel location	
1+2	Horizontal	Vertical
Peak	<p>Site : 03CH07-HY            Condition : FCC CLASS-B 3m HF-ANT_130829 HORIZONTAL            RBW:1000.000kHz VBW:3000.000kHz SWT:Auto            Detector : Peak</p>	<p>Site : 03CH07-HY            Condition : FCC CLASS-B 3m HF-ANT_130829 VERTICAL            RBW:1000.000kHz VBW:3000.000kHz SWT:Auto            Detector : Peak</p>
Avg.	<p>Site : 03CH07-HY            Condition : FCC CLASS-B (AVG) 3m HF-ANT_130829 HORIZONTAL            RBW:1000.000kHz VBW:2.000kHz SWT:Auto            Detector : Peak</p>	<p>Site : 03CH07-HY            Condition : FCC CLASS-B (AVG) 3m HF-ANT_130829 VERTICAL            RBW:1000.000kHz VBW:2.000kHz SWT:Auto            Detector : Peak</p>

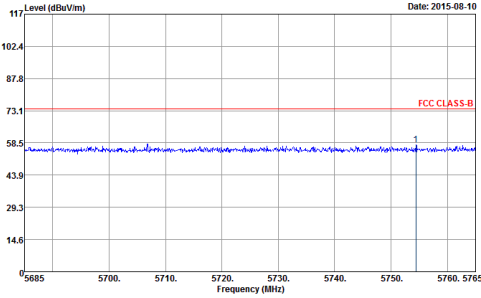
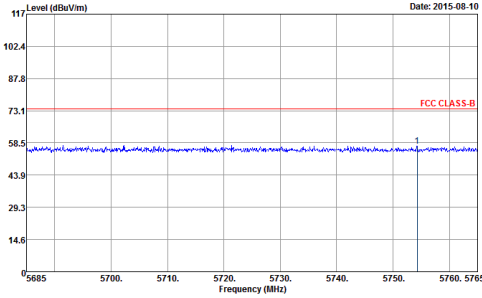
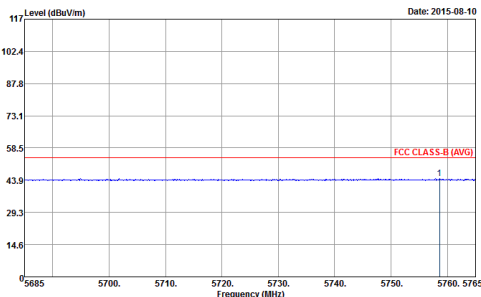
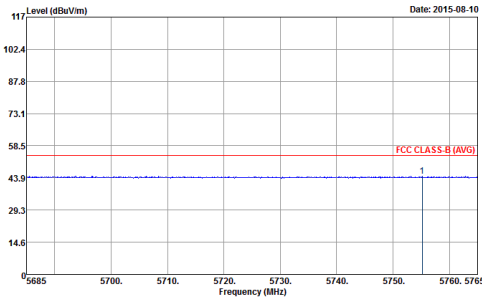

WIFI	Band 3 5470~5725MHz Band Edge @ 3m	
ANT	802.11ac VHT80 CH106 5530MHz - High channel location	
1	Horizontal	Vertical
Peak	 <p>Site : 03CH07-HY Condition : FCC CLASS-B 3m HF-ANT_130829 HORIZONTAL RBW:1000.000kHz VBW:3000.000kHz SWT:Auto Detector : Peak</p>	 <p>Site : 03CH07-HY Condition : FCC CLASS-B 3m HF-ANT_130829 VERTICAL RBW:1000.000kHz VBW:3000.000kHz SWT:Auto Detector : Peak</p>
Avg.	 <p>Site : 03CH07-HY Condition : FCC CLASS-B (AVG) 3m HF-ANT_130829 HORIZONTAL RBW:1000.000kHz VBW:2.000kHz SWT:Auto Detector : Peak</p>	 <p>Site : 03CH07-HY Condition : FCC CLASS-B (AVG) 3m HF-ANT_130829 VERTICAL RBW:1000.000kHz VBW:2.000kHz SWT:Auto Detector : Peak</p>



WIFI	Band 3 5470~5725MHz Band Edge @ 3m	
ANT	802.11ac VHT80 CH122 5610MHz - Low channel location	
1	Horizontal	Vertical
Peak	<p>Date: 2015-08-10</p> <p>Site : 03CH07-HY Condition : FCC CLASS-B 3m HF-ANT_130829 HORIZONTAL RBW:1000.000kHz VBW:3000.000kHz SWT:Auto Detector : Peak</p>	<p>Date: 2015-08-10</p> <p>Site : 03CH07-HY Condition : FCC CLASS-B 3m HF-ANT_130829 VERTICAL RBW:1000.000kHz VBW:3000.000kHz SWT:Auto Detector : Peak</p>
Avg.	<p>Date: 2015-08-10</p> <p>Site : 03CH07-HY Condition : FCC CLASS-B (AVG) 3m HF-ANT_130829 HORIZONTAL RBW:1000.000kHz VBW:2.000kHz SWT:Auto Detector : Peak</p>	<p>Date: 2015-08-10</p> <p>Site : 03CH07-HY Condition : FCC CLASS-B (AVG) 3m HF-ANT_130829 VERTICAL RBW:1000.000kHz VBW:2.000kHz SWT:Auto Detector : Peak</p>

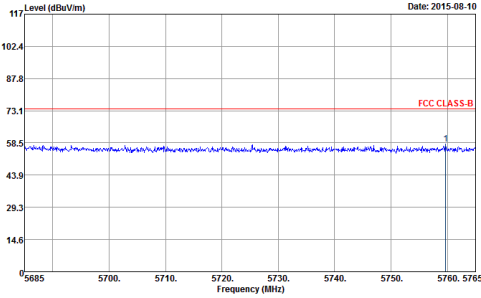
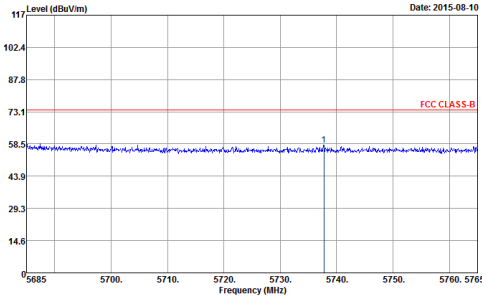
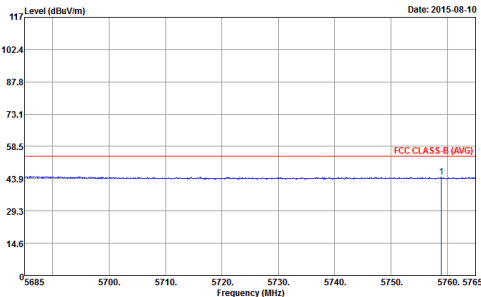
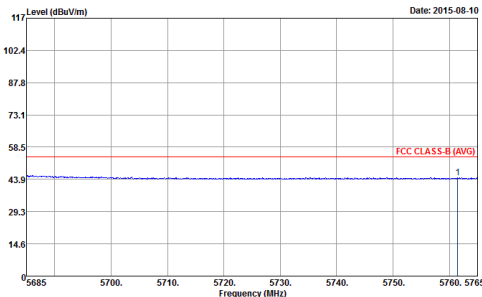

WIFI	Band 3 5470~5725MHz Band Edge @ 3m	
ANT	802.11ac VHT80 CH122 5610MHz - High channel location	
1	Horizontal	Vertical
Peak	 <p>Site : 03CH07-HY Condition : FCC CLASS-B 3m HF-ANT_130829 HORIZONTAL RBW:1000.000kHz VBW:3000.000kHz SWT:Auto Detector : Peak</p>	 <p>Site : 03CH07-HY Condition : FCC CLASS-B 3m HF-ANT_130829 VERTICAL RBW:1000.000kHz VBW:3000.000kHz SWT:Auto Detector : Peak</p>
Avg.	 <p>Site : 03CH07-HY Condition : FCC CLASS-B (AVG) 3m HF-ANT_130829 HORIZONTAL RBW:1000.000kHz VBW:2.000kHz SWT:Auto Detector : Peak</p>	 <p>Site : 03CH07-HY Condition : FCC CLASS-B (AVG) 3m HF-ANT_130829 VERTICAL RBW:1000.000kHz VBW:2.000kHz SWT:Auto Detector : Peak</p>



**Band 3 - 5470~5725MHz**

**WIFI 802.11a (Harmonic @ 3m)**

<b>WIFI</b>	<b>Band 3 5470~5725MHz Harmonic @ 3m</b>	
<b>ANT</b>	<b>802.11a CH100 5500MHz</b>	
<b>1</b>	<b>Horizontal</b>	<b>Vertical</b>
<b>Peak Avg.</b>	<p>Site : 03CH07-HY Condition : FCC CLASS-B 3m SHF-EHF_131029 HORIZONTAL Detector : Peak</p>	<p>Site : 03CH07-HY Condition : FCC CLASS-B 3m SHF-EHF_131029 VERTICAL Detector : Peak</p>

<b>WIFI</b>	<b>Band 3 5470~5725MHz Harmonic @ 3m</b>	
<b>ANT</b>	<b>802.11a CH116 5580MHz</b>	
<b>1</b>	<b>Horizontal</b>	<b>Vertical</b>
<b>Peak Avg.</b>	<p>Site : 03CH07-HY Condition : FCC CLASS-B 3m SHF-EHF_131029 HORIZONTAL Detector : Peak</p>	<p>Site : 03CH07-HY Condition : FCC CLASS-B 3m SHF-EHF_131029 VERTICAL Detector : Peak</p>



WIFI	<b>Band 3 5470~5725MHz Harmonic @ 3m</b>	
ANT	<b>802.11a CH140 5700MHz</b>	
1	<b>Horizontal</b>	<b>Vertical</b>
<b>Peak Avg.</b>	<p>Site : 03CH07-HY Condition : FCC CLASS-B 3m SHF-EHF_131029 HORIZONTAL Detector : Peak</p>	<p>Site : 03CH07-HY Condition : FCC CLASS-B 3m SHF-EHF_131029 VERTICAL Detector : Peak</p>



**Band 3 5470~5725MHz**  
**WIFI 802.11n HT20 (Harmonic @ 3m)**

WIFI	Band 3 5470~5725MHz Harmonic @ 3m	
ANT	802.11n HT20 CH100 5500MHz	
1	Horizontal	Vertical
Peak Avg.	<p>Site : 03CH07-HY Condition : FCC CLASS-B 3m SHF-EHF_131029 HORIZONTAL Detector : Peak</p>	<p>Site : 03CH07-HY Condition : FCC CLASS-B 3m SHF-EHF_131029 VERTICAL Detector : Peak</p>

WIFI	Band 3 5470~5725MHz Harmonic @ 3m	
ANT	802.11n HT20 CH116 5580MHz	
1	Horizontal	Vertical
Peak Avg.	<p>Site : 03CH07-HY Condition : FCC CLASS-B 3m SHF-EHF_131029 HORIZONTAL Detector : Peak</p>	<p>Site : 03CH07-HY Condition : FCC CLASS-B 3m SHF-EHF_131029 VERTICAL Detector : Peak</p>

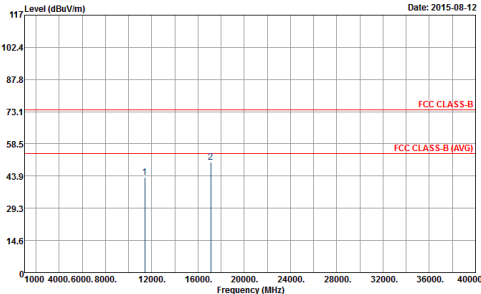
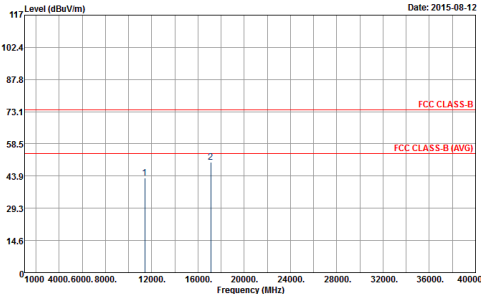

WIFI	Band 3 5470~5725MHz Harmonic @ 3m	
ANT	802.11n HT20 CH140 5700MHz	
1	Horizontal	Vertical
Peak Avg.	 <p>Site : 03CH07-HY Condition : FCC CLASS-B 3m SHF-EHF_131029 HORIZONTAL Detector : Peak</p>	 <p>Site : 03CH07-HY Condition : FCC CLASS-B 3m SHF-EHF_131029 VERTICAL Detector : Peak</p>





**Band 3 5470~5725MHz**  
**WIFI 802.11n HT40 (Harmonic @ 3m)**

<b>WIFI</b>	<b>Band 3 5470~5725MHz Harmonic @ 3m</b>	
<b>ANT</b>	<b>802.11n HT40 CH102 5510MHz</b>	
<b>1</b>	<b>Horizontal</b>	<b>Vertical</b>
<b>Peak Avg.</b>		

<b>WIFI</b>	<b>Band 3 5470~5725MHz Harmonic @ 3m</b>	
<b>ANT</b>	<b>802.11n HT40 CH110 5550MHz</b>	
<b>1</b>	<b>Horizontal</b>	<b>Vertical</b>
<b>Peak Avg.</b>		



WIFI	Band 3 5470~5725MHz Harmonic @ 3m	
ANT	802.11n HT40 CH134 5670MHz	
1	Horizontal	Vertical
Peak Avg.	<p>Site : 03CH07-HY Condition : FCC CLASS-B 3m SHF-EHF_131029 HORIZONTAL Detector : Peak</p>	<p>Site : 03CH07-HY Condition : FCC CLASS-B 3m SHF-EHF_131029 VERTICAL Detector : Peak</p>



**Band 3 5470~5725MHz**  
**WIFI 802.11ac VHT80 (Harmonic @ 3m)**

<b>WIFI</b>	<b>Band 3 5470~5725MHz Harmonic @ 3m</b>	
<b>ANT</b>	<b>802.11ac VHT80 CH106 5530MHz</b>	
<b>1</b>	<b>Horizontal</b>	<b>Vertical</b>
<b>Peak</b> <b>Avg.</b>	<p>Site : 03CH07-HY          Condition : FCC CLASS-B 3m SHF-EHF_131029 HORIZONTAL          Detector : Peak</p>	<p>Site : 03CH07-HY          Condition : FCC CLASS-B 3m SHF-EHF_131029 VERTICAL          Detector : Peak</p>

<b>WIFI</b>	<b>Band 3 5470~5725MHz Harmonic @ 3m</b>	
<b>ANT</b>	<b>802.11ac VHT80 CH122 5610MHz</b>	
<b>1</b>	<b>Horizontal</b>	<b>Vertical</b>
<b>Peak</b> <b>Avg.</b>	<p>Site : 03CH07-HY          Condition : FCC CLASS-B 3m SHF-EHF_131029 HORIZONTAL          Detector : Peak</p>	<p>Site : 03CH07-HY          Condition : FCC CLASS-B 3m SHF-EHF_131029 VERTICAL          Detector : Peak</p>



**Band 3 - Straddle Channel**  
**WIFI 802.11a (Harmonic @ 3m)**

WIFI	Band 3 Straddle Channel Harmonic @ 3m	
ANT	802.11a CH144 5720MHz	
1	Horizontal	Vertical
<b>Peak</b> <b>Avg.</b>	<p>Site : 03CH07-HY Condition : FCC CLASS-B 3m SHF-EHF_131029 HORIZONTAL Detector : Peak</p>	<p>Site : 03CH07-HY Condition : FCC CLASS-B 3m SHF-EHF_131029 VERTICAL Detector : Peak</p>

**Band 3 – Straddle Channel**  
**WIFI 802.11n HT20 (Harmonic @ 3m)**

WIFI	Band 3 Straddle Channel Harmonic @ 3m	
ANT	802.11n HT20 CH144 5720MHz	
1	Horizontal	Vertical
<b>Peak</b> <b>Avg.</b>	<p>Site : 03CH07-HY Condition : FCC CLASS-B 3m SHF-EHF_131029 HORIZONTAL Detector : Peak</p>	<p>Site : 03CH07-HY Condition : FCC CLASS-B 3m SHF-EHF_131029 VERTICAL Detector : Peak</p>



**Band 3 – Straddle Channel  
WIFI 802.11n HT40 (Harmonic @ 3m)**

WIFI	Band 3 Straddle Channel Harmonic @ 3m	
ANT	802.11n HT40 CH142 5710MHz	
1	Horizontal	Vertical
<b>Peak Avg.</b>	<p>Site : 03CH07-HY Condition : FCC CLASS-B 3m SHF-EHF_131029 HORIZONTAL Detector : Peak</p>	<p>Site : 03CH07-HY Condition : FCC CLASS-B 3m SHF-EHF_131029 VERTICAL Detector : Peak</p>

**Band 3 – Straddle Channel  
WIFI 802.11ac VHT80 (Harmonic @ 3m)**

WIFI	Band 3 Straddle Channel Harmonic @ 3m	
ANT	802.11ac VHT80 CH138 5690MHz	
1	Horizontal	Vertical
<b>Peak Avg.</b>	<p>Site : 03CH07-HY Condition : FCC CLASS-B 3m SHF-EHF_131029 HORIZONTAL Detector : Peak</p>	<p>Site : 03CH07-HY Condition : FCC CLASS-B 3m SHF-EHF_131029 VERTICAL Detector : Peak</p>



Emission below 1GHz  
5GHz WIFI 802.11a (LF)

WIFI	5GHz WIFI	
ANT	802.11a LF	
1	Horizontal	Vertical
QP / Peak	<p>Site : 03CH07-HY Condition : FCC CLASS-B 3m LF-ANT(131102) HORIZONTAL Detector : Peak</p>	<p>Site : 03CH07-HY Condition : FCC CLASS-B 3m LF-ANT(131102) VERTICAL Detector : Peak</p>

Emission below 1GHz  
5GHz WIFI 802.11n HT20 (LF)

WIFI	5GHz WIFI	
ANT	802.11n HT20 LF	
1	Horizontal	Vertical
QP / Peak	<p>Site : 03CH07-HY Condition : FCC CLASS-B 3m LF-ANT(131102) HORIZONTAL Detector : Peak</p>	<p>Site : 03CH07-HY Condition : FCC CLASS-B 3m LF-ANT(131102) VERTICAL Detector : Peak</p>



Emission below 1GHz  
5GHz WIFI 802.11n HT40 (LF)

WIFI	5GHz WIFI	
ANT	802.11n HT40 LF	
1	Horizontal	Vertical
QP / Peak	<p>Site : 03CH07-HY Condition : FCC CLASS-B 3m LF-ANT(131102) HORIZONTAL Detector : Peak</p>	<p>Site : 03CH07-HY Condition : FCC CLASS-B 3m LF-ANT(131102) VERTICAL Detector : Peak</p>

Emission below 1GHz  
5GHz WIFI 802.11ac VHT80 (LF)

WIFI	5GHz WIFI	
ANT	802.11ac VHT80 LF	
1	Horizontal	Vertical
QP / Peak	<p>Site : 03CH07-HY Condition : FCC CLASS-B 3m LF-ANT(131102) HORIZONTAL Detector : Peak</p>	<p>Site : 03CH07-HY Condition : FCC CLASS-B 3m LF-ANT(131102) VERTICAL Detector : Peak</p>