



FCC RF Test Report

APPLICANT : Sony Mobile Communications Inc.
EQUIPMENT : GSM/WCDMA/LTE Phone + Bluetooth, DTS/UNII
a/b/g/n/ac, ANT+, and NFC
BRAND NAME : Sony
FCC ID : PY7-PM0881
STANDARD : FCC Part 15 Subpart E §15.407
CLASSIFICATION : (NII) Unlicensed National Information Infrastructure

The product was received on Jul. 16, 2015 and testing was completed on Aug. 26, 2015. We, SPORTON INTERNATIONAL INC., would like to declare that the tested sample has been evaluated in accordance with the test procedures and has been in compliance with the applicable technical standards.

The test results in this report apply exclusively to the tested model / sample. Without written approval of SPORTON INTERNATIONAL INC., the test report shall not be reproduced except in full.

Reviewed by: Joseph Lin / Supervisor

Approved by: Jones Tsai / Manager



SPORTON INTERNATIONAL INC.

No. 52, Hwa Ya 1st Rd., Hwa Ya Technology Park, Kwei-Shan District, Tao Yuan City, Taiwan, R.O.C.

SPORTON INTERNATIONAL INC.

TEL : 886-3-327-3456

FAX : 886-3-328-4978

FCC ID : PY7-PM0881

Page Number : 1 of 30

Report Issued Date : Sep. 08, 2015

Report Version : Rev. 01

Report Template No.: BU5-FR15EWLB4 AC Version 1.0



TABLE OF CONTENTS

REVISION HISTORY 3

SUMMARY OF TEST RESULT 4

1 GENERAL DESCRIPTION 5

 1.1 Applicant 5

 1.2 Manufacturer 5

 1.3 Feature of Equipment Under Test 5

 1.4 Modification of EUT 6

 1.5 Testing Location 6

 1.6 Applicable Standards 6

2 TEST CONFIGURATION OF EQUIPMENT UNDER TEST 7

 2.1 Carrier Frequency and Channel 7

 2.2 Pre-Scanned RF Power 8

 2.3 Test Mode 9

 2.4 Connection Diagram of Test System 10

 2.5 Support Unit used in test configuration and system 11

 2.6 EUT Operation Test Setup 11

 2.7 Measurement Results Explanation Example 11

3 TEST RESULT 12

 3.1 6dB Bandwidth Measurement 12

 3.2 Maximum Conducted Output Power Measurement 14

 3.3 Power Spectral Density Measurement 15

 3.4 Unwanted Emissions Measurement 17

 3.5 AC Conducted Emission Measurement 21

 3.6 Frequency Stability Measurement 25

 3.7 Automatically Discontinue Transmission 26

 3.8 Antenna Requirements 27

4 LIST OF MEASURING EQUIPMENT 28

5 UNCERTAINTY OF EVALUATION 30

APPENDIX A. CONDUCTED TEST RESULTS

APPENDIX B. RADIATED TEST RESULTS

APPENDIX C. RADIATED SPURIOUS EMISSION PLOTS



SUMMARY OF TEST RESULT

Report Section	FCC Rule	Description	Limit	Result	Remark
3.1	15.403(i)	6dB Bandwidth	> 500kHz	Pass	-
3.2	15.407(a)	Maximum Conducted Output Power	≤ 30 dBm	Pass	-
3.3	15.407(a)	Power Spectral Density	≤ 30 dBm/500kHz	Pass	-
3.4	15.407(b)	Unwanted Emissions	≤ -17, -27 dBm/MHz & 15.209(a)	Pass	Under limit 1.52 dB at 5712.200 MHz
3.5	15.207	AC Conducted Emission	15.207(a)	Pass	Under limit 19.30 dB at 0.614 MHz
3.6	15.407(g)	Frequency Stability	Within Operation Band	Pass	-
3.7	15.407(c)	Automatically Discontinue Transmission	Discontinue Transmission	Pass	-
3.8	15.203 & 15.407(a)	Antenna Requirement	N/A	Pass	-

Remark: The FR571618G report reuses test data from the FR571617G report.



1 General Description

1.1 Applicant

Sony Mobile Communications Inc.
Nya Vattentorget, 22188 Lund, Sweden

1.2 Manufacturer

Sony Mobile Communications Inc.
1-8-15 Konan, Minato-ku, Tokyo, 108-0075, Japan

1.3 Feature of Equipment Under Test

GSM/WCDMA/LTE, Bluetooth, DTS/UNII a/b/g/n/ac, ANT+, NFC, and GPS

Product Specification subjective to this standard	
Antenna Type	Monopole Antenna
Antenna Gain	-4.62 dBi

EUT Information List				
IMEI	HW Version	SW Version	S/N	Performed Test Item
004402455123152	A	32.0.A.0.287	CB5A273TKQ	RF conducted measurement
004402455122295			CB5A273TGC	Radiated Spurious Emission
004402455122410			CB5A273THY	Conducted Emission

Accessory List	
AC Adapter	Model No. : UCH20
	Type No. : AC-0061-US
	S/N : 2115W15500021 (for Radiation Spurious Emission) 5815W22500112 (for Conducted Emission)
Earphone	Model No. : MDR-NC31E
	Type No. : AG-1110
USB Cable	Model No. : UCB11
	Type No. : AI-0120
	S/N : 1522A731000010A (for Radiated Spurious Emission) 1512A73E0001BD0 (for Conducted Emission)

Note:

1. Above EUT list and accessory list used are electrically identical per declared by manufacturer.
2. Above the accessories list are used to exercise the EUT during test.
3. For other wireless features of this EUT, test report will be issued separately.



1.4 Modification of EUT

No modifications are made to the EUT during all test items.

1.5 Testing Location

Sporton Lab is accredited to ISO 17025 by Taiwan Accreditation Foundation (TAF code : 1190) and the FCC designation No. TW1022 under the FCC 2.948(e) by Mutual Recognition Agreement (MRA) in FCC Test.

Test Site	SPORTON INTERNATIONAL INC.		
Test Site Location	No. 52, Hwa Ya 1 st Rd., Hwa Ya Technology Park, Kwei-Shan District, Tao Yuan City, Taiwan, R.O.C. TEL: +886-3-327-3456 FAX: +886-3-328-4978		
Test Site No.	Sporton Site No.		
	TH05-HY	CO05-HY	03CH07-HY

Note: The test site complies with ANSI C63.4 2009 requirement.

1.6 Applicable Standards

According to the specifications of the manufacturer, the EUT must comply with the requirements of the following standards:

- FCC Part 15 Subpart E
- FCC KDB 789033 D02 General UNII Test Procedures New Rules v01
- FCC KDB 644545 D03 Guidance for IEEE 802 11ac New Rules v01
- ANSI C63.10-2009

Remark:

1. All test items were verified and recorded according to the standards and without any deviation during the test.
2. FCC permits the use of the 1.5 meter table as an alternative in C63.10-2013 through inquiry tracking number 961829.



2 Test Configuration of Equipment Under Test

The EUT has been associated with peripherals and configuration operated in a manner tended to maximize its emission characteristics in a typical application. Frequency range investigated: conducted emission (150 kHz to 30 MHz) and radiated emission (9 kHz to the 10th harmonic of the highest fundamental frequency or to 40 GHz, whichever is lower). For radiated measurement, pre-scanned in three orthogonal panels, X, Y, Z. The worst cases (X plane) were recorded in this report.

The final configuration from all the combinations and the worst-case data rates were investigated by measuring the maximum power across all the data rates and modulation modes under section 2.2.

Based on the worst configuration found above, the RF power setting is set individually to meet FCC compliance limit for the final conducted and radiated tests shown in section 2.3.

2.1 Carrier Frequency and Channel

Frequency Band	Channel	Freq. (MHz)	Channel	Freq. (MHz)
5725-5850 MHz Band 4 (U-NII-3)	149	5745	157	5785
	151	5755	159	5795
	153	5765	161	5805
	155	5775	165	5825

Note: The above Frequency and Channel in boldface were 802.11n HT40.



2.2 Pre-Scanned RF Power

Preliminary tests were performed in different data rate and data rate associated with the highest power were chosen for full test in the following tables. Final Output Power equals to Measured Output Power adds the duty factor.

5GHz 802.11a mode								
Data Rate (MHz)	6M bps	9M bps	12M bps	18M bps	24M bps	36M bps	48M bps	54M bps
Average Power (dBm)	12.60	12.52	12.59	12.58	12.56	12.58	12.57	12.57

5GHz 802.11n HT20 mode								
Data Rate (MHz)	MCS0	MCS1	MCS2	MCS3	MCS4	MCS5	MCS6	MCS7
Average Power (dBm)	12.59	12.53	12.54	12.54	12.51	12.56	12.57	12.55

5GHz 802.11n HT40 mode								
Data Rate (MHz)	MCS0	MCS1	MCS2	MCS3	MCS4	MCS5	MCS6	MCS7
Average Power (dBm)	12.64	12.62	12.63	12.63	12.63	12.62	12.63	12.63

5GHz 802.11ac VHT20 mode									
Data Rate (MHz)	MCS 0	MCS 1	MCS 2	MCS 3	MCS 4	MCS 5	MCS 6	MCS 7	MCS 8
Average Power (dBm)	12.33	12.32	12.32	12.30	12.31	12.32	12.31	12.32	12.32

5GHz 802.11ac VHT40 mode										
Data Rate (MHz)	MCS 0	MCS 1	MCS 2	MCS 3	MCS 4	MCS 5	MCS 6	MCS 7	MCS 8	MCS 9
Average Power (dBm)	12.50	12.43	12.48	12.49	12.47	12.49	12.48	12.48	12.49	12.48

5GHz 802.11ac VHT80 mode										
Data Rate (MHz)	MCS 0	MCS 1	MCS 2	MCS 3	MCS 4	MCS 5	MCS 6	MCS 7	MCS 8	MCS 9
Average Power (dBm)	12.79	12.54	12.53	12.77	12.78	12.78	12.77	12.76	12.78	12.78



2.3 Test Mode

Final test mode of conducted test items and radiated spurious emissions are considering the modulation and worse data rates from the power table described in section 2.2.

The radiated spurious emissions testing were performed in n-mode only for HT20/40, which covers ac-mode testing.

Modulation	Data Rate
802.11a	6 Mbps
802.11n HT20	MCS0
802.11n HT40	MCS0
802.11ac VHT20	MCS0
802.11ac VHT40	MCS0
802.11ac VHT80	MCS0

AC Conducted Emission	Mode 1 : WLAN (5GHz) Link + Earphone + USB Cable (Charging from Adapter)
------------------------------	--

Ch. #		Band IV : 5725-5850 MHz		
		802.11a	802.11n HT20	802.11n HT40
L	Low	149	149	151
M	Middle	157	157	-
H	High	165	165	159

Ch. #		Band IV : 5725-5850 MHz		
		802.11ac VHT20	802.11ac VHT40	802.11ac VHT80
L	Low	149	151	-
M	Middle	157	-	155
H	High	165	159	-

2.4 Connection Diagram of Test System

<WLAN Tx Mode>

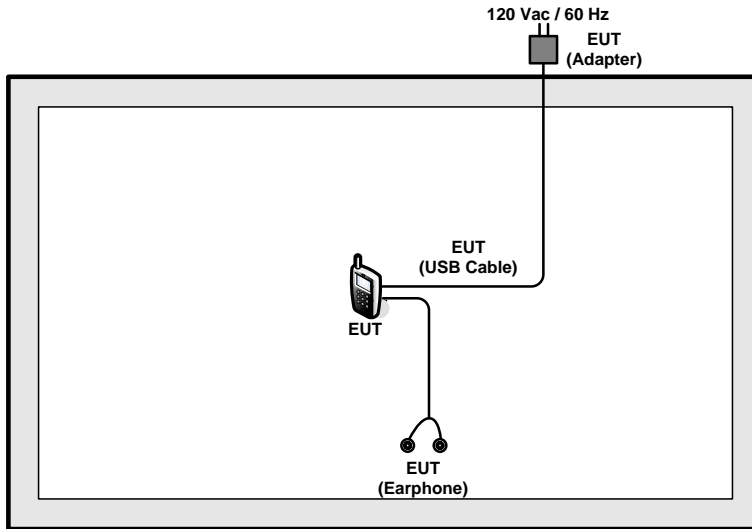

<AC Conducted Emission Mode>

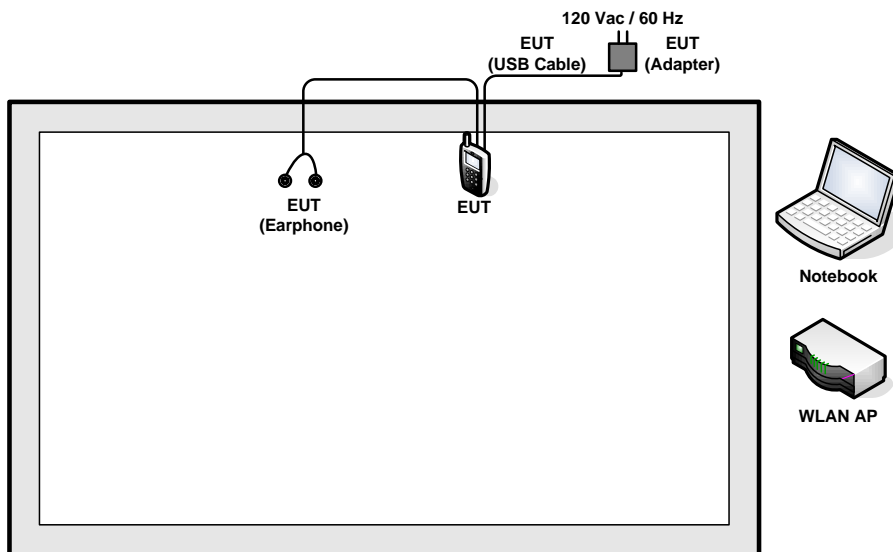



2.5 Support Unit used in test configuration and system

Item	Equipment	Trade Name	Model Name	FCC ID	Data Cable	Power Cord
1.	WLAN AP	D-Link	DIR-865L	KA2IR865LA1	N/A	Unshielded, 1.8 m
2.	Notebook	DELL	Latitude E6320	FCC DoC/ Contains FCC ID: QDS-BRCM1054	N/A	AC I/P: Unshielded, 1.2 m DC O/P: Shielded, 1.8 m
3.	SD Card	SanDisk	MicroSD HC	FCC DoC	N/A	N/A

2.6 EUT Operation Test Setup

For WLAN function, programmed RF utility, "QRCT" installed in the notebook make the EUT provide functions like channel selection and power level for continuous transmitting and receiving signals.

2.7 Measurement Results Explanation Example

For all conducted test items:

The offset level is set in the spectrum analyzer to compensate the RF cable loss and attenuator factor between EUT conducted output port and spectrum analyzer. With the offset compensation, the spectrum analyzer reading level is exactly the EUT RF output level.

Example :

The spectrum analyzer offset is derived from RF cable loss and attenuator factor.

Offset = RF cable loss + attenuator factor.

Following shows an offset computation example with cable loss 4.2 dB and 10dB attenuator.

$$\begin{aligned}
\text{Offset(dB)} &= \text{RF cable loss(dB)} + \text{attenuator factor(dB)}. \\
&= 4.2 + 10 = 14.2 \text{ (dB)}
\end{aligned}$$

3 Test Result

3.1 6dB Bandwidth Measurement

3.1.1 Description of 6dB Bandwidth

The minimum 6 dB bandwidth shall be at least 500 kHz.

3.1.2 Measuring Instruments

The measuring equipment is listed in the section 4 of this test report.

3.1.3 Test Procedures

1. The testing follows FCC KDB 789033 D02 General UNII Test Procedures New Rules v01.
Section C) Emission bandwidth for the band 5.725-5.85GHz
2. Set RBW = 100kHz.
3. Set the VBW $\geq 3 \times$ RBW.
4. Detector = Peak.
5. Trace mode = max hold
6. Measure the maximum width of the emission that is 6 dB down from the peak of the emission.
7. Measure and record the results in the test report.

3.1.4 Test Setup





3.1.5 Test Result of 6dB Bandwidth

Please refer to Appendix A.

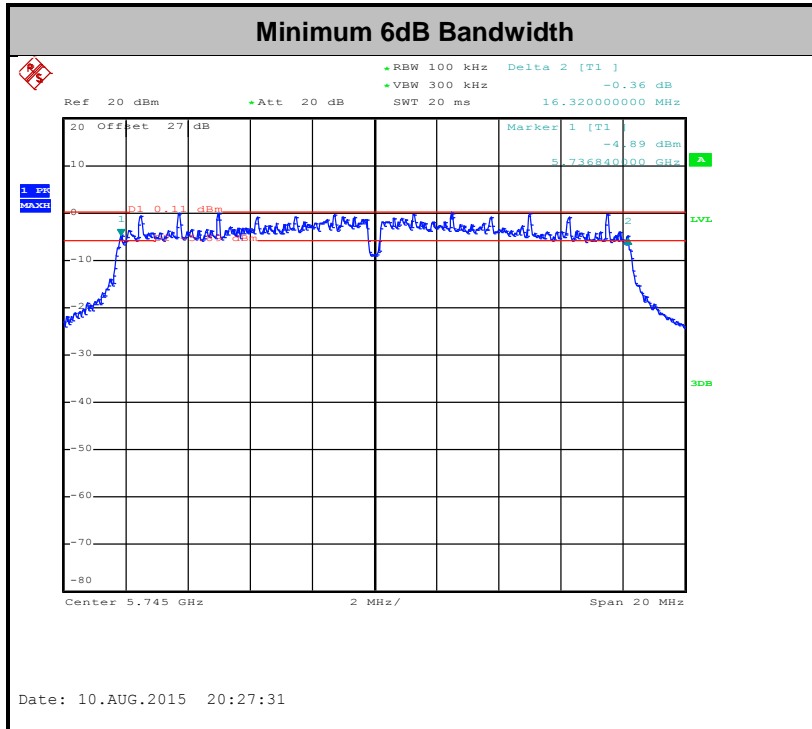

3.2 Maximum Conducted Output Power Measurement

3.2.1 Limit of Maximum Conducted Output Power

For the band 5.725–5.85 GHz, the maximum conducted output power over the frequency band of operation shall not exceed 1 W.

If transmitting antennas of directional gain greater than 6 dBi are used, the peak output power shall be reduced by the amount in dB that the directional gain of the antenna exceeds 6 dBi.

3.2.2 Measuring Instruments

The measuring equipment is listed in the section 4 of this test report.

3.2.3 Test Procedures

The testing follows Method PM of FCC KDB 789033 D02 General UNII Test Procedures New Rules v01.

Method PM (Measurement using an RF average power meter):

1. Measurement is performed using a wideband RF power meter.
2. The EUT is configured to transmit continuously with a consistent duty cycle at its maximum power control level.
3. Measure the average power of the transmitter, and the average power is corrected with duty factor, $10 \log(1/x)$, where x is the duty cycle.

3.2.4 Test Setup

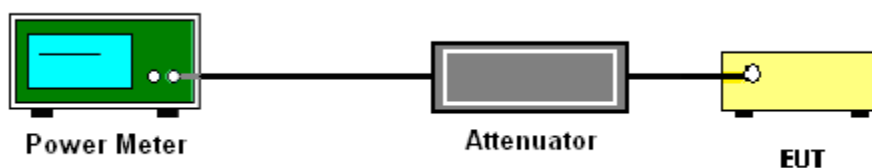

3.2.5 Test Result of Maximum Conducted Output Power

Please refer to Appendix A.



3.3 Power Spectral Density Measurement

3.3.1 Limit of Power Spectral Density

For the band 5.725–5.85 GHz, the maximum power spectral density shall not exceed 30 dBm in any 500-kHz band.

If transmitting antennas of directional gain greater than 6 dBi are used, the peak output power shall be reduced by the amount in dB that the directional gain of the antenna exceeds 6 dBi.

3.3.2 Measuring Instruments

The measuring equipment is listed in the section 4 of this test report.

3.3.3 Test Procedures

The testing follows FCC KDB 789033 D02 General UNII Test Procedures New Rules v01. Section F) Maximum power spectral density.

Method SA-2

(trace averaging across on and off times of the EUT transmissions, followed by duty cycle correction).

1. The testing follows Method SA-2 of FCC KDB 789033 D01 General UNII Test Procedures v01r03.
 - Measure the duty cycle.
 - Set span to encompass the entire emission bandwidth (EBW) of the signal.
 - Set RBW = 300 kHz.
 - Set VBW \geq 1 MHz.
 - Number of points in sweep \geq 2 Span / RBW.
 - Sweep time = auto.
 - Detector = RMS
 - Trace average at least 100 traces in power averaging mode.
 - Add $10 \log(500\text{kHz}/\text{RBW})$ to the test result.
 - Add $10 \log(1/x)$, where x is the duty cycle, to the measured power in order to compute the average power during the actual transmission times. For example, add $10 \log(1/0.25) = 6$ dB if the duty cycle is 25 percent.

2. The RF output of EUT was connected to the spectrum analyzer by a low loss cable.
3. Each plot has already offset with cable loss, and attenuator loss. Measure the PPSD and record it.

3.3.4 Test Setup

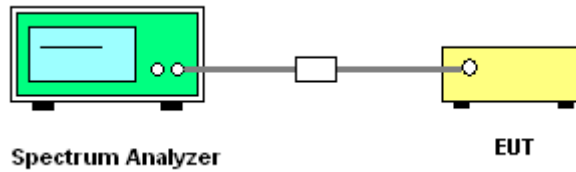

3.3.5 Test Result of Power Spectral Density

Please refer to Appendix A.

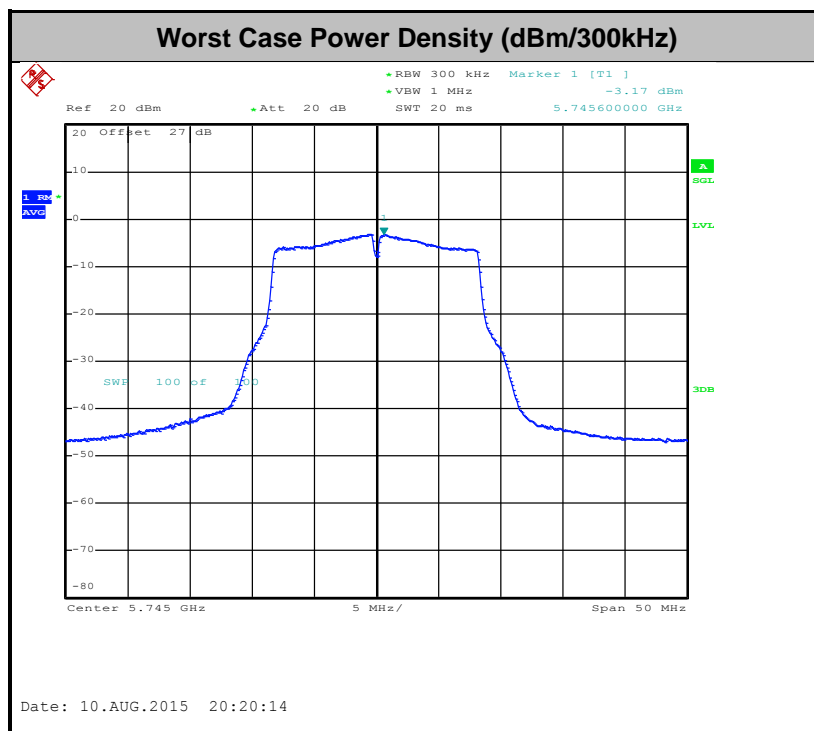



3.4 Unwanted Emissions Measurement

This section as specified in FCC Part 15.407(b) is to measure unwanted emissions through radiated measurement for band edge spurious emissions and out of band emissions measurement. The unwanted emissions shall comply with 15.407(b)(1) to (6), and restricted bands per FCC Part15.205.

3.4.1 Limit of Unwanted Emissions

- (1) For transmitters operating in the 5725-5850 MHz band: all emissions within the frequency range from the band edge to 10 MHz above or below the band edge shall not exceed an EIRP of -17 dBm/MHz (78.3dBμV/m); for frequencies 10 MHz or greater above or below the band edge, emissions shall not exceed an EIRP of -27 dBm/MHz (68.3dBμV/m).
- (2) Unwanted spurious emissions fallen in restricted bands per FCC Part15.205 shall comply with the general field strength limits set forth in § 15.209 as below table,

Frequency (MHz)	Field Strength (microvolts/meter)	Measurement Distance (meters)
0.009 – 0.490	2400/F(kHz)	300
0.490 – 1.705	24000/F(kHz)	30
1.705 – 30.0	30	30
30 – 88	100	3
88 – 216	150	3
216 - 960	200	3
Above 960	500	3

Note: The following formula is used to convert the EIRP to field strength.

$$E = \frac{1000000\sqrt{30P}}{3} \mu\text{V/m, where P is the eirp (Watts)}$$

EIRP (dBm)	Field Strength at 3m (dBμV/m)
-17	78.3
- 27	68.3

- (3) KDB789033 v01r03 H)2)c)(i) As specified in 15.407(b), emissions above 1000 MHz that are outside of the restricted bands are subject to a peak emission limit of -27 dBm/MHz (or -17 dBm/MHz as specified in 15.407(b)(4)). However, an out-of-band emission that complies with both the average and peak limits of 15.209 is not required to satisfy the -27 dBm/MHz or -17 dBm/MHz peak emission limit.



3.4.2 Measuring Instruments

The measuring equipment is listed in the section 4 of this test report.

3.4.3 Test Procedures

1. The testing follows FCC KDB 789033 D02 General UNII Test Procedures New Rules v01. Section G) Unwanted emissions measurement.

(1) Procedure for Unwanted Emissions Measurements Below 1000MHz

- RBW = 120 kHz
- VBW = 300 kHz
- Detector = Peak
- Trace mode = max hold

(2) Procedure for Peak Unwanted Emissions Measurements Above 1000 MHz

- RBW = 1 MHz
- VBW ≥ 3 MHz
- Detector = Peak
- Sweep time = auto
- Trace mode = max hold

(3) Procedures for Average Unwanted Emissions Measurements Above 1000MHz

- RBW = 1 MHz
- VBW = 10 Hz, when duty cycle is no less than 98 percent.
- $VBW \geq 1/T$, when duty cycle is less than 98 percent where T is the minimum transmission duration over which the transmitter is on and is transmitting at its maximum power control level for the tested mode of operation.

Band	Duty Cycle(%)	T(us)	1/T(kHz)	VBW Setting
802.11a	98.00	-	-	10Hz
5GHz 802.11n HT20	98.75	-	-	10Hz
5GHz 802.11n HT40	95.46	1416.67	0.71	1kHz
5GHz 802.11ac VHT80	90.41	679.49	1.47	2kHz

2. The EUT was placed on a turntable with 0.8 meter for frequency below 1GHz and 1.5 meter for frequency above 1GHz respectively above ground.
3. The EUT was set 3 meters from the interference receiving antenna which was mounted on the top of a variable height antenna tower.
4. The antenna is a broadband antenna and its height is adjusted between one meter and four meters above ground to find the maximum value of the field strength for both horizontal polarization and vertical polarization of the antenna.
5. For each suspected emission, the EUT was arranged to its worst case and then adjust the antenna tower (from 1 m to 4 m) and turntable (from 0 degree to 360 degrees) to find the maximum reading.
6. For testing below 1GHz, if the emission level of the EUT in peak mode was 3 dB lower than the limit specified, then peak values of EUT will be reported, otherwise, the emissions will be repeated one by one using the CISPR quasi-peak method and reported.
7. For testing above 1GHz, the emission level of the EUT in peak mode was 20dB lower than average limit (that means the emission level in average mode also complies with the limit in average mode), then peak values of EUT will be reported, otherwise, the emissions will be measured in average mode again and reported.

3.4.4 Test Setup

For radiated emissions below 30MHz

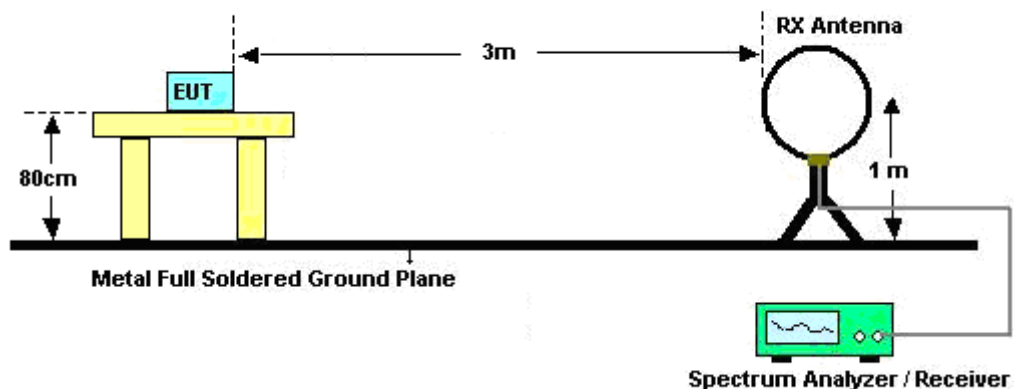

For radiated emissions from 30MHz to 1GHz

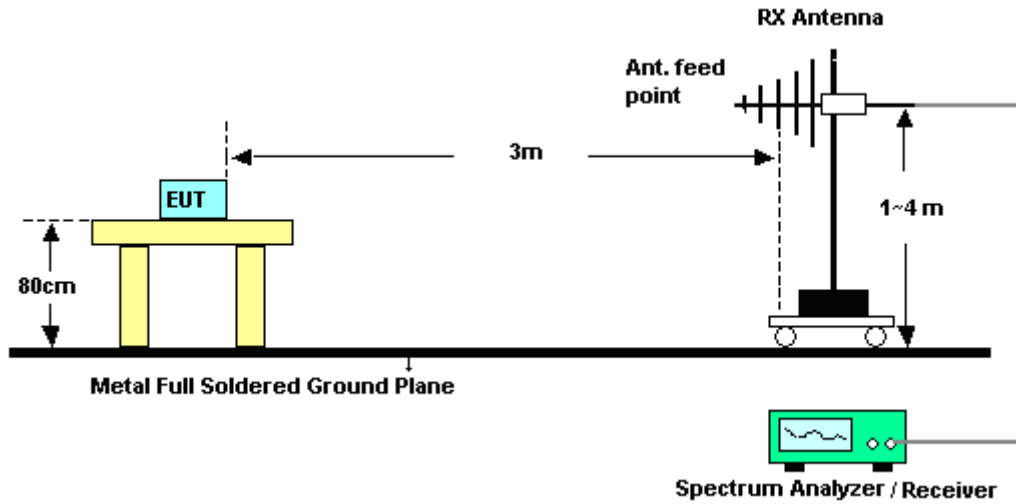

For radiated emissions above 1GHz

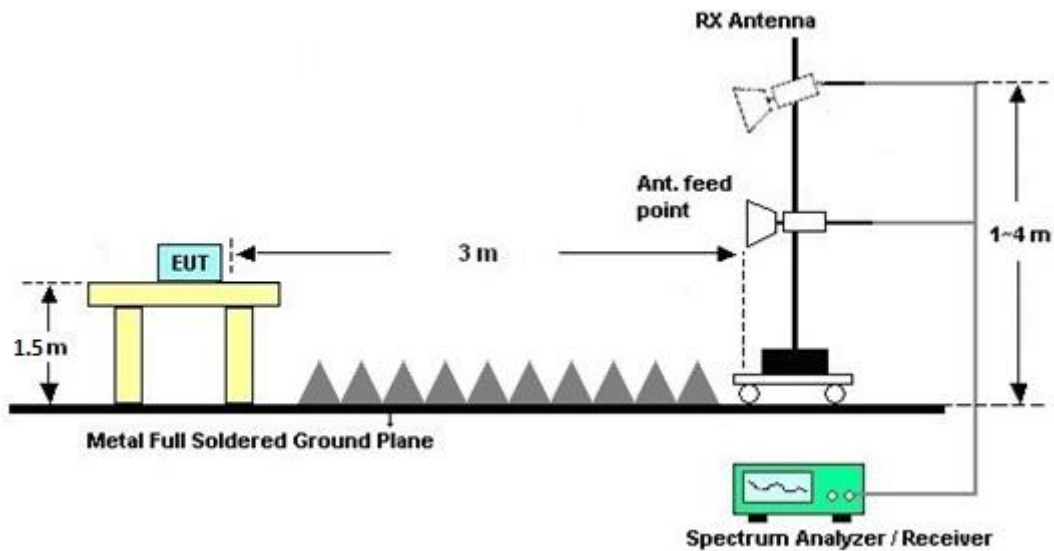

3.4.5 Test Results of Radiated Emissions (9 kHz ~ 30 MHz)

The low frequency, which started from 9 kHz to 30MHz, was pre-scanned and the result which was 20dB lower than the limit line per 15.31(o) was not reported.

3.4.6 Test Result of Radiated Band Edges

Please refer to Appendix B and Appendix C.

3.4.7 Test Result of Unwanted Radiated Emission (30MHz ~ 10th Harmonic)

Please refer to Appendix B and Appendix C.



3.5 AC Conducted Emission Measurement

3.5.1 Limit of AC Conducted Emission

For equipment that is designed to be connected to the public utility (AC) power line, the radio frequency voltage that is conducted back onto the AC power line on any frequency or frequencies within the band 150 kHz to 30 MHz shall not exceed the limits in the following table.

Frequency of emission (MHz)	Conducted limit (dBµV)	
	Quasi-peak	Average
0.15-0.5	66 to 56*	56 to 46*
0.5-5	56	46
5-30	60	50

*Decreases with the logarithm of the frequency.

3.5.2 Measuring Instruments

The measuring equipment is listed in the section 4 of this test report.

3.5.3 Test Procedures

1. The EUT was placed 0.4 meter from the conducting wall of the shielding room was kept at least 80 centimeters from any other grounded conducting surface.
2. Connect EUT to the power mains through a line impedance stabilization network (LISN).
3. All the support units are connecting to the other LISN.
4. The LISN provides 50 ohm coupling impedance for the measuring instrument.
5. The FCC states that a 50 ohm, 50 microhenry LISN should be used.
6. Both sides of AC line were checked for maximum conducted interference.
7. The frequency range from 150 kHz to 30 MHz was searched.
8. Set the test-receiver system to Peak Detect Function and specified bandwidth with Maximum Hold Mode.

3.5.4 Test Setup

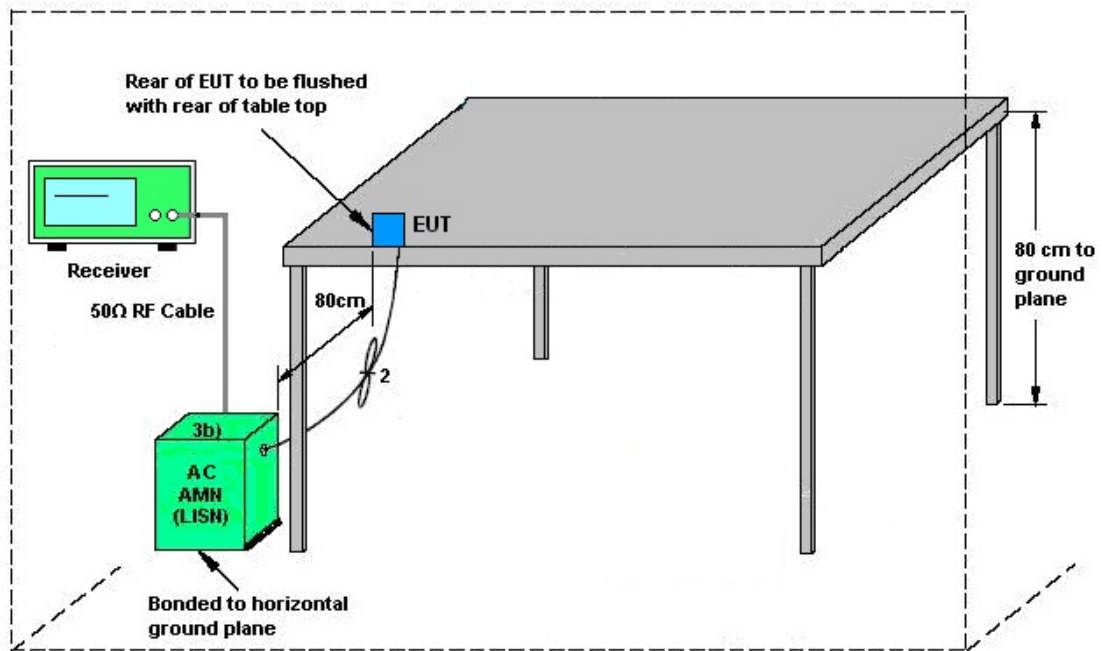

AMN = Artificial mains network (LISN)
AE = Associated equipment
EUT = Equipment under test
ISN = Impedance stabilization network



3.5.5 Test Result of AC Conducted Emission

Test Mode :	Mode 1	Temperature :	23~25°C
Test Engineer :	Eric Jeng	Relative Humidity :	58~61%
Test Voltage :	120Vac / 60Hz	Phase :	Line
Function Type :	WLAN (5GHz) Link + Earphone + USB Cable (Charging from Adapter)		

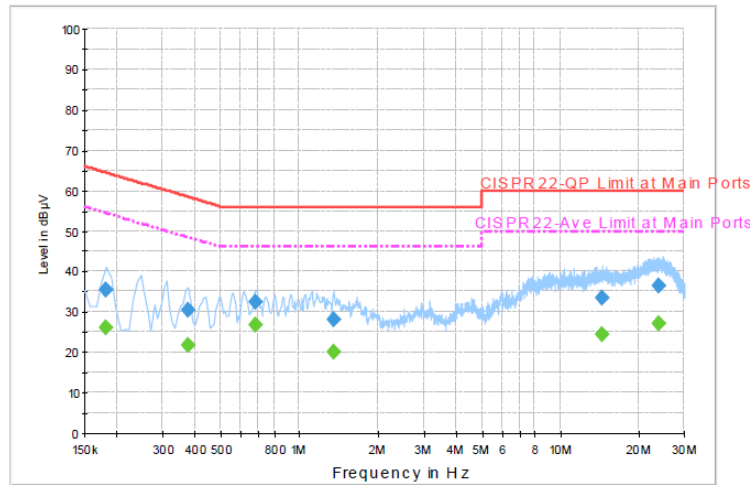

Final Result : QuasiPeak

Frequency (MHz)	QuasiPeak (dBµV)	Filter	Line	Corr. (dB)	Margin (dB)	Limit (dBµV)
0.182000	35.6	Off	L1	19.5	28.8	64.4
0.374000	30.5	Off	L1	19.5	27.9	58.4
0.678000	32.5	Off	L1	19.6	23.5	56.0
1.350000	28.2	Off	L1	19.6	27.8	56.0
14.438000	33.4	Off	L1	20.0	26.6	60.0
24.046000	36.5	Off	L1	20.0	23.5	60.0

Final Result : Average

Frequency (MHz)	Average (dBµV)	Filter	Line	Corr. (dB)	Margin (dB)	Limit (dBµV)
0.182000	26.2	Off	L1	19.5	28.2	54.4
0.374000	21.9	Off	L1	19.5	26.5	48.4
0.678000	26.6	Off	L1	19.6	19.4	46.0
1.350000	20.1	Off	L1	19.6	25.9	46.0
14.438000	24.3	Off	L1	20.0	25.7	50.0
24.046000	27.0	Off	L1	20.0	23.0	50.0



Test Mode :	Mode 1	Temperature :	23~25°C
Test Engineer :	Eric Jeng	Relative Humidity :	58~61%
Test Voltage :	120Vac / 60Hz	Phase :	Neutral
Function Type :	WLAN (5GHz) Link + Earphone + USB Cable (Charging from Adapter)		

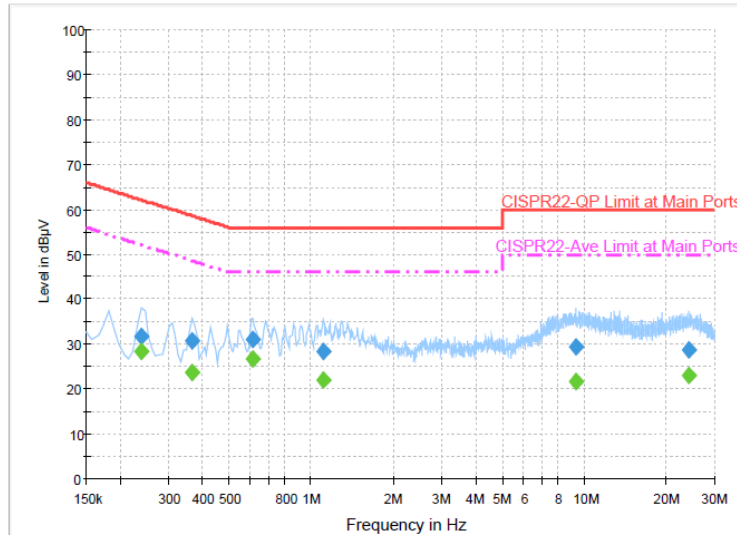

Final Result : QuasiPeak

Frequency (MHz)	QuasiPeak (dBµV)	Filter	Line	Corr. (dB)	Margin (dB)	Limit (dBµV)
0.238000	31.9	Off	N	19.5	30.3	62.2
0.366000	30.8	Off	N	19.5	27.8	58.6
0.614000	31.1	Off	N	19.5	24.9	56.0
1.110000	28.5	Off	N	19.5	27.5	56.0
9.374000	29.6	Off	N	19.8	30.4	60.0
24.078000	28.6	Off	N	20.1	31.4	60.0

Final Result : Average

Frequency (MHz)	Average (dBµV)	Filter	Line	Corr. (dB)	Margin (dB)	Limit (dBµV)
0.238000	28.5	Off	N	19.5	23.7	52.2
0.366000	23.8	Off	N	19.5	24.8	48.6
0.614000	26.7	Off	N	19.5	19.3	46.0
1.110000	21.9	Off	N	19.5	24.1	46.0
9.374000	21.8	Off	N	19.8	28.2	50.0
24.078000	23.1	Off	N	20.1	26.9	50.0

3.6 Frequency Stability Measurement

3.6.1 Limit of Frequency Stability

Manufacturers of U-NII devices are responsible for ensuring frequency stability such that an emission is maintained within the band of operation under all conditions of normal operation as specified in the user's manual.

3.6.2 Measuring Instruments

The measuring equipment is listed in the section 4 of this test report.

3.6.3 Test Procedures

1. To ensure emission at the band edge is maintained within the authorized band, those values shall be measured by radiation emissions at upper and lower frequency points, and finally compensated by frequency deviation as procedures below.
2. The EUT was operated at the maximum output power, and connected to the spectrum analyzer, which is set to maximum hold function and peak detector. The peak value of the power envelope was measured and noted. The upper and lower frequency points were respectively measured relatively 10dB lower than the measured peak value.
3. The frequency deviation was calculated by adding the upper frequency point and the lower frequency point divided by two. Those detailed values of frequency deviation are provided in table below.

3.6.4 Test Setup

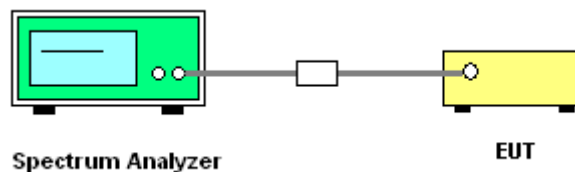

3.6.5 Test Result of Frequency Stability

Please refer to Appendix A.



3.7 Automatically Discontinue Transmission

3.7.1 Limit of Automatically Discontinue Transmission

The device shall automatically discontinue transmission in case of either absence of information to transmit or operational failure. These provisions are not intended to preclude the transmission of control or signaling information or the use of repetitive codes used by certain digital technologies to complete frame or burst intervals. Applicants shall include in their application for equipment authorization to describe how this requirement is met.

3.7.2 Measuring Instruments

The measuring equipment is listed in the section 4 of this test report.

3.7.3 Test Result of Automatically Discontinue Transmission

While the EUT is not transmitting any information, the EUT can automatically discontinue transmission and become standby mode for power saving. The EUT can detect the controlling signal of ACK message transmitting from remote device and verify whether it shall resend or discontinue transmission.



3.8 Antenna Requirements

3.8.1 Standard Applicable

According to FCC 47 CFR Section 15.407(a)(1)(2) ,if transmitting antenna directional gain is greater than 6 dBi, both the peak transmit power and the peak power spectral density shall be reduced by the amount in dB that the directional gain of the antenna exceeds 6 dBi.

3.8.2 Antenna Anti-Replacement Construction

An embedded-in antenna design is used.

3.8.3 Antenna Gain

The antenna peak gain of EUT is less than 6 dBi. Therefore, it is not necessary to reduce maximum peak output power limit.



4 List of Measuring Equipment

Instrument	Manufacturer	Model No.	Serial No.	Characteristics	Calibration Date	Test Date	Due Date	Remark
Power Meter	Anritsu	ML2495A	1218006	300MHz~40GHz	Oct. 18, 2014	Aug. 03, 2015~ Aug. 12, 2015	Oct. 17, 2015	Conducted (TH05-HY)
Power Sensor	Anritsu	MA2411B	1207363	300MHz~40GHz	Oct. 18, 2014	Aug. 03, 2015~ Aug. 12, 2015	Oct. 17, 2015	Conducted (TH05-HY)
Spectrum Analyzer	Rohde & Schwarz	FSP40	100057	9kHz-40GHz	Oct. 17, 2014	Aug. 03, 2015~ Aug. 12, 2015	Oct. 16, 2015	Conducted (TH05-HY)
Temperature Chamber	ESPEC	SU-241	92003713	-30° ~ 95°	Jun. 15, 2015	Aug. 03, 2015~ Aug. 12, 2015	Jun. 14, 2016	Conducted (TH05-HY)
Hygrometer	Testo	608-H1	34897199	N/A	May 04, 2015	Aug. 03, 2015~ Aug. 12, 2015	May 03, 2016	Conducted (TH05-HY)
RF Cable	HARBOUR INDUSTRIES	LL142	Infinet CA3601-3601- DLL	0.1MHz~40GHz	Mar. 06, 2015	Aug. 03, 2015~ Aug. 12, 2015	Mar. 05, 2016	Conducted (TH05-HY)
Bilog Antenna	Schaffner	CBL6111C	2726	30MHz ~ 1GHz	Sep. 27, 2014	Aug. 05, 2015 ~ Aug. 26, 2015	Sep. 26, 2015	Radiation (03CH07-HY)
Double Ridge Horn Antenna	EMCO	3117	00066583	1GHz~18GHz	Jul. 20, 2015	Aug. 05, 2015 ~ Aug. 26, 2015	Jul. 19, 2016	Radiation (03CH07-HY)
Loop Antenna	TESEQ	HLA 6120	31244	9kHz~30MHz	Feb. 02, 2015	Aug. 05, 2015 ~ Aug. 26, 2015	Feb. 01, 2016	Radiation (03CH07-HY)
EMI Test Receiver	Rohde & Schwarz	ESCI 7	100724	9kHz~7GHz	Aug. 30, 2014	Aug. 05, 2015 ~ Aug. 26, 2015	Aug. 29, 2015	Radiation (03CH07-HY)
Horn Antenna	SCHWARZBECK	BBHA 9170	BBHA917058 4	18GHz- 40GHz	Nov. 03, 2014	Aug. 05, 2015 ~ Aug. 26, 2015	Nov. 02, 2015	Radiation (03CH07-HY)
Hygrometer	Testo	608-H1	34897197	N/A	May 04, 2015	Aug. 05, 2015 ~ Aug. 26, 2015	May 03, 2016	Radiation (03CH07-HY)
Preamplifier	MITEQ	AMF-7D-0010 1800-30-10P	1590075	1GHz ~ 18GHz	Apr. 20, 2015	Aug. 05, 2015 ~ Aug. 26, 2015	Apr. 19, 2016	Radiation (03CH07-HY)
Preamplifier	COM-POWER	PA-103A	161241	10MHz-1000MHz	Mar. 12, 2015	Aug. 05, 2015 ~ Aug. 26, 2015	Mar. 11, 2016	Radiation (03CH07-HY)
Preamplifier	Agilent	8449B	3008A02362	1GHz~ 26.5GHz	Oct. 21, 2014	Aug. 05, 2015 ~ Aug. 26, 2015	Oct. 20, 2015	Radiation (03CH07-HY)
Signal Analyzer	Rohde & Schwarz	FSV 30	101749	10Hz~30GHz	Mar. 10, 2015	Aug. 05, 2015 ~ Aug. 26, 2015	Mar. 09, 2016	Radiation (03CH07-HY)
RF Cable	HUBER + SUHNER	SUCOFLEX 104	MY84209521	1GHz~40GHz	Dec. 04, 2014	Aug. 05, 2015 ~ Aug. 26, 2015	Dec. 03, 2015	Radiation (03CH07-HY)
RF Cable	HUBER + SUHNER	SUCOFLEX 104	MY84209521	9KHz~1GHz	Dec. 04, 2014	Aug. 05, 2015 ~ Aug. 26, 2015	Dec. 03, 2015	Radiation (03CH07-HY)
Controller	ChainTek	Chaintek 3000	N/A	Control Turn table	N/A	Aug. 05, 2015 ~ Aug. 26, 2015	N/A	Radiation (03CH07-HY)
Controller	Max-Full	MF7802	MF780208368	Control Ant Mast	N/A	Aug. 05, 2015 ~ Aug. 26, 2015	N/A	Radiation (03CH07-HY)
Antenna Mast	Max-Full	MFA520BS	N/A	1m~4m	N/A	Aug. 05, 2015 ~ Aug. 26, 2015	N/A	Radiation (03CH07-HY)
Turn Table	ChainTek	Chaintek 3000	N/A	0~360 degree	N/A	Aug. 05, 2015 ~ Aug. 26, 2015	N/A	Radiation (03CH07-HY)



Instrument	Manufacturer	Model No.	Serial No.	Characteristics	Calibration Date	Test Date	Due Date	Remark
Preamplifier	MITEQ	JS44-1800400 0-33-8P	1840917	18GHz ~ 40GHz	Jun. 02, 2015	Aug. 05, 2015 ~ Aug. 26, 2015	Jun. 01, 2016	Radiation (03CH07-HY)
Test Software	Audix	E3	6.2009-8-24	N/A	N/A	Aug. 05, 2015 ~ Aug. 26, 2015	N/A	Radiation (03CH07-HY)
Filter	Wainwright	WLKS4500-8S S	SN19	4.5G Low Pass	Oct. 01, 2014	Aug. 05, 2015 ~ Aug. 26, 2015	Sep. 30, 2015	Radiation (03CH07-HY)
Filter	Microwave Circuits	H07G18G3	SN8009-01	7GHz HPF	Oct. 01, 2014	Aug. 05, 2015 ~ Aug. 26, 2015	Sep. 30, 2015	Radiation (03CH07-HY)
EMI Test Receiver	Rohde & Schwarz	ESCS 30	100356	9kHz – 2.75GHz	Dec. 01, 2014	Aug. 15, 2015	Nov. 30, 2015	Conduction (CO05-HY)
Hygrometer	Testo	608-H1	34913912	N/A	Apr. 20, 2015	Aug. 15, 2015	Apr. 19, 2016	Conduction (CO05-HY)
LISN	Rohde & Schwarz	ENV216	100080	9kHz~30MHz	Dec. 02, 2014	Aug. 15, 2015	Dec. 01, 2015	Conduction (CO05-HY)
AC Power Source	ChainTek	APC-1000W	N/A	N/A	N/A	Aug. 15, 2015	N/A	Conduction (CO05-HY)
LF Cable	HUBER + SUHNER	RG-214/U	LF01	N/A	Jan. 07, 2015	Aug. 15, 2015	Jan. 06, 2016	Conduction (CO05-HY)
Test Software	N/A	EMC32	8.40.0	N/A	N/A	Aug. 15, 2015	N/A	Conduction (CO05-HY)



5 Uncertainty of Evaluation

Uncertainty of Conducted Emission Measurement (150kHz ~ 30MHz)

Measuring Uncertainty for a Level of Confidence of 95% ($U = 2Uc(y)$)	2.26
---	------

Uncertainty of Radiated Emission Measurement (30 MHz ~ 1000 MHz)

Measuring Uncertainty for a Level of Confidence of 95% ($U = 2Uc(y)$)	4.8
---	-----



Appendix A. Conducted Test Results

Test Engineer:	Tommy Lee	Temperature:	21~25	°C
Test Date:	2015/08/03 ~ 2015/08/12	Relative Humidity:	51~54	%

TEST RESULTS DATA
6dB Bandwidth

Band IV							
Mod.	Data Rate	NTX	CH.	Freq. (MHz)	6 dB Bandwidth (MHz)	FCC 6dB Bandwidth Limit (MHz)	Pass/Fail
11a	6M bps	1	149	5745	16.32	0.5	Pass
11a	6Mbps	1	157	5785	16.32	0.5	Pass
11a	6Mbps	1	165	5825	16.32	0.5	Pass
HT20	MCS 0	1	149	5745	17.56	0.5	Pass
HT20	MCS 0	1	157	5785	17.56	0.5	Pass
HT20	MCS 0	1	165	5825	17.52	0.5	Pass
HT40	MCS 0	1	151	5755	36	0.5	Pass
HT40	MCS 0	1	159	5795	36	0.5	Pass
VHT20	MCS 0	1	149	5745	17.56	0.5	Pass
VHT20	MCS 0	1	157	5785	17.56	0.5	Pass
VHT20	MCS 0	1	165	5825	17.52	0.5	Pass
VHT40	MCS 0	1	151	5755	36.08	0.5	Pass
VHT40	MCS 0	1	159	5795	36	0.5	Pass
VHT80	MCS 0	1	155	5775	76.32	0.5	Pass

TEST RESULTS DATA
Average Power Table

Band IV										
Mod.	Data Rate	NTX	CH.	Freq. (MHz)	Duty Factor (dB)	Average Conducted Power (dBm)	FCC Conducted Power Limit (dBm)	DG (dBi)		Pass/Fail
11a	6M bps	1	149	5745	0.09	12.50	30.00	-4.62		Pass
11a	6Mbps	1	157	5785	0.09	12.60	30.00	-4.62		Pass
11a	6Mbps	1	165	5825	0.09	12.52	30.00	-4.62		Pass
HT20	MCS 0	1	149	5745	0.05	12.50	30.00	-4.62		Pass
HT20	MCS 0	1	157	5785	0.05	12.59	30.00	-4.62		Pass
HT20	MCS 0	1	165	5825	0.05	12.53	30.00	-4.62		Pass
HT40	MCS 0	1	151	5755	0.20	12.36	30.00	-4.62		Pass
HT40	MCS 0	1	159	5795	0.20	12.64	30.00	-4.62		Pass
VHT20	MCS 0	1	149	5745	0.05	12.19	30.00	-4.62		Pass
VHT20	MCS 0	1	157	5785	0.05	12.33	30.00	-4.62		Pass
VHT20	MCS 0	1	165	5825	0.05	12.31	30.00	-4.62		Pass
VHT40	MCS 0	1	151	5755	0.25	12.32	30.00	-4.62		Pass
VHT40	MCS 0	1	159	5795	0.25	12.50	30.00	-4.62		Pass
VHT80	MCS 0	1	155	5775	0.44	12.79	30.00	-4.62		Pass

TEST RESULTS DATA
Power Spectral Density

Band IV										
Mod.	Data Rate	NTx	CH.	Freq. (MHz)	Duty Factor (dB)	10log (500kHz /RBW) Factor (dB)	Average Power Density (dBm/500kHz)	Average PSD Limit (dBm/500kHz)	DG (dBi)	Pass/Fail
11a	6M bps	1	149	5745	0.09	2.22	-0.86	30.00	-4.62	Pass
11a	6Mbps	1	157	5785	0.09	2.22	-1.10	30.00	-4.62	Pass
11a	6Mbps	1	165	5825	0.09	2.22	-1.01	30.00	-4.62	Pass
HT20	MCS 0	1	149	5745	0.05	2.22	-1.22	30.00	-4.62	Pass
HT20	MCS 0	1	157	5785	0.05	2.22	-1.38	30.00	-4.62	Pass
HT20	MCS 0	1	165	5825	0.05	2.22	-1.28	30.00	-4.62	Pass
HT40	MCS 0	1	151	5755	0.20	2.22	-4.20	30.00	-4.62	Pass
HT40	MCS 0	1	159	5795	0.20	2.22	-4.31	30.00	-4.62	Pass
VHT20	MCS 0	1	149	5745	0.05	2.22	-1.13	30.00	-4.62	Pass
VHT20	MCS 0	1	157	5785	0.05	2.22	-1.27	30.00	-4.62	Pass
VHT20	MCS 0	1	165	5825	0.05	2.22	-1.32	30.00	-4.62	Pass
VHT40	MCS 0	1	151	5755	0.25	2.22	-4.25	30.00	-4.62	Pass
VHT40	MCS 0	1	159	5795	0.25	2.22	-4.20	30.00	-4.62	Pass
VHT80	MCS 0	1	155	5775	0.44	2.22	-2.23	30.00	-4.62	Pass

TEST RESULTS DATA
Frequency Stability

Band IV										
Mod.	Data Rate	NTX	CH.	Freq. (MHz)	Center Frequency (MHz)	Frequency Deviation (MHz)	Frequency Stability (ppm)	Temperature (°C)	Voltage (V)	Note
11a	6M bps	1	149	5745	5745.000	0.000	0.00	20	3.6	
11a	6M bps	1	149	5745	5745.000	0.000	0.00	20	4.2	
11a	6M bps	1	149	5745	5745.000	0.000	0.00	20	3.8	
11a	6M bps	1	149	5745	5745.050	0.050	8.70	-10	3.8	
11a	6M bps	1	149	5745	5745.000	0.000	0.00	55	3.8	



Appendix B. Radiated Spurious Emission

Test Engineer :	Wei Chen, Ken Wu and James Chiu	Temperature :	21~23°C
		Relative Humidity :	60~63%

15E Band 4 5725~5850MHz

WIFI 802.11a (Band Edge @ 3m)

WIFI	Note	Frequency	Level	Over	Limit	Read	Antenna	Cable	Preamp	Ant	Table	Peak	Pol.	
Ant.				Limit	Line	Level	Factor	Loss	Factor	Pos	Pos	Avg.		
1		(MHz)	(dBμV/m)	(dB)	(dBμV/m)	(dBμV)	(dB/m)	(dB)	(dB)	(cm)	(deg)	(P/A)	(H/V)	
802.11a CH 149 5745MHz		5714.76	66.65	-7.35	74	53.32	35.22	12.26	34.15	100	173	P	H	
		5724.92	71.27	-7.03	78.3	57.93	35.23	12.26	34.15	100	173	P	H	
		5715	44.42	-9.58	54	31.09	35.22	12.26	34.15	100	173	A	H	
	*	5746	102.85	-	-	89.45	35.24	12.33	34.17	100	173	P	H	
	*	5746	91.98	-	-	78.58	35.24	12.33	34.17	100	173	A	H	
														H
														H
														H
			5715	65.95	-8.05	74	52.62	35.22	12.26	34.15	102	25	P	V
			5724.6	70.2	-8.1	78.3	56.86	35.23	12.26	34.15	102	25	P	V
			5714.6	44.26	-9.74	54	30.93	35.22	12.26	34.15	102	25	A	V
	*		5745	101.97	-	-	88.57	35.24	12.33	34.17	102	25	P	V
	*		5745	91.43	-	-	78.03	35.24	12.33	34.17	102	25	A	V
														V
														V
													V	



WIFI	Note	Frequency	Level	Over	Limit	Read	Antenna	Cable	Preamp	Ant	Table	Peak	Pol.
Ant.				Limit	Line	Level	Factor	Loss	Factor	Pos	Pos	Avg.	
1		(MHz)	(dBμV/m)	(dB)	(dBμV/m)	(dBμV)	(dB/m)	(dB)	(dB)	(cm)	(deg)	(P/A)	(H/V)
802.11a CH 157 5785MHz		5712.2	57.44	-16.56	74	44.11	35.22	12.26	34.15	102	171	P	H
		5719.4	58.8	-19.5	78.3	45.46	35.23	12.26	34.15	102	171	P	H
		5714.28	43.26	-10.74	54	29.93	35.22	12.26	34.15	102	171	A	H
	*	5785	101.79	-	-	88.35	35.27	12.4	34.23	102	171	P	H
	*	5785	91.77	-	-	78.33	35.27	12.4	34.23	102	171	A	H
		5859.36	56.61	-21.69	78.3	43.19	35.32	12.45	34.35	102	171	P	H
		5869.44	57.98	-16.02	74	44.52	35.32	12.49	34.35	102	171	P	H
		5860.88	43.49	-10.51	54	30.03	35.32	12.49	34.35	102	171	A	H
		5690.36	57.82	-16.18	74	44.55	35.21	12.18	34.12	102	25	P	V
		5724.28	59.55	-18.75	78.3	46.21	35.23	12.26	34.15	102	25	P	V
		5713	43.24	-10.76	54	29.91	35.22	12.26	34.15	102	25	A	V
	*	5784	101.37	-	-	87.93	35.27	12.4	34.23	102	25	P	V
	*	5784	92.1	-	-	78.66	35.27	12.4	34.23	102	25	A	V
		5850.96	56.57	-21.73	78.3	43.12	35.31	12.45	34.31	102	25	P	V
		5862.32	57.4	-16.6	74	43.94	35.32	12.49	34.35	102	25	P	V
		5860	43.47	-10.53	54	30.05	35.32	12.45	34.35	102	25	A	V



WIFI	Note	Frequency	Level	Over	Limit	Read	Antenna	Cable	Preamp	Ant	Table	Peak	Pol.	
Ant.				Limit	Line	Level	Factor	Loss	Factor	Pos	Pos	Avg.		
1		(MHz)	(dBμV/m)	(dB)	(dBμV/m)	(dBμV)	(dB/m)	(dB)	(dB)	(cm)	(deg)	(P/A)	(H/V)	
802.11a CH 165 5825MHz	*	5827	102.18	-	-	88.7	35.3	12.45	34.27	102	169	P	H	
	*	5827	91.88	-	-	78.4	35.3	12.45	34.27	102	169	A	H	
		5852	60.84	-17.46	78.3	47.39	35.31	12.45	34.31	102	169	P	H	
		5860.4	59.1	-14.9	74	45.64	35.32	12.49	34.35	102	169	P	H	
		5860.24	44.04	-9.96	54	30.58	35.32	12.49	34.35	102	169	A	H	
														H
														H
														H
	*	5825	100.62	-	-	87.14	35.3	12.45	34.27	102	14	P	V	
	*	5825	90.52	-	-	77.04	35.3	12.45	34.27	102	14	A	V	
		5855.6	60.43	-17.87	78.3	46.97	35.32	12.45	34.31	102	14	P	V	
		5883.12	57.76	-16.24	74	44.29	35.33	12.49	34.35	102	14	P	V	
		5860.56	43.82	-10.18	54	30.36	35.32	12.49	34.35	102	14	A	V	
														V
														V
														V
														V
	Remark	1. No other spurious found. 2. All results are PASS against Peak and Average limit line.												



15E Band 4 5725~5850MHz
WIFI 802.11a (Harmonic @ 3m)

WIFI	Note	Frequency	Level	Over	Limit	Read	Antenna	Cable	Preamp	Ant	Table	Peak	Pol.
Ant.				Limit	Line	Level	Factor	Loss	Factor	Pos	Pos	Avg.	
1		(MHz)	(dBµV/m)	(dB)	(dBµV/m)	(dBµV)	(dB/m)	(dB)	(dB)	(cm)	(deg)	(P/A)	(H/V)
802.11a CH 149 5745MHz		11490	44.96	-29.04	74	47.23	38.19	17.38	57.84	100	0	P	H
		17235	49.81	-24.19	74	42.76	42.21	21.38	56.54	100	0	P	H
													H
													H
		11490	44.95	-29.05	74	47.22	38.19	17.38	57.84	100	0	P	V
		17235	50.44	-23.56	74	43.39	42.21	21.38	56.54	100	0	P	V
													V
													V
802.11a CH 157 5785MHz		11570	44.42	-29.58	74	46.35	38.3	17.46	57.69	100	0	P	H
		17352	49.87	-24.13	74	42.91	42.12	21.45	56.61	100	0	P	H
													H
													H
		11570	45.29	-28.71	74	47.22	38.3	17.46	57.69	100	0	P	V
		17352	49.59	-24.41	74	42.63	42.12	21.45	56.61	100	0	P	V
													V
													V
802.11a CH 165 5825MHz		11650	44.16	-29.84	74	45.82	38.39	17.53	57.58	100	0	P	H
		17472	50.94	-23.06	74	44.06	42.03	21.53	56.68	100	0	P	H
													H
													H
		11650	46.78	-27.22	74	48.44	38.39	17.53	57.58	100	0	P	V
		17472	50.94	-23.06	74	44.06	42.03	21.53	56.68	100	0	P	V
													V
													V
Remark	1. No other spurious found. 2. All results are PASS against Peak and Average limit line.												



15E Band 4 5725~5850MHz
WIFI 802.11n HT20 (Band Edge @ 3m)

WIFI	Note	Frequency	Level	Over	Limit	Read	Antenna	Cable	Preamp	Ant	Table	Peak	Pol.	
Ant.				Limit	Line	Level	Factor	Loss	Factor	Pos	Pos	Avg.		
1		(MHz)	(dBμV/m)	(dB)	(dBμV/m)	(dBμV)	(dB/m)	(dB)	(dB)	(cm)	(deg)	(P/A)	(H/V)	
802.11n HT20 CH 149 5745MHz		5714.36	66.95	-7.05	74	53.62	35.22	12.26	34.15	102	169	P	H	
		5725	72.3	-6	78.3	58.96	35.23	12.26	34.15	102	169	P	H	
		5714.92	44.32	-9.68	54	30.99	35.22	12.26	34.15	102	169	A	H	
	*	5747	102.54	-	-	89.14	35.24	12.33	34.17	102	169	P	H	
	*	5747	92.04	-	-	78.64	35.24	12.33	34.17	102	169	A	H	
														H
														H
														H
			5714.44	65.64	-8.36	74	52.31	35.22	12.26	34.15	102	26	P	V
			5724.92	71.63	-6.67	78.3	58.29	35.23	12.26	34.15	102	26	P	V
			5715	44.17	-9.83	54	30.84	35.22	12.26	34.15	102	26	A	V
	*		5745	101.45	-	-	88.05	35.24	12.33	34.17	102	26	P	V
	*		5745	91.08	-	-	77.68	35.24	12.33	34.17	102	26	A	V
														V
													V	
													V	



WIFI	Note	Frequency	Level	Over	Limit	Read	Antenna	Cable	Preamp	Ant	Table	Peak	Pol.
Ant.				Limit	Line	Level	Factor	Loss	Factor	Pos	Pos	Avg.	
1		(MHz)	(dBμV/m)	(dB)	(dBμV/m)	(dBμV)	(dB/m)	(dB)	(dB)	(cm)	(deg)	(P/A)	(H/V)
802.11n HT20 CH 157 5785MHz		5712.6	58.72	-15.28	74	45.39	35.22	12.26	34.15	101	168	P	H
		5724.44	61.97	-16.33	78.3	48.63	35.23	12.26	34.15	101	168	P	H
		5714.6	43.48	-10.52	54	30.15	35.22	12.26	34.15	101	168	A	H
	*	5785	105.39	-	-	91.95	35.27	12.4	34.23	101	168	P	H
	*	5785	92.44	-	-	79	35.27	12.4	34.23	101	168	A	H
		5859.04	56.96	-21.34	78.3	43.54	35.32	12.45	34.35	101	168	P	H
		5864.4	57.76	-16.24	74	44.3	35.32	12.49	34.35	101	168	P	H
		5860.16	43.65	-10.35	54	30.19	35.32	12.49	34.35	101	168	A	H
		5715	59.62	-14.38	74	46.29	35.22	12.26	34.15	101	23	P	V
		5718.84	60.85	-17.45	78.3	47.51	35.23	12.26	34.15	101	23	P	V
		5705.72	43.37	-10.63	54	30.04	35.22	12.26	34.15	101	23	A	V
	*	5785	103.97	-	-	90.53	35.27	12.4	34.23	101	23	P	V
	*	5785	91.67	-	-	78.23	35.27	12.4	34.23	101	23	A	V
		5859.68	57.31	-20.99	78.3	43.89	35.32	12.45	34.35	101	23	P	V
		5876.32	57.01	-16.99	74	43.54	35.33	12.49	34.35	101	23	P	V
		5860.24	43.61	-10.39	54	30.15	35.32	12.49	34.35	101	23	A	V



WIFI	Note	Frequency	Level	Over	Limit	Read	Antenna	Cable	Preamp	Ant	Table	Peak	Pol.	
Ant.				Limit	Line	Level	Factor	Loss	Factor	Pos	Pos	Avg.		
1		(MHz)	(dBμV/m)	(dB)	(dBμV/m)	(dBμV)	(dB/m)	(dB)	(dB)	(cm)	(deg)	(P/A)	(H/V)	
802.11n HT20 CH 165 5825MHz	*	5825	104.2	-	-	90.72	35.3	12.45	34.27	101	169	P	H	
	*	5825	92.09	-	-	78.61	35.3	12.45	34.27	101	169	A	H	
		5854.08	62.81	-15.49	78.3	49.35	35.32	12.45	34.31	101	169	P	H	
		5863.52	59.75	-14.25	74	46.29	35.32	12.49	34.35	101	169	P	H	
		5860.16	44.27	-9.73	54	30.81	35.32	12.49	34.35	101	169	A	H	
														H
														H
														H
	*	5825	103.42	-	-	89.94	35.3	12.45	34.27	101	20	20	P	V
	*	5825	91.28	-	-	77.8	35.3	12.45	34.27	101	20	20	A	V
		5850.64	64.99	-13.31	78.3	51.54	35.31	12.45	34.31	101	20	20	P	V
		5862.48	60.2	-13.8	74	46.74	35.32	12.49	34.35	101	20	20	P	V
		5860.72	44.17	-9.83	54	30.71	35.32	12.49	34.35	101	20	20	A	V
														V
													V	
													V	
Remark	1. No other spurious found. 2. All results are PASS against Peak and Average limit line.													



15E Band 4 5725-5850MHz

WIFI 802.11n HT20 (Harmonic @ 3m)

WIFI	Note	Frequency	Level	Over	Limit	Read	Antenna	Cable	Preamp	Ant	Table	Peak	Pol.
Ant.				Limit	Line	Level	Factor	Loss	Factor	Pos	Pos	Avg.	
1		(MHz)	(dBµV/m)	(dB)	(dBµV/m)	(dBµV)	(dB/m)	(dB)	(dB)	(cm)	(deg)	(P/A)	(H/V)
802.11n HT20 CH 149 5745MHz		11490	44.68	-29.32	74	46.95	38.19	17.38	57.84	100	0	P	H
		17232	50.3	-23.7	74	43.25	42.21	21.38	56.54	100	0	P	H
													H
													H
		11490	44.91	-29.09	74	47.18	38.19	17.38	57.84	100	0	P	V
		17232	50.23	-23.77	74	43.18	42.21	21.38	56.54	100	0	P	V
													V
802.11n HT20 CH 157 5785MHz		11570	43.6	-30.4	74	45.53	38.3	17.46	57.69	100	0	P	H
		17352	50.12	-23.88	74	43.16	42.12	21.45	56.61	100	0	P	H
													H
													H
		11570	44.89	-29.11	74	46.82	38.3	17.46	57.69	100	0	P	V
		17352	49.13	-24.87	74	42.17	42.12	21.45	56.61	100	0	P	V
													V
802.11n HT20 CH 165 5825MHz		11650	46.78	-27.22	74	48.44	38.39	17.53	57.58	100	0	P	H
		17472	50.27	-23.73	74	43.39	42.03	21.53	56.68	100	0	P	H
													H
													H
		11650	45.46	-28.54	74	47.12	38.39	17.53	57.58	100	0	P	V
		17472	50.48	-23.52	74	43.6	42.03	21.53	56.68	100	0	P	V
													V
Remark	1. No other spurious found.												
	2. All results are PASS against Peak and Average limit line.												



**15E Band 4 5725~5850MHz
WIFI 802.11n HT40 (Band Edge @ 3m)**

WIFI	Note	Frequency	Level	Over	Limit	Read	Antenna	Cable	Preamp	Ant	Table	Peak	Pol.
Ant.				Limit	Line	Level	Factor	Loss	Factor	Pos	Pos	Avg.	
1		(MHz)	(dBµV/m)	(dB)	(dBµV/m)	(dBµV)	(dB/m)	(dB)	(dB)	(cm)	(deg)	(P/A)	(H/V)
802.11n HT40 CH 151 5755MHz		5713.96	65.24	-8.76	74	51.91	35.22	12.26	34.15	101	163	P	H
		5723.64	69.55	-8.75	78.3	56.21	35.23	12.26	34.15	101	163	P	H
		5714.28	49.95	-4.05	54	36.62	35.22	12.26	34.15	101	163	A	H
	*	5755	101.5	-	-	88.08	35.26	12.33	34.17	101	163	P	H
	*	5755	90.8	-	-	77.38	35.26	12.33	34.17	101	163	A	H
		5852.88	57.79	-20.51	78.3	44.34	35.31	12.45	34.31	101	163	P	H
		5877.92	57.44	-16.56	74	43.97	35.33	12.49	34.35	101	163	P	H
		5883.28	44.56	-9.44	54	31.13	35.33	12.49	34.39	101	163	A	H
		5711.4	65.92	-8.08	74	52.59	35.22	12.26	34.15	101	21	P	V
		5721.88	69.36	-8.94	78.3	56.02	35.23	12.26	34.15	101	21	P	V
		5714.92	49.58	-4.42	54	36.25	35.22	12.26	34.15	101	21	A	V
	*	5755	101.36	-	-	87.94	35.26	12.33	34.17	101	21	P	V
	*	5755	90.61	-	-	77.19	35.26	12.33	34.17	101	21	A	V
		5854.88	57.39	-20.91	78.3	43.93	35.32	12.45	34.31	101	21	P	V
		5867.68	57.47	-16.53	74	44.01	35.32	12.49	34.35	101	21	P	V
		5866.8	44.42	-9.58	54	30.96	35.32	12.49	34.35	101	21	A	V



WIFI	Note	Frequency	Level	Over	Limit	Read	Antenna	Cable	Preamp	Ant	Table	Peak	Pol.
Ant.				Limit	Line	Level	Factor	Loss	Factor	Pos	Pos	Avg.	
1		(MHz)	(dBμV/m)	(dB)	(dBμV/m)	(dBμV)	(dB/m)	(dB)	(dB)	(cm)	(deg)	(P/A)	(H/V)
802.11n HT40 CH 159 5795MHz		5707.88	57.42	-16.58	74	44.09	35.22	12.26	34.15	101	169	P	H
		5724.92	58.34	-19.96	78.3	45	35.23	12.26	34.15	101	169	P	H
		5714.68	44.67	-9.33	54	31.34	35.22	12.26	34.15	101	169	A	H
	*	5795	102.46	-	-	89.01	35.28	12.4	34.23	101	169	P	H
	*	5795	90.83	-	-	77.38	35.28	12.4	34.23	101	169	A	H
		5855.2	59.16	-19.14	78.3	45.7	35.32	12.45	34.31	101	169	P	H
		5868.72	58.03	-15.97	74	44.57	35.32	12.49	34.35	101	169	P	H
		5860.96	44.69	-9.31	54	31.23	35.32	12.49	34.35	101	169	A	H
		5712.12	58.09	-15.91	74	44.76	35.22	12.26	34.15	101	23	P	V
		5724.2	57.41	-20.89	78.3	44.07	35.23	12.26	34.15	101	23	P	V
		5713.48	44.67	-9.33	54	31.34	35.22	12.26	34.15	101	23	A	V
	*	5795	101	-	-	87.55	35.28	12.4	34.23	101	23	P	V
	*	5795	89.61	-	-	76.16	35.28	12.4	34.23	101	23	A	V
		5851.52	58.9	-19.4	78.3	45.45	35.31	12.45	34.31	101	23	P	V
		5860.16	57.81	-16.19	74	44.35	35.32	12.49	34.35	101	23	P	V
	5865.44	44.64	-9.36	54	31.18	35.32	12.49	34.35	101	23	A	V	
Remark	1. No other spurious found. 2. All results are PASS against Peak and Average limit line.												



15E Band 4 5725~5850MHz

WIFI 802.11n HT40 (Harmonic @ 3m)

WIFI	Note	Frequency	Level	Over	Limit	Read	Antenna	Cable	Preamp	Ant	Table	Peak	Pol.
Ant.				Limit	Line	Level	Factor	Loss	Factor	Pos	Pos	Avg.	
1		(MHz)	(dBμV/m)	(dB)	(dBμV/m)	(dBμV)	(dB/m)	(dB)	(dB)	(cm)	(deg)	(P/A)	(H/V)
802.11n HT40 CH 151 5755MHz		11510	43.68	-30.32	74	45.86	38.2	17.42	57.8	100	0	P	H
		17265	50.86	-23.14	74	43.83	42.19	21.4	56.56	100	0	P	H
													H
													H
		11510	44.18	-29.82	74	46.36	38.2	17.42	57.8	100	0	P	V
		17268	50.82	-23.18	74	43.79	42.19	21.4	56.56	100	0	P	V
													V
802.11n HT40 CH 159 5795MHz		11590	43.38	-30.62	74	45.22	38.32	17.5	57.66	100	0	P	H
		17385	50.48	-23.52	74	43.54	42.09	21.48	56.63	100	0	P	H
													H
													H
		11590	43.56	-30.44	74	45.4	38.32	17.5	57.66	100	0	P	V
		17385	50.08	-23.92	74	43.14	42.09	21.48	56.63	100	0	P	V
													V
Remark	1. No other spurious found.												
	2. All results are PASS against Peak and Average limit line.												



15E Band 4 5725~5850MHz
WIFI 802.11ac VHT80 (Band Edge @ 3m)

WIFI	Note	Frequency	Level	Over	Limit	Read	Antenna	Cable	Preamp	Ant	Table	Peak	Pol.	
Ant.				Limit	Line	Level	Factor	Loss	Factor	Pos	Pos	Avg.		
1		(MHz)	(dBμV/m)	(dB)	(dBμV/m)	(dBμV)	(dB/m)	(dB)	(dB)	(cm)	(deg)	(P/A)	(H/V)	
802.11ac VHT80 CH 155 5775MHz		5712.2	66.78	-1.52	68.3	53.45	35.22	12.26	34.15	100	167	P	H	
		5720.36	68.01	-10.29	78.3	54.67	35.23	12.26	34.15	100	167	P	H	
	*	5779	96.35	-	-	82.95	35.27	12.33	34.2	100	167	P	H	
	*	5779	85.61	-	-	72.21	35.27	12.33	34.2	100	167	A	H	
		5855.12	58.17	-20.13	78.3	44.71	35.32	12.45	34.31	100	167	P	H	
		5866.16	58.16	-10.14	68.3	44.7	35.32	12.49	34.35	100	167	P	H	
														H
														H
			5709.4	65.97	-2.33	68.3	52.64	35.22	12.26	34.15	100	23	P	V
			5719.88	67.27	-11.03	78.3	53.93	35.23	12.26	34.15	100	23	P	V
	*		5770	94.8	-	-	81.4	35.27	12.33	34.2	100	23	P	V
	*		5770	85.84	-	-	72.44	35.27	12.33	34.2	100	23	A	V
			5850	57.79	-20.51	78.3	44.34	35.31	12.45	34.31	100	23	P	V
			5867.04	57.05	-11.25	68.3	43.59	35.32	12.49	34.35	100	23	P	V
														V
													V	
Remark	1. No other spurious found. 2. All results are PASS against Peak and Average limit line.													



15E Band 4 5725~5850MHz

WIFI 802.11ac VHT80 (Harmonic @ 3m)

WIFI	Note	Frequency	Level	Over	Limit	Read	Antenna	Cable	Preamp	Ant	Table	Peak	Pol.	
Ant.				Limit	Line	Level	Factor	Loss	Factor	Pos	Pos	Avg.		
1		(MHz)	(dBμV/m)	(dB)	(dBμV/m)	(dBμV)	(dB/m)	(dB)	(dB)	(cm)	(deg)	(P/A)	(H/V)	
802.11ac VHT80 CH 155 5775MHz		11550	43.05	-30.95	74	45.04	38.27	17.46	57.72	100	0	P	H	
		17325	50.52	-23.48	74	43.53	42.15	21.43	56.59	100	0	P	H	
													H	
													H	
			11550	42.81	-31.19	74	44.8	38.27	17.46	57.72	100	0	P	V
			17328	50.45	-23.55	74	43.46	42.15	21.43	56.59	100	0	P	V
													V	
													V	
Remark	1. No other spurious found. 2. All results are PASS against Peak and Average limit line.													



**15E Emission below 1GHz
5GHz WIFI 802.11a (LF @ 3m)**

WIFI	Note	Frequency	Level	Over	Limit	Read	Antenna	Cable	Preamp	Ant	Table	Peak	Pol.	
Ant.				Limit	Line	Level	Factor	Loss	Factor	Pos	Pos	Avg.		
1		(MHz)	(dBμV/m)	(dB)	(dBμV/m)	(dBμV)	(dB/m)	(dB)	(dB)	(cm)	(deg)	(P/A)	(H/V)	
5GHz 802.11a LF		37.29	32.36	-7.64	40	46.95	14.88	1.77	31.24	100	0	P	H	
		133.95	20.28	-23.22	43.5	37.4	11.6	2.38	31.1	-	-	P	H	
		258.42	22.49	-23.51	46	36.85	13.68	2.96	31	-	-	P	H	
		371.4	21.12	-24.88	46	33.86	14.92	3.39	31.05	-	-	P	H	
		631.1	27.38	-18.62	46	33.3	20.4	4.22	30.54	-	-	P	H	
		892.2	29.59	-16.41	46	32.29	22.96	4.66	30.32	-	-	P	H	
														H
														H
														H
														H
														H
														H
			46.74	30.65	-9.35	40	50.28	9.8	1.77	31.2	100	0	P	V
			131.25	20.21	-23.29	43.5	37.03	11.9	2.38	31.1	-	-	P	V
			242.76	20.13	-25.87	46	36.57	11.6	2.96	31	-	-	P	V
			388.9	22.07	-23.93	46	34.05	15.46	3.52	30.96	-	-	P	V
			656.3	27.96	-18.04	46	33.9	20.33	4.22	30.49	-	-	P	V
			975.5	33.24	-20.76	54	33.68	24.92	4.94	30.3	-	-	P	V
														V
														V
													V	
													V	
													V	
													V	
Remark	1. No other spurious found. 2. All results are PASS against limit line.													



Note symbol

*	Fundamental Frequency which can be ignored. However, the level of any unwanted emissions shall not exceed the level of the fundamental frequency per 15.209(c).
!	Test result is over limit line.
P/A	Peak or Average
H/V	Horizontal or Vertical



A calculation example for radiated spurious emission is shown as below:

WIFI	Note	Frequency	Level	Over	Limit	Read	Antenna	Cable	Preamp	Ant	Table	Peak	Pol.
Ant.				Limit	Line	Level	Factor	Loss	Factor	Pos	Pos	Avg.	
1+2		(MHz)	(dBμV/m)	(dB)	(dBμV/m)	(dBμV)	(dB/m)	(dB)	(dB)	(cm)	(deg)	(P/A)	(H/V)
802.11b		2390	55.45	-18.55	74	54.51	32.22	4.58	35.86	103	308	P	H
CH 01													
2412MHz		2390	43.54	-10.46	54	42.6	32.22	4.58	35.86	103	308	A	H

- Level(dBμV/m) =
Antenna Factor(dB/m) + Cable Loss(dB) + Read Level(dBμV) - Preamp Factor(dB)
- Over Limit(dB) = Level(dBμV/m) – Limit Line(dBμV/m)

For Peak Limit @ 2390MHz:

- Level(dBμV/m)
= Antenna Factor(dB/m) + Cable Loss(dB) + Read Level(dBμV) - Preamp Factor(dB)
= 32.22(dB/m) + 4.58(dB) + 54.51(dBμV) – 35.86 (dB)
= 55.45 (dBμV/m)
- Over Limit(dB)
= Level(dBμV/m) – Limit Line(dBμV/m)
= 55.45(dBμV/m) – 74(dBμV/m)
= -18.55(dB)

For Average Limit @ 2390MHz:

- Level(dBμV/m)
= Antenna Factor(dB/m) + Cable Loss(dB) + Read Level(dBμV) - Preamp Factor(dB)
= 32.22(dB/m) + 4.58(dB) + 42.6(dBμV) – 35.86 (dB)
= 43.54 (dBμV/m)
- Over Limit(dB)
= Level(dBμV/m) – Limit Line(dBμV/m)
= 43.54(dBμV/m) – 54(dBμV/m)
= -10.46(dB)

Both peak and average measured complies with the limit line, so test result is “PASS”.



Appendix C. Radiated Spurious Emission

Test Engineer :	Wei Chen, Ken Wu and James Chiu	Temperature :	21~23°C
		Relative Humidity :	60~63%

Band 4 - 5725~5850MHz
WIFI 802.11a (Band Edge @ 3m)

WIFI	Band 4 5725~5850MHz Band Edge @ 3m	
ANT	802.11a CH149 5745MHz	
1	Horizontal	Vertical
Peak	<p>Site : 03CH07-HY Condition : FCC CLASS-B_BAND 4 3m HF-ANT_130829 HORIZONTAL RBW:1000.000kHz VBW:3000.000kHz SWT:Auto Detector : Peak</p>	<p>Site : 03CH07-HY Condition : FCC CLASS-B_BAND 4 3m HF-ANT_130829 VERTICAL RBW:1000.000kHz VBW:3000.000kHz SWT:Auto Detector : Peak</p>
Avg.	<p>Site : 03CH07-HY Condition : FCC CLASS-B (AVG) 3m HF-ANT_130829 HORIZONTAL RBW:1000.000kHz VBW:0.010kHz SWT:Auto Detector : Peak</p>	<p>Site : 03CH07-HY Condition : FCC CLASS-B (AVG) 3m HF-ANT_130829 VERTICAL RBW:1000.000kHz VBW:0.010kHz SWT:Auto Detector : Peak</p>

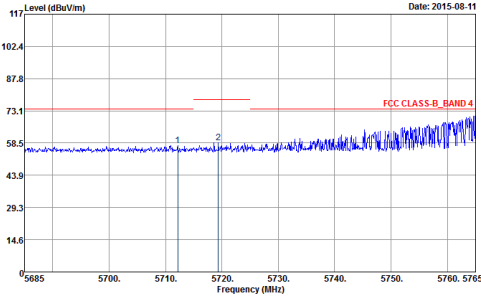
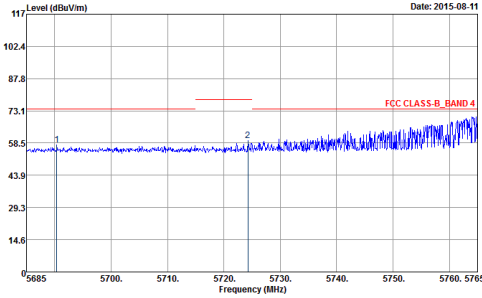
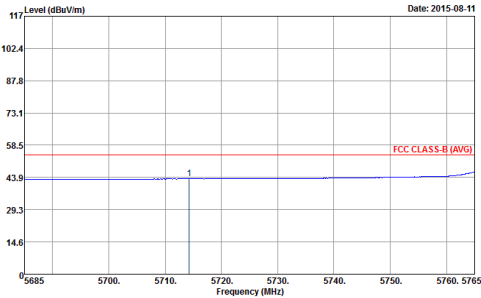
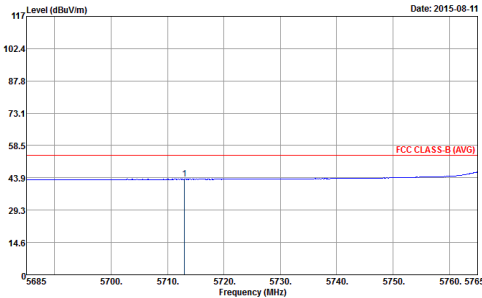

WIFI	Band 4 5725~5850MHz Band Edge @ 3m	
ANT	802.11a CH157 5785MHz – Low channel location	
1	Horizontal	Vertical
Peak	 <p>Site : 03CH07-HY Condition : FCC CLASS-B BAND 4 3m HF-ANT_130829 HORIZONTAL Detector : Peak</p>	 <p>Site : 03CH07-HY Condition : FCC CLASS-B BAND 4 3m HF-ANT_130829 VERTICAL Detector : Peak</p>
Avg.	 <p>Site : 03CH07-HY Condition : FCC CLASS-B (AVG) 3m HF-ANT_130829 HORIZONTAL Detector : Peak</p>	 <p>Site : 03CH07-HY Condition : FCC CLASS-B (AVG) 3m HF-ANT_130829 VERTICAL Detector : Peak</p>

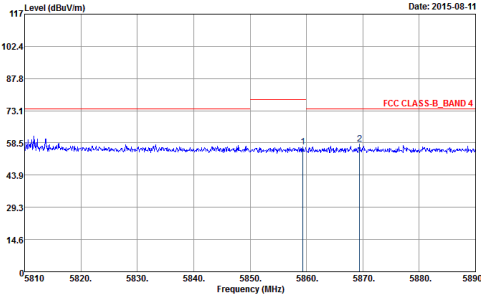
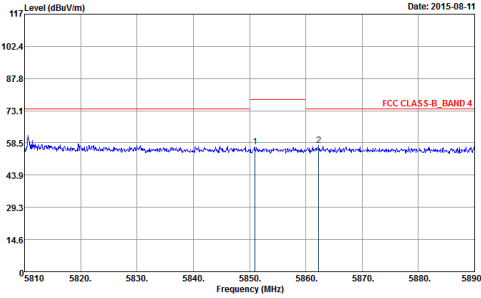
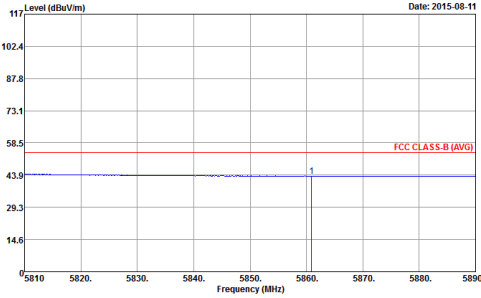
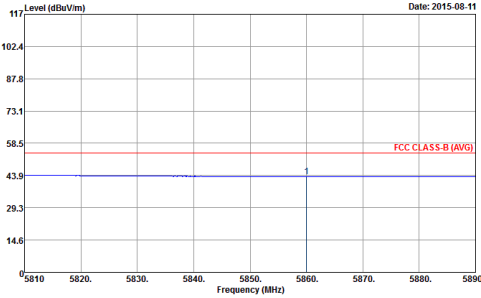

WIFI	Band 4 5725~5850MHz Band Edge @ 3m	
ANT	802.11a CH157 5785MHz – High channel location	
1	Horizontal	Vertical
Peak	 <p>Level (dBuV/m) vs Frequency (MHz) plot for Horizontal orientation. The y-axis ranges from 14.6 to 117 dBuV/m, and the x-axis ranges from 5810 to 5890 MHz. A red horizontal line indicates the FCC CLASS-B_BAND 4 limit at approximately 73.1 dBuV/m. The plot shows a noisy signal with two peaks labeled '1' and '2' at approximately 5860 MHz and 5870 MHz respectively, both exceeding the limit.</p> <p>Site : 03CH07-HY Condition : FCC CLASS-B_BAND 4 3m HF-ANT_130829 HORIZONTAL REW:1000.000kHz VBW:3000.000kHz SWT:Auto Detector : Peak</p>	 <p>Level (dBuV/m) vs Frequency (MHz) plot for Vertical orientation. The y-axis ranges from 14.6 to 117 dBuV/m, and the x-axis ranges from 5810 to 5890 MHz. A red horizontal line indicates the FCC CLASS-B_BAND 4 limit at approximately 73.1 dBuV/m. The plot shows a noisy signal with two peaks labeled '1' and '2' at approximately 5860 MHz and 5870 MHz respectively, both exceeding the limit.</p> <p>Site : 03CH07-HY Condition : FCC CLASS-B_BAND 4 3m HF-ANT_130829 VERTICAL REW:1000.000kHz VBW:3000.000kHz SWT:Auto Detector : Peak</p>
Avg.	 <p>Level (dBuV/m) vs Frequency (MHz) plot for Horizontal orientation. The y-axis ranges from 14.6 to 117 dBuV/m, and the x-axis ranges from 5810 to 5890 MHz. A red horizontal line indicates the FCC CLASS-B (AVG) limit at approximately 58.5 dBuV/m. The plot shows a noisy signal with one peak labeled '1' at approximately 5860 MHz, which exceeds the limit.</p> <p>Site : 03CH07-HY Condition : FCC CLASS-B (AVG) 3m HF-ANT_130829 HORIZONTAL REW:1000.000kHz VBW:0.010kHz SWT:Auto Detector : Peak</p>	 <p>Level (dBuV/m) vs Frequency (MHz) plot for Vertical orientation. The y-axis ranges from 14.6 to 117 dBuV/m, and the x-axis ranges from 5810 to 5890 MHz. A red horizontal line indicates the FCC CLASS-B (AVG) limit at approximately 58.5 dBuV/m. The plot shows a noisy signal with one peak labeled '1' at approximately 5860 MHz, which exceeds the limit.</p> <p>Site : 03CH07-HY Condition : FCC CLASS-B (AVG) 3m HF-ANT_130829 VERTICAL REW:1000.000kHz VBW:0.010kHz SWT:Auto Detector : Peak</p>



WIFI	Band 4 5725~5850MHz Band Edge @ 3m	
ANT	802.11a CH165 5825MHz	
1	Horizontal	Vertical
Peak	<p>Site : 03CH07-HY Condition : FCC CLASS-B BAND 4 3m HF-ANT_130829 HORIZONTAL Detector : Peak</p>	<p>Site : 03CH07-HY Condition : FCC CLASS-B BAND 4 3m HF-ANT_130829 VERTICAL Detector : Peak</p>
Avg.	<p>Site : 03CH07-HY Condition : FCC CLASS-B (AVG) 3m HF-ANT_130829 HORIZONTAL Detector : Peak</p>	<p>Site : 03CH07-HY Condition : FCC CLASS-B (AVG) 3m HF-ANT_130829 VERTICAL Detector : Peak</p>



Band 4 5725~5850MHz
WIFI 802.11n HT20 (Band Edge @ 3m)

WIFI	Band 4 5725~5850MHz Band Edge @ 3m	
ANT	802.11n HT20 CH149 5745MHz	
1	Horizontal	Vertical
Peak	<p>Site : 03CH07-HY Condition : FCC CLASS-B_BAND 4 3m HF-ANT_130829 HORIZONTAL RBW:1000.000kHz VBW:3000.000kHz SWT:Auto Detector : Peak</p>	<p>Site : 03CH07-HY Condition : FCC CLASS-B_BAND 4 3m HF-ANT_130829 VERTICAL RBW:1000.000kHz VBW:3000.000kHz SWT:Auto Detector : Peak</p>
Avg.	<p>Site : 03CH07-HY Condition : FCC CLASS-B (AVG) 3m HF-ANT_130829 HORIZONTAL RBW:1000.000kHz VBW:0.010kHz SWT:Auto Detector : Peak</p>	<p>Site : 03CH07-HY Condition : FCC CLASS-B (AVG) 3m HF-ANT_130829 VERTICAL RBW:1000.000kHz VBW:0.010kHz SWT:Auto Detector : Peak</p>

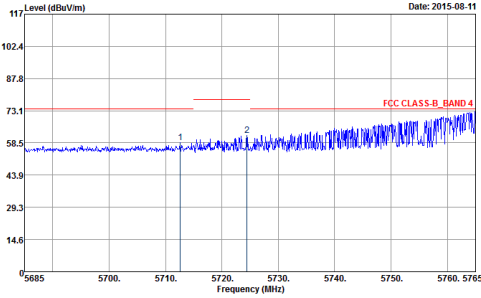
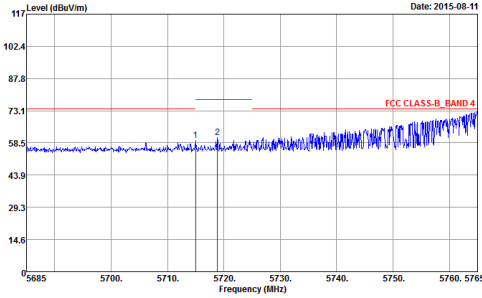
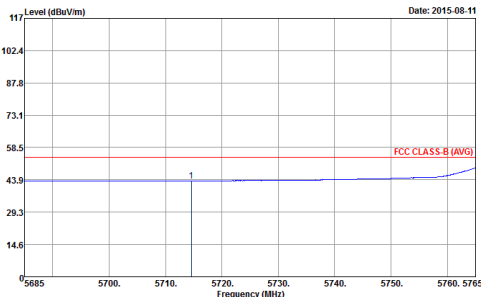
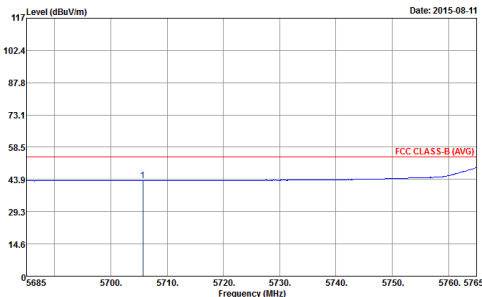

WIFI	Band 4 5725~5850MHz Band Edge @ 3m	
ANT	802.11n HT20 CH157 5785MHz – Low channel location	
1	Horizontal	Vertical
Peak	 <p>Site : 03CH07-HY Condition : FCC CLASS-B BAND 4 3m HF-ANT_130829 HORIZONTAL REW:1000.000kHz VBW:3000.000kHz SWT:Auto Detector : Peak</p>	 <p>Site : 03CH07-HY Condition : FCC CLASS-B BAND 4 3m HF-ANT_130829 VERTICAL REW:1000.000kHz VBW:3000.000kHz SWT:Auto Detector : Peak</p>
Avg.	 <p>Site : 03CH07-HY Condition : FCC CLASS-B (AVG) 3m HF-ANT_130829 HORIZONTAL REW:1000.000kHz VBW:0.010kHz SWT:Auto Detector : Peak</p>	 <p>Site : 03CH07-HY Condition : FCC CLASS-B (AVG) 3m HF-ANT_130829 VERTICAL REW:1000.000kHz VBW:0.010kHz SWT:Auto Detector : Peak</p>

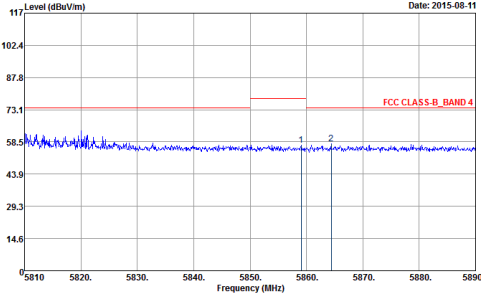
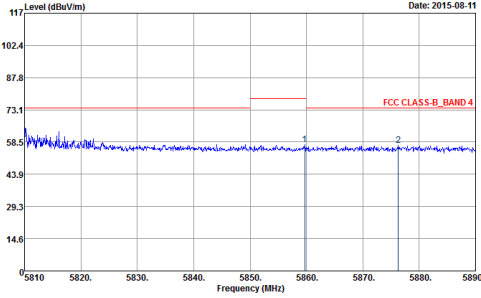
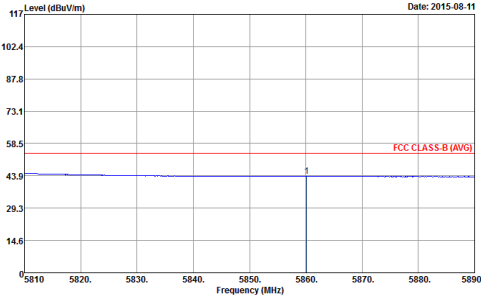
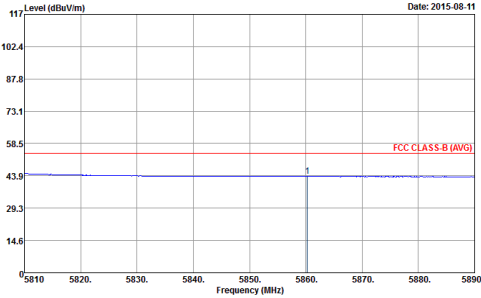

WIFI	Band 4 5725~5850MHz Band Edge @ 3m	
ANT	802.11n HT20 CH157 5785MHz – High channel location	
1	Horizontal	Vertical
Peak	 <p>Site : 03CH07-HY Condition : FCC CLASS-B BAND 4 3m HF-ANT_130829 HORIZONTAL REW:1000.000kHz VBW:3000.000kHz SWT:Auto Detector : Peak</p>	 <p>Site : 03CH07-HY Condition : FCC CLASS-B BAND 4 3m HF-ANT_130829 VERTICAL REW:1000.000kHz VBW:3000.000kHz SWT:Auto Detector : Peak</p>
Avg.	 <p>Site : 03CH07-HY Condition : FCC CLASS-B (AVG) 3m HF-ANT_130829 HORIZONTAL REW:1000.000kHz VBW:0.010kHz SWT:Auto Detector : Peak</p>	 <p>Site : 03CH07-HY Condition : FCC CLASS-B (AVG) 3m HF-ANT_130829 VERTICAL REW:1000.000kHz VBW:0.010kHz SWT:Auto Detector : Peak</p>

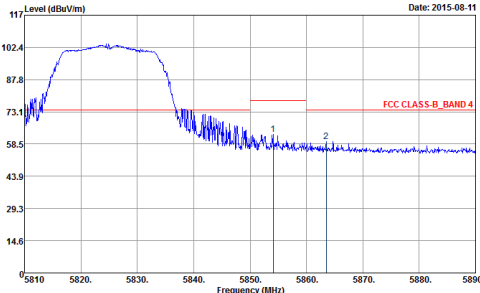
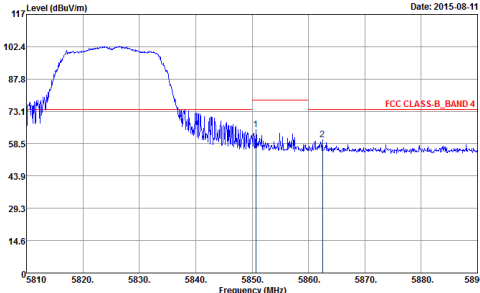
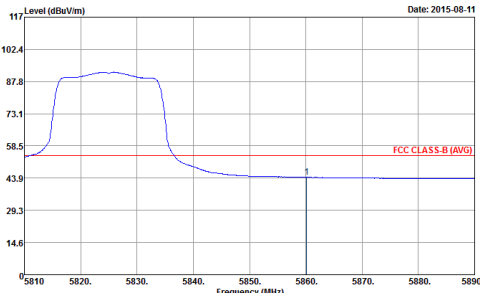
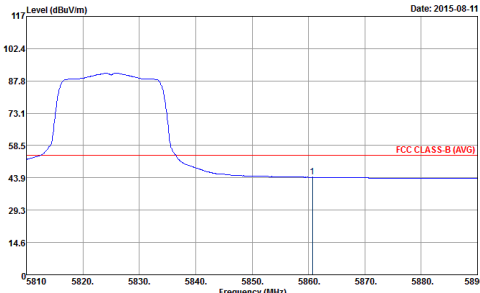

WIFI	Band 4 5725~5850MHz Band Edge @ 3m	
ANT	802.11n HT20 CH165 5825MHz	
1	Horizontal	Vertical
Peak	 <p>Site : 03CH07-HY Condition : FCC CLASS-B_BAND 4 3m HF-ANT_130829 HORIZONTAL RBW:1000.000kHz VBW:3000.000kHz SWT:Auto Detector : Peak</p>	 <p>Site : 03CH07-HY Condition : FCC CLASS-B_BAND 4 3m HF-ANT_130829 VERTICAL RBW:1000.000kHz VBW:3000.000kHz SWT:Auto Detector : Peak</p>
Avg.	 <p>Site : 03CH07-HY Condition : FCC CLASS-B (AVG) 3m HF-ANT_130829 HORIZONTAL RBW:1000.000kHz VBW:0.010kHz SWT:Auto Detector : Peak</p>	 <p>Site : 03CH07-HY Condition : FCC CLASS-B (AVG) 3m HF-ANT_130829 VERTICAL RBW:1000.000kHz VBW:0.010kHz SWT:Auto Detector : Peak</p>



Band 4 5725~5850MHz
WIFI 802.11n HT40 (Band Edge @ 3m)

WIFI	Band 4 5725~5850MHz Band Edge @ 3m	
ANT	802.11n HT40 CH151 5755MHz – Low channel location	
1	Horizontal	Vertical
Peak	<p>Site : 03CH07-HY Condition : FCC CLASS-B_BAND 4 3m HF-ANT_130829 HORIZONTAL RBW:1000.000kHz VBW:3000.000kHz SWT:Auto Detector : Peak</p>	<p>Site : 03CH07-HY Condition : FCC CLASS-B_BAND 4 3m HF-ANT_130829 VERTICAL RBW:1000.000kHz VBW:3000.000kHz SWT:Auto Detector : Peak</p>
Avg.	<p>Site : 03CH07-HY Condition : FCC CLASS-B (AVG) 3m HF-ANT_130829 HORIZONTAL RBW:1000.000kHz VBW:1.000kHz SWT:Auto Detector : Peak</p>	<p>Site : 03CH07-HY Condition : FCC CLASS-B (AVG) 3m HF-ANT_130829 VERTICAL RBW:1000.000kHz VBW:1.000kHz SWT:Auto Detector : Peak</p>

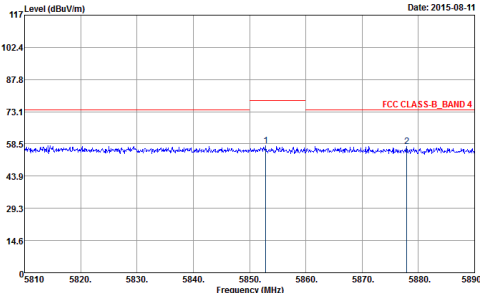
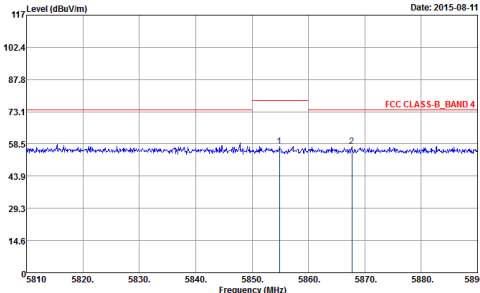
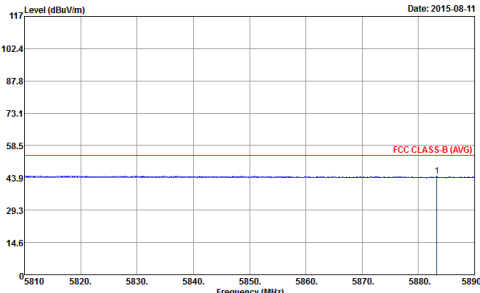
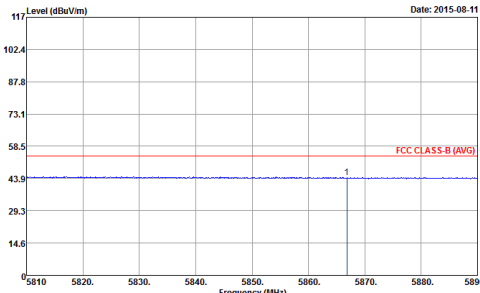

WIFI	Band 4 5725~5850MHz Band Edge @ 3m	
ANT	802.11n HT40 CH151 5755MHz – High channel location	
1	Horizontal	Vertical
Peak	 <p>Site : 03CH07-HY Condition : FCC CLASS-B BAND 4 3m HF-ANT_130829 HORIZONTAL Detector : Peak</p>	 <p>Site : 03CH07-HY Condition : FCC CLASS-B BAND 4 3m HF-ANT_130829 VERTICAL Detector : Peak</p>
Avg.	 <p>Site : 03CH07-HY Condition : FCC CLASS-B (AVG) 3m HF-ANT_130829 HORIZONTAL Detector : Peak</p>	 <p>Site : 03CH07-HY Condition : FCC CLASS-B (AVG) 3m HF-ANT_130829 VERTICAL Detector : Peak</p>



WIFI	Band 4 5725~5850MHz Band Edge @ 3m	
ANT	802.11n HT40 CH159 5795MHz – Low channel location	
1	Horizontal	Vertical
Peak	<p>Site : 03CH07-HY Condition : FCC CLASS-B_BAND 4 3m HF-ANT_130829 HORIZONTAL RBW:1000.000KHz VBW:3000.000KHz SWT:Auto Detector : Peak</p>	<p>Site : 03CH07-HY Condition : FCC CLASS-B_BAND 4 3m HF-ANT_130829 VERTICAL RBW:1000.000KHz VBW:3000.000KHz SWT:Auto Detector : Peak</p>
Avg.	<p>Site : 03CH07-HY Condition : FCC CLASS-B (AVG) 3m HF-ANT_130829 HORIZONTAL RBW:1000.000KHz VBW:1.000KHz SWT:Auto Detector : Peak</p>	<p>Site : 03CH07-HY Condition : FCC CLASS-B (AVG) 3m HF-ANT_130829 VERTICAL RBW:1000.000KHz VBW:1.000KHz SWT:Auto Detector : Peak</p>

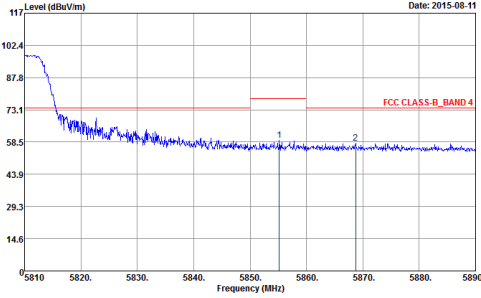
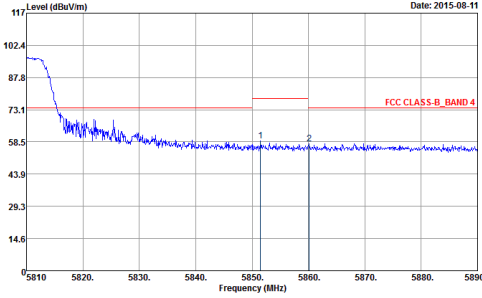
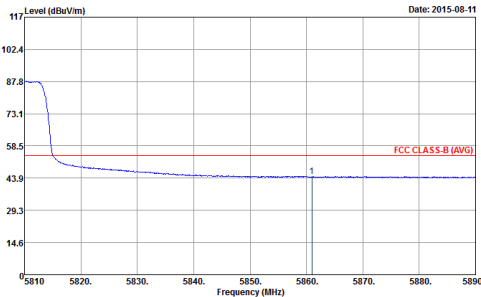
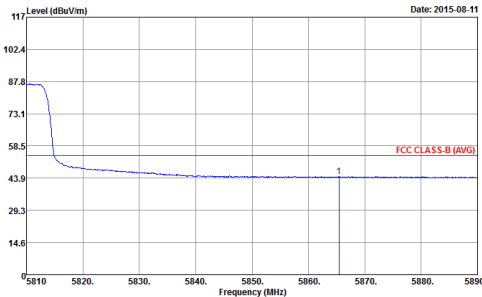

WIFI	Band 4 5725~5850MHz Band Edge @ 3m	
ANT	802.11n HT40 CH159 5795MHz – High channel location	
1	Horizontal	Vertical
Peak	 <p>Site : 03CH07-HY Condition : FCC CLASS-B BAND 4 3m HF-ANT_130829 HORIZONTAL REW:1000.000kHz VBW:3000.000kHz SWT:Auto Detector : Peak</p>	 <p>Site : 03CH07-HY Condition : FCC CLASS-B BAND 4 3m HF-ANT_130829 VERTICAL REW:1000.000kHz VBW:3000.000kHz SWT:Auto Detector : Peak</p>
Avg.	 <p>Site : 03CH07-HY Condition : FCC CLASS-B (AVG) 3m HF-ANT_130829 HORIZONTAL REW:1000.000kHz VBW:1.000kHz SWT:Auto Detector : Peak</p>	 <p>Site : 03CH07-HY Condition : FCC CLASS-B (AVG) 3m HF-ANT_130829 VERTICAL REW:1000.000kHz VBW:1.000kHz SWT:Auto Detector : Peak</p>



Band 4 5725~5850MHz

WIFI 802.11ac VHT80 (Band Edge @ 3m)

WIFI	Band 4 5725~5850MHz Band Edge @ 3m	
ANT	802.11ac VHT80 CH155 5775MHz – Low channel location	
1	Horizontal	Vertical
Peak	<p>Site : 03CH07-HY Condition : FCC PART 15E_BAND4 3m HF-ANT_130829 HORIZONTAL RBW:1000.000KHz VBW:3000.000KHz SWT:Auto Detector : Peak : RBW (6dB)</p>	<p>Site : 03CH07-HY Condition : FCC PART 15E_BAND4 3m HF-ANT_130829 VERTICAL RBW:1000.000KHz VBW:3000.000KHz SWT:Auto Detector : Peak : RBW (6dB)</p>

WIFI	Band 4 5725~5850MHz Band Edge @ 3m	
ANT	802.11ac VHT80 CH155 5775MHz – High channel location	
1	Horizontal	Vertical
Peak	<p>Site : 03CH07-HY Condition : FCC PART 15E_BAND4 3m HF-ANT_130829 HORIZONTAL RBW:1000.000KHz VBW:3000.000KHz SWT:Auto Detector : Peak : RBW (6dB)</p>	<p>Site : 03CH07-HY Condition : FCC PART 15E_BAND4 3m HF-ANT_130829 VERTICAL RBW:1000.000KHz VBW:3000.000KHz SWT:Auto Detector : Peak : RBW (6dB)</p>



Band 4 - 5725~5850MHz
WIFI 802.11a (Harmonic @ 3m)

WIFI	Band 4 5725~5850MHz Harmonic @ 3m	
ANT	802.11a CH149 5745MHz	
1	Horizontal	Vertical
Peak Avg.	<p>Site : 03CH07-HY Condition : FCC CLASS-B_BAND 4 3m SHF-EHF_131029 HORIZONTAL Detector : Peak</p>	<p>Site : 03CH07-HY Condition : FCC CLASS-B_BAND 4 3m SHF-EHF_131029 VERTICAL Detector : Peak</p>

WIFI	Band 4 5725~5850MHz Harmonic @ 3m	
ANT	802.11a CH157 5785MHz	
1	Horizontal	Vertical
Peak Avg.	<p>Site : 03CH07-HY Condition : FCC CLASS-B_BAND 4 3m SHF-EHF_131029 HORIZONTAL Detector : Peak</p>	<p>Site : 03CH07-HY Condition : FCC CLASS-B_BAND 4 3m SHF-EHF_131029 VERTICAL Detector : Peak</p>



WIFI	Band 4 5725-5850MHz Harmonic @ 3m	
ANT	802.11a CH165 5825MHz	
1	Horizontal	Vertical
Peak Avg.	<p style="font-size: small;">Date: 2015-08-12</p> <p style="font-size: x-small;">Site : 03CH07-HY Condition : FCC CLASS-B_BAND 4 3m SHF-EHF_131029 HORIZONTAL Detector : Peak</p>	<p style="font-size: small;">Date: 2015-08-12</p> <p style="font-size: x-small;">Site : 03CH07-HY Condition : FCC CLASS-B_BAND 4 3m SHF-EHF_131029 VERTICAL Detector : Peak</p>



Band 4 5725~5850MHz
WIFI 802.11n HT20 (Harmonic @ 3m)

WIFI	Band 4 5725~5850MHz Harmonic @ 3m	
ANT	802.11n HT20 CH149 5745MHz	
1	Horizontal	Vertical
Peak Avg.	<p>Site : 03CH07-HY Condition : FCC CLASS-B_BAND 4 3m SHF-EHF_131029 HORIZONTAL Detector : Peak</p>	<p>Site : 03CH07-HY Condition : FCC CLASS-B_BAND 4 3m SHF-EHF_131029 VERTICAL Detector : Peak</p>

WIFI	Band 4 5725~5850MHz Harmonic @ 3m	
ANT	802.11n HT20 CH157 5785MHz	
1	Horizontal	Vertical
Peak Avg.	<p>Site : 03CH07-HY Condition : FCC CLASS-B_BAND 4 3m SHF-EHF_131029 HORIZONTAL Detector : Peak</p>	<p>Site : 03CH07-HY Condition : FCC CLASS-B_BAND 4 3m SHF-EHF_131029 VERTICAL Detector : Peak</p>



WIFI	Band 4 5725~5850MHz Harmonic @ 3m	
ANT	802.11n HT20 CH165 5825MHz	
1	Horizontal	Vertical
Peak Avg.	<p style="font-size: small;">Date: 2015-08-12</p> <p style="font-size: x-small;">Site : 03CH07-HY Condition : FCC CLASS-B_BAND 4 3m SHF-EHF_131029 HORIZONTAL Detector : Peak</p>	<p style="font-size: small;">Date: 2015-08-12</p> <p style="font-size: x-small;">Site : 03CH07-HY Condition : FCC CLASS-B_BAND 4 3m SHF-EHF_131029 VERTICAL Detector : Peak</p>



Band 4 5725~5850MHz
WIFI 802.11n HT40 (Harmonic @ 3m)

WIFI	Band 4 5725~5850MHz Harmonic @ 3m	
ANT	802.11n HT40 CH151 5755MHz	
1	Horizontal	Vertical
Peak Avg.	<p>Site : 03CH07-HY Condition : FCC CLASS-B_BAND 4 3m SHF-EHF_131029 HORIZONTAL Detector : Peak</p>	<p>Site : 03CH07-HY Condition : FCC CLASS-B_BAND 4 3m SHF-EHF_131029 VERTICAL Detector : Peak</p>

WIFI	Band 4 5725~5850MHz Harmonic @ 3m	
ANT	802.11n HT40 CH159 5795MHz	
1	Horizontal	Vertical
Peak Avg.	<p>Site : 03CH07-HY Condition : FCC CLASS-B_BAND 4 3m SHF-EHF_131029 HORIZONTAL Detector : Peak</p>	<p>Site : 03CH07-HY Condition : FCC CLASS-B_BAND 4 3m SHF-EHF_131029 VERTICAL Detector : Peak</p>



Band 4 5725~5850MHz
WIFI 802.11ac VHT80 (Harmonic @ 3m)

WIFI	Band 4 5725~5850MHz Harmonic @ 3m	
ANT	802.11ac VHT80 CH155 5775MHz	
1	Horizontal	Vertical
Peak Avg.	<p>Site : 03CH07-HY Condition : FCC CLASS-B_BAND 4 3m SHF-EHF_131029 HORIZONTAL Detector : Peak</p>	<p>Site : 03CH07-HY Condition : FCC CLASS-B_BAND 4 3m SHF-EHF_131029 VERTICAL Detector : Peak</p>



Emission below 1GHz
5GHz WIFI 802.11a (LF)

WIFI	5GHz 5725~5850MHz	
ANT	802.11a LF	
1	Horizontal	Vertical
QP / Peak	<p>Site : 03CH07-HY Condition : FCC CLASS-B 3m LF-ANT(131102) HORIZONTAL Detector : Peak</p>	<p>Site : 03CH07-HY Condition : FCC CLASS-B 3m LF-ANT(131102) VERTICAL Detector : Peak</p>

Emission below 1GHz
5GHz WIFI 802.11n HT20 (LF)

WIFI	5GHz 5725~5850MHz	
ANT	802.11n HT20 LF	
1	Horizontal	Vertical
QP / Peak	<p>Site : 03CH07-HY Condition : FCC CLASS-B 3m LF-ANT(131102) HORIZONTAL Detector : Peak</p>	<p>Site : 03CH07-HY Condition : FCC CLASS-B 3m LF-ANT(131102) VERTICAL Detector : Peak</p>



Emission below 1GHz
5GHz WIFI 802.11n HT40 (LF)

WIFI	5GHz 5725~5850MHz	
ANT	802.11n HT40 LF	
1	Horizontal	Vertical
QP / Peak	<p>Site : 03CH07-HY Condition : FCC CLASS-B 3m LF-ANT(131102) HORIZONTAL Detector : Peak</p>	<p>Site : 03CH07-HY Condition : FCC CLASS-B 3m LF-ANT(131102) VERTICAL Detector : Peak</p>

Emission below 1GHz
5GHz WIFI 802.11ac VHT80 (LF)

WIFI	5GHz 5725~5850MHz	
ANT	802.11ac VHT80 LF	
1	Horizontal	Vertical
QP / Peak	<p>Site : 03CH07-HY Condition : FCC CLASS-B 3m LF-ANT(131102) HORIZONTAL Detector : Peak</p>	<p>Site : 03CH07-HY Condition : FCC CLASS-B 3m LF-ANT(131102) VERTICAL Detector : Peak</p>