



# FCC RF Test Report

**APPLICANT** : Sony Mobile Communications Inc.  
**EQUIPMENT** : GSM/WCDMA/LTE Phone + Bluetooth, DTS/UNII  
a/b/g/n/ac, ANT+, and NFC  
**BRAND NAME** : Sony  
**FCC ID** : PY7-PM0881  
**STANDARD** : FCC Part 15 Subpart C §15.247  
**CLASSIFICATION** : (DTS) Digital Transmission System

The product was received on Jul. 16, 2015 and testing was completed on Aug. 15, 2015. We, SPORTON INTERNATIONAL INC., would like to declare that the tested sample has been evaluated in accordance with the test procedures and has been in compliance with the applicable technical standards.

The test results in this report apply exclusively to the tested model / sample. Without written approval of SPORTON INTERNATIONAL INC., the test report shall not be reproduced except in full.

Reviewed by: Joseph Lin / Supervisor

Approved by: Jones Tsai / Manager



## SPORTON INTERNATIONAL INC.

No. 52, Hwa Ya 1<sup>st</sup> Rd., Hwa Ya Technology Park, Kwei-Shan District, Tao Yuan City, Taiwan, R.O.C.

SPORTON INTERNATIONAL INC.

TEL : 886-3-327-3456

FAX : 886-3-328-4978

FCC ID : PY7-PM0881

Page Number : 1 of 35

Report Issued Date : Sep. 08, 2015

Report Version : Rev. 01

Report Template No.: BU5-FR15CBT4.0 Version 1.0



# TABLE OF CONTENTS

**REVISION HISTORY..... 3**

**SUMMARY OF TEST RESULT ..... 4**

**1 GENERAL DESCRIPTION..... 5**

    1.1 Applicant ..... 5

    1.2 Manufacturer..... 5

    1.3 Product Feature of Equipment Under Test..... 5

    1.4 Modification of EUT ..... 6

    1.5 Testing Location ..... 6

    1.6 Applicable Standards..... 6

**2 TEST CONFIGURATION OF EQUIPMENT UNDER TEST..... 7**

    2.1 Descriptions of Test Mode ..... 7

    2.2 Test Mode..... 7

    2.3 Connection Diagram of Test System..... 8

    2.4 Support Unit used in test configuration and system ..... 9

    2.5 EUT Operation Test Setup ..... 9

    2.6 Measurement Results Explanation Example..... 9

**3 TEST RESULT ..... 10**

    3.1 6dB Bandwidth Measurement ..... 10

    3.2 Peak Output Power Measurement ..... 13

    3.3 Power Spectral Density Measurement ..... 14

    3.4 Conducted Band Edges and Spurious Emission Measurement ..... 19

    3.5 Radiated Band Edges and Spurious Emission Measurement ..... 24

    3.6 AC Conducted Emission Measurement..... 28

    3.7 Antenna Requirements..... 32

**4 LIST OF MEASURING EQUIPMENT..... 33**

**5 UNCERTAINTY OF EVALUATION..... 35**

**APPENDIX A. CONDUCTED TEST RESULTS**

**APPENDIX B. TEST RESULT OF RADIATED EMISSION**

**APPENDIX C. RADIATED SPURIOUS EMISSION**





### SUMMARY OF TEST RESULT

Report Section	FCC Rule	Description	Limit	Result	Remark
3.1	15.247(a)(2)	6dB Bandwidth	$\geq 0.5\text{MHz}$	Pass	-
3.2	15.247(b)(1)	Peak Output Power	$\leq 30\text{dBm}$	Pass	-
3.3	15.247(e)	Power Spectral Density	$\leq 8\text{dBm}/3\text{kHz}$	Pass	-
3.4	15.247(d)	Conducted Band Edges and Spurious Emission	$\leq 20\text{dBc}$	Pass	-
3.5	15.247(d)	Radiated Band Edges and Spurious Emission	15.209(a) & 15.247(d)	Pass	Under limit 8.06 dB at 30.540 MHz
3.6	15.207	AC Conducted Emission	15.207(a)	Pass	Under limit 19.80 dB at 0.678 MHz
3.7	15.203 & 15.247(b)	Antenna Requirement	N/A	Pass	-

**Remark:** The FR571618B report reuses test data from the FR571617B report.



# 1 General Description

## 1.1 Applicant

**Sony Mobile Communications Inc.**  
Nya Vattentorget, 22188 Lund, Sweden

## 1.2 Manufacturer

**Sony Mobile Communications Inc.**  
1-8-15 Konan, Minato-ku, Tokyo, 108-0075, Japan

## 1.3 Product Feature of Equipment Under Test

GSM/WCDMA/LTE, Bluetooth, DTS/UNII a/b/g/n/ac, ANT+, NFC, and GPS

Product Specification subjective to this standard	
Antenna Type/Gain	Monopole Antenna type with gain -2.16 dBi

EUT Information List				
IMEI	HW Version	SW Version	S/N	Performed Test Item
004402455123178	A	32.0.A.0.287	CB5A273TPX	RF conducted measurement
004402455122311			CB5A273TF4	Radiated Spurious Emission
004402455122410			CB5A273THY	Conducted Emission

Accessory List	
AC Adapter	Model No. : UCH20
	Type No. : AC-0061-US
	S/N : 2115W15500021 (for radiated spurious emission) 5815W22500112 (for conducted emission)
Earphone	Model No. : MDR-NC31E
	Type No. : AG-1110
USB Cable	Model No. : UCB11
	Type No. : AI-0120
	S/N : 1522A731000010A (for radiated spurious emission) 1512A73E0001BD0 (for conducted emission)

**Note:**

1. Above EUT list and accessory list used are electrically identical per declared by manufacturer.
2. Above the accessories list are used to exercise the EUT during test.
3. For other wireless features of this EUT, test report will be issued separately.



### 1.4 Modification of EUT

No modifications are made to the EUT during all test items.

### 1.5 Testing Location

Sporton Lab is accredited to ISO 17025 by Taiwan Accreditation Foundation (TAF code : 1190) and the FCC designation No. TW1022 under the FCC 2.948(e) by Mutual Recognition Agreement (MRA) in FCC Test.

<b>Test Site</b>	SPORTON INTERNATIONAL INC.		
<b>Test Site Location</b>	No. 52, Hwa Ya 1 <sup>st</sup> Rd., Hwa Ya Technology Park, Kwei-Shan District, Tao Yuan City, Taiwan, R.O.C. TEL: +886-3-327-3456 FAX: +886-3-328-4978		
<b>Test Site No.</b>	<b>Sporton Site No.</b>		
	TH05-HY	CO05-HY	03CH07-HY

**Note:** The test site complies with ANSI C63.4 2009 requirement.

### 1.6 Applicable Standards

According to the specifications of the manufacturer, the EUT must comply with the requirements of the following standards:

- FCC Part 15 Subpart C §15.247
- FCC KDB Publication No. 558074 D01 DTS Meas. Guidance v03r03
- ANSI C63.10-2009

**Remark:**

1. All test items were verified and recorded according to the standards and without any deviation during the test.
2. FCC permits the use of the 1.5 meter table as an alternative in C63.10-2013 through inquiry tracking number 961829.



## 2 Test Configuration of Equipment Under Test

### 2.1 Descriptions of Test Mode

The RF output power was recorded in the following table:

Channel	Frequency	Bluetooth 4.0 – LE RF Output Power	
		Data Rate / Modulation	
		GFSK	
		1Mbps	
Ch00	2402MHz	5.43 dBm	
Ch19	2440MHz	6.36 dBm	
Ch39	2480MHz	3.74 dBm	

- a. The EUT has been associated with peripherals and configuration operated in a manner tended to maximize its emission characteristics in a typical application. Frequency range investigated: conduction (150 kHz to 30 MHz), radiation (9 kHz to the 10th harmonic of the highest fundamental frequency or to 40 GHz, whichever is lower). Pre-scanned tests, X, Y, Z in three orthogonal panels to determine the final configuration (Y plane as worst plane) from all possible combinations.
- b. AC power line Conducted Emission was tested under maximum output power.

### 2.2 Test Mode

The following summary table is showing all test modes to demonstrate in compliance with the standard.

Summary table of Test Cases	
Test Item	Data Rate / Modulation
	Bluetooth 4.0 – LE / GFSK
Conducted TCs	Mode 1: Bluetooth Tx CH00_2402 MHz_1Mbps Mode 2: Bluetooth Tx CH19_2440 MHz_1Mbps Mode 3: Bluetooth Tx CH39_2480 MHz_1Mbps
Radiated TCs	Mode 1: Bluetooth Tx CH00_2402 MHz_1Mbps Mode 2: Bluetooth Tx CH19_2440 MHz_1Mbps Mode 3: Bluetooth Tx CH39_2480 MHz_1Mbps
AC Conducted Emission	Mode 1 :: Bluetooth Link + USB Cable (Charging from Adapter) + Earphone

## 2.3 Connection Diagram of Test System

### <Bluetooth 4.0 – LE Tx Mode>

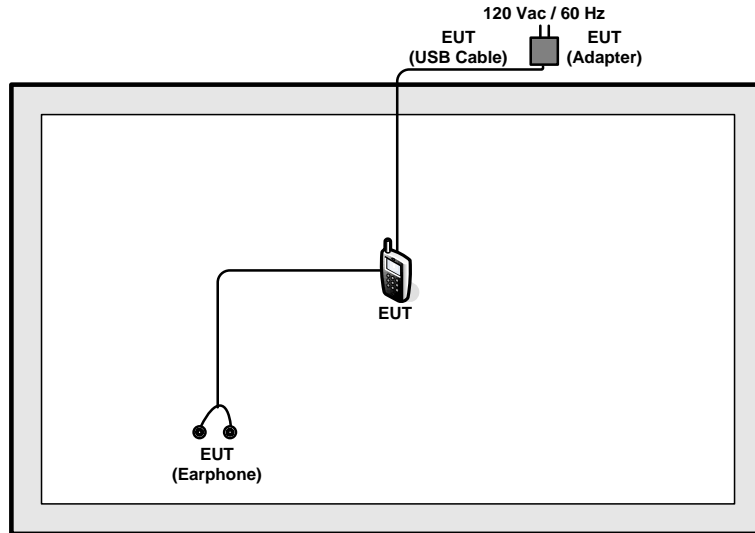

### <AC Conducted Emission Mode>

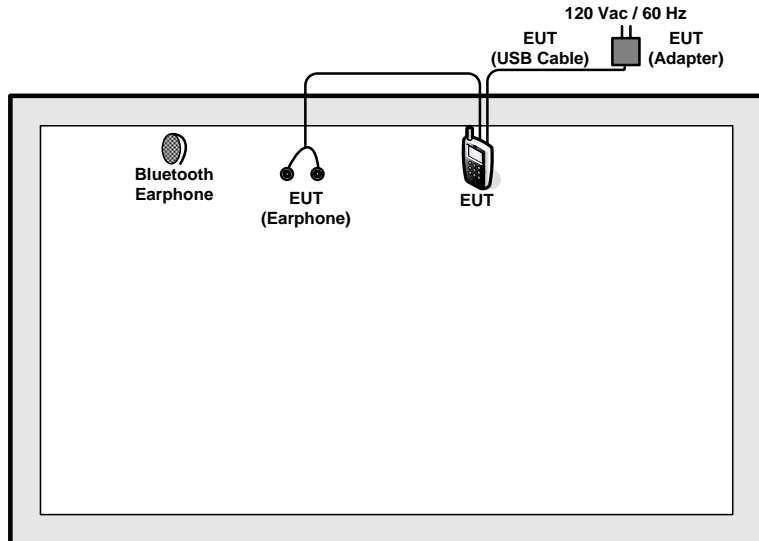





## 2.4 Support Unit used in test configuration and system

Item	Equipment	Trade Name	Model Name	FCC ID	Data Cable	Power Cord
1.	Bluetooth Earphone	Sony	SBH20	PY7-RD0010	Unshielded, 0.75m	N/A
2.	SD Card	SanDisk	MicroSD HC	FCC DoC	N/A	N/A

## 2.5 EUT Operation Test Setup

For Bluetooth function test items, an engineering test program was provided and enabled to make EUT transmitting and receiving signals.

## 2.6 Measurement Results Explanation Example

For all conducted test items:

The offset level is set in the spectrum analyzer to compensate the RF cable loss and attenuator factor between EUT conducted output port and spectrum analyzer. With the offset compensation, the spectrum analyzer reading level is exactly the EUT RF output level.

Example :

The spectrum analyzer offset is derived from RF cable loss and attenuator factor.

*Offset = RF cable loss + attenuator factor.*

Following shows an offset computation example with cable loss 4.2 dB and 10dB attenuator.

$$\begin{aligned} \text{Offset(dB)} &= \text{RF cable loss(dB)} + \text{attenuator factor(dB)}. \\ &= 4.2 + 10 = 14.2 \text{ (dB)} \end{aligned}$$

### 3 Test Result

#### 3.1 6dB Bandwidth Measurement

##### 3.1.1 Limit of 6dB Bandwidth

The minimum 6 dB bandwidth shall be at least 500 kHz.

##### 3.1.2 Measuring Instruments

The section 4.0 of List of Measuring Equipment of this test report is used for test.

##### 3.1.3 Test Procedures

1. The testing follows FCC KDB Publication No. 558074 D01 DTS Meas. Guidance v03r03.
2. The RF output of EUT was connected to the spectrum analyzer by RF cable and attenuator. The path loss was compensated to the results for each measurement.
3. Set to the maximum power setting and enable the EUT transmit continuously.
4. Make the measurement with the spectrum analyzer's resolution bandwidth (RBW) = 100 kHz. Set the Video bandwidth (VBW) = 300 kHz. In order to make an accurate measurement. The 6 dB bandwidth must be greater than 500 kHz.
5. Measure and record the results in the test report.

##### 3.1.4 Test Setup





### 3.1.5 Test Result of 6dB Bandwidth

Test data refer to Appendix A.

#### 6 dB Bandwidth Plot on Channel 00

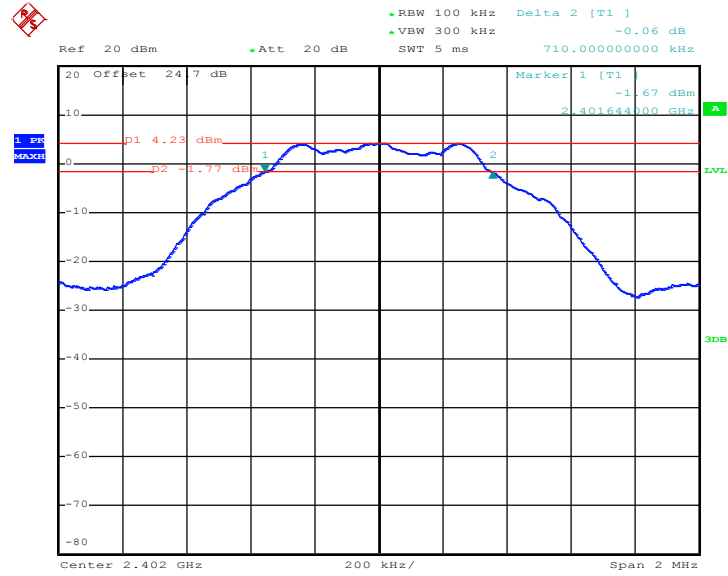

Date: 9.AUG.2015 13:21:48



### 6 dB Bandwidth Plot on Channel 19

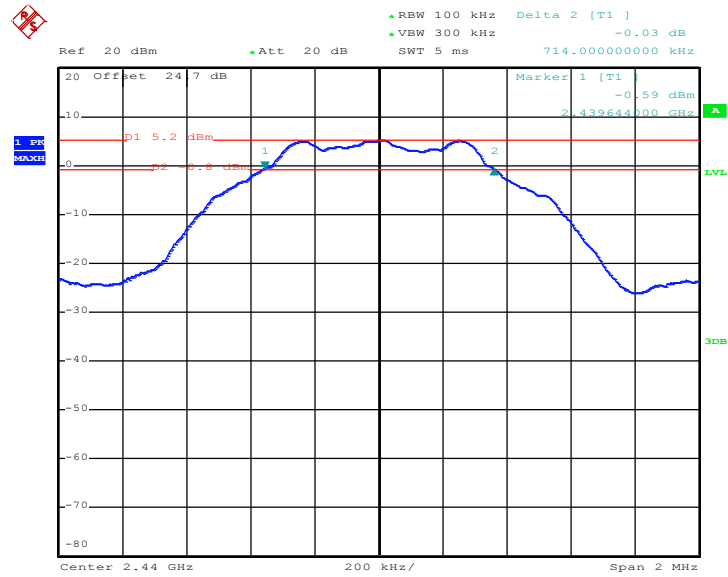

Date: 9.AUG.2015 13:28:44

### 6 dB Bandwidth Plot on Channel 39

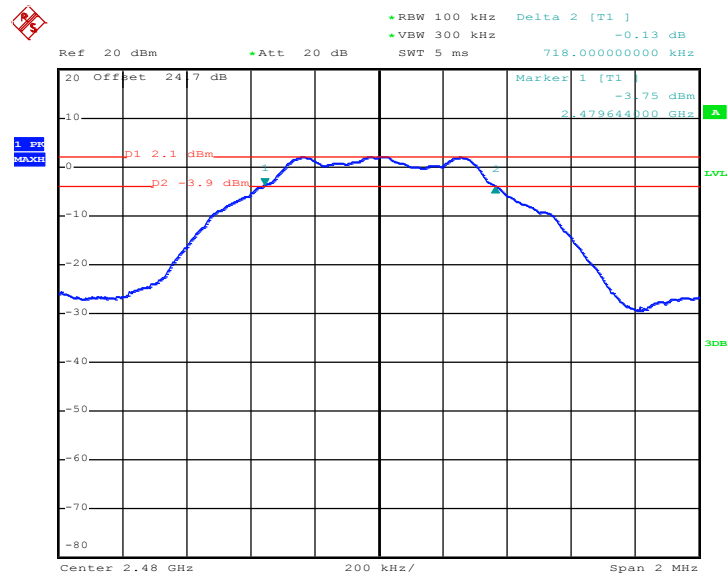

Date: 9.AUG.2015 13:33:26

## 3.2 Peak Output Power Measurement

### 3.2.1 Limit of Peak Output Power

For systems using digital modulation in the 2400-2483.5MHz, the limit for peak output power is 30dBm. If transmitting antenna of directional gain greater than 6dBi is used, the peak output power from the intentional radiator shall be reduced below the above stated value by the amount in dB that the directional gain of the antenna exceeds 6 dBi. In case of point-to-point operation, the limit has to be reduced by 1dB for every 3dB that the directional gain of the antenna exceeds 6dBi.

### 3.2.2 Measuring Instruments

The section 4.0 of List of Measuring Equipment of this test report is used for test.

### 3.2.3 Test Procedures

1. The testing follows the Measurement Procedure of FCC KDB No. 558074 DTS D01 Meas. Guidance v03r03 section 9.1.2 PKPM1 Peak power meter method.
2. The RF output of EUT was connected to the power meter by RF cable and attenuator. The path loss was compensated to the results for each measurement.
3. Set to the maximum power setting and enable the EUT transmit continuously.
4. Measure the conducted output power and record the results in the test report.

### 3.2.4 Test Setup

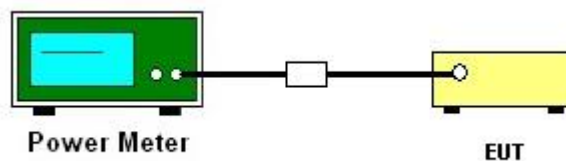

### 3.2.5 Test Result of Peak Output Power

Test data refers to Appendix A.

### 3.3 Power Spectral Density Measurement

#### 3.3.1 Limit of Power Spectral Density

The peak power spectral density shall not be greater than 8dBm in any 3kHz band at any time interval of continuous transmission.

#### 3.3.2 Measuring Instruments

The section 4.0 of List of Measuring Equipment of this test report is used for test.

#### 3.3.3 Test Procedures

1. The testing follows Measurement Procedure 10.2 Method PKPSD of FCC KDB Publication No. 558074 D01 DTS Meas. Guidance v03r03
2. The RF output of EUT was connected to the spectrum analyzer by RF cable and attenuator. The path loss was compensated to the results for each measurement.
3. Set to the maximum power setting and enable the EUT transmit continuously.
4. Make the measurement with the spectrum analyzer's resolution bandwidth (RBW) = 3 kHz. Video bandwidth VBW = 10 kHz In order to make an accurate measurement, set the span to 1.5 times DTS Channel Bandwidth. (6dB BW)
5. Detector = peak, Sweep time = auto couple, Trace mode = max hold, Allow trace to fully stabilize. Use the peak marker function to determine the maximum power level.
6. Measure and record the results in the test report.
7. The Measured power density (dBm)/ 100kHz is a reference level and used as 20dBc down limit line for Conducted Band Edges and Conducted Spurious Emission.

#### 3.3.4 Test Setup





### 3.3.5 Test Result of Power Spectral Density

Test data refers to Appendix A.

### 3.3.6 Test Result of Power Spectral Density Plots (100kHz)

PSD 100kHz Plot on Channel 00

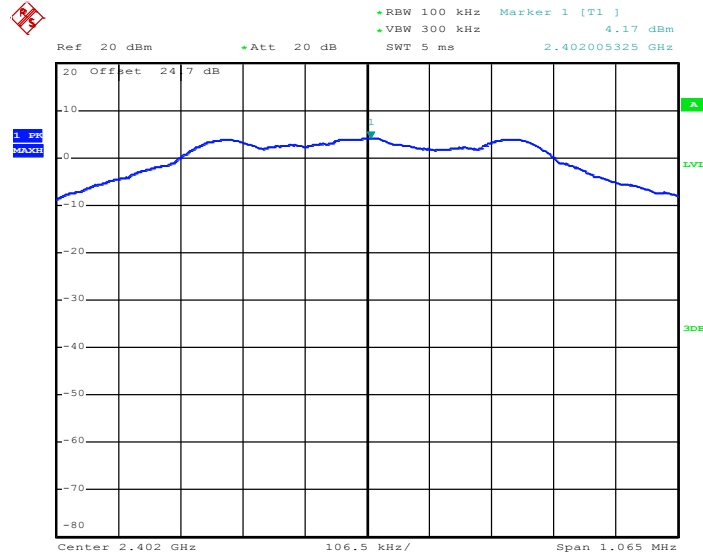

Date: 9.AUG.2015 13:23:17



PSD 100kHz Plot on Channel 19

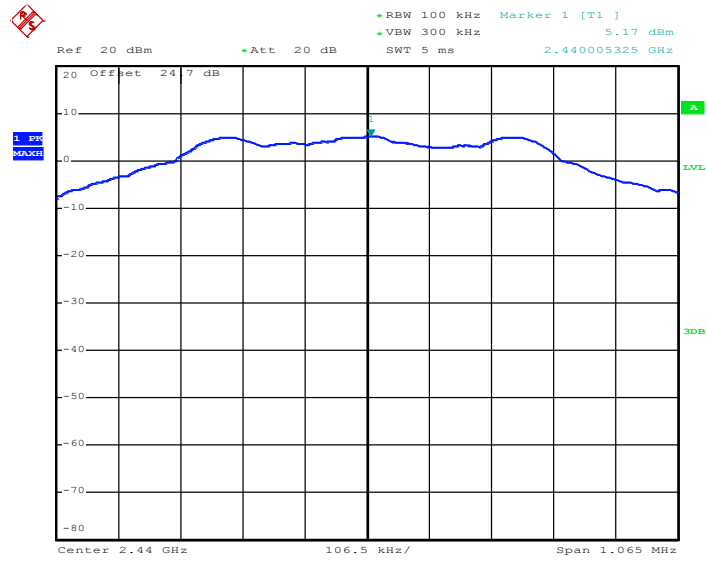

Date: 9.AUG.2015 13:29:32

PSD 100kHz Plot on Channel 39

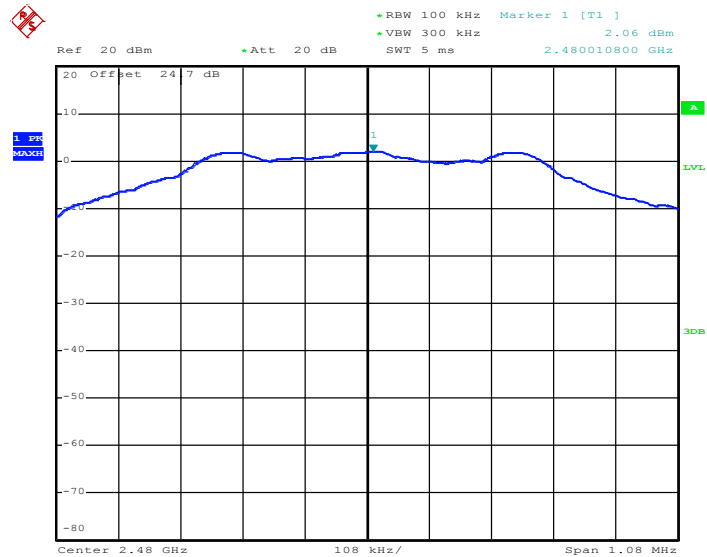

Date: 9.AUG.2015 13:34:51





### 3.3.7 Test Result of Power Spectral Density Plots (3kHz)

PSD 3kHz Plot on Channel 00

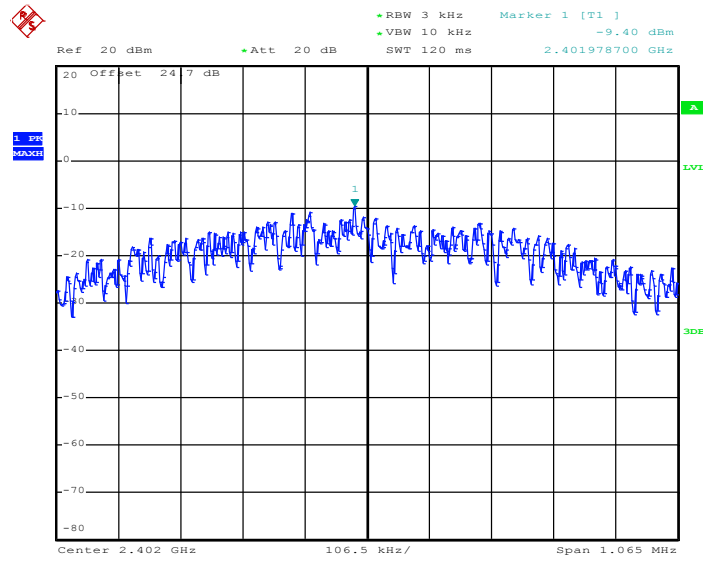

Date: 9.AUG.2015 13:22:55

PSD 3kHz Plot on Channel 19

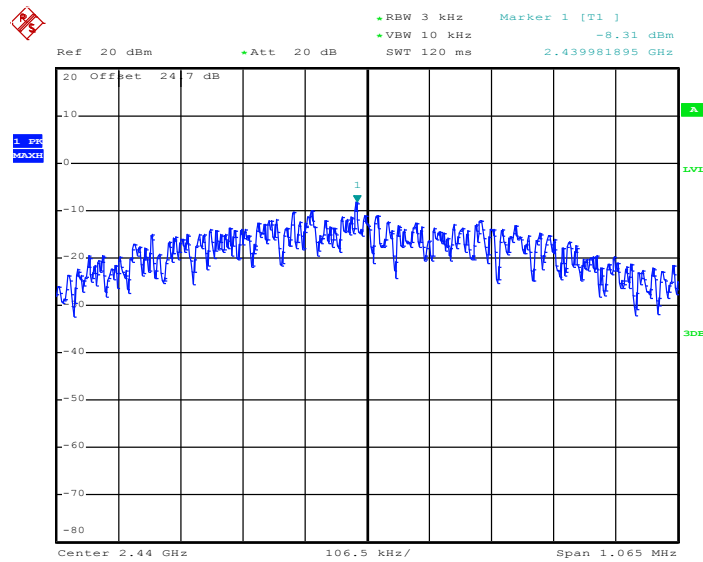

Date: 9.AUG.2015 13:29:10



PSD 3kHz Plot on Channel 39

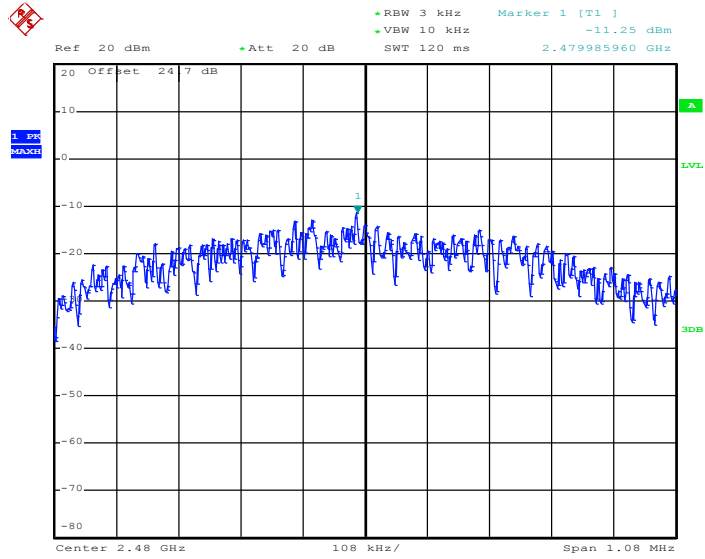

Date: 9.AUG.2015 13:34:18

## 3.4 Conducted Band Edges and Spurious Emission Measurement

### 3.4.1 Limit of Conducted Band Edges and Spurious Emission

All harmonics/spurious must be at least 20 dB down from the highest emission level within the authorized band.

### 3.4.2 Measuring Instruments

The section 4.0 of List of Measuring Equipment of this test report is used for test.

### 3.4.3 Test Procedure

1. The testing follows FCC KDB Publication No. 558074 D01 DTS Meas. Guidance v03r03.
2. The RF output of EUT was connected to the spectrum analyzer by RF cable and attenuator. The path loss was compensated to the results for each measurement.
3. Set to the maximum power setting and enable the EUT transmit continuously.
4. Set RBW = 100 kHz, VBW=300 kHz, Peak Detector. Unwanted Emissions measured in any 100 kHz bandwidth outside of the authorized frequency band shall be attenuated by at least 20 dB relative to the maximum in-band peak PSD level in 100 kHz when maximum peak conducted output power procedure is used. If the transmitter complies with the conducted power limits based on the use of RMS averaging over a time interval, the attenuation required under this paragraph shall be 30 dB instead of 20 dB per 15.247(d).
5. Measure and record the results in the test report.
6. The RF fundamental frequency should be excluded against the limit line in the operating frequency band.

### 3.4.4 Test Setup

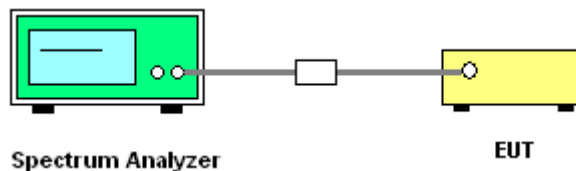



### 3.4.5 Test Result of Conducted Band Edges Plots

#### Low Band Edge Plot on Channel 00

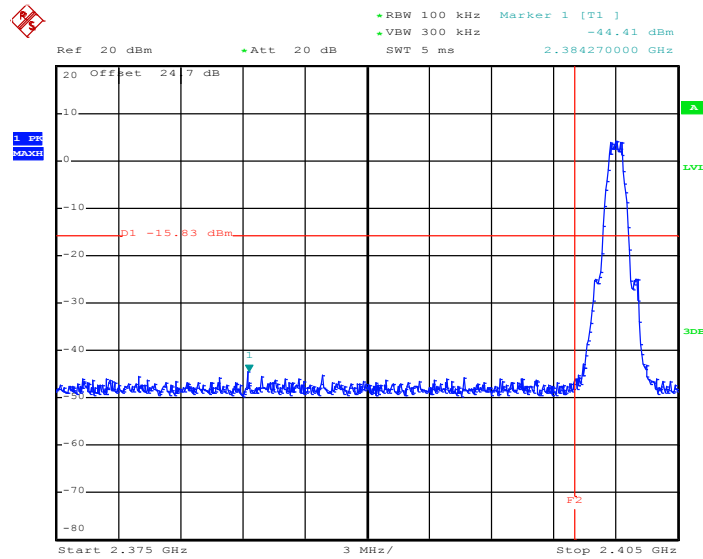

Date: 9.AUG.2015 13:24:49

#### High Band Edge Plot on Channel 39

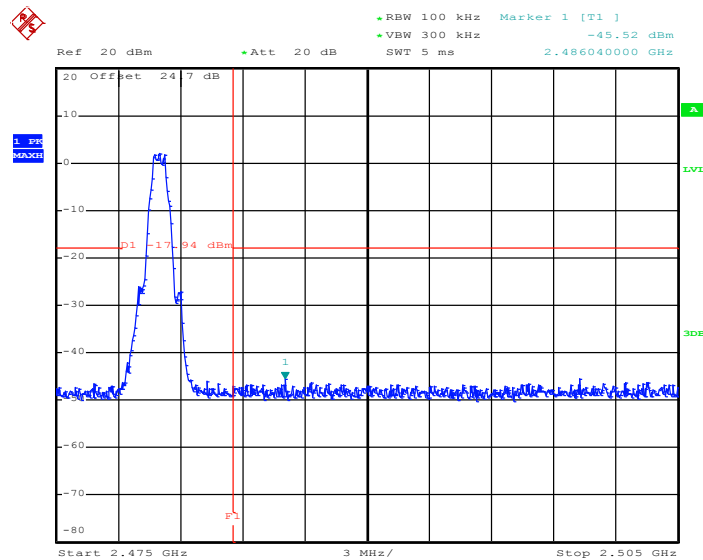

Date: 9.AUG.2015 13:35:51



### 3.4.6 Test Result of Conducted Spurious Emission Plots

#### Conducted Spurious Emission Plot on Bluetooth LE 1Mbps GFSK Channel 00

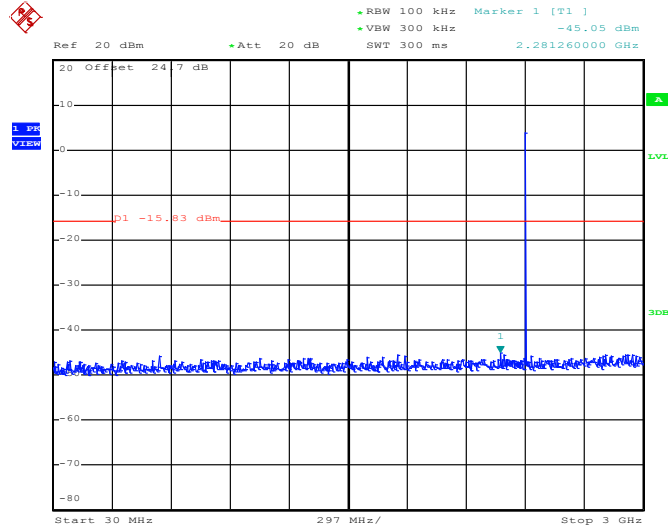

Date: 9.AUG.2015 13:25:31

#### Conducted Spurious Emission Plot on Bluetooth LE 1Mbps GFSK Channel 00

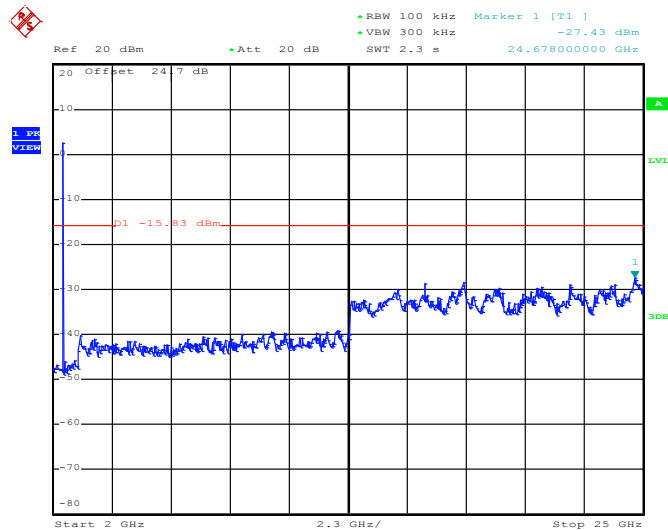

Date: 9.AUG.2015 13:25:49



### Conducted Spurious Emission Plot on Bluetooth LE 1Mbps GFSK Channel 19

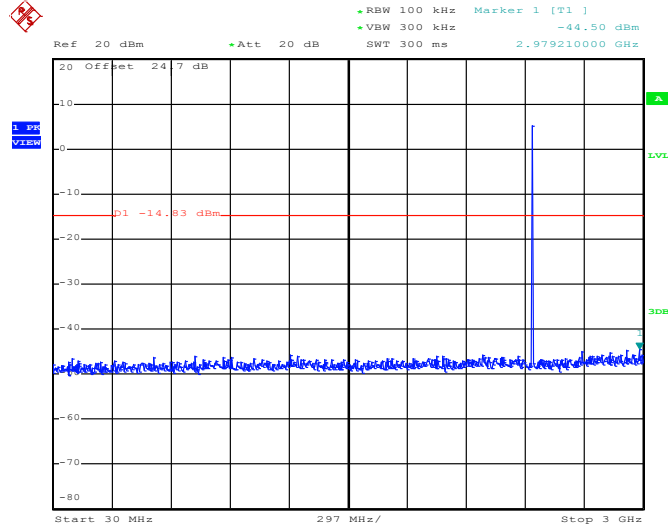

Date: 9.AUG.2015 13:30:03

### Conducted Spurious Emission Plot on Bluetooth LE 1Mbps GFSK Channel 19

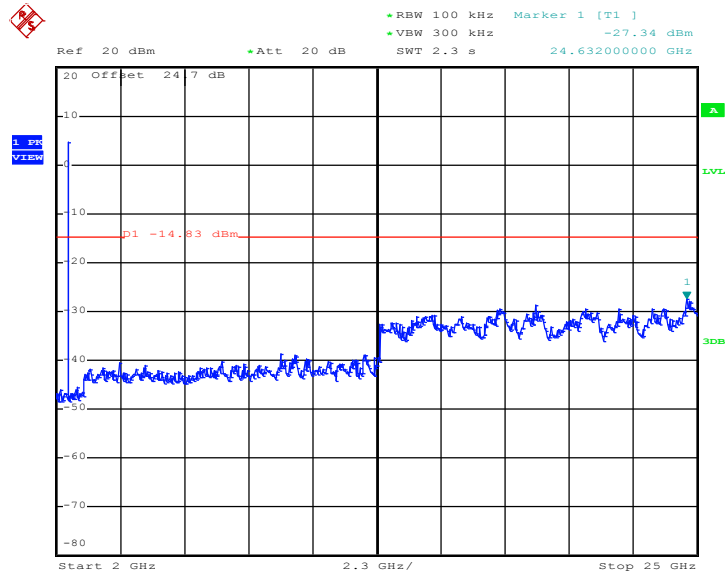

Date: 9.AUG.2015 13:30:21



Conducted Spurious Emission Plot on Bluetooth LE 1Mbps GFSK Channel 39

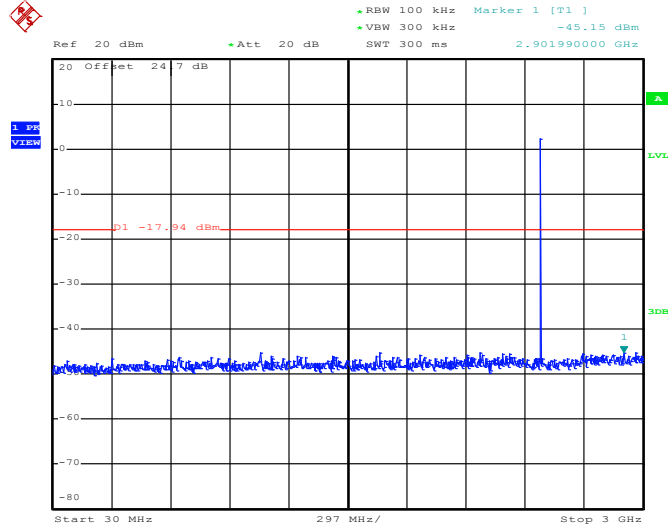

Date: 9.AUG.2015 13:36:29

Conducted Spurious Emission Plot on Bluetooth LE 1Mbps GFSK Channel 39

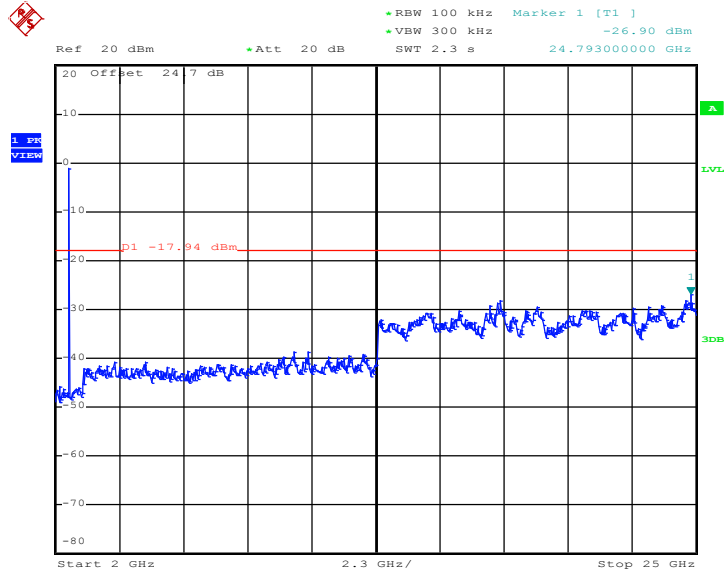

Date: 9.AUG.2015 13:36:47



### 3.5 Radiated Band Edges and Spurious Emission Measurement

#### 3.5.1 Limit of Radiated Band Edges and Spurious Emission

In any 100 kHz bandwidth outside the intentional radiator frequency band, all harmonics/spurious must be at least 20 dB below the highest emission level within the authorized band. If the output power of this device was measured by spectrum analyzer, the attenuation under this paragraph shall be 30 dB instead of 20 dB. In addition, radiated emissions which fall in the restricted bands must also comply with the FCC section 15.209 limits as below.

Frequency (MHz)	Field Strength (microvolts/meter)	Measurement Distance (meters)
0.009 – 0.490	2400/F(kHz)	300
0.490 – 1.705	24000/F(kHz)	30
1.705 – 30.0	30	30
30 – 88	100	3
88 – 216	150	3
216 - 960	200	3
Above 960	500	3

#### 3.5.2 Measuring Instruments

The section 4.0 of List of Measuring Equipment of this test report is used for test.





3.5.3 Test Procedures

1. The testing follows FCC KDB Publication No. 558074 D01 DTS Meas. Guidance v03r03.
2. The EUT was arranged to its worst case and then tune the antenna tower (from 1 m to 4 m) and turntable (from 0 degree to 360 degrees) to find the maximum reading. A pre-amp and a high pass filter are used for the test in order to get better signal level.
3. The EUT was placed on a turntable with 0.8 meter for frequency below 1GHz and 1.5 meter for frequency above 1GHz respectively above ground.
4. The EUT was set 3 meters from the interference receiving antenna, which was mounted on the top of a variable height antenna tower.
5. Corrected Reading: Antenna Factor + Cable Loss + Read Level - Preamp Factor = Level
6. For measurement below 1GHz, If the emission level of the EUT measured by the peak detector is 3 dB lower than the applicable limit, the peak emission level will be reported. Otherwise, the emission measurement will be repeated using the quasi-peak detector and reported.
7. Use the following spectrum analyzer settings:
  - (1) Span shall wide enough to fully capture the emission being measured;
  - (2) Set RBW=100 kHz for  $f < 1 \text{ GHz}$ ;  $VBW \geq RBW$ ; Sweep = auto; Detector function = peak; Trace = max hold;
  - (3) Set RBW = 1 MHz, VBW= 3MHz for  $f \geq 1 \text{ GHz}$  for peak measurement.
 

For average measurement:

    - $VBW = 10 \text{ Hz}$ , when duty cycle is no less than 98 percent.
    - $VBW \geq 1/T$ , when duty cycle is less than 98 percent where T is the minimum transmission duration over which the transmitter is on and is transmitting at its maximum power control level for the tested mode of operation.

Band	Duty Cycle(%)	T(μs)	1/T(kHz)	VBW Setting
Bluetooth 4.0 - LE	62.27	393.59	2.54	3kHz

### 3.5.4 Test Setup

For radiated emissions below 30MHz

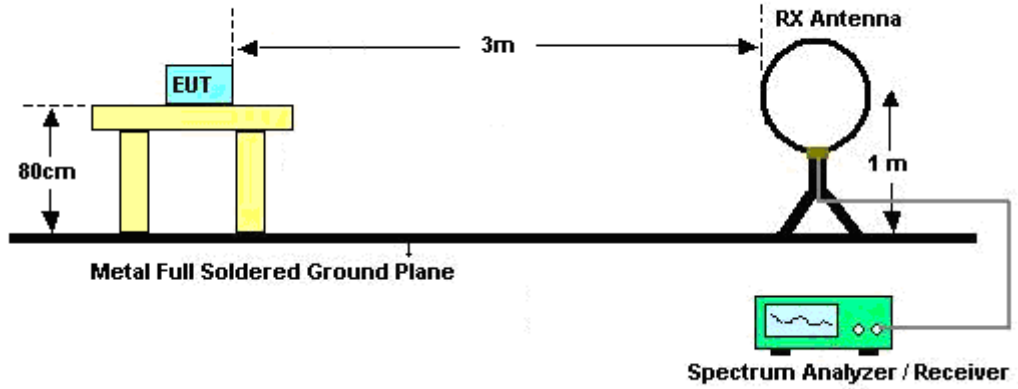

For radiated emissions from 30MHz to 1GHz

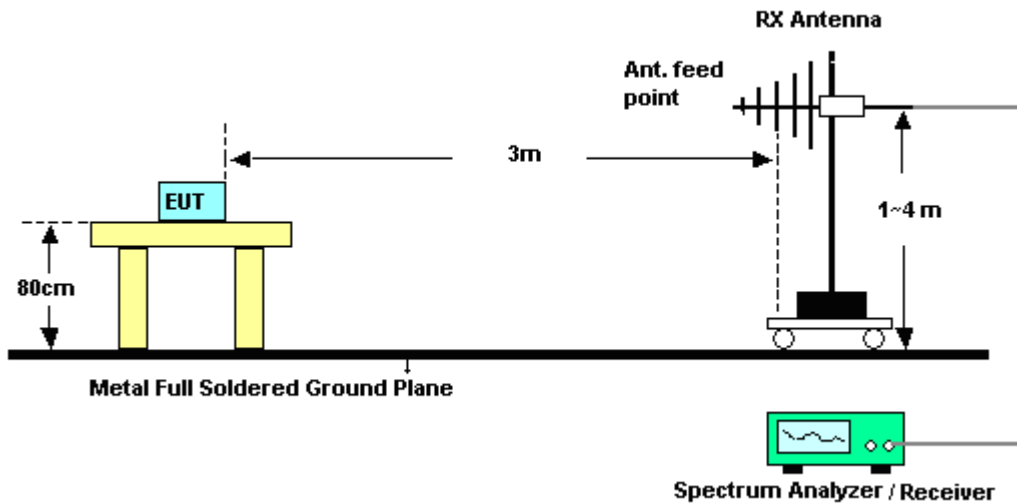

For radiated emissions above 1GHz

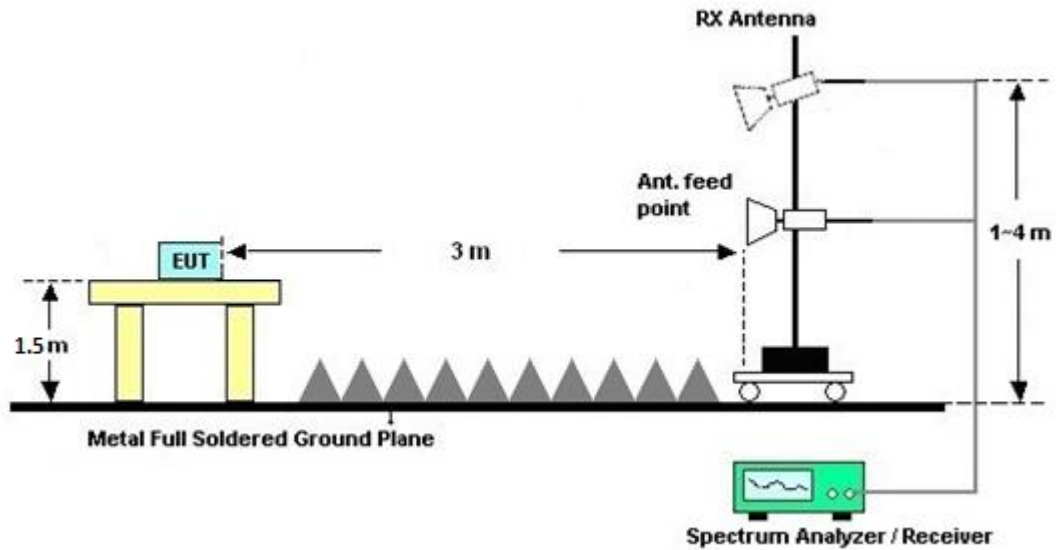

### 3.5.5 Test Results of Radiated Spurious Emissions (9 kHz ~ 30 MHz)

The low frequency, which started from 9 kHz to 30MHz, was pre-scanned and the result which was 20dB lower than the limit line per 15.31(o) was not reported.

### 3.5.6 Test Result of Radiated Spurious at Band Edges

Please refer to Appendix B and Appendix C.

### 3.5.7 Test Result of Radiated Spurious Emission (30MHz ~ 10<sup>th</sup> Harmonic)

Please refer to Appendix B and Appendix C.



### 3.6 AC Conducted Emission Measurement

#### 3.6.1 Limit of AC Conducted Emission

For equipment that is designed to be connected to the public utility (AC) power line, the radio frequency voltage that is conducted back onto the AC power line on any frequency or frequencies within the band 150 kHz to 30 MHz shall not exceed the limits in the following table.

Frequency of emission (MHz)	Conducted limit (dB $\mu$ V)	
	Quasi-peak	Average
0.15-0.5	66 to 56*	56 to 46*
0.5-5	56	46
5-30	60	50

\*Decreases with the logarithm of the frequency.

#### 3.6.2 Measuring Instruments

The section 4.0 of List of Measuring Equipment of this test report is used for test.

#### 3.6.3 Test Procedures

1. The EUT was placed 0.4 meter from the conducting wall of the shielding room was kept at least 80 centimeters from any other grounded conducting surface.
2. Connect EUT to the power mains through a line impedance stabilization network (LISN).
3. All the support units are connecting to the other LISN.
4. The LISN provides 50 ohm coupling impedance for the measuring instrument.
5. The FCC states that a 50 ohm, 50 microhenry LISN should be used.
6. Both sides of AC line were checked for maximum conducted interference.
7. The frequency range from 150 kHz to 30 MHz was searched.
8. Set the test-receiver system to Peak Detect Function and specified bandwidth (IF Bandwidth = 9kHz) with Maximum Hold Mode. Then measurement is also conducted by Average Detector and Quasi-Peak Detector Function respectively.

### 3.6.4 Test Setup

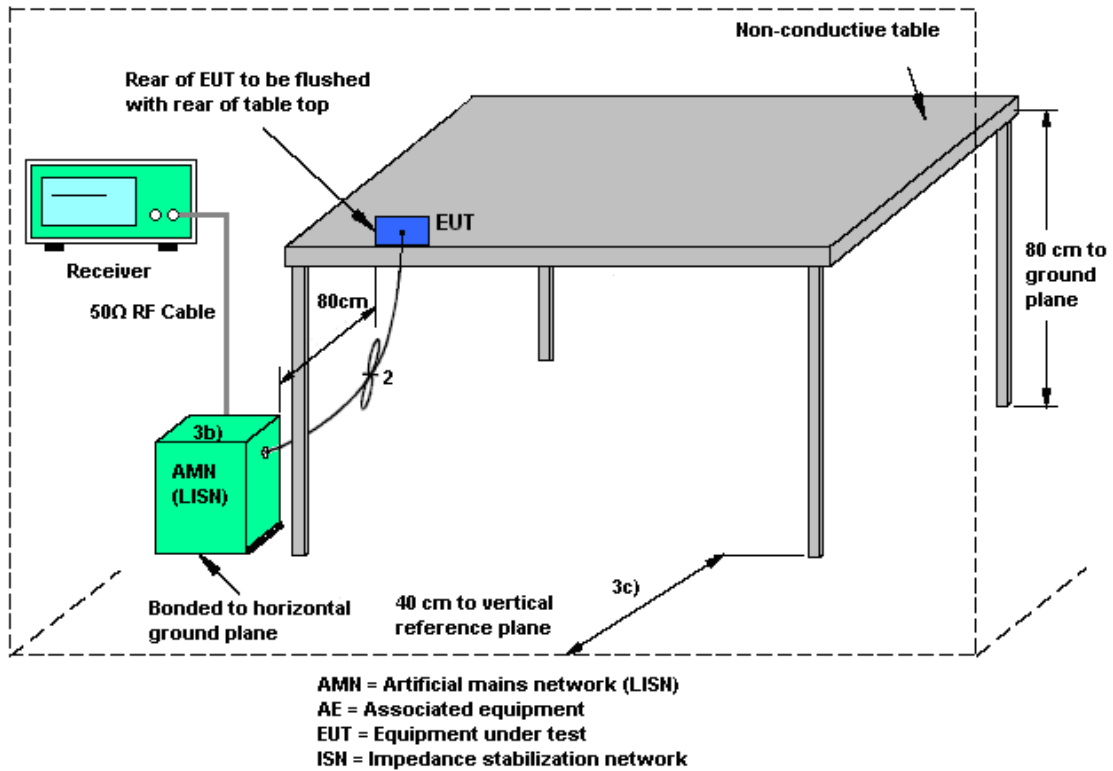



### 3.6.5 Test Result of AC Conducted Emission

Test Mode :	Mode 1	Temperature :	23~25°C
Test Engineer :	Eric Jeng	Relative Humidity :	58~61%
Test Voltage :	120Vac / 60Hz	Phase :	Line
Function Type :	Bluetooth Link + USB Cable (Charging from Adapter) + Earphone		

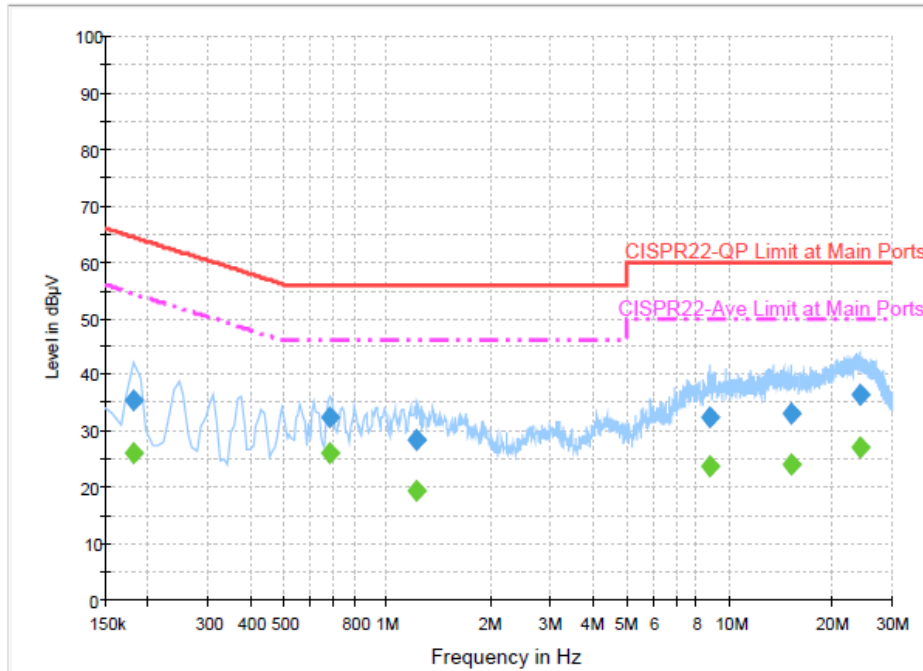

#### Final Result : QuasiPeak

Frequency (MHz)	QuasiPeak (dBµV)	Filter	Line	Corr. (dB)	Margin (dB)	Limit (dBµV)
0.182000	35.5	Off	L1	19.5	28.9	64.4
0.678000	32.4	Off	L1	19.6	23.6	56.0
1.222000	28.3	Off	L1	19.6	27.7	56.0
8.758000	32.4	Off	L1	19.8	27.6	60.0
15.214000	33.2	Off	L1	20.0	26.8	60.0
24.134000	36.6	Off	L1	20.0	23.4	60.0

#### Final Result : Average

Frequency (MHz)	Average (dBµV)	Filter	Line	Corr. (dB)	Margin (dB)	Limit (dBµV)
0.182000	26.0	Off	L1	19.5	28.4	54.4
0.678000	26.2	Off	L1	19.6	19.8	46.0
1.222000	19.3	Off	L1	19.6	26.7	46.0
8.758000	23.9	Off	L1	19.8	26.1	50.0
15.214000	24.0	Off	L1	20.0	26.0	50.0
24.134000	27.1	Off	L1	20.0	22.9	50.0



Test Mode :	Mode 1	Temperature :	23~25
Test Engineer :	Eric Jeng	Relative Humidity :	58~61
Test Voltage :	120Vac / 60Hz	Phase :	Neutral
Function Type :	Bluetooth Link + USB Cable (Charging from Adapter) + Earphone		

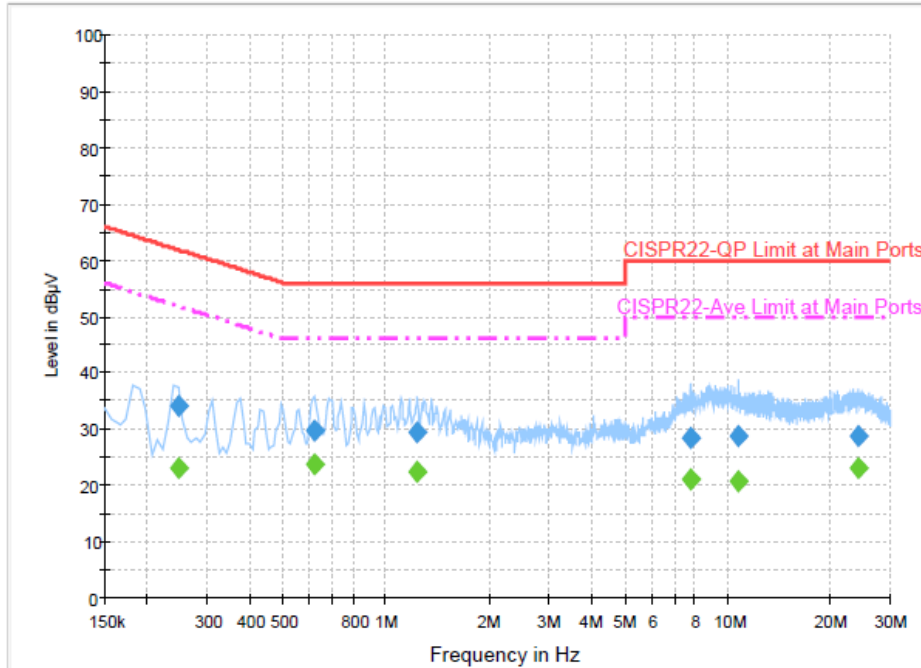

**Final Result : QuasiPeak**

Frequency (MHz)	QuasiPeak (dBµV)	Filter	Line	Corr. (dB)	Margin (dB)	Limit (dBµV)
0.246000	34.2	Off	N	19.5	27.7	61.9
0.622000	29.9	Off	N	19.4	26.1	56.0
1.238000	29.3	Off	N	19.6	26.7	56.0
7.774000	28.3	Off	N	19.8	31.7	60.0
10.790000	28.6	Off	N	19.8	31.4	60.0
24.238000	28.8	Off	N	20.1	31.2	60.0

**Final Result : Average**

Frequency (MHz)	Average (dBµV)	Filter	Line	Corr. (dB)	Margin (dB)	Limit (dBµV)
0.246000	23.0	Off	N	19.5	28.9	51.9
0.622000	23.8	Off	N	19.4	22.2	46.0
1.238000	22.5	Off	N	19.6	23.5	46.0
7.774000	20.9	Off	N	19.8	29.1	50.0
10.790000	20.6	Off	N	19.8	29.4	50.0
24.238000	23.1	Off	N	20.1	26.9	50.0



## **3.7 Antenna Requirements**

### **3.7.1 Standard Applicable**

If directional gain of transmitting antennas is greater than 6dBi, the power shall be reduced by the same level in dB comparing to gain minus 6dBi. The use of a permanently attached antenna or of an antenna that uses a unique coupling to the intentional radiator shall be considered sufficient to comply with the FCC rule.

### **3.7.2 Antenna Anti-Replacement Construction**

An embedded-in antenna design is used.

### **3.7.3 Antenna Gain**

The antenna peak gain of EUT is less than 6 dBi. Therefore, it is not necessary to reduce maximum peak output power limit.





## 4 List of Measuring Equipment

Instrument	Manufacturer	Model No.	Serial No.	Characteristics	Calibration Date	Test Date	Due Date	Remark
Power Meter	Agilent	E4416A	GB412923 44	300MHz~40GHz	Jan. 14, 2015	Aug. 04, 2015 ~ Aug. 09, 2015	Jan. 13, 2016	Conducted (TH05-HY)
Power Sensor	Agilent	E9327A	US404415 48	300MHz~40GHz	Jan. 14, 2015	Aug. 04, 2015 ~ Aug. 09, 2015	Jan. 13, 2016	Conducted (TH05-HY)
Spectrum Analyzer	Rohde & Schwarz	FSP40	100055	9kHz-40GHz	Jun. 18, 2015	Aug. 04, 2015 ~ Aug. 09, 2015	Jun. 17, 2016	Conducted (TH05-HY)
Hygrometer	Testo	608-H1	34897199	N/A	May 04, 2015	Aug. 04, 2015 ~ Aug. 09, 2015	May 03, 2016	Conducted (TH05-HY)
RF Cable	HARBOUR INDUSTRIES	LL142	Infinet CA3601-3 601-DLL	0.1MHz~40GHz	Mar. 06, 2015	Aug. 04, 2015 ~ Aug. 09, 2015	Mar. 05, 2016	Conducted (TH05-HY)
Bilog Antenna	Schaffner	CBL6111C	2726	30MHz ~ 1GHz	Sep. 27, 2014	Aug. 05, 2015 ~ Aug. 13, 2015	Sep. 26, 2015	Radiation (03CH07-HY)
Double Ridge Horn Antenna	EMCO	3117	00066583	1GHz~18GHz	Jul. 20, 2015	Aug. 05, 2015 ~ Aug. 13, 2015	Jul. 19, 2016	Radiation (03CH07-HY)
Loop Antenna	TESEQ	HLA 6120	31244	9kHz~30MHz	Feb. 02, 2015	Aug. 05, 2015 ~ Aug. 13, 2015	Feb. 01, 2016	Radiation (03CH07-HY)
EMI Test Receiver	Rohde & Schwarz	ESCI 7	100724	9kHz~7GHz	Aug. 30, 2014	Aug. 05, 2015 ~ Aug. 13, 2015	Aug. 29, 2015	Radiation (03CH07-HY)
Horn Antenna	SCHWARZBECK	BBHA 9170	BBHA9170 584	18GHz- 40GHz	Nov. 03, 2014	Aug. 05, 2015 ~ Aug. 13, 2015	Nov. 02, 2015	Radiation (03CH07-HY)
Hygrometer	Testo	608-H1	34897197	N/A	May. 04, 2015	Aug. 05, 2015 ~ Aug. 13, 2015	May. 03, 2016	Radiation (03CH07-HY)
Preamplifier	MITEQ	AMF-7D-0010 1800-30-10P	1590075	1GHz ~ 18GHz	Apr. 20, 2015	Aug. 05, 2015 ~ Aug. 13, 2015	Apr. 19, 2016	Radiation (03CH07-HY)
Preamplifier	COM-POWER	PA-103A	161241	10MHz-1000MHz	Mar. 12, 2015	Aug. 05, 2015 ~ Aug. 13, 2015	Mar. 11, 2016	Radiation (03CH07-HY)
Preamplifier	Agilent	8449B	3008A023 62	1GHz~ 26.5GHz	Oct. 21, 2014	Aug. 05, 2015 ~ Aug. 13, 2015	Oct. 20, 2015	Radiation (03CH07-HY)
Signal Analyzer	Rohde & Schwarz	FSV 30	101749	10Hz~30GHz	Mar. 10, 2015	Aug. 05, 2015 ~ Aug. 13, 2015	Mar. 09, 2016	Radiation (03CH07-HY)
RF Cable	HUBER + SUHNER	SUCOFLEX 104	MY842095 21	1GHz~40GHz	Dec. 04, 2014	Aug. 05, 2015 ~ Aug. 13, 2015	Dec. 03, 2015	Radiation (03CH07-HY)
RF Cable	HUBER + SUHNER	SUCOFLEX 104	MY842095 21	9KHz~1GHz	Dec. 04, 2014	Aug. 05, 2015 ~ Aug. 13, 2015	Dec. 03, 2015	Radiation (03CH07-HY)
Controller	ChainTek	Chaintek 3000	N/A	Control Turn table	N/A	Aug. 05, 2015 ~ Aug. 13, 2015	N/A	Radiation (03CH07-HY)
Controller	Max-Full	MF7802	MF780208 368	Control Ant Mast	N/A	Aug. 05, 2015 ~ Aug. 13, 2015	N/A	Radiation (03CH07-HY)
Antenna Mast	Max-Full	MFA520BS	N/A	1m~4m	N/A	Aug. 05, 2015 ~ Aug. 13, 2015	N/A	Radiation (03CH07-HY)
Turn Table	ChainTek	Chaintek 3000	N/A	0~360 degree	N/A	Aug. 05, 2015 ~ Aug. 13, 2015	N/A	Radiation (03CH07-HY)
Preamplifier	MITEQ	JS44-180040 00-33-8P	1840917	18GHz ~ 40GHz	Jun. 02, 2015	Aug. 05, 2015 ~ Aug. 13, 2015	Jun. 01, 2016	Radiation (03CH07-HY)



Instrument	Manufacturer	Model No.	Serial No.	Characteristics	Calibration Date	Test Date	Due Date	Remark
Test Software	Audix	E3	6.2009-8-24	N/A	N/A	Aug. 05, 2015 ~ Aug. 13, 2015	N/A	Radiation (03CH07HY)
Filter	Wainwright	WLKS1200-8SS	SN3	1.2G Low Pass	Oct. 01, 2014	Aug. 05, 2015 ~ Aug. 13, 2015	Sep. 30, 2015	Radiation (03CH07HY)
Filter	Microwave	H3G018G1	SN477220	3.0G High Pass	Oct. 01, 2014	Aug. 05, 2015 ~ Aug. 13, 2015	Sep. 30, 2015	Radiation (03CH07HY)
EMI Test Receiver	Rohde & Schwarz	ESCS 30	100356	9kHz – 2.75GHz	Dec. 01, 2014	Aug. 15, 2015	Nov. 30, 2015	Conduction (CO05-HY)
Hygrometer	Testo	608-H1	34913912	N/A	Apr. 20, 2015	Aug. 15, 2015	Apr. 19, 2016	Conduction (CO05-HY)
LISN	Rohde & Schwarz	ENV216	100080	9kHz~30MHz	Dec. 02, 2014	Aug. 15, 2015	Dec. 01, 2015	Conduction (CO05-HY)
AC Power Source	ChainTek	APC-1000W	N/A	N/A	N/A	Aug. 15, 2015	N/A	Conduction (CO05-HY)
LF Cable	HUBER + SUHNER	RG-214/U	LF01	N/A	Jan. 07, 2015	Aug. 15, 2015	Jan. 06, 2016	Conduction (CO05-HY)
Test Software	N/A	EMC32	8.40.0	N/A	N/A	Aug. 15, 2015	N/A	Conduction (CO05-HY)



## 5 Uncertainty of Evaluation

### Uncertainty of Conducted Emission Measurement (150 kHz ~ 30 MHz)

Measuring Uncertainty for a Level of Confidence of 95% ( $U = 2Uc(y)$ )	2.26
---	------

### Uncertainty of Radiated Emission Measurement (30 MHz ~ 1000 MHz)

Measuring Uncertainty for a Level of Confidence of 95% ( $U = 2Uc(y)$ )	4.80
---	------



## **Appendix A. Conducted Test Results**

**Bluetooth Low Energy**

Test Engineer:	Stuart Lin	Temperature:	21~25	°C
Test Date:	2015/08/04 ~ 2015/08/09	Relative Humidity:	51~54	%

**TEST RESULTS DATA**  
**6dB Occupied Bandwidth**

Mod.	Data Rate	N <sub>TX</sub>	CH.	Freq. (MHz)	6dB BW (MHz)	6dB BW Limit (MHz)	Pass/Fail
BLE	1Mbps	1	0	2402	0.71	0.50	Pass
BLE	1Mbps	1	19	2440	0.71	0.50	Pass
BLE	1Mbps	1	39	2480	0.72	0.50	Pass

**TEST RESULTS DATA**  
**Peak Power Table**

Mod.	Data Rate	N <sub>TX</sub>	CH.	Freq. (MHz)	Peak Conducted Power (dBm)	Conducted Power Limit (dBm)	DG (dBi)	EIRP Power (dBm)	EIRP Power Limit (dBm)	Pass /Fail
BLE	1Mbps	1	0	2402	5.43	30.00	-2.16	3.27	36.00	Pass
BLE	1Mbps	1	19	2440	6.36	30.00	-2.16	4.20	36.00	Pass
BLE	1Mbps	1	39	2480	3.74	30.00	-2.16	1.58	36.00	Pass

**TEST RESULTS DATA**  
**Average Power Table**  
**(Reporting Only)**

Mod.	Data Rate	N <sub>TX</sub>	CH.	Freq. (MHz)	Duty Factor (dB)	Average Conducted Power (dBm)
BLE	1Mbps	1	0	2402	2.06	5.19
BLE	1Mbps	1	19	2440	2.06	6.16
BLE	1Mbps	1	39	2480	2.06	3.29

**TEST RESULTS DATA**  
**Peak Power Density**

Mod.	Data Rate	N <sub>TX</sub>	CH.	Freq. (MHz)	Peak PSD (dBm /100kHz)	Peak PSD (dBm /3kHz)	DG (dBi)	Peak PSD Limit (dBm /3kHz)	Pass/Fail
BLE	1Mbps	1	0	2402	4.17	-9.40	-2.16	8.00	Pass
BLE	1Mbps	1	19	2440	5.17	-8.31	-2.16	8.00	Pass
BLE	1Mbps	1	39	2480	2.06	-11.25	-2.16	8.00	Pass

Note: PSD (dBm/ 100kHz) is a reference level used for Conducted Band Edges and Conducted Spurious Emission 20dBc limit.



## Appendix B. Radiated Spurious Emission

Test Engineer :	Wei Chen, Nick Yu, and James Chiu	Temperature :	21~23°C
		Relative Humidity :	60~63%

2.4GHz 2400~2483.5MHz

BLE (Band Edge @ 3m)

BLE	Note	Frequency	Level	Over	Limit	Read	Antenna	Cable	Preamp	Ant	Table	Peak	Pol.	
		( MHz )	( dBμV/m )	( dB )	Limit	Level	Factor	Loss	Factor	Pos	Pos	Avg.		
					Line	( dBμV )	( dB/m )	( dB )	( dB )	( cm )	( deg )	( P/A )	( H/V )	
BLE CH 00 2402MHz		2327.82	46.58	-27.42	74	41.11	32.09	7.6	34.22	113	42	P	H	
		2312.88	34.58	-19.42	54	29.1	32.07	7.6	34.19	113	42	A	H	
	*	2402.25	97.29	-	-	91.66	32.18	7.75	34.3	113	42	P	H	
	*	2402	96.59	-	-	90.96	32.18	7.75	34.3	113	42	A	H	
													H	
														H
			2387.4	46.79	-27.21	74	41.13	32.18	7.75	34.27	221	287	P	V
			2357.34	34.46	-19.54	54	28.9	32.13	7.68	34.25	221	287	A	V
	*		2402.25	96.9	-	-	91.27	32.18	7.75	34.3	221	287	P	V
	*		2402	96.18	-	-	90.55	32.18	7.75	34.3	221	287	A	V
														V
														V
BLE CH 19 2440MHz		2369.58	47.05	-26.95	74	41.48	32.16	7.68	34.27	200	43	P	H	
		2331.15	34.56	-19.44	54	29.09	32.09	7.6	34.22	200	43	A	H	
	*	2439.83	97.52	-	-	91.8	32.24	7.83	34.35	200	43	P	H	
	*	2440	96.84	-	-	91.12	32.24	7.83	34.35	200	43	A	H	
			2493.48	47.29	-26.71	74	41.56	32.3	7.91	34.48	200	43	P	H
			2489.92	34.75	-19.25	54	28.97	32.3	7.91	34.43	200	43	A	H
			2389.74	47.8	-26.2	74	42.14	32.18	7.75	34.27	108	319	P	V
			2315.76	34.72	-19.28	54	29.27	32.07	7.6	34.22	108	319	A	V
	*		2439.83	99.36	-	-	93.64	32.24	7.83	34.35	108	319	P	V
	*		2440	98.62	-	-	92.9	32.24	7.83	34.35	108	319	A	V
			2491.6	46.96	-27.04	74	41.18	32.3	7.91	34.43	108	319	P	V
			2490.24	34.98	-19.02	54	29.2	32.3	7.91	34.43	108	319	A	V



<b>BLE CH 39 2480MHz</b>	*	2479.83	95.25	-	-	89.49	32.28	7.91	34.43	200	39	P	H
	*	2480.08	94.44	-	-	88.68	32.28	7.91	34.43	200	39	A	H
		2488	47.13	-26.87	74	41.35	32.3	7.91	34.43	200	39	P	H
		2493.88	34.75	-19.25	54	29.02	32.3	7.91	34.48	200	39	A	H
													H
													H
	*	2479.83	97.79	-	-	92.03	32.28	7.91	34.43	103	308	P	V
	*	2480.00	96.96	-	-	91.2	32.28	7.91	34.43	103	308	A	V
		2492.84	47.42	-26.58	74	41.69	32.3	7.91	34.48	103	308	P	V
		2484.92	34.93	-19.07	54	29.17	32.28	7.91	34.43	103	308	A	V
													V
													V
Remark	<ol style="list-style-type: none"> <li>1. No other spurious found.</li> <li>2. All results are PASS against Peak and Average limit line.</li> </ol>												



2.4GHz 2400~2483.5MHz

BLE (Harmonic @ 3m)

BLE	Note	Frequency	Level	Over	Limit	Read	Antenna	Cable	Preamp	Ant	Table	Peak	Pol.	
		( MHz )	( dBµV/m )	( dB )	( dBµV/m )	( dBµV )	( dB/m )	( dB )	( dB )	( cm )	( deg )	Avg.	(H/V)	
BLE CH 00 2402MHz		4806	41.02	-32.98	74	55.33	34.25	11.11	59.67	100	0	P	H	
													H	
													H	
													H	
			4800	43.21	-30.79	74	57.52	34.25	11.11	59.67	100	0	P	V
														V
														V
BLE CH 19 2440MHz		4878	41.02	-32.98	74	55.08	34.3	11.21	59.57	100	0	P	H	
		7320	42.34	-31.66	74	50.15	35.6	15.08	58.49	100	0	P	H	
													H	
													H	
			4878	40.99	-33.01	74	55.05	34.3	11.21	59.57	100	0	P	V
			7320	42.22	-31.78	74	50.03	35.6	15.08	58.49	100	0	P	V
														V
BLE CH 39 2480MHz		4962	40.76	-33.24	74	54.52	34.37	11.32	59.45	100	0	P	H	
		7440	42.21	-31.79	74	50.12	35.6	15.13	58.64	100	0	P	H	
													H	
													H	
			4962	41.11	-32.89	74	54.87	34.37	11.32	59.45	100	0	P	V
			7440	42.69	-31.31	74	50.6	35.6	15.13	58.64	100	0	P	V
														V
Remark	1. No other spurious found. 2. All results are PASS against Peak and Average limit line.													





Emission below 1GHz

2.4GHz BLE (LF)

BLE	Note	Frequency	Level	Over	Limit	Read	Antenna	Cable	Preamp	Ant	Table	Peak	Pol.	
		( MHz )	( dBμV/m )	( dB )	( dBμV/m )	( dBμV )	( dB/m )	( dB )	( dB )	( cm )	( deg )	(P/A)	(H/V)	
2.4GHz BLE LF		30.54	31.94	-8.06	40	43.35	18.28	1.77	31.46	100	0	P	H	
		140.43	18.93	-24.57	43.5	35.92	11.5	2.61	31.1			P	H	
		223.86	19.67	-26.33	46	38.09	9.62	2.96	31			P	H	
		574.4	23.29	-22.71	46	30.32	19.66	4.01	30.7			P	H	
		869.1	28.16	-17.84	46	30.84	23.02	4.66	30.36			P	H	
		977.6	30.17	-23.83	54	30.56	24.96	4.94	30.29			P	H	
														H
														H
														H
														H
														H
														H
														H
			30	30.44	-9.56	40	41.37	18.8	1.77	31.5	100	0	P	V
			150.69	16.26	-27.24	43.5	33.96	10.8	2.61	31.11			P	V
			285.96	19.55	-26.45	46	34.43	12.98	3.16	31.02			P	V
			561.8	23.22	-22.78	46	30.01	19.95	4.01	30.75			P	V
			783	26.81	-19.19	46	30.56	21.97	4.62	30.34			P	V
			988.1	29.53	-24.47	54	29.91	24.84	5.03	30.25			P	V
														V
													V	
													V	
													V	
													V	
													V	
Remark	1. No other spurious found. 2. All results are PASS against limit line.													



**Note symbol**

*	<b>Fundamental Frequency</b> which can be ignored. However, the level of any unwanted emissions shall not exceed the level of the fundamental frequency per 15.209(c).
!	Test result is <b>over limit</b> line.
P/A	<b>Peak</b> or <b>Average</b>
H/V	<b>Horizontal</b> or <b>Vertical</b>



A calculation example for radiated spurious emission is shown as below:

WIFI	Note	Frequency	Level	Over	Limit	Read	Antenna	Cable	Preamp	Ant	Table	Peak	Pol.
Ant.				Limit	Line	Level	Factor	Loss	Factor	Pos	Pos	Avg.	
1+2		( MHz )	( dBμV/m )	( dB )	( dBμV/m )	( dBμV )	( dB/m )	( dB )	( dB )	( cm )	( deg )	( P/A )	( H/V )
802.11b		2390	55.45	-18.55	74	54.51	32.22	4.58	35.86	103	308	P	H
CH 01		2390	43.54	-10.46	54	42.6	32.22	4.58	35.86	103	308	A	H
2412MHz													

- Level(dBμV/m) =  
Antenna Factor(dB/m) + Cable Loss(dB) + Read Level(dBμV) - Preamp Factor(dB)
- Over Limit(dB) = Level(dBμV/m) – Limit Line(dBμV/m)

**For Peak Limit @ 2390MHz:**

- Level(dBμV/m)  
= Antenna Factor(dB/m) + Cable Loss(dB) + Read Level(dBμV) - Preamp Factor(dB)  
= 32.22(dB/m) + 4.58(dB) + 54.51(dBμV) – 35.86 (dB)  
= 55.45 (dBμV/m)
- Over Limit(dB)  
= Level(dBμV/m) – Limit Line(dBμV/m)  
= 55.45(dBμV/m) – 74(dBμV/m)  
= -18.55(dB)

**For Average Limit @ 2390MHz:**

- Level(dBμV/m)  
= Antenna Factor(dB/m) + Cable Loss(dB) + Read Level(dBμV) - Preamp Factor(dB)  
= 32.22(dB/m) + 4.58(dB) + 42.6(dBμV) – 35.86 (dB)  
= 43.54 (dBμV/m)
- Over Limit(dB)  
= Level(dBμV/m) – Limit Line(dBμV/m)  
= 43.54(dBμV/m) – 54(dBμV/m)  
= -10.46(dB)

**Both peak and average measured complies with the limit line, so test result is “PASS”.**



# Appendix C. Radiated Spurious Emission

2.4GHz 2400~2483.5MHz

BLE (Band Edge @ 3m)

BLE	2.4GHz 2400~2483.5MHz Band Edge @ 3m	
ANT	BLE CH00 2402MHz	
1	Horizontal	Vertical
<b>Peak</b>	<p>Site : 03CH07-HY Condition : FCC CLASS-B 3m HF-ANT_130829 HORIZONTAL RBW:1000.000kHz VBW:3000.000kHz SWT:Auto Detector : Peak</p>	<p>Site : 03CH07-HY Condition : FCC CLASS-B 3m HF-ANT_130829 VERTICAL RBW:1000.000kHz VBW:3000.000kHz SWT:Auto Detector : Peak</p>
<b>Avg.</b>	<p>Site : 03CH07-HY Condition : FCC CLASS-B (AVG) 3m HF-ANT_130829 HORIZONTAL RBW:1000.000kHz VBW:3.000kHz SWT:Auto Detector : Peak</p>	<p>Site : 03CH07-HY Condition : FCC CLASS-B (AVG) 3m HF-ANT_130829 VERTICAL RBW:1000.000kHz VBW:3.000kHz SWT:Auto Detector : Peak</p>

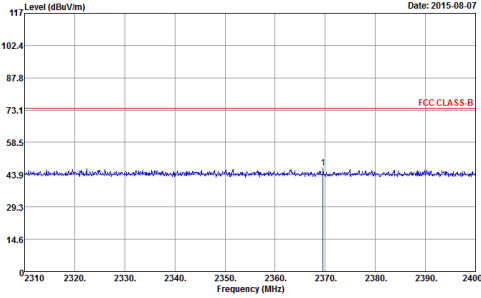
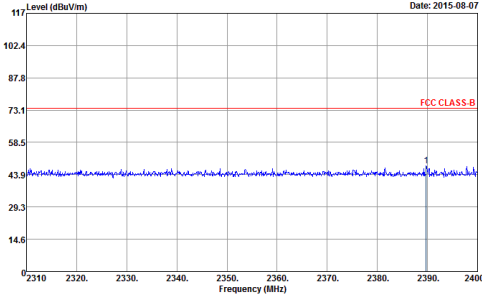
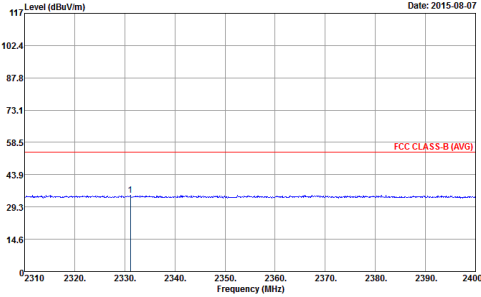
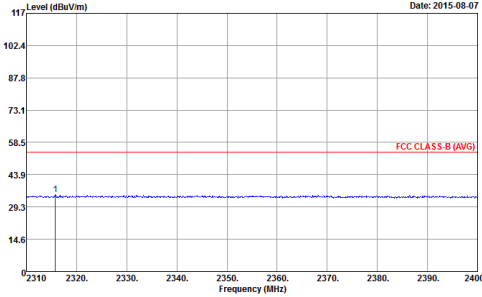

BLE	2.4GHz 2400~2483.5MHz Band Edge @ 3m	
ANT	BLE CH19 2440MHz - Low Channel Location	
1	Horizontal	Vertical
Peak	 <p>Level (dBuV/m) vs Frequency (MHz) plot for Horizontal orientation. The y-axis ranges from 0 to 117 dBuV/m, and the x-axis ranges from 2310 to 2400 MHz. A red horizontal line indicates the FCC CLASS-B limit at 73.1 dBuV/m. A blue signal trace shows a peak at approximately 2370 MHz. The date is 2015-08-07.</p> <p>Site : 03CH07-HY  Condition : FCC CLASS-B 3m HF-ANT_130829 HORIZONTAL  RBW:1000.000kHz VBW:3000.000kHz SWT:Auto  Detector : Peak</p>	 <p>Level (dBuV/m) vs Frequency (MHz) plot for Vertical orientation. The y-axis ranges from 0 to 117 dBuV/m, and the x-axis ranges from 2310 to 2400 MHz. A red horizontal line indicates the FCC CLASS-B limit at 73.1 dBuV/m. A blue signal trace shows a peak at approximately 2390 MHz. The date is 2015-08-07.</p> <p>Site : 03CH07-HY  Condition : FCC CLASS-B 3m HF-ANT_130829 VERTICAL  RBW:1000.000kHz VBW:3000.000kHz SWT:Auto  Detector : Peak</p>
Avg.	 <p>Level (dBuV/m) vs Frequency (MHz) plot for Horizontal orientation showing average levels. The y-axis ranges from 0 to 117 dBuV/m, and the x-axis ranges from 2310 to 2400 MHz. A red horizontal line indicates the FCC CLASS-B (AVG) limit at 58.5 dBuV/m. A blue signal trace shows a peak at approximately 2330 MHz. The date is 2015-08-07.</p> <p>Site : 03CH07-HY  Condition : FCC CLASS-B (AVG) 3m HF-ANT_130829 HORIZONTAL  RBW:1000.000kHz VBW:3.000kHz SWT:Auto  Detector : Peak</p>	 <p>Level (dBuV/m) vs Frequency (MHz) plot for Vertical orientation showing average levels. The y-axis ranges from 0 to 117 dBuV/m, and the x-axis ranges from 2310 to 2400 MHz. A red horizontal line indicates the FCC CLASS-B (AVG) limit at 58.5 dBuV/m. A blue signal trace shows a peak at approximately 2315 MHz. The date is 2015-08-07.</p> <p>Site : 03CH07-HY  Condition : FCC CLASS-B (AVG) 3m HF-ANT_130829 VERTICAL  RBW:1000.000kHz VBW:3.000kHz SWT:Auto  Detector : Peak</p>

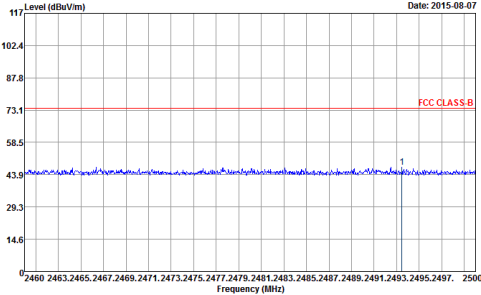
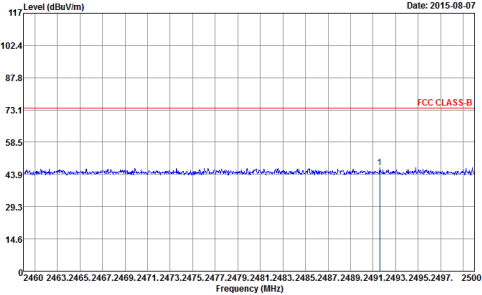
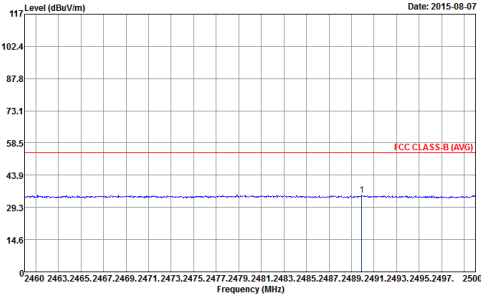
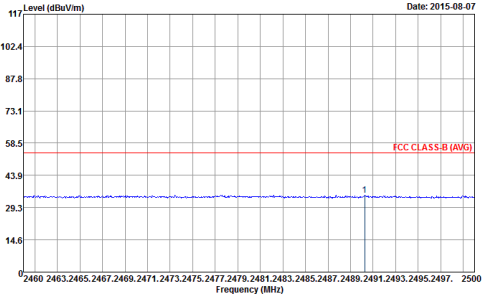

BLE	2.4GHz 2400~2483.5MHz Band Edge @ 3m	
ANT	BLE CH19 2440MHz - High Channel Location	
1	Horizontal	Vertical
Peak	 <p>Level (dBuV/m) vs Frequency (MHz) plot for Horizontal orientation. The plot shows a blue signal line with a peak at 2440 MHz. A red horizontal line indicates the FCC CLASS-B limit at 73.1 dBuV/m. The y-axis ranges from 14.6 to 117 dBuV/m, and the x-axis ranges from 2460 to 2500 MHz. A '1' is marked above the peak.</p> <p>Date: 2015-08-07</p> <p>Site : 03CH07-HY            Condition : FCC CLASS-B 3m HF-ANT_130829 HORIZONTAL            RBW:1000.000kHz VBW:3000.000kHz SWT:Auto            Detector : Peak</p>	 <p>Level (dBuV/m) vs Frequency (MHz) plot for Vertical orientation. The plot shows a blue signal line with a peak at 2440 MHz. A red horizontal line indicates the FCC CLASS-B limit at 73.1 dBuV/m. The y-axis ranges from 14.6 to 117 dBuV/m, and the x-axis ranges from 2460 to 2500 MHz. A '1' is marked above the peak.</p> <p>Date: 2015-08-07</p> <p>Site : 03CH07-HY            Condition : FCC CLASS-B 3m HF-ANT_130829 VERTICAL            RBW:1000.000kHz VBW:3000.000kHz SWT:Auto            Detector : Peak</p>
Avg.	 <p>Level (dBuV/m) vs Frequency (MHz) plot for Horizontal orientation showing average values. The plot shows a blue signal line with a peak at 2440 MHz. A red horizontal line indicates the FCC CLASS-B (AVG) limit at 58.5 dBuV/m. The y-axis ranges from 14.6 to 117 dBuV/m, and the x-axis ranges from 2460 to 2500 MHz. A '1' is marked above the peak.</p> <p>Date: 2015-08-07</p> <p>Site : 03CH07-HY            Condition : FCC CLASS-B (AVG) 3m HF-ANT_130829 HORIZONTAL            RBW:1000.000kHz VBW:3.000kHz SWT:Auto            Detector : Peak</p>	 <p>Level (dBuV/m) vs Frequency (MHz) plot for Vertical orientation showing average values. The plot shows a blue signal line with a peak at 2440 MHz. A red horizontal line indicates the FCC CLASS-B (AVG) limit at 58.5 dBuV/m. The y-axis ranges from 14.6 to 117 dBuV/m, and the x-axis ranges from 2460 to 2500 MHz. A '1' is marked above the peak.</p> <p>Date: 2015-08-07</p> <p>Site : 03CH07-HY            Condition : FCC CLASS-B (AVG) 3m HF-ANT_130829 VERTICAL            RBW:1000.000kHz VBW:3.000kHz SWT:Auto            Detector : Peak</p>

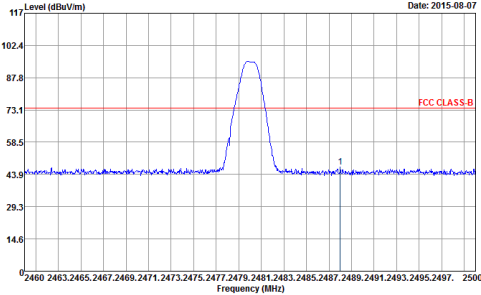
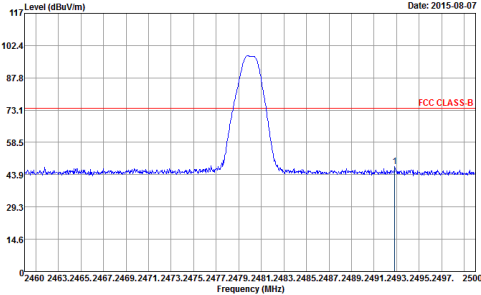
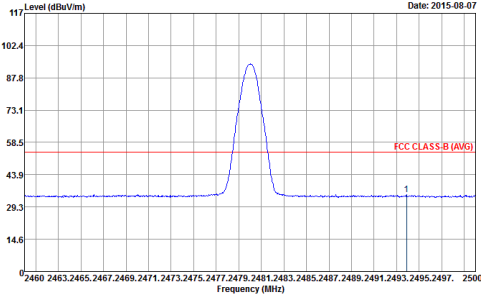
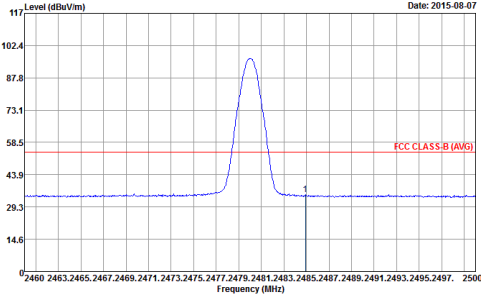

BLE	2.4GHz 2400~2483.5MHz Band Edge @ 3m	
ANT	BLE CH39 2480MHz	
1	Horizontal	Vertical
Peak	 <p>Level (dBuV/m) vs Frequency (MHz) plot for Horizontal orientation. The plot shows a peak at approximately 2479 MHz. A red horizontal line indicates the FCC CLASS-B limit at 73.1 dBuV/m. The peak level is approximately 95 dBuV/m.</p> <p>Site : 03CH07-HY            Condition : FCC CLASS-B 3m HF-ANT_130829 HORIZONTAL            RBW:1000.000kHz VBW:3000.000kHz SWT:Auto            Detector : Peak</p>	 <p>Level (dBuV/m) vs Frequency (MHz) plot for Vertical orientation. The plot shows a peak at approximately 2479 MHz. A red horizontal line indicates the FCC CLASS-B limit at 73.1 dBuV/m. The peak level is approximately 95 dBuV/m.</p> <p>Site : 03CH07-HY            Condition : FCC CLASS-B 3m HF-ANT_130829 VERTICAL            RBW:1000.000kHz VBW:3000.000kHz SWT:Auto            Detector : Peak</p>
Avg.	 <p>Level (dBuV/m) vs Frequency (MHz) plot for Horizontal orientation (Average). The plot shows a peak at approximately 2479 MHz. A red horizontal line indicates the FCC CLASS-B (AVG) limit at 58.5 dBuV/m. The average level is approximately 85 dBuV/m.</p> <p>Site : 03CH07-HY            Condition : FCC CLASS-B (AVG) 3m HF-ANT_130829 HORIZONTAL            RBW:1000.000kHz VBW:3.000kHz SWT:Auto            Detector : Peak</p>	 <p>Level (dBuV/m) vs Frequency (MHz) plot for Vertical orientation (Average). The plot shows a peak at approximately 2479 MHz. A red horizontal line indicates the FCC CLASS-B (AVG) limit at 58.5 dBuV/m. The average level is approximately 85 dBuV/m.</p> <p>Site : 03CH07-HY            Condition : FCC CLASS-B (AVG) 3m HF-ANT_130829 VERTICAL            RBW:1000.000kHz VBW:3.000kHz SWT:Auto            Detector : Peak</p>



2.4GHz 2400~2483.5MHz

BLE (Harmonic @ 3m)

BLE	2.4GHz 2400~2483.5MHz Harmonic @ 3m	
ANT	BLE CH00 2402MHz	
1	Horizontal	Vertical
<p><b>Peak</b></p> <p><b>Avg.</b></p>	<p>Site : 03CH07-HY Condition : FCC CLASS-B 3m SHF-EHF_131029 HORIZONTAL Detector : Peak</p>	<p>Site : 03CH07-HY Condition : FCC CLASS-B 3m SHF-EHF_131029 VERTICAL Detector : Peak</p>



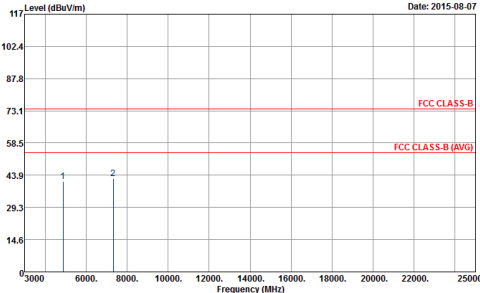
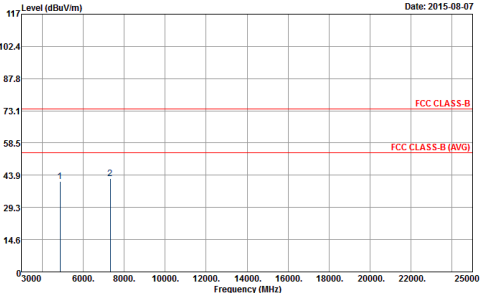

BLE	2.4GHz 2400~2483.5MHz Harmonic @ 3m	
ANT	BLE CH19 2440MHz	
1	Horizontal	Vertical
<p><b>Peak</b></p> <p><b>Avg.</b></p>	 <p>Date: 2015-08-07</p> <p>Site : 03CH07-HY Condition : FCC CLASS-B 3m SHF-EHF_131029 HORIZONTAL Detector : Peak</p>	 <p>Date: 2015-08-07</p> <p>Site : 03CH07-HY Condition : FCC CLASS-B 3m SHF-EHF_131029 VERTICAL Detector : Peak</p>



BLE	2.4GHz 2400~2483.5MHz Band Edge @ 3m	
ANT	BLE CH39 2480MHz	
1	Horizontal	Vertical
<p><b>Peak</b></p> <p><b>Avg.</b></p>	<p>Date: 2015-08-07</p> <p>Site : 03CH07-HY Condition : FCC CLASS-B 3m SHF-EHF_131029 HORIZONTAL Detector : Peak</p>	<p>Date: 2015-08-07</p> <p>Site : 03CH07-HY Condition : FCC CLASS-B 3m SHF-EHF_131029 VERTICAL Detector : Peak</p>



Emission below 1GHz

2.4GHz BLE (LF)

BLE	2.4GHz 2400~2483.5MHz	
ANT	BLE LF	
1	Horizontal	Vertical
QP / Peak		